Caution



Do not exceed the operating input power, voltage, and current level and signal type appropriate for the instrument being used, refer to your instrument's Function Reference.



Electrostatic discharge(ESD) can damage the highly sensitive microcircuits in your instrument. ESD damage is most likely to occur as the test fixtures are being connected or disconnected. Protect them from ESD damage by wearing a grounding strap that provides a high resistance path to ground. Alternatively, ground yourself to discharge any static charge built-up by touching the outer shell of any grounded instrument chassis before touching the test port connectors.

Safety Summary

When you notice any of the unusual conditions listed below, immediately terminate operation and disconnect the power cable.

Contact your local Agilent Technologies sales representative or authorized service company for repair of the instrument. If you continue to operate without repairing the instrument, there is a potential fire or shock hazard for the operator.

- Instrument operates abnormally.
- Instrument emits abnormal noise, smell, smoke or a spark-like light during operation.
- Instrument generates high temperature or electrical shock during operation.
- Power cable, plug, or receptacle on instrument is damaged.
- Foreign substance or liquid has fallen into the instrument.

Herstellerbescheinigung

GERÄUSCHEMISSION

LpA < 70 dB
am Arbeitsplatz
normaler Betrieb
nach DIN 45635 T. 19

Manufacturer's Declaration

ACOUSTIC NOISE EMISSION

LpA < 70 dB
operator position
normal operation
per ISO 7779

Regulatory compliance information

This product complies with the essential requirements of the following applicable European Directives, and carries the CE marking accordingly:

The Low Voltage Directive 73/23/EEC, amended by 93/68/EEC

The EMC Directive 89/336/EEC, amended by 93/68/EEC

To obtain Declaration of Conformity, please contact your local Agilent Technologies sales office, agent or distributor.

Safety notice supplement

- This equipment complies with EN/IEC61010-1:2001.
- This equipment is MEASUREMENT CATEGORY I (CAT I). Do not use for CAT II, III, or IV.
- Do not connect the measuring terminals to mains.
- This equipment is POLLUTION DEGREE 2, INDOOR USE product.
- This equipment is tested with stand-alone condition or with the combination with the accessories supplied by Agilent Technologies against the requirement of the standards described in the Declaration of Conformity. If it is used as a system component, compliance of related regulations and safety requirements are to be confirmed by the builder of the system.

Agilent E5052A Signal Source Analyzer

User's Guide

Seventh Edition

FIRMWARE REVISIONS

This manual applies directly to instruments that have the firmware revision A.02.5x.
For additional information about firmware revisions, see Appendix A.



Agilent Technologies

Manufacturing No. E5052-90060

November 2007

Notices

The information contained in this document is subject to change without notice.

This document contains proprietary information that is protected by copyright. All rights are reserved. No part of this document may be photocopied, reproduced, or translated to another language without the prior written consent of Agilent Technologies.

Microsoft®, MS-DOS®, Windows®, Visual C++®, Visual Basic®, VBA® and Excel® are registered

UNIX is a registered trademark in U.S. and other countries, licensed exclusively through X/Open Company Limited.

Portions ©Copyright 1996, Microsoft Corporation. All rights reserved.

© Copyright 2004, 2005, 2006, 2007 Agilent Technologies

Manual Printing History

The manual's printing date and part number indicate its current edition. The printing date changes when a new edition is printed (minor corrections and updates that are incorporated at reprint do not cause the date to change). The manual part number changes when extensive technical changes are incorporated.

August 2004	First Edition (part number: E5052-90000)
October 2004	Second Edition (part number: E5052-90010, changes for firmware version A.01.10)
February 2005	Third Edition (part number: E5052-90020, changes for firmware version A.01.50)
August 2005	Fourth Edition (part number: E5052-90030, changes for firmware version A.02.00)
June 2006	Fifth Edition (part number: E5052-90040, changes for firmware version A.02.50)
June 2007	Sixth Edition (part number: E5052-90050)
November 2007	Seventh Edition (part number: E5052-90060)

Safety Summary

The following general safety precautions must be observed during all phases of operation, service, and repair of this instrument. Failure to comply with these precautions or with specific WARNINGS elsewhere in this manual may impair the protection provided by the equipment. Such noncompliance would also violate safety standards of design, manufacture, and intended use of the instrument. Agilent Technologies assumes no liability for the customer's failure to comply with these precautions.

NOTE	The E5052A complies with INSTALLATION CATEGORY II as well as POLLUTION DEGREE 2 in IEC61010-1. The E5052A is an INDOOR USE product.
NOTE	The LEDs in the E5052A are Class 1 in accordance with IEC60825-1, CLASS 1 LED PRODUCT
NOTE	This equipment is MEASUREMENT CATEGORY I (CAT I). Do not use for CAT II, III, or IV.
NOTE	This equipment is tested with stand-alone condition or with the combination with the accessories supplied by Agilent Technologies against the requirement of the standards described in the Declaration of Conformity. If it is used as a system component, compliance of related regulations and safety requirements are to be confirmed by the builder of the system.

- **Ground the Instrument**
To avoid electric shock, the instrument chassis and cabinet must be grounded with the supplied power cable's grounding prong.
- **DO NOT Operate in an Explosive Atmosphere**
Do not operate the instrument in the presence of inflammable gasses or fumes. Operation of any electrical instrument in such an environment clearly constitutes a safety hazard.
- **Keep Away from Live Circuits**
Operators must not remove instrument covers. Component replacement and internal adjustments must be made by qualified maintenance personnel. Do not replace components with the power cable connected. Under certain conditions, dangerous voltage levels may remain even after the power cable has been disconnected. To avoid injuries, always disconnect the power and discharge circuits before touching them.
- **DO NOT Service or Adjust the Instrument Alone**
Do not attempt internal service or adjustment unless another person, capable of rendering first aid and resuscitation, is present.
- **DO NOT Substitute Parts or Modify the Instrument**
To avoid the danger of introducing additional hazards, do not install substitute parts or perform unauthorized modifications to the instrument. Return the instrument to an Agilent Technologies Sales and Service Office for service and repair to ensure that

safety features are maintained in operational condition.

- Dangerous Procedure Warnings

Warnings, such as the example below, precede potentially dangerous procedures throughout this manual. Instructions contained in the warnings must be followed.

WARNING

Dangerous voltage levels, capable of causing death, are present in this instrument. Use extreme caution when handling, testing, and adjusting this instrument.

- Do not connect the measuring terminals to mains.

Safety Symbols

General definitions of safety symbols used on the instrument or in manuals are listed below.



Instruction Manual symbol: the product is marked with this symbol when it is necessary for the user to refer to the instrument manual.



Alternating current.



Direct current.



On (Supply).



Off (Supply).



In-position of push-button switch.



Out-position of push-button switch.



A chassis terminal; a connection to the instrument's chassis, which includes all exposed metal structure.



Stand-by.

WARNING

This warning sign denotes a hazard. It calls attention to a procedure, practice, or condition that, if not correctly performed or adhered to, could result in injury or death to personnel.

CAUTION

This Caution sign denotes a hazard. It calls attention to a procedure, practice, or condition that, if not correctly performed or adhered to, could result in damage to or destruction of part or all of the instrument.

NOTE

This Note sign denotes important information. It calls attention to a procedure, practice, or condition that is essential for the user to understand.

Certification

Agilent Technologies certifies that this product met its published specifications at the time of shipment from the factory. Agilent Technologies further certifies that its calibration measurements are traceable to the United States National Institute of Standards and Technology, to the extent allowed by the Institution's calibration facility or by the calibration facilities of other International Standards Organization members.

Documentation Warranty

The material contained in this document is provided "as is," and is subject to being changed, without notice, in future editions. Further, to the maximum extent permitted by applicable law, Agilent disclaims all warranties, either express or implied with regard to this manual and any information contained herein, including but not limited to the implied warranties of merchantability and fitness for a particular purpose. Agilent shall not be liable for errors or for incidental or consequential damages in connection with the furnishing, use, or performance of this document or any information contained herein. Should Agilent and the user have a separate written agreement with warranty terms covering the material in this document that conflict with these terms, the warranty terms in the separate agreement will control.

Exclusive Remedies

The remedies provided herein are Buyer's sole and exclusive remedies. Agilent Technologies shall not be liable for any direct, indirect, special, incidental, or consequential damages, whether based on contract, tort, or any other legal theory.

Assistance

Product maintenance agreements and other customer assistance agreements are available for Agilent Technologies products.

For any assistance, contact your nearest Agilent Technologies Sales and Service Office. Addresses are provided at the back of this manual.

Typeface Conventions

Sample (bold)	Boldface type is used when a term is defined or emphasis.
<i>Sample</i> (Italic)	Italic type is used for emphasis.
Sample key	Indicates a hardkey (key on the front panel or external keyboard) labeled “Sample.” “key” may be omitted.
Sample menu/button/box	Indicates a menu/button/box on the screen labeled “Sample” which can be selected/executed by clicking. “menu,” “button,” or “box” may be omitted.
Sample block/toolbar	Indicates a block (group of hardkeys) or a toolbar (setup toolbar) labeled “Sample.”
Sample 1 - Sample 2 - Sample 3	Indicates a sequential operation of Sample 1 , Sample 2 , and Sample 3 (menu, button, or box). “-” may be omitted.

Documentation Map

The following manuals are available for the Agilent E5052A.

- **User's Guide (Part Number E5052-900x0, attached to Option ABA)**

This manual describes most of the basic information needed to use the E5052A. It provides a function overview, detailed operation procedure for each function (from preparation for measurement to analysis of measurement results), measurement examples, specifications, and supplemental information. For programming guidance on performing automatic measurement with the E5052A, please see *the Programming Manual*.
- **Programmer's Guide (Part Number E5052-900x1, attached to Option ABA)**

This manual provides programming information for performing automatic measurement with the E5052A. It includes an outline of remote control, procedures for detecting measurement start (trigger) and end (sweep end), application programming examples, a command reference, and related information.
- **VBA Programmer's Guide (Part Number E5052-900x2, attached to Option ABA)**

This manual describes programming information for performing automatic measurement with internal controller. It includes an outline of VBA programming, some sample programming examples, a COM object reference, and related information.

NOTE

The number position shown by "x" in the part numbers above indicates the edition number.

VBA Macro

The Agilent folder (D:\Agilent) on the hard disk of the E5052A contains the VBA macros (VBA Projects) used in this manual.

The customer shall have the personal, non-transferable rights to use, copy, or modify the VBA macros for the customer's internal operations.

The customer shall use the VBA macros solely and exclusively for their own purposes and shall not license, lease, market, or distribute the VBA macros or modification of any part thereof.

Agilent Technologies shall not be liable for any infringement of any patent, trademark, copyright, or other proprietary right by the VBA macros or their use. Agilent Technologies does not warrant that the VBA macros are free from infringements of such rights of third parties. However, Agilent Technologies will not knowingly infringe or deliver software that infringes the patent, trademark, copyright, or other proprietary right of a third party.

1. Precautions	
Software Installed	18
Before contacting us	19
2. Overview of Functions	
Front Panel: Names and Functions of Parts	22
1. Standby Switch	23
2. LCD Screen	23
3. WINDOW/TRACE Block	24
4. MEASUREMENT Block	25
5. CONTROL Block	26
6. Floppy Disk Drive	27
7. NAVIGATION Block	28
8. ENTRY Block	30
9. INSTR STATE Block	31
10. MKR/ANALYSIS Block	32
△ 11. DUT Interface	32
12. OPTIONAL RF Ports	33
LCD Screen: Names and Functions of Parts	34
1. Data Entry Bar	35
2. Softkey Menu Bar	36
3. Instrument Status Bar	38
4. Measurement Window	41
Rear Panel: Names and Functions of Parts	46
1. 24-bit I/O Port	47
2. LAN Port	47
3. External Monitor Output Terminal (Video)	47
4. GPIB Connector	47
5. External Trigger Input Connector (Ext Trig)	47
6. Fan	47
7. Line Switch (Always ON)	47
8. Power Cable Receptacle (to LINE)	48
9. High Stability Frequency Reference Output Connector (Ref Oven)	48
10. External Reference Signal Input Connector (Ref In)	48
11. Internal Reference Signal Output Connector (Ref Out)	48
12. Serial Number Plate	48
13. Certificate of Authenticity Label	49
14. Rear USB port	49
15. Reserved Port (Reserved)	49
16. Printer Parallel Port	49
17. Mini-DIN Keyboard Port	49
18. Mini-DIN Mouse Port	49
19. USB (USBTMC) Interface Port	49
3. Installation	
Checking the Shipment	53
Environmental Requirements	56
Operating environment	56

Ventilation requirements	57
Protection against electrostatic discharge (ESD)	58
Ensuring adequate free space around analyzer for immediate disconnection of power cable in case of emergency 58	
Installing Front Handles/Rack Mounting Flanges	59
How to install the handle kit (Option 1CN)	60
How to install the rack-mount kit (Option 1CM)	61
How to install the rack-mount and handle kit (Option 1CP)	61
Connecting the Accessories	62
Connecting the mouse and keyboard	62
Connecting a LAN cable	63
Connecting a printer	64
Power Supply and Blown Fuses	65
Verification of the power supply	65
Verification and connection of power cable	65
Blown fuses	67
Starting the E5052A	68
Turning the Power ON and OFF	68
Disconnection from supply source	69
Initial Registration of E5052A	70
Setting the Internal Clock	73
Setting the Date/Time	73
Turning the Date/Time display ON and OFF	74
Daily Maintenance	75
Cleaning method	75
Maintaining connectors/ports on test port (DUT interface)	75
Self-test When Turning on the Power	75
Considerations When Shipping to a Service Center Due to Breakdown or Other Problems	76
4. Basic Measurement Using E5052A	
Frequency/Power Measurement in Frequency/Power Measurement Mode	78
Overview of frequency/power measurement	78
About analyzer mode and tester mode	78
Setting Trace Layout	79
Common settings in RF power, frequency and power supply DC current measurement	81
Setting DC power/DC control and protection	86
Auto Frequency Control Function	88
About DC control voltage delay, DC power delay and point delay	91
Confirming Result of Frequency Measurement	94
Confirming Result of RF Power Measurement	98
Confirming Result of Power Supply DC Current Measurement	102
Phase Noise Measurement in Phase Noise Measurement Mode	106
Overview of Phase Noise Measurement	106
Setting Phase Noise Measurement	106
Confirming Result of Phase Noise Measurement	112
Spectrum Monitor Measurement in Spectrum Monitor Measurement Mode	119
Overview of Spectrum Monitor Measurement	119
Setting Spectrum Monitor Measurement	119
Setting Averaging Trigger	123

Confirming Result of Spectrum Monitor Measurement	124
Transient Measurement in Transient Measurement Mode	129
Overview of transient measurement	129
Common Settings for Transient Measurement	129
Setting Video Trigger	135
Setting External Trigger	137
Confirming the result of frequency transient (Wide Band) measurement	138
Confirming Result of Frequency Transient (Narrow Band) Measurement.	142
Confirming Result of Power Transient Measurement.	146
Confirming the phase transient measurement.	149
User Calibration	155
Overview of User Calibration	155
Setting User Calibration Function.	155
Format of the correction data file	155
Correction Method	157
5. Measurement Using E5053A and External Mixer	
E5053A Microwave Downconverter	160
Connection of E5052A and E5053A.	160
Device Configuration Using E5052A and E5053A Microwave Downconverter.	164
Setting E5053A Microwave Downconverter	167
Effects of Setting of Downconverter and Input Port for RF Signals.	174
External Mixer	178
Overview	178
Setup Parameters	178
Limitations	180
Frequency Offset Function	181
Overview	181
Setting Items	181
Frequency Conversion Equations	182
Consideration on Frequency Setting.	183
Applicable Measurement Results	183
Making phase-noise measurement above 26.5 GHz.	184
Basic configuration for expanding frequency range.	184
Setup considerations for > 26.5 GHz measurement	186
Measurement noise floor.	187
Configuring millimeter-wave phase-noise measurement setup	188
Advanced measurement techniques for a free-running source measurement.	189
Large frequency drift.	189
High phase noise that may saturate phase detector.	190
Prescaler techniques to suppress frequency drift and high phase noise	191
Configuring millimeter-wave setup to allow prescaler techniques	192
Operation of the AgtmmWave VBA macro	193
Start up the AgtmmWave macro	193
Set up millimeter-wave measurement parameters.	193
Setup for prescaler techniques (Advanced technique for measuring a free-running source)	196
6. Data Analysis and Result Output	

Analyzing Data on Trace Using Marker	200
About Marker Functions	200
Reading Values on Trace	201
Changing Display Position of Marker Value	202
Specifying Sweep Range by Using Marker	203
Reading Relative Value From Reference Point on Trace	204
Reading Only Actual Measurement Point/Reading Value Interpolated Between Measurement Points	205
Setting Up Markers for Each Trace/Setting up Markers for Coupled Operations Between Traces	206
Listing All Marker Values in All Displayed Traces	207
Searching for Positions that Match Specified Criteria	208
Setting Search Range (Bandmarkers)	208
Searching in Specified Range	209
Setting up Bandmarker for Each Trace/Setting up Markers for Coupled Operations Between Traces	210
Automatically Executing Search Each Time Sweep is Done (search tracking)	212
Searching for Maximum and Minimum Measured Values	213
Searching for Target Value (target search)	214
Searching for Peak	216
Searching for Multiple Peaks	218
Determining Mean, Standard Deviation, and Peak-to-Peak of the Trace	220
Specifying Range for Statistical Data	221
Displaying Statistical Data	221
Comparing Traces/Performing Data Math	222
Operational Procedure	222
Comparing Measurement Results in User Window	224
Copy Traces to User Window	224
Add Annotation to Each Trace in User Window	224
Limit Test	225
Concept of Limit Test	225
Displaying Judgment Result of Limit Test	226
Defining Limit Line	227
Initializing Limit Lines	228
File Saving and Loading Instrument Status Settings	229
Saving Procedure	232
Recalling Procedure	235
Recall Procedure Using “Recall by File Name” Feature	236
Managing Files/Folders	237
Running Windows Explorer	237
Copying Files/Folders	237
Moving Files/Folders	237
Removing Files/Folders	238
Changing the Name of File/Folder	238
Formatting Floppy Disk	238
Saving Trace on File	239
Saving Trace Data File	239
Saving Trace Memory	240
Linearity Evaluation of Chirped FM Signal	241
Create Reference Regression Line	241
Evaluate the Linearity	242
Hiding Numeric Information	243

Hiding Frequency Information on Screen	243
Hiding All Numeric Information Screen	243
Saving Display Screen	244
Operational Procedure	244
Printing Screen Image	245
Supported Printers	245
Installing Printer Driver	245
Images You Can Print/save	246
Printing Procedure	246
7. Clock Jitter Measurement	
Overview	250
Overview of clock jitter measurement	250
Relation between phase deviation (spurious) and jitter	252
Clock jitter measurement with the E5052A	253
Executing Clock Jitter Measurement	255
Starting the VBA program	255
Random jitter analysis	256
Frequency analysis for periodic jitter	258
Decomposition analysis for periodic jitter	261
Installing the program	265
Error messages	266
8. Setting and Using the Control and Management Functions	
Setting the GPIB	268
Setting talker/listener GPIB address of E5052A	268
Setting system controller (USB/GPIB interface) when c drive volume label in hard disk is less than CL250 268	
Setting system controller (USB/GPIB interface) when c drive volume label in hard disk is more than CL251 271	
Setting the Mouse	273
Setup steps	273
Configuring the Network	276
Enabling/disabling network	276
Setting IP address	277
Specifying computer name	279
Accessing Hard Disk of E5052A from External PC	281
Enabling access from an external PC	281
Accessing hard disk of E5052A from external PC	283
Disabling USB Mass Storage Device	284
Steps for Setting Modification	284
Locking the Front Keys, Keyboard, and Mouse (Touch Screen)	285
Locking the front keys, keyboard, and mouse	285
Setting the Beeper (Built-in Speaker)	286
Setting the Operation Complete Beeper	286
Setting the Warning Beeper	286
Turning off the LCD Screen Backlight	287
Turning off the LCD Screen Backlight	287

Setting display colors	288
Selecting display mode	288
Setting display color for each item	288
Resetting the display colors to factory defaults	289
Checking the Product Information	290
Checking the serial number	290
Checking the firmware revision	290
Checking the option number	290
9. Information on Maintenance	
Backing Up the Data	292
Making backup files	292
Maintenance of removable hard disk	293
Saving system calibration data from removable hard disk to floppy disk	293
Removing Removable Hard Disk	293
Mounting Removable Hard Disk	294
Recalling system calibration data to removable hard disk	295
System Recovery	296
Types of system recoveries	296
Notes on executing system recovery	296
Procedure to execute factory recovery	297
Procedure to create the user backup image	300
Procedure to execute the user recovery	303
Calibration of the Touch Screen	306
Cleaning the Instrument	307
Cleaning the LCD	307
Maintenance of test ports (DUT INTERFACE) and other connectors/ports	307
Cleaning parts other than the LCD	307
Replacement of Parts with Limited Service Life	308
Cautions Applicable to Requesting Repair, Replacement, Regular Calibration, etc.	309
Backing up data in the hard disk	309
Devices to be sent back for repair or regular calibration	309
Recommended Calibration Period	309
10. Specifications and Supplemental Information	
Definitions	312
Phase Noise Measurement	313
Measurement capabilities	320
Frequency, RF Power, DC current Measurements	321
Specifications of the E5052A use only	321
Measurement capabilities	322
Softkeys and SCPI commands that are not available when using “Tester” mode or option 011 is installed	322
Transient Measurement	324
Measurement capabilities	327
Spectrum Monitor	328
Measurement capabilities	328
Port Output (DC Power/Control)	329

Test Port Input	330
General Information	331
Measurement capabilities	338
DC Power/Control Voltage Setting	338
Trace functions	339
Storage	339
System capabilities	339
Automation	340
Function differences between standard and option 011	341
System performance with E5053A Microwave Downconverter	342
Clock jitter Analysis	344
A. Manual Changes	
Manual Changes	346
Change 5	347
Change 4	347
Change 3	348
Change 2	348
Change 1	349
B. Troubleshooting	
Troubleshooting	352
Troubleshooting during Startup	352
Troubleshooting during Operation	353
Troubleshooting for External Devices	355
Error Messages	356
A	356
D	357
E	358
F	358
I	359
L	359
M	360
N	360
O	360
P	360
R	361
S	362
T	362
U	362
Warning Message	363
C. List of Default Values	
List of Default Values, Save/Recall Settings, and Backup Settings	366
FP Menu	367
PN Menu	376
SP Menu	384
TR Menu	393

USER Menu	402
D. Softkey Functions	
Phanse Noise Menu (Top Menu)	412
PN Menu.....	413
Spectrum Monitor Menu (Top Menu)	427
SP Menu.....	428
Frequency Power Menu (Top Menu)	442
FP Menu.....	443
Transient Menu (Top Menu).....	458
TR Menu.....	459
User Defined Menu (Top Menu)	475
USER Menu	476

1 Precautions

This chapter describes cautions that must be observed in operating the E5052A.

Software Installed

The Windows operating system installed in this machine is customized for more effective operation, and has different functions that are not part of the Windows operating system for ordinary PCs (personal computers).

Therefore, do not attempt to use the system in ways other than those described in this manual or to install Windows-based software (including anti-virus software) for ordinary PCs as doing so may cause malfunctions.

Also note the followings.

- Do not update the Windows operating system installed in this machine to the Windows operating system for ordinary PCs. Doing so will cause malfunctions.
- Do not attempt to update VBA (Visual Basic for Applications) software installed in this machine to its equivalent developed for ordinary PCs. Doing so will cause malfunctions.
- Do not allow any computer virus to infect the system. This machine has no virus check function nor anti-virus software installed.

Agilent Technologies will not be held liable for any failure or damage arising from negligence regarding these prohibitions and warnings.

NOTE

If the pre-installed software is damaged somehow, resulting in errant behavior by the machine, perform a system recovery. For further details of system recovery, refer to “System Recovery” on page 296.

Before contacting us

If you encounter the following problems during startup or operation of the E5052A, in which initial registration of the Windows 2000 Operating System has been properly performed, execute system recovery and update the firmware version. As for the system recovery procedure, refer to “System Recovery” on page 296.

The system starts up, but the normal measurement screen does not appear

- The system automatically shuts down immediately after the startup, or the startup process stops.
- The measurement screen appears, but "Power on test fail" or "Calibration data lost" is displayed in the instrument message/warning area against a red background in the lower-left part of the screen. The system enters the service mode. (The instrument status bar in the lower-right displays SVC in red).

Unstable Operation

- The system hangs up while the instrument is controlled from VBA or external PCs.
- The blue screen appears and the system hangs up.
- The response is much slower than usual.

When execution of system recovery does not result in normal operation, a failure may have occurred. Contact Agilent Technology’s Customer Contact listed at the end of this guide or the company from which you bought the device.

For other problems, refer to “Troubleshooting” on page 352.

Precautions
Before contacting us

2 Overview of Functions

This chapter describes the functions of the E5052A that can be accessed from the front panel, LCD screen, and rear panel.

Front Panel: Names and Functions of Parts

This section describes the names and functions of the parts on the front panel of the E5052A. For more about the functions displayed on the LCD screen, see “LCD Screen: Names and Functions of Parts” on page 34. For more about the functions of softkeys, see Appendix D, “Softkey Functions,” on page 411.

Figure 2-1

Front Panel

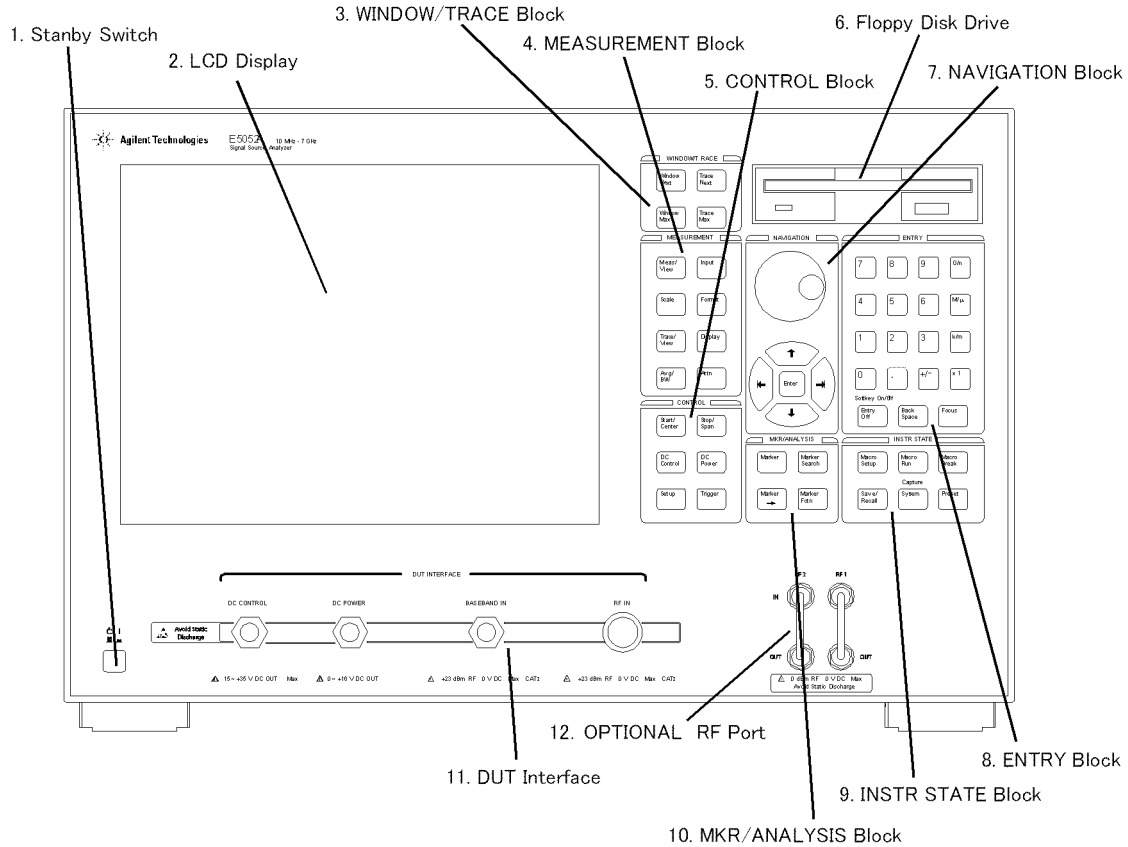

e5052aue032

1. Standby Switch

Used for choosing between power-on (|) and standby (⏻) states of the E5052A.

NOTE

To turn off the power of the E5052A, be sure to follow the steps described below.

1. First, press the standby switch or send a shutdown command from the external controller to activate the shutdown process (the processing of software and hardware necessary to turn off the power supply). This will put the E5052A into the standby state.
2. Next, if necessary, turn off the power supply to the “8. Power Cable Receptacle (to LINE)” on page 48 on the rear panel.

Under normal use, never directly interrupt the power supply to the power cable receptacle on the rear panel when the power supply is on. Always keep the “7. Line Switch (Always ON)” on page 47 at (I). Never turn it off (O).

If you directly interrupt the power supply to the power cable receptacle when the power supply is on, or turn off the “7. Line Switch (Always ON)” on page 47, the shutdown process will not work. This could damage the E5052A’s software and hardware and lead to device failure.

Turning on the power supply after a faulty shutdown may cause the system to start up in a condition called “safe mode.” If this occurs, first shut down the system to put it into the standby state and then turn on the power supply again to start up the system in normal mode.

See also Chapter 3, “Installation,” for further information on power on/off.

2. LCD Screen

A 10.4-inch touch screen TFT color LCD used for displaying traces, scales, settings, softkeys, etc. The touch screen LCD allows you to manipulate softkeys by touching the LCD screen directly with a finger. For more about the LCD screen, see “LCD Screen: Names and Functions of Parts” on page 34.

NOTE

Do not press the surface of the LCD screen (both standard and touch screen types) with a sharp object (e.g., a nail, pen, or screwdriver). Pressing the surface with a sharp-pointed object can damage the LCD screen surface or cause the screen to fail.

NOTE

Occasionally, a few pixels may appear on the screen as a fixed point of blue, green or red. Please note that this is not a failure and does not affect the performance of your product.

3. WINDOW/TRACE Block

A group of keys for selecting active measurement windows and active traces. For more about the concepts of measurement windows and traces, see “4. Measurement Window” on page 41.

Table 2-1

Window Next Key	Pressing this key causes the active measurement window to switch over to the next higher window number of four measurement windows. It is possible to define sweep range and other parameters of an active measurement window. To change the settings of a window, use this key to first activate the window.
Window Max Key	Switches over between normal and maximum display of the active measurement window. In normal display, all four measurement windows (both active and non-active) are displayed in split views on the screen. In maximum display, only the active measurement window is displayed over the entire area, without showing non-active measurement windows. You can also switch over between the normal and maximum windows by double-clicking the measurement window frame. Measurements are also carried out on the non-active measurement windows that are not displayed.
Trace Next Key	Switches over the active trace to the next one. (Each time the key is pressed the active trace steps up from the trace with the designated number to the one with a higher number.) An active trace is one for which the measurement parameters are defined. To change the settings for a trace, use this key to first make the trace active.
Trace Max Key	Switches over between normal and maximum display of the active trace within the measurement window. In normal display, all traces are displayed in split views on the measurement window. In maximum display, only the active trace is displayed over the entire area, without showing non-active traces. To maximize the active trace, you can also double-click the area inside the measurement window (excluding the frame). Measurements are also carried out on the non-active traces that are not displayed.

4. MEASUREMENT Block

A group of keys used mainly for setting up measurements on the E5052A.

Table 2-2

Meas/View Key	Displays the “Measurement View Menu” in the right part of the screen. Manipulating the “Measurement View Menu” enables you to select any active measurement window. Active measurement windows are also selectable in maximum display. In this case, the measurement window in maximum display will switch over to the one you have selected.
Input Key	Displays the “Input Menu” in the right part of the screen. Manipulating the “Input Menu” enables you to select any port for the measurement signal input.
Scale Key	Displays the “Scale Menu” in the right part of the screen. Manipulating the “Scale Menu” enables you to specify the scale for displaying a trace (magnitude per division, value of the reference line, etc.) for each trace.
Format Key	Displays the “Format Menu” in the right part of the screen. Manipulating the “Format Menu” enables you to specify the data format (data transformation and graph formats) for each trace.
Trace/View Key	Displays the “Trace View Menu” in the right part of the screen. Manipulating the “Trace View Menu” enables you to specify the data smoothing, data saving on memory, title of trace, etc. for each trace.
Display Key	Displays the “Display Menu” in the right part of the screen. Manipulating the “Display Menu” enables you to specify the screen title display, digit of the y-axis value, marker position, etc. for each active measurement window.
Avg/BW Key	Displays the “Average Menu” in the right part of the screen. Manipulating the “Average Menu” enables you to specify enabling/disabling and number of times for averaging, etc. For spectrum measurements only, you can specify the bandwidth of resolution.
Attn Key	Displays the “Attenuator Menu” in the right part of the screen. Manipulating the “Attenuator Menu” enables you to change the setting of the input signal attenuator.

5. CONTROL Block

A group of keys for defining the values of the DC output port and sweeps as well as trigger settings.

Table 2-3

<div style="border: 1px solid black; padding: 2px; display: inline-block;">Start/Center</div> Key	<p>Displays the data input bar in the upper part of the screen by which you can specify the start value of the sweep range for the active measurement trace or the time offset value for the transient measurement. Also displays the menu in the right part of the screen that allows you to specify the sweep range. You can use the following menus:</p> <ul style="list-style-type: none"> • Phase noise measurement “Start Menu” • Spectrum measurement “Start/Center Menu” • Frequency power measurement “Start/Center Menu” • Transient measurement “Time Offset Menu”
<div style="border: 1px solid black; padding: 2px; display: inline-block;">Stop/Span</div> Key	<p>Displays the data input bar in the upper part of the screen by which you can specify the stop value of the sweep range for the active measurement trace or the span value for the transient measurement. Also displays the menu in the right part of the screen that allows you to specify the sweep range. You can use the following menus:</p> <ul style="list-style-type: none"> • Phase noise measurement “Stop Menu” • Spectrum measurement “Stop/Span Menu” • Frequency power measurement “Stop/Span Menu” • Transient measurement “Span Menu” <p>In these menus, the titles are different from those at the start, but the function of the softkey is the same.</p>
<div style="border: 1px solid black; padding: 2px; display: inline-block;">DC Control</div> Key	<p>Displays the “DC Control Voltage Menu” by which you can specify the values of control voltage output for the DC CONTROL port.</p>
<div style="border: 1px solid black; padding: 2px; display: inline-block;">DC Power</div> Key	<p>Displays the “DC Power Voltage Menu” by which you can specify the values of power voltage output for the DC power port.</p>
<div style="border: 1px solid black; padding: 2px; display: inline-block;">Setup</div> Key	<p>Displays the “Setup Menu” in the right part of the screen. Manipulating the “Setup Menu” enables you to specify the frequency range, IF Gain, input level, etc. required for individual measurements.</p>
<div style="border: 1px solid black; padding: 2px; display: inline-block;">Trigger</div> Key	<p>Displays the “Trigger Menu” in the right part of the screen. Manipulating the “Trigger Menu” enables you to specify the trigger mode and trigger source and obtain triggers. Specify the trigger mode for each measurement window.</p>

6. Floppy Disk Drive

A device to use for storing to and reading from a floppy disk the setup state of the E5052A, measurement data, calibration data, data on images displayed on the LCD screen, VBA (Visual Basic for Applications) programs, etc. The floppy disk drive is compatible with a 3.5-inch, 1.44-MB DOS (Disk Operating System) formatted floppy disk.

A floppy disk access lamp is provided at the lower left of the floppy disk drive opening. When the floppy disk drive is accessing a disk (for reading or writing), this lamp is lit green.

A disk eject button is provided at the lower right of the floppy disk drive opening. Pressing this button ejects the inserted floppy disk.

NOTE

Insert a floppy disk into the floppy disk drive opening **rightside up** in the direction of the arrow marked on the disk.

Do not press the disk eject button while the floppy disk access lamp is on. Trying to forcefully pull the floppy disk out while the lamp is on may damage the floppy disk or disk drive.

7. NAVIGATION Block





The keys and knob in the NAVIGATION block are used to navigate between softkey menus or selected (highlighted) areas in a dialog box and to change numeric values in the data entry area by stepping up or down. When selecting one of two or more objects (softkey menus, data entry areas, etc.) to manipulate with the NAVIGATION block keys displayed on the screen, first press the  key in the “8. ENTRY Block” on page 30 to select the object to be manipulated (focus on the object) and then manipulate the NAVIGATION block keys (knob) to move your selection (highlighted object) or change numeric values.

In the following, you will see how the NAVIGATION block keys work in both the softkey menu and the data entry area. For more on manipulating tables and dialog boxes, refer to the manipulation procedure for each of those functions.

Operation in softkey menu (softkey menu is selected)

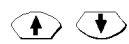
When the focus is on the softkey menu (the menu title area in the uppermost part is displayed in blue), the NAVIGATION block keys work as described below.

Table 2-4

 Knob (turned clockwise or counterclockwise)	Moves the softkey selection (highlighted display) up or down.
 Key	Moves the softkey selection (highlighted display) up or down.
 Key	Displays the softkey menu one layer above.
 Key	Displays the softkey menu one layer below.
 Knob (pressed) or  key	Executes the function of the selected softkey.

After pressing the data entry softkey, the focus automatically moves to the data entry area.

Operation in data entry area (data entry area is selected)

When the focus is on the data entry area (the data entry bar is displayed in blue), the NAVIGATION block keys work as described below.

Table 2-5



 Knob (turned clockwise or counterclockwise)	Increases or decreases the numeric value in the data entry area in small steps.
 Keys	Increases or decreases the numeric value in the data entry area in large steps.

Table 2-5



Keys

Moves the cursor (|) in the data entry area laterally back and forth. Use it together with the “8. ENTRY Block” keys to change data one character at a time.

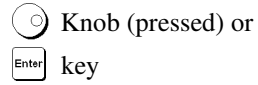

Knob (pressed) or















key

Finishes the entry in the data entry area and moves the focus to the softkey menu.

8. ENTRY Block

A group of keys used for entering numeric data.

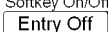
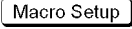





Table 2-6

<p>   . . .  </p> <p>Keys (numeric keys)</p>	<p>Type numeric characters and a decimal point at the position of the cursor in the data entry area.</p>
<p> Key</p>	<p>Alternately changes the sign (+, -) of the numeric value in the data entry area.</p>
<p>   </p> <p>Keys</p>	<p>Adds a prefix to the numeric data typed by using the numeric key and  and then enters that data. One of the two prefixes written on the surface of the key is automatically selected depending on the parameter to be entered.  is entered without a prefix being given.</p>
<p>Softkey On/Off  Key</p>	<p>Turns off the data entry bar if it is displayed. If the dialog box is displayed, cancels the entry and close the dialog box. If the data entry bar and dialog box are not displayed, turns the softkey menu display on/off.</p>
<p> Key</p>	<p>Deletes the character to the left of the cursor () in the data entry area. When two or more characters in the data entry area are selected (highlighted), deletes all the characters selected.</p>
<p> Key</p>	<p>Changes the selection (focus) between the objects to be manipulated by the keys for “7. NAVIGATION Block” on page 28 and “8. ENTRY Block” on page 30.</p> <p>“7. NAVIGATION Block”: The objects to be manipulated by the “8. ENTRY Block” keys include softkey menus, data entry areas, tables (e.g., segment tables, limit tables, and marker tables), and dialog boxes. When two or more of these are displayed on the screen and need selecting, use this key to change the selection (focus) between the objects to be manipulated. When a softkey menu is selected, the menu name area at the top of the menu is displayed in blue. When a data entry area is selected, the data entry bar is displayed in blue. When a table is selected, the frame of the table window is displayed in light gray.</p> <p>While a dialog box is displayed, the focus is fixed on the dialog box and cannot be changed.</p>

9. INSTR STATE Block

A group of keys related to the macro function, store and call function, control/management function, and the presetting of the E5052A (returning it to the preset state).



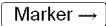

Table 2-7

 Key	Displays the “Macro Setup Menu” in the right part of the screen. Manipulating the “Macro Setup Menu” enables you to start up the VBA editor, or create, call, or store a VBA project.
 Key	Executes a VBA procedure called “main” that has a VBA module named Module1.
 Key	Stops the VBA procedure being executed.
 Key	Displays the “Save/Recall Menu” in the right part of the screen. Manipulating the “Save/Recall Menu” enables you to store to or read from the internal hard disk or floppy disk the setup conditions and trace data of the analyzer.
 Key	First, temporarily saves the data for the image displayed on the LCD screen at the moment the key is pressed to the internal memory (clipboard). Immediately afterwards, it displays the “System Menu” on the right side of the screen. Manipulating the “System Menu” enables you to define the setup for the control and management of the analyzer. Using the Dump Screen Image key enables you to store the image data in the clipboard to a file on the internal hard disk or a floppy disk. Also, using the Print key in the System menu enables you to print the image data in the clipboard to a printer.
 Key	Displays the “Preset Menu” on the right side of the screen. Pressing Factory enables you to return the analyzer to the initial setup state. For the initial setup for each of the functions, see Appendix C, “List of Default Values,” on page 365. Pressing User recalls the Autorec.sta in the F drive.

10. MKR/ANALYSIS Block

A group of keys used to control the markers in analyzing the measurement results. For more on the functions of the keys in the MKR/ANALYSIS block, see Chapter 2 “Overview of Functions” in the User’s Guide.

Table 2-8

 Key	<p>Displays the “Marker Menu” on the right side of the screen. Manipulating the “Marker Menu” enables you to turn the markers on/off and to move them by entering stimulus values. You can place up to 6 markers on each trace.</p>
 Key	<p>Displays the “Marker Search Menu” on the right side of the screen. Manipulating the “Marker Search Menu” enables you to move a marker to a specific point (maximum, minimum, peak, and a point with a target value) on a trace. You can also find and display the bandwidth parameters (up to six).</p>
 Key	<p>Displays the “Marker To Menu” in the right part of the screen. Manipulating the “Marker To Menu” enables you to specify the marker sweep range and the coupling of markers within a measurement and to display statistical data on traces.</p>
 Key	<p>Displays the “Analysis Menu” on the right side of the screen. Manipulating the “Analysis Menu” enables you to use the analytical functions.</p>

11. DUT Interface

A port used to connect the DUT. It has a DC CONTROL port, DC POWER port, and RF port. The connector type of each port is given below.

RF port: 50 Ω, N-type, female connector

DC CONTROL port, DC POWER port: BNC, female connector

CAUTION



Do not apply a DC voltage or current to the individual ports of the DUT interface. Applying a DC voltage or current may lead to device failure. In particular, there is the risk of the capacitor remaining charged. Connect the measurement sample (DUT) to the port (or the test fixture, cables, etc. connected to the port) after the analyzer’s power has been completely discharged.

The individual ports comply with Installation Category I of IEC 61010-1 and Measurement Category I of IEC 61010-1.

12. OPTIONAL RF Ports

For the firmware version A.01.50, these ports are already connected and ready to operate; the user does not have to connect them.

For the firmware version A.02.00, the user have to connect these ports when the E5053A microwave downconverter are used with the E5052A.

LCD Screen: Names and Functions of Parts

This section describes the names and functions of the parts on the E5052A's LCD screen.

Figure 2-2 Screen Display

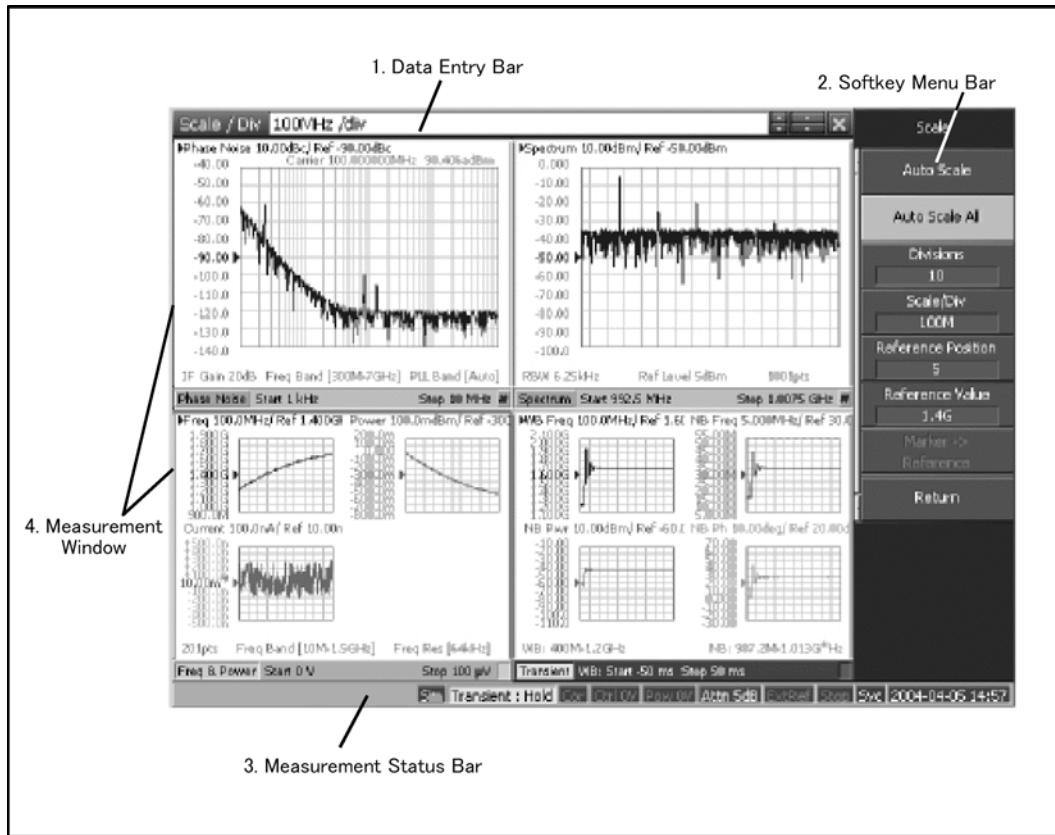

e5052aue053

1. Data Entry Bar

Used to enter numeric data into the E5052A. Press a hardkey or softkey to enter data, and the data entry bar will appear at the top of the screen. To assign a title to a measurement window, the entry bar also allows you to enter letters and symbols by using the front panel keys or mouse.

Figure 2-3

Data Entry Bar

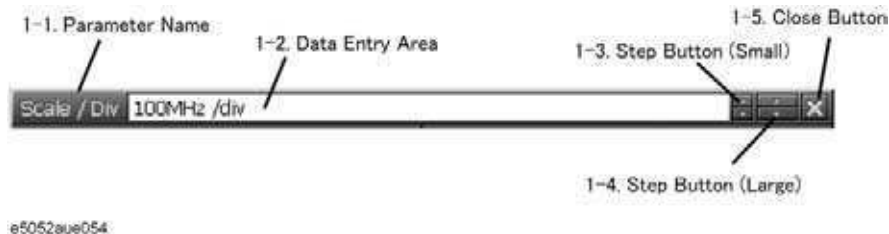

NOTE

To manipulate the data entry bar with the front panel keys, it has to be selected as the object to manipulate (focus placed on it). When the focus is placed on the data entry bar, the entire bar is displayed in blue. Pressing or clicking on **Focus** of “8. ENTRY Block” on page 30 enables you to move the focus to the desired object.

1-1. Parameter Name

Displays the name of the parameter for which data will be entered.

1-2. Data Entry Area

When the data entry bar is displayed for the first time, the current settings are displayed on it. You can change numeric values by typing from the keyboard or in the ENTRY block on the front panel.

1-3. Step Button (Small)

Increases or decreases the numeric value in the data entry area in small steps. Use the mouse to manipulate these buttons.

1-4. Step Button (Large)

Increases or decreases the numeric value in the data entry area in large steps. Use the mouse to manipulate these buttons.

1-5. Close Button

Closes the data entry area (turns off the display). Use the mouse to manipulate this button.

2. Softkey Menu Bar

A group of keys on the screen called up by the hardkeys or menu bars. You can manipulate these keys by using the NAVIGATION block keys on the front panel, the mouse, or the keyboard. You can perform manipulations by directly touching the screen with your finger instead of using a mouse.

Figure 2-4

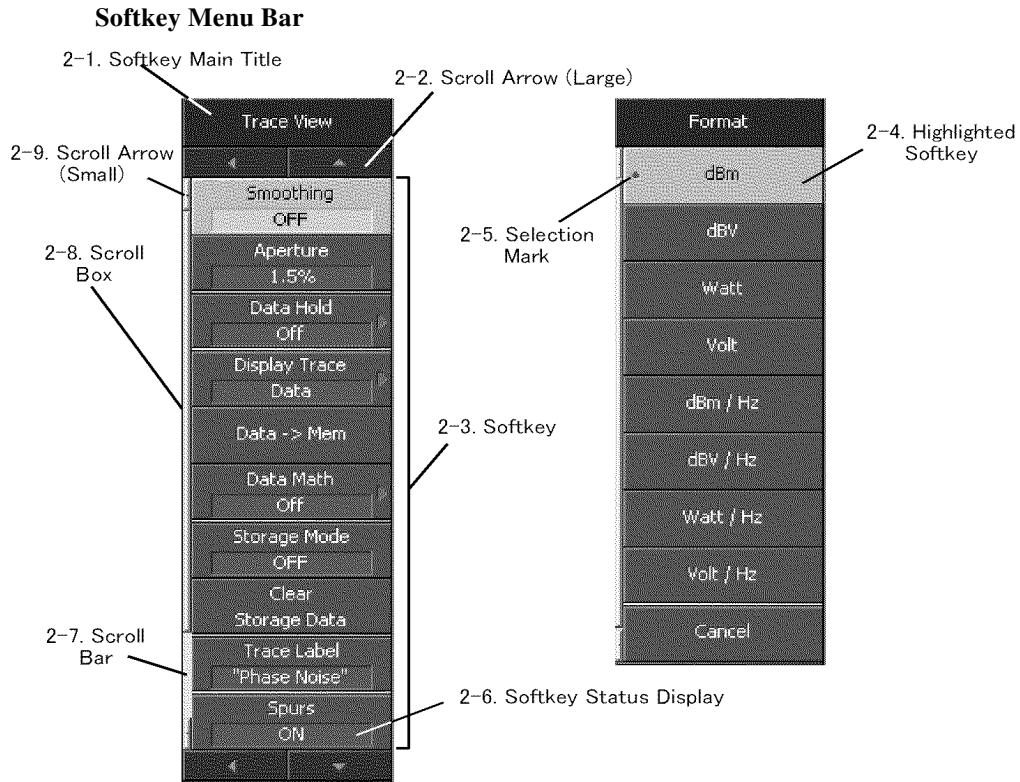

e5052aue075

NOTE

To manipulate a menu bar, it has to be selected as the object to manipulate (focus placed on it). When the focus is placed on a menu bar, any of the softkeys may be highlighted. An example of the focus not being placed on the menu bar is when it's on the data entry bar.

2-1. Softkey Menu Title

The title of the softkey menu is displayed here. Double-clicking on this part of the menu bar displays the top layer of softkeys.









2-2. Scroll Arrow (Large)





When the softkeys in a menu overflow the screen, using this key enables you to scroll the menu page by page. There are four scroll arrows: two for up and down and two for returning to the top menu (at top and bottom). Use the mouse to manipulate these buttons.

2-3. Softkeys

These are the actual keys you can use to perform setup. A ► displayed to the right of a softkey indicates that pressing that softkey will display the lower layer of softkeys.

2-4. Highlighted Softkey

Pressing  and  on the front panel or pressing  on the keyboard causes the highlighted (selected) softkey to be executed. You can change which softkey in the menu is highlighted by turning  or pressing   on the front panel or by pressing   on the keyboard.

Pressing the  key on the front panel or the  key on the keyboard brings up the upper level softkey menu, and pressing the  key on the front panel or the  key on the keyboard brings up the lower level softkey menu.

2-5. Selection Mark

Shows which softkey function is currently selected.

2-6. Softkey Status Display

Displays the setup status of that softkey.

2-7. Scroll Bar

When the softkeys in a menu overflow the screen, clicking on the blank part of this scroll bar enables you to scroll the softkey menu up or down.

2-8. Scroll Box

You can scroll the softkey menu up or down by using the mouse to select and drag the scroll box (pressing the button on the object to be moved and then releasing the button at the desired location). The length and position of the scroll box indicate the length and position of the currently displayed part of the softkey menu relative to the entire menu.

2-9. Scroll Arrow (Small)

Using this button, you can scroll the menu one softkey at a time. Both upward and downward scroll arrows are available. Use the mouse to manipulate these buttons.

3. Instrument Status Bar

This graphical bar displays the status of the entire instrument.

Figure 2-5

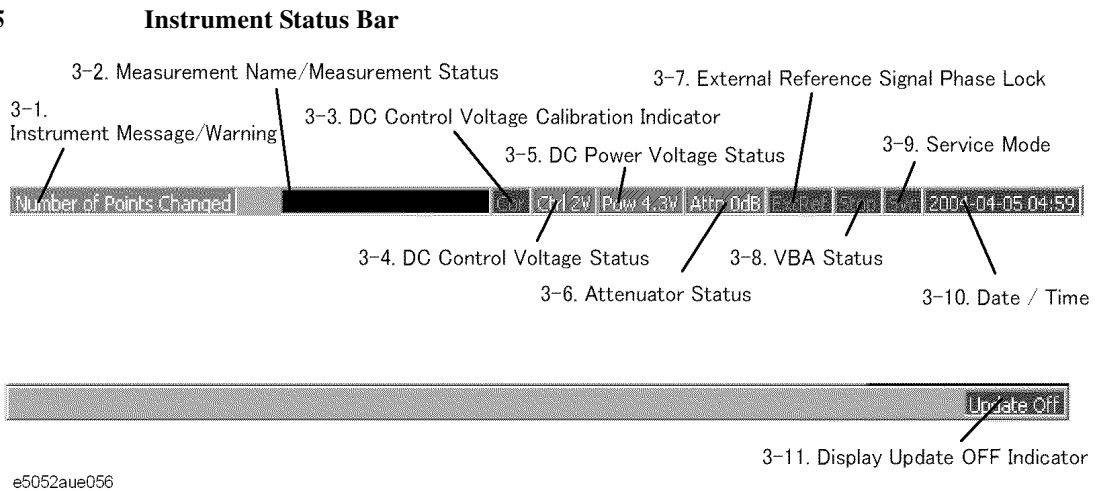

3-1. Instrument Message/Warning

Displays instrument messages and warnings. Instrument messages are displayed in gray and warnings in red. For the meanings of the instrument messages and warnings, see Appendix B, “Troubleshooting,” on page 351.

3-2. Measurement Name/Measurement Status

Displays the measurement name and measurement status of the E5052A. Each measurement status is described below.

Table 2-9

Hold	A holding state is maintained for measurement (idling).
Man	The trigger source is set to “Manual” and waiting for trigger.
Ext	The trigger source is set to “External” and waiting for trigger.
Bus	The trigger source is set to “Bus” and waiting for trigger.
NVideo ^{*1}	The trigger source is set to “Narrow Video” and waiting for trigger.
WVideo ^{*1}	The trigger source is set to “Wide Video” and waiting for trigger.
Meas	A measurement is in progress.

*1. You can select "Narrow Video" or "Wide Video" for the transient measurement only.

3-3. DC Control Voltage Calibration Indicator

When the DC control voltage calibration is enabled, it is displayed in blue. When disabled, it is displayed in grey.

3-4. DC Control Voltage Status

When the DC control voltage signal output is turned on, the specified voltage is displayed.

3-5. DC Power Voltage Status

When the DC power voltage signal output is turned on, the specified voltage is displayed.

3-6. Attenuator Status

The specified attenuator value is displayed.

3-7. External Reference Signal Phase Lock

When the frequency reference signal is input to the “10. External Reference Signal Input Connector (Ref In)” on page 48 on the rear panel and the measurement signal of the E5052A is phase-locked to the reference signal, **ExtRef** is displayed in blue.

Table 2-10

ExtRef (displayed in blue)	Measurement signal is phase-locked to external reference signal.
ExtRef (displayed in gray)	Measurement signal is not phase-locked to external reference signal.

NOTE

When the phase lock function is not operated improperly, “**Unlock**” is displayed in red. Even when “9. High Stability Frequency Reference Output Connector (Ref Oven)” on page 48 and “10. External Reference Signal Input Connector (Ref In)” on page 48 are interconnected, the measurement signal may not be phase-locked immediately after powered on under a cool-temperature environment (i.e. the display of “ExtRef” does not change from grey to blue). In this case, wait a few minutes until the instrument warms-up and “ExtRef” is displayed in blue.

3-8. VBA Status

Indicates the current status of the VBA program running on the E5052A.

Table 2-11

Run	VBA program is currently running.
Stop	VBA program has stopped.

3-9. Service Mode

Indicates the service mode status.

Table 2-12

SVC (displayed in red)	An abnormal condition has been detected inside the E5052A. The unit may be damaged. Notify the Customer Contact listed at the end of this brochure or the distributor from whom the unit was purchased.
SVC (displayed in gray)	The E5052A is in normal mode.

3-10. Date / Time

Displays the date and time generated by the internal clock. The display format is as follows:

Table 2-13

YYYY-MM-DD HH:MM	YYYY: Year (AD) MM: Month DD: Day HH:MM: Time (0:00 to 23:59)
-------------------------	--

You can turn the date and time display on/off by manipulating the keys: **System** - **Misc Setup** - **Clock Setup** - **Show Clock**.

3-11. Display Update OFF Indicator

When you have turned off updating of information displayed on the LCD screen, this indicator is displayed.

4. Measurement Window

This provides windows for displaying traces. Because a measurement corresponds to a window, it is called a measurement window. When the outer frame of a measurement window is displayed in light gray, the measurement is active (the measurement for which setup is being performed). Figure 2-2 on page 34 shows that the transient measurement is active (lower-right window). To make a measurement active, use **Window Next**. Clicking inside a measurement window will also make it active. Figure 2-6 shows a spectrum measurement displayed in maximum screen by using **Window Max**.

Figure 2-6 Measurement Window

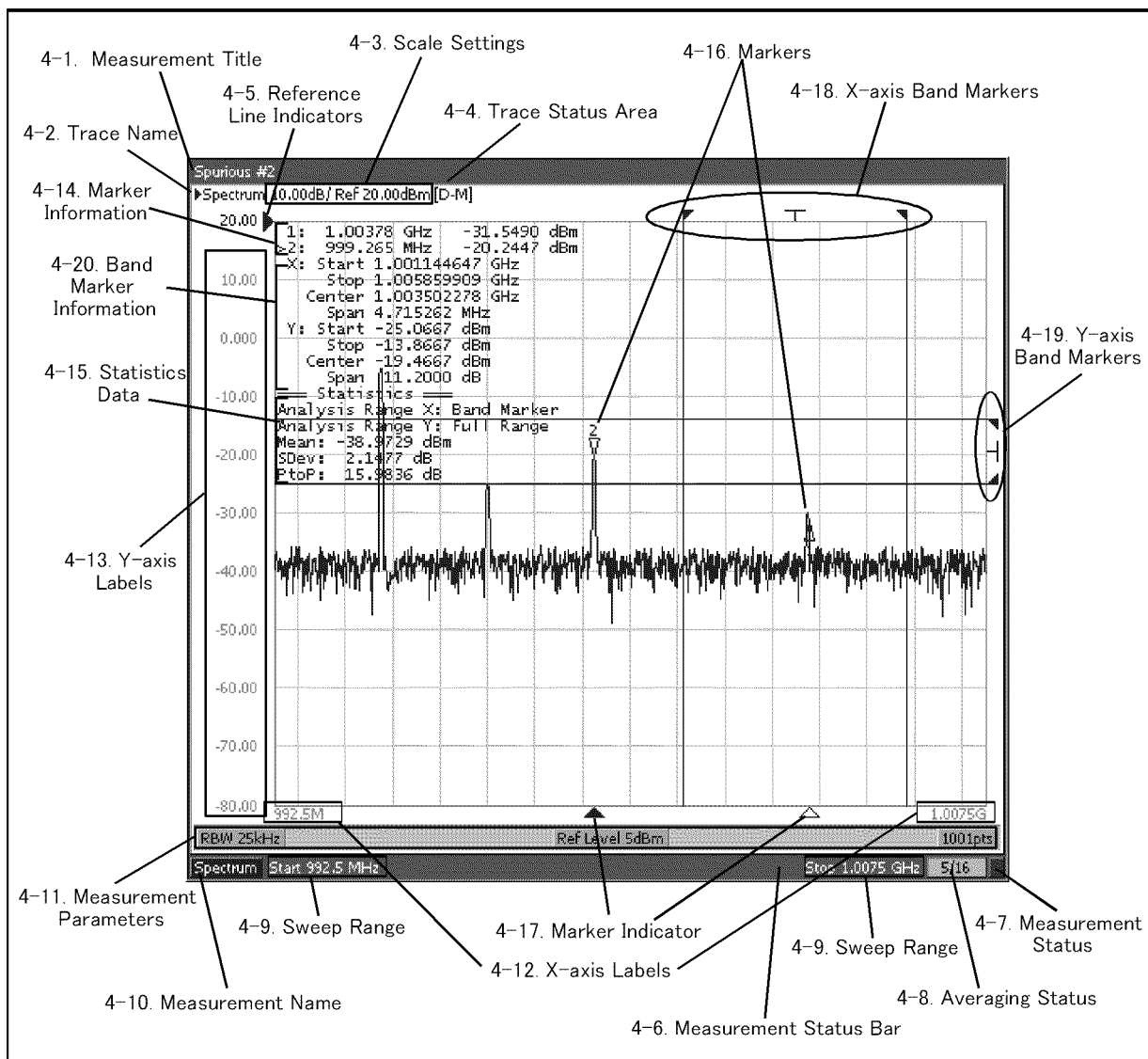

e5052aue3001

2. Overview of Functions

4-1. Measurement Title

You can assign a title to each channel and have the title displayed in the bar. To set up the measurement title, enter a title in **[Display]** - **Edit Title Label** and then toggle on/off the title display by using **[Display]** - **Title Label** .

4-2. Trace Name

The names of the traces on the measurement are displayed here. **▶** to the left of the trace name indicates the active trace (the trace for which setup is being performed). To switch over the active trace, use **[Trace Next]**.. Clicking the graph of the trace will also activate the trace.

4-3. Scale Settings

The scale setting for each trace is displayed here. This example shows that “0.00dB/” corresponds to 10 dB per division. “Ref -50.00.000dB” shows that the value of the reference line is -50 dB. To specify the scale settings, use each softkey that can be displayed by pressing the **[Scale]** hardkey.



4-4. Trace Status Area

The setup for each trace is displayed here.

Table 2-14 Trace Status Display

Classification	Contents inside the []	Meaning
Turning on/off traces	Nothing M D&M off	Data trace: ON, Memory trace: OFF Data trace: OFF, Memory trace: ON Data trace: ON, Memory trace: ON Data trace: OFF, Memory trace: OFF
Performing data math: Refer to the indication in parentheses when the memory trace is turned on.	D+M (D+M&M) D-M (D-M&M) D*M (D*M&M) D/M (D/M&M)	Execution of Data+Mem math Execution of Data-Mem math Execution of Data*Mem math Execution of Data/Mem math
Smoothing	Smo	Smoothing: ON

4-5. Reference Line Indicators

These indicate the position of the reference line for the Y-axis scale in the rectangular display format. There is an indicator to the right of the scale (**▶**). To enter a numeric value for the position of the reference line, open the data entry bar using the keys: **[Scale]** - **Reference Position**. You can also move the position of the reference line by placing the mouse pointer on the reference line indicator (the pointer changes from  to ), moving the indicator vertically with the left mouse button kept pressed, and then releasing the button at the desired location (i.e., a drag-and-drop operation).

4-6. Measurement Status Bar

The status of each measurement is displayed here (see parts 4-7 through 4-10).

4-7. Measurement Status

Displays the update status of traces on the measurement.

Table 2-15

#	Invalid traces. The measurement conditions have changed, but the traces on the measurement window currently displayed have not been updated to match the new conditions.
(not displayed)	Valid traces.

4-8. Averaging Status

Displays the averaging factor and averaging count when averaging is turned on.

Table 2-16

n/m (displayed in blue)	Averaging: ON (m: averaging factor; n: averaging count)
(not displayed)	Averaging: OFF

4-9. Sweep Range

Indicates the sweep range by using the start/stop or center/span. This varies depending on the given parameters or measurements.

4-10. Measurement Name

Indicates the measurement name.

4-11. Measurement Parameters

Indicates the parameters specified to perform a measurement sweep at the bottom of each measurement screen. The content may vary depending on the measurement.

4-12. X-axis Labels

X-axis divisions in the rectangular display format. To hide the divisions, select "OFF" in **-Y # of Digits**. (The display/nondisplay of the X-axis divisions interlocks with that of the Y-axis divisions.)

4-13. Y-axis Labels

Y-axis divisions in the rectangular display format. The value of the reference line (the division line indicated by ►) can be entered numerically by opening the data entry bar using the keys: **Scale** - **Reference Value**. You can change values of the reference line in one division intervals by placing the mouse pointer in the area of the graticule label (the pointer changes from ↖ to ↕), moving the pointer vertically with the left mouse button pressed, and then releasing the button at the desired location. By using **Display** - **Y # of Digits**, you can select the display format of the graticule label from three options: 4 digits, 12digits, and "not displayed."

4-14. Marker Information

The marker information is displayed in a list. It shows the marker number, marker x-axis value, and marker measurement value from left to right. For the active marker (the one for which setup and analysis are being performed), > is displayed to the left of the marker number. For the reference marker, △ is displayed instead of the marker number.



4-15. Statistics Data

Turning on the statistics data function displays statistics data here. For more about the statistics data function, see “Determining Mean, Standard Deviation, and Peak-to-Peak of the Trace” on page 220.

4-16. Markers

The markers used for reading values on a trace. Up to six markers can be displayed for each trace.

Table 2-17



	Active marker (ready for setup and analysis)
	Non-active marker



Here, “n” denotes a marker number. For the reference marker, however, nothing is displayed at the location of n. Clicking the marker or one of the “4-17. Marker Indicators” makes the marker active.

4-17. Marker Indicators

These indicate the positions of markers on the x-axis.

Table 2-18

	Active marker indicator
	Non-active marker indicator



You can also move a marker to the desired position by placing the mouse pointer on the marker indicator or the position of the marker itself (the pointer changes from  to ), moving the indicator vertically with the left mouse button pressed, and then releasing the button at the desired location.

4-18. X-axis Bandmarkers

By turning on the x-axis band marker function, the x-axis band marker is displayed in a specified position.

Table 2-19

▶	Indicator of start value of x-axis band marker
◀	Indicator of stop value of x-axis band marker
T	Indicator of center value of x-axis band marker



You can also move a marker to the desired position by placing the mouse pointer on the marker indicator or the position of the marker itself (the pointer changes from  to ) , moving the indicator vertically with the left mouse button pressed, and then releasing the button at the desired location.

4-19. Y-axis Bandmarkers

By turning on the y-axis band marker function, the y-axis band marker is displayed in a specified position

Table 2-20

▶	Indicator of start value of y-axis band marker
▲	Indicator of stop value of y-axis band marker
-	Indicator of center value of y-axis band marker

You can also move a marker to the desired position by placing the mouse pointer on the marker indicator or the position of the marker itself (the pointer changes from  to ) , moving the indicator up or down with the left mouse button pressed, and then releasing the button at the desired location.

4-20. Bandmarker information

Turning on the x-axis or y-axis band marker function will display the corresponding band marker information on a list in the order of start, stop, center and span.

Rear Panel: Names and Functions of Parts

This section describes the names and functions of the parts on the rear panel of the E5052A.

Figure 2-7 Rear Panel

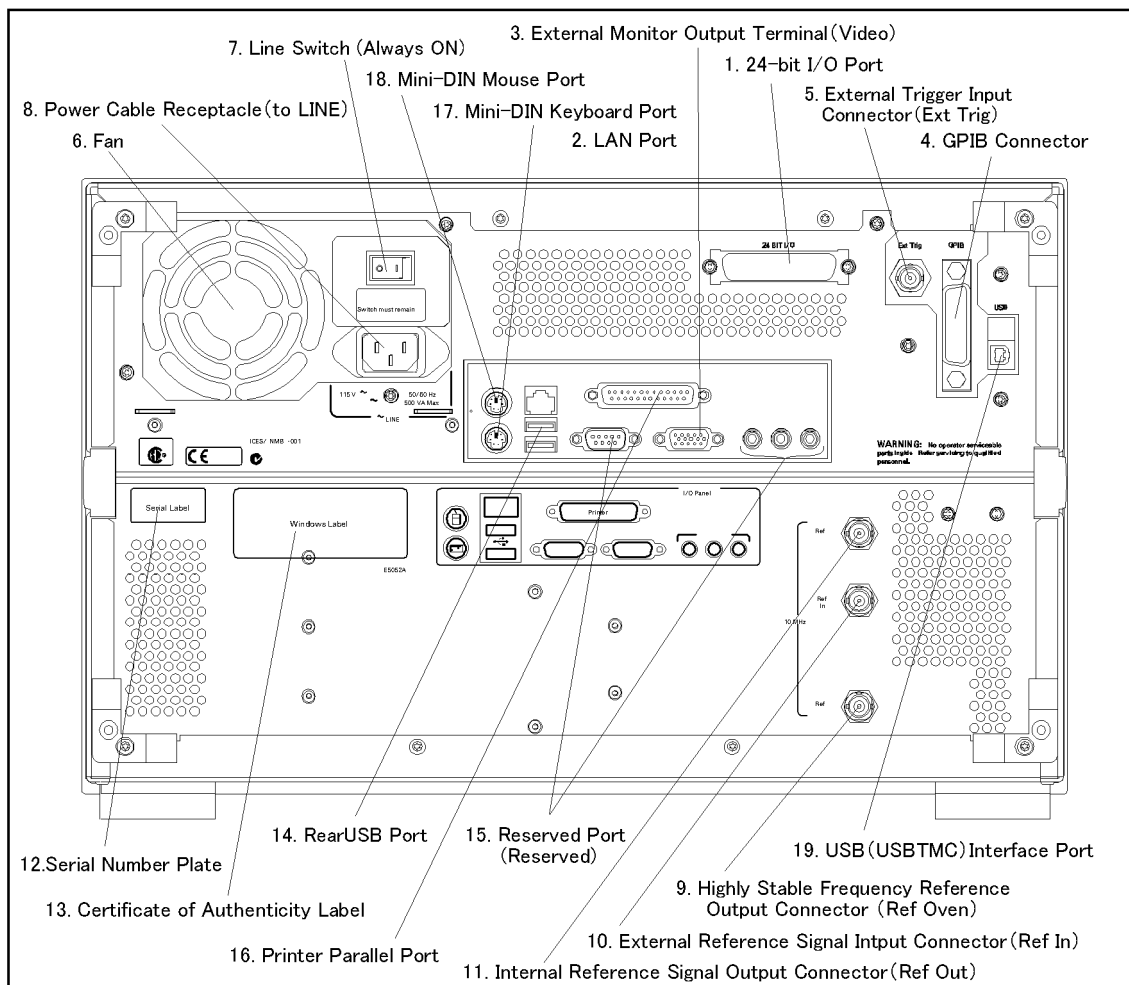

e5052aue4006

1. 24-bit I/O Port

The terminal to which an automatic machine (handler) used on a production line is connected. For more about using the 24-bit I/O port, see the Programmer's Guide.

Connector type: 36-pin Ribbon (centronics) connector

2. LAN Port

A terminal for connecting the E5052A to a LAN (Local Area Network). Connecting this instrument to a LAN enables you to access the hard disk drive of the instrument from an external PC or to control this instrument by using SICL-LAN or telnet.

Connector type: 8-pin RJ-45 connector

Base standard: 10Base-T/100Base-TX Ethernet (automatic data rate selection)

3. External Monitor Output Terminal (Video)

The terminal to which an external color monitor (display device) is connected. By connecting the color monitor to this terminal, the same information shown on the LCD screen of the main body can be displayed on an external color monitor.

Connector type: 15-pin VGA connector, female

4. GPIB Connector

General Purpose Interface Bus (GPIB). The connection of an external controller and other devices through this connector allows you to configure an automatic measurement system. For more on automatic measurement systems via GPIB, see the *Programmer's Guide*.

5. External Trigger Input Connector (Ext Trig)

External trigger signals are input through this connector, which detects the downward transition from the HIGH state in TTL signals as the trigger signal. To use this connector to generate a trigger, you must set the trigger source to the "external" side (key operation:

Trigger - Source - External).

Connector type: BNC connector, female

6. Fan

The cooling fan for controlling the temperature inside the E5052A. This fan exhausts heated air from inside the analyzer to the outside.

7. Line Switch (Always ON)

Always keep this switch on (I).

CAUTION

Do not use this switch to turn off (O) the mains. Doing so may cause the analyzer to fail. For more information, see the description of the "1. Standby Switch" on page 23.

8. Power Cable Receptacle (to LINE)

The receptacle (outlet) to which the power cable is connected.

NOTE

To feed power, use the included three-prong power cable with a ground conductor.

The plug attached to the power cable (on the power outlet side or device side of the cable) serves as the disconnecting device (device that cuts off power supply) of the E5052A.

When the power supply must be cut off to avoid danger such as electric shock, pull out the power cable plug (on the power outlet side or device side of the cable). The procedure for turning off the mains in normal use is given in “1. Standby Switch” on page 23.

For more about the power supply, see Chapter 3, “Installation,”.

9. High Stability Frequency Reference Output Connector (Ref Oven)

A connector from which the reference signals are output.

Connector type: BNC connector, female

Output signal (Nominal): 10 MHz, +0 dBm \pm 3 dB

10. External Reference Signal Input Connector (Ref In)

The reference signal input connector for phase-locking the measurement signal from the E5052A to the external frequency reference signal. Inputting the reference signal via this connector improves the accuracy and stability of the frequency of the measurement signal from the E5052A.

Connector type: BNC connector, female

Input signal (typical): 10 MHz \pm 10 Hz, – 6 dBm to + 16 dBm

NOTE

When the frequency reference signal is input to this connector, the measurement signal from the E5052A is automatically phase-locked to the reference signal. When an input signal is not present, the frequency reference signal inside the E5052A is automatically used. The **ExtRef** on the instrument status bar is displayed in blue when the system is phase-locked to the external reference signal and in gray when it is not phase-locked.

11. Internal Reference Signal Output Connector (Ref Out)

A connector for outputting the internal frequency reference signal from the E5052A. By connecting this output connector to the external reference signal input connector of another device, the device can be phase-locked to the internal reference signal of the E5052A and used under this condition.

Connector type: BNC connector, female

Output signal (typical): 10 MHz \pm 50 Hz, + 2.5 dBm \pm 3 dB

Output impedance (typical): 50 Ω

12. Serial Number Plate

The seal showing the serial number of the product.

13. Certificate of Authenticity Label

The label showing the information of the “Certificate of Authenticity.”

14. Rear USB port

A USB (Universal Serial Bus) port (number of ports: 2) specifically for a USB/GPIB interface or a printer.

15. Reserved Port (Reserved)

Using these two ports is not allowed. No connections.

16. Printer Parallel Port

The 25-pin parallel port for printer connection. Connecting a designated printer to this port allows screen information on the E5052A to be printed. For more on printing, see “Printing Screen Image” on page 245.

17. Mini-DIN Keyboard Port

The port to which a mini-DIN type keyboard is connected. The keyboard can be used to edit VBA programs inside the E5052A or to enter file names. Since the arrow keys and numeric keys on the keyboard work in the same way as the arrow keys and numeric keys on the front panel of the E5052A, you can use it instead of front panel operation.

NOTE

Be sure to only use a keyboard designated for use with this instrument. Using a keyboard other than those designated may cause erroneous input.

18. Mini-DIN Mouse Port

The port to which a mini-DIN type mouse is connected. Using a mouse enables you to more efficiently perform the operations of menu bars, softkeys, and dialog boxes as well as selecting an active channel or an active trace. The mouse also enables you to move a marker or the scale reference line by using drag-and-drop operations.

NOTE

Be sure to only use a mouse designated for use with this instrument. Using a mouse other than those designated may cause erroneous input.

19. USB (USBTMC) Interface Port

Through this port, you can control the E5052A from external controllers. For more information on the measurement system using the USB port, see the Programmer's Guide.

Connector Types: Universal serial bus (USB) jack, type B (4 contact positions), Female

Compliance Standards: USBTMC-USB488 and USB2.0

Overview of Functions

Rear Panel: Names and Functions of Parts

3

Installation

This chapter provides information on how to set up the Agilent E5052A signal source analyzer and on daily maintenance.

Contents of this Chapter

- ❑ **Checking the Shipment** on page 53
After you receive the analyzer, check all of the items in the packing container.
- ❑ **Environmental Requirements** on page 56
Describes the system requirements needed to install the E5052A and how to secure space for heat radiation.
- ❑ **Installing Front Handles/Rack Mounting Flanges** on page 59
Shows how to mount the front handles used to transport the E5052A and how to install the flanges needed to install it in a rack.
- ❑ **Connecting the Accessories** on page 62
Provides information for connecting the mouse, keyboard, and LAN cable to the E5052A.
- ❑ **Power Supply and Blown Fuses** on page 65
Shows how to check the power supply as well as how to check and connect the power cable. This section also explains how to handle a blown fuse.
- ❑ **Starting the E5052A** on page 68
Describes turning on/off of the Power switch and cutting off the power supply.
- ❑ **Initial Registration of E5052A** on page 70
Describes initial registration of the Windows 2000 operating system.
- ❑ **Setting the Internal Clock** on page 73
Explains how to set the internal clock.
- ❑ **Daily Maintenance** on page 75
Describes the required daily maintenance for the E5052A.

Checking the Shipment

After you receive the analyzer, inspect the contents during unpacking according to the following procedure.

WARNING

When unpacking the analyzer, if an external surface of the analyzer (such as the cover, front/rear panel, LCD screen, power switch, and port connectors) appears to have been damaged during transport, do not turn on the power switch. In an extreme case, this may result in your getting an electric shock.

-
- Step 1.** Check that the packing box or shock-absorbing material used to package the analyzer has not been damaged.

NOTE

If the packing box or shock-absorbing material has been damaged, leave the packing box and shock-absorbing material as is until other inspections are made as follows:

- Step 2.** Check the packaged items supplied with the analyzer for any damage or defect.
- Step 3.** By referring to Table 3-1 and Figure 3-1, check that all packaged items supplied with the analyzer have been provided as per the specified options.
- Step 4.** After checking, if one of the following applies, contact your nearest Agilent Technologies sales and service office.
1. The packing box or shock-absorbing material used to package the analyzer has been damaged or the shock-absorbing material shows evidence where extreme force has been applied.
 2. A packaged item supplied with the analyzer has mechanical damage or defects.
 3. An item that should be packaged with the analyzer is missing.
 4. A fault has been detected in the subsequent operation check of the analyzer.

If an abnormality is detected in Step 1, contact the company that transported the analyzer as well as your nearest Agilent Technologies sales and service office. For inspection by the transport company, save the packing box, shock-absorbing material, and packaged items as you received them.

Installation
Checking the Shipment

Table 3-1 **Items Packaged with the E5052A**

Name	Agilent Product/ Part Number	Qty
Standard Accessories		
<input type="checkbox"/> E5052A	E5052A	1
<input type="checkbox"/> Power cable *1	-	1
<input type="checkbox"/> CD-ROM (of the manual)*2	E5052-9050x	1
<input type="checkbox"/> CD-ROM (of the Agilent IO Libraries Suite)	E2094-60003	1
<input type="checkbox"/> System recovery disk	E5052-16000	1
<input type="checkbox"/> BNC adaptor	1250-1859	1
Options		
<input type="checkbox"/> Keyboard (Option 810)	-	1
<input type="checkbox"/> Mouse (Option 820)	-	1
<input type="checkbox"/> Manual (Option ABA)*3		
• User's Guide	E5052-900x0	1
• Programmer's Guide	E5052-900x1	1
• VBA Programmer's Guide	E5052-900x2	1
<input type="checkbox"/> Handle Kit (Option 1CN)*4	5063-9230	1
<input type="checkbox"/> Rack Mount Kit Without Handles (Option 1CM)*4	5063-9217	1
<input type="checkbox"/> Rack Mount Kit With Handles (Option 1CP)*4	5063-9224	1

*1. This accessory varies from country to country. For an illustration of the power cable options, see Figure 3-8.

*2. The CD-ROM contains the same information as in the *User's Guide, Programmer's Guide, VBA Programmer's Guide*. The "xx" in the part number is a number that is incremented each time a revision is made, with "00" regarded as the first edition. The network analyzer will always be supplied with the latest versions of these items.

*3. The "x" in the part number of the Manual is a number that is incremented each time a revision is made, with "0" regarded as the first edition. The network analyzer will always be supplied with the latest versions of these items.

*4. This accessory is not shown in Figure 3-1. For details, see Table 3-3 on page 59.

Figure 3-1 E5052A accessories

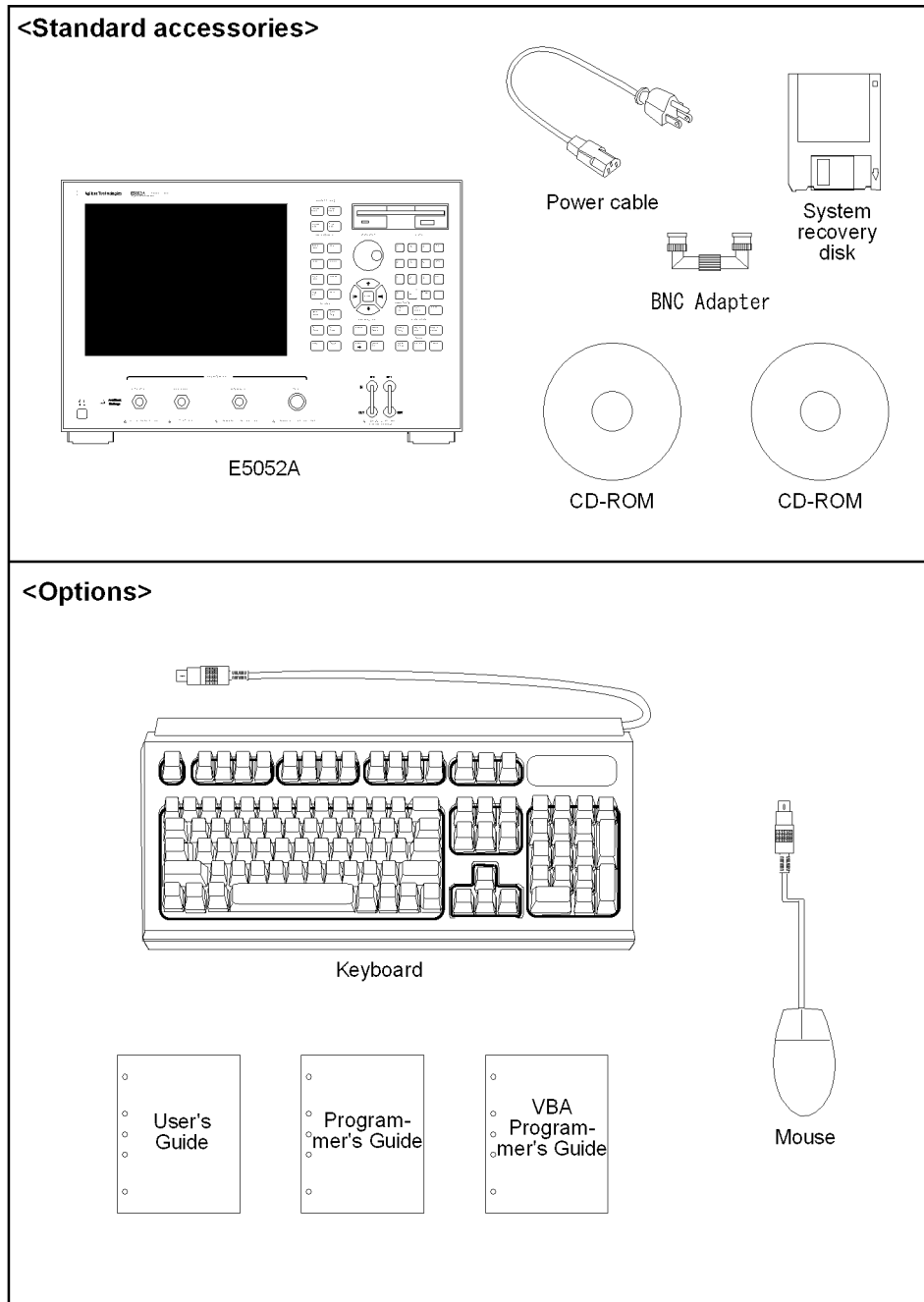

e5052aue3008

Environmental Requirements

Set up the E5052A in a location where the following environmental requirements are met.

Operating environment

Ensure that the operating environment meets the following requirements.

Temperature	10°C to 40°C
Temperature range at the error-correction	23°C ±5°C (<1°C deviation from the temperature when performing the error-correction)
Humidity	20% to 80% at wet bulb temperature <+29 °C (non-condensation)
Altitude	0 to 2,000 m (0 to 6,561 feet)
Vibration	0.21 G maximum, 5 Hz to 500 Hz

NOTE

The above environmental requirements are **not** intended for the specifications and measurement accuracy of the analyzer but for the operating environment of the analyzer.

Ventilation requirements

To ensure compliance with safety requirements, as well as the specifications and measurement accuracy of the analyzer, you must maintain an environmental temperature that is within the specified range by providing appropriate cooling clearance around the analyzer (or, for the rackmount type, by forced air-cooling inside the rack housing). For more information on the environmental temperature needed to satisfy the specifications and measurement accuracy of the analyzer, see the Chapter 10, “Specifications and Supplemental Information.”

When the environmental temperature around the analyzer is kept within the temperature range of the operating environment specification (see the section on “Operating environment” on page 56), the analyzer conforms to the requirements of the safety standard. Furthermore, under that temperature requirement, the analyzer still conforms to the requirements of the safety standard even when the analyzer is placed with the following cooling clearance:

	Requirement
Back	≥180 mm
Sides	≥60 mm (both right and left)

Figure 3-2

Ventilation space needed for installation

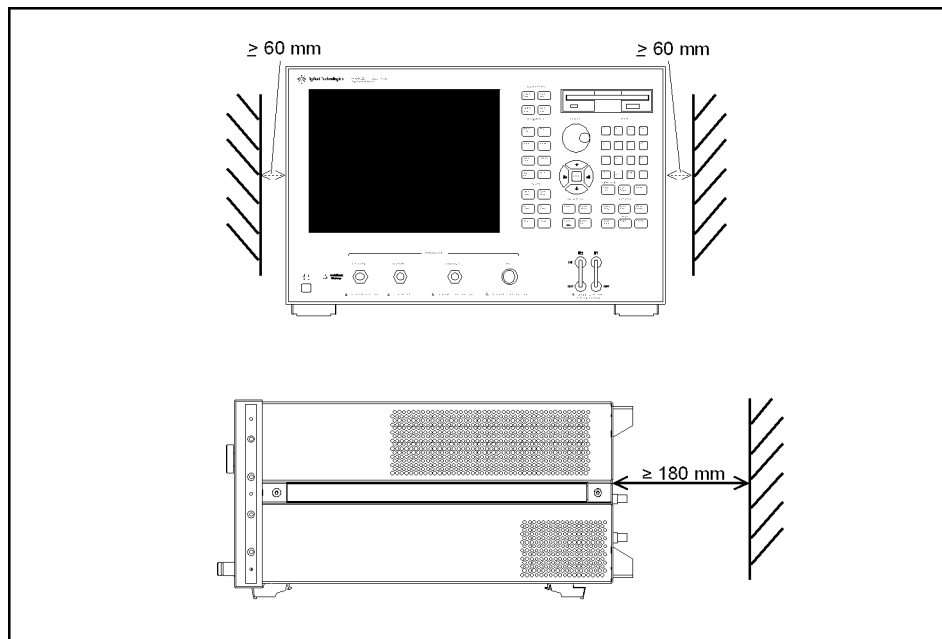

e5052auj007

Protection against electrostatic discharge (ESD)

Set up a static-free workstation to protect the electronic components against damage by electrostatic discharge (ESD) as shown in Figure 3-3.

Figure 3-3

Example of static-free workstation

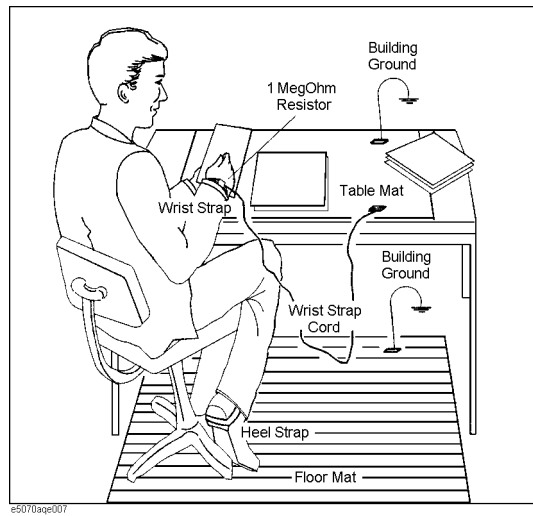

Ensuring adequate free space around analyzer for immediate disconnection of power cable in case of emergency

As described in “Disconnection from supply source” on page 69, the power supply is disconnected by removing the power cable’s connector plug from either the AC outlet or the E5052A unit. When installing the E5052A, ensure that there is sufficient free space around the unit to permit quick disconnection of the plug (from AC outlet or E5052A unit) in case of emergency.

Installing Front Handles/Rack Mounting Flanges

The E5052A can be installed on a workbench or in a rack. This section describes how to install the front handles (Option 1CN) used for transporting the instrument and how to install the analyzer in an equipment rack as part of a measurement system (Option 1CM: without handles, Option 1CP: with handles).

Table 3-2 **Agilent E5052A handles/rack mounting options**

Option	Name	Agilent Part Number
1CN	Handle Kit	5063-9230
1CM	Rack-mount Kit	5063-9217
1CP	Rack-mount and Handle Kit	5063-9224

Table 3-3 **Contents of each option**

Option	Contents	Quantity
1CN	Front Handles	2
	Screws	6
	Trim Strips	2
1CM	Rack-mounting flanges (locking side plate)	2
	Screws	6
1CP	Rack-mounting flanges (locking side plate)	2
	Front Handles	2
	Screws	8

Figure 3-4

Installing front handle/rack-mount kits

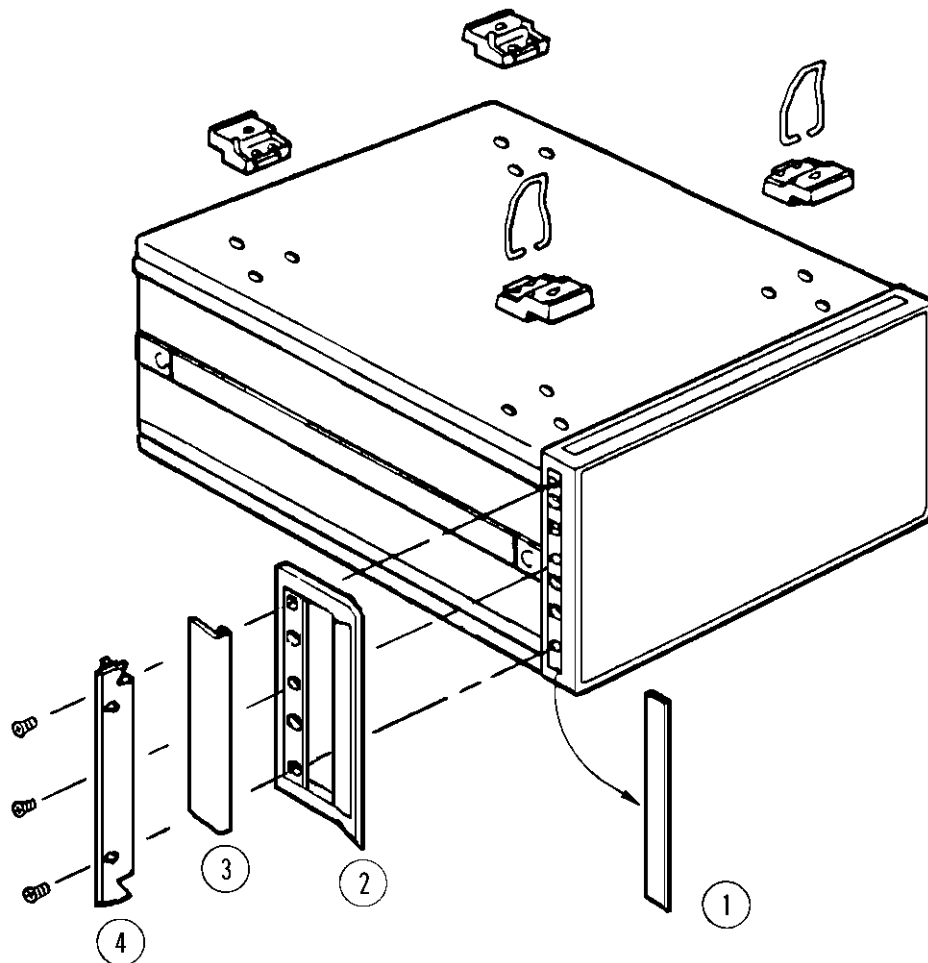

e5070aqj009

How to install the handle kit (Option 1CN)

The handle kit is used for transport and relocation of the E5052A. While referring to Figure 3-4, install the handle kit by following these steps.

- Step 1.** Remove the adhesive-backed trim strip (1) from each side of the outer frame of the E5052A front panel.
- Step 2.** Use the provided screws to mount the front handles (2) on each side of the E5052A front panel frame.
- Step 3.** Attach the provided modified trim strip (3) to each front handle in order to cover the front panel locking screws.

WARNING

If the installed front handle becomes damaged, replace it with a new one immediately. A damaged handle can break while moving or lifting the instrument and cause personal injury or damage to the instrument.

How to install the rack-mount kit (Option 1CM)

The rack-mount kit includes two flanges (locking side plates) for mounting the E5052A on a rack (482.6 mm/19 inches), conforming to the EIA Standard. While referring to Figure 3-4, install the rack-mount kit by following these steps.

- Step 1.** Remove the adhesive-backed trim strip (1) from each side of the outer frame of the E5052A front panel.
- Step 2.** Use the provided screws to mount a rack-mounting flange (4) on each side of the E5052A front panel frame.
- Step 3.** Remove the four bottom feet of the E5052A (lift the bar marked TAB on the inner side of the foot and slide the foot toward the bar).
- Step 4.** Mount the E5052A on the rack.

How to install the rack-mount and handle kit (Option 1CP)

The rack-mount and handle kit includes both the rack-mounting flanges (locking side plates) and front handles. While referring to Figure 3-4, install the rack-mount kit by following these steps.

- Step 1.** Remove the adhesive-backed trim strip (1) from each side of the outer frame of the E5052A front panel.
- Step 2.** Use the provided screws to mount a front handle (2) and rack-mounting flange (4) on each side of the E5052A front panel frame.

CAUTION

Be sure to use both the front handles and the rack-mounting flanges at the same time. Do not attempt to install flanges or handles separately with the hardware provided, since this risks serious electrical damage to the instrument.

- Step 3.** Remove the four bottom feet of the E5052A (lift the bar marked TAB on the inner side of the foot and slide the foot toward the bar).
- Step 4.** Mount the E5052A on the rack.

Connecting the Accessories

The E5052A allows you to connect a variety of accessories using the USB ports on the front panel or each of the ports on the rear panel.

Connecting the mouse and keyboard

As shown in Figure 3-5, connect the mouse and keyboard to the mini-DIN mouse port and mini-DIN keyboard port, respectively, before turning ON the power.

Figure 3-5

Connecting mouse and keyboard

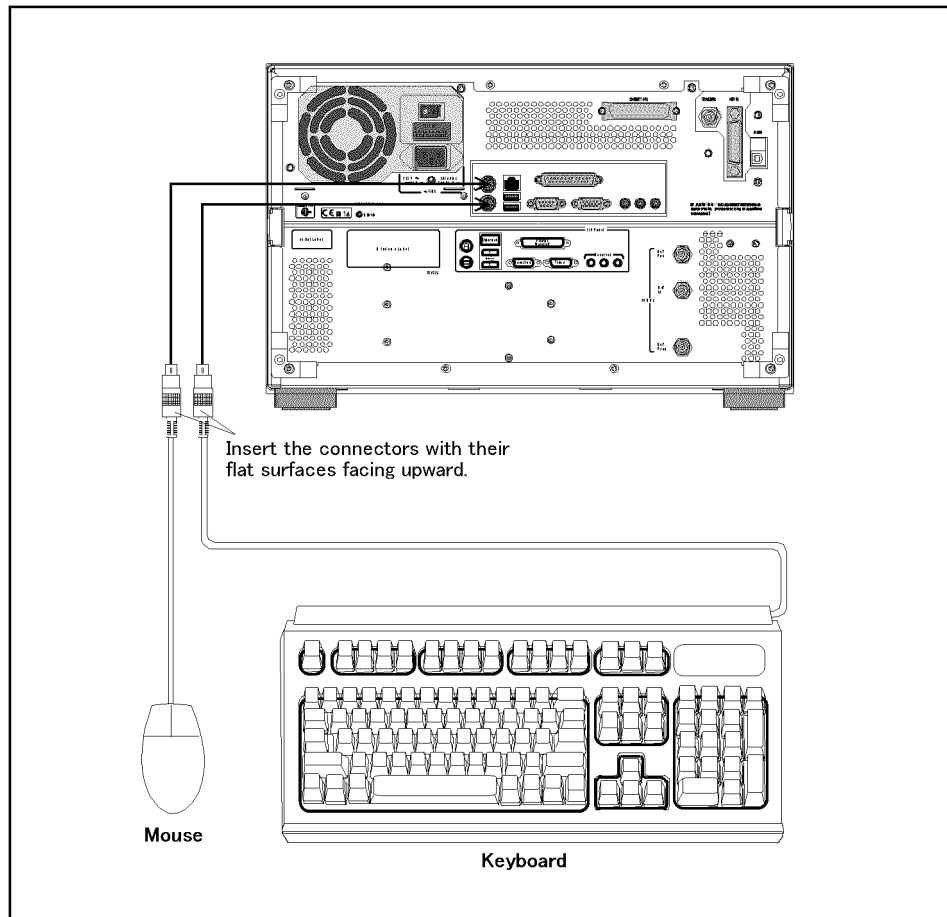

e5052aue4002

Connecting a LAN cable

When using a LAN (local area network), follow the procedure below to connect the E5052A to the LAN.

- Step 1.** By referring to the Chapter 8, “Setting and Using the Control and Management Functions,” on page 267, set up the E5052A LAN.
- Step 2.** As shown in Figure 3-6, connect a LAN cable to the LAN port on the rear panel of the E5052A.

Figure 3-6

Connecting LAN cable

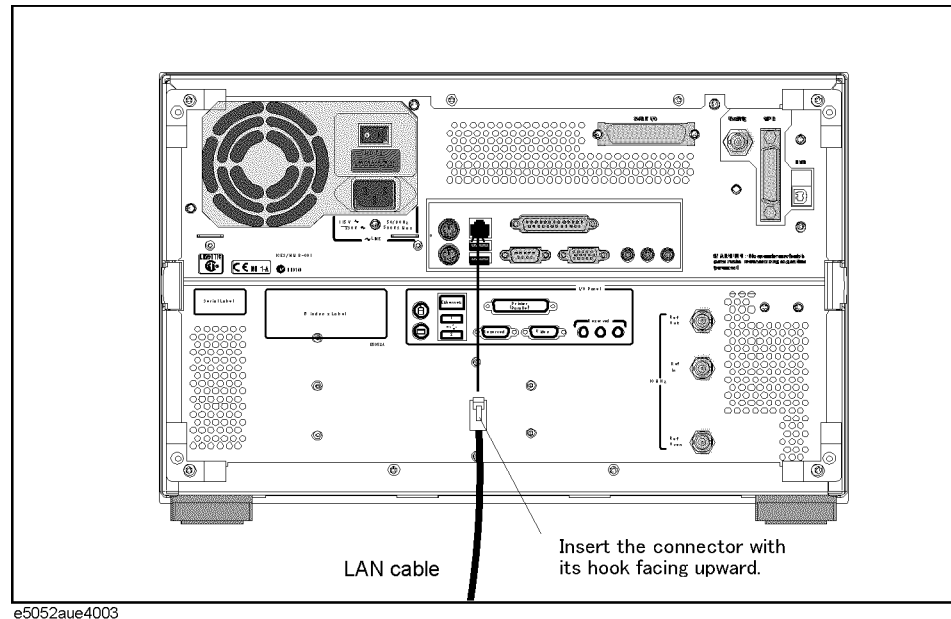

e5052aue4003

NOTE

When connecting the E5052A to a LAN for use, consult the network administrator about the proper LAN settings.

Do not connect a LAN cable until the proper LAN settings have been made. Connecting the E5052A to a LAN with improper settings may cause a problem in the network.

Connecting a printer

When using a compatible printer, connect it to the printer parallel port or USB (Universal Serial Bus) port on the rear panel of the E5052A as shown in Figure 3-7.

For a list of printers that work with the E5052A in its factory-shipped condition, see the Chapter 6, “Data Analysis and Result Output.”

Figure 3-7

Connecting a printer

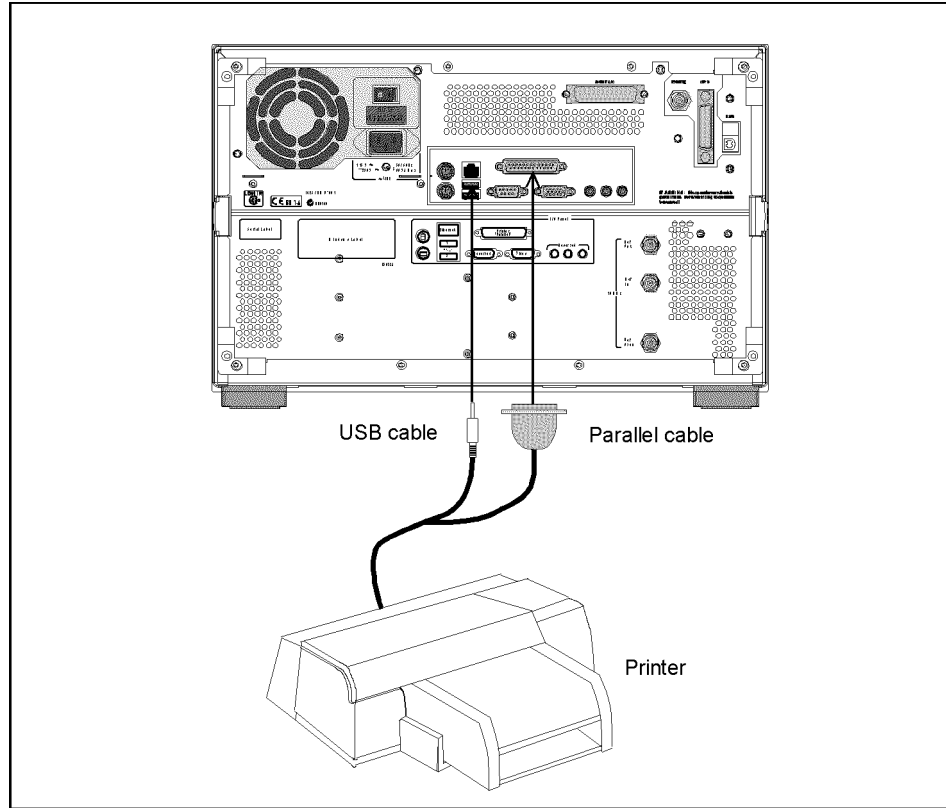

e5052aue4004

Power Supply and Blown Fuses

Before turning on the E5052A power, check the following important items.

Verification of the power supply

Confirm that the power supplied to the E5052A meets the following requirements:

	Requirement
Voltage	90 to 132 VAC or 198 to 264 VAC *1
Frequency	47 to 63 Hz
Maximum power consumption	500 VA

*1. Switched automatically by the E5052A in conformity to the voltage used.

Verification and connection of power cable

The three-wire power cable attached to the E5052A has one wire serving as a ground. Using this power cable allows the E5052A to be grounded, thereby protecting you against electrical shock from the power outlet.

Step 1. Confirm that the power cable is not damaged.

WARNING NEVER use a power cable showing any sign of damage. Faulty cables can cause electrical shock.



Step 2. Use the supplied cable to connect between the power cable receptacle (Figure 3-9 on page 69) on the rear panel of the E5052A and a three-wire power outlet, with the grounding prong firmly connected in the ground slot.

WARNING Use the supplied power cable with grounding wire to securely ground the E5052A.

Figure 3-8 shows the power cable options.

Installation
Power Supply and Blown Fuses

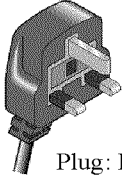
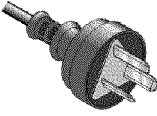
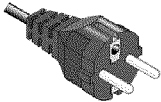
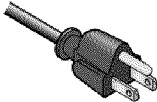
Figure 3-8 Power cable options

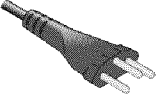
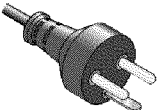
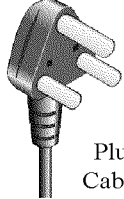
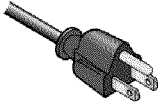
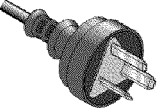
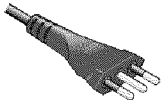
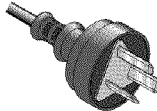
<p>OPTION 900</p>  <p>United Kingdom</p> <p>Plug: BS 1363/A, 250V, 10A Cable: 8120-1351, 8120-8705</p>	<p>OPTION 901</p>  <p>Australia/New Zealand</p> <p>Plug: AS 3112, 250V, 10A Cable: 8120-1369</p>
<p>OPTION 902</p>  <p>Continental Europe</p> <p>Plug: CEE 7 Standard Sheet VII, 250V, 10A Cable: 8120-1689</p>	<p>OPTION 903</p>  <p>U.S./Canada</p> <p>Plug: NEMA 5-15P, 125V, 10A Cable: 8120-1378</p>
<p>OPTION 904</p>  <p>U.S./Canada</p> <p>Plug: NEMA 6-15P, 250V, 6A Cable: 8120-0698</p>	<p>OPTION 906</p>  <p>Switzerland</p> <p>Plug: SEV Type 12, 250V, 10A Cable: 8120-2104</p>
<p>OPTION 912</p>  <p>Denmark</p> <p>Plug: SR 107-2-D, 250V, 10A Cable: 8120-2956</p>	<p>OPTION 917</p>  <p>India/Republic of S. Africa</p> <p>Plug: IEC 83-B1, 250V, 10A Cable: 8120-4211</p>
<p>OPTION 918</p>  <p>Japan</p> <p>Plug: JIS C 8303, 125V, 12A Cable: 8120-4753</p>	<p>OPTION 920</p>  <p>Argentina</p> <p>Plug: Argentine Resolution 63, Annex IV, 250V, 10A Cable: 8120-6870</p>
<p>OPTION 921</p>  <p>Chile</p> <p>Plug: CEI 23-16, 250V, 10A Cable: 8120-6978</p>	<p>OPTION 922</p>  <p>China</p> <p>Plug: GB 1002, 250V, 10A Cable: 8120-8376</p>

NOTE: Each option number includes a 'family' of cords and connectors of various materials and plug body configurations (straight, 90° etc.).

power_e

Blown fuses

If the fuse appears to have blown during operation, this instrument may be subject to failure and must be repaired. Ship the E5052A to the nearest Agilent Technologies Service Center according to the section on “Considerations When Shipping to a Service Center Due to Breakdown or Other Problems” on page 76

The product uses the following fuse type: UL/CSA Type, Slow-Blo, 8 A-250 V.

WARNING

Do NOT replace the fuse yourself; doing this may expose you to dangerous electrical shock.



Starting the E5052A

This section explains how to turn on/off the E5052A power, how to cut off the power supply in an emergency, and how to set the internal clock.

Turning the Power ON and OFF

Perform the following steps to turn the power ON or OFF.

Turning the Power ON

Step 1. If the standby switch () in the lower-left part of the front panel is in the depressed () position, press it to put it in the popped-up position ().

Step 2. Press the standby switch to put it in the depressed position ().



This operation turns ON the power, and the E5052A starts the self-test.

Step 3. Confirm that the self-test indicates normal operation.

Normal operation is confirmed by the self-test if no error message appears.

Turning the Power OFF

Step 1. Use either of the following methods to turn the power OFF.

- Press the standby switch () in the lower-left part of the front panel (now in the depressed () position) to put it in the popped-up () position.
- Send the shutdown command from an external controller.

These operations will start the E5052A shutdown process (required software and hardware processes for turning the power off), and the power will turn OFF after a few seconds.

NOTE

Under normal circumstances, always press the standby switch (), or send the shutdown command from an external controller, to execute the E5052A shutdown process. **Never cut off the power supply directly by disconnecting the power cable plug from the rear panel of the unit.**

If the power supply is cut off directly by disconnecting the power cable plug from the instrument or the AC outlet, the shutdown process is not carried out and there is a risk of damage to the E5052A's software or hardware.

Figure 3-9 Line switch (Always ON) and power cable receptacle

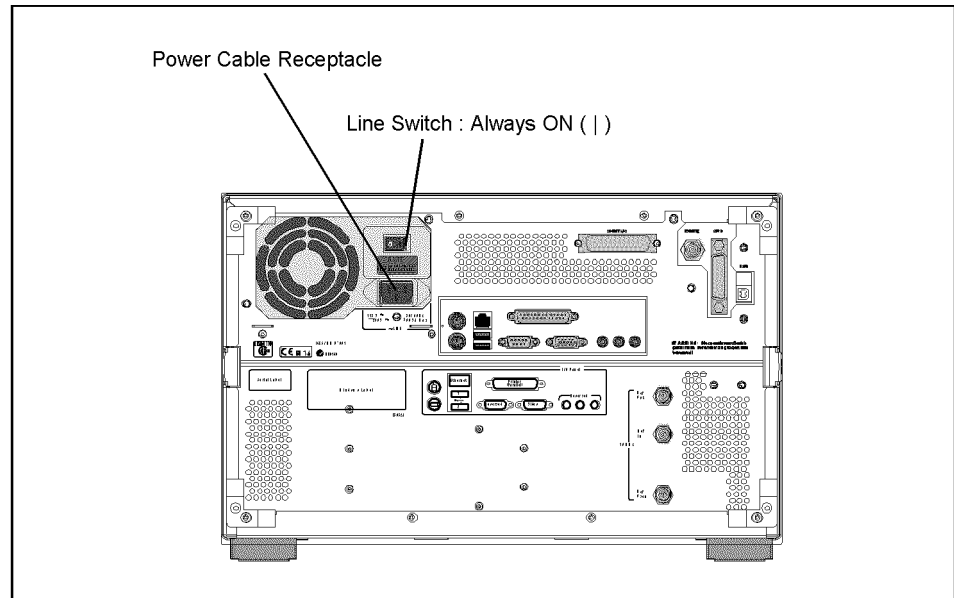

e5052aue4005

Disconnection from supply source

The power supply of the E5052A is cut off by disconnecting the plug of the power cable (on either AC outlet side or E5052A side). When it is necessary to disconnect the power supply in order to avoid shock hazards, etc., pull out the power cable plug from either the AC outlet side or the E5052A side.

NOTE

To allow this to be done smoothly, be sure to follow the guidelines in “Ensuring adequate free space around analyzer for immediate disconnection of power cable in case of emergency” on page 58.

When turning the power OFF under normal circumstances, always follow the methods described in “Turning the Power OFF” on page 68.

Initial Registration of E5052A

When you start up the E5052A for the first time or after executing system recovery, you need to perform the initial registration of the Windows 2000 operating system used in the E5052A.

NOTE You cannot use the front panel keys during the initial registration of the E5052A, so be sure to connect the mouse and keyboard before turning on the power.

NOTE If you perform the following procedure incorrectly, a message appears asking whether to return to the previous registration screen and perform the registration again. In this case, follow the instruction to return to the previous registration screen.

Step 1. Turns on the E5052A.

Step 2. The Windows 2000 Professional Setup Wizard appears. Click the **Next >** button (Figure 3-10).

Figure 3-10 Windows 2000 Professional Setup Wizard



Step 3. In the Windows 2000 Professional Setup dialog box, select the **I accept this agreement** box and click the **Next >** button (Figure 3-11). Then, the Windows 2000 operating system restarts automatically.

Figure 3-11 Windows 2000 Professional Setup dialog box

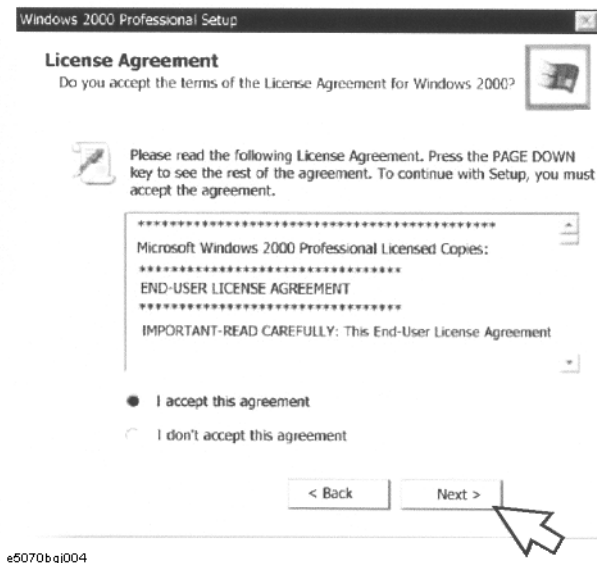

Step 4. The Network Identification Wizard appears. Click the **Next >** button (Figure 3-12).

Figure 3-12 Network Identification Wizard

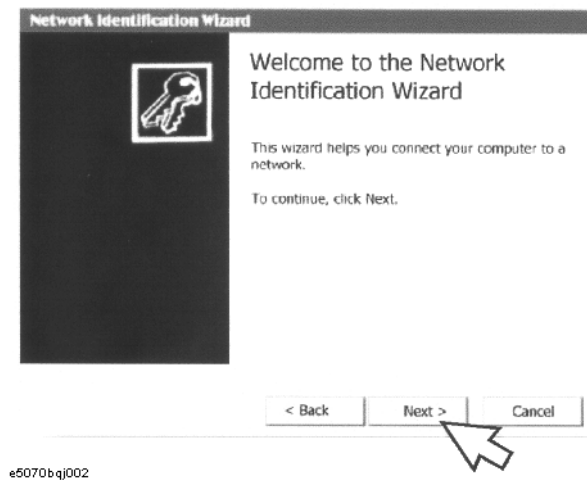

3. Installation

Installation
Initial Registration of E5052A

Step 5. In the Network Identification Wizard dialog box (1/2), select the **Windows always assumes the following user has logged on to this computer** box and check that **E5052** is in the **User Name** box. If not, type in **E5052**. Then type in **E5052** both in **Password box** and **Confirm password box**. Click the **Next>** button (Figure 3-13).

Figure 3-13 Network Identification Wizard dialog box (1/2)

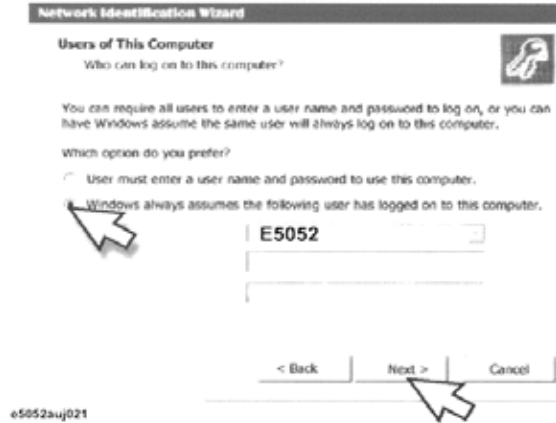

Step 6. In the Network Identification Wizard dialog box (2/2), click the **Finish** button to finish the initial registration of the E5052A (Figure 3-14). Then, the measurement display of the E5052A appears.

Figure 3-14 Network Identification Wizard dialog box (2/2)

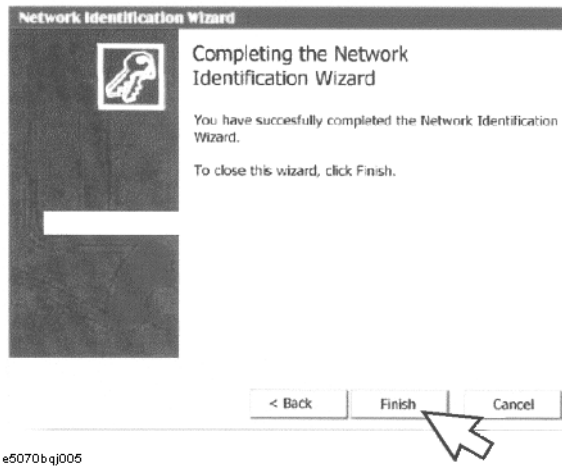

Setting the Internal Clock

You can set the date/time displayed at the lower right of the screen. When you save data in the storage unit, for example, the settings of the internal clock will be used for the saved file's information. The following describes the setting procedure by using the keys on the front panel.

NOTE

After turning on the instrument's power for the first time after delivery, be sure to set the internal clock.

Setting the Date/Time

- Step 1.** Press the [System] key in the INSTR STATE block. Press the [↓] or [↑] key to move the focus to the Misc Setup button and then press the [Enter] or [→] key. Press the [↓] or [↑] key to move the focus to the Clock Setup button and then press the [Enter] or [→] key. Place the focus on the Set Date and Time button and press the [Enter] key. The Date/Time Properties dialog box will appear (Figure 3-15).

Figure 3-15

Date/Time Properties dialog box ("Date & Time" tab)

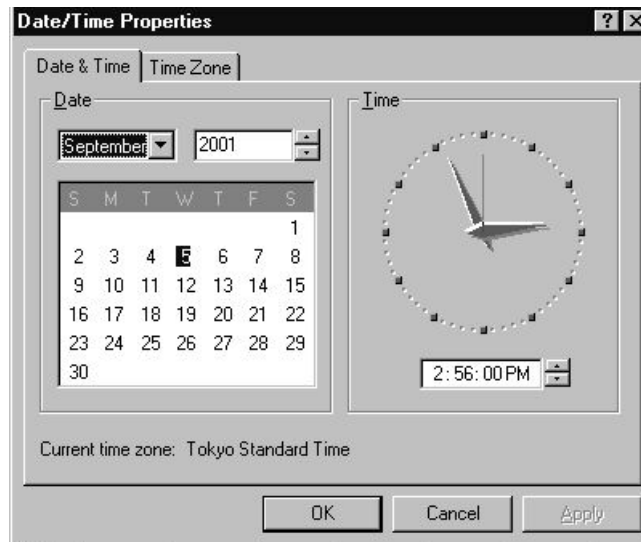

- Step 2.** Turn the rotary knob (⊙) on the front panel to place the focus on the **Date & Time** tab and then press the [→] key to move the focus to the **Time Zone** tab (Figure 3-16).

Figure 3-16 Date/Time Properties dialog box (“Time Zone” tab)



e5070aqi005

- Step 3.** Turn the rotary knob (⊙) on the front panel to place the focus on the **Time Zone** box and press the [←]/[→] or [↓]/[↑] key to select the time zone.

NOTE

When you select a time zone having daylight savings time (‘summer time’), the **Automatically adjust clock for daylight saving changes** box becomes selectable. To set automatic adjustment to daylight savings time to ON, turn the rotary knob (⊙) to place the focus on the **Automatically adjust clock for daylight saving changes** box and press the rotary knob (⊙) to display the √ mark (Figure 3-16).

- Step 4.** Turn the rotary knob (⊙) on the front panel to place the focus on the **Time Zone** tab and press the [←] key to move the focus to the **Date & Time** tab.
- Step 5.** By referring to Figure 3-15, turn the rotary knob (⊙) on the front panel to place the focus on the desired item. Press the [←]/[→] or [↓]/[↑] keys to set each item.
- Step 6.** Turn the rotary knob (⊙) on the front panel to place the focus on the **OK** button and then press the [Enter] key.

Turning the Date/Time display ON and OFF

The Date/Time is displayed within the instrument status bar at the lower right of the display screen.

- Step 1.** Press the [System] key in the INSTR STATE block. Press the [↓] or [↑] key to move the focus to the **Misc Setup** button and then press the [Enter] or [→] key. Press the [↓] or [↑] key, move the focus to the **Clock Setup** button, and press the [Enter] or [→] key. Place the focus on the **Show Clock** button and press the [Enter] key to set the date/time display to on/off.

Daily Maintenance

This section provides the maintenance information for the E5052A and describes the self-test function, which checks the instrument for failure. This section also provides information required for shipping the E5052A due to breakdown or other problems.

Cleaning method

To clean the surface of the E5052A, wipe the surface gently with a dry cloth or soft cloth dampened with water and wrung dry. Never attempt to clean the inside of the instrument.

WARNING To avoid electric shock, always disconnect the power cord of the E5052A from the power outlet when cleaning.

NOTE To clean a touch-screen LCD, do not wet the cloth with water.

Occasionally, a few pixels may appear on the screen as a fixed point of blue, green or red. Please note that this is not a failure and does not affect the performance of your product.

Maintaining connectors/ports on test port (DUT interface)

Each port on the front panel of the E5052A has an N-type connector (female) and a BNC connector (female). In the RF band, soil or damage on the connector or cable will affect the measurements. The following describes how to handle and maintain these N-type connectors and BNC connectors.

- The connectors should always be kept clean and away from dirt.
- To prevent electrostatic discharge (ESD), do not touch the contact face of the connector.
- Never attempt to use a damaged or nicked connector.
- When cleaning, blow air onto the connector. Never attempt to use abrasives such as emery paper.

NOTE The RF port on the front panel of the E5052A is a 50 Ω -based N-type connector (female). Note that connecting a connector with different impedance can damage the connectors.

Self-test When Turning on the Power

When the power is turned on, the E5052A automatically performs a self-test. If any error is detected by the self-test at power-on, the error message “Power on test fail” appears in the instrument status bar. This causes the E5052A to enter the service mode. If your E5052A is in the service mode, ship it to the nearest Agilent Technologies Service Center by referring to the section on “Considerations When Shipping to a Service Center Due to Breakdown or Other Problems” on page 76.

Considerations When Shipping to a Service Center Due to Breakdown or Other Problems

When shipping the E5052A to an Agilent Technologies Service Center because of breakdown or other problems, for re-shipment use the packing box and shock-absorbing material used to package the analyzer, or static-protective package in place of them. To find your nearest Agilent Technologies Service Center, contact the Agilent Technologies Customer Center displayed at the end of the Manual.

NOTE

Occasionally, a few pixels may appear on the screen as a fixed point of blue, green or red. Please note that this is not a failure and does not affect the performance of your product.

4

Basic Measurement Using E5052A

This chapter describes the basic measurement procedures of the DUT using the E5052A. The description is mainly based on the manual measurement method.

The E5052A has a measurement screen for each measurement target; and the target you can measure may vary depending on the screen. Select measurement screens according to your intended use.

Frequency/Power Measurement in Frequency/Power Measurement Mode

Overview of frequency/power measurement

For frequency/power measurements, the E5052A measures the corresponding frequency, power and power supply DC current by sweeping the specified range of the DC control/power given to the DUT.

The E5052A's frequency/power measurement window has three measurement trace screens: RF power measurement trace, frequency measurement trace, and power supply DC current measurement trace. By using the individual trace screen, you can measure RF power, frequency and power supply DC current corresponding to the DC control/power of the DUT.

The following sections explain how to use the E5052A to make these basic measurements.

About analyzer mode and tester mode

The frequency/power measurement has two modes: analyzer mode, which analyzes input signals for a specific range swept by DC voltage (DC control voltage or DC power voltage), and tester mode, which performs measurement on the spot without DC voltage sweeping.

In the analyzer mode, an individual change in frequency, RF power or power supply DC current of the input signals for a specified range of DC voltage will be shown in a graph and analyzed by using the marker or analysis function.

In the tester mode, the frequency, RF power or power supply DC current of the input signals will be measured on the spot as if each was measured with dedicated single power meter, frequency counter, and DC current meter. You can confirm each numeric value by viewing the screen, however in this mode you cannot observe an exact change of the signals in response to DC voltage sweeping.

Analyzer mode is not available when option 011 is installed.

Selecting Analyzer Mode or Tester Mode

- Step 1.** You can select either analyzer mode or tester mode by pressing the **Trigger**-**Mode** key. Analyzer mode is selected by default.

The basic settings and their examples described in the following sections assume signal analysis using the analyzer mode.

NOTE

When option 011 is installed, switching analyzer mode and tester mode is not available; only tester mode is supported.

Figure 4-1 Example of Tester Mode Screen



Setting Trace Layout

In frequency/power measurement mode, four traces will be displayed at the same time. The four traces consist of two traces in frequency measurement (the unit is Hz and Hz/V), a trace in RF power measurement (the unit is dBm) and a trace in power supply DC current measurement (the unit is mA).

You can select the trace layout from three- or four-division mode. In each trace layout, data will be assigned as Figure 4-2, “Trace Layout.” In the four-division mode, the upper-left trace is frequency in Hz unit and the lower-right trace is frequency in Hz/V unit. Refer to “Setting Frequency Format and Sensitivity Aperture” on page 94 for selecting the unit (data format).

Step 1. Press **[Display]-Allocate** key.

Step 2. Press the desired softkey to select the trace layout.

Figure 4-2 Trace Layout

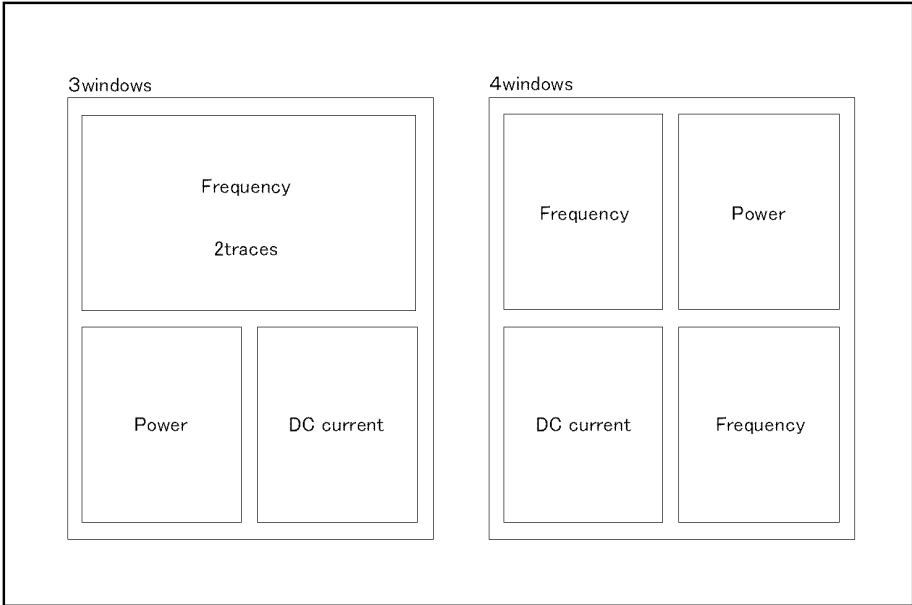

e5052aue3003

Common settings in RF power, frequency and power supply DC current measurement

The following section describes the common setting steps to measure RF power, frequency and power supply DC current corresponding to the DUT's DC control/power by using the E5052A's frequency/power measurement window.

Selecting Measurement Window

Step 1. Press **Meas/View** - **Freq & Power** to select the frequency/power measurement window.

NOTE

You can maximize the frequency/power measurement window by pressing **Window Max** key while the window is selected. You can bring up the original size when you press the **Window Max** key once again.

You can select the next trace by pressing the **Trace Next** key and maximize the target trace by pressing the **Trace Max** key. The frequency/power window will come back when you press the **Trace Max** key once again.

Setting Downconverter and External mixer

Follow these steps to make the setting when using the E5053A Microwave Downconverter.

Step 1. Press **Input** - **Downconverter**.

Step 2. Press **Downconverter** to toggle on/off.

Step 3. If the downconverter is on, press **RF Input - Downconverter | E5052A Direct** to select an RF input source.

Step 4. If the downconverter is on and the RF input is set to Downconverter, press **External Mixer - Not Used | ON** to select whether to use the external mixer.

NOTE

For more information on the settings of the E5053A Microwave Downconverter, see Chapter 5, "Measurement Using E5053A and External Mixer."

The settings when using the downconverter and the external mixer include:

- Setting of LO frequency and power
- Setting of DC bias current (CH1, CH2)
- Setting of IF gain inside downconverter
- Setting of downconverter Δ IF frequency

Procedure to Select Carrier Frequency Band

Step 1. Press **Setup** - **Frequency Band**.

Step 2. Select a frequency band that contains the carrier signal to be measured from the softkey menu list. The ranges of the frequency bands are shown below.

Note that, for analyzer mode, select a frequency band that contains the frequency of the sweep start position.

NOTE Selectable frequency bands differ depending on whether the E5053A Microwave Downconverter is used and whether the RF input is direct input or downconverter input.

Table 4-1 Selecting Carrier Frequency Band (When E5052A is Used Standalone or with Downconverter is Off)

Carrier frequency band
10 M to 1.5 GHz
300 M to 7 GHz

Table 4-2 Selecting Carrier Frequency Band (When Downconverter is On and RF Input Set to 'E5052A Direct')

Carrier frequency band
10 M to 1.5 GHz
300 M to 3 GHz

Table 4-3 Selecting Carrier Frequency Band (When Downconverter is On and RF Input Set to 'Downconverter')

Carrier frequency band
3 G to 10 GHz
9 G to 26.5 GHz

Specifying Nominal Frequency

When the downconverter setting is turned on, the RF input setting is Downconverter, and the external mixer setting is Not Used, enter the nominal value of the carrier frequency to detect the carrier signal.

Note that, for analyzer mode, set the frequency of the sweep start position as the nominal frequency.

- Step 1.** Press - **Nominal Frequency**.
- Step 2.** Enter the value of the nominal frequency in the data entry field displayed in the upper part of the screen.

NOTE When using the downconverter RF IN port, the Nominal Frequency setting range is limited to within the carrier frequency band, and the Nominal Frequency should be set to the actual input signal frequency.

In the tester mode, use the **Carrier Search** function to set the nominal frequency so as to the input signal frequency. See also "Executing Carrier Search Function" on page 96.

In the analyzer mode, the Nominal Frequency should be set to the initial frequency at the starting voltage of the built-in DC source (either control voltage or power voltage).

Frequency/Power Measurement in Frequency/Power Measurement Mode

Specifying Maximum Input Level

When the downconverter is turned on, the RF input is set to Downconverter, and the external mixer is set to Not Used, set the maximum input level value of the measurement signal supplied from the input port of the E5053A Microwave Downconverter.

The maximum input level is set to determine the IF gain of the E5053A Microwave Downconverter.

- Step 1.** Press **Setup** - **Max Input Level**.
- Step 2.** Enter the value of the maximum input level in the data entry field displayed in the upper part of the screen.

NOTE

In no cases other than when the downconverter is turned on, the RF input is set to Downconverter, and the external mixer is set to Not Used, you can set the maximum input level.

Specifying Sweep Range

- Step 1.** Press **Setup** - **Sweep Parameter**.
- Step 2.** Selecting from the softkey menu list, you can define a sweep operation to be performed for either DC control or DC power. Select **Control Voltage** for DC control and **Power Voltage** for DC power.
- Step 3.** Press **Start/Center** (**Stop/Span**) - **DC Control(Power)Start**.
- Step 4.** Enter the sweep start value in the data entry field that appears in the upper part of the screen.
- Step 5.** Press **Start/Center** (**Stop/Span**) - **DC Control(Power)Stop**.
- Step 6.** Enter the sweep stop value in the data entry field that appears in the upper part of the screen.

NOTE

Otherwise, press **Start/Center** (**Stop/Span**) - **DC Control(Power)Center** to enter the sweep center value in the data entry field that appears in the upper part of the screen and then press **DC Control(Power) Span** to enter the sweep span value in the same way.

The same softkey will be displayed by pressing either **Start/Center** or **Stop/Span**. You can make the same settings by using either of the two keys.

Specifying Frequency Resolution, Number of Measurement Points and Delay

- Step 1.** Press **Setup** - **Freq Resolution**.
- Step 2.** Select the appropriate frequency resolution from the softkey menu list. The available

frequency resolutions are as follows:

Table 4-4

Frequency Resolution List

Frequency Resolution
10 Hz
1 kHz
64 kHz

Step 3. Press **Setup** - **Points**.

Step 4. Enter the number of measurement points in the data entry field that appears in the upper part of the screen.

Step 5. Press **Setup** - **Points Delay**.

Step 6. Enter the waiting time between each measurement in the data entry field that appears in the upper part of the screen.

About DC voltage setting and protection

You can specify the DC power/control that will be applied to the DUT. Refer to “Setting DC power/DC control and protection” on page 86 for the setting procedure.

About Auto Frequency Control Function

If this function is turned on, the E5052A will adjust the control voltage automatically so that the output signal frequency from the DUT may keep the specified value. For the setting procedure, refer to the “Auto Frequency Control Function” on page 88.

Setting Average Function

Follow the steps below to use the averaging function.

Step 1. Press **Avg/BW** - **Avg Factor**.

Step 2. Enter the number of times for averaging in the data entry field that appears in the upper part of the screen.

Step 3. Press **Avg/BW** - **Averaging** to turn on the averaging function.

Setting Trigger

Step 1. Press **Trigger** - **Source**.

Step 2. Select the trigger source from the softkey menu list. The available options are as follows. Internal is selected by default.

Table 4-5

Trigger Source List

Softkey	Overview
Internal	Sets trigger source to internal continuous trigger signal

Table 4-5 Trigger Source List

Softkey	Overview
External* ¹	Sets trigger source to external trigger input connector
Manual	Sets trigger source to manual operation
Bus	Sets trigger source to the bus; the trigger signal is issued by the trigger command via GPIB interface or LAN.

*1. If External is selected for the trigger source, the trigger signal must be provided by an external instrument. Refer to “Setting External Trigger” on page 137 for the setting procedure.

Step 3. Press **Trigger** - **Trigger to Freq & Power** to send a trigger to the frequency/power measurement. By default, **Continuous** is selected for sweep.

NOTE

The E5052A has four measurement functions: phase noise measurement, spectrum monitor measurement, frequency/power measurement, and transient measurement. Because individual measurements differ in their characteristics from one another, each of the E5052A’s trigger is used exclusively for a single measurement.

In other words, only one measurement function can be triggered at a time, and only it can perform measurement at that time.

Setting Averaging Trigger

Follow the steps below to use the averaging trigger.

Step 1. Press **Trigger** - **Average Trigger** to toggle on/off the averaging trigger.

When the averaging trigger is set to on, a single activation of the trigger system can perform the number of measurements set by the user as the averaging factor.

The following table shows how this function works by pressing **Trigger** - **Single** when the averaging trigger is on and off.

Averaging Trigger	Operation
ON	Executes state transitions among Waiting for Trigger, Trigger, and Measurement for the number of times set for averaging and then changes to the Hold state.
OFF	Enters Waiting for Trigger state once and then changes to the Hold state after measurement is completed.

NOTE

The averaging function (“Setting Average Function” on page 84) must be set before enabling the averaging trigger.

Setting DC power/DC control and protection

You can set the DC power or the DC control that is applied by the E5052A to the DUT not only to protect the DUT but also to perform stable measurements.

The E5052A allows you to set the maximum and minimum allowance levels of DC power/control that are applied to the DUT. This prevents excessive voltage from being applied to the DUT.

Follow the steps below to set the DC voltage for the DC control measurement.

Setting DC Power

- Step 1.** Press **DC Power** - **Max Pwr Voltage Limit**.
- Step 2.** Enter the maximum allowance voltage of DC power in the data entry field that appears in the upper part of the screen.
- Step 3.** Press **DC Power** - **Min Pwr Voltage Limit**.
- Step 4.** Enter the minimum allowance voltage of DC power in the data entry field that appears in the upper part of the screen.
- Step 5.** Press **DC Power** - **DC Power Delay**.
- Step 6.** Enter the waiting time to suppress DC power until the first measurement is finished in the data entry field that appears in the upper part of the screen.
- Step 7.** Press **DC Power** - **DC Power Voltage**.
- Step 8.** Enter DC power in the data entry field that appears in the upper part of the screen.

Setting DC Control

- Step 1.** Press **DC Control** - **Max Ctrl Voltage Limit**.
- Step 2.** Enter the maximum allowance voltage of DC control in the data entry field that appears in the upper part of the screen.
- Step 3.** Press **DC Control** - **Min Ctrl Voltage Limit**.
- Step 4.** Enter the minimum allowance voltage of DC control in the data entry field that appears in the upper part of the screen.
- Step 5.** Press **DC Control** - **DC Control Delay**.
- Step 6.** Enter the waiting time to suppress DC control until the first measurement is finished in the data entry field that appears in the upper part of the screen.
- Step 7.** Press **DC Control** - **DC Control Voltage**.
- Step 8.** Enter DC control in the data entry field that appears in the upper part of the screen.

Pressing **DC Control** - **Execute Control Voltage Cal** automatically turns on the DC control voltage calibration function. As necessary, press **DC Control** - **Control Voltage Cal** to turn on/off the DC control voltage calibration function.

NOTE

You must perform this calibration every time you power on the instrument, since the DC control calibration is cleared when the power is turned off.

Applying DC Power/DC Control to DUT

Step 1. Press **DC Power** - **DC Power Output** to turn on the DC power output.

Step 2. Press **DC Control** - **DC Control Output** to turn on the DC control output.

Auto Frequency Control Function

The automatic frequency control (AFC) function can quickly set and maintain the DUT output frequency to the target frequency you want. It does this by controlling the internal DC control voltage and using the measurement results obtained by its internal frequency counter. The DC control voltage has to be turned on to use the AFC function.

The AFC status appears in the lower right corner of the measurement screen. Each background color indicates the respective AFC function.

Blue	The function is enabled.
Grey	The function is disabled. Check if the DC Control Output is turned off.

NOTE

The AFC starts immediately before the measurement. During a single measurement, the DC control voltage is maintained. Therefore, the DC control voltage will not be changed even if the actual output frequency from the DUT drifts during the measurement.

Be sure to take this into consideration for the long time measurement, for example, by using the correlation function in the phase noise measurement.

When the external mixer is set to off, the auto frequency control function is not available.

Specifying Auto Frequency Control Function

Step 1. Press **DC Control** - **Auto Freq Control**.

Step 2. Press **Min Ctrl Voltage Limit**.

Step 3. Enter the minimum allowance voltage for DC control to be used for the Auto Frequency Control function, in the data entry field that appears in the upper part of the screen.

NOTE

Comparing the value entered here with the value specified in **Min Ctrl Voltage Limit** under the **DC Control** menu, the E5052A will choose a higher value to apply the limit.

Step 4. Press **Max Ctrl Voltage Limit**.

Step 5. Enter the maximum allowance voltage for DC control to be used for the Auto Frequency Control function, in the data entry field that appears in the upper part of the screen.

NOTE

Comparing the value entered here with the value specified in **Max Ctrl Voltage Limit** under the **DC Control** menu, the E5052A will choose a lower value to apply the limit.

Step 6. Press **Max Input Level**.

Step 7. Enter the maximum level value of the measurement signal that is supplied from the Input port of the E5053A Microwave Downconverter in the Auto Frequency Control function, in the data entry field that appears in the upper part of the screen.

NOTE

With no settings other than the downconverter is turned on, the RF input is set to Downconverter, and the external mixer is set to Not Used, setting maximum input level is available.

Step 8. Press **Frequency Band**.

Step 9. Select an appropriate frequency band that contains the target carrier signal, from the softkey menu list.

NOTE Selectable frequency bands differ depending on whether the E5053A Microwave Downconverter is used and whether the RF input is direct input or downconverter input.

Table 4-6 **Selecting Carrier Frequency Band (When E5052A is Used Standalone or with Downconverter is Off)**

Carrier frequency band
10 M to 1.5 GHz
300 M to 7 GHz

Table 4-7 **Selecting Carrier Frequency Band (When Downconverter is On and RF Input Set to 'E5052A Direct')**

Carrier frequency band
10 M to 1.5 GHz
300 M to 3 GHz

Table 4-8 **Selecting Carrier Frequency Band (When Downconverter is On and RF Input Set to 'Downconverter')**

Carrier frequency band
3 G to 10 GHz
9 G to 26.5 GHz

Step 10. Press **Target**.

Step 11. Enter the target frequency of the output from the DUT in the data entry field that appears in the upper part of the screen. The unit is [Hz].

NOTE In the analyzer mode, the frequency band is automatically altered so that the input signal frequency is within the band when the actual input frequency crosses the band.

Also the E5053A downconverter is automatically controlled to offset the downconverter LO frequency to track the input signal frequency within the IF frequency being fed to the E5052A. Note that the maximum frequency step between the two adjacent measurement points may be limited due to the IF frequency range. Increase the number of measurement points for the E5052A to detect the input signal frequency within the IF frequency, when “Downconverter IF not found” error message is found.

Step 12. Press **Tolerance**.

Step 13. Enter the tolerance (an allowable range of difference between the target frequency and the actual frequency output from the DUT) in the data entry field that appears in the upper part

Basic Measurement Using E5052A Frequency/Power Measurement in Frequency/Power Measurement Mode

of the screen. The unit is [Hz].

Step 14. Press **Sensitivity**.

Step 15. Enter an approximate control sensitivity of the DUT in the data entry field that appears in the upper part of the screen. The unit is [Hz/V].

Step 16. Press **Max Iteration**.

Step 17. Enter the maximum number of times to perform repetitive measurements and calculation (control -voltage setting loop) for determining the optimum control voltage, in the data entry field that appears in the upper part of the screen.

Step 18. Press **AFC Status**.

Step 19. Select the status of the Auto Frequency Control function from the softkey menu list.

OFF*1	The Auto Frequency Control will not be performed.
ON*1	The Auto Frequency Control will be performed prior to each sweep.
Immediate	The Auto Frequency Control will be performed only once. If the status is changed this during sweep, the sweep will be interrupted and Auto Frequency Control will be performed.

*1. Frequency/Power measurement mode in analyzer mode and Transient measurement mode doesn't have the ON/OFF status, but has the Immediate status only.

NOTE The Auto Frequency Control can not be aborted during an operation.

NOTE The wait time specified in **DC Control** - DC control Delay is also applied for repetitive measurements to obtain the optimum control voltage during the execution of the Auto Frequency Control function.

NOTE When the downconverter is turned on, the RF input is set to Downconverter, and the external mixer is set to Not Used, the operation differs depending on whether the **AFC Status** is **ON** or **Immediate**.

- When executed before each sweep with the **ON** setting
The auto frequency control function is executed assuming that the input signal frequency is near the target frequency (within several hundred MHz). If the input signal is not near the target frequency, the auto frequency control function fails.
- When executed with the **Immediate** setting
Because the auto frequency control function is executed after detecting the input signal by searching for inside the frequency band that is set first in the execution, the auto frequency control function can be executed provided that the input signal is within the frequency band even if it is not near the target frequency.
Note that, because the input signal search is performed first, the time required to complete the auto frequency control function is elongated compared to when it is executed before each sweep with the **AFC Status ON** setting.

About DC control voltage delay, DC power delay and point delay

This section describes the point delay for DC control delay, DC power delay, and common settings, which were mentioned in the previous sections. This is not a part of the setting procedures, so for more on settings you can skip this section and proceed to “Confirming Result of RF Power Measurement” on page 98.

About delay while DC control is selected for sweep parameter

The following section describes how to set up DC control delay and point delay. For better understanding of each delay, “a,” “b,” “c” and “e” and the measurement point “d” used in the description below, refer to Figure 4-3, “Delay While DC Control Selected for Sweep Parameter,”.

- “a” signifies the delay until measurement of the first point starts in the single sweep, or the delay until measurement of the first point of the first sweep in the continuous sweep. This delay is equal to the addition of the setting times of DC control delay and point delay.
- “b” signifies the individual delay between respective measurement points. The setting times of point delay is set as this delay.
- “c” signifies the time that elapses when the setting of the voltage (DC Control Stop) at the last measurement point (“d”) of the sweep is different from the setting value of DC Control Voltage. This time is required for generating the DC Control Voltage. It is not generated when the voltage setting of the DC Control Stop (Start/Center) (Stop/Span) - **DC Control Stop** and that of the DC Control Voltage (DC Control) - **DC Control Voltage** is same.
- “e” is signifies the time that elapses to set the voltage back to the starting voltage for next sweep in the continuous sweep. This time is required for setting of the DC Power Delay is completed.

Figure 4-3

Delay While DC Control Selected for Sweep Parameter

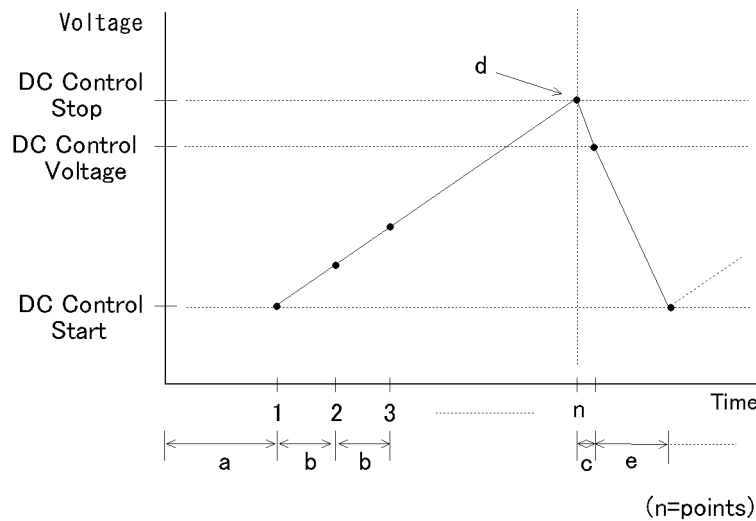

e5052aue4007

NOTE

If the output voltage falls 0 V or exceeds 20 V, the setting time of DC control delay will be

set as the delay, after the voltage is output.

About Delay While DC Power is Selected for Sweep Parameter

The following section describes how to set up DC power delay and point delay. For better understanding of each delay, “a,” “b,” “c” and “e” and the measurement point “d” used in the description, refer to Figure 4-4, “Delay While DC power is Selected for Sweep Parameter,”.

- “a” signifies the delay until measurement of the first point starts in the single sweep, or the delay until measurement of the first point of the first sweep in the continuous sweep. This delay is equal to the addition of the setting times of DC control delay and point delay.
- “b” signifies the individual delay between respective measurement points. The setting times of point delay is set as this delay.
- “c” signifies the time that elapses when the setting of the voltage (DC Control Stop) at the last measurement point (“d”) of the sweep is different from the setting value of DC Control Voltage. This time is required for generating the DC Control Voltage. It is not generated when the voltage setting of the DC Control Stop (**Start/Center** / **Stop/Span**) - **DC Control Stop**) and that of the DC Control Voltage (**DC Control** - **DC Control Voltage**) is same.
- “e” signifies the time that elapses to set the voltage back to the starting voltage for next sweep in the continuous sweep. This time is required for setting of the DC Power Delay is completed.

Figure 4-4

Delay While DC power is Selected for Sweep Parameter

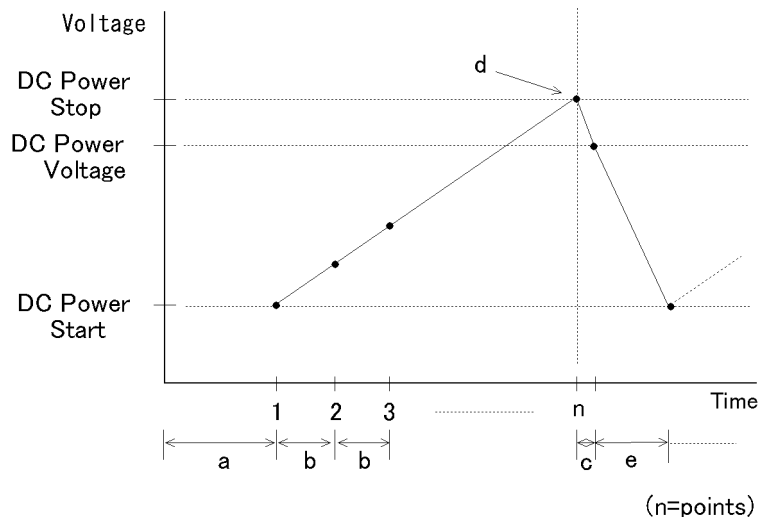

e5052aue4008

About Delay in Tester Mode

In the tester mode, measurement is made for only one measurement point. The delay for the measurement point can be set by using a point delay setting. Refer to Figure 4-5, “Delay in Tester Mode,”.

Figure 4-5

Delay in Tester Mode

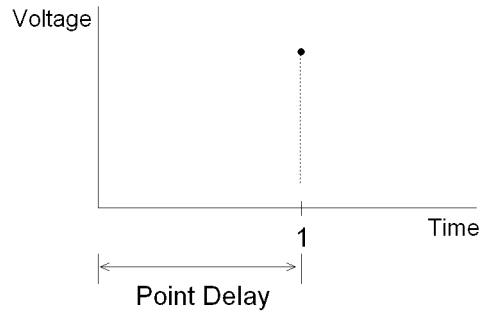

e5052aue017

Confirming Result of Frequency Measurement

The following section describes the procedure used to confirm the measurement results of frequencies corresponding to the DUT's DC control/power by using the E5052A's frequency/power measurement window.

Selecting Trace

Step 1. Press the **Trace Next** key to select the frequency measurement trace.

NOTE If you want to maximize the screen, press the **Trace Max** key.

Setting Frequency Format and Sensitivity Aperture

You can select the unit (frequency format) used in the frequency trace screen and set the sensitivity aperture.

Step 1. Press **Format** - **Frequency Format**.

Step 2. Select an appropriate frequency format from the softkey menu list. The available options are as follows.

Table 4-9

Format List

Softkey	Overview
Hz	Displays the measurement frequency data.
Hz/V	Displays the data obtained from measurement frequency differentiated by the DC control voltage.
ΔHz	Displays the difference subtracted from the reference frequency.
%	Displays the difference subtracted from the reference frequency in per cent.
ppm	Displays the difference subtracted from the reference frequency in ppm.

Step 3. Press **Format** - **Sensitivity Aperture**. (This setting will be used when “Hz/V” is selected for the frequency format.)

Step 4. Enter the sensitivity aperture value in the data entry field that appears in the upper part of the screen. The unit is %.

Step 5. Press **Format** - **Frequency Reference**. (This setting will be used when either “ΔHz”, “%”, “ppm” is selected for the frequency format.)

Step 6. Enter the frequency reference value in the data entry field that appears in the upper part of the screen. The unit is Hz.

Setting Scale of Measurement Trace (manual setting)

Follow the steps below to set the scale of the measurement trace manually.

Step 1. Press **Scale** - **Divisions**.

Frequency/Power Measurement in Frequency/Power Measurement Mode

- Step 2.** Enter the number of divisions by scale for the y-axis in the data entry field that appears in the upper part of the screen.
- Step 3.** Press **[Display]** - **Y # of Digits**.
- Step 4.** Select the number of digits for Y-axis in the softkey menu. Available options are 4-digits, 8-digits, and 12-digits.

NOTE

Set the number of digits for Y-axis display for each measurement mode. Therefore, when the number of digits for Y-axis is changed in the frequency measurement, those for the RF power measurement and the power supply DC current measurement are also changed.

- Step 5.** Press **[Scale]** - **Reference Position**.
- Step 6.** Enter the position of the scale reference line in the data entry field that appears in the upper part of the screen.
- The position of the scale reference line must be specified by any of the numbers assigned to the y-axis scale, from 0 (minimum scale) to the number of divisions (max scale).
- Step 7.** Press **[Scale]** - **Reference Value**.
- Step 8.** Enter the value of the scale reference line in the data entry field that appears in the upper part of the screen. The unit varies depending on the frequency format setting.
- Step 9.** Press **[Scale]** - **Scale/Div**.
- Step 10.** Enter the value per scale in the data entry field that appears in the upper part of the screen. The unit varies depending on the frequency format setting.

Setting Scale of Measurement Trace (automatic setting)

Follow the steps below to set the scale of measurement trace automatically.

- Step 1.** Press **[Scale]** - **Auto Scale**.

NOTE

If you want the scale setting to be performed automatically for all three measurement traces (RF power, frequency and power supply DC current), press **[Scale]** - **Auto Scale All**.

Setting Trace Offset (manual setting)

You can add an offset value to the displayed trace by following the steps below.

- Step 1.** Press **[Format]** - **Offset**
- Step 2.** Enter the offset value to be added to the trace in the data entry field that appears in the upper part of the screen. The unit varies depending on the setting of the frequency format.

Setting Trace Offset (Y-axis marker setting)

When the marker is displayed, the value of the active marker is used as the offset value. This procedure is carried out as follows.

- Step 1.** Move the active marker to the position of the measurement value that you want to set as the reference.

Step 2. Press **Format** - **Marker** -> **-Offset**

NOTE

Even when the reference marker mode is on and the active marker displays a Δ value, the value of the active marker is used as the offset value.

When the offset value has already been set, that value is overwritten.

When an active marker does not exist, this function is not available.

Setting X-axis Scale (manual setting)

Follow the steps below to set the maximum/minimum display values of the x-axis. This is used when you want to enlarge a part of the displayed trace.

Step 1. Press **Scale** - **X axis** - **Auto** to turn off the auto adjustment of the x-axis scale.

Step 2. Press **Scale** - **X axis** - **Left**

Step 3. Enter the display start value of the x-axis in the data entry field that appears in the upper part of the screen. V is used as a unit

Step 4. Press **Scale** - **X axis** - **Right**

Step 5. Enter the display stop value of the x-axis in the data entry field that appears in the upper part of the screen. V is used as a unit

NOTE

When you want to restore the display's original start/stop values, press **Scale** - **X axis** - **Auto** to turn on the auto adjustment of the x-axis scale.

X-axis Scale Setting Procedure (x-axis band marker setting)

When the band marker of the x-axis is displayed, the x-axis scale can be adjusted to the band marker setting. The procedure is as follows.

Step 1. Press **Scale** - **X axis** - **Band Marker** -> **X Axis**

Setting Attenuator

When an input level is very high, a message may appear to prompt you to adjust the attenuator. In this case, follow the steps below to adjust the attenuator.

Step 1. Press **Attn** - **Input Attenuator** to enter the attenuator value in the data entry field that appears in the upper part of the screen.

You can select the value from the options: 0 dB, 5 dB, 10 dB, 15 dB, 20 dB, 25 dB, 30 dB or 35 dB. The appropriate input level is between 0 and 5 dBm, depending on the type of measurement or the characteristics of the DUT. Adjust the attenuator so that the input level of the RF port may approximate this range.

NOTE

When the downconverter is turned on, the RF input is set to Downconverter, and the external mixer is set to Not Used, the attenuator value is fixed to 10 dB.

Executing Carrier Search Function

The carrier search function is to detect the input signal frequency with the selected carrier

frequency band for the downconverter RF IN (i.e. 3 to 10 GHz or 9 to 26.5 GHz) and reflect the result to the nominal frequency.

- Step 1. Press **Setup**.
- Step 2. Press **Carrier Search** to execute the carrier signal search.
- Step 3. The detected signal frequency is reflected on the nominal frequency.

Setting Smoothing

You can use the smoothing function to reduce the trace noise. Follow the steps below.

- Step 1. Press **Trace/View** - **Aperture**.
- Step 2. Enter the value of the smoothing aperture (%) in the data entry field that appears in the upper part of the screen.
- Step 3. Press **Trace/View** - **Smoothing** to turn on the smoothing function.

Confirming Measurement Points by Markers

- Step 1. Press **Marker** to display marker 1 on the screen.
- Step 2. Move marker 1 to the point you want to confirm and read the measurement value displayed in the upper part of the graph. To confirm multiple values, press **Marker** - **Marker x (x=1 to 10)**, which allows you to display up to marker 10.

Figure 4-6

Example of Measurement Screen (frequency characteristics)

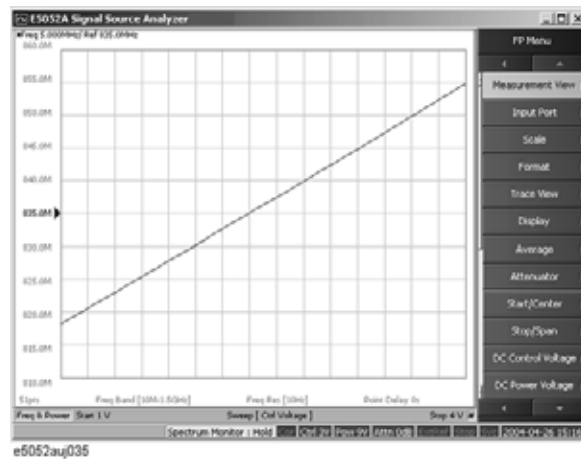

NOTE

By taking into account the transient of DC control/power prior to the sweep, the instrument will start the sweep after the time specified in **DC Control**(**DC Power**) **Voltage - DC Control(Power) Delay** has elapsed. This delay time is not included in the sweep time, and it only applies to the first measurement point.

Confirming Result of RF Power Measurement

The following section describes the procedure to confirm the measurement results of RF power corresponding to the DUT's DC control/power by using the E5052A's frequency/power measurement window.

NOTE Measurement display indicates a measured value obtained with the power meter if the downconverter is turned off, otherwise a measurement result obtained through the FFT.

Selecting Trace

Step 1. Press **Trace Next** key to select the RF power measurement trace.

NOTE If you want to maximize the screen, press the **Trace Max** key.

Setting Scale of Measurement Trace (manual setting)

Follow the steps below to set the scale of the measurement trace manually.

Step 1. Press **Scale** - **Divisions**.

Step 2. Enter the number of divisions by scale for the y-axis in the data entry field that appears in the upper part of the screen.

Step 3. Press **Display** - **Y # of Digits**.

Step 4. Select the number of digits for Y-axis in the softkey menu. Available options are 4-digits, 8-digits, and 12-digits.

NOTE Set the number of digits for Y-axis display for each measurement mode. Therefore, when the number of digits for Y-axis is changed in the frequency measurement, those for the RF power measurement and the power supply DC current measurement are also changed.

Step 5. Press **Scale** - **Reference Position**.

Step 6. Enter the position of the scale reference line in the data entry field that appears in the upper part of the screen.

The position of the scale reference line must be specified by any of the numbers assigned to the y-axis scale, from 0 (minimum scale) to the number of divisions (max scale).

Step 7. Press **Scale** - **Reference Value**.

Step 8. Enter the value of the scale reference line in the data entry field that appears in the upper part of the screen. The unit is dBm.

Step 9. Press **Scale** - **Scale/Div**.

Step 10. Enter the value per scale in the data entry field that appears in the upper part of the screen. The unit is dB/Div.

Setting Scale of Measurement Trace (automatic setting)

Follow the steps below to set the scale of the measurement trace automatically.

Step 1. Press **Scale** - **Auto Scale**.

NOTE

If you want the scale setting to be performed automatically for all three measurement traces (RF power, frequency and power supply DC current), press **Scale** - **Auto Scale All**.

Setting Trace Offset (manual setting)

You can add an offset value to the displayed trace. Follow the steps below.

Step 1. Press **Format** - **Offset**

Step 2. Enter the offset value to be added to the trace in the data entry field that appears in the upper part of the screen. dBm is used as a unit.

Setting Trace Offset (Y-axis marker setting)

When the marker is displayed, the value of the active marker is used as the offset value. The procedure is as follows.

Step 1. Move the active marker to the position of the measurement value that you want to set as a reference.

Step 2. Press **Format** - **Marker -> -Offset**

NOTE

Even when the reference marker mode is on and the active marker displays a Δ value, the value of the active marker is used as the offset value.

When the offset value has already been set, that value is overwritten.

When an active marker does not exist, this function is not available.

Setting X-axis Scale (manual setting)

Follow the steps below to set the maximum/minimum display values of the x-axis. This is used when you want to enlarge a part of the displayed trace.

Step 1. Press **Scale** - **X axis - Auto** to turn off the auto adjustment of the x-axis scale.

Step 2. Press **Scale** - **X axis - Left**

Step 3. Enter the display start value of the x-axis in the data entry field that appears in the upper part of the screen. V is used as a unit.

Step 4. Press **Scale** - **X axis - Right**

Step 5. Enter the display stop value of the x-axis in the data entry field that appears in the upper part of the screen. V is used as a unit.

NOTE

When you want to restore the display's original start/stop values, press **Scale** - **X axis - Auto** to turn on the auto adjustment of the x-axis scale.

Setting X-axis Scale (x-axis band marker setting)

When the band marker of the x-axis is displayed, the x-axis scale can be adjusted to the band marker setting. The procedure is as follows.

Step 1. Press **Scale** - **X axis - Band Marker -> X Axis**

Setting Attenuator

When an input level is very high, a message may appear to prompt you to adjust the attenuator. In this case, follow the steps below to adjust the attenuator.

Step 1. Press **Attn** - **Input Attenuator** to enter the attenuator value in the data entry field that appears in the upper part of the screen.

You can select the value from the options: 0 dB, 5 dB, 10 dB, 15 dB, 20 dB, 25 dB, 30 dB or 35 dB. The appropriate input level is between 0 and 5 dBm, depending on the type of measurement or the characteristics of the DUT. Adjust the attenuator so that the input level of the RF port approximates this range.

NOTE

When the downconverter is turned on, the RF input is set to Down converter, and the external mixer is set to Not Used, the attenuator value is fixed to 10 dB.

Executing Carrier Search Function

The carrier search function is to detect the input signal frequency with the selected carrier frequency band for the downconverter RF IN (i.e. 3 to 10 GHz or 9 to 26.5 GHz) and reflect the result to the nominal frequency. Refer to “Executing Carrier Search Function” on page 96 for the setting procedure.

Setting Smoothing

You can use the smoothing function to reduce the trace noise. Follow the steps below.

Step 1. Press **Trace/View** - **Aperture**.

Step 2. Enter the value of the smoothing aperture (%) in the data entry field that appears in the upper part of the screen.

Step 3. Press **Trace/View** - **Smoothing** to turn on the smoothing function.

Confirming Measurement Points by Markers

Step 1. Press **Marker** to display marker 1 on the screen.

Step 2. Move marker 1 to the point you want to confirm and read the measurement value displayed in the upper part of the graph. To confirm multiple values, press **Marker** - **Marker x (x=1 to 10)**, which allows you to display up to marker 10.

Figure 4-7 Example of Measurement Screen (RF power characteristics)

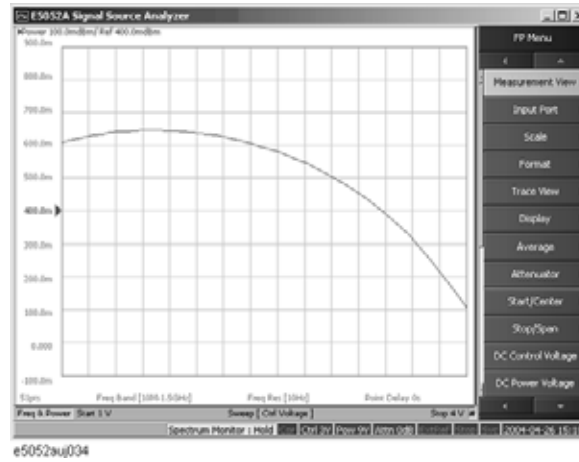

NOTE

By taking into account the transient of DC control/power prior to the sweep, the instrument will start the sweep after the time specified in **DC Control**(**DC Power**) - **DC Control(Power) Delay** has elapsed. This delay time is not included in the sweep time, and it only applies to the first measurement point.

Confirming Result of Power Supply DC Current Measurement

The following section describes the procedure used to confirm the measurement results of the power supply DC current corresponding to the DUT's DC control/power by using the E5052A's frequency/power measurement window.

Selecting Trace

Step 1. Press the **Trace Next** key to select the power supply DC current measurement trace.

NOTE If you want to maximize the screen, press the **Trace Max** key.

Setting Scale of Measurement Trace (manual setting)

Follow the steps below to set the scale of the measurement trace manually.

Step 1. Press **Scale** - **Divisions**.

Step 2. Enter the number of divisions by scale for the y-axis in the data entry field that appears in the upper part of the screen.

Step 3. Press **Display** - **Y # of Digits**.

Step 4. Select the number of digits for Y-axis in the softkey menu. Available options are 4-digits, 8-digits, and 12-digits.

NOTE Set the number of digits for Y-axis display for each measurement mode. Therefore, when the number of digits for Y-axis is changed in the frequency measurement, those for the RF power measurement and the power supply DC current measurement are also changed.

Step 5. Press **Scale** - **Reference Position**.

Step 6. Enter the position of the scale reference line in the data entry field that appears in the upper part of the screen.

The position of the scale reference line must be specified by any of the numbers assigned to the y-axis scale, from 0 (minimum scale) to the number of divisions (maximum scale).

Step 7. Press **Scale** - **Reference Value**.

Step 8. Enter the value of the scale reference line in the data entry field that appears in the upper part of the screen. The unit is A.

Step 9. Press **Scale** - **Scale/Div**.

Step 10. Enter the value per scale in the data entry field that appears in the upper part of the screen. The unit is A/Div.

Setting Scale of Measurement Trace (automatic setting)

Follow the steps below to set the scale of the measurement trace automatically.

Step 1. Press **Scale** - **Auto Scale**.

NOTE If you want the scale setting to be performed automatically for all three measurement traces

(RF power, frequency and power supply DC current), press **Scale** - **Auto Scale All**.

Setting Trace Offset (manual setting)

You can add an offset value to the displayed trace. Follow the steps below.

- Step 1.** Press **Format** - **Offset**
- Step 2.** Enter the offset value to be added to the trace in the data entry field that appears in the upper part of the screen. A is used as a unit.

Setting Trace Offset (Y-axis marker setting)

When the marker is displayed, the value of the active marker is used as the offset value. The procedure is as follows.

- Step 1.** Move the active marker to the position of the measurement value that you want to set as the reference
- Step 2.** Press **Format** - **Marker -> -Offset**

NOTE

Even when the reference marker mode is on and the active marker displays a Δ value, the value of the active marker is used as the offset value.

When the offset value has already been set, that value is overwritten.

When an active marker does not exist, this function is not available.

Setting X-axis Scale (manual setting)

Follow the steps below to set the maximum/minimum display values of the x-axis. This is used when you want to enlarge a part of the displayed trace.

- Step 1.** Press **Scale** - **X axis - Auto** to turn off the auto adjustment of the x-axis scale.
- Step 2.** Press **Scale** - **X axis - Left**
- Step 3.** Enter the display start value of the x-axis in the data entry field that appears in the upper part of the screen. V is used as a unit.
- Step 4.** Press **Scale** - **X axis - Right**
- Step 5.** Enter the display stop value of the x-axis in the data entry field that appears in the upper part of the screen. V is used as a unit.

NOTE

When you want to restore the display's original start/stop values, press **Scale** - **X axis - Auto** to turn on the auto adjustment of the x-axis scale.

Setting X-axis Scale (x-axis band marker setting)

When the band marker of the x-axis is displayed, the x-axis scale can be adjusted to the band marker setting. The procedure is as follows.

- Step 1.** Press **Scale** - **X axis - Band Marker -> X Axis**

Setting Attenuator

When the input level is very high, a message may appear to prompt you to adjust the attenuator. In this case, follow the steps below to adjust the attenuator.

- Step 1.** Press **Attn** - **Input Attenuator** to enter the attenuator value in the data entry field that appears in the upper part of the screen.

You can select the value from the options: 0 dB, 5 dB, 10 dB, 15 dB, 20 dB, 25 dB, 30 dB or 35 dB. The appropriate input level is between 0 and 5 dBm, depending on the type of measurement or the characteristics of the DUT. Adjust the attenuator so that the input level of the RF port approximates this range.

NOTE

When the downconverter is turned on, the RF input is set to Down converter, and the external mixer is set to Not Used, the attenuator value is fixed to 10 dB.

Executing Carrier Search Function

The carrier search function is to detect the input signal frequency with the selected carrier frequency band for the downconverter RF IN (i.e. 3 to 10 GHz or 9 to 26.5 GHz) and reflect the result to the nominal frequency. Refer to “Executing Carrier Search Function” on page 96 for the setting procedure.

Setting Smoothing

You can use the smoothing function to reduce the trace noise. Follow the steps below.

- Step 1.** Press **Trace/View** - **Aperture**.
- Step 2.** Enter the value of the smoothing aperture (%) in the data entry field that appears in the upper part of the screen.
- Step 3.** Press **Trace/View** - **Smoothing** to turn on the smoothing function.

Confirming Measurement Points by Markers

- Step 1.** Press **Marker** to display marker 1 on the screen.
- Step 2.** Move marker 1 to the point you want to confirm and read the measurement value displayed in the upper part of the graph. To confirm multiple values, press **Marker** - **Marker x (x=1 to 10)**, which allows you to display up to marker 10.

Figure 4-8 Example of Measurement Screen (power supply DC current characteristics)

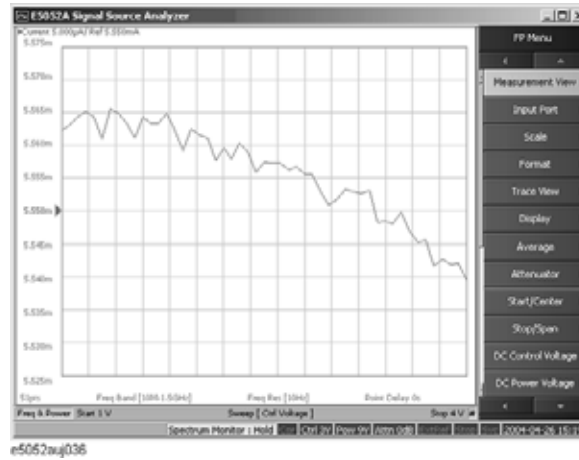

NOTE

By taking into account the transient of DC control/power prior to the sweep, the instrument will start the sweep after the time specified in **DC Control**(**DC Power**) **Voltage - DC Control(Power) Delay** has elapsed. This delay time is not included in the sweep time, and it only applies to the first measurement point.

Phase Noise Measurement in Phase Noise Measurement Mode

Overview of Phase Noise Measurement

This function locks on the DUT's output signal and measures the phase of the signal in the specified offset frequency range.

The following section describes the basic measurement method of the DUT's phase noise corresponding to the offset frequency from the carrier by using the E5052A's phase noise measurement window.

Setting Phase Noise Measurement

Follow the steps below to measure the phase noise by using the E5052A's phase noise measurement window.

Selecting Measurement Window

Step 1. Press **Meas/View** - **Phase Noise** to select the phase noise measurement window.

NOTE

You can maximize the frequency/power measurement window by pressing the **Window Max** key while the window is selected. You can return to the original size when you press the **Window Max** key once again.

Setting Downconverter and External mixer

Follow these steps to make the setting when using the E5053A Microwave Downconverter.

Step 1. Press **Input** - **Downconverter**.

Step 2. Press **Downconverter** to toggle on/off.

Step 3. If the downconverter is turned on, press **RF Input - Downconverter | E5052A Direct** to select an RF input source.

Step 4. If the downconverter is turned on and the RF input is set to Downconverter, press **External Mixer - Not Used | ON** to select whether to use the external mixer.

NOTE

For more information on the settings of the E5053A Microwave Downconverter, see Chapter 5, "Measurement Using E5053A and External Mixer."

The settings when using the downconverter and the external mixer include:

- Setting of LO frequency and power
 - Setting of DC bias current (CH1, CH2)
 - Setting of IF gain inside downconverter
 - Setting of downconverter Δ IF frequency
-

Selecting Carrier Frequency Band

- Step 1.** Press - **Frequency Band**.
- Step 2.** Select the appropriate frequency band that contains the target carrier signal from the softkey menu list. The range of each frequency band is listed in the following table.

NOTE Selectable frequency bands differ depending on whether the E5053A Microwave Downconverter is used and whether the RF input is direct input or downconverter input.

Table 4-10 **Selecting Carrier Frequency Band (When E5052A is Used Standalone or with Downconverter is Off)**

Carrier frequency band
10 M to 41 MHz
39 M to 101 MHz
99 M to 1.5 GHz
300 M to 7 GHz

Table 4-11 **Selecting Carrier Frequency Band (When Downconverter is On and RF Input Set to 'E5052A Direct')**

Carrier frequency band
10 M to 41 MHz
39 M to 101 MHz
99 M to 1.5 GHz
300 M to 3 GHz

Table 4-12 **Selecting Carrier Frequency Band (When Downconverter is On and RF Input Set to 'Downconverter')**

Carrier frequency band
3 G to 10 GHz
9 G to 26.5 GHz

Specifying Nominal Frequency

Enter the nominal value of the carrier frequency.

- Step 1.** Press - **Nominal Frequency**.
- Step 2.** Enter the value of the nominal frequency in the data entry field displayed in the upper part of the screen.

NOTE The carrier search function is to detect the input signal frequency with the selected carrier

Basic Measurement Using E5052A
Phase Noise Measurement in Phase Noise Measurement Mode

frequency band for the downconverter RF IN (i.e. 3 to 10 GHz or 9 to 26.5 GHz) and reflect the result to the nominal frequency.

See also “Executing Carrier Search Function” on page 96.

Optimizing LO Phase Noise Characteristics

In the SSB phase noise measurement of the DUT, LO phase noise characteristics can be selected for optimizing the phase noise measurement accuracy.

Step 1. Press - **LO PhNoise Optimize.**

Step 2. Select LO phase noise characteristics in the softkey menu displayed.

Table 4-13 LO Phase Noise Characteristics

Softkey	Overview
L(f) for > 150 kHz	Lowering LO SSB phase noise at > 150 kHz offset frequency
L(f) for < 150 kHz	Lowering LO SSB phase noise at < 150 kHz offset frequency

NOTE Refer to the “Phase Noise Measurement” on page 313 in the Chapter 10, “Specifications and Supplemental Information.”

Selecting Measurement Quality

- Step 1.** Press **Setup** - **Measurement Quality**.
- Step 2.** Select the appropriate quality level from the softkey menu list. The available options are Normal and Fast.

NOTE To obtain the outline of the measurement data, select “Fast” for the quality level. If you need more precise frequency resolution, select “Normal” for the quality level.

Specifying Sweep Range for Offset Frequency

- Step 1.** Press **Start/Center** (**Stop/Span**) - **Start**.
- Step 2.** Select the sweep start value from the softkey menu list.
You can select the value from the options: 1 Hz, 10 Hz, 100 Hz or 1 kHz.
- Step 3.** Press **Start/Center** (**Stop/Span**) - **Stop**.
- Step 4.** Select the sweep stop value from the softkey menu list.
You can select the value from the options: 100 kHz, 1 MHz, 5 MHz, 10 MHz, 20 MHz or 40 MHz.

NOTE Sweep stop values that are selectable differ depending on the selection of the carrier frequency band.

- For 10 M - 41 MHz
100 kHz, 1 MHz, 5 MHz
- For 39 M - 101 MHz
100 kHz, 1 MHz, 5 MHz, 10 MHz, 20 MHz
- For frequency bands other than above
100 kHz, 1 MHz, 5 MHz, 10 MHz, 20 MHz, 40 MHz

NOTE The number of measurement points varies depending on the setting value for the sweep range.

Table 4-14 Correlation Table for Measurement Points and Sweep Range

Start/Stop	100 kHz	1 MHz	5 MHz	10 MHz	20 MHz	40 MHz
1 Hz	646	775	865	904	943	982
10 Hz	517	646	736	775	814	853
100 Hz	388	517	607	646	685	724
1 kHz	259	388	478	517	556	595

NOTE For phase noise measurement, you cannot use the center value or span value for log sweep.

Setting Average Function and Correlation Number

Follow the steps below to use the averaging function.

- Step 1.** Press **[Avg/BW]** - **Avg Factor**.
- Step 2.** Enter the number of times for averaging in the data entry field that appears in the upper part of the screen.
- Step 3.** Press **[Avg/BW]** - **Averaging** to turn on the averaging function.
- Step 4.** Press **[Avg/BW]** - **Correlation**.
- Step 5.** Enter the value of the correlation number in the data entry field that appears in the upper part of the screen.

NOTE If it takes more than one second for one sweep of phase noise measurement, you will see a “|” character rotates on the measurement status, which indicates the measurement is in progress.

And if it takes more than two seconds for one sweep, under the conditions that the number of correlation is set to more than two, you will see the progress bar in the left of the measurement status.

About DC Voltage Setting and Protection

You can specify DC power/control that is applied to DUT. Refer to “Setting DC power/DC control and protection” on page 86 for the setting procedure.

About Auto Frequency Control Function

If this function is turned on, the E5052A will adjust the control voltage automatically so that the output signal frequency from the DUT may keep the specified value. For the setting procedure, refer to the “Auto Frequency Control Function” on page 88.

Setting Trigger

- Step 1.** Press **[Trigger]** - **Source**.
- Step 2.** Select the trigger source from the softkey menu list. The available options are as follows. Internal is selected by default.

Table 4-15 **Trigger Source List**

Softkey	Overview
Internal	Sets trigger source to internal continuous trigger
External ^{*1}	Sets trigger source to external trigger input connector
Manual	Sets trigger source to manual operation

Table 4-15 Trigger Source List

Softkey	Overview
Bus	Sets trigger source to the bus; the trigger signal is issued by the trigger command via GPIB interface or LAN.

*1. If External is selected for the trigger source, the trigger signal must be provided by an external instrument. Refer to “Setting External Trigger” on page 137 for the setting procedure.

Step 3. Press **Trigger** - **Trigger to Phase Noise** to send a trigger to the phase noise measurement. By default, **Continuous** is selected for sweep.

NOTE

The E5052A has four measurement function: phase noise measurement, spectrum monitor measurement, frequency/power measurement, and transient measurement. Because individual measurements differ in their characteristics from one another, the E5052A’s each trigger is used exclusively for a single measurement function.

In other words, only one measurement function can be triggered at a time, and only this function can perform measurement at this time.

Setting Averaging Trigger

Follow the steps below to use the averaging trigger.

Step 1. Press **Trigger** - **Average Trigger** to toggle on/off the averaging trigger.

When the averaging trigger is set to on, a single activation of the trigger system can perform the number of measurements set by the user as the averaging factor.

The following table shows how this function works by pressing **Trigger** - **Single** when the averaging trigger is on and off.

Averaging Trigger	Operation
ON	Executes state transitions among Waiting for Trigger, Trigger, and Measurement for the number of times set for averaging and then changes to the Hold state.
OFF	Enters Waiting for Trigger state once and then changes to the Hold state after measurement is completed.

NOTE

The averaging function (“Setting Average Function” on page 84) must be set before enabling the averaging trigger.

Confirming Result of Phase Noise Measurement

Follow the steps below to confirm the results of the DUT's phase noise measurement by using the E5052A's phase noise measurement window.

Setting Scale of Measurement Trace (manual setting)

Follow the steps below to set the scale of the measurement trace manually.

- Step 1.** Press **Scale** - **Divisions**.
- Step 2.** Enter the number of divisions by scale for the y-axis in the data entry field that appears in the upper part of the screen.
- Step 3.** Press **Display** - **Y # of Digits**.
- Step 4.** Select the number of digits for Y-axis in the softkey menu. Available options are 4-digits, 8-digits, and 12-digits.
- Step 5.** Press **Scale** - **Reference Position**.
- Step 6.** Enter the position of the scale reference line in the data entry field that appears in the upper part of the screen.

The position of the scale reference line must be specified by any of the numbers assigned to the y-axis scale, from 0 (minimum scale) to the number of divisions (maximum scale).
- Step 7.** Press **Scale** - **Reference Value**.
- Step 8.** Enter the value of the scale reference line in the data entry field that appears in the upper part of the screen. The unit is dBc/Hz.
- Step 9.** Press **Scale** - **Scale/Div**.
- Step 10.** Enter the value per scale in the data entry field that appears in the upper part of the screen. The unit is dB/Div.

Setting Scale of Measurement Trace (automatic setting)

Follow the steps below to set the scale of measurement trace automatically.

- Step 1.** Press **Scale** - **Auto Scale**.

Setting Trace Offset (manual setting)

You can add an offset value to the displayed trace. Follow the steps below.

- Step 1.** Press **Format** - **Offset**
- Step 2.** Enter the offset value to be added to the trace in the data entry field that appears in the upper part of the screen. dBc/Hz is used as a unit.

Setting Trace Offset (Y-axis marker setting)

When the marker is displayed, the value of the active marker is used as the offset value. The procedure is as follows.

- Step 1.** Move the active marker to the position of the measurement value that you want to set as the

reference.

Step 2. Press **Format** - **Marker -> -Offset**

NOTE

Even when the reference marker mode is on and the active marker displays a Δ value, the value of the active marker is used as the offset value.

When the offset value has already been set, that value is overwritten.

When an active marker does not exist, this function is not available.

Setting X-axis Scale (manual setting)

Follow the steps below to set the maximum/minimum display values of the x-axis. This is used when you want to enlarge a part of the displayed trace.

Step 1. Press **Scale** - **X axis - Auto** to turn off the auto adjustment of the x-axis scale.

Step 2. Press **Scale** - **X axis - Left**

Step 3. Enter the display start value of the x-axis in the data entry field that appears in the upper part of the screen. Hz is used as a unit.

Step 4. Press **Scale** - **X axis - Right**

Step 5. Enter the display stop value of the x-axis in the data entry field that appears in the upper part of the screen. Hz is used as a unit.

NOTE

When you want to return the display start/stop values to the original ones, press **Scale** - **X axis - Auto** to turn on the auto adjustment of the x-axis scale.

Setting X-axis Scale (x-axis band marker setting)

When the band marker of the x-axis is displayed, the x-axis scale can be adjusted to the band marker setting. The procedure is as follows.

Step 1. Press **Scale** - **X axis - Band Marker -> X Axis**

Basic Measurement Using E5052A
Phase Noise Measurement in Phase Noise Measurement Mode

Setting IF Gain

“IF over flow” error may be displayed when phase noise is distorted. On the other hand, internal noise level of the instrument may be significant in the measurement display when the DUT has a low-noise characteristics. In this case, follow the steps below to adjust the IF Gain value.

Step 1. Press **Setup** - **IF Gain**.

Step 2. Enter the IF Gain value in the data entry field that appears in the upper part of the screen.

You can select the value from the options: 0 dB, 10 dB, 20 dB, 30 dB, 40 dB or 50 dB.

NOTE When either “Phase lock loop unlocked” or “IF A/D overflow” error message is displayed, choose an appropriate IF Gain value indicated as the table below (Table 4-16).

Table 4-16 IF Gain selection table

DUT type	IF Gain
Frequency drifting sources (Free-run VCO, etc.)	0, 10 dB
Frequency locked sources (PLL Synthesizer, etc.)	20, 30, 40, 50 dB

NOTE With the Option 011 configured, available IF Gain options are 0 dB, 10 dB, and 20 dB.

If the IF signal is not at appropriate value a “drop out” may occur as it will not be able to detect the phase noise of the DUT at the ADC resulting in strange measurement as show in the figure below.

In such a case, it is recommended to increase the value of IF gain (default value of 20 dB) as it is important to correctly measure the phase noise at close in offset.

Figure 4-9 Example of IF signal is not at appropriate value



Setting Attenuator

In case when an input level is very high, a message may appear to prompt you to adjust the attenuator. In this case, follow the steps below to adjust the attenuator.

- Step 1.** Press **Attn** - **Input Attenuator** to enter the attenuator value in the data entry field that appears in the upper part of the screen.

You can select the value from the options: 0 dB, 5 dB, 10 dB, 15 dB, 20 dB, 25 dB, 30 dB or 35 dB. The appropriate input level is between 0 and 5 dBm, depending on the type of measurement or the characteristics of the DUT. Adjust the attenuator so that the input level of the RF port approximates this range.

NOTE

When the downconverter is turned on, the RF input is set to Down converter, and the external mixer is set to Not Used, the attenuator value is fixed to 10 dB.

Executing Carrier Search Function

When the downconverter is turned on, the RF input is set to Downconverter, and the external mixer is set to Not Used, the function to search for the carrier signal in the specified carrier frequency band and reflect the result to the nominal frequency is available.

- Step 1.** Press **Setup**
- Step 2.** Press **Carrier Search** to execute the carrier signal search.
- Step 3.** The detected signal frequency is reflected on the nominal frequency.

Setting Smoothing

You can use the smoothing function to reduce the trace noise. Follow the steps below.

- Step 1.** Press **Trace/View** - **Aperture**.
- Step 2.** Enter the value of the smoothing aperture (%) in the data entry field that appears in the upper part of the screen.
- Step 3.** Press **Trace/View** - **Smoothing** to turn on the smoothing function.

Confirming Measurement Points by Markers

- Step 1.** Press **Marker** to display marker 1 on the screen.
- Step 2.** Move marker 1 to the point you want to confirm and read the measurement value displayed in the upper part of the graph. To confirm multiple values, press **Marker** - **Marker x (x=1 to 10)**, which allows you to display up to marker 10.

Figure 4-10 Example of Measurement Screen (phase noise - offset frequency characteristics)

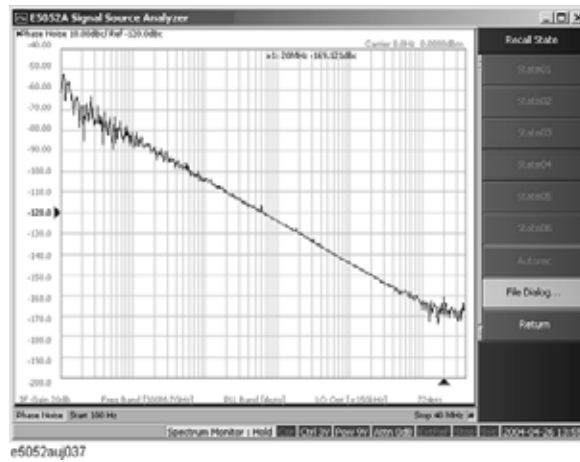

NOTE

In this measurement, you cannot specify the sweep time. It will be determined automatically based on the selection of the offset frequency sweep range and the carrier frequency band.

Confirming Integral Phase Noise, Jitter and Residual FM

- Step 1.** Specify the noise integration range by using the band marker. For further detail, refer to “Searching in Specified Range” on page 209. You do not have to use the band marker to integrate the entire range.
- Step 2.** Press **Marker** - Analysis Type.
- Step 3.** Press **Integral**. In the upper right part of the screen, you will see the Integral Phase Noise value [dBc], the RMS Noise value [rad, deg], the RMS Jitter value [sec] and Residual FM value [Hzrms].

Calculate Integral Phase Noise, Jitter and Residual FM, using the specified data by analysis range.

Integral Phase Noise returns the value of SSB Integral result. RMS Noise, Jitter and Residual FM returns the value after applying the DSB conversion.

Value	Formula
Integral Phase Noise	$10 * \log(\text{integ}(10 ^ (L(f) / 10)))$ [dBc]
RMS Noise	$\text{sqrt}(2 * 10 ^ (\text{Integral Phase Noise} / 10))$ [rad]
RMS Jitter	$\text{RMS Noise} / (2 * \pi * \text{Carrier Frequency})$ [sec]
Residual FM	$\text{sqrt}(2 * \text{integ}(f ^ 2 * 10 ^ (L(f) / 10)))$ [Hz]

where, L(f) : Phase Noise [dBc/Hz] and integ : Integral

NOTE

When Power is selected in the spurious measurement, it is calculated with adding the power of spurious after integrating except spurious.

Confirming Spurious

The E5052A obtains a reference waveform based on the moving average of the phase noise measurement results, and regards any data as spurious that may vary significantly from the reference waveform.

Figure 4-11 Spurious Judgment

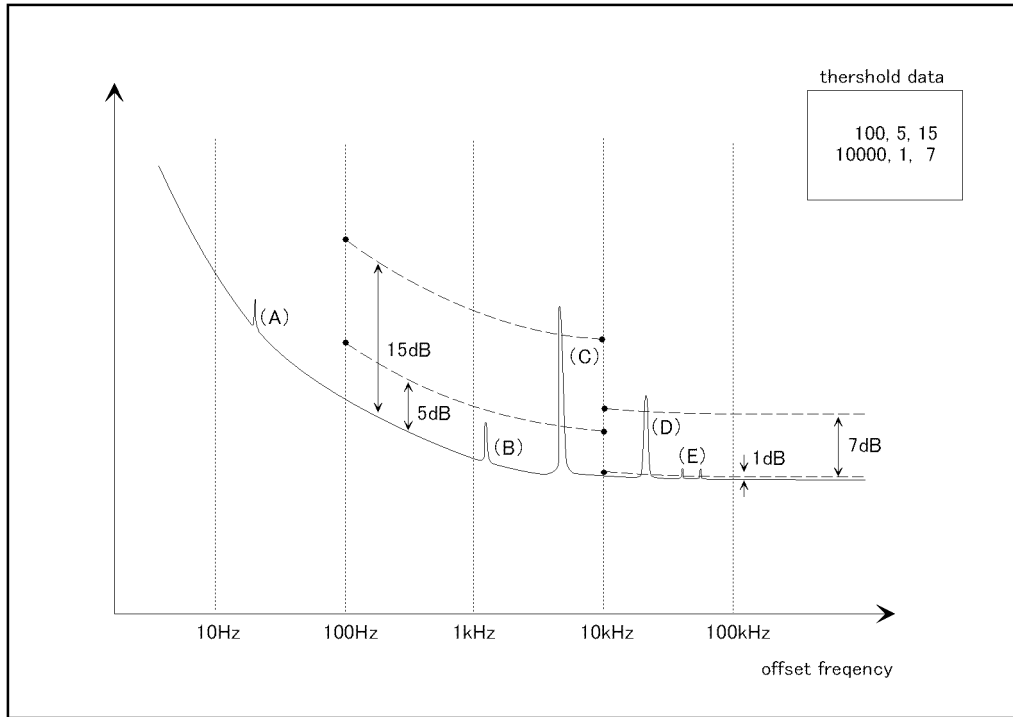

You can view the measurement points regarded as spurious in power (dBc). You can also provide any user-defined threshold for determining spurious.

Spurious judgment

- (A), (E) For measurement values falling in the range for which no threshold is specified (A), or between the upper and lower thresholds (E), the E5052A determines whether or not they are spurious based on its own determination criteria.
- (B) The E5052A considers the spurious smaller than the lower threshold as non-spurious regardless of its own determination criteria.
- (C), (D) The E5052A considers the spurious greater than the upper threshold as spurious regardless of its own determination criteria.

Step 1. To specify the threshold for spurious, you must define the threshold table in advance. Define the threshold data in the following format, and then save it in the CSV format (with the extension of *.csv).

freq_from, threshold_min, threshold_max

freq_from, threshold_min, threshold_max

Basic Measurement Using E5052A

Phase Noise Measurement in Phase Noise Measurement Mode

:

freq_from, threshold_min, threshold_max

Parameter	Overview
freq_from	Setting the start point of the threshold for spurious. You can not specify the end point. If the next start point and upper/lower threshold values are not specified, this threshold is valid until the stop frequency.
threshold_min	Lower threshold value
threshold_max	Upper threshold value

NOTE

One line represents one segment, and you can specify up to 50 segments in the threshold table.

If the upper threshold is smaller than the lower threshold, the former will take precedence.

You can comment out the line by placing “#” at the beginning of the line.

Step 2. Press - Spurious.

Step 3. Press Import Threshold table to import the threshold data file that you defined in advance.

Step 4. Press **Power (dBc)**. The data regarded as spurious is displayed in blue. You can view the stimulus and response values for each peak of spurious in a text file by pressing Spurious List now.

By Pressing Omit, the data regarded as spurious is replaced by the reference waveform that the E5052A calculated. By pressing Normalized (dBc), the data displayed is back to the phase noise data.

NOTE

By pressing Clear Threshold Table, the threshold table is cleared and set to the initial value, 0, 2, 30.

Confirming Allan Variance using with Phase Noise measurement value

It is available to calculate the Allan Variance (sigma) and Jitter using the measured average time and the key operation. For more information refer to the command reference of programmer's guide.

NOTE

The value obtained with E5052A as sigma is standard deviation, and the Allan Variance as the general definition is the value that is squared this sigma.

Spectrum Monitor Measurement in Spectrum Monitor Measurement Mode

Overview of Spectrum Monitor Measurement

You can measure the spectrum of a specified range by sweeping the DUT's output signals and approximate frequency range.

The following section describes the basic measurement method of spectrum monitor measurement by using the E5052A's spectrum monitor measurement window.

Setting Spectrum Monitor Measurement

Follow the steps below to set up the measurement by using the E5052A's phase spectrum monitor measurement window.

Selecting Measurement Window

Step 1. Press **Meas/View** - **Spectrum Monitor**.

NOTE

You can maximize the frequency/power measurement window by pressing the **Window Max** key while the window is selected. You can return to the original size when you press the **Window Max** key once again.

Setting the downconverter and the external mixer

Follow these steps to make the setting when using the E5053A Microwave Downconverter.

Step 1. Press **Input** - **Downconverter**.

Step 2. Press **Downconverter** to toggle on/off.

Step 3. If the downconverter is on, press **RF Input - Downconverter | E5052A Direct** to select an RF input source.

Step 4. If the downconverter is on and the RF input is set to Downconverter, press **External Mixer - Not Used | ON** to select whether to use the external mixer.

NOTE

For more information on the settings of the E5053A Microwave Downconverter, see Chapter 5, "Measurement Using E5053A and External Mixer."

The settings when using the downconverter and the external mixer include:

- Setting of LO frequency and power
 - Setting of DC bias current (CH1, CH2)
 - Setting of IF gain inside downconverter
 - Setting of downconverter Δ IF frequency
-

Procedure to select a carrier frequency band

- Step 1.** Press **Start/Center** (**Stop/Span**) - **Carrier To - Frequency Band**.
- Step 2.** Select a frequency band that contains the carrier signal to be measured from the softkey menu list. The ranges of the frequency bands are shown below.

NOTE Selectable frequency bands differ depending on whether the E5053A Microwave Downconverter is used and whether the RF input is direct input or downconverter input.

Table 4-17 **Selecting Carrier Frequency Band (When E5052A is Used Standalone or with Downconverter is Off)**

Carrier frequency band
10 M to 1.5 GHz
300 M to 7 GHz

Table 4-18 **Selecting Carrier Frequency Band (When Downconverter is On and RF Input Set to 'E5052A Direct')**

Carrier frequency band
10 M to 1.5 GHz
300 M to 3 GHz

Table 4-19 **Selecting Carrier Frequency Band (When Downconverter is On and RF Input Set to 'Downconverter')**

Carrier frequency band
3 G to 10 GHz
9 G to 26.5 GHz

NOTE When the downconverter is turned on, the RF input is set to Downconverter, and the external mixer is set to on, setting the carrier frequency band is not available.

Specifying Frequency Sweep Range

- Step 1.** Press **Start/Center** (**Stop/Span**) - **Start**.
- Step 2.** Enter the sweep start value in the data entry field that appears in the upper part of the screen.
- Step 3.** Press **Start/Center** (**Stop/Span**) - **Stop**.
- Step 4.** Enter the sweep stop value in the data entry field that appears in the upper part of the screen.

NOTE Otherwise, press **Start/Center** (**Stop/Span**) - **Center** to enter the sweep center value in the data entry field that appears in the upper part of the screen and then press **Span** to enter the sweep span value in the same way.

The same softkey will be displayed by pressing either **Start/Center** or **Stop/Span**. You can make the same settings by using either of the two keys.

NOTE Allowable setting range for the frequency sweep varies depending on whether the E5053A is turned on/off and the RF input is set to 'E5052A Direct'/'Downconverter.' Possible setting range for the center frequency is possible widest setting range of the carrier frequency bands. More specifically, when possible setting range for the carrier frequency bands are 10M to 1.5GHz and 300M to 3GHz, resultant possible setting range for the center frequency is 10M to 3GHz.

Device Configuration	Carrier Frequency Bands	Possible Setting Range for Center Frequency
E5052A is stand-alone, or with downconverter turned off	10 M to 1.5 GHz 300 M to 7 GHz	10 M to 7 GHz
With the downconverter turned on and RF input set to 'E5052A Direct'	10 M to 1.5 GHz 300 M to 3 GHz	10 M to 3 GHz
With the downconverter turned on and RF input set to 'Downconverter'	3 G to 10 GHz 9 G to 26.5 GHz	3 G to 26.5 GHz

Specifying Maximum Input Level of Input Signal

Follow the steps below to enter the maximum level value of the measurement signals that are input from the RF port. For more information, refer to the Chapter 10, "Specifications and Supplemental Information," on page 311.

- Step 1.** Press **Setup** - **Reference Level**.
- Step 2.** Enter the maximum input level in the data entry field that appears in the upper part of the screen.

Setting Average Function

Follow the steps below to use the averaging function.

- Step 1.** Press **Avg/BW** - **Avg Factor**.
- Step 2.** Enter the number of times for averaging in the data entry field that appears in the upper part of the screen.
- Step 3.** Press **Avg/BW** - **Averaging Type** to select the averaging type. You can choose either Log-Pwr Avg or Pwr Avg(RMS).
- Step 4.** Press **Avg/BW** - **Averaging** to turn on the averaging function.

Specifying Measurement Resolution Bandwidth

Step 1. Press **[Avg/BW]** - **RBW**.

Step 2. Enter the RBW value in the data entry field that appears in the upper part of the screen.

You can select the value from the options: 100 kHz, 25 kHz, 6.25 kHz, 1.56 kHz, 391 Hz, 97.7 Hz, 24.4 Hz, 6.1 Hz, or 1.53 Hz.

About DC voltage setting and protection

You can specify DC power/control that is applied to the DUT. Refer to “Setting DC power/DC control and protection” on page 86 for the setting procedure.

About Auto Frequency Control Function

If this function is turned on, the E5052A will adjust the control voltage automatically so that the output signal frequency from the DUT may keep the specified value. For the setting procedure, refer to the “Auto Frequency Control Function” on page 88.

Setting Trigger

Step 1. Press **[Trigger]** - **Source**.

Step 2. Select the trigger source from the softkey menu list. The available options are as follows. Internal is selected by default.

Table 4-20

Trigger Source List

Softkey	Overview
Internal	Sets trigger source to internal continuous trigger
External*1	Sets trigger source to external trigger input connector
Manual	Sets trigger source to manual operation
Bus	Sets trigger source to the bus; the trigger signal is issued by the trigger command via GPIB interface or LAN.

*1. If External is selected for the trigger source, the trigger signal must be provided by an external instrument. Refer to “Setting External Trigger” on page 137 for the setting procedure.

Step 3. Press **[Trigger]** - **Trigger to Spectrum Monitor** to deliver a trigger to the spectrum monitor measurement. By default, **Continuous** is selected for sweep.

NOTE

The E5052A has four measurement functions: phase noise measurement, spectrum monitor measurement, frequency/power measurement and transient measurement. Because individual measurements differ in characteristics from one another, each of the E5052A’s triggers is used exclusively for a single measurement function.

In other words, only one measurement function can be triggered at a time, and only this function can perform measurement at this time.

Setting Averaging Trigger

Follow the steps below to use the averaging trigger.

Step 1. Press **Trigger** - **Average Trigger** to toggle on/off the averaging trigger.

When the averaging trigger is set to on, a single activation of the trigger system can perform the number of measurements set by the user as the averaging factor.

The following table shows how this function works by pressing **Trigger** - **Single** when the averaging trigger is on and off.

Averaging Trigger	Operation
ON	Executes state transitions among Waiting for Trigger, Trigger, and Measurement for the number of times set for averaging and then changes to the Hold state.
OFF	Enters Waiting for Trigger state once and then changes to the Hold state after measurement is completed.

NOTE

The averaging function (“Setting Average Function” on page 84) must be set before enabling the averaging trigger.

Confirming Result of Spectrum Monitor Measurement

Follow the steps below to confirm the results of the DUT's spectrum monitor measurement by using the E5052A's spectrum monitor measurement window.

Moving Carrier Frequency to the Center

- Step 1.** Press **Marker** to display marker 1 on the screen.
- Step 2.** Press **Marker Search** - **Peak** - **Search Peak** to move marker 1 to the position of carrier frequency.
- Step 3.** Press **Marker →** - **Marker->Center** to move the frequency in which the carrier resides to the center of the sweep range.

Moving harmonic Frequency to the Center

- Step 1.** Press **Start/Center** (**Stop/Span**)- **Carrier to** to move the frequency at which the carrier resides to the center of the sweep range.
- Step 2.** Press **Carrier x1 -> Center** to move the frequency at which the first harmonic resides, to the center of the sweep range. Pressing **Carrier x2 -> Center** or **Carrier x3 -> Center** moves the frequency at which the second or the third harmonic respectively resides, to the center of the sweep range.

To move the frequency in which an n-order harmonic resides to the center of the sweep range, press Harmonic # and enter the number corresponding to n, and then press Carrier x# -> Center.

NOTE

“No Signal Found” may error occur when the attenuator setting is not appropriate. Refer to “Error Messages” for more detail explanation.

Setting Format and Detector Mode

You can select the unit (format) used in the spectrum monitor measurement trace screen and switch to the detector mode.

NOTE

The E5052A displays the measurement value at the specified point; actually, it sweeps (measures) with the resolution determined by the RBW. The detector captures all of the signals not only at the display point but also between individual display points. If there are more measurement points than display points, you must select the detector mode so that each display point is converted from the individual value of multiple measurement points.

In the “Positive” mode, the E5052A displays the maximum value (peak) of the measurement values between the display points. In the “Sample” mode, the E5052A displays the measurement value at the nearest measurement point to the display point.

- Step 1.** Press **Format** - **Format**.
- Step 2.** Select the appropriate format from the softkey menu list. The available options are as

follows.

Table 4-21

Format List

Format	
dBm	dBm / Hz
dBV	dBV / Hz
Watt	Watt / Hz
Volt	Volt / Hz

Step 3. Press **[Format]** - **Detector Mode.**

Step 4. Select the appropriate detector mode from the softkey menu list. You can choose either Positive or Sample. Positive is selected by default.

Setting Scale of Measurement Trace (manual setting)

Follow the steps below to set the scale of the measurement trace manually.

Step 1. Press **[Scale]** - **Divisions.**

Step 2. Enter the number of divisions by scale for the y-axis in the data entry field that appears in the upper part of the screen.

Step 3. Press **[Display]** - **Y # of Digits.**

Step 4. Select the number of digits for Y-axis in the softkey menu. Available options are 4-digits, 8-digits, and 12-digits.

Step 5. Press **[Scale]** - **Reference Position.**

Step 6. Enter the position of the scale reference line in the data entry field that appears in the upper part of the screen.

The position of the scale reference line must be specified by any of the numbers assigned to the y-axis scale, from 0 (minimum scale) to the number of divisions (maximum scale).

Step 7. Press **[Scale]** - **Reference Value.**

Step 8. Enter the value of the scale reference line in the data entry field that appears in the upper part of the screen. The unit varies depending on the format setting.

Step 9. Press **[Scale]** - **Scale/Div.**

Step 10. Enter the value per scale in the data entry field that appears in the upper part of the screen. The unit varies depending on the format setting.

Setting Scale of Measurement Trace (automatic setting)

Follow the steps below to set the scale of the measurement trace automatically.

Step 1. Press **[Scale]** - **Auto Scale.**

Setting Trace Offset (manual setting)

You can add an offset value to the displayed trace. Follow the steps below.

- Step 1.** Press **[Format]** - **Offset**
- Step 2.** Enter the offset value to be added to the trace in the data entry field that appears in the upper part of the screen. The unit varies depending on the format setting.

Setting Trace Offset (Y-axis marker setting)

When the marker is displayed, the value of the active marker is used as the offset value. The procedure is as follows.

- Step 1.** Move the active marker to the position of the measurement value that you want to set as the reference.
- Step 2.** Press **[Format]** - **Marker -> -Offset**

NOTE

Even when the reference marker mode is on and the active marker displays a Δ value, the value of the active marker is used as the offset value.

When the offset value has already been set, that value is overwritten.

When an active marker does not exist, this function is not available.

Setting X-axis Scale (manual setting)

Follow the steps below to set the maximum/minimum display values of the x-axis. This is used when you want to enlarge a part of the displayed trace.

- Step 1.** Press **[Scale]** - **X axis - Auto** to turn off the auto adjustment of the x-axis scale.
- Step 2.** Press **[Scale]** - **X axis - Left**
- Step 3.** Enter the display start value of the x-axis in the data entry field that appears in the upper part of the screen. Hz is used as a unit.
- Step 4.** Press **[Scale]** - **X axis - Right**
- Step 5.** Enter the display stop value of the x-axis in the data entry field that appears in the upper part of the screen. Hz is used as a unit.

NOTE

When you want to restore the display's original start/stop values, press **[Scale]** - **X axis - Auto** to turn on the auto adjustment of the x-axis scale.

Setting X-axis Scale (x-axis band marker setting)

When the band marker of the x-axis is displayed, the x-axis scale can be adjusted to the band marker setting. The procedure is as follows.

- Step 1.** Press **[Scale]** - **X axis - Band Marker -> X Axis**

Setting Attenuator

When the input level is very high, a message may appear to prompt you to adjust the

attenuator. In this case, follow the steps below to adjust the attenuator.

- Step 1.** Press **Attn** - **Input Attenuator** to enter the attenuator value in the data entry field that appears in the upper part of the screen.

You can select the value from the options: 0 dB, 5 dB, 10 dB, 15 dB, 20 dB, 25 dB, 30 dB or 35 dB. The appropriate input level is between 0 and 5 dBm, depending on the type of measurement or the characteristics of the DUT. Adjust the attenuator so that the input level of the RF port approximates this range.

NOTE

When the downconverter is turned on, the RF input is set to Down converter, and the external mixer is set to Not Used, the attenuator value is fixed to 10 dB.

Setting Smoothing

You can use the smoothing function to reduce the trace noise. Follow the steps below.

- Step 1.** Press **Trace/View** - **Aperture**.
- Step 2.** Enter the value of the smoothing aperture (%) in the data entry field that appears in the upper part of the screen.
- Step 3.** Press **Trace/View** - **Smoothing** to turn on the smoothing function.

Transient Measurement in Transient Measurement Mode

Overview of transient measurement

You can measure the frequency, power and phase of the DUT along the time axis. The frequency can be measured by using two instruments of different frequency resolutions. Each frequency resolution has its own x-axis.

The E5052A's transient measurement window has four measurement trace screens to perform transient measurement of frequency (Wide Band/Narrow Band), power and phase. You can use each trace screen to measure the variation in frequency, power or phase after you have changed the output settings of the DUT.

The following section describes the basic measurement method of the variations in the DUT's frequency, power and phase by using the E5052A's transient measurement window.

Common Settings for Transient Measurement

Follow the steps below for the common settings to perform transient measurements of frequency, power or phase by using the E5052A's transient measurement window.

Selecting Measurement Screen

Step 1. Press **Meas/View** - **Transient** to select the transient measurement window.

NOTE

You can maximize the transient measurement window by pressing the **Window Max** key while the window is selected. You can return to the original size when you press the **Window Max** key once again.

You can select the next trace by pressing the **Trace Next** key and maximize the target trace by pressing the **Trace Max** key. The transient window will come back when you press the **Trace Max** key once again.

Setting Downconverter and External Mixer

Follow these steps to make the setting when using the E5053A Microwave Downconverter.

Step 1. Press **Input** - **Downconverter**.

Step 2. Press **Downconverter** to toggle on/off.

Step 3. If the downconverter is on, press **RF Input - Downconverter | E5052A Direct** to select an RF input source.

Step 4. If the downconverter is on and the RF input is set to Downconverter, press **External Mixer - Not Used | ON** to select whether to use the external mixer.

NOTE

For more information on the settings of the E5053A Microwave Downconverter, see Chapter 5, "Measurement Using E5053A and External Mixer."

The settings when using the downconverter and the external mixer include:

Basic Measurement Using E5052A

Transient Measurement in Transient Measurement Mode

- Setting of LO frequency and power
 - Setting of DC bias current (CH1, CH2)
 - Setting of IF gain inside downconverter
 - Setting of downconverter Δ IF frequency
-

Specifying Target Frequency

Specify target frequency for the Narrow Band measurement.

Step 1. Press - **Target Freq.**

Step 2. Enter the target frequency in the data entry field that appears in the upper part of the screen.

Allowable setting range is 10 MHz to 7 GHz if the downconverter is turned off.

Allowable setting range is 10 MHz to 3 GHz if the downconverter is turned on, the RF input is set to 'E5052A Direct.'

Allowable setting range is 3 G to 26.5 GHz if the downconverter is turned on, the RF input is set to 'Downconverter,' and the external mixer is set to 'Not Used.'

NOTE

Among the target frequency and the frequency band or the maximum frequency of the input signal (described later), one that is specified later overrides the other. For example, when the target frequency is set to 5 GHz, specifying the maximum frequency as 3 GHz will automatically decrease the target frequency below the maximum frequency.

Specifying Frequency Range

Specify frequency range for the Narrow Band measurement.

Step 1. Press - **Freq Range** to select the frequency range.

You can select either 1.6 MHz, 25.6 MHz, 200 kHz, 25 kHz, or 3.125 kHz. When the target frequency is set to less than 200 MHz, 1.6 MHz, 200 kHz, 25 kHz, or 3.125 kHz is available.

Specifying Frequency Band of Input Signal

Specify frequency range for the Wide Band measurement.

- Step 1.** Press - **Wide Freq Range.**
- Step 2.** Select the frequency band (Wide Band) from the softkey menu list. The available options are as follows.

Table 4-22 Frequency Band List (Wide Band)

Frequency Band	
50 M -150 MHz	1 G - 3 GHz
100 M -300 MHz	1.2 G -3.6 GHz
200 M -600 MHz	1.4 G -4.2 GHz
300 M -900 MHz	1.6 G -4.8 GHz
400 MHz -1.2 GHz	1.8 G -5.4 GHz
500 MHz - 1.5 GHz	2 G -6 GHz
600 MHz -1.8 GHz	2.2 G -6.6 GHz
800 MHz -2.4 GHz	2.4 G -7.2 GHz

NOTE The frequency bands shown above are all applicable only when the downconverter is turned off. When the downconverter is turned on and the RF input is set to ‘E5052A Direct,’ the maximum frequency band is “1 GHz to 3 GHz”.

When the downconverter is turned on, the RF input set to ‘Downconverter,’ and the external mixer set to ‘Not Used,’ specifying the frequency band is not available. In this case, specify the maximum frequency of the input signal. For details in the procedure, refer to “Specifying Maximum Frequency of Input Signal” on page 131.

Specifying Maximum Frequency of Input Signal

When the downconverter is turned on, the RF input set to ‘Downconverter,’ and the external mixer set to ‘Not Used,’ specify frequency of the input signal as the maximum frequency.

- Step 1.** Press - **Wide Max Frequency.**
- Step 2.** Enter the maximum frequency of the input signal in the data entry field that appears in the upper part of the screen.

Specifying the Maximum Input Level of Input Signal

Follow the steps below to enter the maximum level value of the measurement signals that are input from the RF port. For more information, refer to the Chapter 10, “Specifications and Supplemental Information,” on page 311.

- Step 1.** Press - **Max Input Level.**

Basic Measurement Using E5052A
Transient Measurement in Transient Measurement Mode

Step 2. Enter the maximum input level in the data entry field that appears in the upper part of the screen.

Specifying Sweep Start Time, Sweep Time and Reference Position for Frequency Transient (Wide Band) Measurement Trace

Step 1. Press the **Trace Next** key to select the measurement trace for the frequency transient (Wide Band). You can confirm which trace is selected by viewing the cursor, which is displayed to the left of the trace title.

NOTE You can also click on the trace of the frequency transient (Wide Band) for confirmation.

Step 2. Press **Start/Center** - **Wide Ref Position**.

Step 3. Select the sweep reference position from the softkey menu list.

You can select any of the three options: Left, Center or Right.

Step 4. Press **Start/Center** - **Wide Span**.

Step 5. Enter the sweep time value in the data entry field that appears in the upper part of the screen. The allowable input value may vary depending on the scale value, target frequency or frequency range of the measurement trace.

Step 6. Press **Start/Center** - **Wide Time Offset**.

Step 7. Enter the sweep offset value in the data entry field that appears in the upper part of the screen.

NOTE The function of **Time Offset** on the softkey is same as that of the **Start/Center** key.

Specifying Sweep Start Time, Sweep Time and Reference Position for Frequency Transient (Narrow Band) Measurement Trace, Power Transient Measurement Trace and Phase Transient Measurement Trace

Step 1. Press the **Trace Next** key to select the measurement trace for the frequency transient (Narrow Band). You can confirm which trace is selected by viewing the cursor which is displayed to the left of the trace title.

NOTE You can also click on the trace of the frequency transient (Narrow Band) for confirmation.

The procedure for specifying the sweep start time, sweep time and reference position for frequency transient (Narrow Band) measurement trace is also applicable to the measurement trace of power transient and phase transient.

You can also specify the sweep start time, sweep time, and reference position for the frequency transient (Narrow Band) measurement trace by selecting the measurement trace of the power transient or phase transient.

Step 2. Press **Start/Center** - **Narrow Ref Position**.

Step 3. Select the sweep reference position from the softkey menu list.

You can select any of the three options: Left, Center or Right.

Step 4. Press **Start/Center** - **Narrow Span**.

Step 5. Enter the sweep time value in the data entry field that appears in the upper part of the screen. The allowable input value may vary depending on the scale value, target frequency, or frequency range of the measurement trace.

Step 6. Press **Start/Center** - **Narrow Time Offset**.

Step 7. Enter the sweep offset value in the data entry field that appears in the upper part of the screen.

NOTE

The function of **Time Offset** on the softkey is the same as that of the **Start/Center** key.

You can apply the setting values of sweep start time, sweep time, and reference position for the frequency transient (Wide Band) measurement trace to the frequency transient (Narrow Band) by pressing **Start/Center** - **Wide Settings -> Narrow**.

Basic Measurement Using E5052A
Transient Measurement in Transient Measurement Mode

Setting Average Function

Follow the steps below to use the averaging function.

- Step 1.** Press **Avg/BW** - **Avg Factor**.
- Step 2.** Enter the number of times for averaging in the data entry field that appears in the upper part of the screen.
- Step 3.** **Avg/BW** - Press **Averaging** to turn on the averaging function.

About DC Voltage Setting and Protection

You can specify DC power/control that will be applied to the DUT. Refer to “Setting DC power/DC control and protection” on page 86 for the setting procedure.

Setting Trigger

- Step 1.** Press **Trigger** - **Source**.
- Step 2.** Select the trigger source from the softkey menu list. The available options are as follows. Internal is selected by default.

Table 4-23

Trigger Source List

Softkey	Overview
Internal	Sets trigger source to internal continuous trigger
External*1	Sets trigger source to external trigger input connector
Manual	Sets trigger source to manual operation
Bus	Sets trigger source to the bus; the trigger signal is issued by the trigger command via GPIB interface or LAN.
Wide Video*2	Sets trigger source to Wide Video
Narrow Video*2	Sets trigger source to Narrow Video

*1. If External is selected for the trigger source, the trigger signal must be provided by an external instrument. Refer to “Setting External Trigger” on page 137 for the setting procedure.

*2. When you select either Wide Video or Narrow Video for the trigger source, you must set up the video trigger. Refer to “Setting Video Trigger” on page 135 for the setting procedure.

- Step 3.** Press **Trigger** - **Trigger to Transient** to send a trigger to the transient measurement. By default, **Continuous** is selected for sweep.

NOTE

The E5052A has four measurement functions: phase noise measurement, spectrum monitor measurement, frequency/power measurement, and transient measurement. Because individual measurements differ in characteristics from one another, each of the E5052A’s trigger is used exclusively for a single measurement function.

In other words, only one measurement function can be triggered at a time, and only this

_____ function can perform measurement at this time.

NOTE When trigger by using the SCPI command, it is needed to trigger after taking a certain latency time at trigger wait state if trigger source is selected “External”, “Wide Video” or “Narrow Video”.

Setting Averaging Trigger

Follow the steps below to use the averaging trigger.

Step 1. Press **Trigger** - **Average Trigger** to toggle on/off the averaging trigger.

When the averaging trigger is set to on, a single activation of the trigger system can perform the number of measurements set by the user as the averaging factor.

The following table shows how this function works by pressing **Trigger** - **Single** when the averaging trigger is on and off.

Averaging Trigger	Operation
ON	Executes state transitions among Waiting for Trigger, Trigger, and Measurement for the number of times set for averaging and then changes to the Hold state.
OFF	Enters Waiting for Trigger state once and then changes to the Hold state after measurement is completed.

NOTE The averaging function (“Setting Average Function” on page 84) must be set before enabling the averaging trigger.

Setting Video Trigger

You must set up the video trigger when you select either **Wide Video** or **Narrow Video** for the trigger source. You do not have to set up the video trigger when you select other trigger sources.

Follow the steps below to set up the video trigger for the transient measurement.

Setting Video Trigger (Wide Band)

Step 1. Press **Setup** - **Video Trigger - Wide Freq.**

Step 2. Enter the center frequency of the video trigger in the data entry field that appears in the upper part of the screen.

NOTE This setting is restricted by the settings of frequency band or maximum frequency of the input signal.

The setting is enabled when you select **Wide Video** from the trigger source options.

Basic Measurement Using E5052A
Transient Measurement in Transient Measurement Mode

Setting Video Trigger (Narrow Band)

- Step 1.** Press - **Video Trigger - Narrow Freq.**
- Step 2.** Enter the center frequency of the video trigger in the data entry field that appears in the upper part of the screen.
- Step 3.** Press - **Video Trigger - Minimum Power Level.**
- Step 4.** Enter the minimum power level of the video trigger in the data entry field that appears in the upper part of the screen.

NOTE

This setting is restricted to the range of Narrow Band measurement that is determined by the target frequency and frequency range.

The setting is enabled when you select **Narrow Video** from the trigger source options.

Setting External Trigger

When the trigger source is set to External, the input signal is regarded as the start trigger of measurement, which is transmitted to the external trigger input connector (Ext Trig) from the external instruments. When the connector detects more than 20 us of pulse transition upward or downward, a measurement starts. A TTL compatible signal is used as the trigger signal.

Follow the steps below to set up the external trigger.

Connecting to the External Trigger Input Connector

Connect the trigger output connector of the external instrument to the E5052A's EXT TRIG connector on the rear panel.

Selecting Trigger Source

- Step 1.** Press **Trigger** - **Source**.
- Step 2.** Select **External** from the softkey menu list.
- Step 3.** Press **Trigger** - **Ext Trig Polarity** to select the polarity of the external trigger. You can select either **Positive** (upward) or **Negative** (downward).

Confirming the result of frequency transient (Wide Band) measurement

Follow the steps below to confirm the results of the DUT’s frequency transient (Wide Band) measurement, using the E5052A’s transient measurement window.

Selecting Frequency Transient (Wide Band) Measurement Trace

- Step 1.** Press the **Trace Next** key to select the measurement trace for the frequency transient (Wide Band). You can confirm which trace is selected by viewing the cursor displayed to the left of the trace title.

NOTE

You can also click on the measurement trace of the frequency transient (Wide Band) for confirmation.

Setting Frequency Format and Sensitivity Aperture

You can select the unit (frequency format) used in the frequency trace screen and set the sensitivity aperture.

- Step 1.** Press **Format** - **Frequency Format**.
- Step 2.** Select an appropriate frequency format from the softkey menu list. The available options are as follows. The initial setting is “Hz”.

Table 4-24

Format List

Softkey	Overview
Hz	Displays the measurement frequency data.
ΔHz	Displays the difference subtracted from reference frequency.
%	Displays the difference subtracted from reference frequency in per cent.
ppm	Displays the difference subtracted from reference frequency in ppm.

- Step 3.** Press **Format** - **Frequency Reference**. (This setting will be used when either “Hz”, “%”, “ppm” is selected for the frequency format.)
- Step 4.** Enter the frequency reference value in the data entry field that appears in the upper part of the screen. The unit is Hz.

Setting Scale of Measurement Trace (manual setting)

Follow the steps below to set the scale of the measurement trace manually.

- Step 1.** Press **Scale** - **Divisions**.
- Step 2.** Enter the number of divisions by scale for the y-axis in the data entry field that appears in the upper part of the screen.
- Step 3.** Press **Display** - **Y # of Digits**.
- Step 4.** Select the number of digits for Y-axis in the softkey menu. Available options are 4-digits, 8-digits, and 12-digits.

NOTE

Set the number of digits for Y-axis display for each measurement mode. Therefore, when the number of digits for Y-axis display is changed in the frequency transient (wide band) measurement, those for frequency transient (narrow band) measurement, power transient measurement and phase transient measurement are also automatically changed.

Step 5. Press **[Scale]** - **Reference Position**.

Step 6. Enter the position of the scale reference line in the data entry field that appears in the upper part of the screen.

The position of the scale reference line must be specified by any of the numbers assigned to the y-axis scale, from 0 (minimum scale) to the number of divisions (maximum scale).

Step 7. Press **[Scale]** - **Reference Value**.

Step 8. Enter the value of the scale reference line in the data entry field that appears in the upper part of the screen. The unit is Hz.

Step 9. Press **[Scale]** - **Scale/Div**.

Step 10. Enter the value per scale in the data entry field that appears in the upper part of the screen. The unit is Hz/Div.

Setting Scale of Measurement Trace (automatic setting)

Follow the steps below to set the scale of the measurement trace automatically.

Step 1. Press **[Scale]** - **Auto Scale**.

NOTE

If you want the scale setting to be performed automatically for all four measurement traces (frequency transient (Wide Band and Narrow Band), power transient and phase transient), press **[Scale]** - **Auto Scale All**.

Setting Trace Offset (manual setting)

You can add an offset value to the displayed trace. Follow the steps below.

Step 1. Press **[Format]** - **Offset**

Step 2. Enter the offset value to be added to the trace in the data entry field that appears in the upper part of the screen. Hz is used as a unit.

Setting Trace Offset (Y-axis marker setting)

When the marker is displayed, the value of the active marker is used as the offset value. The procedure is as follows.

Step 1. Move the active marker to the position of the measurement value that you want to set as the reference

Step 2. Press **[Format]** - **Marker -> -Offset**

NOTE

Even when the reference marker mode is on and the active marker displays a Δ value, the value of the active marker is used as the offset value.

Basic Measurement Using E5052A

Transient Measurement in Transient Measurement Mode

When the offset value has already been set, that value is overwritten.

When an active marker does not exist, this function is not available.

Setting X-axis Scale (manual setting)

Follow the steps below to set the maximum/minimum display values of the x-axis. This is used when you want to enlarge a part of the displayed trace.

- Step 1.** Press **[Scale]** - **X axis - Auto** to turn off the auto adjustment of the x-axis scale.
- Step 2.** Press **[Scale]** - **X axis - Left**
- Step 3.** Enter the display start value of the x-axis in the data entry field that appears in the upper part of the screen. s (sec.) is used as a unit.
- Step 4.** Press **[Scale]** - **X axis - Right**
- Step 5.** Enter the display stop value of the x-axis in the data entry field that appears in the upper part of the screen. s (sec.) is used as a unit.

NOTE

When you want to restore the display's original start/stop values, press **[Scale]** - **X axis - Auto** to turn on the auto adjustment of the x-axis scale.

Setting X-axis Scale (x-axis band marker setting)

When the band marker of the x-axis is displayed, the x-axis scale can be adjusted to the band marker setting. The procedure is as follows.

- Step 1.** Press **[Scale]** - **X axis - Band Marker -> X Axis**

Setting Attenuator

When the input level is very high, a message may appear to prompt you to adjust the attenuator. In this case, follow the steps below to adjust the attenuator.

- Step 1.** Press **[Attn]** - **Input Attenuator** to enter the attenuator value in the data entry field that appears in the upper part of the screen.

You can select the value from the options: 0 dB, 5 dB, 10 dB, 15 dB, 20 dB, 25 dB, 30 dB or 35 dB. The appropriate input level is between 0 and 5 dBm, depending on the type of measurements or the characteristics of the DUT. Adjust the attenuator so that the input level of the RF port approximates this range.

NOTE

When the downconverter is turned on, the RF input is set to Down converter, and the external mixer is set to Not Used, the attenuator value is fixed to 10 dB.

Setting Smoothing

You can use the smoothing function to reduce the trace noise. Follow the steps below.

- Step 1.** Press **[Trace/View]** - **Aperture**.
- Step 2.** Enter the value of the smoothing aperture (%) in the data entry field that appears in the upper part of the screen.

Step 3. Press **Trace/View** - **Smoothing** to turn on the smoothing function.

Confirming Measurement Points by Markers

Step 1. Press **Marker** to display marker 1 on the screen.

Step 2. Move marker 1 to the point you want to confirm and read the measurement value displayed in the upper part of the graph. To confirm multiple values, press **Marker** - **Marker x (x=1 to 10)**, which allows you to display up to marker 10.

Figure 4-13

Example of Measurement Screen (frequency transient wide band)

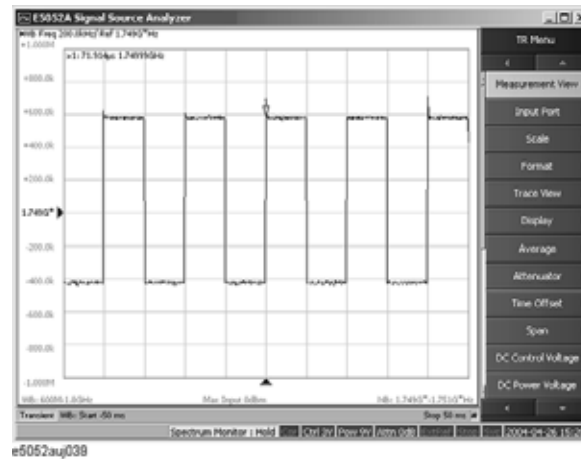

Confirming Result of Frequency Transient (Narrow Band) Measurement

Follow the steps below to confirm the results of the DUT's frequency transient (Narrow Band) measurement by using the E5052A's transient measurement window.

Selecting Frequency Transient (Narrow Band) Measurement Trace

- Step 1.** Press the **Trace Next** key to select the measurement trace for the frequency transient (Narrow Band). You can confirm which trace is selected by viewing the cursor which is displayed in the left to the trace title.

NOTE

You can also click on the measurement trace of the frequency transient (Narrow Band) for confirmation.

Setting Frequency Format and Sensitivity Aperture

You can select the unit (frequency format) used in the frequency trace screen and set the sensitivity aperture.

- Step 1.** Press **Format** - **Frequency Format**.
- Step 2.** Select an appropriate frequency format from the softkey menu list. The available options are as follows. The initial setting is "Hz".

Table 4-25

Format list

Softkey	Overview
Hz	Displays the measurement frequency data.
ΔHz	Displays the difference subtracted from reference frequency.
%	Displays the difference subtracted from reference frequency in per cent.
ppm	Displays the difference subtracted from reference frequency in ppm.

- Step 3.** Press **Format** - **Frequency Reference**. (This setting will be used when either "ΔHz", "%", "ppm" is selected for the frequency format.)
- Step 4.** Enter the frequency reference value in the data entry field that appears in the upper part of the screen. The unit is Hz.

Setting Scale of Measurement Trace (manual setting)

Follow the steps below to set the scale of the measurement trace manually.

- Step 1.** Press **Scale** - **Divisions**.
- Step 2.** Enter the number of divisions by scale for the y-axis in the data entry field that appears in the upper part of the screen.
- Step 3.** Press **Display** - **Y # of Digits**.
- Step 4.** Select the number of digits for Y-axis in the softkey menu. Available options are 4-digits, 8-digits, and 12-digits.

NOTE

Set the number of digits for Y-axis display for each measurement mode. Therefore, when the number of digits for Y-axis display is changed in the frequency transient (narrow band) measurement, those for the frequency transient (wide band) measurement, power transient measurement and phase transient measurement are also automatically changed.

Step 5. Press **Scale** - **Reference Position**.

Step 6. Enter the position of the scale reference line in the data entry field that appears in the upper part of the screen. The position of the scale reference line must be specified by any of the numbers assigned to the y-axis scale, from 0 (minimum scale) to the number of divisions (maximum scale).

Step 7. Press **Scale** - **Reference Value**.

Step 8. Enter the value of the scale reference line in the data entry field that appears in the upper part of the screen. The unit is Hz.

Step 9. Press **Scale** - **Scale/Div**.

Step 10. Enter the value per scale in the data entry field that appears in the upper part of the screen. The unit is Hz/Div.

Setting Scale of Measurement Trace (automatic setting)

Follow the steps below to set the scale of the measurement trace automatically.

Step 1. Press **Scale** - **Auto Scale**.

NOTE

If you want the scale setting to be performed automatically for all four measurement traces (frequency transient (Wide Band and Narrow Band), power transient and phase transient), press **Scale** - **Auto Scale All**.

Setting Trace Offset (manual setting)

You can add an offset value to the displayed trace. Follow the steps below.

Step 1. Press **Format** - **Offset**

Step 2. Enter the offset value to be added to the trace in the data entry field that appears in the upper part of the screen. Hz is used as a unit.

Setting Trace Offset (Y-axis marker setting)

When the marker is displayed, the value of the active marker is used as the offset value. Procedure is as follows.

Step 1. Move the active marker to the position of the measurement value that you want to set as the reference

Step 2. Press **Format** - **Marker -> -Offset**

NOTE

Even when the reference marker mode is on and the active marker displays a Δ value, the value of the active marker is used as the offset value.

When the offset value has already been set, that value is overwritten.

Basic Measurement Using E5052A

Transient Measurement in Transient Measurement Mode

When an active marker does not exist, this function is not available.

Setting X-axis Scale (manual setting)

Follow the steps below to set the maximum/minimum display values of the x-axis. This is used when you want to enlarge a part of the displayed trace.

- Step 1.** Press **[Scale]** - **X axis - Auto** to turn off the auto adjustment of the x-axis scale.
- Step 2.** Press **[Scale]** - **X axis - Left**
- Step 3.** Enter the display start value of the x-axis in the data entry field that appears in the upper part of the screen. s (sec.) is used as a unit.
- Step 4.** Press **[Scale]** - **X axis - Right**
- Step 5.** Enter the display stop value of the x-axis in the data entry field that appears in the upper part of the screen. s (sec.) is used as a unit.

NOTE

When you want to restore the display's original start/stop values, press **[Scale]** - **X axis - Auto** to turn on the auto adjustment of the x-axis scale.

Setting X-axis Scale (x-axis band marker setting)

When the band marker of the x-axis is displayed, the x-axis scale can be adjusted to the band marker setting. The procedure is as follows.

- Step 1.** Press **[Scale]** - **X axis - Band Marker -> X Axis**

Setting Attenuator

When the input level is very high, a message may appear to prompt you to adjust the attenuator. In this case, follow the steps below to adjust the attenuator.

- Step 1.** Press **[Attn]** - **Input Attenuator** to enter the attenuator value in the data entry field that appears in the upper part of the screen.

You can select the value from the options: 0 dB, 5 dB, 10 dB, 15 dB, 20 dB, 25 dB, 30 dB or 35 dB. The appropriate input level is between 0 and 5 dBm, depending on the type of measurements or the characteristics of DUT. Adjust the attenuator so that the input level of the RF port approximates this range.

NOTE

When the downconverter is turned on, the RF input is set to Down converter, and the external mixer is set to Not Used, the attenuator value is fixed to 10 dB.

Setting Smoothing

You can use the smoothing function to reduce the trace noise. Follow the steps below.

- Step 1.** Press **[Trace/View]** - **Aperture**.
- Step 2.** Enter the value of the smoothing aperture (%) in the data entry field that appears in the upper part of the screen.
- Step 3.** Press **[Trace/View]** - **Smoothing** to turn on the smoothing function.

Confirming Measurement Points by Markers

- Step 1.** Press **Marker** to display marker 1 on the screen.
- Step 2.** Move marker 1 to the point you want to confirm and read the measurement value displayed in the upper part of the graph. To confirm multiple values, press **Marker** - **Marker x (x=1 to 10)**, which allows you to display up to marker 10.

Figure 4-14

Example of Measurement Screen (frequency transient narrow band)

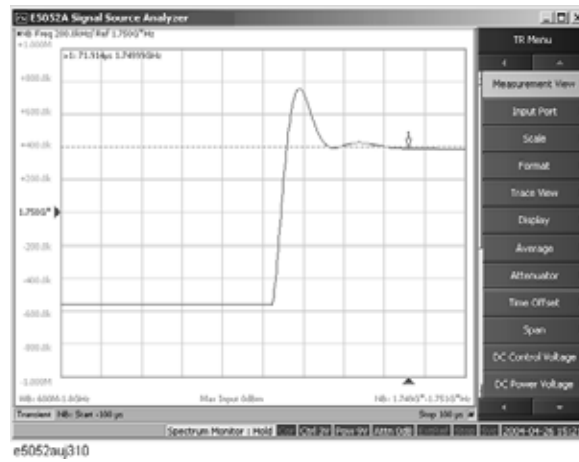

Confirming Result of Power Transient Measurement

Follow the steps below to confirm the results of the DUT's power transient measurement by using the E5052A's transient measurement window.

Selecting Power Transient Measurement Trace

- Step 1.** Press the **Trace Next** key to select the power transient measurement trace. You can confirm which trace is selected by viewing the cursor that is displayed to the left of the trace title.

NOTE

You can also click on the measurement trace of the power transient for confirmation.

Setting Scale of Measurement Trace (manual setting)

Follow the steps below to set the scale of the measurement trace manually.

- Step 1.** Press **Scale** - **Divisions**.
- Step 2.** Enter the number of divisions by scale for the y-axis in the data entry field that appears in the upper part of the screen.
- Step 3.** Press **Display** - **Y # of Digits**.
- Step 4.** Select the number of digits for Y-axis in the softkey menu. Available options are 4-digits, 8-digits, and 12-digits.

NOTE

Set the number of digits for Y-axis display for each measurement mode. Therefore, when the number of digits for Y-axis is changed in the power transient measurement, those for the frequency transient (wide band) measurement, frequency transient (narrow band) measurement, and phase transient measurement are also automatically changed.

- Step 5.** Press **Scale** - **Reference Position**.
- Step 6.** Enter the position of the scale reference line in the data entry field that appears in the upper part of the screen.
- The position of the scale reference line must be specified by any of the numbers assigned to the y-axis scale, from 0 (minimum scale) to the number of divisions (max scale).
- Step 7.** Press **Scale** - **Reference Value**.
- Step 8.** Enter the value of the scale reference line in the data entry field that appears in the upper part of the screen. The unit is dBm.
- Step 9.** Press **Scale** - **Scale/Div**.
- Step 10.** Enter the value per scale in the data entry field that appears in the upper part of the screen. The unit is dB/Div.

Setting Scale of Measurement Trace (automatic setting)

Follow the steps below to set the scale of the measurement trace automatically.

- Step 1.** Press **Scale** - **Auto Scale**.

NOTE If you want the scale setting to be performed automatically for all four measurement traces (frequency transient (Wide Band and Narrow Band), power transient and phase transient), press **[Scale]** - **Auto Scale All**.

Setting Trace Offset (manual setting)

You can add an offset value to the displayed trace. Follow the steps below.

- Step 1.** Press **[Format]** - **Offset**
- Step 2.** Enter the offset value to be added to the trace in the data entry field that appears in the upper part of the screen. dBm is used as a unit.

Setting Trace Offset (Y-axis marker setting)

When the marker is displayed, the value of the active marker is used as the offset value. The procedure is as follows.

- Step 1.** Move the active marker to the position of the measurement value that you want to set as the reference
- Step 2.** Press **[Format]** - **Marker -> -Offset**

NOTE Even when the reference marker mode is on and the active marker displays a Δ value, the value of the active marker is used as the offset value.

When the offset value has already been set, that value is overwritten.

When an active marker does not exist, this function is not available.

Setting X-axis Scale (manual setting)

Follow the steps below to set the maximum/minimum display values of the x-axis. This is used when you want to enlarge a part of the displayed trace.

- Step 1.** Press **[Scale]** - **X axis - Auto** to turn off the auto adjustment of the x-axis scale.
- Step 2.** Press **[Scale]** - **X axis - Left**
- Step 3.** Enter the display start value of the x-axis in the data entry field that appears in the upper part of the screen. s (sec.) is used as a unit.
- Step 4.** Press **[Scale]** - **X axis - Right**
- Step 5.** Enter the display stop value of the x-axis in the data entry field that appears in the upper part of the screen. s (sec.) is used as a unit.

NOTE When you want to restore the display's original start/stop values, press **[Scale]** - **X axis - Auto** to turn on the auto adjustment of the x-axis scale.

Setting X-axis Scale (x-axis band marker setting)

When the band marker of the x-axis is displayed, the x-axis scale can be adjusted to the band marker setting. The procedure is as follows.

Basic Measurement Using E5052A Transient Measurement in Transient Measurement Mode

Step 1. Press **Scale** - X axis - **Band Marker** -> X Axis

Setting Attenuator

When the input level is very high, a message may appear to prompt you to adjust the attenuator. In this case, follow the steps below to adjust the attenuator.

Step 1. Press **Attn** - **Input Attenuator** to enter the attenuator value in the data entry field that appears in the upper part of the screen.

You can select the value from the options: 0 dB, 5 dB, 10 dB, 15 dB, 20 dB, 25 dB, 30 dB or 35 dB. The appropriate input level is between 0 and 5 dBm, depending on the type of measurement or the characteristics of the DUT. Adjust the attenuator so that the input level of the RF port approximates this range.

NOTE

When the downconverter is turned on, the RF input is set to Down converter, and the external mixer is set to Not Used, the attenuator value is fixed to 10 dB.

Setting Smoothing

You can use the smoothing function to reduce the trace noise. Follow the steps below.

Step 1. Press **Trace/View** - **Aperture**.

Step 2. Enter the value of the smoothing aperture (%) in the data entry field that appears in the upper part of the screen.

Step 3. Press **Trace/View** - **Smoothing** to turn on the smoothing function.

Confirming Measurement Points by Markers

Step 1. Press **Marker** to display marker 1 on the screen.

Step 2. Move marker 1 to the point you want to confirm and read the measurement value displayed in the upper part of the graph. To confirm multiple values, press **Marker** - **Marker x (x=1 to 10)**, which allows you to display up to marker 10.

Figure 4-15

Example of Measurement Screen (power transient)

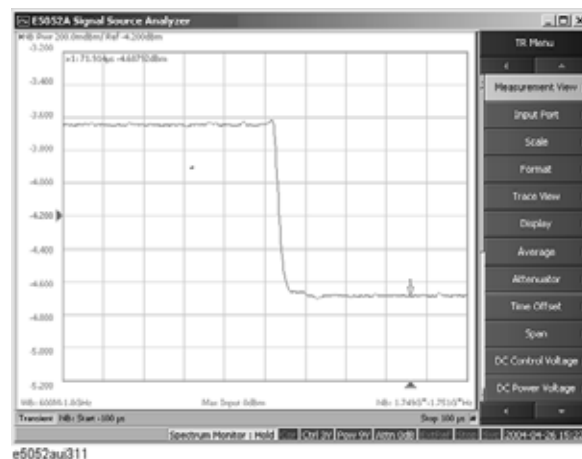

Confirming the phase transient measurement

Follow the steps below to confirm the results of the DUT's phase transient measurement by using the E5052A's transient measurement window.

Selecting Phase Transient Trace

- Step 1.** Press the **Trace Next** key to select the phase transient measurement trace. You can confirm which measurement trace is selected by viewing the cursor that is displayed to the left of the trace title.

NOTE

You can also click on the phase transient measurement trace for confirmation.

Using the phase reference frequency

The instrument calculates the phase deviation within the Narrow Band measurement range based on the frequency transient (Narrow Band) measurement result. The phase reference function sets the reference value of frequency to calculate the phase transient.

In case the target frequency is equal to the final frequency (the right most measurement data obtained in the frequency transient (Narrow Band) measurement) of the DUT, it can be used as the phase reference frequency. If the target frequency is deviated from the final frequency of the DUT, use the actual frequency measured at the right end of measurement point as set the phase reference frequency. Then the phase data over time starts from zero at the right end of the measurement point, and the phase data maintains as long as the measured frequency stays at the phase reference frequency.

- Step 1.** Press **Setup** - **Phase Reference**.
- Step 2.** Enter the phase reference value, then measure the phase transient data again.

Figure 4-16

Defining Phase Reference Frequency

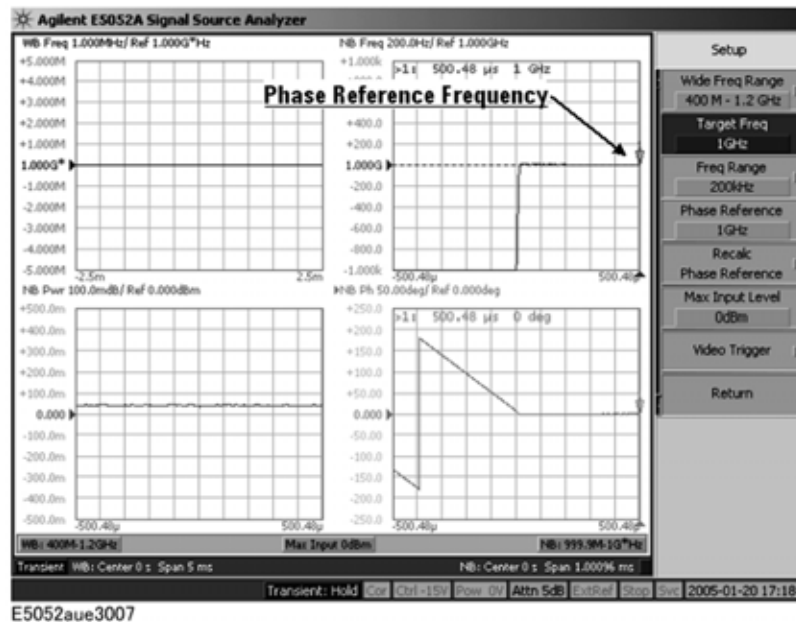

4. Basic Measurement Using E5052A

Basic Measurement Using E5052A Transient Measurement in Transient Measurement Mode

NOTE

The phase reference frequency is restricted to the range of Narrow Band measurement that is determined by the target frequency and frequency range.

The **Marker -> Phase Reference** function automatically sets the phase reference frequency based on the actual frequency data where the active marker is located at the frequency over time trace.

Adjust Phase Reference by Specifying Value of X-axis

You can set the measurement value of the x-axis value you specified to the phase reference (phase 0). Follow the steps below.

Step 1. Press **[Format]** - **Phase X Reference**

Step 2. Enter the x-axis value (position) set as the phase reference in the data entry field that appears in the upper part of the screen.

You can also use the marker. Move the marker to the position of the phase reference and press **[Format]** - **Marker -> Phase X Reference**

Using Phase Offset Frequency When Adjusting Phase Baseline Manually

If the actual measured frequency is different from the phase reference frequency you set, the recal phase reference function also allows you to adjust the baseline of the phase transient data manually after a single measurement.

Step 1. Press **[Setup]** - **Recalc Phase Reference.**

Step 2. Press Phase Ref. Offset to enter the offset frequency value relative to the phase reference frequency, and then the baseline of the phase transient data will be adjusted.

Figure 4-17

Using Recalculating Phase Data Function to Adjust Baseline of Phase Transient

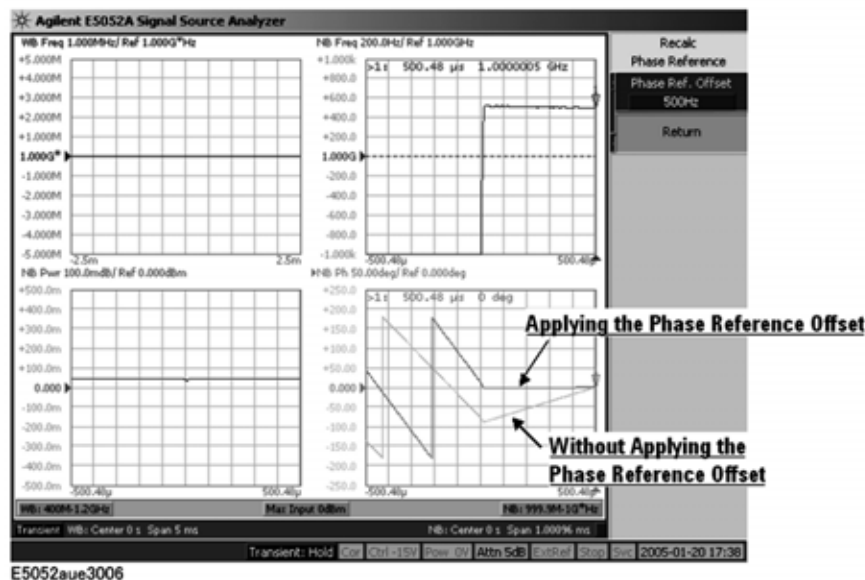

Setting Phase Unit and Wrap Phase

You can select the unit (phase unit) used in the phase transient measurement trace screen and specify the wrap phase.

- Step 1.** Press **Format** - **Phase Unit**.
- Step 2.** Select the appropriate format from the softkey menu list. You can select any of the three options: Deg, Rad or Grad.
- Step 3.** Press **Format** - **Wrap Phase** to turn on/off the wrap phase function.

Setting Scale of Measurement Trace (manual setting)

Follow the steps below to set the scale of the measurement trace manually.

- Step 1.** Press **Scale** - **Divisions**.
- Step 2.** Enter the number of divisions by scale for the y-axis in the data entry field that appears in the upper part of the screen.
- Step 3.** Press **Display** - **Y # of Digits**.
- Step 4.** Select the number of digits for Y-axis in the softkey menu. Available options are 4-digits, 8-digits, and 12-digits.

NOTE

Set the number of digits for Y-axis display for each measurement mode. Therefore, when the number of digits for Y-axis is changed in the phase transient measurement, those for the frequency transient (wide band) measurement, frequency transient (narrow band) measurement, and power transient measurement are also automatically changed.

- Step 5.** Press **Scale** - **Reference Position**.
- Step 6.** Enter the position of the scale reference line in the data entry field that appears in the upper part of the screen.

The position of the scale reference line must be specified by any of the numbers assigned to the y-axis scale, from 0 (minimum scale) to the number of divisions (maximum scale).
- Step 7.** Press **Scale** - **Reference Value**.
- Step 8.** Enter the value of the scale reference line in the data entry field that appears in the upper part of the screen. The unit varies depending on the format setting.
- Step 9.** Press **Scale** - **Scale/Div**.
- Step 10.** Enter the value per scale in the data entry field that appears in the upper part of the screen. The unit varies depending on the format setting.

Basic Measurement Using E5052A

Transient Measurement in Transient Measurement Mode

Setting Scale of Measurement Trace (automatic setting)

Follow the steps below to set the scale of the measurement trace automatically.

Step 1. Press **[Scale]** - **Auto Scale**.

NOTE

If you want the scale setting to be performed automatically for all four measurement traces (frequency transient (Wide Band and Narrow Band), power transient and phase transient), press **[Scale]** - **Auto Scale All**.

Setting Trace Offset (manual setting)

You can add an offset value to the displayed trace. Follow the steps below.

Step 1. Press **[Format]** - **Offset**

Step 2. Enter the offset value to be added to the trace in the data entry field that appears in the upper part of the screen. The unit varies depending on the format setting.

Setting Trace Offset (Y-axis marker setting)

When the marker is displayed, the value of the active marker is used as the offset value. The procedure is as follows.

Step 1. Move the active marker to the position of the measurement value that you want to set as the reference

Step 2. Press **[Format]** - **Marker -> -Offset**

NOTE

Even when the reference marker mode is on and the active marker displays a Δ value, the value of the active marker is used as the offset value.

When the offset value has already been set, that value is overwritten.

When an active marker does not exist, this function is not available.

Setting X-axis Scale (manual setting)

Follow the steps below to set the maximum/minimum display values of the x-axis. This is used when you want to enlarge a part of the displayed trace.

Step 1. Press **[Scale]** - **X axis - Auto** to turn off the auto adjustment of the x-axis scale.

Step 2. Press **[Scale]** - **X axis - Left**

Step 3. Enter the display start value of the x-axis in the data entry field that appears in the upper part of the screen. s (sec.) is used as a unit.

Step 4. Press **[Scale]** - **X axis - Right**

Step 5. Enter the display stop value of the x-axis in the data entry field that appears in the upper part of the screen. s (sec.) is used as a unit.

NOTE

When you want to restore the display's original start/stop values, press **[Scale]** - **X axis - Auto** to turn on the auto adjustment of the x-axis scale.

Setting X-axis Scale (x-axis band marker setting)

When the band marker of the x-axis is displayed, the x-axis scale can be adjusted to the band marker setting. The procedure is as follows.

Step 1. Press **[Scale]** - **X axis - Band Marker -> X Axis**

Setting Attenuator

When the input level is very high, a message may appear to prompt you to adjust the attenuator. In this case, follow the steps below to adjust the attenuator.

Step 1. Press **[Attn]** - **Input Attenuator** to enter the attenuator value in the data entry field that appears in the upper part of the screen.

You can select the value from the options: 0 dB, 5 dB, 10 dB, 15 dB, 20 dB, 25 dB, 30 dB or 35 dB. The appropriate input level is between 0 and 5 dBm, depending on the type of measurement or the characteristics of the DUT. Adjust the attenuator so that the input level of the RF port approximates this range.

NOTE

When the downconverter is turned on, the RF input is set to Downconverter, and the external mixer is set to Not Used, the attenuator value is fixed to 10 dB.

Setting Smoothing

You can use the smoothing function to reduce the trace noise. Follow the steps below.

Step 1. Press **[Trace/View]** - **Aperture**.

Step 2. Enter the value of the smoothing aperture (%) in the data entry field that appears in the upper part of the screen.

Step 3. Press **[Trace/View]** - **Smoothing** to turn on the smoothing function.

Confirming Measurement Points by Markers

Step 1. Press **[Marker]** to display marker 1 on the screen.

Step 2. Move marker 1 to the point you want to confirm and read the measurement value displayed in the upper part of the graph. To confirm multiple values, press **[Marker]** - **Marker x (x=1 to 10)**, which allows you to display up to marker 10.

Basic Measurement Using E5052A
Transient Measurement in Transient Measurement Mode

Figure 4-18 Example of Measurement Screen (phase transient)

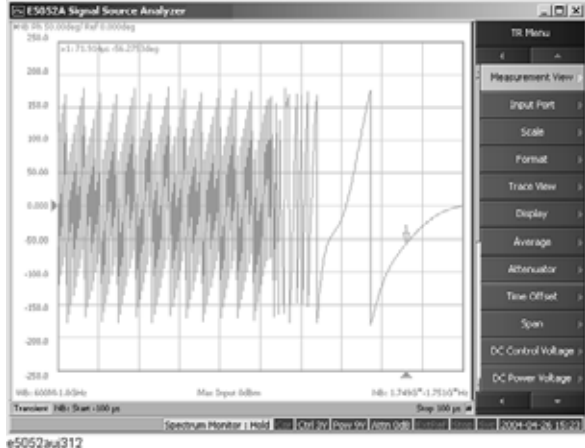

User Calibration

Overview of User Calibration

User calibration is a function to correct the power value using correction data set for the following measurement results.

Measurement Mode	Measurement Value to be Corrected
Phase noise	Carrier signal level
Spectrum monitor	Measurement value (array)
Frequency/power measurement	Power measurement value (array) ^{*1}
Transient measurement	Power measurement value (array)

*1. The result of tester mode is included.

Setting User Calibration Function

Loading Correction Data From CSV File

Load a correction data file written in CSV format to the E5052A. Follow these steps.

- Step 1.** Press **[System]** - **Instrument Setup** - **Correction** - **Import Power Correction Table**.
- Step 2.** Select a correction data file you want to load from the softkey file list.

CSV files (extension:.csv) in the surgical folder in the F: drive are listed as softkeys.

NOTE

To load a correction data file from a floppy disk, other media, or another folder, follow these steps.

- Step 1.** Press **[System]** - **Instrument Setup** - **Correction** - **File Dialog**
- Step 2.** Select a correction data file you want to load from the file dialog box.

Turning On/Off User Correction Function

Reflect the loaded correction data. Follow these steps.

- Step 1.** Press **[System]** - **Instrument Setup** - **Correction**.
- Step 2.** Press **Power Correction** to turn on the user calibration function for correction data.

Format of the correction data file

Correction data files must be written in CSV format.

Writing Correction Data File

Write a frequency value and a correction value for the frequency with a comma (,)

Basic Measurement Using E5052A User Calibration

separator. Deal them as a pair, and write pairs for all correction points with comma separators.

Line break characters are recognized as data separators in the same way as commas. Therefore, two formats as shown below are available: writing pairs in a single line, or writing a pair of a frequency value and a correction value in each line.

Write frequencies in Hz, and correction values in dB.

Example 4-1

Example of Data Written in Single Line

```
10E+6,0.04,100E+6,0.06,200E+6,0.07,300E+6,0.06
```

Example 4-2

Example of Data Written in Multiple Lines

```
10E+6,0.04  
100E+6,0.06  
200E+6,0.07  
300E+6,0.06
```

Restrictions on Writing

There are some restrictions on writing correction data files. They are:

1. The maximum number of data items is 1001. Data after that is ignored when loaded.
2. Lines that start with a pound sign (#) are skipped as comment lines. Data in those lines is not recognized.
3. Data must be written in the order from data for the smallest frequency to data for the largest. If data for a frequency equal to or smaller than the previous one is read, the read operation ends immediately. This does not cause any error, and the correction data immediately before the end of the read operation is reflected.

Correction Method

Power data correction is performed as follows. (The correction value is Corr shown below.)

Data after correction (dBm) = data before correction (dBm) + Corr (dB)

If the power data frequency to be corrected is smaller than the minimum frequency in the loaded data, the correction coefficient for the minimum frequency is used for correction.

If the power data frequency to be corrected is greater than the maximum frequency in the loaded data, the correction coefficient for the maximum frequency is used for correction.

If the power data frequency to be corrected does not match any frequency in the loaded data, the correction coefficient obtained by linear interpolation of the nearest 2 points is used for correction.

In this case, a correction coefficient after linear interpolation (Corr') is used for calculation.

Data after correction (Watt) = data before correction (Watt) x correction value (Corr')

$Corr' = 10^{(Corr / 10)}$

NOTE

Note that correction is made before determining raw data. In other words, corrected values are stored as raw data. For more information on raw data, see “Internal data processing” written in “Chapter 4. Reading out/writing measurement data” of “Programmers Guide.”

5

Measurement Using E5053A and External Mixer

This chapter describes connection and settings when using the E5053A Microwave Downconverter, as well as those when using the external mixer. It also describes the frequency offset function.

E5053A Microwave Downconverter

This section described hardware configurations and setups when using the E5053A Microwave Downconverter with the E5052A.

Connection of E5052A and E5053A

Required Devices

Following devices are required when configuring the E5052A and E5053A Microwave Downconverter.

- E5052A
- E5053A Microwave Downconverter
- RF cables of 2 types × 2 (supplied with the E5053A, Agilent part number: E5053-61621, E5053-61622)
- USB cable (supplied with the E5053A, Agilent part number: 8121-0770)
- BNC cable (supplied with the E5053A, Agilent part number: 8120-1839)
- BNC adapter (supplied with the E5053A, Agilent part number: 1250-1859)

Connecting E5052A and E5053A Microwave Downconverter

Check the following connections on the rear panel before turning on both the E5052A and the E5053A, as shown in the Figure 5-1.

- USB Cable (PN: 8121-0770): Connecting the USB ports of both the E5052A and E5053A.
- BNC Cable (PN: 8120-1839): Connecting the E5052A internal reference signal output port (Ref Out) and the E5053A external reference signal input port (Ref In) of the channel 1.
- BNC Adaptor (PN: 1250-1859): Connecting the internal reference signal output port (Ref Out) of the channel 1 and the internal reference signal input port (Ref In) of the channel 2 of the E5053A rear panel.

Figure 5-1

Connection of the E5052A and the E5053A (rear view)

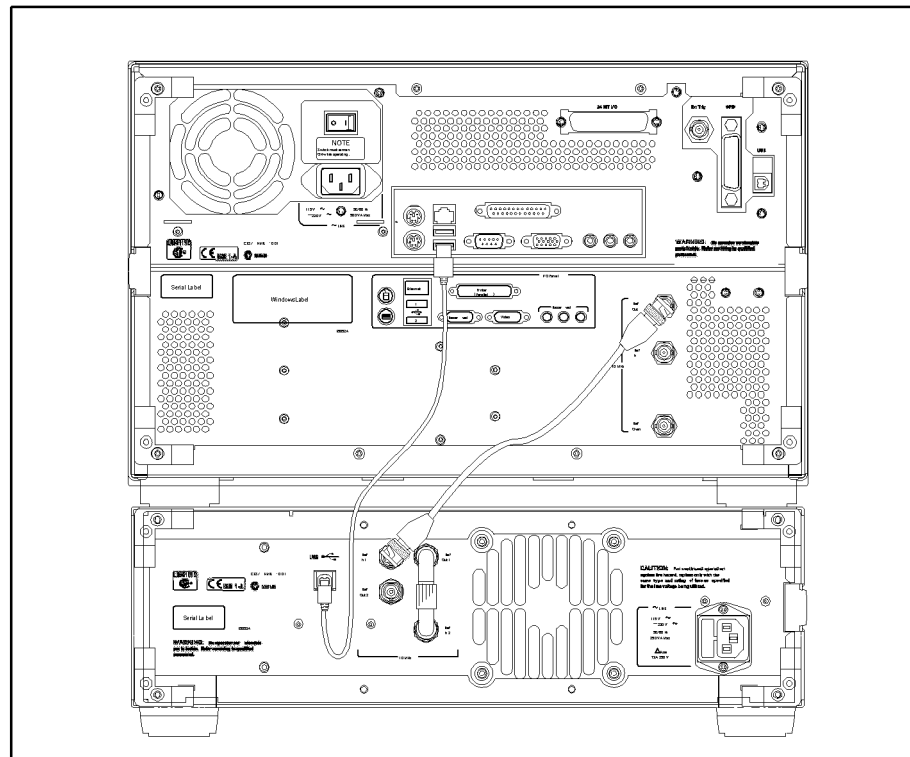

e5053auj1007

NOTE

Do not connect or disconnect the USB cable during the measurement.

Check the following connections on the front panel as shown in the Figure 5-2.

- RF Cable (PN: E5053-61621): Connecting the E5052A RF output ports and the E5053A RF input ports
- RF Cable (PN: E5053-61622): Connecting the E5052A RF input ports and the E5053A RF output ports

Measurement Using E5053A and External Mixer
E5053A Microwave Downconverter

NOTE

When mounting the E5053A and the E5052A with the rack mount kit, use the following RF cables.

- RF Cable (PN: E5053-61623): Connecting the E5052A RF output ports and the E5053A RF input ports
- RF Cable (PN: E5053-61624): Connecting the E5052A RF input ports and the E5053A RF output ports

Figure 5-2

Connection of E5052A and E5053A (front view)

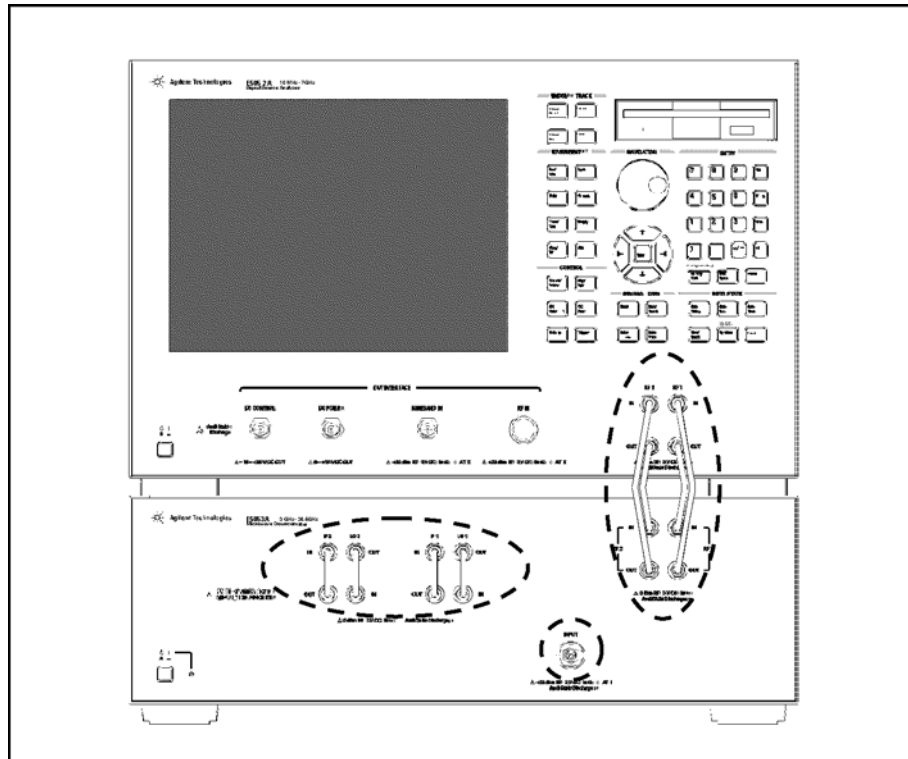

e5052auj5005

NOTE

Use the torque wrench when the semi-rigid cable or adapter is fastened on the following connectors of E5052A and E5053A. The recommended torque and open-ended wrenches are shown below.

Connector	Recommended Torque	Recommended Wrench
SMA	5.7 kgf-cm/ 56 N - cm/ 5 in-lb	Wrench PN 8710-1582
3.5 mm	9.2 kgf-cm/ 90 N - cm/ 8 in-lb	Wrench PN 8710-1765

Turning On E5053A Microwave Downconverter

Turn on the E5053A Microwave Downconverter first, and then turn on the E5052A.

The E5052A automatically detects the E5053A Microwave Downconverter whenever it is connected. If there's an auto recall file, the instrument state is also set along with the settings defined in the auto recall file.

NOTE

When the E5052A fails to detect the downconverter and you try to activate the E5053A Microwave Downconverter, “No downconverter unit connected” error message is displayed. In this case, the E5052A instrument state is initiated as the settings of the E5052A standalone by the firmware, even if there's an auto recall file that includes any instrument setups that relate the E5053A settings.

See also “Selecting Device Configuration” on page 165 for more information.

Device Configuration Using E5052A and E5053A Microwave Downconverter

Types of Device Configurations

There are 4 types of device configurations using the E5052A and the E5053A Microwave Downconverter including the standalone use of the E5052A: A-1, A-2, B, and C (Figure 5-3).

Figure 5-3 Device Configurations Using E5052A and E5053A

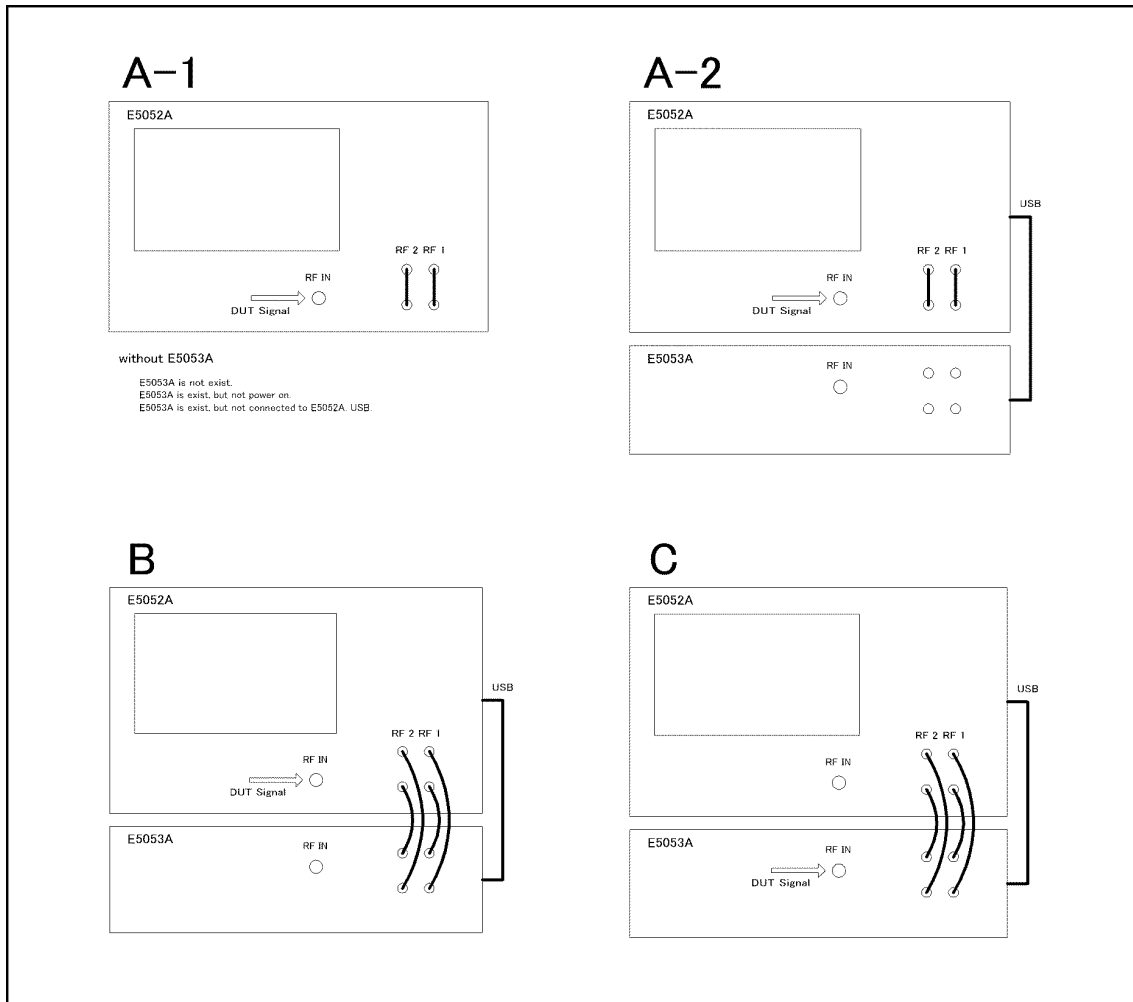

e5052auj4001

The device configurations of the E5052A and the E5053A Microwave Downconverter are classified by the following factors.

- Connection of the USB cable
- Input port for DUT signals (the RF IN port of the E5052A or the INPUT port of the E5053A)
- Connection of the RF1 and RF2 ports

NOTE

The device configuration A-1 (standalone use of the E5052A) includes the configuration where the E5053A Microwave Downconverter is not turned on and the configuration where no USB cable is connected.

Selecting Device Configuration

Following items should be specified in order to identify the device configuration: A (A-1, A-2), B, or C.

Downconverter	On/off
	<input type="checkbox"/> - Downconverter - Downconverter [ON OFF]
Input port for DUT signals	E5052A RF IN port/E5053A INPUT port
	<input type="checkbox"/> - Downconverter - RF Input - Downconverter E5052A Direct

The device configuration A-2 is a configuration where the E5053A Microwave Downconverter is turned on and the USB cable is connected, but the E5053A Microwave Downconverter is disabled by the firmware. The basic functions available with this configuration is the same as those in A-1.

The device configuration B is a configuration where the E5053A Microwave Downconverter is enabled by the firmware, and the input port for the DUT signals is set to the RF IN port of the E5052A.

The device configuration C is a configuration where the E5053A Microwave Downconverter is enabled by the firmware, and the input port for the DUT signals is set to the INPUT port of the E5053A.

Discrepancy Between Device Configuration and Setting

The firmware recognizes none of discrepancy between the device configuration and settings but connection of the USB cable. Therefore, the E5052A performs processing based on the firmware setting which could be different than actual connection of the input port for the DUT signals or connection of the RF1 and RF2 ports. In this case, measurement cannot be performed properly. In addition, an error may occur during measurement.

The connection of the USB cable is recognized by the firmware, therefore discrepancy in each configuration can be eliminated as described below.

- Configuration A-1 (when the E5053A Microwave Downconverter is not present)
You cannot activate the downconverter setting with the softkey. You can activate it by loading a configuration file with the downconverter setting enabled, but an error “No

Measurement Using E5053A and External Mixer E5053A Microwave Downconverter

downconverter unit connected.” appears.

To correct this error, deactivate the downconverter setting, or connect the E5053A Microwave Downconverter.

- Configurations A-2, B, and C (when the E5053A Microwave Downconverter is present)

When power-on the E5052A, connection is checked and the downconverter setting is automatically activated if the E5053A Microwave Downconverter is recognized. Note that, if Auto Recall is set, the setting loaded by the function will be used.

- When the E5053A Microwave Downconverter is added to the configuration

When the E5053A Microwave Downconverter is turned on (previously off) or the USB cable is connected (previously not connected), the downconverter setting remains disabled. It is not activated automatically. You need to activate the downconverter setting.

- When the E5053A Microwave Downconverter is removed from the configuration

When the E5053A Microwave Downconverter is present in the configuration and it is turned off or the USB cable is disconnected, the E5052A does no particular action if the downconverter setting is disabled. If the downconverter setting is activated, an error “No downconverter unit connected.” appears.

Take the same corrective action as that for configuration A-1.

Setting E5053A Microwave Downconverter

This section describes the differences of the settings when the E5053A Microwave Downconverter is used from that of the E5052A standalone operations.

Common to All Measurement Modes

1. Selecting the input port

The RF input port has to be selected first depending on the device configuration as well as the carrier frequency range. Selecting External Mixer ON is available only when “Downconverter ON” is selected AND “Downconverter” is selected in the RF Input menu.

- Downconverter - External Mixer - Not Used | ON

2. Setting of the attenuator

For the device configuration C in Figure 5-3 on page 164, the attenuator setting is fixed to 10 dB when the external mixer is off. For the device configurations A (A-1, A-2) and B and the device configuration C with the external mixer on, you can change the attenuator setting.

- Input Attenuator

Phase-noise Measurement

The following settings for phase-noise measurement mode differ from the settings when using the E5052A alone.

1. Setting of the carrier frequency band

Set the frequency band for the carrier frequency.

- Frequency Band - 10 M - 41 MHz | ... | 9 G - 26.5 GHz

Band 1	10 M - 41 MHz
Band 2	39 M - 101 MHz
Band 3	99 M - 1.5 GHz
Band 4	300 M - 7 GHz (300 M - 3 GHz)
Band 5	3 G - 10 GHz
Band 6	9 G - 26.5 GHz

For the device configuration A in Figure 5-3 on page 164, you can set Band 1 to Band 4. You cannot specify Band 5 and Band 6.

For the device configuration B, you can set Band 1 to Band 4. Note that the frequency range of Band 4 is changed to 300 M - 3 GHz. You cannot specify Band 5 and Band 6.

For the device configuration C, you can set Band 5 and Band 6 when the external mixer is off. You cannot specify Band 1 to Band 4.

NOTE

For the device configuration C with the external mixer ON, actual settings are dependent on the external mixer settings and/or the frequency function used. For more information, see “External Mixer” on page 178 and “Frequency Offset Function” on page 181.

2. Input of the nominal frequency

Set the nominal frequency of the carrier frequency.

Setup - **Nominal Frequency**

You can make this setting only when the device configuration is C in Figure 5-3 on page 164 and the external mixer is off. If the device configuration is C with the external mixer on or if the device configuration is A or B, you cannot make this setting.

The allowable range is limited by the range of the carrier frequency band.

3. Carrier search function

This function searches for the carrier signal, and reflects the result on the nominal frequency. To execute this function:

Setup - **Carrier Search**

You can execute this function only when the device configuration is C in Figure 5-3 on page 164 and the external mixer is off. If the device configuration is C with the external mixer on or if the device configuration is A or B, you cannot execute this function.

The range to be searched is the range of the carrier frequency band.

4. Display of the carrier power

Information on the carrier signal is displayed.

For the device configuration A in Figure 5-3 on page 164, the measurement value of the power meter of the E5052A is displayed.

For the device configurations B and C, the measurement value of FFT is displayed.

Spectrum Monitor Measurement

The following settings for spectrum monitor measurement mode differ from the settings when using the E5052A alone.

1. Start, Stop, Center, Span frequencies

Set the 4 frequencies to determine the sweep range.

Start/Center (**Stop/Span**) - **Start (Stop, Center, Span)**

For the device configuration A in Figure 5-3 on page 164, the following limits are applied.

Start	9 M -6.99999995 GHz
Stop	10.00005 M -7.0075 GHz
Center	10 M -7 GHz
Span	100 - 15 MHz

For the device configuration B, the upper limit of Center is 3 GHz, and that of Stop is

3.0075 GHz. Other settings are the same as those for the device configuration A.

For the device configuration C with the external mixer off, the range of Center is 3 G - 26.5 GHz. The range of Start is 2.9925 G - 26.49999995 GHz, the range of Stop is 3.00000005 G - 26.5075 GHz, and the range of Span is 100 - 15 MHz.

NOTE

For the device configuration C with the external mixer ON, actual settings are dependent on the external mixer settings and/or the frequency function used. For more information, see “External Mixer” on page 178 and “Frequency Offset Function” on page 181.

2. Harmonic measurement function

Set the frequency band to measure the harmonics of the carrier signal. To set the frequency band:

Start/Center (**Stop/Span**) - **Carrier to - Frequency Band - 10 M - 1.5 GHz | ... | 9 G - 26.5 GHz**

Low (Band 1)	10 M -1.5 GHz
High (Band 2)	300 M - 7 GHz (300 M - 3 GHz)
Band 3	3 G -10 GHz
Band 4	9 G - 26.5 GHz

For the device configuration A in Figure 5-3 on page 164, you can set Low (Band 1) and High (Band 2). You cannot specify Band 3 and Band 4.

For the device configuration B, you can set Low (Band 1) and High (Band 2). Note that the frequency range of High (Band 2) is changed to 300 M - 3 GHz. You cannot specify Band 3 and Band 4.

For the device configuration C, you can set Band 3 and Band 4 when the external mixer is off. You cannot specify Low (Band 1) and High (Band 2).

Frequency/Power Measurement

The following settings for frequency/power measurement mode differ from the settings when using the E5052A alone.

1. Setting of the carrier frequency band

Set the frequency band for the carrier frequency.

Setup - **Frequency Band - 10 M - 1.5 GHz | ... | 9 G - 26.5 GHz**

Low (Band 1)	10 M -1.5 GHz
High (Band 2)	300 M - 7 GHz (300 M - 3 GHz)
Band 3	3 G -10 GHz
Band 4	9 G - 26.5 GHz

For the device configuration A in Figure 5-3 on page 164, you can set Low (Band 1) and High (Band 2). You cannot specify Band 3 and Band 4.

For the device configuration B, you can set Low (Band 1) and High (Band 2). Note that

Measurement Using E5053A and External Mixer

E5053A Microwave Downconverter

the frequency range of High (Band 2) is changed to 300 M - 3 GHz. You cannot specify Band 3 and Band 4.

For the device configuration C, you can set Band 3 and Band 4 when the external mixer is off. You cannot specify Low (Band 1) and High (Band 2).

NOTE

For the device configuration C with the external mixer ON, actual settings are dependent on the external mixer settings and/or the frequency function used. For more information, see “External Mixer” on page 178 and “Frequency Offset Function” on page 181.

2. Input of the nominal frequency

Set the nominal frequency of the carrier frequency.

Setup - Nominal Frequency

You can make this setting only when the device configuration is C in Figure 5-3 on page 164 and the external mixer is off. If the device configuration is C with the external mixer on or if the device configuration is A or B, you cannot make this setting.

The settable range is limited to the range of the carrier frequency band.

3. Carrier search function

This function searches for the carrier signal, and reflects the result on the nominal frequency. To execute this function:

Setup - Carrier Search

You can execute this function only when the device configuration is C in Figure 5-3 on page 164 and the external mixer is off. If the device configuration is C with the external mixer on or if the device configuration is A or B, you cannot execute this function.

The range to be searched is the range of the carrier frequency band.

4. Setting of the maximum input level

Set the maximum input level value of the measurement signal inputted from the Input port of the E5053A Microwave Downconverter. To execute this function:

Setup - Max Input Level

You can make this setting only when the device configuration is C in Figure 5-3 on page 164 and the external mixer is off. If the device configuration is C with the external mixer on or if the device configuration is A or B, you cannot make this setting.

5. Measurement value of power measurement

For the device configuration A in Figure 5-3 on page 164, the measurement value of the power meter of the E5052A is displayed. For the device configurations B and C, the measurement value of FFT is displayed.

Transient Measurement

The following settings for transient measurement mode differ from the settings when using the E5052A alone.

1. Setting of the frequency band of the input signal (wide band)

Set the frequency band (wide band) of the input signal. To execute this function:

Setup - Wide Freq Range - 50 M - 150 MHz | ••• | 2.4 G - 7.2 GHz

Table 5-1 Frequency Bands (Wide Band)

Frequency band	
50 M -150 MHz	1 G -3 GHz
100 M -300 MHz	1.2 G -3.6 GHz
200 M -600 MHz	1.4 G -4.2 GHz
300 M -900 MHz	1.6 G -4.8 GHz
400 M -1.2 GHz	1.8 G -5.4 GHz
500 M -1.5 GHz	2 G -6 GHz
600 M -1.8 GHz	2.2 G -6.6 GHz
800 M -2.4 GHz	2.4 G -7.2 GHz

For the device configuration A in Figure 5-3 on page 164, you can set any of the above frequency bands.

For the device configuration B, you can set 50 M - 150 MHz to 1 G - 3 GHz. You cannot set frequency bands equal to or greater than 1.2 G - 3.6 GHz.

For the device configuration C, you cannot set the frequency band of the input signal because the maximum frequency of the input signal must be specified when the external mixer is off.

NOTE

For the device configuration C with the external mixer ON, actual settings are dependent on the external mixer settings and/or the frequency function used. For more information, see “External Mixer” on page 178 and “Frequency Offset Function” on page 181.

2. Setting of the maximum frequency of the input signal

For the device configuration C in Figure 5-3 on page 164 with the external mixer off, you specify the maximum frequency of the input signal instead of the frequency band setting of the input signal. To execute this function:

Setup - Wide Max Frequency

For the device configuration C with the external mixer off, the settable range is 3.5 G - 26.5 GHz. The frequency span is fixed to 500 MHz, and cannot be changed.

NOTE

For the device configuration C with the external mixer ON, actual settings are dependent on the external mixer settings and/or the frequency function used. For more information, see “External Mixer” on page 178 and “Frequency Offset Function” on page 181.

3. Setting of the center frequency (wide band) of the video trigger

This setting is required when Wide Video is selected for the video trigger.

Setup - Video Trigger - Wide Freq

The settable range is limited to within the frequency band setting of the input signal described above, or below the maximum frequency of the input signal.

Measurement Using E5053A and External Mixer

E5053A Microwave Downconverter

4. Setting of the target frequency

Set the target frequency for narrow band measurement.

Setup - **Target Freq**

For the device configuration A in Figure 5-3 on page 164, the valid input range is 10 M - 7 GHz.

For the device configuration B, the valid input range is 10 M - 3 GHz.

For the device configuration C with the external mixer off, the valid input range is 3 G - 26.5 GHz.

NOTE

For the device configuration C with the external mixer off, the setting of the target frequency or the setting of the maximum frequency of the input signal, whichever made later, has precedence.

More specifically, if the inputted target frequency is greater than the setting value of the maximum frequency of the input signal, the setting value of the maximum frequency is changed so that it is greater than the target frequency.

On the other hand, if the maximum frequency of the inputted input signal is smaller than the setting value of the target frequency, the setting value of the target frequency is changed so that it is smaller than the maximum frequency of the input signal.

NOTE

For the device configuration C with the external mixer on, this setting differs depending on the setting of the external mixer and the setting of the frequency offset function. For more information, see “External Mixer” on page 178 and “Frequency Offset Function” on page 181.

5. Setting of the phase reference frequency

The phase deviation within the narrow band measurement range can be calculated based on the result of frequency transient (narrow band) measurement. The phase reference frequency is a frequency used as the reference when calculating the phase deviation.

Setup - **Phase Reference**

The setting range is limited to within the measurement range determined by the target frequency and the measurement range.

6. Setting of the center frequency (narrow band) of the video trigger

This setting is required when Narrow Video is selected for the video trigger.

Setup - **Video Trigger - Narrow Freq**

The setting range is limited to within the measurement range determined by the target frequency and the measurement range.

Auto Frequency Control Function

The following settings for auto frequency control measurement mode differ from the settings when using the E5052A alone.

1. Setting of the frequency band

Set the frequency band that contains the carrier signal to be measured.

DC Control - **Auto Freq Control - Frequency Band - 10 M - 1.5 GHz | ... | 9 G - 26.5 GHz**

Low (Band 1)	10 M -1.5 GHz
High (Band 2)	300 M - 7 GHz (300 M - 3 GHz)
Band 3	3 G -10 GHz (added)
Band 4	9 G - 26.5 GHz (added)

For the device configuration A in Figure 5-3 on page 164, you can set Low (Band 1) and High (Band 2). You cannot specify Band 3 and Band 4.

For the device configuration B, you can set Low (Band 1) and High (Band 2). Note that the frequency range of High (Band 2) is changed to 300 M - 3 GHz. You cannot specify Band 3 and Band 4.

For the device configuration C, you can set Band 3 and Band 4 when the external mixer is off. You cannot specify Low (Band 1) and High (Band 2). When the external mixer is on, you cannot make this setting because the auto frequency control function itself is not available.

2. Setting of the target frequency

Set the target frequency for the DUT output.

DC Control - **Auto Freq Control - Target**

For the device configuration A in Figure 5-3 on page 164, you can set 10 M - 7 GHz.

For the device configuration B, you can set 10 M - 3 GHz.

For the device configuration C, you can set 3 G - 26.5 GHz when the external mixer is off. When the external mixer is on, you cannot make this setting because the auto frequency control function itself is not available.

3. Setting of the maximum input level

Set the maximum input level value of the measurement signal inputted from the Input port of the E5053A Microwave Downconverter. To execute this function:

DC Control - **Auto Freq Control - Max Input Level**

You can make this setting only when the device configuration is C in Figure 5-3 on page 164 and the external mixer is off. If the device configuration is C with the external mixer on or if the device configuration is A or B, you cannot make this setting.

Effects of Setting of Downconverter and Input Port for RF Signals

The table below lists items whose setting range changes or whose display is affected depending on the setting of the E5053A Microwave Downconverter and the setting of the input port of the RF signal.

Table 5-2 Items Affected by E5053A Microwave Downconverter and Input Port

Measurement mode	Affected items	Downconverter		
		OFF	ON	
			Input port	
			E5052A direct	E5053A downconverter
Common to all modes	Setting of attenuator	Available (0,5,10,15,20,25,30, 35 dB)	Available (0,5,10,15,20,25,30, 35 dB)	fixed to 10dB
phase-noise measurement mode	Setting of carrier frequency band	10 M - 41 MHz 39 M - 101 MHz 99 M -1.5 GHz 300 M -7 GHz	10 M - 41 MHz 39 M - 101 MHz 99 M -1.5 GHz 300 M - 3 GHz	3 G -10 GHz 9 G - 26.5 GHz
	Setting of nominal frequency	N/A	N/A	Yes (Allowable range is limited by carrier frequency band.)
	Carrier search function	N/A	N/A	Can be executed
Spectrum monitor measurement mode	Setting of start frequency	9 M -6.99999995 GHz	9 M -6.99999995 GHz	2.9925 G -26.49999995 GHz
	Setting of stop frequency	10.00005 M -7.0075 GHz	10.00005 M - 3.0075 GHz	3.00000005 G - 26.5075 GHz
	Setting of center frequency	10 M -7 GHz	10 M -3 GHz	3 G -26.5 GHz
	Setting of span frequency	100 - 15 MHz	100 - 15 MHz	100 - 15 MHz
	Setting of carrier frequency band for harmonic measurement function	10 M -1.5 GHz 300 M -7 GHz	10 M -1.5 GHz 300 M - 3 GHz	3 G -10 GHz 9 G - 26.5 GHz

Table 5-2 Items Affected by E5053A Microwave Downconverter and Input Port

Measurement mode	Affected items	Downconverter		
		OFF	ON	
			Input port	
			E5052A direct	E5053A downconverter
Frequency/power measurement mode	Setting of carrier frequency band	10 M -1.5 GHz 300 M -7 GHz	10 M -1.5 GHz 300 M - 3 GHz	3 G -10 GHz 9 G - 26.5 GHz
	Setting of nominal frequency	N/A	N/A	Yes (Allowable range is limited by carrier frequency band.)
	Carrier search function	N/A	N/A	Yes
	Setting of maximum input level	N/A	N/A	Yes (-45 to 30 dBm)
Transient measurement mode	Setting of frequency band of input signal (wide band)	50 M -150 MHz 100 M -300 MHz 200 M -600 MHz 300 M -900 MHz 400 M -1.2 GHz 500 M -1.5 GHz 600 M -1.8 GHz 800 M -2.4 GHz 1 G -3 GHz 1.2 G -3.6 GHz 1.4 G -4.2 GHz 1.6 G -4.8 GHz 1.8 G -5.4 GHz 2 G -6 GHz 2.2 G -6.6 GHz 2.4 G -7.2 GHz	50 M -150 MHz 100 M -300 MHz 200 M -600 MHz 300 M -900 MHz 400 M -1.2 GHz 500 M -1.5 GHz 600 M -1.8 GHz 800 M -2.4 GHz 1 G -3 GHz	N/A (set with maximum frequency of input signal)

Table 5-2 Items Affected by E5053A Microwave Downconverter and Input Port

Measurement mode	Affected items	Downconverter		
		OFF	ON	
			Input port	
			E5052A direct	E5053A downconverter
Transient measurement mode (continued)	Setting of maximum frequency of input signal (wide band)	N/A (set with frequency band of input signal (wide band))	N/A (set with frequency band of input signal (wide band))	Allowable range: 3 G - 26.5 GHz Setting resolution: 50 MHz (3.5 G - 10.85 GHz) 150 MHz (10.85 G - 26.5 GHz) Frequency span: 500 MHz
	Setting of center frequency of video trigger (wide band)	Limited to within setting of frequency band of input signal (wide band)	Limited to within setting of frequency band of input signal (wide band)	Limited to value less than or equal to setting value of maximum frequency of input signal (wide band)
	Setting of target frequency (narrow band)	10 M - 7 GHz	10 M - 3 GHz	3 G - 26.5 GHz
	Setting of phase reference frequency (narrow band)	Limited to within measurement range determined by target frequency (narrow band) and measurement range (narrow band).	Limited to within measurement range determined by target frequency (narrow band) and measurement range (narrow band).	Limited to within measurement range determined by target frequency (narrow band) and measurement range (narrow band).
	Setting of center frequency of video trigger (narrow band)	Limited to within measurement range determined by target frequency (narrow band) and measurement range (narrow band).	Limited to within measurement range determined by target frequency (narrow band) and measurement range (narrow band).	Limited to within measurement range determined by target frequency (narrow band) and measurement range (narrow band).

Table 5-2 **Items Affected by E5053A Microwave Downconverter and Input Port**

Measurement mode	Affected items	Downconverter		
		OFF	ON	
			Input port	
			E5052A direct	E5053A downconverter
Auto frequency control function (AFC)	Setting of frequency band	10 M -1.5 GHz 300 M -7 GHz	10 M -1.5 GHz 300 M - 3 GHz	3 G -10 GHz 9 G - 26.5 GHz
	Setting of target frequency	10 M -7 GHz	10 M -3 GHz	3 G -26.5 GHz
	Setting of maximum input level	N/A	N/A	Yes (-45 to 30 dBm)

NOTE In the above table, the setting of the external mixer and the setting of the frequency offset are not taken into consideration. The table assumes that they are disabled.

External Mixer

This section describes settings and limitations when using the external mixer.

Overview

The E5053A Microwave Downconverter with the external mixer connected enables measurement up to 110 GHz.

Setting the E5052A when used with the E5053A Microwave Downconverter and the external mixer is based on the frequency of the RF signal (IF signal of the downconverter) supplied to the E5052A.

NOTE

In practice, the hardware in the E5052A narrows the measurement range of a signal down-converted by the E5053A Microwave Downconverter.

The frequency offset function described later is supported also when using the external mixer. You can use this function to display the setting values and measurement results of the E5052A in terms of DUT frequencies (frequencies before down-conversion).

Setup Parameters

The settings of the external mixer are common to all measurement modes (phase-noise measurement, spectrum monitor measurement, frequency/power measurement, and transient measurement).

The settings are applied to the hardware immediately when the device configuration is C in Figure 5-3 on page 164 and the external mixer is on.

Other than the phase-noise measurement mode, use the identical LO frequency for each channel (channel 1 and channel 2), while the LO frequency of channel 1 and channel2 can be set differently.

In the phase-noise measurement mode, the carrier frequency is measured using the channel2 path. In the frequency/power/DC current measurement, the carrier frequency is measured using the channel1 path.

Both channel paths are required to complete the measurement other than spectrum monitor mode, which uses channel2 path only.

In the transient measurement mode, the channel1 path is used for the wideband transient measurement, and the channel2 path is used for the narrowband transient measurement.

The settings when using the downconverter and the external mixer include:

- Setting of LO
- Setting of DC bias current (CH1, CH2)
- Setting of the IF gain inside the downconverter
- Setting of the downconverter Δ IF frequency

Setting of LO

Set the external signal source (LO).

(Channel 1 side)

System - Instrument Setup - Downconverter Manual Setup - LO1 Frequency

System - Instrument Setup - Downconverter Manual Setup - LO1 Level

(Channel 2 side)

System - Instrument Setup - Downconverter Manual Setup - LO2 Frequency

System - Instrument Setup - Downconverter Manual Setup - LO2 Level

Allowable range of the LO frequency setting is 2.975 G - 10.025 GHz, and setting resolution setting is 50 MHz.

Allowable range of the LO level setting is 10 - 16 dBm when the setting frequency is 2.975 G - 6 GHz; it is fixed to 10 dBm when the setting frequency is 6 G - 10.025 GHz.

Setting of DC Bias Current

Set a bias current supplied to the external mixer.

(Channel 1 side)

System - Instrument Setup - Downconverter Manual Setup - Mixer 1 Bias

System - Instrument Setup - Downconverter Manual Setup - Current

(Channel 2 side)

System - Instrument Setup - Downconverter Manual Setup - Mixer 2 Bias

System - Instrument Setup - Downconverter Manual Setup - Current

Valid input range of the bias current is -10 mA to 10 mA both for Channel 1 and Channel 2.

Setting of downconverter IF Gain

Set IF gain inside the downconverter.

(Channel 1 side)

System - Instrument Setup - Downconverter Manual Setup - IF Gain 1

(Channel 2 side)

System - Instrument Setup - Downconverter Manual Setup - IF Gain 2

Valid input range of the downconverter IF gain is 0 dB to 35 dB both for Channel 1 and Channel 2.

Setting of downconverter Δ IF Frequency

Set frequency difference when the IF frequency (RF frequency of the E5052A) of the downconverter differs between Channel 1 and Channel 2.

System - Instrument Setup - Downconverter Manual Setup - Δ IF = IF2 - IF1

Set the value Δ IF obtained by the following equation.

$$\Delta\text{IF} = \text{IF} (\text{Channel 2}) - \text{IF} (\text{Channel 1})$$

Limitations

Using the external mixer has following limitations:

- Limitations on the auto frequency control function and the carrier search function
When the external mixer is enabled, the auto frequency control function (AFC) is not available. Also not available is the carrier search function.

- The LO frequency of the downconverter is not changed automatically.

When using the external mixer, values are not changed automatically so the settings should be done manually

For example, when you make measurement in analyzer mode for frequency/power measurement, if the measurement frequency exceeds a valid measurement range during a sweep, LO frequency of the downconverter is not changed automatically. (The frequency is not changed automatically to follow the excess of frequency.)

Frequency Offset Function

This section describes the frequency offset function and applicable setting values/measurement values.

Overview

This function offsets the frequency readouts when using an external downconverter or external mixers. All the frequency data and marker readouts are converted along with the equation below.

$$RF = N \times LO \text{ } -/+ \text{ } IF$$

Where RF is the DUT frequency, N is the harmonic number, LO is the LO frequency of the external downconverter or the mixer used.

You can use this function to display the setting values and measurement results of the E5052A in terms of DUT frequencies (frequencies before down-conversion).

This function supports an offset not only when the internal local signal (LO) supplied to the internal mixer is at the lower frequency side of the DUT signal, but also when it is at the higher frequency side.

The frequency offset function is available when the device configuration is A or B in Figure 5-3 on page 164, and when the device configuration is C with the external mixer enabled.

Setting Items

Setting items to use the frequency offset function are as follows.

- On/off setting of the frequency offset function
- Setting of the conversion mode
- Setting of the frequency of the local signal (LO)
- Setting of the harmonic

NOTE

Settings of the frequency offset function are common to all measurement modes (phase-noise measurement mode, spectrum monitor measurement mode, frequency/power measurement mode, and transient measurement mode). You cannot make these settings for each measurement mode separately.

On/off Setting of Frequency Offset Function

Turn on/off the frequency offset function.

System - Instrument Setup - Frequency Offset (User Downconv.) -
Frequency Offset - ON | OFF

Setting of Conversion Mode

Set the conversion mode of the frequency offset function.

Measurement Using E5053A and External Mixer Frequency Offset Function

System - Instrument Setup - Frequency Offset (User Downconv.) -
Conversion Mode - $RF = n * LO + IF$ | $RF = n * LO - IF$

When you select $RF = n * LO + IF$, Upper Side Band (USB) mode is used, while selecting $RF = n * LO - IF$, Lower Side Band (LSB) mode is used.

For information on the frequency conversion equations, see “Frequency Conversion Equations” on page 182.

Setting of LO Frequency

Set the LO frequency of a mixer or a downconverter used.

The LO frequency range is as follows:

- 10 M to 110 GHz for the USB conversion mode
- 500 M to 110 GHz for the LSB conversion mode

System - Instrument Setup - Frequency Offset (User Downconv.) -
LO Frequency

The LO frequency is used for the equations as described “Frequency Conversion Equations” on page 182. When the conversion mode is USB, the setting range is 10 M - 330 GHz, and when the conversion mode is LSB, 500 M - 330 GHz.

Setting of Harmonic Number

Set the harmonic number of a mixer.

System - Instrument Setup - Frequency Offset (User Downconv.) -
Harmonic #

The harmonic number is used for the conversion equations as described “Frequency Conversion Equations” on page 182. The setting range is 1-34.

Frequency Conversion Equations

The frequency conversion equations are as follows.

1. When the conversion mode is USB. ($RF > N \times LO$)
$$RF = N \times LO + IF$$
2. When the conversion mode is LSB. ($RF < N \times LO$)
$$RF = N \times LO - IF$$

, where RF is the DUT frequency, LO is the LO frequency of a mixer or a downconverter used, IF is the IF frequency of the downconverted signal, and N is the harmonic number.

Consideration on Frequency Setting

All the measurement setup parameters concerning frequency can be input as DUT frequency when frequency offset function is applied. The applicable frequency range is from 20 M to 117 GHz. There are some constraints on measurement setup parameters actually depending on the IF frequency of the downconverted signal being fed into the E5052A, and it is determined by the measurement range of the E5052A.

The listed below may be needed on considering the frequency setting when using the frequency offset function.

1. Setting common to all measurement modes
 - Setting of the target frequency of the auto frequency control function
2. Spectrum monitor measurement mode
 - Setting of Start, Stop, and Center frequencies

Note that the start and stop frequency may be limited by the actual IF signal being inputted to the E5052A. For example, the IF frequency is 10 MHz, the maximum span is limited up to 2 MHz, 10 percent of the IF frequency, not the RF frequency.
3. Transient measurement mode
 - Setting of the frequency range (wide band) or the maximum frequency

When the frequency offset function is on, the **Wide Freq Range** softkey is not available, and the **Wide Freq Span** softkey appears instead. Use the **Wide Max Frequency** softkey to set the maximum frequency.
 - Setting of the target frequency (narrow band)
 - Setting of the phase reference frequency (narrow band, phase transient measurement)
 - Setting of the video trigger frequency (wide band)
 - Setting of the video trigger frequency (narrow band)

Applicable Measurement Results

The listed below are the measurement results that the frequency data is converted by the use of frequency offset function.

1. Phase-noise measurement mode
 - Frequency of the carrier signal
2. Frequency/power measurement mode
 - Measurement data array for frequency measurement (frequency data of all measurement points in analyzer mode)
 - Frequency measurement data in tester mode
3. Transient measurement mode
 - Measurement data array for frequency transient measurement (wide band)
 - Measurement data array for frequency transient measurement (narrow band)

Making phase-noise measurement above 26.5 GHz

This chapter contains information on making phase-noise measurements of signal sources above 26.5 GHz. This information is fundamental to configuring millimeter-wave phase-noise measurement systems with the Agilent E5052A and E5053A.

Basic configuration for expanding frequency range

The E5053A is designed to use two independent paths for the signal downconversion from RF to IF. Above 26.5 GHz, a power divider and a pair of external mixers can be added to extend the scheme of the E5053A. External mixers can be driven by the E5053A's built-in LOs. A block diagram of the basic setup is shown in Figure 5-4.

Figure 5-4 Block diagram for making phase-noise measurement above 26.5 GHz

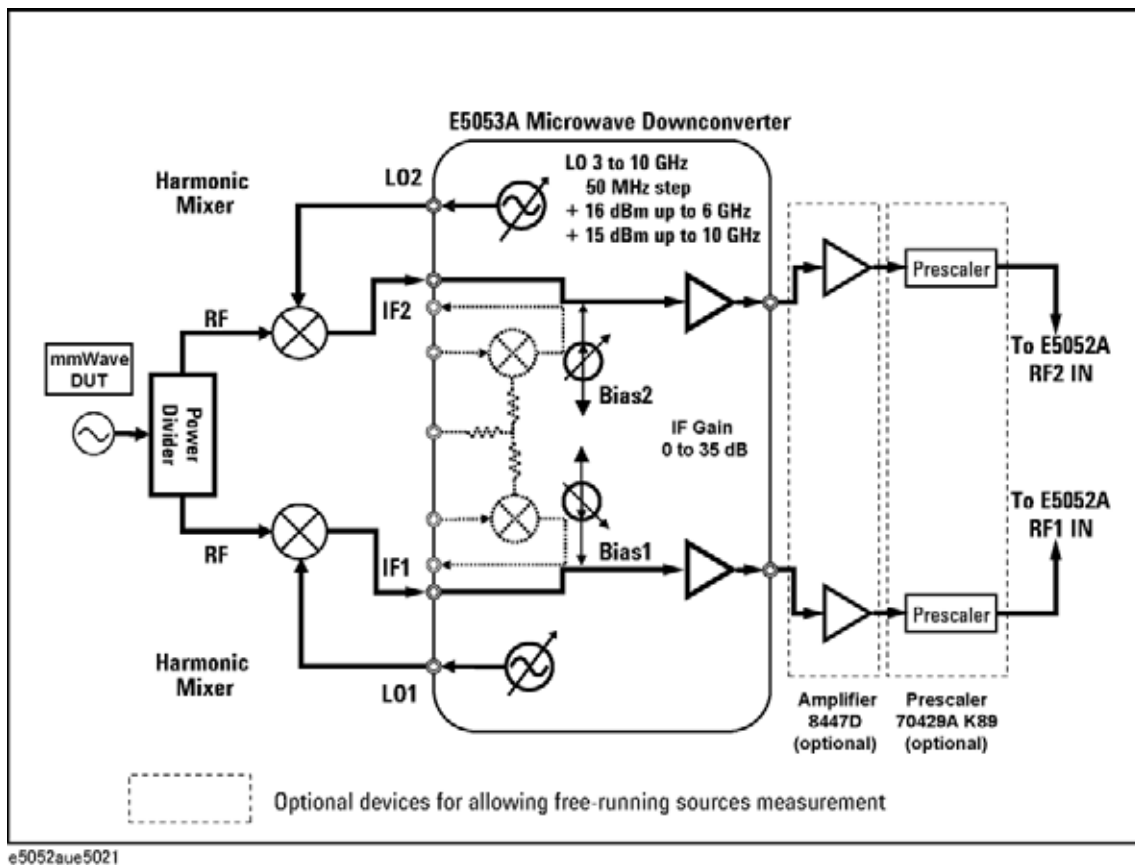

Table 5-3

Required equipment for expanding frequency range > 26.5 GHz

Equipment	Quantity	Note
11970 Series	2	
Hybrid matched tee	1	Available from third-party vendors of millimeter-wave equipment
Waveguide termination	1	Available from third-party vendors of millimeter-wave equipment
Waveguide bend	2	Available from third-party vendors of millimeter-wave equipment
Coax cables	4	
70429A K89 frequency divider (prescaler)	2	Required if the frequency drift and/or high phase-noise pedestal of your DUT has difficulties with phase lock. Refer to “Advanced measurement techniques for a free-running source measurement” on page 189.
8447D Option 011 Dual Channel amplifier	1	Required if the IF power level is insufficient. Refer to “Advanced measurement techniques for a free-running source measurement” on page 189

Setup considerations for > 26.5 GHz measurement

If a source is not able to provide a sufficient power level, it may be necessary to insert an amplifier between the output of the mixer and the IF input of the E5052A. The allowable power level at the E5053A IF input port depends on the equipment's IF Gain setting (Figure 5-5). The detailed power requirements of your DUT along with the millimeter-wave mixers selected are shown in Table 5-4.

Figure 5-5

Allowable power level at E5053A IF input port

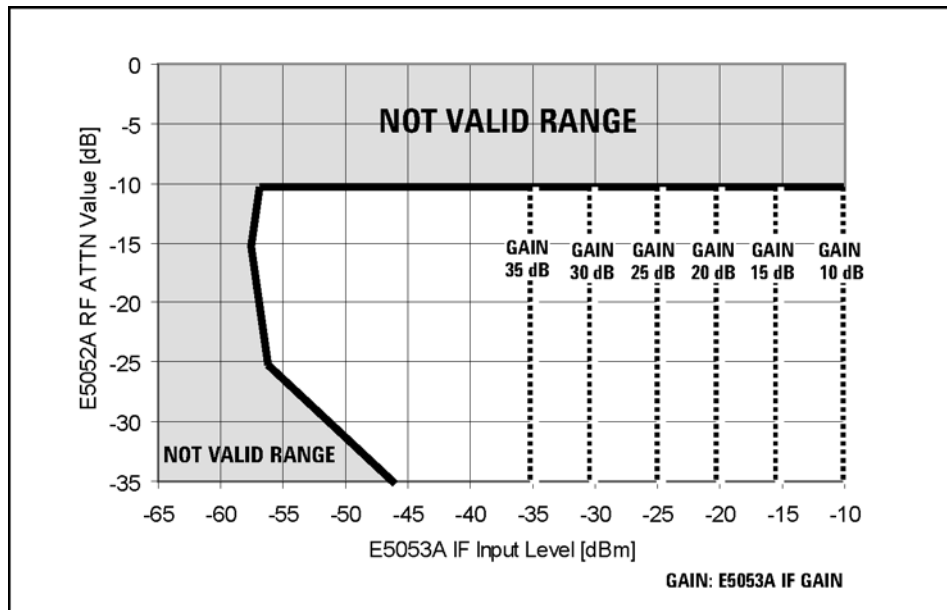

e5052aue5036

Table 5-4

Applicable power level by selected harmonic mixer

Harmonic mixer	Frequency band [GHz]	Maximum conversion loss [dB]	Gain Compression [dBm] (typ.)	Minimum power level of DUT*1 [dBm]
11970A	26.5 to 40	26	-5	-29 approx.
11970Q	33 to 50	28	-7	-27 approx.
11970U	40 to 60	28	-7	-27 approx.
11970V	50 to 75	40	-3	-15 approx.
11970W	75 to 110	46	-1	-9 approx.

*1. Assumes 3 dB loss of the waveguide adaptors between output port of the DUT and the mixers. If the DUT noise floor at IF port is greater than -110 dBc/Hz, the phase-noise measurement may not be performed properly. A poor S/N ratio would prevent the frequency counter of the E5052A from working correctly.

Measurement noise floor

Using harmonic mixers alone degrades the phase noise of the LO of the E5053A, depending on the harmonics number. Figure A-3 shows an example of 77-GHz millimeter-wave measurement. If you need to insert amplifiers to boost the IF signal, the noise of the inserted amplifier will also be summed into the measured noise level along with the noise of your device under test. Setting a correlation rate reduces the additive noise of the inserted dual-channel amplifier.

Figure 5-6

Example of millimeter-wave phase-noise sensitivity (start offset = 1 Hz, correlation = 1)

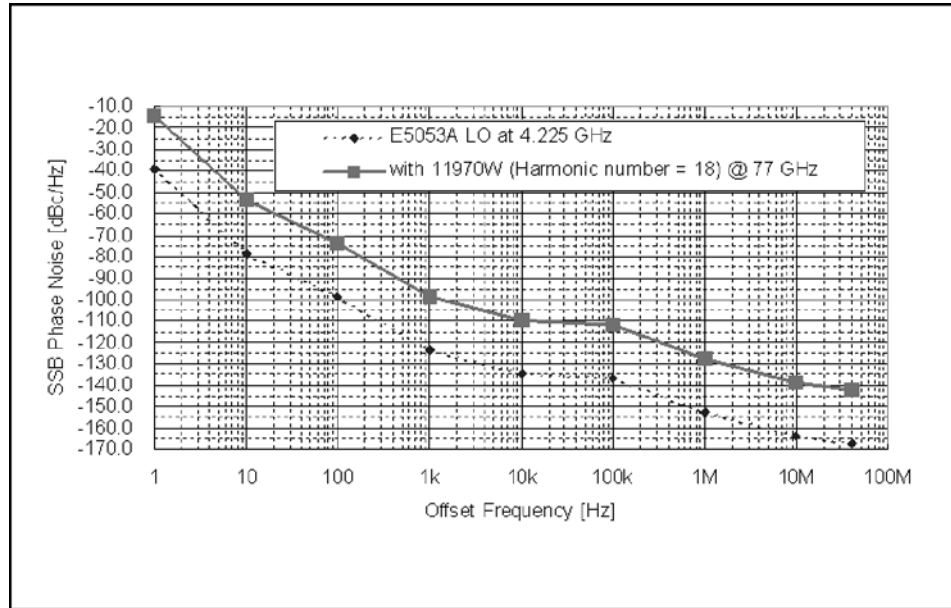

e5052aue5023

Configuring millimeter-wave phase-noise measurement setup

A typical millimeter-wave measurement setup is shown in Figure A-4.

CAUTION

To prevent damage to the Agilent E5053A hardware, input signals MUST NOT be applied to the signal output connector of the E5053A. Also, to prevent unexpected static discharge during operation, terminate the output signal connectors with coax-sma termination, part number 1810-0188.

Figure 5-7 Millimeter-wave measurement setup for stable source

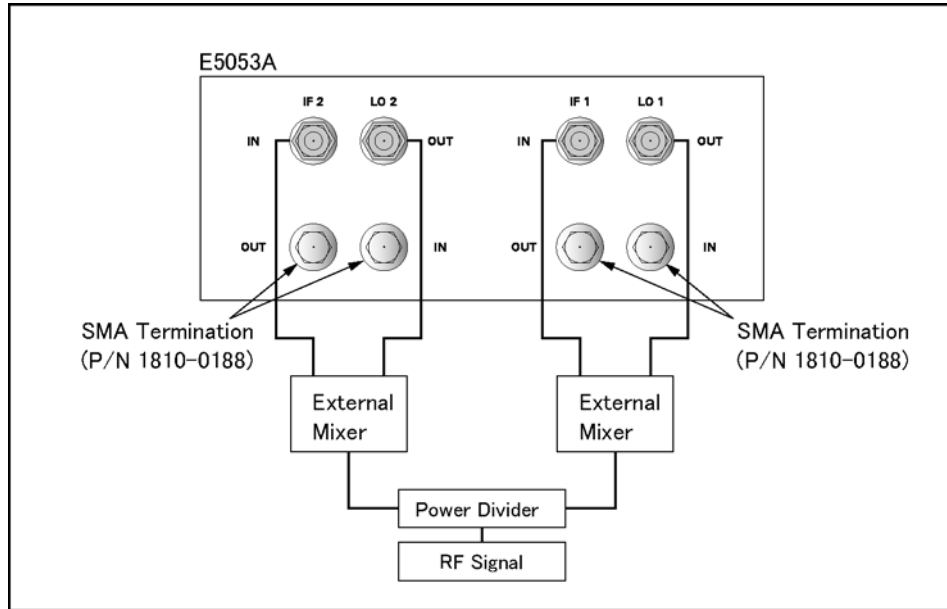

e5052aue5024

Advanced measurement techniques for a free-running source measurement

Some free-running oscillators exhibit large frequency drift and high phase noise, especially in the millimeter-wave frequency range. Sometimes these oscillators cause measurement difficulties, such as PLL unlock and/or invalid measurement. Prescaler techniques can help you overcome these difficulties.

Large frequency drift

The E5052A automates the phase-noise measurement in several steps: measuring carrier frequency and power level, calibrating phase detector constant, tuning the built-in LO, closing the phase-locked loop, and measuring the noise signal coming out of the phase detector.

The tracking ability of the E5052A is limited by:

- Instantaneous peak-to-peak frequency drift throw rate when attaining phase lock.
 - Peak-to-peak frequency change during a single measurement.
1. Check whether the instantaneous peak-to-peak frequency drift throw rate exceeds the maximum allowable throw rate, which is approximately 5 kHz per 20 msec with 0 or 10 dB IF GAIN. The instantaneous peak-to-peak frequency drift can be checked with the transient measurement mode. Measure the downconverted frequency profile over time by setting the time length to 20 msec or 50 msec.
 2. Check whether your peak-to-peak frequency change exceeds 0.4% of the carrier frequency or the downconverted IF signal frequency. Note that this is also a function of measurement time depending on the start offset you select and/or the number of cross-correlations you set. (Refer to table xx for specification, page xx). Taking a longer time for a single measurement increases the chances of losing phase lock.

Figure 5-8

E5052A tracking ability

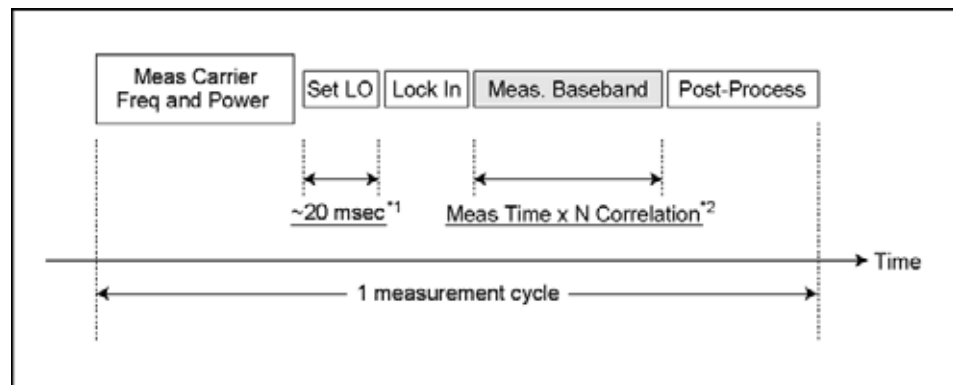

e5052aue5025

*1. Maximum E5052A PLL BW
Approximately 5 kHz (IF GAIN = 0, 10 dB)

*2. Maximum LO Tunable Range During Baseband Measurement
0.4% of downconverted IF Signal

High phase noise that may saturate phase detector

An average noise level of the input signals that exceeds approximately 0.2 radian rms, integrated outside of the phase-locked loop (PLL) bandwidth, can prevent the Agilent E5052A from attaining phase lock. Please confirm that the expected phase noise of your DUT does not exceed the limit line shown in Figure 5-9.

Figure 5-9

Phase-noise measurement limit line

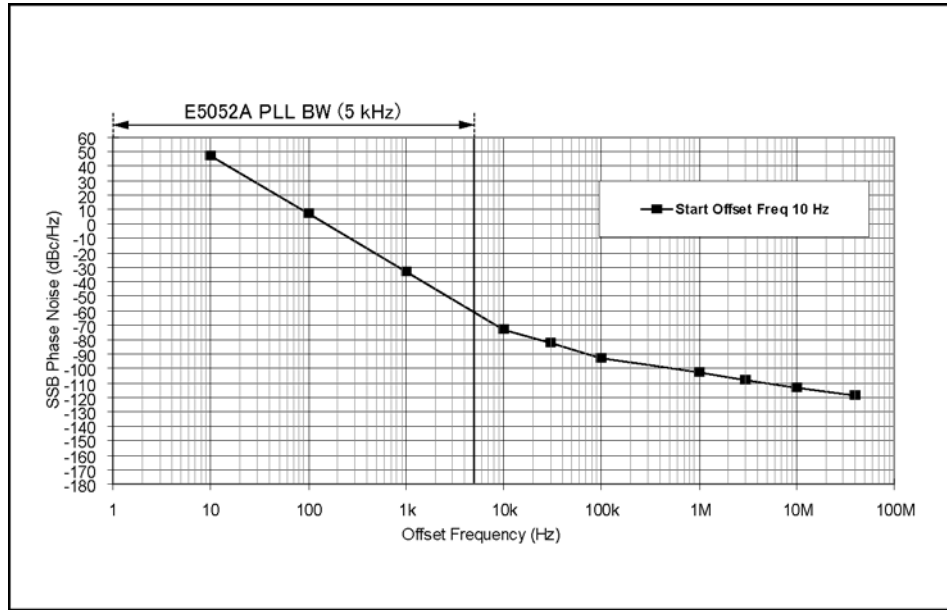

e5052aue5026

In either case, prescaler techniques can help you overcome problems related to this issue.

Prescaler techniques to suppress frequency drift and high phase noise

Inserting frequency dividers (prescaler) reduces the frequency drift as well as phase-noise level in order to make valid phase-noise measurement with the E5052A.

Note that the additive noise of the inserted frequency dividers will be summed into the noise level to determine the noise floor of the measurement. By taking advantage of the dual-prescaler technique for setting the appropriate the number of correlations, you can reduce the additive noise of the prescaler used.

Figure 5-10 Effect of prescaler techniques

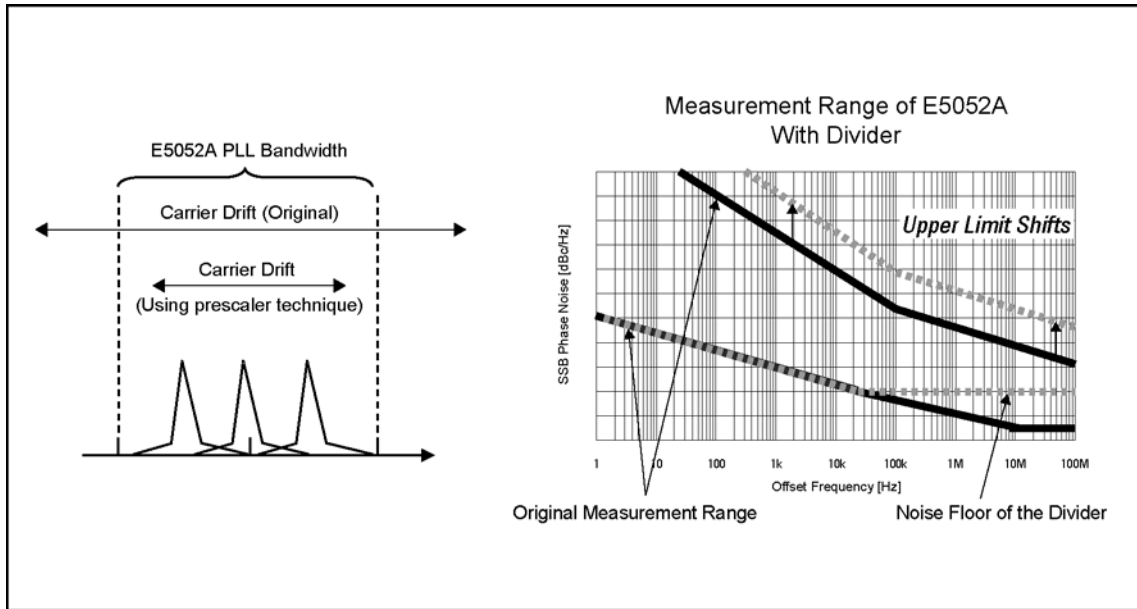

e5052aue5027

Configuring millimeter-wave setup to allow prescaler techniques

CAUTION

To prevent damage to the Agilent E5052A and E5053A hardware, the input signal **MUST NOT** be applied to the signal input connector until the input attenuator has been correctly set for the desired configuration. Apply the input signal when the AgtmmWave VBA macro form appears. (See the section “Operation of VBA macro AgtmmWave”.)

A typical millimeter-wave measurement setup is shown in Figure 5-11.

Figure 5-11 Setup for millimeter-wave phase-noise measurement with prescaler techniques



e5052au15034

Operation of the AgtmmWave VBA macro

The “AgtmmWave” macro in the assistant tool, which is a VBA macro program running on the E5052A, is used to automate the setup of the E5053A and E5052A when making millimeter-wave phase-noise measurement.

Start up the AgtmmWave macro

- Step 1.** Press **Macro Setup**.
- Step 2.** Press **Application - mmWave** to start up the macro

The macro window shown in Figure 5-12 appears on the E5052A display.

Figure 5-12 AgtmmWave macro window

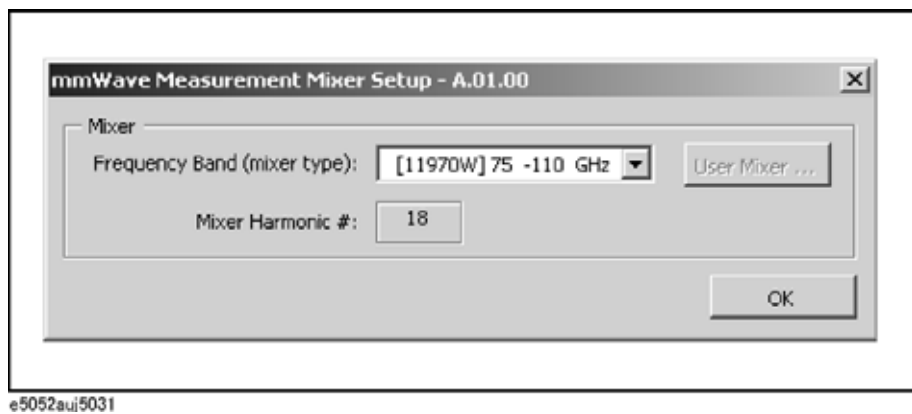

Set up millimeter-wave measurement parameters

- Step 1.** Select a frequency band from the pull-down menu of the macro window (Figure 5-12).
- Step 2.** If you select “User Mixer” from the menu, press the **User Mixer...** button to set up the necessary parameters of the harmonic mixer used (Figure 5-13).

Figure 5-13 User Mixer setup menu

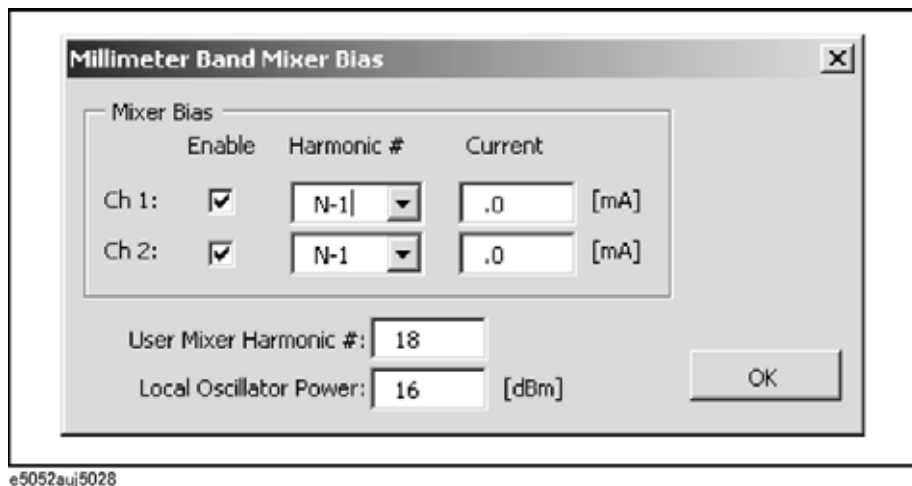

Measurement Using E5053A and External Mixer Making phase-noise measurement above 26.5 GHz

Step 3. Click **OK**.

Step 4. Input DUT Frequency (Figure 5-15).

The AgtmmWave automatically sets the E5053A LO to output the appropriate IF frequency of the downconverted signal.

NOTE

The AgtmmWave VBA macro sets the downconverted IF frequency differently between channel 1 and channel 2 without prescaler techniques. This is to avoid the generation of spurs by the E5053A. The E5053A uses slightly different reference frequencies for the LOs of channel 1 and channel 2. In order to take the advantage of the cross-correlation technique, both LOs have to be incoherent to each other. If the E5053A uses the same nominal LO frequency for both channels, whose frequencies are even slightly different from each other, inter-modulation signals are generated and fall into the baseband signal as spurious signals due to the coupling of channel 1 and channel 2.

Figure 5-14

Mechanism of spurs generation due to incoherent LO of E5053A

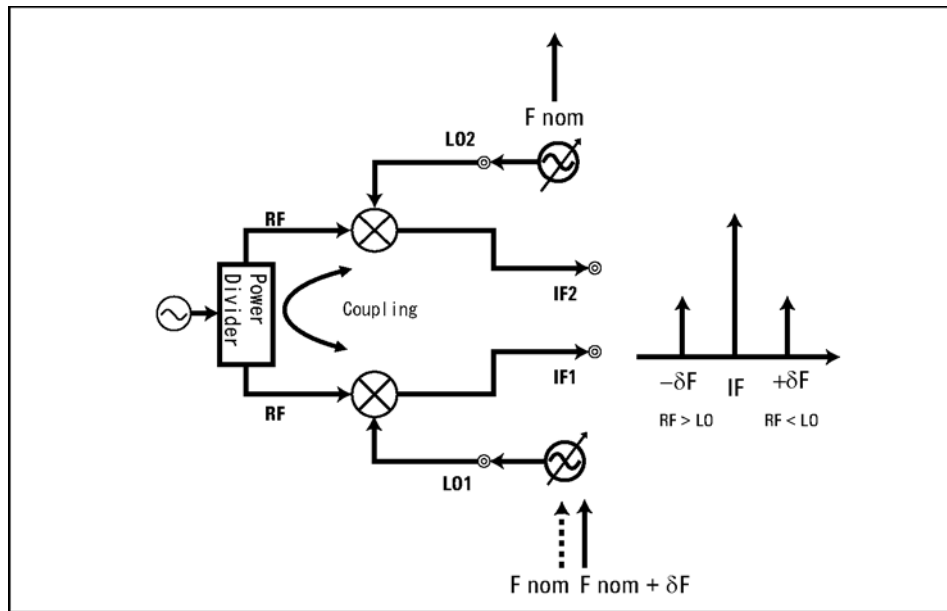

Step 5. Select the appropriate **SSA Input Attn** and **D/C IF GAIN** from the pull down menus (Figure 5-15).

Change the **SSA Input Attn** value if a warning message “Set RF ATTN to xx dB” is displayed. The default setting is 35 dB ATTN for preventing damage to the E5052A from unexpectedly high applied IF power.

Change the **D/C IF Gain** value from the pull down menu if an error message such as “IF A/D overflow” or “IF Level overload” is displayed. The default setting is 35 dB for maximum gain.

Figure 5-15 SSA Input ATTN and D/C IF Gain menu

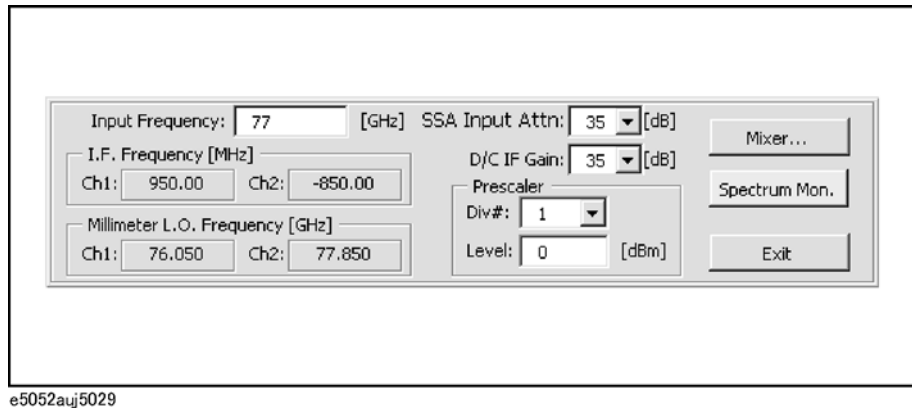

NOTE

If you fail to measure phase noise (phase-locked loop unlock error or IF not found) or get an unstable phase-noise measurement result, you can check the signal quality of the downconverted IF signal. Press **Spectrum Mon.** to verify that the IF signal is present. If no IF signal is present, vary the input frequency slightly until the IF signal is found. If the frequency drift is large, the use of prescaler techniques is recommended. (Refer to “Advanced measurement techniques for a free-running source measurement” on page 189)

Figure 5-16 Verify downconverted IF signal with spectrum monitor function

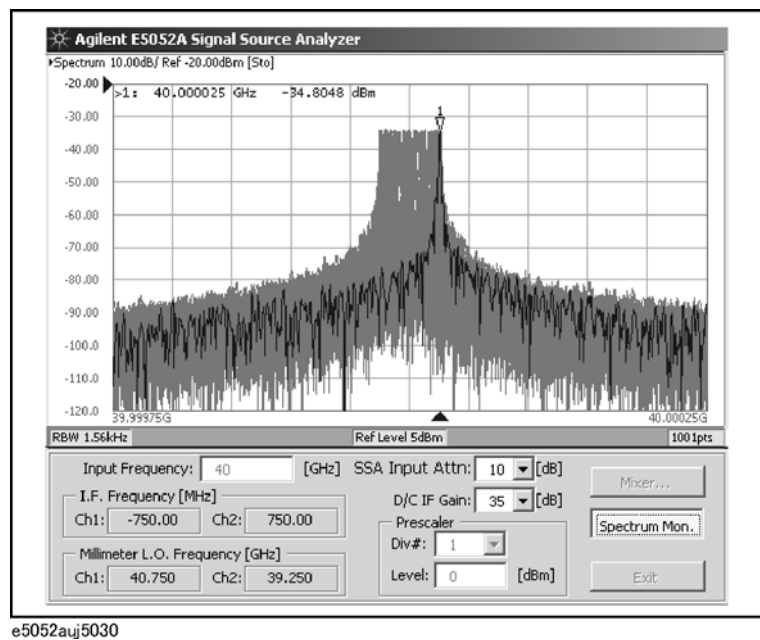

Setup for prescaler techniques (Advanced technique for measuring a free-running source)

CAUTION To prevent damage to the Agilent E5052A hardware, the input signal **MUST NOT** be applied to the RF1 IN and RF2 IN connectors until the E5052A input attenuator has been set to 35 dB. Do not connect anything as the E5052A is turning off because the INPUT ATTN is automatically set to 0 dB during shutdown.

CAUTION To prevent damage to the Agilent E5052A hardware, the input signal **MUST**:

- NOT BE GREATER THAN 0 dBm RF OUTPUT POWER
- NOT CONTAIN DC OFFSET VOLTAGE

when applied to the RF1 IN and RF2 IN connectors. Use an external attenuator to ensure that the input signal to RF1 IN and RF2 IN is less than or equal to 0 dBm. Use DC Blocking Capacitors if the DC voltage is present at the output signal of the prescaler used.

Step 1. Set **SSA Input Attn** to 35 dB.

Connect prescalers between RF1 OUT of the E5053A and RF1 IN of the E5052A and between RF2 OUT of the E5053A and RF2 IN of the E5052A.

Figure 5-17

Connecting prescalers

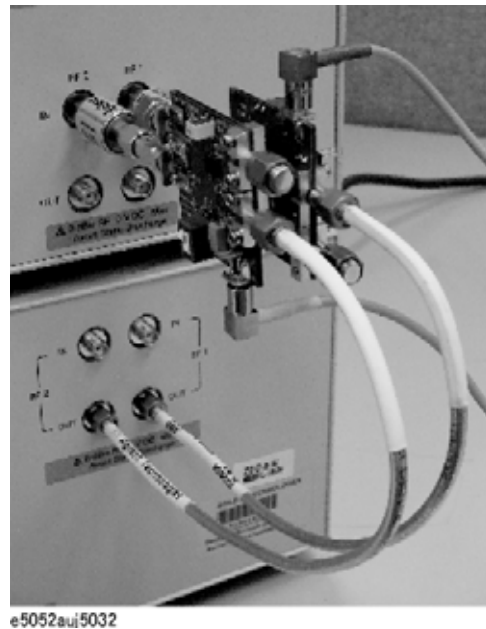

Step 2. Select **Div#** and input the prescaler output power level (Figure 5-15).

NOTE Set an appropriate D/C IF Gain if the downconverted signal-power level is not sufficient for the required input-power level of the prescaler used.

The phase-noise measurement amplitude is automatically corrected according to the following equation, and the results are shown in Figure 5-18.

$$\text{Corrected Phase Noise} = \text{Phase Noise at Prescaler Output} + 20 * \text{LOG}(N)$$

N = Prescaler's Dividing Number

Figure 5-18 Phase-noise correction with prescaler techniques

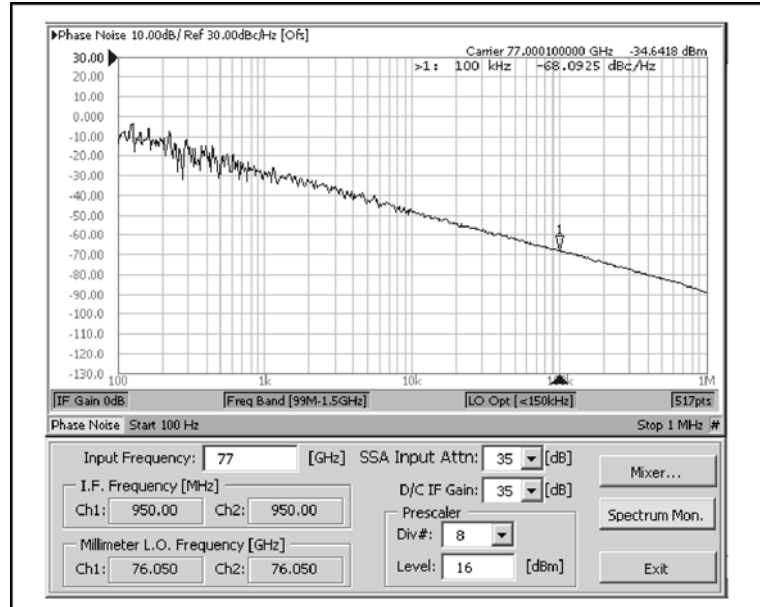

e5052auj5033

Measurement Using E5053A and External Mixer
Making phase-noise measurement above 26.5 GHz

6

Data Analysis and Result Output

This chapter describes the analysis function of the E5052A, how to use the saving/recalling function, and the concept and method of screen information printing.

Analyzing Data on Trace Using Marker

About Marker Functions

The marker can be used in the following ways:

- Reading a measured value as numerical data (as an absolute value or a relative value from the reference point)
- Moving the marker to a specific point on the trace (marker search)
- Using the value of the marker to change the stimulus (sweep range) and scale (value of the reference line)

For more information, refer to “Searching for Positions that Match Specified Criteria” on page 208.

For the procedure used to change the sweep range and scale by using the marker, refer to “Specifying Sweep Range by Using Marker” on page 203.

The E5052A is capable of displaying up to 10 markers (10 normal markers or 9 normal markers and 1 reference marker) on each trace. Each marker has a stimulus value (the value on the X-axis) and a response value (the value on the Y-axis).

Reading Values on Trace

You can read the value of a marker displayed on the trace.

You can set the marker for the selected measurement window.

The marker response value is always in the same data format as that of the Y-axis.

Operational Procedure

Step 1. Press **Trace Next** or **Trace Max** to activate the trace on which you want to use the marker.

Step 2. Press **Marker**.

NOTE

At this point, marker 1 is turned on and becomes active (you can operate the marker). When using marker 1, you can omit Step 3.

Step 3. Select a marker and turn it on. The softkey used to turn on a marker is used to activate that marker.

Softkey	Function
Marker 1	Turns on marker 1, which has been turned off; activates marker 1
Marker 2	Turns on marker 2, which has been turned off; activates marker 2
Marker 3	Turns on marker 3, which has been turned off; activates marker 3
Marker 4	Turns on marker 4, which has been turned off; activates marker 4
:	
Marker 10	Turns on marker 10, which has been turned off; activates marker 10

Step 4. Change the marker value in the entry area. This operation enables you to move the marker to a point on the desired trace.

The marker value in the entry area can be changed by one of the following methods.

NOTE

To change the value in the entry area, the figure in the box should be highlighted. If the figure is not highlighted, press the softkey for the marker you are using (**marker 1** to **marker 10**) or **Focus** to highlight the figure.

- Enter a numeric value using the ENTRY block key on the front panel.
- Turn the rotary knob (⊙) on the front panel.
- Press the up or down arrow key (⬆️⬇️) on the front panel.
- Using the mouse, click one of the buttons (▲▼) on the right side of the entry area.

You can move the marker by dragging and dropping either one of the marker position pointers above or below the graph (▲) (pressing the button on the object to be moved and releasing the button on the destination). You can also move a marker itself by dragging and dropping it.

Step 5. When using other markers, repeat Step 3 and Step 4.

Data Analysis and Result Output

Analyzing Data on Trace Using Marker

- Step 6.** Read the marker stimulus value and marker response value displayed in the upper part of the trace screen.
- Step 7.** To turn off marker(s), press the **Clear Marker Menu** and then press one of the softkeys as follows:

Softkey	Function
All OFF	Turns off all markers on active trace
Marker 1 to Marker 10	Turns off one of markers 1 through 6 on active trace

Changing Display Position of Marker Value

You can change the display position of the marker value on the graph.

Operational Procedure

- Step 1.** Press **Trace Next** or **Trace Max** to activate the trace on which you want to use the marker.
- Step 2.** Press **Display**.
- Step 3.** Press **Marker Information** to change the display position.

Softkey	Function
Left	Displays marker value in upper-left part of graph
Right	Displays marker value in upper-right part of graph

You can also view the marker values in a list. For more information, refer to “Listing All Marker Values in All Displayed Traces” on page 207.

Specifying Sweep Range by Using Marker

You can copy the active marker value to the position of start, stop or center.

NOTE If multiple markers are present on the active trace, only the active marker can be moved.

NOTE This function is not available for the transient measurement.

Operational Procedure

- Step 1.** Press **Trace Next** or **Trace Max** to activate the trace on which you want to use the marker.
- Step 2.** Press **Marker →**.
- Step 3.** Press the corresponding softkey to specify the sweep range.

Softkey	Function
Marker to Start	Changes start value to be equal to stimulus value of active marker on current active trace
Marker to Stop	Changes stop value to be equal to stimulus value of active marker on current active trace
Marker to Center	Changes center value to be equal to stimulus value of active marker on current active trace

Reading Relative Value From Reference Point on Trace

You can convert the marker reading to a relative value from the reference point.

Figure 6-1 Reference Marker Mode

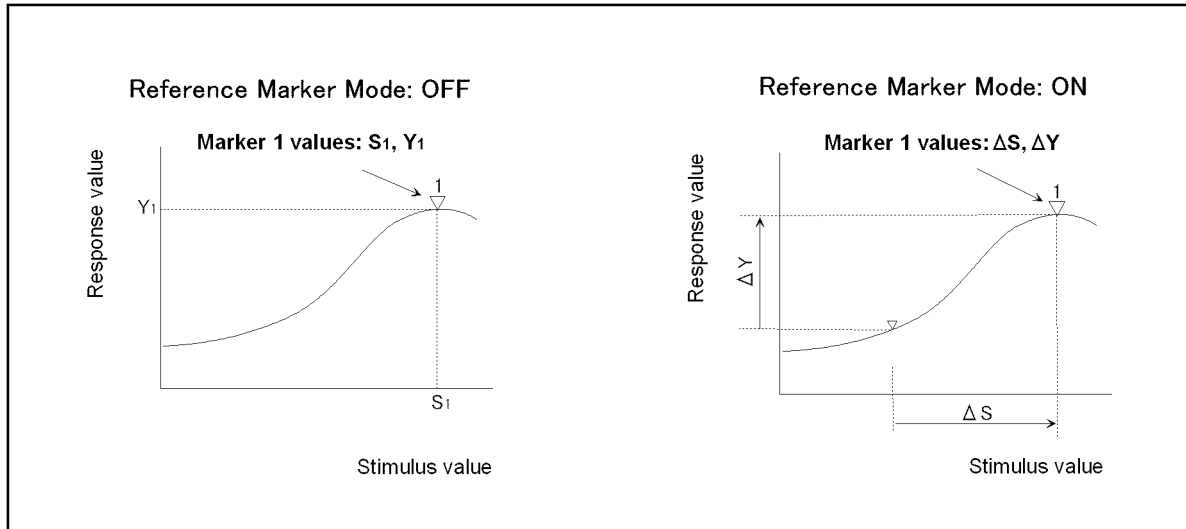

e5070aue121

Operational Procedure

Step 1. Press **Trace Next** or **Trace Max** to activate the trace on which you want to use the marker.

Step 2. Press **Marker**.

Step 3. Press **More functions**.

Step 4. Press **Ref Marker** to specify the reference marker (Marker 1 through 6).

By default, marker 1 is set as the reference marker.

Step 5. Press **Ref Marker Mode** to turn on the reference mode.

Activate the reference marker if it is not active.

With the reference mode turned on, the stimulus values and response values are indicated in relative values referred to by the position of the reference marker.

NOTE

While the reference marker mode is turned on, you cannot view the relative value from the reference point unless the delta marker mode is set to 'ON'.

Step 6. Following Step 4 in "Reading Values on Trace" on page 201, place the reference marker on the point to be used as the reference.

Step 7. Following Step 3 to Step 4 in "Reading Values on Trace" on page 201, place markers 1 through 6 on the desired points to read the values.

To use the list view of the marker values, refer to "Listing All Marker Values in All Displayed Traces" on page 207.

Reading Only Actual Measurement Point/Reading Value Interpolated Between Measurement Points

The point on the trace on which a marker can be placed differs depending on how the discrete marker mode is set up.

Turning on discrete mode (Discrete ON)

A marker moves only between actual measurement points. When a specific marker stimulus value is specified as a numerical value, the marker is placed at the measurement point closest to the specified value. A marker that is placed between interpolated points with the discrete mode off automatically moves to the nearest measurement point when the discrete mode turns on.

Turning off discrete mode (Discrete OFF)

The marker can move from one actual measurement point to another. Because it is interpolated, it can also move in the space between measurement points.

Figure 6-2

Marker Discrete Mode

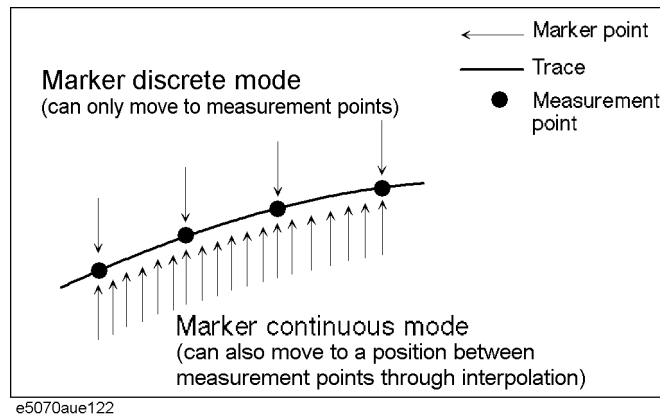

Operational Procedure

- Step 1.** Press **Trace Next** or **Trace Max** to activate the trace on which you want to use the marker.
- Step 2.** Press **Marker**.
- Step 3.** Press **More functions**.
- Step 4.** Press **Discrete** to turn the discrete mode on or off.

Setting Up Markers for Each Trace/Setting up Markers for Coupled Operations Between Traces

Markers can be set up and moved either in a coupled operation for all traces in a channel or independently for each trace.

You can set up marker coupling for frequency/power measurement, transient measurement and the user window.

Figure 6-3

Marker Coupling

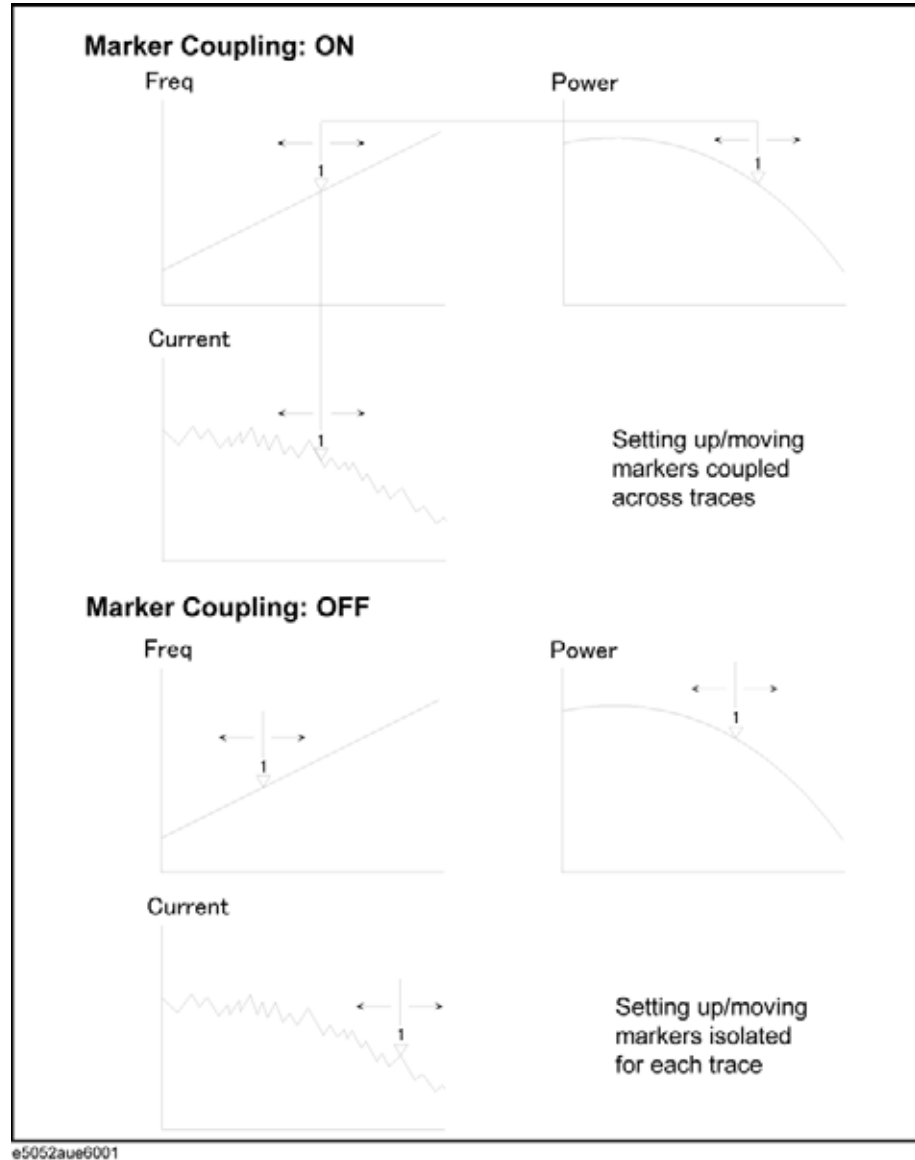

**Marker Couple is on
(Couple ON)**

Markers are set up and moved in coupled operation on all traces in a channel.

**Marker Couple is off
(Couple OFF)**

Markers are set up and moved independently for each trace.

Operational Procedure

- Step 1.** Press **Trace Next** or **Trace Max** to activate the trace on which you want to use the marker.
- Step 2.** Press **Marker**.
- Step 3.** Press **Couple** to turn the marker coupling on or off.

NOTE

For the transient measurement, both the marker coupling (Couple) and the marker discrete mode are turned on, where the active marker on the active trace operates in the discrete mode; however, the other subsequent markers are not always on the measurement point, since they are coupled with the value.

Listing All Marker Values in All Displayed Traces

You can list all of the marker values for all traces on the marker list display.

Operational Procedure

- Step 1.** Press **Marker**.
- Step 2.** Press **Marker List** to turn on the marker list display.

The marker list is displayed in the lower part of the screen (Figure 6-4).

Figure 6-4 Turning on Marker List

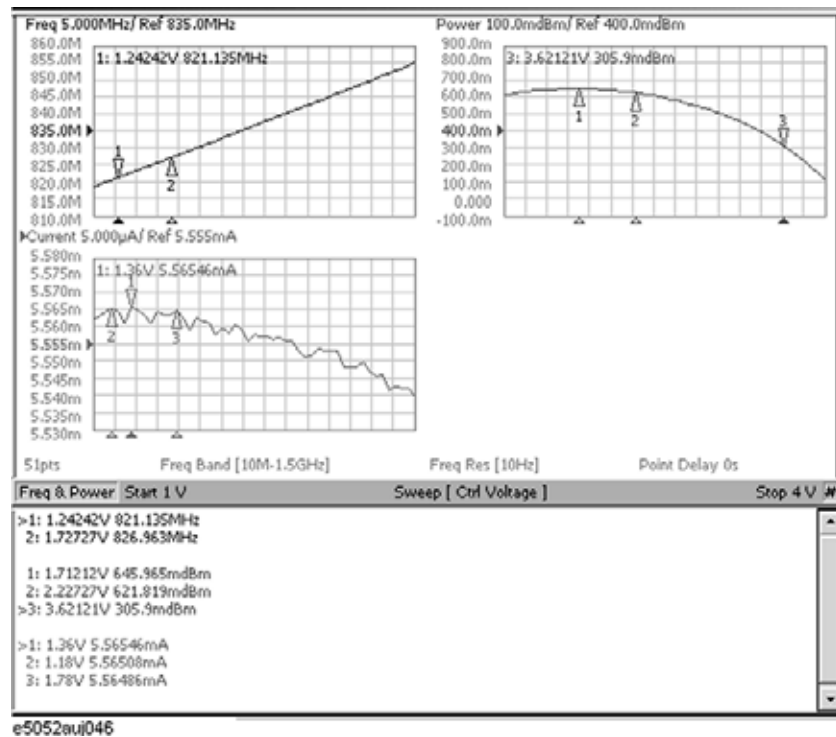

Searching for Positions that Match Specified Criteria

You can search for a position that matches your specified criteria by using the Marker Search feature.

Marker Search allows you to search for a position that matches the following criteria.

- Maximum value
- Minimum value
- Target (a point that has a target measurement value)
 - Target nearest to marker position
 - Target nearest to left-hand side of marker position
 - Target nearest to right-hand side of marker position
- Peak
 - Maximum peak (for a positive peak), minimum peak (for a negative peak)
 - Peak nearest to left-hand side of marker position
 - Peak nearest to right-hand side of marker position





Setting Search Range (Bandmarkers)



The Marker Search feature allows you to set part of the sweep range as the search target (Bandmarker feature) as well as the entire search range.

Procedure to Set Search Range

- Step 1.** Press **Trace Next** or **Trace Max** to activate the trace on which you want to use the marker.
- Step 2.** Press **Marker Fctn** (or press **Marker Search**).
- Step 3.** To set the search range for the X-axis, turn on **Bandmarker X**.
- Step 4.** Set the search range using **X start**, **X stop**, **X center** and **X span**.

Each value for the search range can be changed by one of the following methods.

- Enter a numeric value using the ENTRY block key on the front panel.
- Turn the rotary knob () on the front panel.
- Press the up or down arrow key ( ) on the front panel.
- Using the mouse, click one of the buttons ( ) on the right side of the entry area.

You can move the search range by dragging and dropping either one of the bandmarker position pointers (  ) above the graph (pressing the button on the object to be moved and releasing the button on the destination). You can also drag and drop the start/stop line of the search range.

- Step 5.** To set the search range for the Y-axis, turn on **Bandmarker Y**.

Step 6. Set the search range using **Y start**, **Y stop**, **Y center** and **Y span**.

Each value for the search range can be changed by one of the following methods.

- Enter a numeric value using the ENTRY block key on the front panel.
- Turn the rotary knob (⊙) on the front panel.
- Press the up or down arrow key (⬆️⬇️) on the front panel.
- Using the mouse, click one of the buttons (▲▼) on the right side of the entry area.

You can move the search range by dragging and dropping either one of the bandmarker position pointers (↖️ → ↘️) above the graph (pressing the button on the object to be moved and releasing the button on the destination). You can also drag and drop the start/stop line of the search range.

Searching in Specified Range

Procedure to Set Search Range

- Step 1.** Press **Trace Next** or **Trace Max** to activate the trace on which you want to use the marker.
- Step 2.** Press **Marker Search**.
- Step 3.** To perform the partial search for the stimulus value (x-axis), press **Search Range(X)** to select Bandmarker.
- Step 4.** To perform the partial search for the response value (y-axis), press **Search Range(Y)** to select Bandmarker.

Fullspan Search (Full Range)

All data on the trace are specified as the search target.

Left search (Bandmarker)

Partial data on the trace are specified as the search target.

Setting up Bandmarker for Each Trace/Setting up Markers for Coupled Operations Between Traces

The bandmarkers can be set up and moved either in coupled operation for all traces in a channel or independently for each trace.

You can set up bandmarker coupling for frequency/power measurement, transient measurement and the user window.

Figure 6-5 Bandmarker Coupling

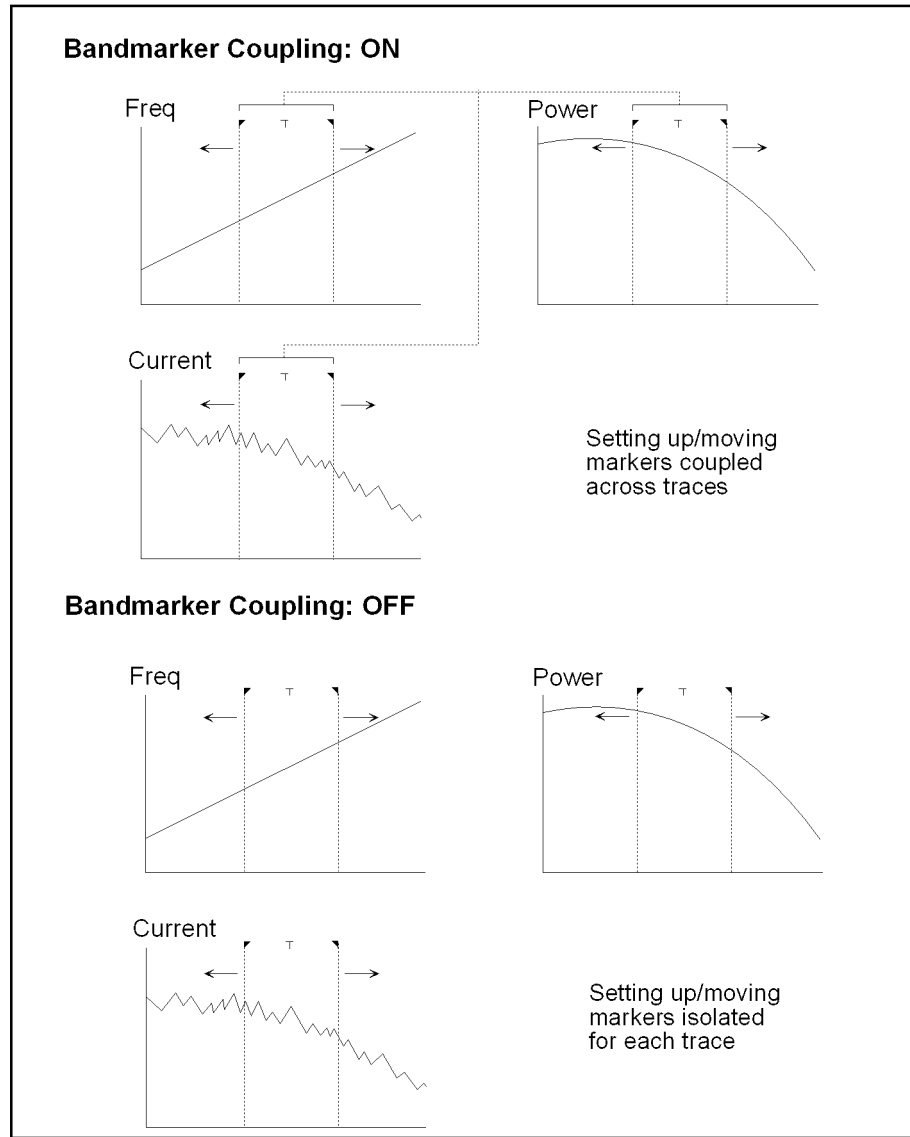

Bandmarker Couple is on (Couple ON) Bandmarkers are set up and moved in coupled operation on all traces in a channel.

Bandmarker Couple is off Bandmarkers are set up and moved independently for each trace.
(Couple OFF)

Operational Procedure

- Step 1.** Press **Trace Next** or **Trace Max** to activate the trace on which you want to use the marker.
- Step 2.** Press **Marker Fctn** (or press **Marker Search**).
- Step 3.** Now you can set up the bandmarker. For more information, refer to “Setting Search Range (Bandmarkers)” on page 208.
- Step 4.** Press **Couple** to turn the marker coupling on or off.

NOTE You cannot turn on the bandmarker coupling for the x-axis.

Automatically Executing Search Each Time Sweep is Done (search tracking)

Search tracking is a function that sets a search to be repeated every time a sweep is done. This function facilitates the observation of measurement results, such as the maximum value of traces.

Operational Procedure

- Step 1.** Press or to activate the trace on which search tracking is set up.
- Step 2.** Press .
- Step 3.** Press **Tracking** and specify the parameters of the search tracking function.

Off	Turns off search tracking function
Maximum value	Specifies the maximum value for search tracking function
Minimum value	Specifies the minimum value for search tracking function
Peak	Specifies the peak for search tracking function
Target	Specifies the target for search tracking function

Searching for Maximum and Minimum Measured Values

You can search for the maximum or minimum measured value on the trace and move a marker to that point (Figure 6-6).

Figure 6-6

Searching for Maximum and Minimum Measured Values

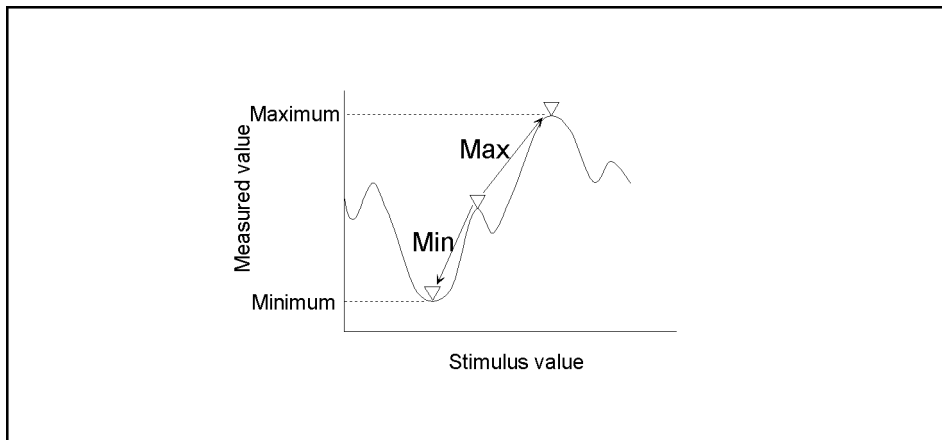

e5070aue047

Search for maximum (Max) Moves active marker to point on trace where measured value is greatest

Search for minimum (Min) Moves active marker to point on the trace where measured value is lowest

Operational Procedure

- Step 1.** Following Step 1 to Step 3 in “Reading Values on Trace” on page 201, activate the marker you will use to search for the maximum and minimum values.
- Step 2.** Press **Marker Search**.
- Step 3.** Press the corresponding softkey to move the marker to the maximum or minimum measured value.

Softkey	Function
Search Max	Performs a search for the maximum value
Search Min	Performs a search for the minimum value

Figure 6-8

Target Search (when transition type is set to “both positive and negative”)

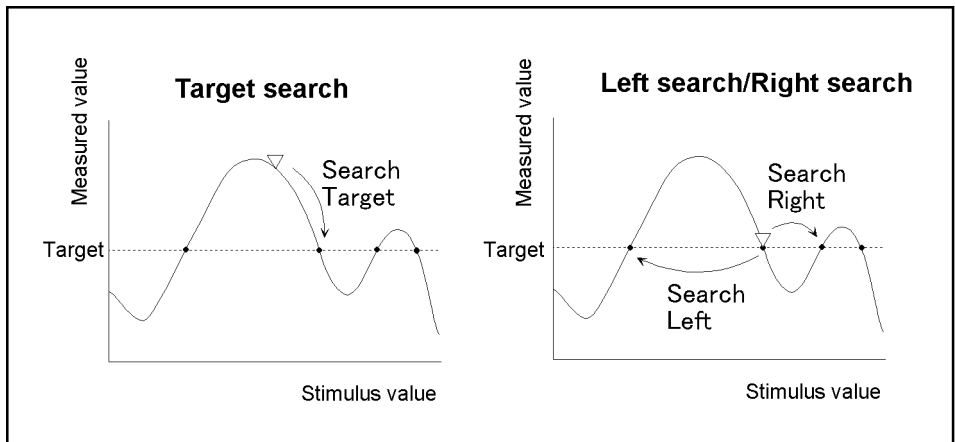

e5070aue048

Operational Procedure

Step 1. Following Step 1 through Step 3 in “Reading Values on Trace” on page 201, activate a marker you are using for the target search.

Step 2. Press **Marker Search**.

Step 3. Press **Target**.

Step 4. Press **Target Value** and enter a target value in the entry box that appears.

The marker target search will be executed based on the newly set target value and the transition type defined.

Step 5. Press **Target Transition**.

Step 6. Select a transition type.

Softkey	Function
Positive	Selects positive as transition type
Negative	Selects negative as transition type
Both	Selects both positive and negative as transition type

The marker target search will be executed based on the definitions of the currently set target value and the newly set transition type. Each marker is allowed to have the peak excursion value and the peak polarity individually.

Step 7. Press the corresponding softkey to move the marker to the target.

Softkey	Function
Search Target	Executes target search
Search Left	Executes left search
Search Right	Executes right search

Searching for Peak

The peak search function enables you to move the marker to the peak on the trace.

Definitions of Peaks

A peak is a measurement point whose value is greater or smaller than the adjoining measurement points on its right and left sides. Peaks are classified into the following types depending on the difference in magnitude from the measurement points on either side of it.

Positive peak (Positive) A peak whose measurement value is greater than those of the measurement points on either side of it (peak polarity: positive)

Negative peak (Negative) A peak whose measurement value is smaller value than those of measurement points on either side of it (peak polarity: negative)

About the peak search function

The peak search is a function that searches for a peak that matches a pre-defined lower limit for the peak excursion value and peak polarity (positive or negative) and then moves the marker to this peak.

The peak excursion is the smaller of the differences in measurement values from the adjoining peaks of the opposite polarity.

Figure 6-9

Positive Peak, Negative Peak and Peak Excursion

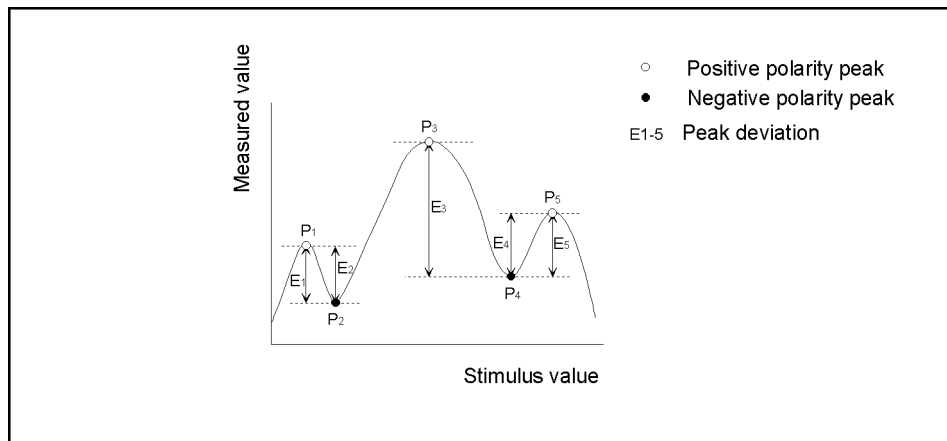

e5070aue051

The following four methods are available for executing the peak search:

Search peak (Search Peak)	Moves marker to the maximum peak when peak polarity is Positive or Both ; moves marker to the minimum peak when peak polarity is Negative
Search all peaks (Search Peak All)	Moves marker to the maximum peak when peak polarity is Positive or Both ; moves marker to the minimum peak when peak polarity is Negative
Search left (Search Left)	Executes search from current marker position to the smaller stimulus values and moves marker to the first peak encountered
Search right (Search Right)	Executes search from current marker position to the larger stimulus values and moves marker to the first peak encountered

Figure 6-10

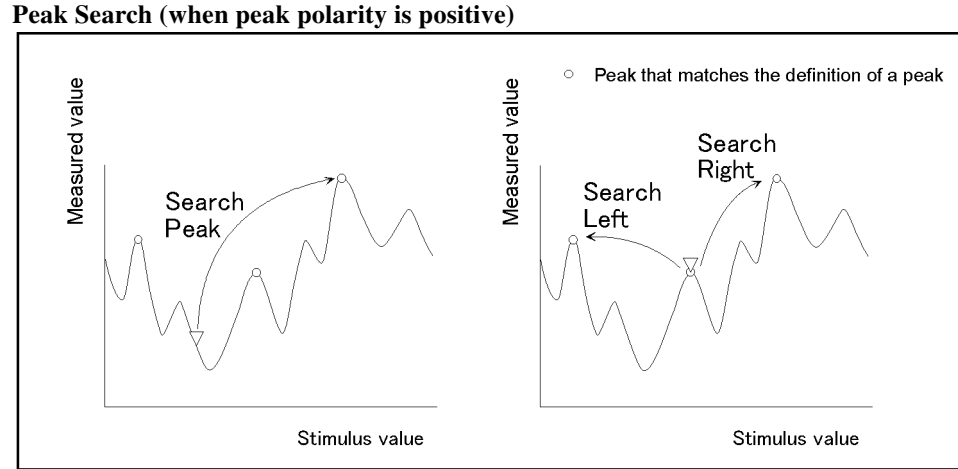

Operational Procedure

Step 1. Following Step 1 through Step 3 in “Reading Values on Trace” on page 201, activate a marker you are using for the peak search.

Step 2. Press **Marker Search**.

Step 3. Press **Peak**.

Step 4. Press **Peak Excursion** and enter the lower limit for the peak excursion value.

The marker peak search will be executed based on the definitions of the newly set lower limit for the peak excursion value and the currently set peak polarity.

Step 5. Press **Peak Polarity**.

Step 6. Select a peak polarity.

Softkey	Function
Positive	Selects Positive as the peak polarity
Negative	Selects Negative as the peak polarity
Both	Selects Both Positive and Negative as the peak polarity

The marker peak search will be executed based on the definitions of the currently set lower limit for the peak excursion value and the newly set peak polarity. Each marker is allowed to have the peak excursion value and the peak polarity individually.

Step 7. Press the corresponding softkey to move the marker to the peak.

Softkey	Function
Search Peak	Executes peak search
Search Left	Executes left search
Search Right	Executes right search

Searching for Multiple Peaks

The multi-peak search function enables you to display markers on multiple peaks on traces.

About Peak Search All Functions (Peak Search All)

The peak-search-all is a function that searches for peaks that match a pre-defined lower limit for the peak excursion value and peak polarity (positive or negative) and then displays the markers on these peaks. Up to 6 markers can be displayed.

The peak excursion is the smaller of the differences in measurement values from the adjoining peaks of the opposite polarity.

Figure 6-11

Peak Search All (when peak polarity is positive)

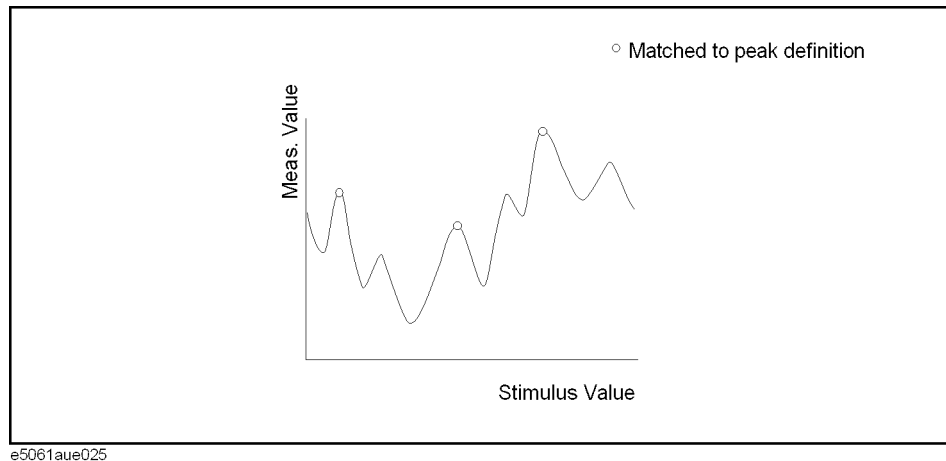

Operational Procedure

Step 1. Following Step 1 through Step 3 in “Reading Values on Trace” on page 201, display the multiple markers you are using for the peak search.

NOTE

The peak search is executed as many times as the number of markers displayed (up to 6).

Step 2. Press **Marker Search**.

Step 3. Press **Peak**.

Step 4. Press **Peak Excursion** and enter the lower limit for the peak excursion value.

This sets the multiple peak searches to be executed based on the definitions of the newly set lower limit for the peak excursion value and the currently set peak polarity.

Step 5. Press **Peak Polarity**.

Step 6. Select a peak polarity.

Softkey	Function
Positive	Selects Positive as the peak polarity.
Negative	Selects Negative as the peak polarity
Both	Selects Both Positive and Negative as the peak polarity

This sets the multiple peak searches to be executed based on the definitions of the currently set lower limit for the peak excursion value and the newly set peak polarity.

Step 7. Press **Search Peak All** to move the marker to the peak.

Determining Mean, Standard Deviation, and Peak-to-Peak of the Trace

You can easily determine the statistics data for the trace between marker 1 and marker 2 (mean, standard deviation, and peak-to-peak). Figure 6-12 and Table 6-1 show the definitions for the statistics data elements.

Figure 6-12

Parameters Used for Calculating Statistics Data

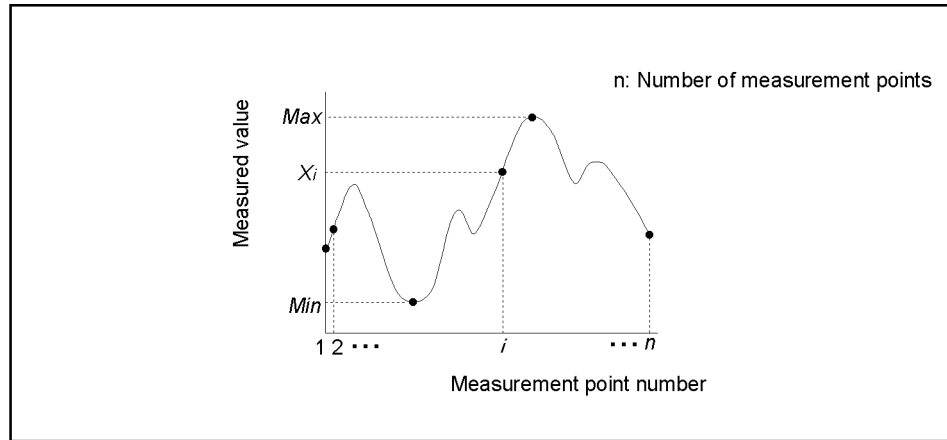

e5070aue053

Table 6-1

Definitions of Statistics Data

Statistics data element	Definition
Average (Mean)	$\frac{\sum_{i=1}^n x_i}{n}$ (in: number of points; xi: i measured value at the i-th measurement point)
Standard deviation (SDev)	$\sqrt{\frac{\sum_{i=1}^n \langle x_i - mean \rangle^2}{n - 1}}$ (n: number of points; xi: measured value at the i-th measurement point; mean: mean)
Peak-to-Peak (PtoP)	$Max - Min$ (Max: greatest measured value; Min: smallest measured value)

Specifying Range for Statistical Data

- Step 1.** Press **Trace Next** or **Trace Max** to activate the trace for which you want to obtain statistical data.
- Step 2.** Press **Marker Fctn**.
- Step 3.** Specify the range (x/y-axis) from which you want to obtain statistical data.

Full Range (Fullscale) Statistical data are obtained from all traces

Bandmarker (Bandmarker) Statistical data are obtained from within bandmarker

To set up the bandmarker, refer to “Setting Search Range (Bandmarkers)” on page 208.

Displaying Statistical Data

- Step 1.** Press **Trace Next** or **Trace Max** to activate the trace for which you want to obtain statistical data.
- Step 2.** Press **Marker Fctn**.
- Step 3.** Specify the range (x/y-axis) from which you want to obtain statistical data. For more information, refer to “Specifying Range for Statistical Data” on page 221.
- Step 4.** Set the **Analysis Type** to **Statistics**.

NOTE

Turning on the marker list displays statistics data in a list. To display the marker list, refer to “Listing All Marker Values in All Displayed Traces” on page 207.

Comparing Traces/Performing Data Math

Each of the traces for which measured data are displayed is provided with an additional trace, called a memory trace, that temporarily stores the measured data. You can use the memory trace to compare traces on the screen or to perform data math between the memory trace and measured data.

The following data math operations are available:

- Data / Memory** Divides measured data by the data in the memory trace; this function can be used to evaluate the ratio of two traces (e.g., evaluating gain or attenuation).
- Data * Memory** Multiplies measured data by a memory trace
- Data – Memory** Subtracts a memory trace from measured data.
- Data + Memory** Adds measured data and data in the memory trace

Operational Procedure

- Step 1.** Press **Trace Next** or **Trace Max** to activate the trace that you want to save in the memory.
- Step 2.** Press **Trace/View**.
- Step 3.** Press **Data** → **Mem** to store the measured data in memory.
- Step 4.** Press **Data Math**.
- Step 5.** Select the data math operation to perform.

Softkey	Function
OFF	Turns off data math functions (Do not perform data math)
Data / Mem	Divides measured data by the memory trace and stores result in the data trace
Data * Mem	Multiplies the data trace by the memory trace and stores result in the data trace
Data – Mem	Subtracts the memory trace from data trace and stores result in the data trace
Data + Mem	Add the data trace and memory trace and store the result in the data trace

- Step 6.** Press **Display Trace**.

Step 7. Select the type of data to display on the screen.

Softkey	Function
Data	Displays only data trace on the screen
Mem	Displays only memory trace stored by Data → Mem operation on the screen
Data & Mem	Displays data trace and memory trace on the screen (You can now easily compare the data trace and memory trace on the screen.)
Off	Turns off display of the trace

Step 8. Apply the trigger to make measurements.

Comparing Measurement Results in User Window

Up to eight measurement data can be retained in a user window. You may want to copy the multiple data that were measured with different settings to the user window so that you can compare them on the same screen.

When you copy traces of phase-noise measurement to the user window, carrier frequency and level are also copied in the upper-right area of the graph. Since this value is treated as annotation, you can change or delete it later.

Copy Traces to User Window

- Step 1.** Press **Trace Next** or **Trace Max** to activate the trace you want to copy.
- Step 2.** Press **Trace/View**.
- Step 3.** Press **Copy to USER**
- Step 4.** From **Copy to USER1** to **Copy to USER8**, select user window trace of the copy destination.
- Step 5.** Press **Meas/View** - **User** to select the user window. The trace that has been copied to the user window is displayed.

NOTE Note that you are viewing the sweep range of the active trace in the user window.

Add Annotation to Each Trace in User Window

You can add annotation to each active trace, and only the annotation of the active trace is displayed in the upper-right area of the graph.

- Step 1.** Press **Trace Next** or **Trace Max** to activate the trace to be copied.
- Step 2.** Press **Trace/View**.
- Step 3.** Press **Trace Annotation**
- Step 4.** When the dialog box appears, enter the annotation.

NOTE You can also use the keyboard to enter the annotation.

Limit Test

The limit test feature allows you to set the limit line for each trace and then perform the pass/fail judgment for the measurement result.

Concept of Limit Test

The limit test is a function to perform pass/fail judgment based on the limit line you set.

In the limit test, if the upper limit or lower limit indicated by the limit line is not exceeded, the judgment result is pass; if it is exceeded, the judgment result is fail for all measurement points on the trace. Measurement points in a stimulus range with no limit line are judged as pass.

NOTE

The targets of the pass/fail judgment are measurement points only. Parts interpolated between measurement points are not judged.

You define the limit line by specifying the stimulus value (Begin Stimulus) and response value (Begin Response) of the begin point, the stimulus value (End Stimulus) and response value (End Response) of the end point. For more information, refer to “Defining Limit Line” on page 227.

When the limit test is on, measurement points that fail are displayed in red on the screen and the measurement’s pass/fail judgment result based on the results of individual measurement points (fail if one or more measurement points on the trace fail) is also displayed. For more information, refer to “Displaying Judgment Result of Limit Test” on page 226.

In addition to viewing the screen, you can check the judgment result of the limit test by the following methods.

- Using the status register (for more information, refer to the Programmer's Guide).
- 24-bit I/O (for more information, refer to the Programmer's Guide).

Displaying Judgment Result of Limit Test

Measurement points determined as “Fail” will be displayed red on the screen. The determination result of a measurement can be displayed in the following two methods:

- Either “Pass” or “Fail” is displayed in the lower-right part of the measurement window. The result can be seen whenever the limit test is turned on.
- “Fail” can be displayed in the center of the measurement window. You can specify display/hide by following the steps below.

Step 1. Press **Display**

Step 2. Press **Limit Test** to display the limit test menu.

Step 3. Press **Fail Sign**. Each press toggles between on/off.

Figure 6-13 Limit Test Result

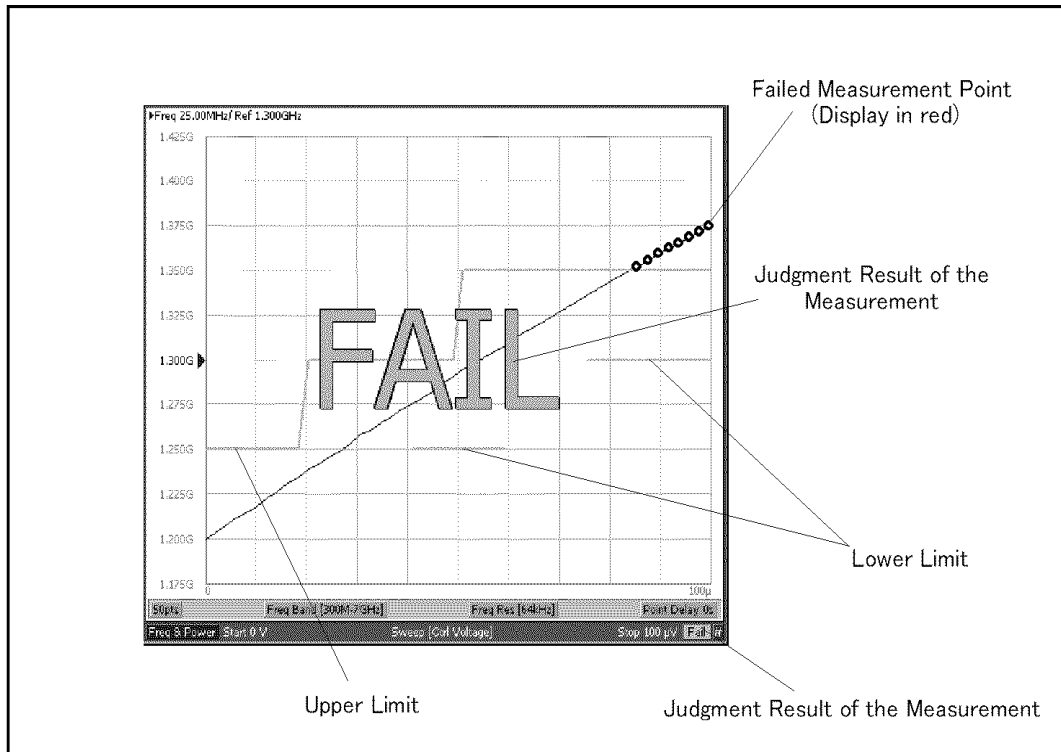

e5052aue3002

NOTE

In the tester mode during the frequency/power measurement mode, either “Pass” or “Fail” is displayed in the lower and the upper right part of the measurement window. Measurement data determined as “Fail” will be shown in red.

Turning On or Off the Beeper in Limit Test

Turn on the warning beeper if you want to sound an alarm when a measurement is determined as “Fail” in the limit test. Refer to the “Setting the Beeper (Built-in Speaker)” on page 286 to turn on or off the warning beeper.

Defining Limit Line

You must define the limit lines before you can use the limit test function. The upper and lower limit lines can be retained for each trace, and up to 100 limit lines (segments) can be defined in each limit line.

Defining Segment

Follow the steps below to define the segments.

- Step 1.** Create upper and lower values for limit lines in the following format, and then save them in the CSV format (with the *.csv extension).

x_start, y_start, x_stop, y_stop

x_start, y_start, x_stop, y_stop

:

x_start, y_start, x_stop, y_stop

Parameter	Overview
x_start	the starting point for the stimulus value on the limit line
y_start	the ending point for the stimulus value on the limit line
x_stop	the starting point for the response value on the limit line
y_stop	the ending point for the response value on the limit line

NOTE

Save the upper limit values together into one file, and the lower limit values into another.

One line represents one segment. Even when specifying 0 for the stimulus range, you must provide both the start and the stop values.

For the tester mode during the frequency/power measurement mode, the response value corresponding to a stimulus value of 0 will be used as the limit value.

- Step 2.** Activate the trace to which you want to apply the limit test function.

- Step 3.** Press **[Display]** - **Limit Test** to display the Limit Test menu.

- Step 4.** Press **Import Upper Limit Line.../Import Lower Limit Line...** to open the file with the *.csv extension, which contains the predefined upper/lower values.

NOTE

In order to edit the predefined upper/lower values file and reflect it to the limit test, you must once again open the file by pressing **Import Upper Limit Line.../Import Lower Limit Line...**

NOTE

You can specify the limit lines so that they may overlap other limit lines as you like. If you set limit lines on which stimulus ranges overlap one another, the measurement points within the range will have multiple limit values. In that case, the limit value to be used for the limit test will be as follows:

- If multiple upper limit values exist within the same range, the lowest value will be used

Data Analysis and Result Output

Limit Test

as the upper limit value.

- If multiple lower limit values exist within the same range, the highest value will be used as the lower limit value.

Turning On or Off the Limit Test

You can set the limit test on/off for each trace individually. Follow the steps below to set the limit test to on/off.

Operational Procedure

The following steps describe how to save/call the limit table. Use the external keyboard and mouse for the operations listed below.

- Step 1.** Activate the trace to which you want to apply the limit test function.
- Step 2.** Press **[Display]** - **Limit Test** to display the Limit Test menu.
- Step 3.** Press **Limit Test** and turn on the Limit Test. You can also display the limit lines on the screen by turning on the Limit Line.

NOTE

In tester mode during the frequency/power measurement, the limit values can be turned on or off with the Limit Line softkey.

Initializing Limit Lines

The following operations initialize the limit lines.

- At power-on
- When presetting
- When **Delete Upper Limit Line/Delete Lower Limit Line** is pressed in the Limit Test menu

File Saving and Loading Instrument Status Settings

You can save the state of the instrument as a file in a hard disk, floppy disk, etc. and recall the file for later use. You can choose one of the two options below for file saving.

Table 6-2 **Content to be Saved**

Type	Content to be saved and used
State Only (State Only)	You can save the E5052A's state settings* ¹ and recall them later to set up the instrument to the same state as previously used.
State and Data	You can save the E5052A's state settings* ¹ and trace (formatted data arrays and formatted memory arrays) and recall them later to set up the instrument to the same state as previously used. Here, the trace can also be recalled and displayed on the screen.

*1. For the content of saving, refer to Appendix C, "List of Default Values."

NOTE Irrespective of the selected measurement window, all of the state settings and settings/data are saved or recalled.

NOTE If an incompatible file is recalled, the settings will be preset due to error.

Compatibility of Files Related to Saving and Recalling

Table 6-3 **Compatibility of Files**

		Recalling	
		Standard	Option 011
Saving	Standard	Yes	Yes* ¹
	Option 011	Yes	Yes

*1. If files saved with the standard model contain data trace, "state & data", having not-allowed parameters such as start offset frequency down to 1 Hz, they cannot be recalled with the option 011. In case that files contain instrument settings only, "state only", which is not available for the option 011, that parameters is automatically set to the initial settings of the option 011.

Table 6-4 Parameters to be Set to Initial Values When Recalling Files Saved with Incompatible Values Between Options

Parameter	Value saved with the standard model	Value will be changed when recalling with the option 011
Phase noise - Correlation	Other than 1	1
Phase noise - IF Gain	Higher than or equal to 20 dB	Changed to 20 dB
Frequency & power - Trigger mode ^{*1}	“Analyzer mode”	“Tester mode”
Phase noise -- Start offset frequency ^{*2}	1 (Hz)	10 (Hz)

*1. A warning message as “Incompatible recall file” is displayed.

*2. The phase noise trace data is not recalled AND warning message as “Incompatible recall file” is displayed, when files saved as “state & data” AND contain 1 Hz start off-set frequency.

Table 6-5 Compatibility Between Different Firmware Revisions

			Recalling							
			A.02.50		A.02.00		A.01.50		Before A.01.10	
			Standard	Option 011	Standard	Option 011	Standard	Option 011	Standard	Option 011
Saving	A.02.50	Standard	Yes	Yes ^{*1}	Yes ^{*1}	Yes ^{*1}	Yes ^{*1}	Yes ^{*1}	Yes ^{*1}	Yes ^{*1}
		Option 011	Yes	Yes	Yes ^{*1}	Yes ^{*1}	Yes ^{*1}	Yes ^{*1}	Yes ^{*1}	Yes ^{*1}
	A.02.00	Standard	Yes ^{*1}	Yes ^{*1}	Yes	Yes ^{*1}	Yes ^{*1}	Yes ^{*1}	Yes ^{*1}	Yes ^{*1}
		Option 011	Yes ^{*1}	Yes ^{*1}	Yes	Yes	Yes ^{*1}	Yes ^{*1}	Yes ^{*1}	Yes ^{*1}
	A.01.50	Standard	Yes ^{*1}	Yes ^{*1}	Yes ^{*1}	Yes ^{*1}	Yes	Yes ^{*1}	Yes ^{*1}	Yes ^{*1}
		Option 011	Yes ^{*1}	Yes ^{*1}	Yes ^{*1}	Yes ^{*1}	Yes	Yes	Yes ^{*1}	Yes ^{*1}
	Before A.01.10	Standard	Yes ^{*1}	Yes ^{*1}	Yes ^{*1}	Yes ^{*1}	Yes	Yes ^{*1}	Yes	Yes ^{*1}
		Option 011	Yes ^{*1}	Yes ^{*1}	Yes ^{*1}	Yes ^{*1}	Yes	Yes	Yes	Yes

*1. “Incompatible recall file” warning message may be displayed when files saved with older firmware revision is recalled with the newer one. In this case, the parameters which are incompatible with the older firmware revision are ignored when recalling.

NOTE

If revision difference includes any additional save/recall items, the recall operation will result in a message “Incompatible recall file,” recalling all of the saved items but the

additional ones. If the difference includes no additional save/recall items and no changes in the save/recall specification, the recall operation will end normally.

NOTE

When the state file that has created with the E5052A firmware Rev.A.01.50 or before is recalled in the E5052A with the Rev.A.02.00 firmware, all of the setup parameters concerning the E5053A Microwave Downconverter are neglected and the E5052A Rev.A.02.00 firmware presets to the instrument state as that of the E5052A standalone.

NOTE

The Security Level can be stored or recalled in the E5052A with the Rev.A.02.00 firmware.

When recalling the state file that includes “Frequency Blank” security level, the E5052A’s security level is set to “Frequency Blank” even if the security level was set to None before recalling. When the state file that was created with the Rev.A.01.50 or before, is recalled on the E5052A with the Rev.A.02.00 firmware, the security level is always set to None.

Table 6-6

Content to be Saved

Type	Content to be saved and used
State Only (State Only)	You can saves the E5052A’s state settings ^{*1} and recall them later to set up the instrument to the same state as previously used.
State and Data	You can saves the E5052A’s state settings ^{*1} and trace (formatted data arrays and formatted memory arrays) and recall them later to set up the instrument to the same state as previously used. Here, the trace can also be recalled and displayed on the screen.

*1. For the content of saving, refer to Appendix C, “List of Default Values.”.

Saving Procedure

Selecting Content To Be Saved

NOTE The following steps affect both file saving and memory saving of the instrument state.

- Step 1.** Press **Save/Recall**.
- Step 2.** Press **Save State**.
- Step 3.** Press **Save Type**.
- Step 4.** Press the softkey corresponding to the content of the instrument's state you want to save.

Softkey	Function
State Only	Selects "State Only" to save only the state settings of the E5052A
State & Data	Selects "State and Data" to save the state settings and the trace of the E5052A

Saving Data

Follow the steps below to save the internal data of the E5052A.

Step 1. Press **Save/Recall**.

Step 2. Press **Save State**.

Step 3. When you save the state using the defined file on drive F (State01.sta - State06.sta, Autorec.sta):

Press **State01 - State06** or **Autorec**.

NOTE Irrespective of the selected measurement window, all of the state settings and settings/data are saved.

NOTE A:\Autorec.sta (floppy disk) and F:\Autorec.sta (F drive) can be recalled automatically whenever the E5052A is powered on. If both A:\Autorec.sta and F:\Autorec.sta exist, the former is called. To disable the auto recall function, remove Autorec.sta.

NOTE If the file already exists, the “*” mark will appear to the right of the softkey label. If you specified overwrite of the existing file, it will be copied with the name “backup.sta”, and then the original file will be overwritten.

When you save the state with any file name (including files on the floppy disk):

1. Press **File Dialog...** to open the dialog box. This operation should be done with the external keyboard and/or mouse. Figure 6-14 shows the user interface elements in the “Save As” dialog box.
2. Specify any folder, and enter the file name.
3. Press **Save**.

Figure 6-14

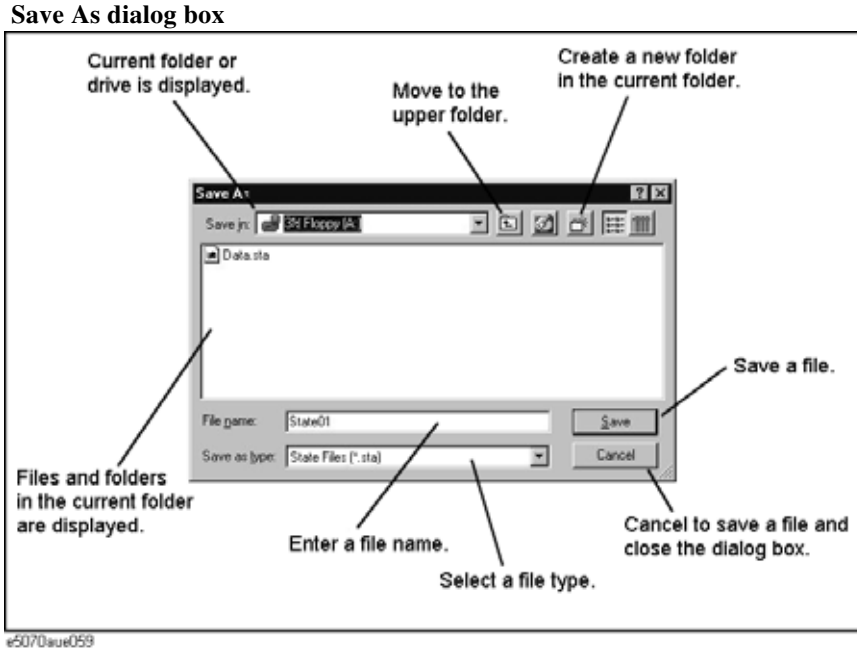

The E5052A provides the following drives to save/recall files. Select a drive in the **Save In** area of the dialog box (Figure 6-14).

Drive name	Description
3.5" Floppy[A:]	Uses a floppy disk drive*1 for saving/recalling the file.
[F:]	Uses a hard disk (F) drive for saving/recalling the file.

*1. Use a 1.44-MB floppy disk formatted in DOS when you use the E5052A's built-in floppy disk drive.

NOTE Do not change any content (i.e. folders or files) in the drives other than A and F. Doing this may cause serious damage to the E5052A's functions and performance.

NOTE **Do not press the disk eject button while the floppy disk access lamp is on.** Trying to forcefully pull the floppy disk out while the lamp is on may damage the floppy disk or disk drive.

Recalling Procedure

NOTE

In recalling the file in which the trace is saved (**State & Data** is specified for saving the content), the trigger sources are recalled and trigger mode is automatically set to 'HOLD'.

Step 1. Press **Save/Recall**.

Step 2. Press **Recall State**.

Step 3. When you recall State01.sta - State06.sta - Autorec.sta:

Press **State01 - State06** or **Autorec**.

When you recall any file:

1. Press **File Dialog...** to open the Open dialog box. This operation should be conducted using the external keyboard and/or mouse. The Figure 6-15 shows the user interface elements on the "Open" dialog box.
2. Specify the folder that contains the file, and then select the file. Press **Open** to recall the saved internal data.

NOTE

Irrespective of the selected measurement window, all of the state settings and settings/data are recalled.

NOTE

Do not press the disk eject button while the floppy disk access lamp is on. Trying to forcefully pull the floppy disk out while the lamp is on may damage the floppy disk or disk drive.

Figure 6-15 Open Dialog Box

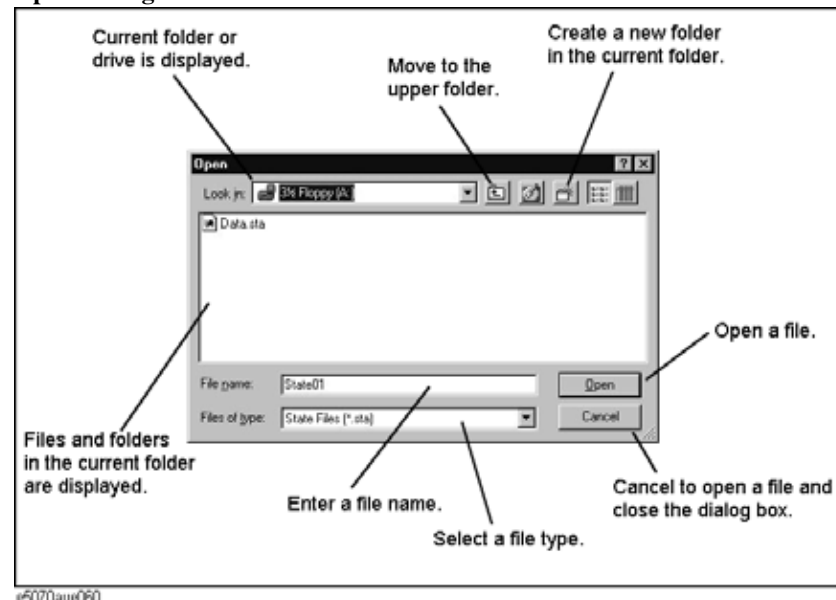

Recall Procedure Using “Recall by File Name” Feature

You can use the recall feature with the **Recall by File Name** softkey for files you have named freely and saved in the F:\State folder. This function lets you recall a file you have named freely and saved by simple softkey operation, eliminating annoying operation using the Open dialog box.

NOTE

Although there is no limit to the number of files saved in a folder, only up to 50 files are displayed on the softkeys. If more than 50 files are saved in a folder, they are sorted in the order of numbers 0 to 9 and alphabetic characters A to Z and the first 50 files are displayed as softkeys.

Although there is no limit to the number of characters of a file name, only up to 12 characters are displayed on the softkey. If a file name exceeds 12 characters, the first 12 characters are displayed on the softkey and the remaining characters are omitted and replaced with “...”.

Note that different files may be displayed on softkeys with the same name or a saved file is not displayed on any softkey because of the above limitations.

- Step 1.** Press **Save/Recall**.
- Step 2.** Press **Recall by File Name**.
- Step 3.** Files that have been named and saved in the F:\State folder are displayed on softkeys. Press the key for the file you want to recall.

Managing Files/Folders

You can manage the files and folders by using Windows® Explorer, which provides such standard operations as copy, move, remove, change name, and format floppy disk.

Figure 6-16

Windows Explorer

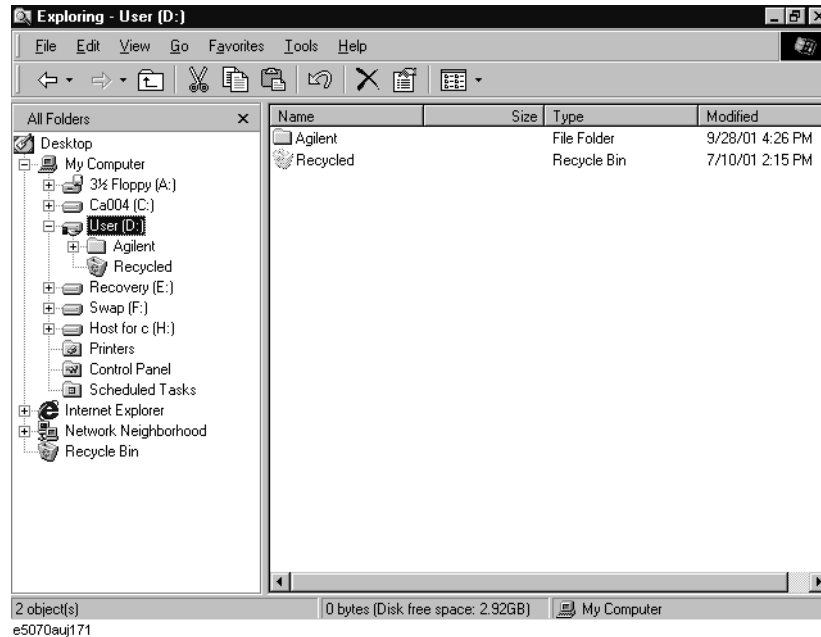

CAUTION

Do not change any content (i.e. folders or files) of the drives other than A and F: This may cause serious damage to the E5052A's functions and performance.

Running Windows Explorer

- Step 1. Press **Save/Recall**.
- Step 2. Press **Explorer...** to open Windows Explorer.

Copying Files/Folders

- Step 1. In Windows Explorer, select any source file or folder for copying.
- Step 2. On the menu bar, select **Edit - Copy**.
- Step 3. Open the target folder for copying.
- Step 4. On the menu bar, select **Edit - Paste**.

Moving Files/Folders

- Step 1. In Windows Explorer, select the file or folder of origin.

Data Analysis and Result Output

Managing Files/Folders

Step 2. On the menu bar, select **Edit - Cut**.

Step 3. Open the destination folder.

Step 4. On the menu bar, select **Edit - Paste**.

Removing Files/Folders

Step 1. In Windows Explorer, select the file or folder to be removed.

Step 2. On the menu bar, select **File - Delete**.

Changing the Name of File/Folder

Step 1. In Windows Explorer, select the file or folder for which you want to change name.

Step 2. On the menu bar, select **File - Rename**.

Step 3. Type the new name for the file or folder and then press on the keyboard.

Formatting Floppy Disk

NOTE

Formatting the disk removes all of the files and folders currently on it.

Step 1. Insert the floppy disk you want to format into the floppy disk drive of the E5052A.

Step 2. Right-click the mouse on the A: drive in Windows Explorer.

Step 3. Select **Format...** from the shortcut menu that appears.

Step 4. Follow the instructions in the dialog box to format the floppy disk.

Saving Trace on File

Saving Trace Data File

You can save the trace data of the E5052A's active trace in the CSV format (with the extension of "*.csv") to recall them for later use on the PC application software.

The trace data are saved in the following format:

Example 6-1

Example of Saved Trace Data (phase noise measurement)

```
Offset Frequency (Hz),Phase Noise (dBc/Hz)
+1.0000000000e+002,-6.11082572643e+001
+1.01800975118e+002,-6.14881381403e+001
+1.03634385350e+002,-5.77826152313e+001
+1.05500814844e+002,-5.81658293608e+001
```

The first line is a header indicating the trace data items that are output from the second line onward.

From the second line, the trace data are output at an amount equivalent to the number of frequency points.

Operational Procedure

Follow the steps below to save the trace data of the E5052A.

- Step 1.** Press **Trace Next** or **Trace Max** to activate the trace on which you want to save the trace data.
- Step 2.** Press **Save/Recall** to open the Save/Recall menu.
- Step 3.** Press **Save Data Trace** to open the "Save As" dialog box. This operation should be conducted using the external keyboard and/or mouse. For information on the Save As dialog box, refer to the description of Figure 6-14, "Save As dialog box," on page 234. Here, the CSV Files (with the extension of *.csv) are selected for the file type.
- Step 4.** Specify the destination folder for saving, enter file name, and then press **Save** to save the file.

NOTE

You cannot recall the trace data while using the Save Data/Memory Trace menu.

NOTE

Do not press the disk eject button while the floppy disk access lamp is on. Trying to forcefully pull the floppy disk out while the lamp is on may damage the floppy disk or disk drive.

Saving Trace Memory

You can save the trace memory of the E5052A's active trace in the CSV format (with the extension of ".csv") to recall them for later use on the PC application software.

The trace memory is saved in the following format:

Example 6-2

Example of Saved Trace Memory (phase noise measurement)

```
Offset Frequency (Hz),Phase Noise (dBc/Hz)
+1.000000000000e+002,-6.11082572643e+001
+1.018009751118e+002,-6.14881381403e+001
+1.03634385350e+002,-5.77826152313e+001
+1.05500814844e+002,-5.81658293608e+001
```

The first line is a header indicating the trace memory items that are output from the second line onward.

From the second line, the trace memory is output at an amount equivalent to the number of frequency points.

Operational Procedure

Follow the steps below to save the trace memory of the E5052A.

Step 1. Press **Trace Next** or **Trace Max** to activate the trace on which you want to save the trace memory.

Step 2. Press **Save/Recall** to open the Save/Recall menu.

Step 3. Press **Save Memory Trace** to open the "Save As" dialog box. This operation should be done with the external keyboard and/or mouse. For information on the Save As dialog box, refer to the description of Figure 6-14, "Save As dialog box," on page 234. Here, the CSV Files (with the extension of *.csv) are selected for the file type.

Step 4. Specify the destination folder for saving, enter the file name, and then press **Save** to save the file.

NOTE

You cannot recall the trace memory while using the Save Data/Memory Trace menu.

NOTE

Do not press the disk eject button while the floppy disk access lamp is on. Trying to forcefully pull the floppy disk out while the lamp is on may damage the floppy disk or disk drive.

Linearity Evaluation of Chirped FM Signal

The linearity evaluation of a chirped FM signal is a function that statistically evaluates errors in test signals by using a reference regression line created by changing the test frequency to the line's values.

This function has two processes: creating the reference regression line and evaluating the linearity of test signals. When evaluating linearity, you can specify the analysis range by using the band marker.

The linearity evaluation of chirped signals can be used for phase-noise measurements and transient measurements.

Create Reference Regression Line

This section describes steps to create a reference regression line based on the following chirped FM signal in transient measurement.

Figure 6-17

Measurement example of chirped FM signal in transient measurement

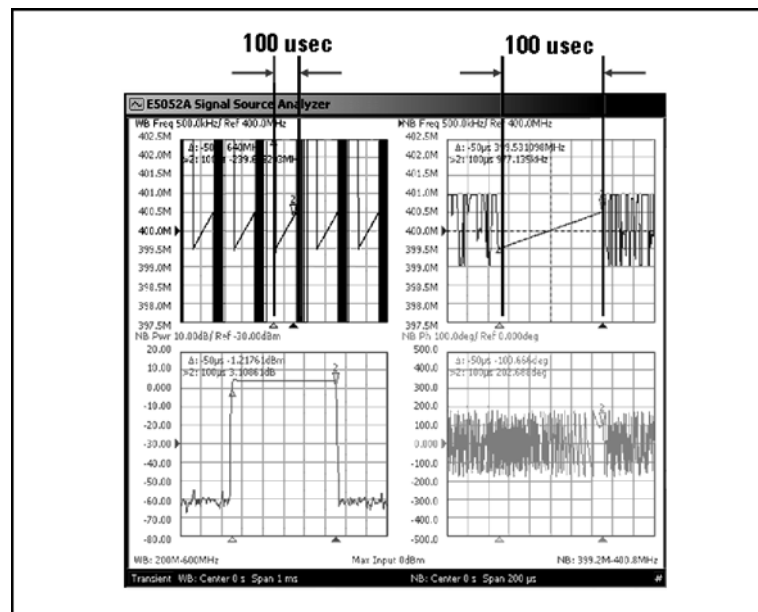

e5052auj5010

Procedure

- Step 1.** Press **Trace Next** or **Trace Max** to activate the trace in which you want to save the trace memory.
- Step 2.** Press **Marker Fctn**.
- Step 3.** Press **Band Marker X** to enable it, and then set the analysis range.
- Step 4.** Press **Trace/View**.
- Step 5.** Press **Memory Trace - Line(Y = AX + B) - A** to enter the value (slope) of the regression line coefficient ($Y = aX + b$).

Data Analysis and Result Output

Linearity Evaluation of Chirped FM Signal

Step 6. Press **B** to enter the value of b (intercept) of the regression line coefficient ($Y = aX + b$).

Step 7. When you want to assign the measurement value currently displayed to the linear regression coefficient, the values of a and b can be obtained by pressing the **DATA Trace -> A,B** button.

NOTE

When fewer than two measurement points are in the analysis range, the values of a and b return to zero.

Step 8. Press **Set Line to Memory** to write into the memory trace.

Evaluate the Linearity

After obtaining the regression line coefficient, calculate error from reference by comparing traces. Here, statistics are used for calculating error (refer to “Determining Mean, Standard Deviation, and Peak-to-Peak of the Trace” on page 220).

Procedure

Step 1. Press **Trace/View**.

Step 2. Press **Data Math** and select **Data - Mem** to perform data math.

Step 3. Press **Marker Fctn**.

Step 4. Set **Analysis Type** to **Statistics** to display the analysis results.

NOTE

When the marker list is on, statistics are displayed on the screen of another window. For display method of the marker list, refer to “Listing All Marker Values in All Displayed Traces” on page 207.

Step 5. When you want to compare traces, set **Data Math** to off and display traces and trace memory on the screen. For the display method, refer to “Comparing Traces/Performing Data Math” on page 222.

Hiding Numeric Information

You can hide numeric information on the screen for purposes such as security.

Hiding Frequency Information on Screen

Follow these steps to display frequency information on the measurement screen and frequency information in softkeys and data entry box as asterisks (***)...

- Step 1.** Press **Display** - **Security Level**.
- Step 2.** Select **Frequency Blank** from the security level setting (Table 6-7).

Table 6-7

Security Level Setting

Softkey	Function
None	Displays all information on the screen.
Frequency Blank	Displays frequency information as asterisks. You cannot return the setting to None with the Security Level menu. You need to execute Preset or Recall to return the display setting to None.
All Numeric Blank	Displays all numeric information as asterisks. You cannot change the security level with the Security Level menu. You need to execute Preset or Recall to return the display setting to None or Frequency Blank.

NOTE

Once you set the security level to Frequency Blank, the frequency readouts are disabled (any frequency readouts are marked as asterisks, “***)”) unless cycling power, executing **Preset** or recall a setting whose security level is None.

Hiding All Numeric Information Screen

Follow these steps to display all numeric information on the measurement screen and numeric information in softkeys and data entry box as asterisks (***)...

- Step 1.** Press **Display** - **Security Level**.
- Step 2.** Select **All Numeric Blank** from the security level setting (Table 6-7).

NOTE

Once you set the security level to **All Numeric Blank**, the **Security Level** is no more changed by the user unless cycling power, executing **Preset** or recall a setting whose security level is None or Frequency Blank.

Saving Display Screen

You can save the E5052A's screen image on a file in the bitmap or PNG format. The saved file can be recalled for later use with PC application software.

Operational Procedure

Follow the steps below to save the screen image on a file.

- Step 1.** Display the screen that you want to save on a file.
- Step 2.** Press **System** to display the system menu. Use the following softkey from the System menu.

Softkey	Function
Dump Screen Image	Saves the screen information on a file

NOTE

The image displayed on the screen just before pressing **System**^{Capture} is saved in the file. For more information, refer to "Images You Can Print/save" on page 246.

- Step 3.** Press **Dump Screen Image** to open the "Save As" dialog box. For information on the Save As dialog box, refer to the description for Figure 6-14, "Save As dialog box," on page 234. In this case, either Bitmap Files (with the extension of *.bmp) or Portable Network Graphics (with the extension of *.png) is selected as the file type.
- Step 4.** Select the file type.
- Step 5.** Specify the folder in which you want to save the file and enter the file name. Press **Save** to save the screen image of the E5052A in a file.

Printing Screen Image

Connect your printer to the E5052A's printer parallel port on the rear panel or to the USB port to print screen images from the E5052A.

Supported Printers

Agilent's Internet website provides the latest information on available printer types and drivers compatible with the E5052A.

Visit us at the following site.

http://www.agilent.com/find/ctdkobe_printers

Installing Printer Driver

You must install the appropriate driver on the E5052A to use newly supported printers after you have purchased the E5052A.

Obtain a driver that is dedicated to the E5052A prepared by the Agilent Technologies. You can download printer drivers from the Agilent Technologies product promotion web site.



For information on obtaining printer drivers, contact Agilent Technologies. For inquiries, see the Customer Contact list at the end of this manual or go to the online assistance homepage at "<http://www.agilent.com/find/assist>".

To install drivers, refer to the instructions supplied with the drivers.

Images You Can Print/save

You can print/save the images that are stored in the clipboard. However, unless images are stored on the clipboard, the current screen image will be printed/saved.

Storing Images in Clipboard

The  key provides a screen capture function as well. In other words, the image displayed on the screen just before pressing  is saved on the clipboard.

NOTE The images stored on the clipboard are cleared after executing print/save operations.

Printing Procedure

Preparing Printing

Follow the steps below to prepare for printing.

- Step 1.** Power off the E5052A.
- Step 2.** Power on the printer and then connect it to the E5052A.

NOTE Do not connect unsupported printers to the E5052A.

- Step 3.** Power on the E5052A.
- Step 4.** Press .
- Step 5.** Press **Printer Setup** to open the “Printers” window. Select the printer you want to use and set it up by referring to the instruction manual for the printer.
- Step 6.** The Printers window will close.

Printing

Follow the steps below to print the screen image.

- Step 1.** Display the screen that you want to print out.
- Step 2.** Press  to save the current screen image on the clipboard.
- Step 3.** As required, press **Invert Image** to toggle the selection of printing either in the displays's actual colors or in the image's inverted colors. (This can save much ink by, for example, printing with a white rather than black background.)
- Step 4.** Press **Print** to start printing.

Pressing **Abort Printing** during the printing operation stops the printing.

NOTE

If you start printing before the printer is ready (e.g. not powered on yet), the Printers Folder dialog box may be displayed as shown in Figure 6-18. In this case, press **Cancel** to close the Printers Folder dialog box and retry the operation after the printer is ready.

Figure 6-18

Printers Folder dialog box

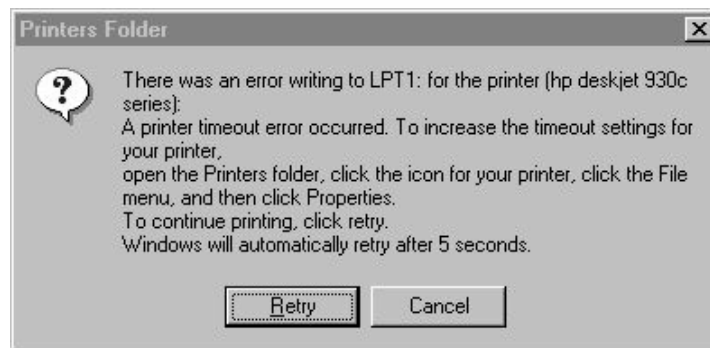

7**Clock Jitter Measurement**

This chapter describes procedures used to install the E5001A SSA-J and to perform clock jitter measurement.

Overview

The E5052A provides application software that lets you perform very-low-level clock jitter measurement. To use this function, you need to separately purchase the E5001A SSA-J option. For more information, contact your local Agilent customer center listed at the end of this manual or your distributor.

Overview of clock jitter measurement

The periods (reference times) of clock sources actually vary depending on a number of factors such as noise. This variation is called jitter, which is generally evaluated using a statistical measurement method. Jitter analysis is an important measurement for applications that handle high-frequency signals.

There are two types of jitter: one dependent on data (Data Correlated or Data Dependent) and one independent of data (Data Uncorrelated or Data Independent). Each type of jitter has various components (jitter components, Figure 7-1).

Figure 7-1

Jitter Components

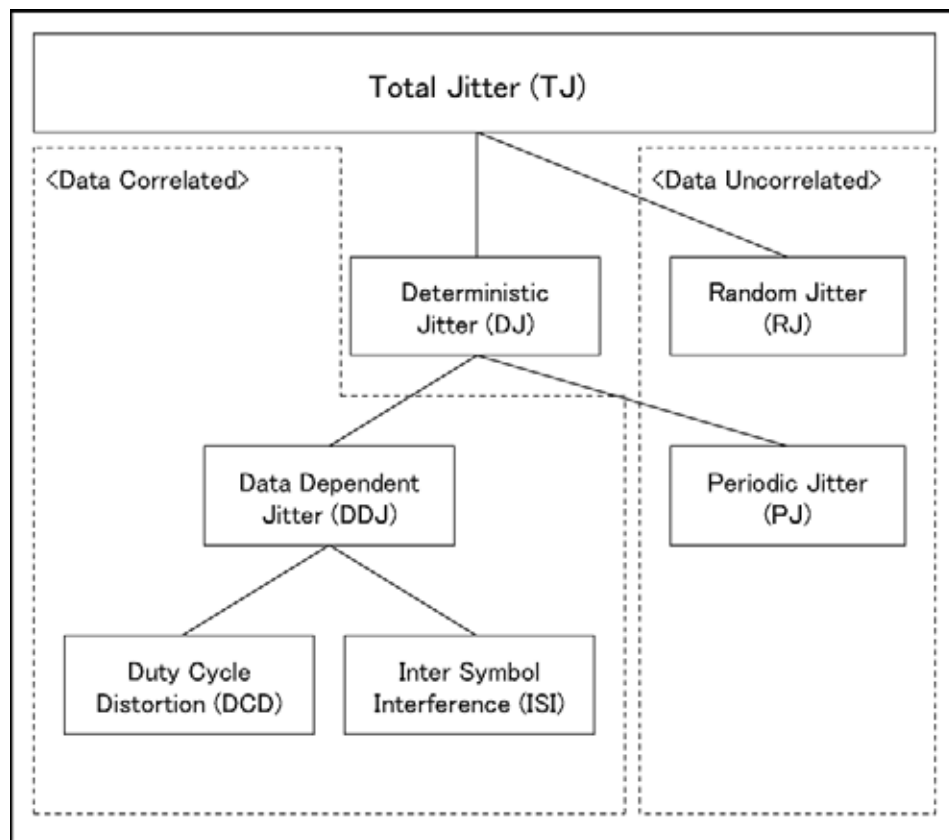

e5052aue5001

The E5052A can measure only data-uncorrelated jitter components. Such data-uncorrelated jitters are described below.

Table 7-1 Types of Jitters

Jitter	Description
Random jitter (RJ)	Jitter that occurs randomly. Generally, it is expressed as a gaussian with an average value (μ) and a standard deviation (σ). Its peak-to-peak (p-p) value has no limit. As measurement time becomes longer, the p-p value measured during the time becomes larger.
Periodic jitter (PJ)	Jitter that occurs over entire periods independent of data patterns. Its peak-to-peak (p-p) value has a limit. Even when measurement time is elongated, the p-p value converges to a finite value.

The Dual Dirac model is used to obtain periodic jitter (PJ). The standard deviation of a random jitter (RJ) distribution is obtained from the RMS value of actually measured random jitter. The Dual Dirac model consists of two identical gaussians defined with the RMS value of the random jitter.

The distance between the two gaussians is adjusted so that the probability density function (PDF) of the model matches the measured jitter histogram. The model for analysis is identified under the condition that the peak-to-peak (p-p) distance representing 99.9% of the area of the model's PDF matches the width that contains 99.9% of the area of the measured histogram (Figure 7-2).

PJ ($\delta-\delta$), which is a parameter indicating the actual effect of the periodic jitter component, is defined by the distance between the average values of the two gaussians. The effective value of periodic jitter independent of its waveform is calculated by rms sum analysis using the standard deviation of the random jitter, which is obtained from the random jitter/periodic jitter histogram giving the RMS value of the periodic jitter.

Figure 7-2

Dual Dirac Model

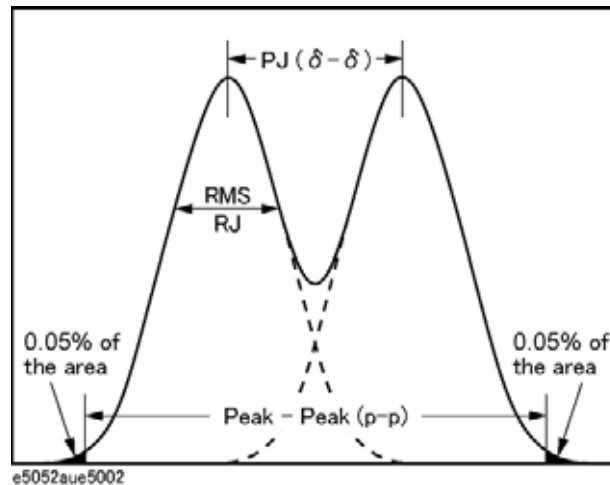

Relation between phase deviation (spurious) and jitter

Equation 7-1 shows the relation between jitter (J) expressed in seconds (s) or unit intervals (UI) and phase deviation (spurious) expressed in radians $\Delta\phi$, where the frequency of the clock signal is expressed as f_c [Hz].

Equation 7-1

$$J[s] = \frac{1}{2\pi f_c} \Delta\phi[rad] \quad J[UI] \equiv \frac{J[s]}{\frac{1}{f_c}} = f_c \cdot J[s] = \frac{1}{2\pi} \Delta\phi[rad]$$

The following equation gives the relation between phase deviation $\Delta\phi$ and phase-noise spectrum, $L\phi(f)$ [dBc/Hz]. A and B in the equation indicate the frequency range specified with the band marker.

Equation 7-2

$$\Delta\phi = \sqrt{2 \times 10^{10} \frac{IPN}{10}} \quad [rad]$$

Equation 7-3

$$IPN = 10 \times LOG \left[\int_A^B 10^{\frac{L\phi(f)}{10}} df \right] \quad [dBc]$$

IPN (Integrated Phase Noise)

Relative value of phase-noise power integrated over a range between frequencies A and B

The following equation gives the residual FM component (RFM) within a range of frequencies A and B.

Equation 7-4

$$RFM = \sqrt{2 \times \int_A^B f^2 \times 10^{\frac{L\phi(f)}{10}} df} \quad [Hz_{rms}]$$

Clock jitter measurement with the E5052A

The E5052A uses phase-noise measurement and transient measurement for clock jitter measurement. The user window is used to display the jitter trend and histogram.

NOTE

To use this function, you need to purchase the E5001A SSA-J option. For more information, contact your local Agilent customer center listed at the end of this manual or your distributor.

The clock jitter measurement provides the following capabilities:

- Displaying the jitter trend and total jitter value
- Displaying the jitter probability distribution (histogram)
- Displaying the periodic jitter (PJ) value and random jitter (RJ) value

The clock jitter measurement of the E5052A provides three analysis functions that you can select from the screen.

Analysis function	Description
Random jitter analysis (RJ)	Displays the clock frequency and the RMS value of the random jitter in phase-noise measurement.
Frequency analysis for periodic jitter (PJ Freq)	In phase-noise measurement, displays the clock frequency and the RMS value of the periodic jitter with the spurious power value display enabled.
Decomposition analysis for periodic jitter (PJ decomposition)	Displays the jitter trend and histogram for jitter value analysis. The target frequency for transient measurement can be linked.

The following figure shows the decomposition analysis for periodic jitter.

Figure 7-3

Flow of decomposition analysis for periodic jitter

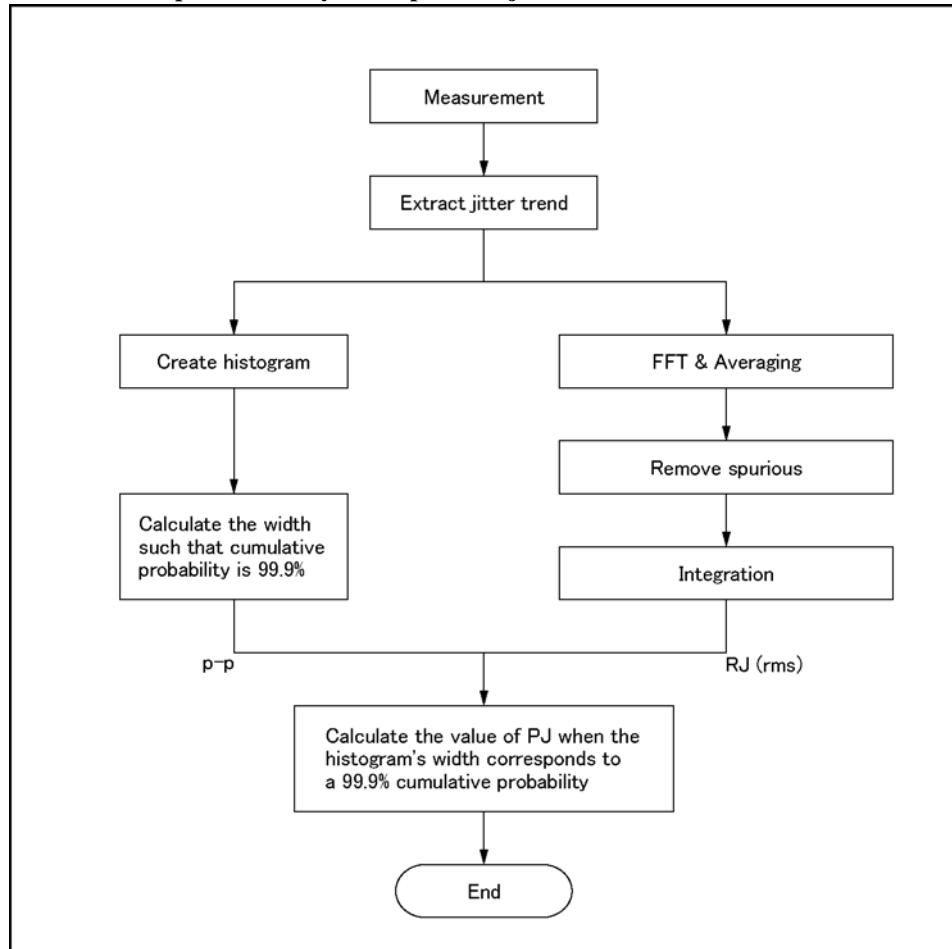

e5052aue5017

Executing Clock Jitter Measurement

Starting the VBA program

Follow these steps to start up the program.

- Step 1. Press **Macro Setup**.
- Step 2. Press **Application**.
- Step 3. Press **Jitter**.

The following screen appears.

Figure 7-4

Initial screen for jitter analysis

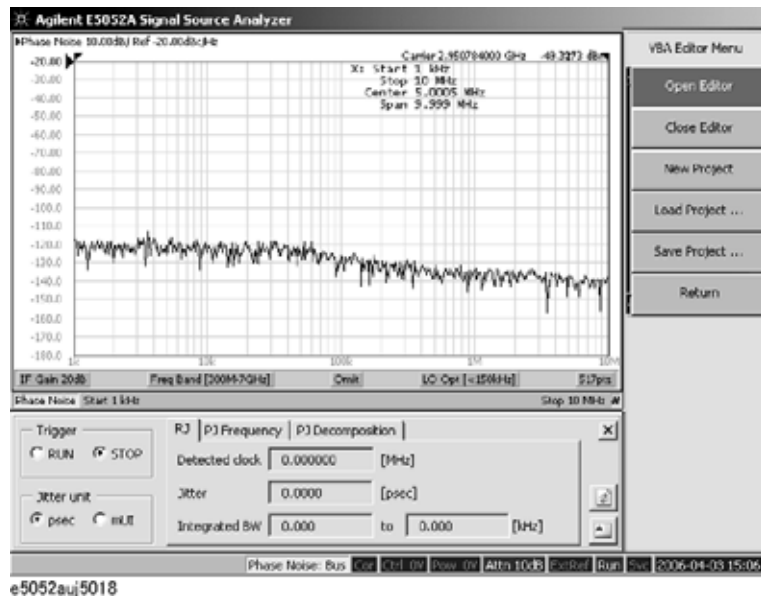

Random jitter analysis

Overview

This analysis displays the clock frequency and the rms value of random jitter in phase-noise measurement. You can use the band marker on the screen to specify an analysis range. In this case, the analysis range is also displayed.

Setting procedure

Figure 7-5

Screen for random jitter analysis

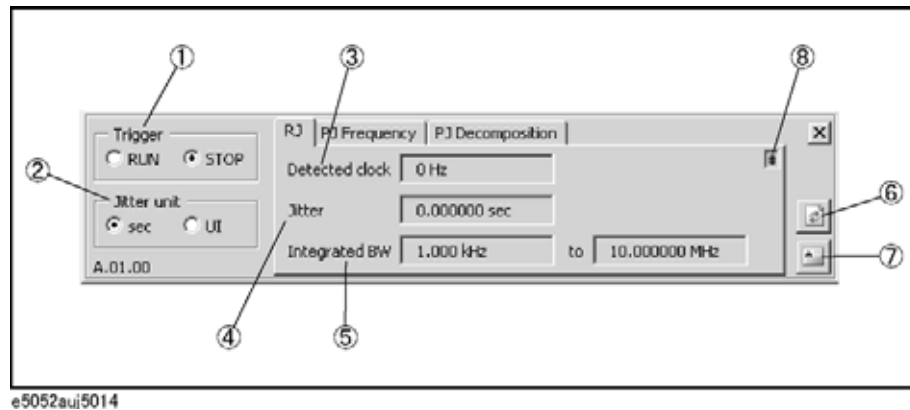

- Step 1.** Select **RJ** from the analysis function selection tabs (default)
- Step 2.** When you want to specify an analysis range, use the band marker on the phase-noise measurement screen. The specified analysis range is displayed in the measurement result display area (5 in Figure 7-5).
- Step 3.** Select a jitter display unit (2 in Figure 7-5).

Button	Function
sec	Displays data in the unit of second.
UI	Displays data in the unit of unit interval.

- Step 4.** Select the **RUN** button (1 in Figure 7-5).
- Step 5.** The measurement starts, and the clock frequency (3 in Figure 7-5) and the random jitter rms value (4 in Figure 7-5) are displayed.
- Step 6.** Click the **STOP** button (1 in Figure 7-5) to finish the measurement.

Figure 7-6 Example of screen for random jitter analysis

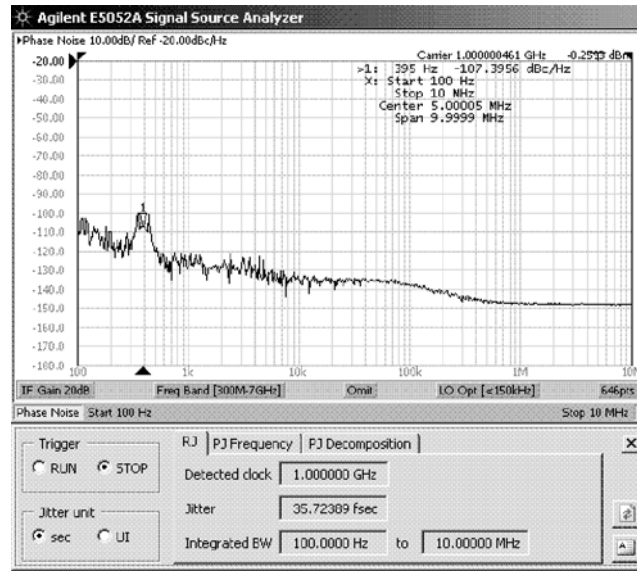

e5052auj5011

7. Clock Jitter Measurement

Saving analysis result

You can save the analysis result to a file by following the steps below.

- Step 1.** Click the tab of the analysis result that you want to save. At this time, analysis is carried out once.
- Step 2.** Use the Save/Recall function to save the analysis result. For details, refer to “File Saving and Loading Instrument Status Settings” on page 229.

Recalling analysis result

You can recall the analysis result from a file by following the steps below.

- Step 1.** Use the Save/Recall function. For details, refer to “File Saving and Loading Instrument Status Settings” on page 229.
- Step 2.** Press the **Refresh** button (6 in Figure 7-5).

Saving analysis result to a file

You can save the result of random jitter analysis to a text file by pressing the **Export** button (7 in Figure 7-5).

Pressing the Export button opens the analysis result file in the Notepad application. Pressing this button during measurement writes the analysis result displayed at that time.

Notes on measurement

If you select another analysis function tab (PJ Frequency/PJ Decomposition) during measurement, the current measurement is aborted. In this case, the # sign (8 in Figure 7-5) is displayed for the analysis result to indicate a possible mismatch of displayed information between the E5052A and VBA.

Note that the # sign is not displayed if the E5052A’s displayed information is changed without using the VBA.

Frequency analysis for periodic jitter

Overview

This analysis displays the clock frequency and the RMS value of the periodic jitter when the spurious power value display is enabled in phase-noise measurement. You can use the band marker on the screen to specify an analysis range.

Setting procedure

Figure 7-7

Screen for periodic jitter frequency analysis

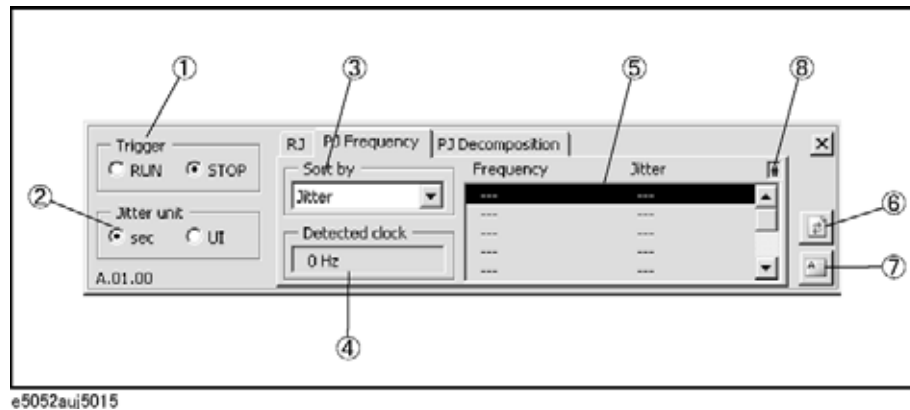

- Step 1.** Select **PJ Frequency** from the analysis function selection tabs.
- Step 2.** When you want to specify an analysis range, use the band marker on the phase-noise measurement screen.
- Step 3.** Select a spurious sorting method displayed on the phase-noise measurement screen (3 in Figure 7-7).

Button	Function
Jitter	Sorts jitters in ascending order.
Frequency	Sorts frequencies in ascending order.

- Step 4.** Select a display unit (2 in Figure 7-7).

Button	Function
sec	Displays data in the unit of second.
UI	Displays data in the unit of unit interval.

- Step 5.** Select the **RUN** button (1 in Figure 7-7).
- Step 6.** The measurement starts, and the lists of clock frequencies (4 in Figure 7-7) and periodic jitter rms values (5 in Figure 7-7) are displayed.
- Step 7.** Select the point you want to analyze from the list (5 in Figure 7-7). When you select a point, the marker moves to the analysis point on the phase-noise measurement screen.

Step 8. Click the **STOP** button to finish the measurement (1 in Figure 7-7).

Figure 7-8

Example screen of periodic jitter frequency analysis

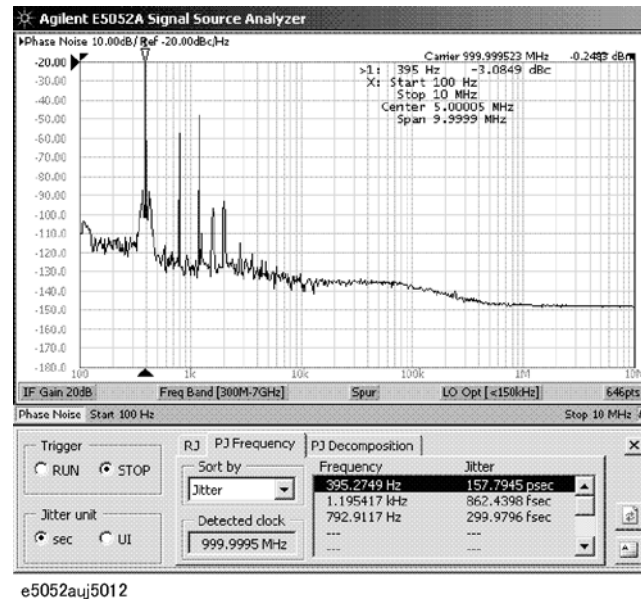

Saving analysis result

You can save the analysis result to a file by following the steps below.

- Step 1.** Click the tab of the analysis result that you want to save. At this time analysis is carried out once.
- Step 2.** Use the Save/Recall function to save the analysis result. For details, refer to “File Saving and Loading Instrument Status Settings” on page 229.

Recalling analysis result

You can recall the analysis result from a file by following the steps below.

- Step 1.** Use the Save/Recall function. For details, refer to “File Saving and Loading Instrument Status Settings” on page 229.
- Step 2.** Press the **Refresh** button (6 in Figure 7-5).

Saving analysis result to a file

You can save the analysis result of random jitter analysis to a text file by pressing the **Export** button (7 in Figure 7-7).

Pressing the Export button opens the analysis result file in the Notepad application. Pressing the Export button during measurement writes the analysis result displayed at that time.

Note on measurement interruption

If you select another analysis function tab (RJ/PJ Decomposition) during measurement, the current measurement is aborted. In this case, the # sign (8 in Figure 7-5) is displayed for the analysis result to indicate a possible mismatch of displayed information between the

Clock Jitter Measurement

Executing Clock Jitter Measurement

E5052A and VBA.

Note that the # sign is not displayed if the E5052A's displayed information is changed without using the VBA.

Decomposition analysis for periodic jitter

Overview

This analysis displays the jitter trend and histogram for jitter value analysis. The target frequency for transient measurement is linked.

Setting procedure

Figure 7-9

Screen for periodic jitter decomposition analysis

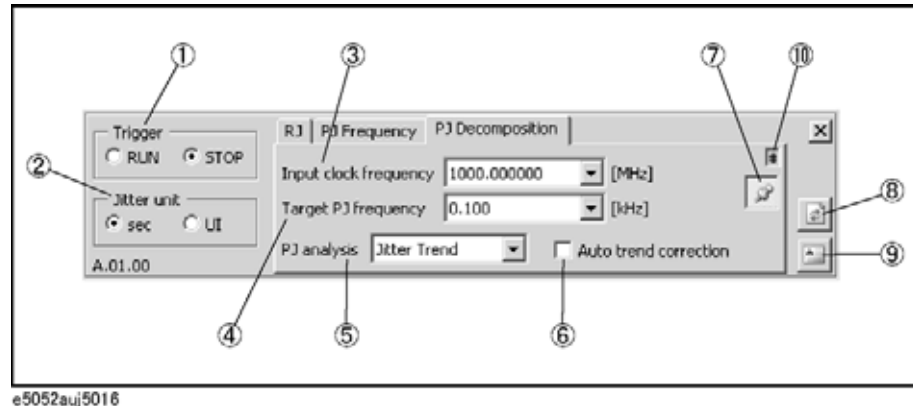

- Step 1.** Select **PJ Decomposition** from the analysis function selection tabs.
- Step 2.** Specify a clock frequency (MHz) for the periodic jitter frequency analysis (3 in Figure 7-9). Frequencies added here are saved in the list.
- Step 3.** Enter the period jitter frequency you want to analyze (4 in Figure 7-9). Frequencies entered here are saved in the list of jitter values (5 in Figure 7-7).
- Step 4.** Select an analysis function (5 in Figure 7-9).

Button	Function
Jitter Trend	Displays the jitter trend and analyzes the total jitter.
Histogram	Displays the histogram and analyzes the total jitter.
PJ Separation	Displays the histogram and gaussian and analyzes the total jitter and periodic jitter.

- Step 5.** Turns on/off the jitter trend auto correction function (6 in Figure 7-9).

The average of the narrow band measurement frequencies used in transient measurement is set to the phase reference frequency offset value.

To turn on this function, select the **Auto Trend Correction** checkbox.

- Step 6.** Select a display unit (2 in Figure 7-9).

Button	Function
sec	Displays data in the unit of second.

Clock Jitter Measurement

Executing Clock Jitter Measurement

UI Displays data in the unit of unit interval.

Step 7. Select the **RUN** button (1 in Figure 7-9).

NOTE The previous analysis result is cleared.

Step 8. Measurement starts, and the analysis result is displayed.

Button	Function
Jitter Trend	<ul style="list-style-type: none">• Total jitter (p-p)• Total jitter (rms)• Clock^{*1}
Histogram	<ul style="list-style-type: none">• Total jitter (p-p)• Total jitter (rms)• Sampling count• Clock^{*1}
PJ Separation	<ul style="list-style-type: none">• Total jitter (p-p)• Total jitter (rms)• Periodic jitter (δ-δ)• Sampling count• Clock^{*1}

*1. Displayed when the jitter trend auto correction function is on.

NOTE If fitting fails, ? (question mark) is added at the end of the analysis result.

Step 9. Click the **STOP** button to finish the measurement (1 in Figure 7-9).

Figure 7-10

Example screen for periodic jitter decomposition analysis

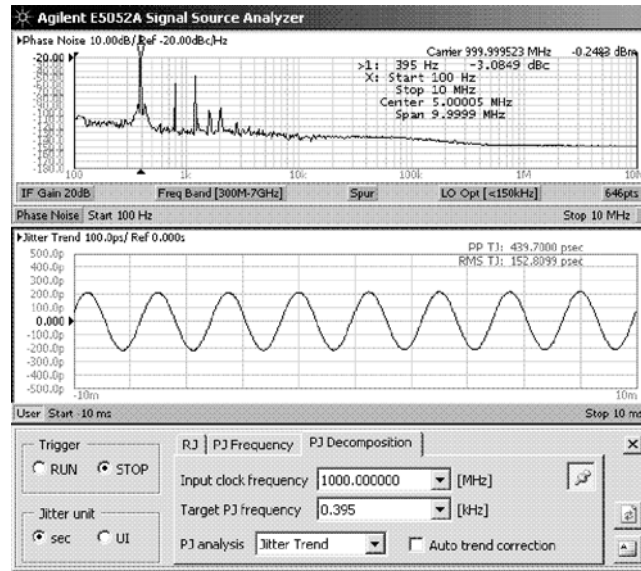

7. Clock Jitter Measurement

Adjusting the position where the analysis result is displayed

You can display the result of periodic jitter decomposition analysis at your desired position. Clicking the **Adjust Position** button (7 in Figure 7-9) will bring up another window on which you can adjust the display position.

Saving analysis result

You can save the analysis result to a file. Follow the steps below.

- Step 1.** Click the tab of the analysis result that you want to save. At this time analysis is carried out once.
- Step 2.** Use the Save/Recall function to save the analysis result. For details, refer to “File Saving and Loading Instrument Status Settings” on page 229.

Recalling analysis result

You can recall the analysis result from a file by following the steps below.

- Step 1.** Use the Save/Recall function. For details, refer to “File Saving and Loading Instrument Status Settings” on page 229.
- Step 2.** Press the **Refresh** button (6 in Figure 7-5).

Saving analysis result to a file

You can save the result of random jitter analysis to a text file by pressing the **Export** button (7 in Figure 7-9).

Pressing the Export button opens the analysis result file in the Notepad application. Pressing the Export button during measurement writes the analysis result displayed at that time.

Clock Jitter Measurement

Executing Clock Jitter Measurement

Note on measurement interruption

If you select another analysis function tab (RJ/PJ Frequency) during measurement, the current measurement is aborted. In this case, the # sign (10 in Figure 7-5) is displayed for the analysis result to indicate a possible mismatch of displayed information between the E5052A and VBA.

Note that the # sign is not displayed if the E5052A's displayed information is changed without using the VBA.

Installing the program

To install the program, you need to separately purchase the E5001A SSA-J option. After you purchase this, a license certificate is issued from Agilent Technologies.

Follow the instructions on the license certificate to access the Agilent Technologies license server and receive your license key code.

NOTE

License key codes are managed based on the serial number of the E5052A. The license for a certain E5052A cannot be transferred to any other E5052A.

There are two types of E5001A licenses: permanent license and limited-time license, which have different methods for entering the license code. For more information, see “Example of entering a permanent license key code” on page 266 or “Example of entering a limited-time license key code” on page 266.

Follow these steps to enable this function after receiving your license key code.

Setting procedure

- Step 1.** Press **System**.
- Step 2.** Press the **Service Menu** button.
- Step 3.** Press the **Install Option License** button.
- Step 4.** Press the **Jitter** button.
- Step 5.** The screen below appears for entering the license key code (SIGN=xxxxxx). After entering it, press the **Enter** key. After installation, the **Jitter** button is enabled (on).

NOTE

You can enter the license key code with the keyboard.

Figure 7-11

License key code entry screen



- Step 6.** After entering the license code, the following dialog box appears. Press **Yes** to restart the firmware.

Figure 7-12

Confirmation dialog box after using key code entry screen

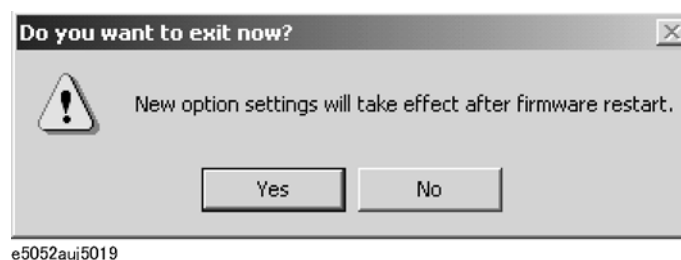

Clock Jitter Measurement

Executing Clock Jitter Measurement

Example of entering a permanent license key code

For the following sample permanent license, enter “128E234EE8B0.”

```
FEATURE SSA-J Agilent 1.000 permanent uncounted \  
HOSTID=VDH=E5052A_JP1KL00066 SIGN=128E234EE8B0
```

Example of entering a limited-time license key code

For the following sample limited-time license, enter “1-apr-2006, 1-may-2006, 1269EA605D7C.”

```
FEATURE SSA-J Agilent 1.000 1-may-2006 uncounted \  
HOSTID=VDH=E5052A_JP1KL00066 START=1-apr-2006 \  
SIGN=1269EA605D7C
```

Confirming installation of E5001A

You can confirm that the E5001 is installed by checking the following items.

- The return value of the *OPT? command (should be “SSA-J”)
- Options displayed according to “Checking the Product Information” on page 290
- Options displayed at the startup of the E5052A

Error messages

If an error occurs during clock jitter measurement, a dialog box appears and the measurement stops. You may encounter the following messages.

Option SSA-J not Installed.

The E5001 (Option SSA-J) is not installed.

Unexpected error.

This message may be displayed on the periodic jitter decomposition analysis screen.

It indicates that the trend range of the current measurement is greatly different from those of previous measurements and thus analysis cannot be performed.

Trigger error.

This message is displayed when the setting of the E5052A is changed during measurement and thus measurement cannot be triggered.

No AgtJitter data on SSA.

This message may be displayed on the periodic jitter frequency analysis screen and the periodic jitter decomposition analysis screen.

It indicates that no measurement data exists when you try to save/recall.

File write error.

This message is displayed when writing to a file fails.

8

Setting and Using the Control and Management Functions

This chapter explains how to set and use the control and management functions that are not directly linked with measurement or analysis.

Setting the GPIB

This section describes how to set the interface necessary to use the GPIB (General Purpose Interface Bus) of the E5052A. For information on the concept and concrete implementation of auto measurement using GPIB, refer to the *Programmers Guide*.

Setting talker/listener GPIB address of E5052A

When controlling the E5052A using GPIB commands from an external controller connected to the GPIB connector, you need to set the talker/listener GPIB address of the E5052A.

Follow these steps to make this setting:

- Step 1.** Press **System**.
- Step 2.** Press **Misc Setup**.
- Step 3.** Press **GPIB Setup**.
- Step 4.** Press **Talker/Listener Address**.
- Step 5.** Enter the address using the ENTRY block keys on the front panel.

Setting system controller (USB/GPIB interface) when c drive volume label in hard disk is less than CL250

When controlling an external device from the E5052A, connect the USB port of the E5052A and the GPIB port of the external device through the USB/GPIB interface.

Follow these steps to set the USB/GPIB interface when c drive volume label in hard disk is less than CL250:

NOTE Do not connect two or more USB/GPIB interfaces.

NOTE 82357B USB/GPIB interface can not be used if not the c drive volume label in hard disk is more than CL251. When use the 82357B USB/GPIB interface, hard disk is required to change.

- Step 1.** Connect the USB port of the E5052A to the USB/GPIB interface. The USB/GPIB Interface Detected dialog box (Figure 8-1) appears.

Figure 8-1 USB/GPIB Interface Detected dialog box

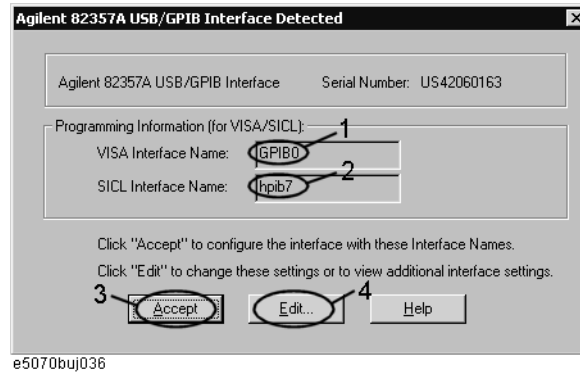

- Step 2.** Confirm that VISA Interface Name is set to GPIB0 (1 in Figure 8-1) and that the SIDL Interface Name is set to hpib7 (2 in Figure 8-1) and then click the **Accept** button (3 in Figure 8-1). If the setting is correct, the procedure is complete. If the setting is different, click the **Edit** button (4 in Figure 8-1).
- Step 3.** The USB to GPIB Configuration dialog box (Figure 8-2) appears. Make the settings as shown in the thick-lined box (1 in Figure 8-2) and then click the **OK** button (2 in Figure 8-2).

Figure 8-2 USB to GPIB Configuration dialog box

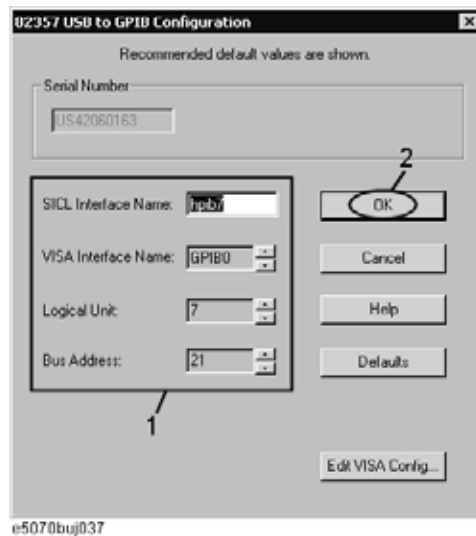

If you need to check/change the settings of the USB/GPIB interface after connecting the USB/GPIB interface, follow these steps:

- Step 1.** Press **System**.
- Step 2.** Press **Misc Setup**.
- Step 3.** Press **GPIB Setup**.
- Step 4.** Press **System Controller Configuration**.

Setting and Using the Control and Management Functions

Setting the GPIB

Step 5. The IO Config dialog box (Figure 8-3) appears. Select (highlight) **GPIB0 hpib7** (1 in Figure 8-3) and then click the **Edit** button (2 in Figure 8-3).

NOTE

In the IO Config dialog box, do not click buttons other than those specified here and do not change any other settings because doing so may cause serious damage to the functions of the E5052A.

Figure 8-3 IO Config dialog box

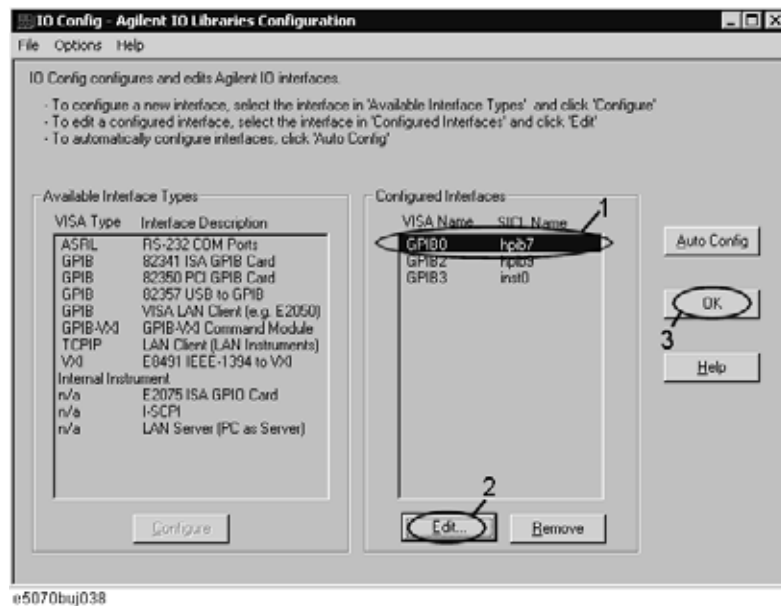

Step 6. The USB to GPIB Configuration dialog box (Figure 8-2) appears. Check/change the setting of the USB/GPIB interface and then click the **OK** button (2 in Figure 8-2).

Step 7. In the USB to GPIB Configuration dialog box, click the **OK** button (3 in Figure 8-3).

Setting system controller (USB/GPIB interface) when c drive volume label in hard disk is more than CL251

When controlling an external device from the E5052A, connect the USB port of the E5052A and the GPIB port of the external device through the USB/GPIB interface.

Follow these steps to set the USB/GPIB interface when c drive volume label in hard disk is more than CL251:

NOTE Do not connect two or more USB/GPIB interfaces.

- Step 1.** Connect the USB/GPIB interface to the USB port of the E5052A. The USB/GPIB Interface Detected dialog box (Figure 8-4) appears.

Figure 8-4 USB/GPIB Interface Detected dialog box

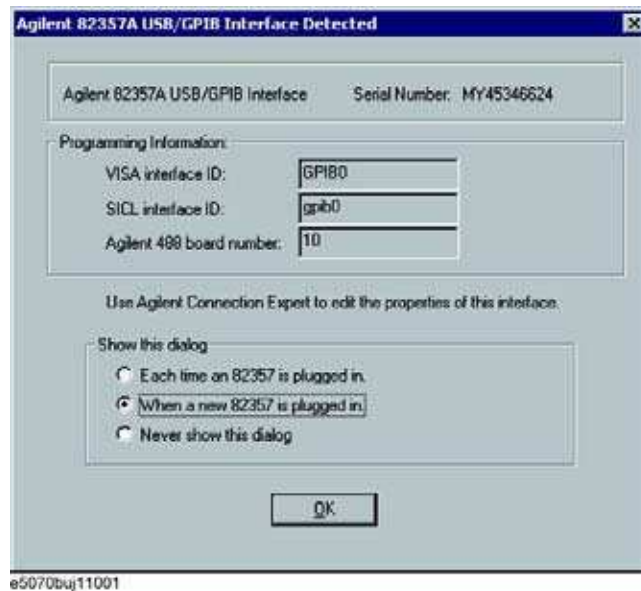

- Step 2.** Choose the “When a new 82357 is plugged in” in Show this dialog flame, then click **OK** button.

Setting and Using the Control and Management Functions

Setting the GPIB

If you need to check/change the setting of the USB/GPIB interface after connecting the USB/GPIB interface, follow these steps:

- Step 1.** Press **System**.
- Step 2.** Press **Misc Setup**.
- Step 3.** Press **GPIB Setup**.
- Step 4.** Press **System Controller Configuration**.
- Step 5.** Agilent Connection Expert (Figure 8-5) appears. After selecting the **USB/GPIB(GPIB0)** (1 in Figure 8-5), click **Change Properties...** button (2 in Figure 8-5).
- Step 6.** Screen of USB/GPIB Interface appears. Check/change the setting of the USB/GPIB interface (3 in Figure 8-5) and then click the **OK** button.

Figure 8-5 USB to GPIB Configuration dialog box

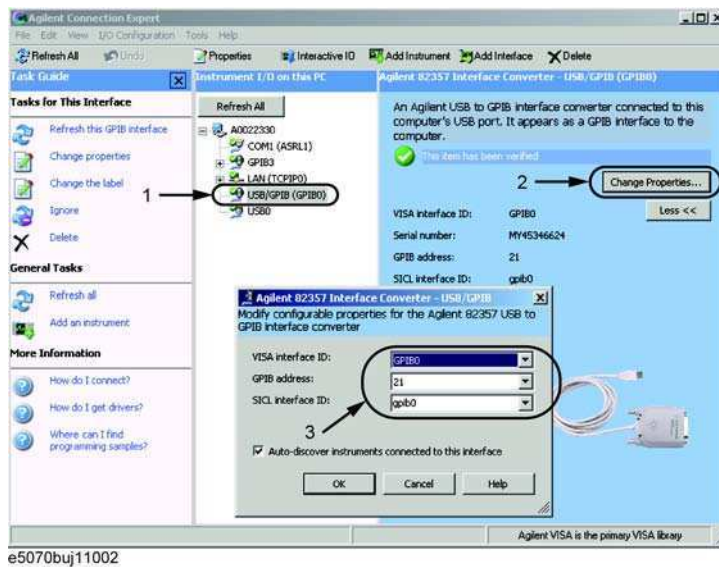

NOTE

In Agilent Connection Expert, do not click buttons other than specified here or do not change other settings because doing so may cause serious damage to the functions of the E5052A.

Setting the Mouse

The user can change the setup for the mouse connected to the E5052A and the movement of the pointer.

Setup steps

NOTE Be sure to use a mouse and a keyboard for mouse setup operations.

- Step 1.** Press **[System]**.
- Step 2.** Press **Misc Setup**.
- Step 3.** Press **Control Panel** to open the Control Panel window.

Figure 8-6 Control Panel window



- Step 4.** Double-click the **Mouse** icon (1 in Figure 8-6) in the Control Panel window.

NOTE Do not click icons other than those specified here and do not change other settings because doing so may cause serious damage to the functions of the E5052A.

Setting and Using the Control and Management Functions

Setting the Mouse

Step 5. The Mouse Properties dialog box (Figure 8-7) is displayed.

Define the setup for a right-handed/left-handed person in the **Buttons configuration** area. Define the setup for double-click speed in the **Double-click speed** area.

Figure 8-7 Mouse Properties Dialog Box (Buttons tab)

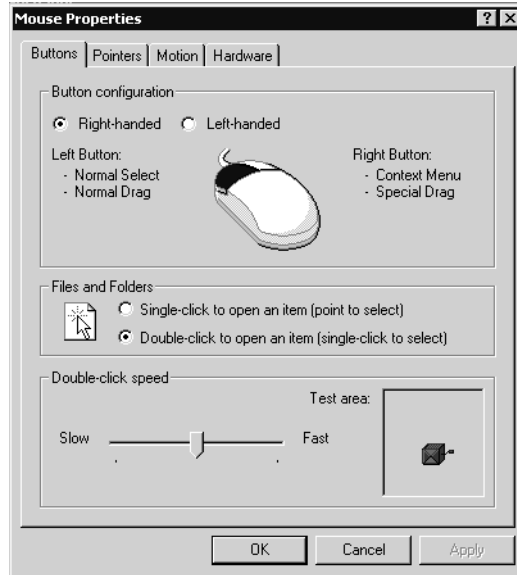

e5070buj028

Step 6. Click the **Pointers** tab (Figure 8-8).

Figure 8-8 Mouse Properties dialog box (Pointers tab)

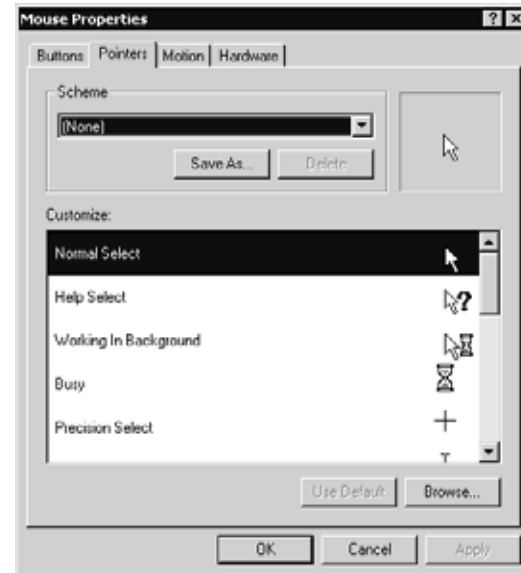

e5070buj029

Step 7. Enter a registration name into the **Scheme** box and specify the shapes of pointers for the registration name in the box below.

To create a registration name, click the **Save As...** button. Enter the registration name into the **Save Scheme** dialog box that appears, and click the **OK** button.

Step 8. Click the **Motion** tab (Figure 8-9).

Figure 8-9

Mouse Properties Dialog Box (Motion tab)

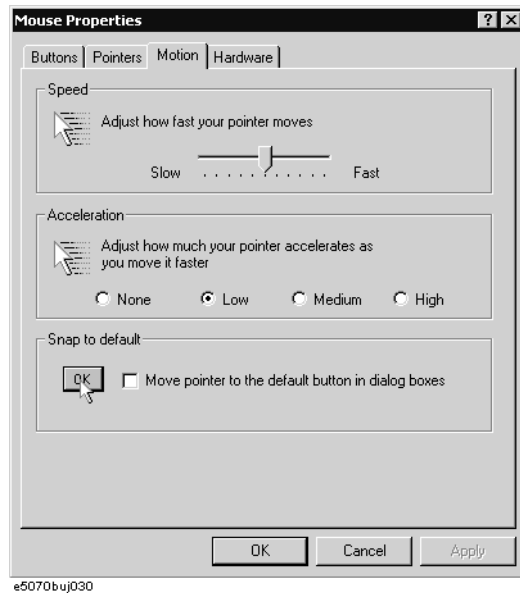

Step 9. Specify the pointer speed in the **Pointer speed** area and the pointer trail in the **Pointer trail** area.

Step 10. Click the **OK** button.

Step 11. Click the × button (2 in Figure 8-6) at the corner of the Control Panel window to close the window.

Configuring the Network

NOTE

When you use the E5052A by connecting it to your LAN, consult your network administrator in order to make the LAN settings correctly.

This section describes how to set the following basic items necessary to connect the E5052A to a LAN (Local Area Network).

- ❑ “Enabling/disabling network” on page 276
- ❑ “Setting IP address” on page 277
- ❑ “Specifying computer name” on page 279

If you need detailed network settings, consult your network administrator and perform operations in the same way as for a PC using Windows 2000®.

Enabling/disabling network

You can enable/disable the network connection function of the E5052A.

Follow these steps to enable/disable the network connection function.

- Step 1.** Use the LAN cable to connect the E5052A to the LAN.
- Step 2.** Press **[System]**.
- Step 3.** Press **Misc Setup**.
- Step 4.** Press **Network Setup**.
- Step 5.** Press **Network Configuration** to open the Network and Dial-up Connections window (Figure 8-10).

Figure 8-10

Network and Dial-up Connections window

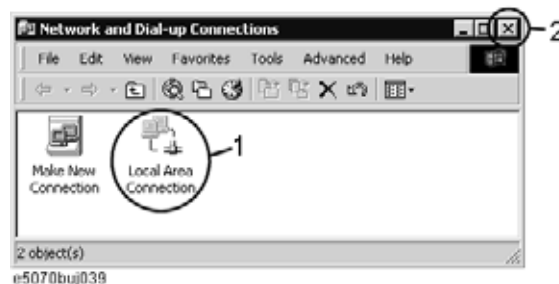

Step 6. When switching from disable to enable:

Double-click the Local Area Connection icon (1 in Figure 8-10) in the Network and Dial-up connections window to enable the network connection function.

When switching from enable to disable:

Double-click the Local Area Connection icon (1 in Figure 8-10) in the Network and Dial-up Connections window. The Local Area Connection Status dialog box (Figure 8-11) appears. Click the **Disable** button (1 in Figure 8-11) to disable the network connection function.

Figure 8-11

Local Area Connection Status dialog box

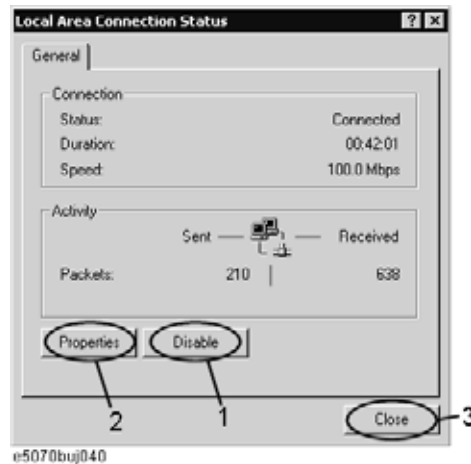

Step 7. Click the × button (2 in Figure 8-10) at the upper right of the Network and Dial-up Connections window to close the window.

Setting IP address

Follow these steps to set the IP address:

- Step 1.** Press **System**.
- Step 2.** Press **Misc Setup**.
- Step 3.** Press **Network Setup**.
- Step 4.** Press **Network Configuration**.
- Step 5.** Double-click the Local Area Connection icon (1 in Figure 8-10) in the Network and Dial-up Connections window. The Local Area Connection Status dialog box (Figure 8-11) appears. Click the **Properties** button (2 in Figure 8-11).

Setting and Using the Control and Management Functions Configuring the Network

Step 6. The Local Area Connection Properties dialog box (Figure 8-12) appears. Select (highlight) **Internet Protocol (TCP/IP)** (1 in Figure 8-12) and then click the **Properties** button (2 in Figure 8-12).

Figure 8-12 Local Area Connection Properties dialog box

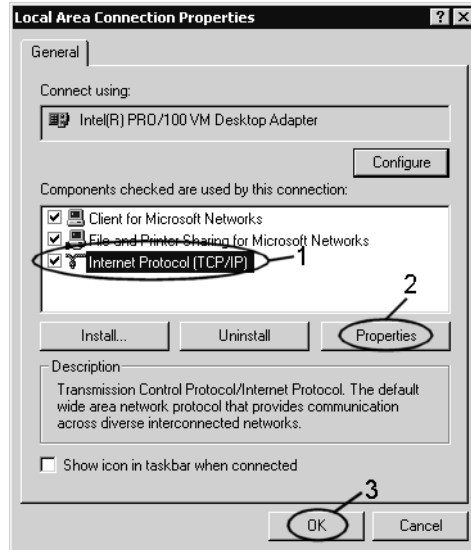

Step 7. The Internet Protocol (TCP/IP) Properties dialog box (Figure 8-13) appears. Click (select) **Use the following IP address** (1 in Figure 8-13) and then enter the IP address (2 in Figure 8-13), the subnet mask (3 in Figure 8-13), and the gateway address (4 in Figure 8-13).

If the IP address can be obtained automatically (if a DHCP server can be used), click (select) **Obtain an IP address automatically** (5 in Figure 8-13).

Figure 8-13 Internet Protocol (TCP/IP) Properties dialog box

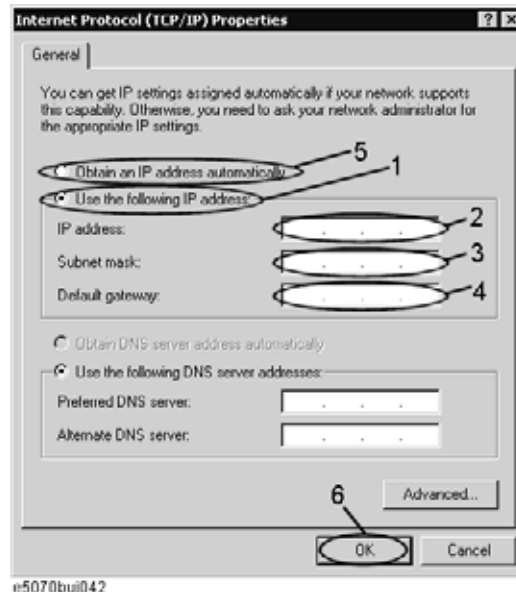

- Step 8.** In the Internet Protocol (TCP/IP) Properties dialog box, click the **OK** button (6 in Figure 8-13).
- Step 9.** In the Local Area Connection Properties dialog box, click the **OK** button (3 in Figure 8-12).
- Step 10.** In the Local Area Connection Status dialog box, click the **Close** button (3 in Figure 8-11).
- Step 11.** Click the × button (2 in Figure 8-10) at the upper right of the Network and Dial-up Connections window to close the window.

Specifying computer name

Follow these steps to specify the computer name:

- Step 1.** Press **System**.
- Step 2.** Press **Misc Setup**.
- Step 3.** Press **Network Setup**.
- Step 4.** Press **Network Identification**.
- Step 5.** The System Properties dialog box (Figure 8-14) appears. Click the **Properties** button (1 in Figure 8-14).

Figure 8-14

System Properties dialog box

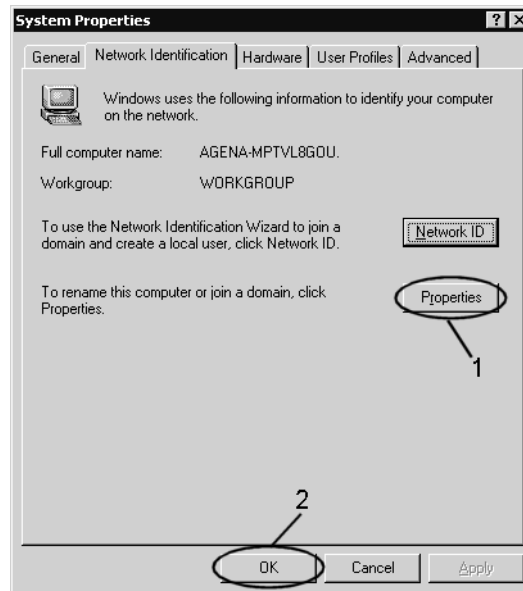

e5070buj043

Setting and Using the Control and Management Functions Configuring the Network

Step 6. The Identification Changes dialog box (Figure 8-15) appears. Enter the computer name in the **Computer Name** box (1 in Figure 8-15).

Figure 8-15

Identification Changes dialog box

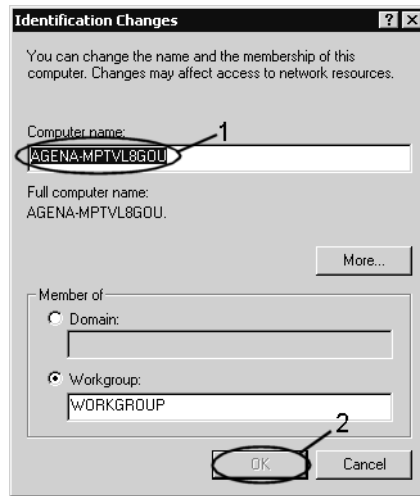

e5070buj044

Step 7. The Network Identification dialog box (Figure 8-16) appears. Click the **OK** button.

Figure 8-16

Network Identification dialog box



e5070buj045

Step 8. In the Identification Changes dialog box, click the **OK** button (2 in Figure 8-15).

Step 9. In the System Properties dialog box, click the **OK** button (2 in Figure 8-14).

Step 10. The System Settings Change dialog box (Figure 8-17) appears. Click the **Yes** button to restart the E5052A.

Figure 8-17

System Settings Change dialog box

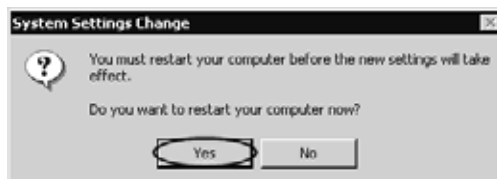

e5070buj046

NOTE

The changed settings do not take effect until the E5052A is restarted.

Accessing Hard Disk of E5052A from External PC

If you connect the E5052A to a LAN, you can access the hard disk (F drive) in the E5052A as a network drive from an external PC connected to the same LAN.

NOTE

See “Connecting Hard Disk (Shared Folder) of External PC” in Chapter 6, “Application Programs” in *VBA Programmer’s Guide* for information on accessing the hard disk of the external PC connected to the same LAN from the E5052A.

Figure 8-18

Accessing drive F of E5052A from external PC

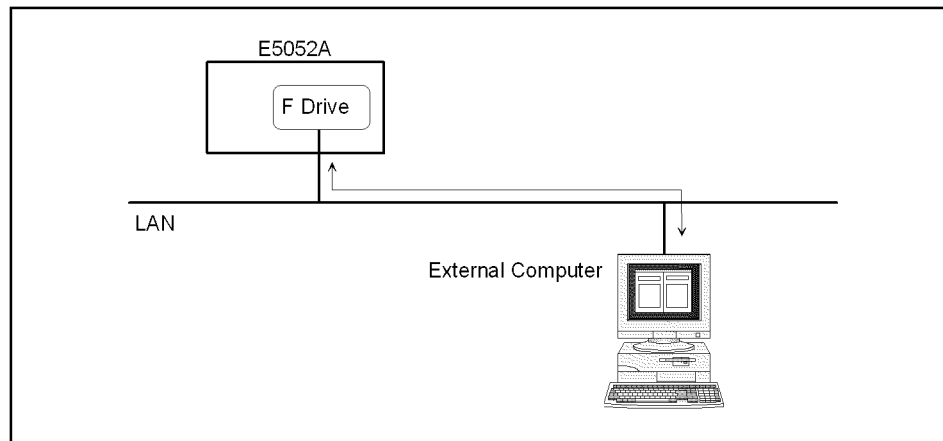

e5052aue014

Enabling access from an external PC

This section shows the simplest procedure to enable access from an external PC.

NOTE

It is recommended that you use settings with relatively high security; please consult your network administrator.

- Step 1.** Press .
- Step 2.** Press **Explorer...**
- Step 3.** Windows Explorer (Refer to the Figure 6-16 on page 237) opens. Select (highlight) **USER (F:)** and then click **Properties** in the File menu.

Setting and Using the Control and Management Functions
Accessing Hard Disk of E5052A from External PC

Step 4. The USER(F:) Properties dialog box (Figure 8-19) appears. Select the **Sharing** tab.

Figure 8-19 USER(F:) Properties dialog box (General tab)

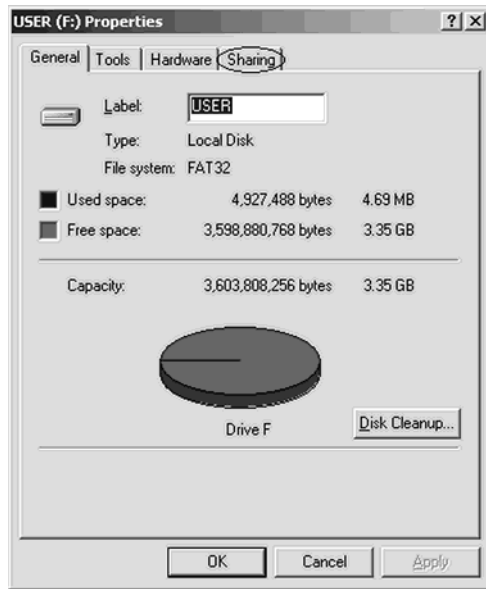

e5052auj047

Step 5. Click the **New Share** button (1 in Figure 8-20).

Figure 8-20 USER(F:) Properties dialog box (Sharing tab)

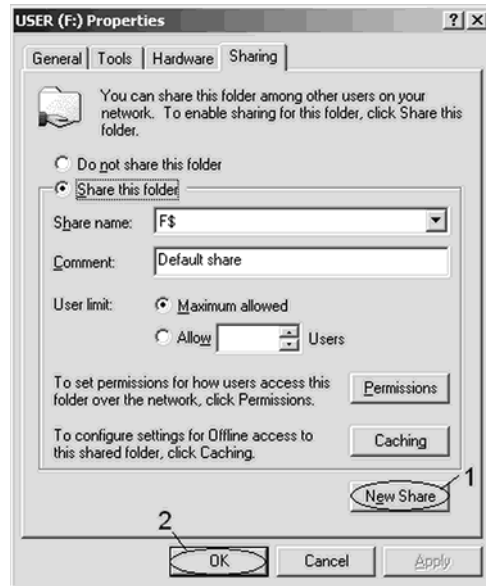

e5052auj048

- Step 6.** The New Share dialog box (Figure 8-21) appears. Enter the share name (name used when accessed from the external PC) in the **Share Name** box (1 in Figure 8-21) and click the **OK** button (2 in Figure 8-21).

Figure 8-21

New Share dialog box

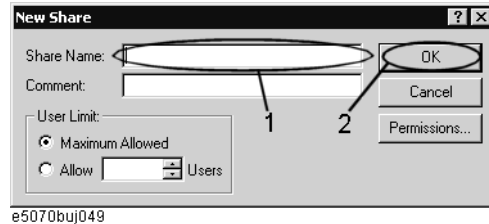

- Step 7.** In the USER(F:) Properties dialog box, click the **OK** button (2 in Figure 8-20).

Accessing hard disk of E5052A from external PC

This section explains the procedure for accessing the hard disk (F drive) in the E5052A from the external PC, which has been made possible by first following the procedure described in “Enabling access from an external PC” on page 281. In our example below, we use Windows NT ®.

NOTE

For information on network connections, see your PC’s operation manual.

- Step 1.** From the Start menu, click Programs - Windows Explorer to start Explorer.
- Step 2.** From Explorer's menu, click **Tools - Map Network Drive...**
- Step 3.** The Map Network Drive dialog box appears. Select an appropriate drive, enter **\\C_NAME\S_NAME** as the network path, and then click the **OK** button.
- C_NAME** in the network path is the computer name of the E5052A, and **S_NAME** is the share name of the F drive. For information on how to set the computer name, refer to “Specifying computer name” on page 279; for information on how to set the share name, refer to “Enabling access from an external PC” on page 281.
- Step 4.** The dialog box used to enter the user name and the password appears. Enter an appropriate user name and password and then click the **OK** button.

The user name and password differ depending on the setting made when enabling access from the external PC. When you have set them according to “Enabling access from an external PC” on page 281, you can make connection using the user name, **E5052**, without the password.

Disabling USB Mass Storage Device

You can disable any USB-compatible external mass storage devices in order to ensure confidentiality or for other reasons.

Steps for Setting Modification

The following procedure shows how to disable a USB Mass Storage Device.

- Step 1.** Press .
- Step 2.** Press **Explorer...**
- Step 3.** Double-click DisableUsbStorage.exe from F:\Agilent\Service.
- Step 4.** Click OK in the SUCCEEDED message window that appears. If any USB mass storage device is connected to the E5052A under this condition, the Hardware Wizard will start, but the USB mass storage device will not work.

The procedure shows how to enable a USB Mass Storage Device.

- Step 1.** Press .
- Step 2.** Press **Explorer...**
- Step 3.** Double-click EnableUsbStorage.exe from F:\Agilent\Service.
- Step 4.** Click OK in the SUCCEEDED message window that appears.

NOTE

If you do not want any USB mass storage device to ever be enabled at any time, delete EnableUsbStorage.exe from the E5052A after DisableUsbStorage.exe has been completed.

These two programs will not be recovered automatically by applying the firmware update or other such action. Before deleting any of these programs, you should make a backup copy to a recording medium such as a floppy disk and store it separately.

NOTE

If the program fails to run, it is possible that you have not logged in as a user in the Administrators Group. When you want to execute any of the above programs, make sure to log in as a user in the Administrators Group.

The "E5052" that is the username when the factory is shipped is Administrator Group.

Locking the Front Keys, Keyboard, and Mouse (Touch Screen)

You can lock (disable) the front keys, keyboard, and mouse (touch screen). This feature prevents erroneous operation caused by inadvertently touching any of these devices.

Locking the front keys, keyboard, and mouse

- Step 1.** Press **System**.
- Step 2.** Press **Misc Setup**.
- Step 3.** Press **Key Lock**.
- Step 4.** Press the corresponding key to switch the lock on/off.

Softkey	Function
Front Panel & Keyboard Lock	Switches the lock for the front panel keys and keyboard on/off.
Touch Screen & Mouse Lock	Switches the lock for the touch screen and mouse on/off.

NOTE

You cannot use a locked device to unlock that same device. To unlock the front panel keys, keyboard, touch screen and mouse when they have all been locked, press the Standby switch to turn off the power supply and then turn it on again. When setting at power-on, the front panel keys, keyboard, touch screen and mouse are all in an unlocked state.

Setting the Beeper (Built-in Speaker)

The E5052A has a built-in speaker that sounds a beep tone. The beeper allows you to make the two types of settings shown in Table 8-1.

Table 8-1

Beeper functions

Type	Function
Operation complete beeper	Sounds a beep tone to inform the user that operations have completed. <ul style="list-style-type: none">• When calibration data measurements are done• When saving/recalling has completed
Warning beeper	Sounds a beep tone to alert the user of a problem. <ul style="list-style-type: none">• When an instrument error occurs (an error message appears at the same time)

The warning beeper sounds slightly longer than the operation complete beeper.

Setting the Operation Complete Beeper

Step 1. Press **System**.

Step 2. Press **Misc Setup**.

Step 3. Press **Beeper**.

Step 4. Press **Beep Complete** to switch the operation complete beeper on/off.

Pressing **Test Beep Complete** allows you to hear and check the beep tone of the operation complete beeper.

Setting the Warning Beeper

Step 1. Press **System**.

Step 2. Press **Misc Setup**.

Step 3. Press **Beeper**.

Step 4. Press **Beep Warning** to switch the warning beeper on/off.

Pressing **Test Beep Warning** allows you to hear and check the beep tone of the warning beeper.

Turning off the LCD Screen Backlight

You can switch off the backlight (illumination) of the E5052A's LCD screen. This extends the life of the backlight when using it continuously over a long period.

Turning off the LCD Screen Backlight

Step 1. Press **System**.

Step 2. Press **Backlight** to switch the backlight on/off.

Switching off the backlight causes indications on the LCD screen to be almost invisible.

A backlight that has been switched off can be turned on again by pressing **Preset**. When the LCD backlight is off, **Preset** works as a key for switching the backlight back on.

Setting display colors

Selecting display mode

You can select the display mode of the LCD display from two options: normal display (background: black) and inverted display (background: white). In normal display, the colors of items are preset so that you can recognize them easily on the display of the instrument. On the other hand, in inverted display, items are preset to colors obtained by almost completely inverting the default settings of the normal display; this mode allows you to use data easily when storing it into a graphic file.

The selection procedure is as follows.

- Step 1.** Press **[Display]**.
- Step 2.** Press **Color Type** to select the display mode. **Normal** indicates the normal display, **Invert** the inverted display.

Setting display color for each item

You can set the display color to the normal display or to the inverted display separately for each of the following items.

- Data/memory trace
- Labels and lines of graphs
- File display of the limit test and limit lines
- Background

Set the color of each item by specifying the amounts of red (R), green (G), and blue (B) contained in the color. You can specify each level of R, G, and B in 256 steps (0 to 255). Therefore, 16.77 million colors in total are available by combining the color levels. The table below shows the R, G, and B values for the main colors as a reference.

	R	G	B		R	G	B		R	G	B
White	255	255	255	Gray	128	128	128	Black	0	0	0
Red	255	0	0	Yellow	255	255	0	Green	0	255	0
Cyan	0	255	255	Blue	0	0	255	Magenta	255	0	255

The setting procedure is as follows:

- Step 1.** Press **System**.
- Step 2.** Press **Misc Setup**.
- Step 3.** Press **Color Setup**.
- Step 4.** Press **Normal** (for normal display) or **Invert** (for inverted display).
- Step 5.** Press the softkey corresponding to the item for which you want to set the display color.

Softkey	Function
Data Trace 1 to 8	Specifies the data trace of traces 1 to 8
Mem Trace 1 to 8	Specifies the memory trace of traces 1 to 8
Graticule Main	Specifies the graticule label and the outer lines of graphs
Graticule Sub	Specifies the grid lines of graphs
Limit Fail	Specifies the fail display in the limit test result
Limit Line	Specifies the limit line
Background	Specifies the background

- Step 6.** Press **Red**.
- Step 7.** Select the amount of red (R) from **0** to **255**.
- Step 8.** Press **Green**.
- Step 9.** Select the amount of green (G) from **0** to **255**.
- Step 10.** Press **Blue**.
- Step 11.** Select the amount of blue (B) from **0** to **255**.

Resetting the display colors to factory defaults

You can reset the display colors in normal display and inverted display to the values of the preset factory state.

The selection procedure is as follows.

- Step 1.** Press **System**.
- Step 2.** Press **Misc Setup**.
- Step 3.** Press **Color Setup**.
- Step 4.** Press **Normal** (for normal display) or **Invert** (for inverted display).
- Step 5.** Press **Reset Color**.
- Step 6.** Press **OK**.

Checking the Product Information

Checking the serial number

The serial number of the E5052A can be checked by using the following procedure.

Step 1. Press **[System]**.

Step 2. Press **Product Information**.

The Product Information dialog box appears.

Step 3. Press **OK** to close the dialog box.

Checking the firmware revision

The revision number of the firmware installed in the E5052A can be checked by using the following procedure.

Step 1. Press **[System]**.

Step 2. Press **Product Information**.

The Product Information dialog box appears.

Step 3. Press **OK** to close the dialog box.

Checking the option number

The option number of the E5052A can be checked by using the following procedure.

Step 1. Press **[System]**.

Step 2. Press **Product Information**.

The Product Information dialog box appears.

Step 3. Press **OK** to close the dialog box.

9

Information on Maintenance

This chapter explains the measures you should take to maintain the Agilent E5052A.

Backing Up the Data

Be sure to regularly back up your important data (including program) files in this instrument to a CD-R or other backup medium. Agilent Technologies shall not be liable for any data damages caused by troubles of this instrument.

Making backup files

Making backup files on a floppy disk

You can make backup files on a floppy disk by using the copy function. See “Managing Files/Folders” on page 237 for making a copy.

Making backup files on the hard disk of an external PC

You can make backup files on the hard disk of an external PC by using the following methods.

- You can access drive F: of the E5052A from an external PC via LAN and copy your important data files on drive F: to the external PC. See “Accessing Hard Disk of E5052A from External PC” on page 281 for details.
- You can transfer your important data files on drive F: of the E5052A to an external PC using the :MMEM:TRAN command via GPIB. See *Programmer's Guide* for details.

NOTE

Do not modify any files or folders in drives other than drive A: and drive F:. Doing so will cause malfunctions.

Maintenance of removable hard disk

This section describes how to attach/detach the removable hard disk, and how to write the system calibration data. The serial number indicates whether the removable hard disk function is available. For more information, see “Manual Changes.” of “Change 4” on page 347

CAUTION

Be sure to send the E5052A with the removable hard disk attached when sending it to our company for calibration/repair.

If you replace the removable hard disk by yourself, load the system calibration data from a floppy disk. For information on the procedure, see “Recalling system calibration data to removable hard disk” on page 295.

If you need a spare removable hard disk, we recommended that you purchase an E5052U -Opt018 Harddisk drive.

Saving system calibration data from removable hard disk to floppy disk

Replacing a removable hard disk causes the system calibration data to be lost. Therefore, before replacing the removable hard disk, you need to save the system calibration data to a floppy disk.

Follow these steps to save the system calibration data to a floppy disk before replacing the removable hard disk.

Step 1. Insert a formatted floppy disk into the floppy disk drive.

Step 2. Press - **Explorer...** to bring Windows Explorer.

Step 3. Copy the entire D:\syscal directory to the floppy disk.

Place the mouse pointer at the D:\syscal directory, right-click it, and select **Copy** .

Place the mouse pointer at the A: drive, right-click it, and select **Paste** .

Step 4. Copy the entire D:\limit directory to the floppy disk.

Place the mouse pointer at the D:\limit directory, right-click it, and select **Copy** .

Place the mouse pointer at the A: drive, right-click it, and select **Paste** .

Removing Removable Hard Disk

Follow the steps below to remove a removable hard disk.

CAUTION

Before removing a hard disk, you must turn off the unit’s power and then disconnect the power cord from the outlet.

Step 1. Unscrew the four screws that hold the cover panel ([1] in Figure 9-1, P/N 0515-2146).

Step 2. Remove the panel.

Maintenance of removable hard disk

- Step 3.** Unscrew the four screws that hold the removable hard disk ([1] in Figure 9-2, P/N0515-0374).
- Step 4.** Carefully remove the flat cable ([2] in Figure 9-2, P/N E5070-61638*¹) from the removable hard disk. Release the cable's connector by pressing the locking hooks at the sides of the connector.

Mounting Removable Hard Disk

Follow the steps below to mount a removable hard disk.

- Step 1.** Connect the removable hard disk to the flat cable's connector ([2] in Figure 9-2).
- Step 2.** Secure the removable hard disk in place with the four screws ([1] in Figure 9-2).
- Step 3.** Secure the cover panel in place with the four screws ([1] in Figure 9-1).

Figure 9-1

Attaching/detaching removable hard disk: 1

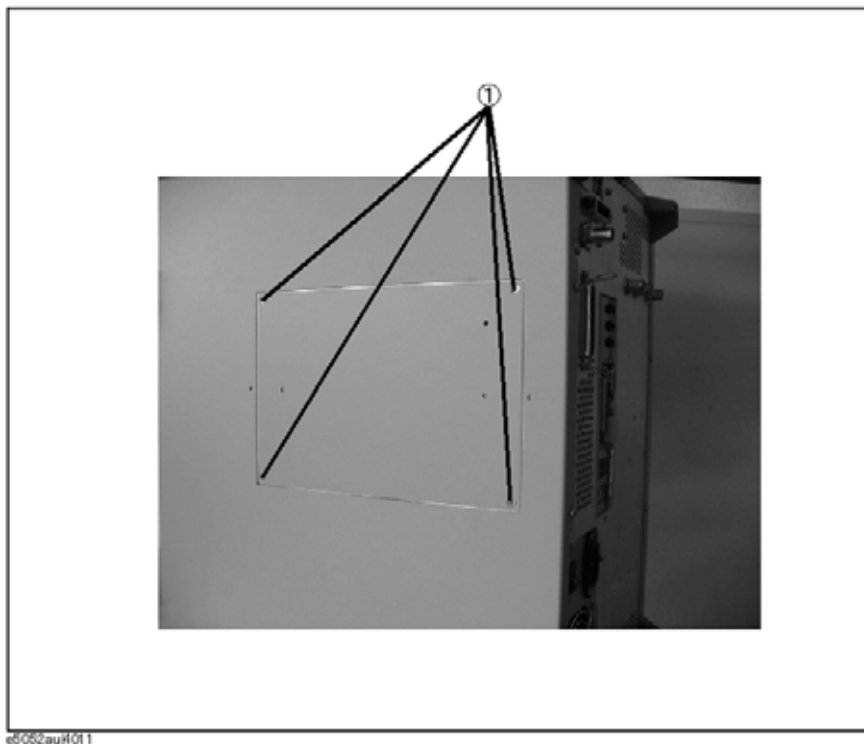

*1.Flat cable with connector

Figure 9-2

Attaching/detaching removable hard disk: 2

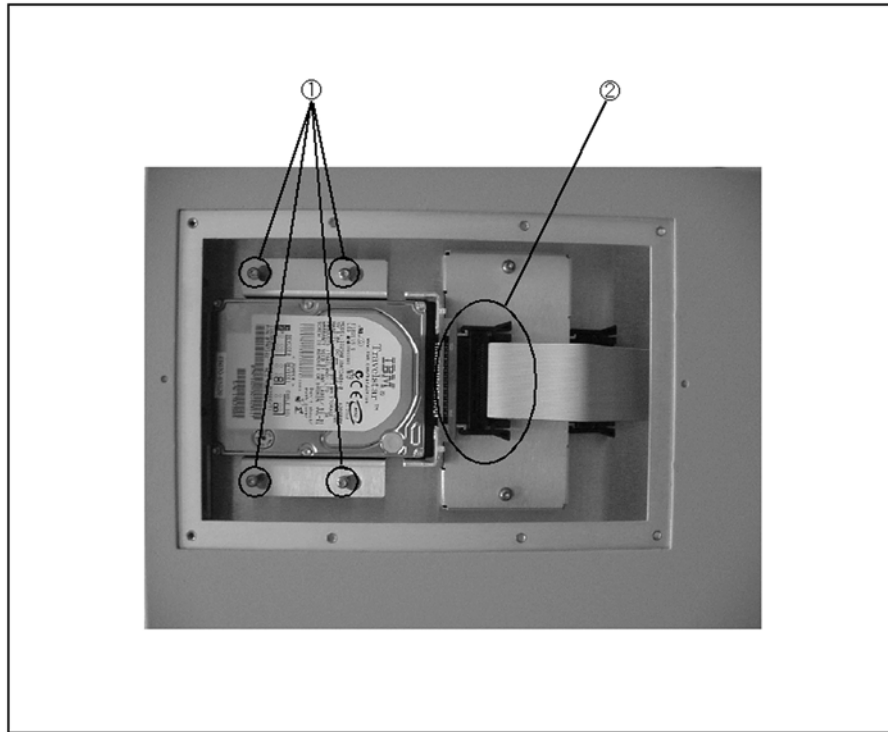

e5070bj7015

Recalling system calibration data to removable hard disk

Follow these steps to recall the system calibration data from a floppy disk in which it is saved after replacing the removable hard disk.

- Step 1.** Turn on the E5052A.
- Step 2.** Insert the floppy disk in which the system calibration data is saved into the floppy disk drive.
- Step 3.** Press - **Explorer...** to bring Windows Explorer.
- Step 4.** Copy the entire syscal directory of the A: drive to immediately under the D: drive.
Place the mouse pointer at the A:\syscal directory, right-click it, and select **Copy** .
Place the mouse pointer at the D: drive, right-click it, and select **Paste** .
- Step 5.** Copy the entire limit directory of the A: drive to immediately under the D: drive.
Place the mouse pointer at the A:\limit directory, right-click it, and select **Copy** .
Place the mouse pointer at the D: drive, right-click it, and select **Paste** .

System Recovery

By executing system recovery, you can return the system of the E5052A (the Windows operating system and the firmware) to the factory state (at the time of purchase ^{*1}).

Types of system recoveries

The following two types of system recoveries are available.

Factory recovery

Returns the contents of the C drive to the factory state.

User recovery ^{*2}

Returns the contents of the C drive to a user-specified state. To use this function, you must prepare for recovery in advance. For information on preparation, see “Procedure to create the user backup image” on page 300. For information on the execution, see “Procedure to execute the user recovery” on page 303.

Notes on executing system recovery

Executing system recovery results in the following:

- In addition to the Windows operating system and the firmware, the following settings of the E5052A are returned to the factory state.
 - Network setting
 - GPIB setting
 - Printer setting
- The driver for the supported printer installed after purchase is deleted.
- You need to execute initial registration again.

Files you created using the save function (files in the F drive) are not affected, but we recommend backing them up before executing system recovery as a prudent precaution. For more information on backup, refer to “Making backup files” on page 292.

^{*1}. If the hard disk failed and has been replaced after purchase, the state when the replacement was performed is recovered.

^{*2}. This function is available when the volume label on the hard disk is CL250 or higher.

Procedure to execute factory recovery

NOTE You need to use the keyboard for this operation.

- Step 1.** Shut down the E5052A.
- Step 2.** Connect the keyboard to the E5052A.
- Step 3.** Insert the system recovery disk into the floppy disk drive of the E5052A.
- Step 4.** Press the standby switch of the E5052A to turn it on.
- Step 5.** When the screen shown in the figure below appears, press and hold  on the keyboard until this screen disappears.

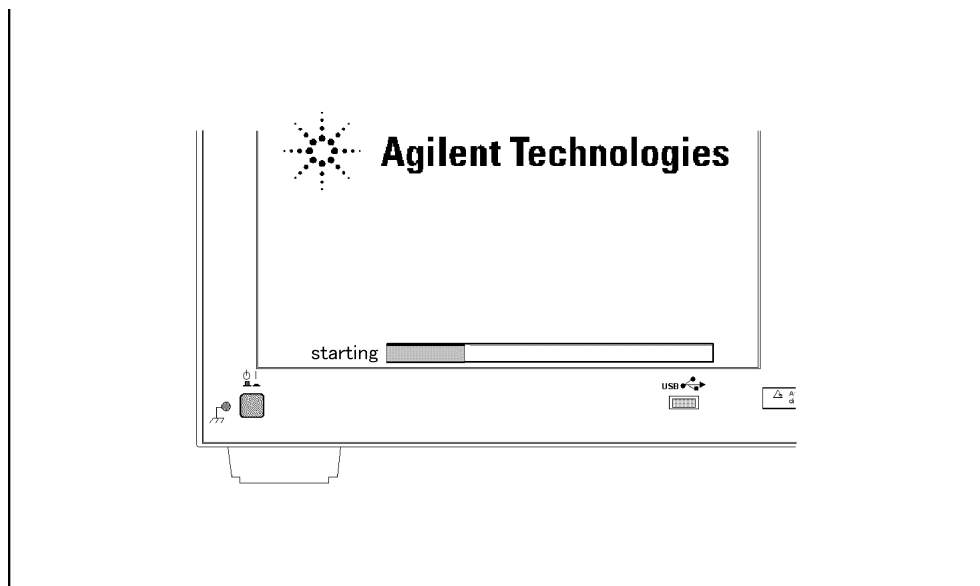



e5061buj034



NOTE After several seconds, the next screen appears automatically even if you do not press any key, so do not miss it.

If the above message does not appear, the instrument is faulty; contact your local Agilent Customer Center listed at the end of this manual or a distributor.

Information on Maintenance
System Recovery

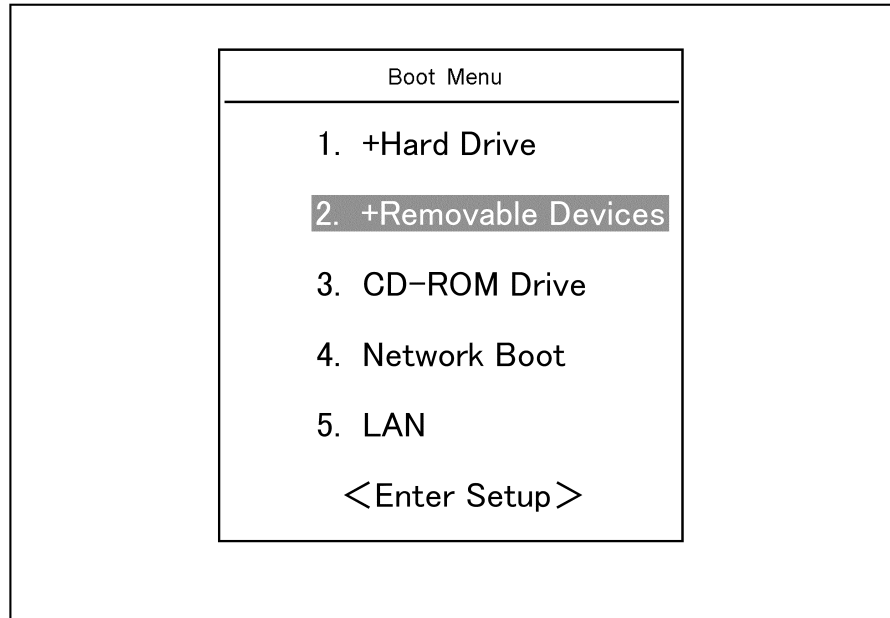
Step 6. The following screen appears. Select “+Removable Devices” with   of the keyboard, and press  of the keyboard.



Step 7. The message shown below appears. Press  on the keyboard. If you want to cancel the factory recovery, press  at this point.

```
Agilent Technologies System Utilities
Recovery & Backup Options (for the E5052A)
```

```
Choose One of the following:
```

-
- ```
1. Recover Factory Backup Image
2. Create User Backup Image
3. Recover User Backup Image
4. Exit
```
- 

```
Enter a Choice: _
```

**NOTE**

If the above message does not appear, the instrument or the system recovery disk is faulty; contact your local Agilent Customer Center listed at the end of this manual or a distributor.



- Step 8.** The message shown below appears. Press **C** on the keyboard. If you want to cancel the system recovery, press **E** at this point.

You chose to Restore your system by installing the original factory installed OS and system software.

WARNING: Press C to Continue only if you are sure that you want to proceed. The C: Drive will be completely overwritten with no chance of recovering any data. Use Option 1 to recover the system from a serious malfunction caused by corrupted or inadvertently deleted files on the system's primary C: partition.

Press C to Continue or E to Exit: \_

- Step 9.** The message shown below appears. Press **C** on the keyboard to start the system recovery. If you want to cancel the system recovery, press **E** at this point.

CAUTION! Interrupting this process may leave the system in an unstable state. Allow the software to complete the backup and recovery process. This may take up to 20 minutes depending on the system configuration.

Press C to Continue or E to Exit: \_

---

**CAUTION**

**Never turn off the power during system recovery: This may cause serious damage to the E5052A.**

- Step 10.** The system recovery will be completed in about 5 minutes. When the system recovery is complete, the message shown below appears. Press **Ctrl**, **Alt**, and **Delete** on the keyboard at the same time to restart.

Remove the disk and Press CLT+ALT+DEL to restart your system.

---

**NOTE**

If the above message does not appear, the instrument is faulty; contact your local Agilent Customer Center listed at the end of this manual or a distributor.

- Step 11.** After restart, the screen for initial registration appears. Execute initial registration. For information on the execution procedure, refer to “Initial Registration of E5052A” on page 70 .
- Step 12.** Execute the calibration of the touch screen. For information on the execution procedure, refer to “Calibration of the Touch Screen” on page 306.

### Procedure to create the user backup image

This section describes how to create the user backup image. The C drive contents saved in this creation are recalled when when the user recovery function is executed.

---

**NOTE** This function is available when the volume label on the hard disk is CL250 or higher.

---

**NOTE** You need the keyboard for this operation.

---

- Step 1.** Shut down the E5052A.
- Step 2.** Connect the keyboard to the E5052A.
- Step 3.** Insert the disk for the system recovery into the floppy disk drive of the E5052A.
- Step 4.** Press the standby swith of the E5052A to turn it on.
- Step 5.** When the screen as shown in the figure below appears, press and hold the  on the keyboard until this screen disappears.

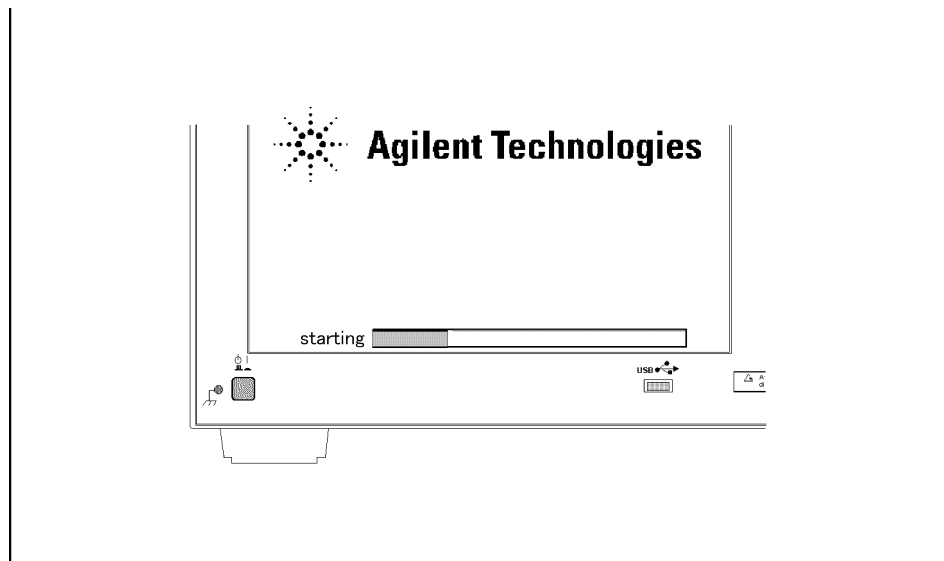



e5061buj034

---



**NOTE** After several seconds, the next screen appears automatically even if you do not press any key, so do not miss it.

If the above message does not appear, the instrument is at fault; contact your local Agilent customer center listed at the end of this manual or distributor.

---

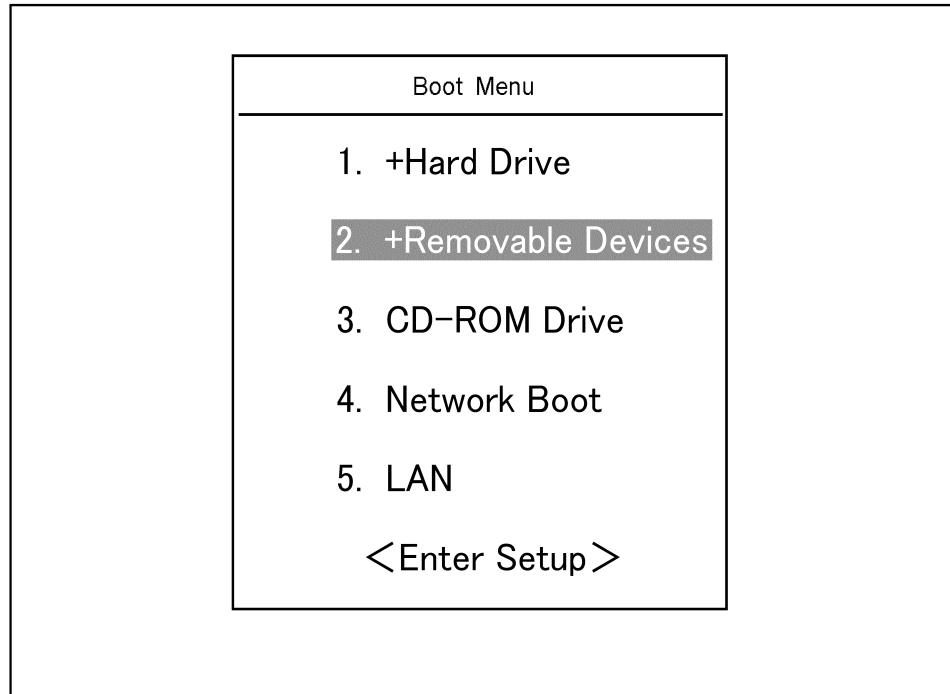
**Step 6.** The following screen appears. Select “+Removable Device” with   of the keyboard, and press  of the keyboard.



**Step 7.** The message as shown below appears. Press  of the keyboard. If you want to cancel creation of the user backup image, press  at this point.

```
Agilent Technologies System Utilities
Recovery & Backup Options for the E5052A
```

```
Choose One of the following:
```

- 
- 1. Recover Factory Backup Image
  - 2. Create User Backup Image
  - 3. Recover User Backup Image
  - 4. Exit
- 

```
Enter a Choice: _
```

**NOTE**

If the above message does not appear, the instrument or the disk for the system recovery is at fault; contact your local Agilent customer center listed at the end of this manual or distributor.

## Information on Maintenance

### System Recovery

**Step 8.** The message as shown below appears. Press **C** of the keyboard. If you want to cancel creation of the user backup image, press **E** at this point.

You chose to create a backup image file of your system.

The system will perform a quick integrity check of the file structure on the C: Drive. It will then copy the C: partition to an image file and store it on the System Recovery partition.

Press C to Continue or E to Exit: \_

**Step 9.** The message as shown below appears. Press **C** of the keyboard to start creating the user backup image. If you want to cancel creation of the user backup image, press **E** at this point.

CAUTION! Interrupting this process may leave the system in an unstable state. Allow the software to complete the backup and recovery process. This may take up to 20 minutes depending on the system configuration.

Press C to Continue or E to Exit: \_

---

#### CAUTION

**Never turn off the power during creating the user backup image because doing so may cause serious damage to the E5052A.**

---

**Step 10.** Creation of user backup image will be complete in about 5 minutes. When it is complete, the message as shown below appears. Press **Ctrl**, **Alt**, and **Delete** of the keyboard at the same time to restart.

Remove the disk and Press CLT+ALT+DEL to restart your system.

---

#### NOTE

If the above message does not appear, the instrument is at fault; contact your local Agilent customer center listed at the end of this manual or distributor.

---

### Procedure to execute the user recovery

Returns the contents of the C drive to a user-specified state. To use this function, you must create the user backup image in advance. For more information, see “Procedure to create the user backup image” on page 300.

---

**NOTE** This function is available when the volume label on the hard disk is CL250 or higher.

---

**NOTE** You need the keyboard for this operation.

---

- Step 1.** Shut down the E5052A.
- Step 2.** Connect the keyboard to the E5052A.
- Step 3.** Insert the disk for the system recovery into the floppy disk drive of the E5052A.
- Step 4.** Press the standby switch of the E5052A to turn it on.
- Step 5.** When the screen as shown in the figure below appears, press and hold the  on the keyboard until this screen disappears.

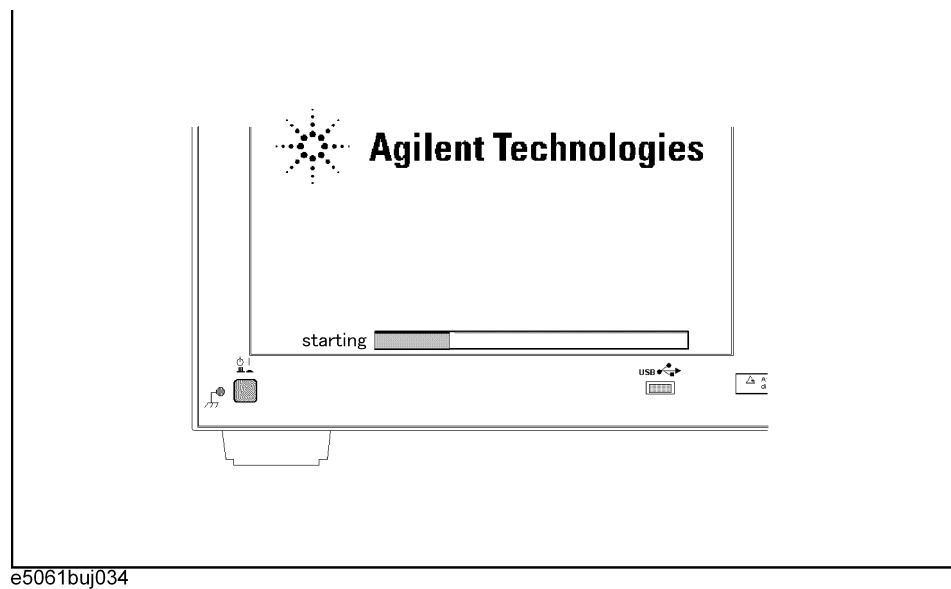



---

**NOTE** After several seconds, the next screen appears automatically even if you do not press any key, so do not miss it.



If the above message does not appear, the instrument is at fault; contact your local Agilent customer center listed at the end of this manual or distributor.

---

Information on Maintenance  
System Recovery

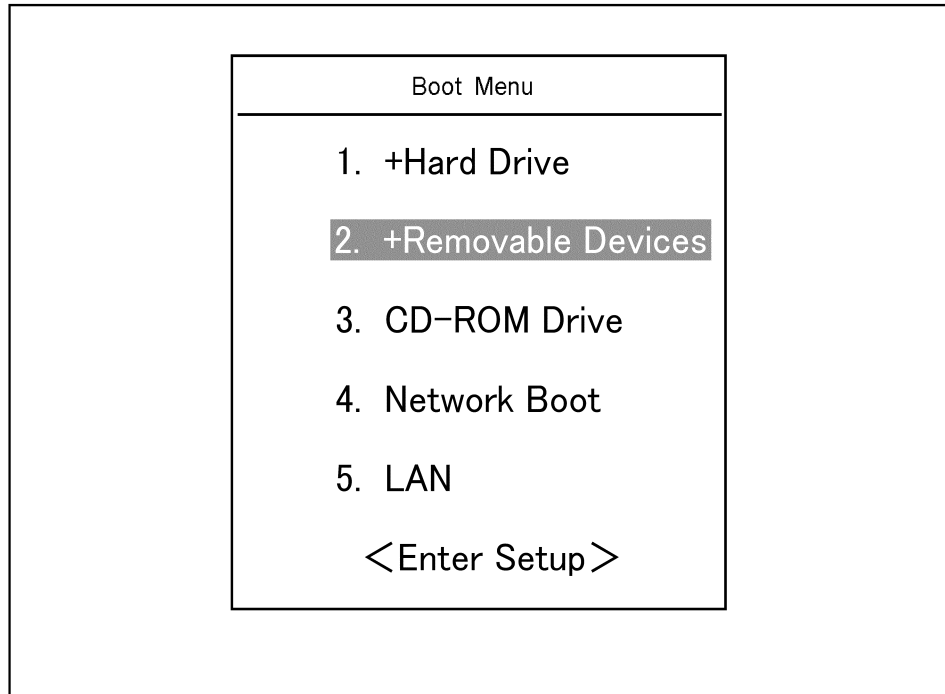
**Step 6.** The following screen appears. Select “+Removable Device” with   of the keyboard and press  of the keyboard.



**Step 7.** The message as shown below appears. Press  of the keyboard. If you want to cancel the user recovery, press  at this point.

```

Agilent Technologies System Utilities
Recovery & Backup Options for the E5052A

```

Choose One of the following:

- 
1. Recover Factory Backup Image
  2. Create User Backup Image
  3. Recover User Backup Image
  4. Exit
- 

Enter a Choice: \_

**NOTE**

If the above message does not appear, the instrument or the disk for the system recovery is at fault; contact your local Agilent customer center listed at the end of this manual or distributor.

- Step 8.** The message as shown below appears. Press **C** of the keyboard. If you want to cancel the user recovery, press **E** at this point.

You chose to recover your own system backup image file.

WARNING: Press C to Continue only if you are sure that you want to proceed. The C: partition will be completely overwritten with no chance of recovering any data. Use Option 3 to recover the system from a serious malfunction caused by corrupted or inadvertently deleted files on the system's primary C: partition.

Press C to Continue or E to Exit: \_

- Step 9.** The message as shown below appears. Press **C** of the keyboard to start the user recovery. If you want to cancel the user recovery, press **E** at this point.

CAUTION! Interrupting this process may leave the system in an unstable state. Allow the software to complete the backup and recovery process. This may take up to 20 minutes depending on the system configuration.

Press C to Continue or E to Exit: \_

---

**CAUTION**

**Never turn off the power during the user recovery because doing so may cause serious damage to the E5052A.**

- Step 10.** The user recovery will be complete in about 5 minutes. When it is complete, the message as shown below appears. Press **Ctrl**, **Alt**, and **Delete** of the keyboard at the same time to restart.

Remove the disk and Press CLT+ALT+DEL to restart your system.

---

**NOTE**

If the above message does not appear, the instrument is at fault; contact your local Agilent customer center listed at the end of this manual or distributor.

## Calibration of the Touch Screen

After you have executed system recovery on the E5052A, you have to calibrate the touch screen. Follow the procedure described below to calibrate the touch screen.

- Step 1.** Press **System**.
- Step 2.** Press **Service Menu**.
- Step 3.** Press **Test Menu**.
- Step 4.** Press **Adjust Touch Screen**.

The touch screen calibration screen (Figure 9-3) appears.

**Figure 9-3**

**Touch panel calibration screen**

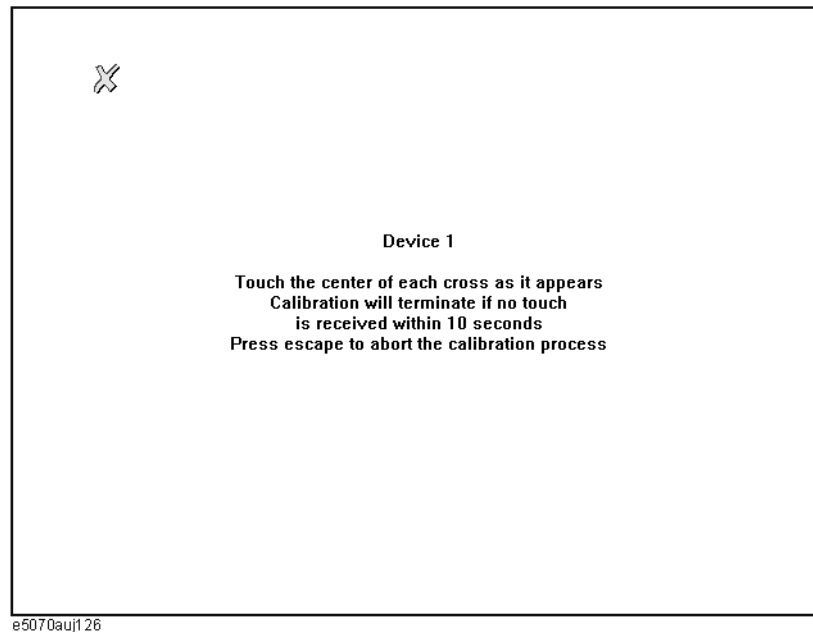

- Step 5.** Touch the x mark on the upper left with your finger. This mark also appears on the lower left, upper right, and lower right. Touch the x marks in that order with your finger. Touching these four locations automatically finishes the touch screen calibration.

---

**NOTE**

With no operation on the touch screen's calibration screen at this time, it automatically closes and the previous measurement screen reappears.

---



---

## Cleaning the Instrument

This section describes how to clean your Agilent E5052A instrument.

---

### WARNING

**To protect yourself from electrical shock, be sure to unplug the power cable from the outlet before cleaning the instrument.**

**Never clean the internal components of the instrument.**

---

### Cleaning the LCD

Use one of the following methods to clean the display surface regularly.

- For normal cleaning, rub the surface gently with a dry, soft cloth.
- When stains are difficult to remove, gently wipe the surface with cloth dampened with a small amount of ethanol or isopropyl alcohol.

---

### NOTE

Do not use chemicals other than ethanol and isopropyl alcohol to wet the cleaning cloth.

Do not wet the cloth with water.

---

### Maintenance of test ports (DUT INTERFACE) and other connectors/ports

The test ports (DUT INTERFACE) on the front panel of the E5052A are fitted with N-type connector (f) and BNC connectors (f). Stains or other damage to these connectors can significantly affect the accuracy in measurements in the RF range. Always take the following precautions.

- Keep the connectors constantly free from stains and dust.
- Do not touch the contact surface on the connectors.
- Do not plug damaged or scratched connectors into the test ports.
- Use compressed air to clean connectors. Do not use abrasives under any circumstance.

The above precautions must also be observed in maintaining connectors and ports other than these test ports.

### Cleaning parts other than the LCD

To remove stains on parts other than the LCD, test ports, and other connectors/ports of the instrument, wipe them gently with a soft cloth that is dry or wetted with a small amount of water and wrung tightly.

## Replacement of Parts with Limited Service Life

This instrument incorporates parts with limited service life as shown in Table 9-1. Using the recommended replacement time shown in Table 9-1 as a guide, request the Agilent Service Center to replace these parts. However, a part may need to be replaced at an earlier time than that listed in the table, depending on such conditions as location, frequency of use, and where it is stored.

**NOTE**

Each service life and recommended replacement time listed below is for reference only and does not imply a guarantee of the part's service life.

**Table 9-1**      **Parts with Limited Service Life**

| Part name                           | Service life (parts supplier reference value)                                        | Recommended replacement time |
|-------------------------------------|--------------------------------------------------------------------------------------|------------------------------|
| Hard disk drive * <sup>1</sup>      | 5 years or 20,000 operating hours, whichever comes earlier                           | 3 years                      |
| Floppy disk drive * <sup>2</sup>    | 5 years or 30,000 operating hours, whichever comes earlier                           | 4 years                      |
| Main fan * <sup>2</sup>             | 50,000 operating hours                                                               | 5 years                      |
| Power supply * <sup>2</sup>         | 50,000 operating hours (depends on the service life of the power supply cooling fan) | 5 years                      |
| LCD screen backlight * <sup>3</sup> | 50,000 operating hours                                                               | 5 years                      |
| Touch screen (function)             | One million 'touches'                                                                | 5 years                      |

\*1. Exchanging hard disk drives causes the contents written after shipment from the factory (LAN setup, etc.) to be initialized to the state at the time of shipment. The programs and data stored in Drive F: (user directory) are erased.

\*2. The service life may be significantly shorter when used in a dusty or dirty environment.

\*3. When the unit is used for automatic measurements in a production line and the on-screen information is not required, the life of the LCD backlight can be saved by turning it off. For the method of turning the backlight off, refer to "Turning off the LCD Screen Backlight" on page 287.

## **Cautions Applicable to Requesting Repair, Replacement, Regular Calibration, etc.**

### **Backing up data in the hard disk**

The user is requested to back up the stored programs and data onto external media by using the instrument's storing function before requesting the Agilent Service Center to repair the instrument or replace hard disks.

See "Making backup files" on page 292 for how to make backup files.

Please take note that Agilent Technologies will not be held liable to any extent for potential erasure or change of stored programs or data due to the repair or replacement of hard disks performed by the Agilent. When a hard disk itself fails, the programs and data stored in it cannot be recovered.

### **Devices to be sent back for repair or regular calibration**

If it is necessary to send the unit to the Service Center of Agilent Technologies for repair or regular calibration, please follow the instructions below.

#### **Equipment to be Sent**

When requesting repair or regular calibration of the unit by our Service Center, send only the E5052A main unit without any installed option you may have ordered. Unless specifically instructed, it is not necessary to send accessories.

#### **Packing**

Use the original package and shock absorbers, or equivalent antistatic packing materials, when sending the unit.

#### **Shipping Address**

For the location of the nearest Agilent Technologies Service Center, contact the Customer Contact listed at the end of this guide.

### **Recommended Calibration Period**

The recommended calibration period for this instrument is one year. The user is recommended to request the Agilent Service Center to perform regular calibration every year.

Information on Maintenance

**Cautions Applicable to Requesting Repair, Replacement, Regular Calibration, etc.**



## Definitions

All specifications apply over a  $23^{\circ}\text{C} \pm 5^{\circ}\text{C}$  range (unless otherwise stated) and 30 minutes after the instrument has been turned on.

**Specification (spec.):** Warranted performance. Specifications include guardbands to account for the expected statistical performance distribution, measurement uncertainties, and changes in performance due to environmental conditions.

Supplemental information is intended to provide information that is helpful for using the instrument but that is not guaranteed by the product warranty. This information is denoted as either typical or nominal.

**Typical (typ.):** Expected performance of an average unit that does not include guardbands. It is not guaranteed by the product warranty.

**Nominal (nom.):** A general, descriptive term that does not imply a level of performance. It is not guaranteed by the product warranty.

## Phase Noise Measurement

**Table 10-1**      **Phase Noise Measurement**

| Description                                                                                                                                        | Specifications                                                                                                                                                                            |
|----------------------------------------------------------------------------------------------------------------------------------------------------|-------------------------------------------------------------------------------------------------------------------------------------------------------------------------------------------|
| Frequency Range                                                                                                                                    | 10 M to 7 GHz<br>Frequency Band :<br>10 M to 41 MHz, 39 M to 101 MHz, 99 M to 1.5 GHz, 300 M to 7 GHz                                                                                     |
| Input Power Level<br>10 MHz to 30 MHz<br>30 MHz to 7 GHz                                                                                           | -15 to + 20 dBm<br>-20 to + 20 dBm                                                                                                                                                        |
| Offset Frequency Range<br>Carrier > 400 MHz<br><br>Carrier < 400 MHz                                                                               | 1 Hz to 40 MHz (Standard)<br>10 Hz to 40 MHz (Option 011)<br><br>1 Hz to 10% of carrier frequency (Standard)<br>10 Hz to 10% of carrier frequency (Option 011)                            |
| Offset Frequency Settable Range<br>Carrier ≥ 99 MHz<br><br>39 MHz ≤ Carrier < 99 MHz<br><br>10 MHz ≤ Carrier < 39 MHz                              | 1 Hz to 40 MHz (Standard)<br>10 Hz to 40 MHz (Option 011)<br><br>1 Hz to 20 MHz (Standard)<br>10 Hz to 20 MHz (Option 011)<br><br>1 Hz to 5 MHz (Standard)<br>10 Hz to 5 MHz (Option 011) |
| Enhanced Phase Noise Sensitivity <sup>*1</sup>                                                                                                     | Cross-Correlation method (Standard)<br>Number of Correlation : 1 to 10000                                                                                                                 |
| Frequency Tracking Range                                                                                                                           | 0.4% of Carrier Frequency                                                                                                                                                                 |
| IF Gain                                                                                                                                            | 0, 10, 20, 30, 40, 50 dB (Standard)<br>0, 10, 20 dB (Option 011)                                                                                                                          |
| Built-in LO Phase Noise Optimization                                                                                                               | < 150 kHz (Optimized for Close-in Phase Noise)<br>> 150 kHz (Optimized for Far-out Phase Noise)<br>See Figure 10-4                                                                        |
| Accuracy<br>1 to 100 Hz offset (Standard)<br>1 to 100 Hz offset (Option 011)<br>100 to 1 kHz offset<br>1 k to 1 MHz offset<br>1 M to 40 MHz offset | < ±4 dB (typical, at 23°C±5°C)<br>< ±4 dB (typical, at 23°C±5°C)<br>< ±4 dB (typical, at 23°C±5°C)<br>< ±2 dB (typical, at 23°C±5°C)<br>< ±3 dB (typical, at 23°C±5°C)                    |

**Table 10-1**            **Phase Noise Measurement**

| Description                                | Specifications                                                     |
|--------------------------------------------|--------------------------------------------------------------------|
| Spurious level                             | 65 dBc (typical), > 1 kHz Offset                                   |
| SSB Phase Noise Sensitivity ( at 23°C±5°C) | See Table 10-2 through Table 10-6, Figure 10-1 through Figure 10-3 |
| Measurement Time                           | See Table 10-7                                                     |

\*1. Not available for Option 011.



**Table 10-2** SSB Phase Noise Sensitivity (Standard, < 150 kHz optim., Measurement quality = Normal, correlation = 1, +5 dBm input, start frequency = 1 Hz, measurement time = 17.7 sec)

| Input Frequency |       | Offset from carrier (Hz) |        |        |        |        |        |        |        |        |
|-----------------|-------|--------------------------|--------|--------|--------|--------|--------|--------|--------|--------|
|                 |       | 1                        | 10     | 100    | 1 k    | 10 k   | 100 k  | 1 M    | 10 M   | 40 M   |
| 10 MHz          | spec. |                          |        |        | -148.5 | -156.5 | -166.5 | -168.5 | -      | -      |
|                 | typ.  | -74.0                    | -114.0 | -144.5 | -152.5 | -160.5 | -170.5 | -172.5 | -      | -      |
| 100 MHz         | spec. |                          |        |        | -148.5 | -156.5 | -163.5 | -168.5 | -170.0 | -      |
|                 | typ.  | -54.0                    | -94.0  | -135.5 | -152.5 | -160.5 | -167.5 | -172.5 | -174.0 | -      |
| 1 GHz           | spec. |                          |        |        | -128.5 | -137.5 | -144.5 | -160.5 | -170.0 | -170.5 |
|                 | typ.  | -34.0                    | -77.0  | -115.5 | -132.5 | -141.5 | -148.5 | -164.5 | -174.0 | -174.5 |
| 3 GHz           | spec. |                          |        |        | -119.0 | -128.0 | -133.7 | -149.7 | -163.2 | -166.7 |
|                 | typ.  | -24.5                    | -64.5  | -106.0 | -123.0 | -132.0 | -137.7 | -153.7 | -167.2 | -170.7 |
| 7 GHz           | spec. |                          |        |        | -111.6 | -120.6 | -127.0 | -143.0 | -156.5 | -160.0 |
|                 | typ.  | -17.1                    | -57.1  | -98.6  | -115.6 | -124.6 | -131.0 | -147.0 | -160.5 | -164.0 |

**Table 10-3** SSB Phase Noise Sensitivity (Standard, < 150 kHz optim., Measurement quality = Fast, correlation = 1, +5 dBm input, start frequency = 1 Hz)

| Input Frequency |       | Offset from carrier (Hz) |        |        |        |        |        |        |        |        |
|-----------------|-------|--------------------------|--------|--------|--------|--------|--------|--------|--------|--------|
|                 |       | 1                        | 10     | 100    | 1 k    | 10 k   | 100 k  | 1 M    | 10 M   | 40 M   |
| 10 MHz          | spec. |                          |        |        | -145.5 | -153.5 | -163.5 | -165.5 | -      | -      |
|                 | typ.  | -74.0                    | -112.5 | -141.5 | -149.5 | -157.5 | -167.5 | -169.5 | -      | -      |
| 100 MHz         | spec. |                          |        |        | -145.5 | -153.5 | -160.5 | -165.5 | -167.0 | -      |
|                 | typ.  | -54.0                    | -92.5  | -132.5 | -149.5 | -157.5 | -164.5 | -169.5 | -171.0 | -      |
| 1 GHz           | spec. |                          |        |        | -125.5 | -134.5 | -141.5 | -157.5 | -167.0 | -167.5 |
|                 | typ.  | -34.0                    | -72.5  | -112.5 | -129.5 | -138.5 | -145.5 | -161.5 | -171.0 | -171.5 |
| 3 GHz           | spec. |                          |        |        | -116.0 | -125.0 | -130.7 | -146.7 | -160.2 | -163.7 |
|                 | typ.  | -24.5                    | -63.0  | -103.0 | -120.0 | -129.0 | -134.7 | -150.7 | -164.2 | -167.7 |
| 7 GHz           | spec. |                          |        |        | -108.6 | -117.6 | -124.0 | -140.0 | -153.5 | -157.0 |
|                 | typ.  | -17.1                    | -55.6  | -95.6  | -112.6 | -121.6 | -128.0 | -144.0 | -157.5 | -161.0 |

**Table 10-4** SSB Phase Noise Sensitivity (Option 011, < 150 kHz optim., Measurement quality = Normal, +5 dBm input, start frequency = 10 Hz, measurement time = 4.4 sec)

| Input Frequency |       | Offset from carrier (Hz) |        |        |        |        |        |        |        |
|-----------------|-------|--------------------------|--------|--------|--------|--------|--------|--------|--------|
|                 |       | 10                       | 100    | 1 k    | 10 k   | 100 k  | 1 M    | 10 M   | 40 M   |
| 10 MHz          | spec. |                          |        | -145.5 | -153.5 | -160.0 | -160.0 | -      | -      |
|                 | typ.  | -106.0                   | -138.5 | -149.5 | -157.5 | -167.5 | -169.5 | -      | -      |
| 100 MHz         | spec. |                          |        | -145.5 | -153.5 | -160.0 | -160.0 | -160.0 | -      |
|                 | typ.  | -94.0                    | -132.5 | -149.5 | -157.5 | -164.5 | -169.5 | -170.0 | -      |
| 1 GHz           | spec. |                          |        | -125.5 | -134.5 | -141.5 | -157.5 | -160.0 | -160.0 |
|                 | typ.  | -74.0                    | -112.5 | -129.5 | -138.5 | -145.5 | -161.5 | -170.0 | -170.0 |
| 3 GHz           | spec. |                          |        | -116.0 | -125.0 | -130.7 | -146.7 | -160.0 | -160.0 |
|                 | typ.  | -64.5                    | -103.0 | -120.0 | -129.0 | -134.7 | -150.7 | -164.2 | -167.7 |
| 7 GHz           | spec. |                          |        | -108.6 | -117.6 | -124.0 | -140.0 | -153.5 | -157.0 |
|                 | typ.  | -57.1                    | -95.6  | -112.6 | -121.6 | -128.0 | -144.0 | -157.5 | -161.0 |

**Table 10-5** SSB Phase Noise Sensitivity (Option 011, < 150 kHz optim., Measurement quality = Fast, +5 dBm input, start frequency = 10 Hz)

| Input Frequency |       | Offset from carrier (Hz) |        |        |        |        |        |        |        |
|-----------------|-------|--------------------------|--------|--------|--------|--------|--------|--------|--------|
|                 |       | 10                       | 100    | 1 k    | 10 k   | 100 k  | 1 M    | 10 M   | 40 M   |
| 10 MHz          | spec. |                          |        | -141.0 | -149.0 | -159.0 | -160.0 | -      | -      |
|                 | typ.  | -114.0                   | -138.0 | -145.0 | -153.0 | -163.0 | -165.0 | -      | -      |
| 100 MHz         | spec. |                          |        | -141.0 | -149.0 | -156.0 | -160.0 | -160.0 | -      |
|                 | typ.  | -94.0                    | -129.0 | -145.0 | -153.0 | -160.0 | -165.0 | -166.5 | -      |
| 1 GHz           | spec. |                          |        | -121.0 | -130.0 | -137.0 | -153.0 | -160.0 | -160.0 |
|                 | typ.  | -74.0                    | -100.0 | -125.0 | -134.0 | -141.0 | -157.0 | -166.5 | -167.0 |
| 3 GHz           | spec. |                          |        | -111.5 | -120.5 | -126.2 | -142.2 | -155.7 | -159.2 |
|                 | typ.  | -64.5                    | -99.5  | -115.5 | -124.5 | -130.2 | -146.2 | -159.7 | -163.2 |
| 7 GHz           | spec. |                          |        | -104.1 | -113.1 | -119.5 | -135.5 | -149.0 | -152.5 |
|                 | typ.  | -57.1                    | -92.1  | -108.1 | -117.1 | -123.5 | -139.5 | -153.0 | -156.5 |

Table 10-6

SSB Phase Noise Sensitivity Improvement by Correlation

| Number of Correlation | 10   | 100   | 1000  | 10000 |
|-----------------------|------|-------|-------|-------|
| Improvement Factor    | 5 dB | 10 dB | 15 dB | 20 dB |

Figure 10-1

SSB Phase Noise Sensitivity (Standard, < 150 kHz optim., Measurement quality = Normal, correlation = 1, start frequency = 1 Hz, measurement time = 17.7 sec), supplemental data

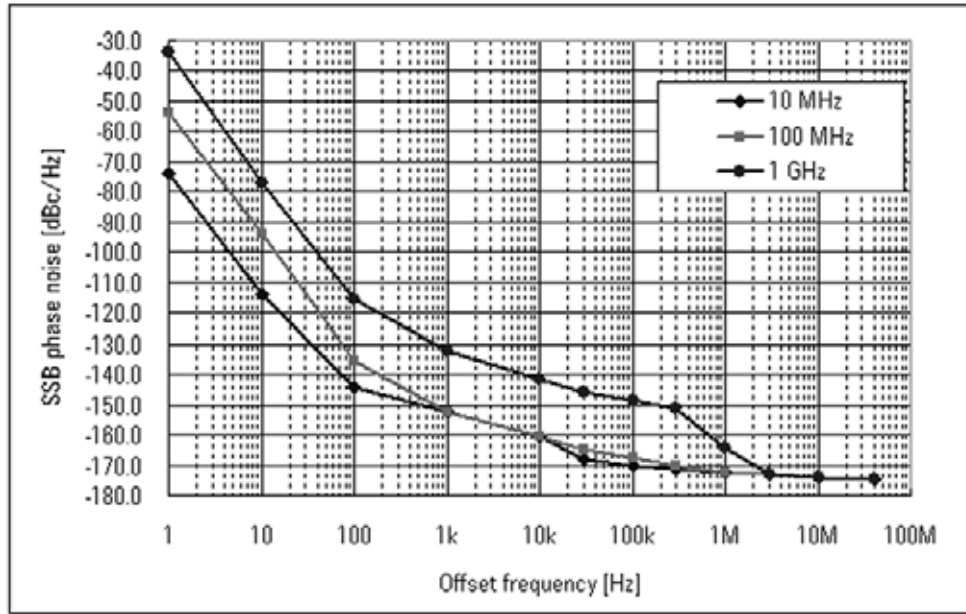

e5052auj401 7

Figure 10-2

SSB Phase Noise Sensitivity (Option 011, < 150 kHz optim., Measurement quality = Normal, start frequency = 10 Hz, measurement time = 4.4 sec), supplemental data

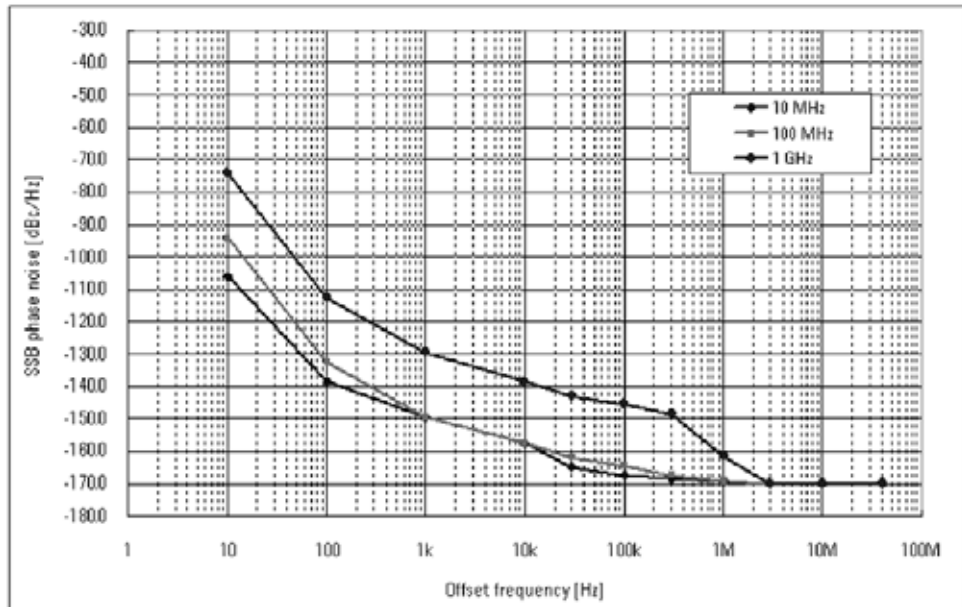

e5052au15020

Figure 10-3

SSB Phase Noise Sensitivity (improvement by correlation, 1 GHz, < 150 kHz optim. Measurement quality = Normal), supplemental data

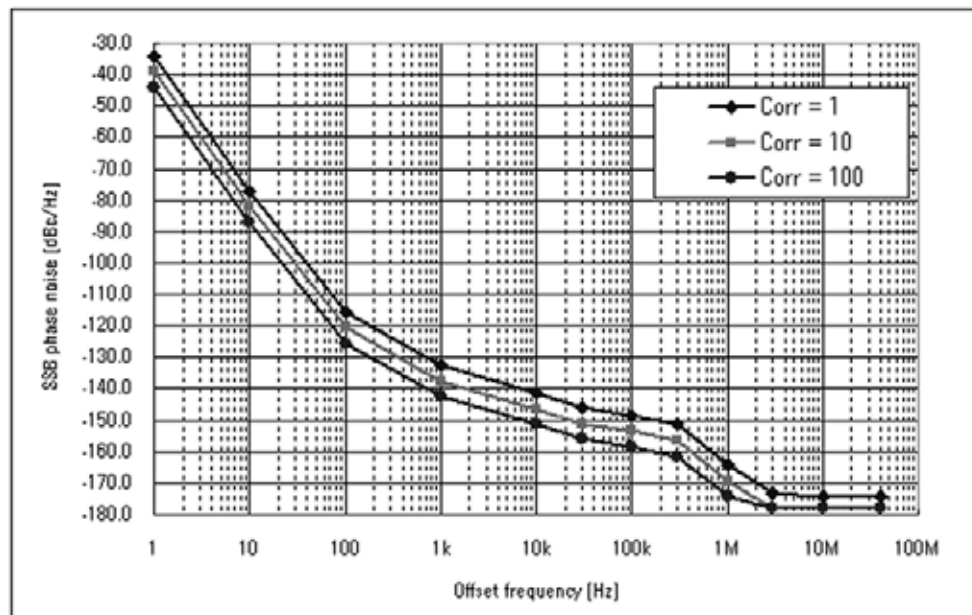

e5052au14019

Figure 10-4

SSB Phase Noise Sensitivity of different LO optimizations (Standard, Measurement quality = Normal, correlation = 1, start frequency = 1 Hz, measurement time = 17.7 sec, 1 GHz), supplemental data

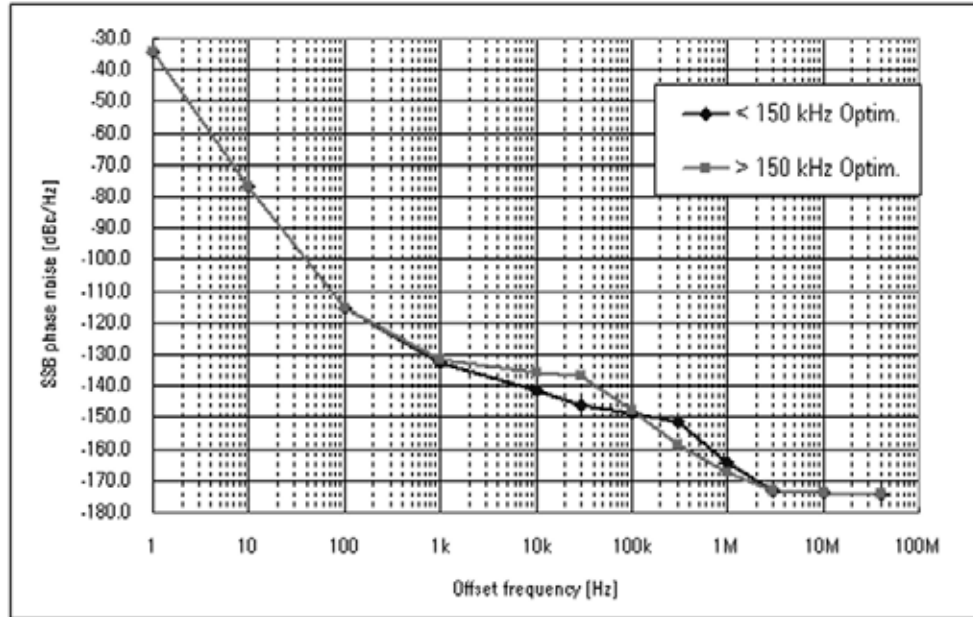

450524ui4020

Table 10-7

Typical measurement time (sec) for phase noise measurement\*1  
(Measurement quality = Normal)

| Stop Frequency (Hz) | Start Frequency (Hz) |      |      |      |
|---------------------|----------------------|------|------|------|
|                     | 1                    | 10   | 100  | 1 k  |
| 100 k               | 10.9                 | 2.70 | 0.34 | 0.04 |
| 1 M                 | 10.7                 | 2.70 | 0.34 | 0.04 |
| 10 M                | 11.1                 | 2.8  | 0.35 | 0.04 |
| 20 M                | 17.7                 | 4.4  | 0.56 | 0.07 |
| 40 M                | 17.7                 | 4.4  | 0.56 | 0.07 |

\*1. Measurement Time (sec) = 0.2 + the above values × number of correlation when applying cross-correlation function (standard only). For Option 011, number of correlation = 1.

**Measurement capabilities**

|                               |                                                                                                                      |
|-------------------------------|----------------------------------------------------------------------------------------------------------------------|
| <b>Phase noise</b>            |                                                                                                                      |
| <b>Measurement parameters</b> | SSB Phase noise, spurious, integrated phase noise, rms noise, rms jitter, residual FM                                |
| <b>Number of trace</b>        | 1 data trace and 1 memory trace                                                                                      |
| <b>Data formats</b>           | dBc/Hz (SSB phase noise), dBc (spurious), rms degree, rms radian (rms noise), sec (rms jitter), Hz rms (residual FM) |
| <b>Measurement Trigger</b>    | Set to continuous, hold, or single, sweep with internal, external, manual, or bus trigger.                           |

**Table 10-8 Limited functions along with the related SCPI commands when option 011 is installed**

| Softkey                   | SCPI Command                | Limitation of values                               |
|---------------------------|-----------------------------|----------------------------------------------------|
| [Start/Center]            | :SENSe:PN:FREQUency:STARt   | The minimum value is down to 10 (Hz) <sup>*1</sup> |
| [Setup] - [IF Gain]       | :SENSe:PN:IFGain            | The value ranges are 0, 10, 20 (dB) <sup>*2</sup>  |
| [Average] - [Correlation] | :SENSe:PN:CORRelation:COUNT | The value is fixed as 1 <sup>*2</sup>              |

\*1. The minimum value is always set to 10 (Hz) when this command receives the value less than 10.

\*2. It is changed to the best value within the range when this command receives the value outside the set range.

## Frequency, RF Power, DC current Measurements

### Specifications of the E5052A use only

**Table 10-9                  Frequency Measurement**

| Description                  | Specifications                                                    |
|------------------------------|-------------------------------------------------------------------|
| Frequency Range              | 10 M to 7 GHz<br>Frequency Band : 10 M to 1.5 GHz, 300 M to 7 GHz |
| Frequency Resolution         | 10 Hz, 1 kHz, 64 kHz                                              |
| Internal time base stability | ±5 ppm (at 23°C±5°C)                                              |
| Accuracy                     | ±(resolution + time base accuracy)                                |

**Table 10-10                RF Power Measurement**

| Description                      | Specifications                                                    |
|----------------------------------|-------------------------------------------------------------------|
| Frequency Range                  | 10 M to 7 GHz<br>Frequency Band : 10 M to 1.5 GHz, 300 M to 7 GHz |
| Input Level                      |                                                                   |
| 10 MHz to 30 MHz                 | -15 dBm to +20 dBm                                                |
| 30 MHz to 7 GHz                  | -20 dBm to +20 dBm                                                |
| Resolution                       | 0.01 dB                                                           |
| Accuracy (Peak Voltage Response) |                                                                   |
| 30 MHz to 3 GHz, >-10 dBm        | ±0.5 dB (at 23°C±5°C)                                             |
| Other than the above             | ±1 dB (at 23°C±5°C)                                               |

**Table 10-11                DC Current Measurement**

| Description   | Specifications                            |
|---------------|-------------------------------------------|
| Current Range | 0 to 80 mA                                |
| Resolution    | 10 µA                                     |
| Accuracy      | ±(0.2% of reading + 160 µA) (at 23°C±5°C) |

**Measurement capabilities**

| <b>Frequency, Power, and DC current (for Standard)</b> |                                                                                                                                                                                                                                                                                                                                                                                                                                                        |
|--------------------------------------------------------|--------------------------------------------------------------------------------------------------------------------------------------------------------------------------------------------------------------------------------------------------------------------------------------------------------------------------------------------------------------------------------------------------------------------------------------------------------|
| <b>Measurement parameters</b>                          | Analyzer mode: *1<br>Frequency versus DC control voltage, dF/dVcontrol (Tuning sensitivity)<br>Frequency versus DC power voltage (Frequency pushing), dF/dVpower<br>RF power versus DC control voltage<br>RF power versus DC power voltage<br>DC current (at DC power port only) versus DC control voltage<br>DC current (at DC power port only) versus DC power voltage<br><br>Tester mode: *1<br>Frequency, power, and DC current (at DC power port) |
| <b>Number of point</b>                                 | 2 to 1001 (for analyzer mode only)                                                                                                                                                                                                                                                                                                                                                                                                                     |
| <b>Data formats</b>                                    | Hz, Hz/V, ΔHz, %, ppm (Frequency)<br>dBm (RF power)<br>A (DC power port only)                                                                                                                                                                                                                                                                                                                                                                          |
| <b>Measurement Trigger</b>                             | Set to continuous, hold, or single, sweep with internal, external, manual, or bus trigger.                                                                                                                                                                                                                                                                                                                                                             |

\*1. Refer to the chapter 4, “Frequency/power measurement in the frequency/power measurement mode” section for the difference between “Analyzer mode” and “Tester mode”

| <b>Frequency, Power, and DC current (for Option 011) *Point measurement only</b> |                                                                                     |
|----------------------------------------------------------------------------------|-------------------------------------------------------------------------------------|
| <b>Measurement parameters</b>                                                    | Frequency, power, and DC current (at DC power port) (Numerical Display Only)        |
| <b>Data formats</b>                                                              | Hz (Frequency), dBm(RF power), A(DC power port only).                               |
| <b>Measurement Trigger</b>                                                       | Set to continuous, hold, or single with internal, external, manual, or bus trigger. |

**Softkeys and SCPI commands that are not available when using “Tester” mode or option 011 is installed**

**Table 10-12**

| Softkeys                         | SCPI commands                                                                                  |
|----------------------------------|------------------------------------------------------------------------------------------------|
| [Format]                         | :CALCulate:FP[1-1]:TRACe[1-3]                                                                  |
| [Display] - [Marker Information] | :DISPlay:FP[1-1]:ANNOtation:MARKer:POSition                                                    |
| [Display] - [Relative Y-Scale]   | :DISPlay:FP[1-1]:GRATicule:AXIS:Y:RELative                                                     |
| [Display] - [Y # of Digits]      | :DISPlay:FP[1-1]:GRATicule:AXIS:Y:STATe                                                        |
| [Marker]                         | :CALCulate:FP[1-1]:TRACe[1-3]<br>:CALCulate:FP[1-1]:ALLTrace<br>:DISPlay:FP[1-1]:TABLe[:STATe] |



**Table 10-12**

|                                     |                                                                                                                          |
|-------------------------------------|--------------------------------------------------------------------------------------------------------------------------|
| [Marker Function]                   | :CALCulate:FP[1-1]:TRACe[1-3]<br>:CALCulate:FP[1-1]:ALLTrace                                                             |
| [Marker Search]                     | :CALCulate:FP[1-1]:TRACe[1-3]                                                                                            |
| [Marker To]                         | :SOURce:FP[1-1]:VOLTage                                                                                                  |
| [Save/Recall] - [Save Data Trace]   | :MMEMory:FP[1-1]:TRACe[1-3]:STORE[:DATA]                                                                                 |
| [Save/Recall] - [Save Memory Trace] | :MMEMory:FP[1-1]:TRACe[1-3]:STORE:MEMory                                                                                 |
| [Scale]                             | :DISPlay:FP[1-1]:TRACe[1-3]:Y[:SCALe]<br>:DISPlay:FP[1-1]:ALLTrace:Y[:SCALe]:AUTO<br>:DISPlay:FP[1-1]:Y[:SCALe]:DIVision |
| [Setup] - [Point]                   | :SOURce:FP[1-1]:SWEep:POINt                                                                                              |
| [Setup] - [Sweep Parameter]         | :SOURce:FP[1-1]:SWEep:PARAmeter                                                                                          |
| [Start/Center]                      | :SOURce:FP[1-1]:VOLTage                                                                                                  |
| [Stop/Span]                         | :SOURce:FP[1-1]:VOLTage                                                                                                  |
| [Trace View]                        | :CALCulate:FP[1-1]:TRACe<br>:DISPlay:FP[1-1]:TRACe                                                                       |
| Command Only                        | :CALCulate:FP[1-1]:DATA:RDATA                                                                                            |
|                                     | :CALCulate:FP[1-1]:DATA:XDATA                                                                                            |
|                                     | :DISPlay:FP[1-1]:MAXimize                                                                                                |
|                                     | :SENSe:FP[1-1]:SWEep:TIME:DATA                                                                                           |

## Transient Measurement

**Table 10-13** Transient Measurement

| Description                                 | Specifications                                                                       |
|---------------------------------------------|--------------------------------------------------------------------------------------|
| Measurement Function                        | Frequency, Power, Phase                                                              |
| Target Frequency Range                      | 10 MHz to 7 GHz                                                                      |
| Input Power Level                           | -20 to +20 dBm                                                                       |
| Frequency Transient Range                   |                                                                                      |
| Wide Band                                   | See Table 10-14                                                                      |
| Narrow Band                                 | 3.125 kHz, 25 kHz, 200 kHz, 1.6 MHz or 25.6 MHz<br>(Target frequency $\geq$ 200 MHz) |
| Time Span                                   | 10 $\mu$ sec to 100 msec, 1, 2, 5 step                                               |
| Time resolution                             | 10 nsec to 100 $\mu$ sec                                                             |
| Frequency Transient measurement             |                                                                                      |
| Accuracy                                    | $\pm$ (frequency resolution <sup>*1</sup> + time base accuracy)                      |
| Power Transient measurement                 |                                                                                      |
| Range                                       | -20 dBm to +20 dBm                                                                   |
| Accuracy                                    | $\pm$ 2 dB (typical, , at 23°C $\pm$ 5°C)                                            |
| Resolution                                  | 0.1 dB (typical)                                                                     |
| Phase Transient measurement <sup>*2*3</sup> |                                                                                      |
| Accuracy                                    | 0.1 deg/GHz (0.1 deg min.) (typical, at 23°C $\pm$ 5°C)                              |
| Trace noise                                 | 0.02 deg/GHz (0.02 deg min.) (typical, at 23°C $\pm$ 5°C)                            |
| Stability                                   | 10 deg/sec (typical, at 23°C $\pm$ 5°C)                                              |

\*1. See Table 10-15 through Table 10-21 for details.

\*2. The time base of DUT is required to lock with the time base of the analyzer.

\*3. When a DUT's frequency is settled to a selected phase reference frequency.

**Table 10-14** Wide Band Frequency Selection Table

|                     |     |     |     |     |      |      |      |      |      |      |      |      |      |      |      |      |
|---------------------|-----|-----|-----|-----|------|------|------|------|------|------|------|------|------|------|------|------|
| Frequency Max (MHz) | 150 | 300 | 600 | 900 | 1200 | 1500 | 1800 | 2400 | 3000 | 3600 | 4200 | 4800 | 5400 | 6000 | 6600 | 7200 |
| Frequency Min (MHz) | 50  | 100 | 200 | 300 | 400  | 500  | 600  | 800  | 1000 | 1200 | 1400 | 1600 | 1800 | 2000 | 2200 | 2400 |

**Table 10-15 Wide Band Transient (Time span, Time resolution and number of points)**

|                              |          |          |          |           |           |           |      |      |      |      |     |      |       |
|------------------------------|----------|----------|----------|-----------|-----------|-----------|------|------|------|------|-----|------|-------|
| Time Span (sec)              | 10 $\mu$ | 20 $\mu$ | 50 $\mu$ | 100 $\mu$ | 200 $\mu$ | 500 $\mu$ | 1 m  | 2 m  | 5 m  | 10 m | 20m | 50 m | 100 m |
| Time Resolution ( $\mu$ sec) | 0.01     | 0.02     | 0.05     | 0.1       | 0.2       | 0.5       | 1    | 2    | 6.25 | 12.5 | 25  | 62.5 | 125   |
| Number of point              | 1001     | 1001     | 1001     | 1001      | 1001      | 1001      | 1001 | 1001 | 801  | 801  | 801 | 801  | 801   |

|                              |       |       |      |      |      |
|------------------------------|-------|-------|------|------|------|
| Time Span (sec)              | 200 m | 500 m | 1    | 2    | 5    |
| Time Resolution ( $\mu$ sec) | 250   | 625   | 1250 | 2500 | 6250 |
| Number of point              | 801   | 801   | 801  | 801  | 801  |

**Table 10-16 Frequency Resolution (Hzrms) of Wide Band Transient**

| Transient Frequency Band (MHz) | Time Span (sec)       |           |           |          |
|--------------------------------|-----------------------|-----------|-----------|----------|
|                                | 10 $\mu$ to 100 $\mu$ | 200 $\mu$ | 500 $\mu$ | 1 m to 5 |
| 50 to 150                      | 28 k                  | 10 k      | 3 k       | 1 k      |
| 100 to 300                     | 56 k                  | 20 k      | 7 k       | 2 k      |
| 200 to 600                     | 113 k                 | 40 k      | 14 k      | 5 k      |
| 300 to 900                     | 169 k                 | 60 k      | 21 k      | 7 k      |
| 400 to 1200                    | 226 k                 | 80 k      | 28 k      | 10 k     |
| 500 to 1500                    | 282 k                 | 100 k     | 35 k      | 12 k     |
| 600 to 1800                    | 339 k                 | 120 k     | 42 k      | 15 k     |
| 800 to 2400                    | 452 k                 | 160 k     | 56 k      | 20 k     |
| 1000 to 3000                   | 565 k                 | 200 k     | 70 k      | 25 k     |
| 1200 to 3600                   | 678 k                 | 240 k     | 84 k      | 30 k     |
| 1400 to 4200                   | 791 k                 | 280 k     | 98 k      | 35 k     |
| 1600 to 4800                   | 905 k                 | 320 k     | 113 k     | 40 k     |
| 1800 to 5400                   | 1 M                   | 360 k     | 127 k     | 45 k     |
| 2000 to 6000                   | 1 M                   | 400 k     | 141 k     | 50 k     |
| 2200 to 6600                   | 1 M                   | 440 k     | 155 k     | 55 k     |
| 2400 to 7200                   | 1 M                   | 480 k     | 169 k     | 60 k     |

**Table 10-17 Narrow Band Transient (Frequency Transient Range = 3.125 kHz)**

|                              |        |        |        |        |        |        |        |
|------------------------------|--------|--------|--------|--------|--------|--------|--------|
| Time Span (sec)              | 100 m  | 200 m  | 500 m  | 1      | 2      | 5      | 10     |
| Frequency Resolution (Hzrms) | 0.0095 | 0.0095 | 0.0034 | 0.0012 | 0.0004 | 0.0004 | 0.0004 |
| Time Resolution ( $\mu$ sec) | 81.92  | 163.84 | 409.6  | 819.2  | 1638.4 | 4096   | 10240  |
| Number of point              | 1222   | 1222   | 1222   | 1222   | 1222   | 1222   | 978    |

Specifications and Supplemental Information  
**Transient Measurement**

**Table 10-18 Narrow Band Transient (Frequency Transient Range = 25 kHz)**

|                              |       |       |       |       |        |        |        |        |        |        |
|------------------------------|-------|-------|-------|-------|--------|--------|--------|--------|--------|--------|
| Time Span (sec)              | 10 m  | 20 m  | 50 m  | 100 m | 200 m  | 500 m  | 1      | 2      | 5      | 10     |
| Frequency Resolution (Hzrms) | 0.22  | 0.22  | 0.076 | 0.027 | 0.0095 | 0.0095 | 0.0095 | 0.0095 | 0.0095 | 0.0095 |
| Time Resolution (µsec)       | 10.24 | 20.48 | 51.2  | 102.4 | 204.8  | 512    | 1280   | 1250   | 6400   | 12800  |
| Number of point              | 978   | 978   | 978   | 978   | 978    | 978    | 783    | 783    | 783    | 783    |

**Table 10-19 Narrow Band Transient (Frequency Transient Range = 200 kHz)**

|                              |      |      |     |      |      |      |       |       |       |      |      |      |       |
|------------------------------|------|------|-----|------|------|------|-------|-------|-------|------|------|------|-------|
| Time Span (sec)              | 1 m  | 2 m  | 5 m | 10 m | 20 m | 50 m | 100 m | 200 m | 500 m | 1    | 2    | 5    | 10    |
| Frequency Resolution (Hzrms) | 4.9  | 4.9  | 1.7 | 0.6  | 0.2  | 0.2  | 0.2   | 0.2   | 0.2   | 0.2  | 0.2  | 0.2  | 0.2   |
| Time Resolution (µsec)       | 1.28 | 2.56 | 6.4 | 12.8 | 25.6 | 64   | 160   | 320   | 800   | 1600 | 3200 | 8000 | 16000 |
| Number of point              | 783  | 783  | 783 | 783  | 783  | 783  | 626   | 626   | 626   | 626  | 626  | 626  | 626   |

**Table 10-20 Narrow Band Transient (Frequency Transient Range = 1.6 MHz)**

|                              |       |       |       |      |      |      |      |      |      |       |       |       |      |
|------------------------------|-------|-------|-------|------|------|------|------|------|------|-------|-------|-------|------|
| Time Span (sec)              | 100 µ | 200 µ | 500 µ | 1 m  | 2 m  | 5 m  | 10 m | 20 m | 50 m | 100 m | 200 m | 500 m | 1    |
| Frequency Resolution (Hzrms) | 110   | 110   | 110   | 39   | 21   | 14   | 5    | 5    | 5    | 5     | 5     | 5     | 5    |
| Time Resolution (µsec)       | 0.16  | 0.32  | 0.8   | 0.8  | 1.6  | 4    | 8    | 20   | 80   | 160   | 320   | 800   | 1600 |
| Number of point              | 626   | 626   | 626   | 1251 | 1251 | 1251 | 1251 | 1001 | 626  | 626   | 626   | 626   | 626  |

|                              |      |      |       |
|------------------------------|------|------|-------|
| Time Span (sec)              | 2    | 5    | 10    |
| Frequency Resolution (Hzrms) | 5    | 5    | 5     |
| Time Resolution (µsec)       | 3200 | 8000 | 16000 |
| Number of point              | 626  | 626  | 626   |

**Table 10-21 Narrow Band Transient (Frequency Transient Range = 25.6 MHz)**

|                              |      |      |      |       |       |       |      |      |      |      |      |      |       |
|------------------------------|------|------|------|-------|-------|-------|------|------|------|------|------|------|-------|
| Time Span (sec)              | 10 µ | 20 µ | 50 µ | 100 µ | 200 µ | 500 µ | 1 m  | 2 m  | 5 m  | 10 m | 20 m | 50 m | 100 m |
| Frequency Resolution (Hzrms) | 7 k  | 7 k  | 7 k  | 7 k   | 3 k   | 884   | 313  | 313  | 313  | 313  | 313  | 313  | 313   |
| Time Resolution (µsec)       | 0.01 | 0.02 | 0.05 | 0.1   | 0.2   | 0.5   | 1    | 2    | 6.25 | 12.5 | 25   | 62.5 | 125   |
| Number of point              | 1001 | 1001 | 1001 | 1001  | 1001  | 1001  | 1001 | 1001 | 801  | 801  | 801  | 801  | 801   |

|                              |       |       |      |       |       |
|------------------------------|-------|-------|------|-------|-------|
| Time Span (sec)              | 200 m | 500 m | 1    | 2     | 5     |
| Frequency Resolution (Hzrms) | 313   | 313   | 313  | 312.5 | 312.5 |
| Time Resolution (µsec)       | 250   | 625   | 1250 | 2500  | 6250  |
| Number of point              | 801   | 801   | 801  | 801   | 801   |

**Measurement capabilities**

| <b>Transient</b>              |                                                                                                                                                |
|-------------------------------|------------------------------------------------------------------------------------------------------------------------------------------------|
| <b>Measurement parameters</b> | Frequency versus time (Wide band)<br>Frequency versus time (Narrow band)<br>Phase versus time (Narrow band)<br>Power versus time (Narrow band) |
| <b>Number of trace</b>        | 1 data trace and 1 memory trace per measurement trace                                                                                          |
| <b>Data formats</b>           | Hz(Frequency versus time), dBm(Power versus time),<br>degree/radian/gradian (phase versus time), wrap phase ON/OFF                             |
| <b>Measurement Trigger</b>    | Set to continuous, hold, or single, sweep with internal, external, manual,<br>bus, or video trigger.                                           |

## Spectrum Monitor

**Table 10-22** Spectrum Monitor

| Description             | Specifications                                                  |
|-------------------------|-----------------------------------------------------------------|
| Frequency Range         | 10 M to 7 GHz                                                   |
| Frequency Span          | 20% of center frequency (center frequency: 10 MHz to 50 MHz)    |
|                         | 10 MHz (center frequency: 50 MHz to 100 MHz)                    |
|                         | 15 MHz (center frequency: greater equal than 100 MHz)           |
| RBW                     | 1.53 Hz to 400 kHz                                              |
| Absolute Level Accuracy | ±2 dB @-10 dBm, Attenuator = 0 dB (typical, at 23°C±5°C)        |
| Relative Level Accuracy | ±1.5 dB @ratio of -10 dBm to -60 dBm during sweep (at 23°C±5°C) |
| Noise Floor             | -95 dBm @RBW=24.4 Hz (typical, at 23°C±5°C)                     |
| Spurious                |                                                                 |
| Mixer harmonics         | -30 dBc (typical, at 23°C±5°C)                                  |
| IF distortion           | -40 dBc (typical, at 23°C±5°C)                                  |

### Measurement capabilities

| Spectrum monitor           |                                                                                            |
|----------------------------|--------------------------------------------------------------------------------------------|
| <b>Number of trace</b>     | 1 data trace and 1 memory trace per measurement trace                                      |
| <b>Data formats</b>        | dBm, dBV, Watt, Volt, dBm/Hz, dBV/Hz, Watt/Hz, Volt/ $\sqrt{Hz}$                           |
| <b>Measurement Trigger</b> | Set to continuous, hold, or single, sweep with internal, external, manual, or bus trigger. |

## Port Output (DC Power/Control)

**Table 10-23 DC Power Voltage Output**

| Description            | Specifications                                                    |
|------------------------|-------------------------------------------------------------------|
| Voltage Range          | 0 to 16 V                                                         |
| Resolution             | 1 mV                                                              |
| Setting Accuracy       | $\pm(0.2\% + 2 \text{ mV})$ (at 23°C±5°C)                         |
| Maximum output current | 80 mA                                                             |
| Noise                  | $< 10 \text{ nV}/\sqrt{\text{Hz}}$ @10 kHz (typical, at 23°C±5°C) |
| Output Resistance      | $< 0.3 \Omega$ (typical)                                          |

**Table 10-24 DC Control Voltage Output**

| Description            | Specifications                                                                            |
|------------------------|-------------------------------------------------------------------------------------------|
| Voltage Range          | -15 to 35 V                                                                               |
| Resolution             | 0.1 mV                                                                                    |
| Setting Accuracy       |                                                                                           |
| -15 to 0 V             | $\pm((\text{setting} + 15 \text{ V}) \times 0.1\% + 5 \text{ mV})$ (typical, at 23°C±5°C) |
| 0 to 35 V              | $\pm(\text{setting} \times 0.1\% + 2 \text{ mV})$ (typical, at 23°C±5°C)                  |
| Maximum output current | 20 mA (typical)                                                                           |
| Noise                  |                                                                                           |
| 0 to 20 V              | $1 \text{ nV}/\sqrt{\text{Hz}}$ @10 kHz (typical, at 23°C±5°C)                            |
| -15 to 0 V, 20 to 35 V | $1.5 \text{ nV}/\sqrt{\text{Hz}}$ @10 kHz (typical, at 23°C±5°C)                          |
| Output resistance (DC) | $< 50 \Omega$                                                                             |
| Output resistance (AC) | 50 $\Omega$ (nominal)                                                                     |

## Test Port Input

Table 10-25

RF IN

| Description      | Specifications               |
|------------------|------------------------------|
| Input Level      |                              |
| 10 M to 30 MHz   | -15 to +20 dBm               |
| 30 M to 7 GHz    | -20 to +20 dBm               |
| Input Attenuator | 0 to 35 dB in 5 dB steps     |
| Damage Level     | +23 dBm (nominal)            |
| VSWR             |                              |
| 10 M to 30 MHz   | < 1.6 (at 23°C±5°C)          |
| 30 M to 2 GHz    | < 1.2 (at 23°C±5°C)          |
| 2 G to 3 GHz     | < 1.3 (at 23°C±5°C)          |
| 3 G to 4 GHz     | < 1.3 (typical, at 23°C±5°C) |
| 4 G to 7 GHz     | < 1.5 (typical, at 23°C±5°C) |



## General Information

**Table 10-26 Front Panel Information**

| Description             | Supplemental Information              |
|-------------------------|---------------------------------------|
| <b>RF IN</b>            |                                       |
| Type                    | Type-N, female, 50 $\Omega$ (nominal) |
| <b>DC POWER/CONTROL</b> |                                       |
| Type                    | BNC, female, 50 $\Omega$ (nominal)    |
| <b>Display</b>          |                                       |
| Size                    | 10.4 in TFT color LCD                 |
| Resolution              | VGA (640 $\times$ 480) <sup>*1</sup>  |

\*1. Valid pixels are 99.99 % and more. Below 0.01 % (approx. 30 points) of fixed points of black, blue, green or red are not regarded as failure.

**Table 10-27 Rear Panel Information**

| Description                                       | Supplemental Information                                                                                                                                                                                                 |
|---------------------------------------------------|--------------------------------------------------------------------------------------------------------------------------------------------------------------------------------------------------------------------------|
| <b>External Trigger Connector</b>                 |                                                                                                                                                                                                                          |
| Type                                              | BNC, female                                                                                                                                                                                                              |
| Input level                                       | LOW threshold voltage: 0.5 V<br>HIGH threshold voltage: 2.1 V<br>Input level range: 0 to + 5 V                                                                                                                           |
| Pulse width                                       | ≥ 2 μsec, typical                                                                                                                                                                                                        |
| Polarity                                          | Positive/Negative selectable                                                                                                                                                                                             |
| <b>External Reference Signal Input Connector</b>  |                                                                                                                                                                                                                          |
| Type                                              | BNC, female                                                                                                                                                                                                              |
| Input Frequency                                   | 10 MHz ± 10 Hz, typical                                                                                                                                                                                                  |
| Input Level                                       | -6 dBm to + 16 dBm, typical                                                                                                                                                                                              |
| <b>Internal Reference Signal Output Connector</b> |                                                                                                                                                                                                                          |
| Type                                              | BNC, female                                                                                                                                                                                                              |
| Output Frequency                                  | 10 MHz ± 50 Hz, typical                                                                                                                                                                                                  |
| Signal Type                                       | Sine Wave, nominal                                                                                                                                                                                                       |
| Output Level                                      | 2.5 dBm ± 3 dB, typical                                                                                                                                                                                                  |
| Output Impedance                                  | 50 Ω, nominal                                                                                                                                                                                                            |
| <b>VGA Video Output</b>                           | 15-pin mini D-Sub; female; drives VGA compatible monitors                                                                                                                                                                |
| <b>GPIOB</b>                                      | 24-pin D-Sub (Type D-24), female; compatible with IEEE-488                                                                                                                                                               |
| <b>Parallel Port</b>                              | 36-pin D-Sub (Type 1284-C), female; provides connection to printers                                                                                                                                                      |
| <b>USB Port</b>                                   |                                                                                                                                                                                                                          |
| Contact 1                                         | Universal Serial Bus jack, Type A configuration (4 contacts inline, contact 1 on left); female; provides connection to printer, USB/GPIB interface<br>Vcc: 4.75 to 5.25 VDC, 500 mA, maximum<br>-Data<br>+Data<br>Ground |
| Contact 2                                         |                                                                                                                                                                                                                          |
| Contact 3                                         |                                                                                                                                                                                                                          |
| Contact 4                                         |                                                                                                                                                                                                                          |
| <b>USB (USBTMC<sup>*1</sup>) Interface Port</b>   | Universal Serial Bus jack, Type B configuration (4 contact inline); female; provides connection to an external PC; compatible with USBTMC-USB488 and USB 2.0.                                                            |
| <b>LAN</b>                                        | 10/100 BaseT Ethernet, 8-pin configuration; auto selects between the two data rates                                                                                                                                      |





**Table 10-27 Rear Panel Information**

| Description            | Supplemental Information                                    |
|------------------------|-------------------------------------------------------------|
| <b>24 Bit I/O Port</b> | 36-pin D-sub, female; provides connection to handler system |
| <b>Line Power</b> *2   |                                                             |
| Frequency              | 47 Hz to 63 Hz                                              |
| Voltage                | 90 to 132 VAC, or 198 to 264 VAC (automatically switched)   |
| VA Max                 | 500 VA max.                                                 |

\*1. USB Test and Measurement Class (TMC) interface that communicates over USB, complying with the IEEE 488.1 and IEEE 488.2 standards.

\*2. A third-wire ground is required.

**Table 10-28 EMC and Safety**

| Description                                                                                           | Supplemental Information                                                                                                                                                                                                                                                                                                                                                                                                                                                                                                                                                                                                                                                             |
|-------------------------------------------------------------------------------------------------------|--------------------------------------------------------------------------------------------------------------------------------------------------------------------------------------------------------------------------------------------------------------------------------------------------------------------------------------------------------------------------------------------------------------------------------------------------------------------------------------------------------------------------------------------------------------------------------------------------------------------------------------------------------------------------------------|
| <b>EMC</b>                                                                                            |                                                                                                                                                                                                                                                                                                                                                                                                                                                                                                                                                                                                                                                                                      |
| <br><b>ISM 1-A</b>   | European Council Directive 89/336/EEC, 92/31/EEC, 93/68/EEC<br>IEC 61326-1:1997 +A1:1998 +A2:2000/EN 61326-1:1997 +A1:1998 +A2:2001<br>CISPR 11:1997 +A1:1999/EN 55011:1998 +A1:1999<br>Group 1, Class A<br>IEC 61000-4-2:1995 +A1:1998/EN 61000-4-2:1995 +A1:1998<br>4 kV CD / 8 kV AD<br>IEC 61000-4-3:1995 +A1:1998/EN 61000-4-3:1996 +A1:1998<br>3 V/m, 80-1000 MHz, 80% AM<br>IEC 61000-4-4:1995/EN 61000-4-4:1995<br>1 kV power / 0.5 kV Signal<br>IEC 61000-4-5:1995/EN 61000-4-5:1995<br>0.5 kV Normal / 1 kV Common<br>IEC 61000-4-6:1996/EN 61000-4-6:1996<br>3 V, 0.15-80 MHz, 80% AM<br>IEC 61000-4-11:1994/EN 61000-4-11:1994<br>100% 1cycle European Council Directive |
| <b>ICES/NMB-001</b>                                                                                   | This ISM device complies with Canadian ICES-001:1998.<br>Cet appareil ISM est conforme a la norme NMB-001 du Canada.                                                                                                                                                                                                                                                                                                                                                                                                                                                                                                                                                                 |
|  <b>N10149</b>     | AS/NZS 2064.1/2 Group 1, Class A                                                                                                                                                                                                                                                                                                                                                                                                                                                                                                                                                                                                                                                     |
| <b>Safety</b>                                                                                         |                                                                                                                                                                                                                                                                                                                                                                                                                                                                                                                                                                                                                                                                                      |
| <br><b>ISM 1-A</b> | European Council Directive 73/23/EEC, 93/68/EEC<br>IEC 61010-1:2001/EN 61010-1:2001<br>Measurement Category I, Pollution Degree 2, Indoor Use<br>IEC60825-1:1994 Class 1 LED                                                                                                                                                                                                                                                                                                                                                                                                                                                                                                         |
|  <b>LR95111C</b>   | CAN/CSA C22.2 No. 1010.1-92                                                                                                                                                                                                                                                                                                                                                                                                                                                                                                                                                                                                                                                          |
| <b>Environment</b>                                                                                    |                                                                                                                                                                                                                                                                                                                                                                                                                                                                                                                                                                                                                                                                                      |
|                    | This product complies with the WEEE Directive (2002/96/EC) marking requirements. The affixed label indicates that you must not discard this electrical/ electronic product in domestic household waste.<br>Product Category : With reference to the equipment types in the WEEE Directive Annex I, this product is classed as a “Monitoring and Control instrumentation” product.<br>Do not dispose in domestic household waste.<br>To return unwanted products, contact your local Agilent office, or see <a href="http://www.agilent.com/environment/product/">www.agilent.com/environment/product/</a> for more information.                                                      |

**Table 10-29 Analyzer Environment and Dimensions**

| Description                              | Supplemental Information                                       |
|------------------------------------------|----------------------------------------------------------------|
| <b>Operating Environment</b>             |                                                                |
| Temperature                              | +10 °C to +40 °C                                               |
| Humidity                                 | 20 % to 80 % at wet bulb temperature < +29 °C (non-condensing) |
| Altitude                                 | 0 to 2,000 m (0 to 6,561 feet)                                 |
| Vibration                                | 0.21 G maximum, 5 Hz to 500 Hz                                 |
| <b>Non-Operating Storage Environment</b> |                                                                |
| Temperature                              | -10 °C to +60 °C                                               |
| Humidity                                 | 20 % to 90 % at wet bulb temperature < +40 °C (non-condensing) |
| Altitude                                 | 0 to 4,572 m (0 to 15,000 feet)                                |
| Vibration                                | 0.5 G maximum, 5 Hz to 500 Hz                                  |
| <b>Dimensions</b>                        | See Figure 10-5 through Figure 10-8.                           |
| <b>Weight (Net)</b>                      | 21 kg                                                          |

**Figure 10-5 Dimensions (front view, in millimeters, nominal)**

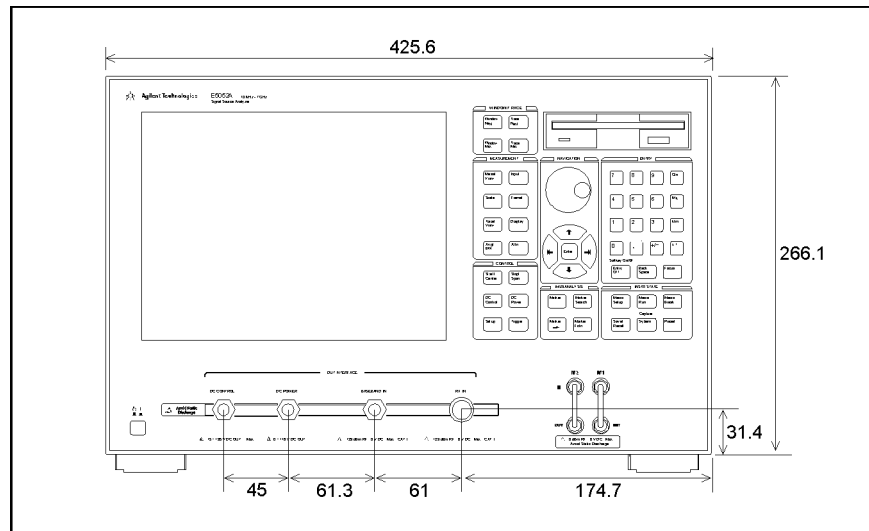

e5052auj4015

Figure 10-6

Dimensions (rear view, in millimeters, nominal)

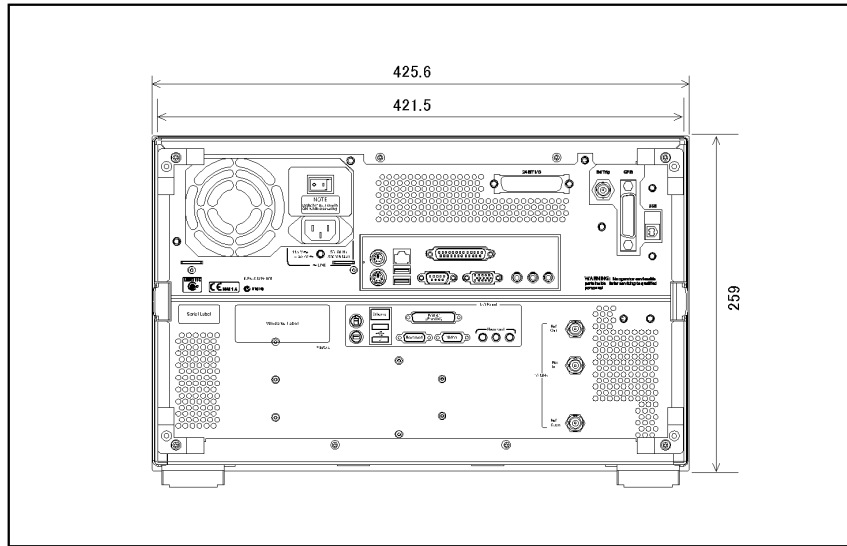

e5052auj4012

Figure 10-7

Dimensions (side view, in millimeters, nominal)

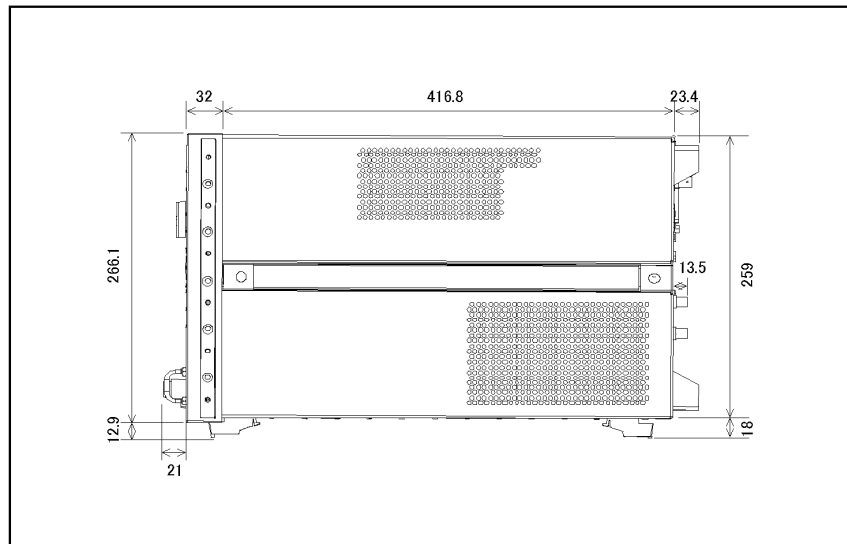

e5052auj4013

Figure 10-8 Dimensions (top view, in millimeters, nominal)

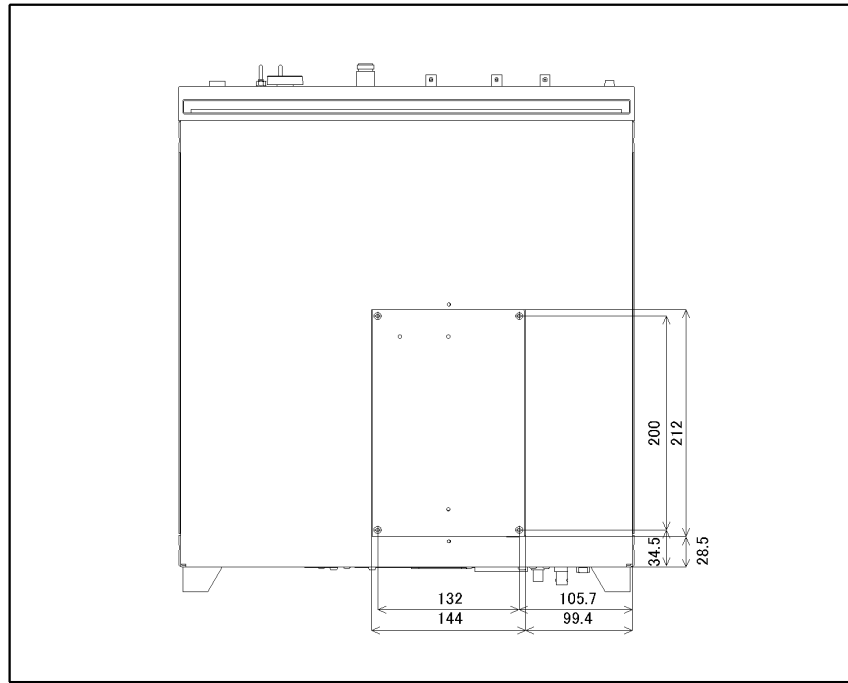

e5052auj4014

## Measurement capabilities

|                                      |                                                                                                                                                                         |
|--------------------------------------|-------------------------------------------------------------------------------------------------------------------------------------------------------------------------|
| <b>Number of measurement windows</b> | Up to 4 measurement windows and 1 user defined window.                                                                                                                  |
| <b>Data markers</b>                  | 10 independent markers per trace. Reference marker available for delta marker operation.                                                                                |
| <b>Marker functions</b>              |                                                                                                                                                                         |
| <b>Marker search</b>                 | Max value, Min value, peak, peak left, peak right, target, target left, target right, multi-peak, multi-target, bandwidth parameters with user-defined bandwidth values |
| <b>Marker-to functions</b>           | Set start, stop, center to active marker stimulus value; set reference to active marker response value.                                                                 |
| <b>Search range</b>                  | User definable                                                                                                                                                          |
| <b>Tracking</b>                      | Performs marker search continuously or on demand                                                                                                                        |
| <b>User defined window</b>           |                                                                                                                                                                         |
| <b>Number of trace</b>               | 8 data traces and 8 memory traces.                                                                                                                                      |

## DC Power/Control Voltage Setting

|                                            |                                             |
|--------------------------------------------|---------------------------------------------|
| <b>Measured number of points per sweep</b> | User definable from 2 to 1001.              |
| <b>Sweep type (parameter)</b>              | Control voltage sweep, power voltage sweep. |
| <b>Control Voltage</b>                     | Set control voltage from -15 V to +35 V.    |
| <b>Power Voltage</b>                       | Set power voltage from 0 V to +16 V.        |



## Trace functions

|                     |                                                                                                       |
|---------------------|-------------------------------------------------------------------------------------------------------|
| <b>Display data</b> | Display current measurement data, memory data, or current measurement and memory data simultaneously. |
| <b>Trace math</b>   | Addition, subtraction, multiplication or division of measured values and memory data.                 |
| <b>Title</b>        | Add custom title to each channel window. Titles are printed on hardcopies of displayed measurements.  |
| <b>Autoscale</b>    | Automatically selects scale resolution and reference value to vertically center the trace.            |
| <b>Statistics</b>   | Calculates and displays mean, standard deviation and peak-to-peak deviation of the data trace.        |

## Storage

|                                 |                                                                                                                                                                                                                                                                                       |
|---------------------------------|---------------------------------------------------------------------------------------------------------------------------------------------------------------------------------------------------------------------------------------------------------------------------------------|
| <b>Internal hard disk drive</b> | Store and recall instrument states, calibration data, and trace data on 10 GB, minimum, internal hard drive. Trace data can be saved in CSV (comma separated value) format. All files are MS-DOS® -compatible. Instrument states include all control settings, and memory trace data. |
| <b>File sharing</b>             | Internal hard disk drive (F:) can be accessed from an external Windows® PC through LAN.                                                                                                                                                                                               |
| <b>Disk drive</b>               | Instrument states, calibration data, and trace data can be stored on an internal 3.5 inch 1.4MB floppy disk in MS-DOS® -compatible format.                                                                                                                                            |
| <b>Screen hardcopy</b>          | Printouts of instrument data are directly produced on a printer.                                                                                                                                                                                                                      |

## System capabilities

|                                          |                                                                                                                                                                                                                               |
|------------------------------------------|-------------------------------------------------------------------------------------------------------------------------------------------------------------------------------------------------------------------------------|
| <b>Familiar graphical user interface</b> | The analyzer employs a graphical user interface based on Windows® operating system. There are three ways to operate the instrument manually: you can use a hardkey interface, a touch screen interface, or a mouse interface. |
| <b>Limit line</b>                        |                                                                                                                                                                                                                               |
| <b>Limit test</b>                        | Define the test limit that appear on the display for pass/fail testing. Defined limits may be any combination of horizontal/sloping lines and discrete data points.                                                           |

## Automation

|                                     |                                                                                                                                                                                                      |
|-------------------------------------|------------------------------------------------------------------------------------------------------------------------------------------------------------------------------------------------------|
| <b>Methods</b>                      |                                                                                                                                                                                                      |
| <b>Internal analyzer execution</b>  | Applications can be developed in a built-in VBA® (Visual Basic for Applications) language. Applications can be executed from within the analyzer via COM (component object model) or using SCPI.     |
| <b>Controlling via GPIB</b>         | The GPIB interface operates to IEEE 488.2 and SCPI protocols. The analyzer can be controlled by a GPIB external controller.<br>The analyzer can control external devices using a USB/GPIB interface. |
| <b>USB (USBTMC)</b>                 |                                                                                                                                                                                                      |
| <b>Controlling via USB (USBTMC)</b> | The USB interface operates to USBTMC and SCPI protocols. The analyzer can be controlled by an external PC using the USB interface with a USB cable.                                                  |
| <b>LAN</b>                          |                                                                                                                                                                                                      |
| <b>Standard conformity</b>          | 10 Base-T or 100 Base-TX (automatically switched), Ethertwist, RJ45 connector                                                                                                                        |
| <b>Protocol</b>                     | TCP/IP                                                                                                                                                                                               |
| <b>Function</b>                     | Telnet, SICL-LAN                                                                                                                                                                                     |

## Function differences between standard and option 011

| <b>Phase noise measurement</b>                     |                                                                                                                                                                                                                                                                                                                                                                                                                                                                              |
|----------------------------------------------------|------------------------------------------------------------------------------------------------------------------------------------------------------------------------------------------------------------------------------------------------------------------------------------------------------------------------------------------------------------------------------------------------------------------------------------------------------------------------------|
| <b>Offset frequency</b>                            | 1 Hz to 40 MHz (Standard)<br>10 M to 40 MHz (Option 011)                                                                                                                                                                                                                                                                                                                                                                                                                     |
| <b>IF Gain</b>                                     | 0, 10, 20, 30, 40, 50 dB (Standard)<br>0, 10, 20 dB (Option 011)                                                                                                                                                                                                                                                                                                                                                                                                             |
| <b>Enhanced phase noise sensitivity</b>            | Cross-Correlation method, Number of Correlation : 1 to 10000 (Standard)<br>Not available (Option 011)                                                                                                                                                                                                                                                                                                                                                                        |
| <b>SSB Phase Noise Sensitivity</b>                 | See Table 10-2 through Table 10-6                                                                                                                                                                                                                                                                                                                                                                                                                                            |
| <b>Frequency, RF power, DC current measurement</b> |                                                                                                                                                                                                                                                                                                                                                                                                                                                                              |
| <b>Measurement parameters (standard)</b>           | Analyzer mode: <sup>*1</sup><br>Frequency versus DC control voltage, dF/dVcontrol (Tuning sensitivity)<br>Frequency versus DC power voltage (Frequency pushing), dF/dVpower<br>RF power versus DC control voltage<br>RF power versus DC power voltage<br>DC current (at DC power port only) versus DC control voltage<br>DC current (at DC power port only) versus DC power voltage<br><br>Tester mode: <sup>*1</sup><br>Frequency, power, and DC current (at DC power port) |
| <b>Measurement parameters (Option 011)</b>         | Frequency, power, and DC current (at DC power port) (Numerical Display Only)                                                                                                                                                                                                                                                                                                                                                                                                 |

\*1. Refer to the chapter 4, “Frequency/power measurement in the frequency/power measurement mode” section for the difference between “Analyzer mode” and “Tester mode”

## System performance with E5053A Microwave Downconverter

The following provide the performances of the system in which the E5052A is connected to the E5053A microwave downconverter. All values are typical values. (23°C±5°C)

| <b>Test port</b>                                   |                                                                                                                                                                                                                                               |
|----------------------------------------------------|-----------------------------------------------------------------------------------------------------------------------------------------------------------------------------------------------------------------------------------------------|
| <b>Frequency Range</b>                             | 10 M to 3 GHz (E5052A SSA RF IN port)<br>3 G to 26.5 GHz (E5053A Microwave downconverter INPUT port)                                                                                                                                          |
| <b>Input level</b>                                 | -15 to +20 dBm (10 M to 3 GHz, E5052A RF IN port)<br>-30 to + 10 dBm (3 G to 10 GHz frequency band, E5053A Microwave downconverter INPUT port)<br>-20 to + 5 dBm (10 G to 26.5 GHz frequency band, E5053A Microwave downconverter INPUT port) |
| <b>Carrier search range*1</b>                      | -10 to +10 dBm (3 G to 10 GHz frequency band)<br>-10 to +5 dBm (9 G to 26.5 GHz frequency band)                                                                                                                                               |
| <b>Phase noise measurement</b>                     |                                                                                                                                                                                                                                               |
| <b>Frequency band</b>                              | 10 M to 3 GHz (E5052A SSA RF IN port)<br>3 G to 10 GHz or 9 G to 26.5 GHz (E5053A Microwave downconverter INPUT port)                                                                                                                         |
| <b>SSB phase noise sensitivity</b>                 | See Table 10-30, and Figure 10-9                                                                                                                                                                                                              |
| <b>Frequency tracking range</b>                    | 1.8 MHz (< 4.9 GHz, 3 G to 10 GHz band)<br>2.8 MHz (>= 4.9 GHz, 3 G to 10 GHz band)<br>1.3 MHz (< 10 GHz, 9 G to 26.5 GHz band)<br>2.6 MHz (>= 10 GHz, 9 G to 26.5 GHz band)                                                                  |
| <b>Transient measurement</b>                       |                                                                                                                                                                                                                                               |
| <b>Wide band measurement range</b>                 | 50 MHz to 3 GHz (E5052A SSA RF IN port)<br>500 MHz (E5053A Microwave downconverter INPUT port)                                                                                                                                                |
| <b>Narrow band measurement range</b>               | 3.125 kHz, 25 kHz, 200 kHz, 1.6 MHz, or 25.6 MHz                                                                                                                                                                                              |
| <b>RF power measurement accuracy</b>               | ±2 dB (10 M to 3 GHz)<br>±3 dB (3 G to 10 GHz)<br>±4 dB (9 G to 26.5 GHz)                                                                                                                                                                     |
| <b>Frequency, RF power, DC current measurement</b> |                                                                                                                                                                                                                                               |
| <b>Frequency measurement resolution</b>            | 10 Hz, 1 kHz, or 64 kHz                                                                                                                                                                                                                       |
| <b>RF power measurement accuracy</b>               | ±2 dB (10 M to 3 GHz)<br>±3 dB (3 G to 10 GHz)<br>±4 dB (9 G to 26.5 GHz)                                                                                                                                                                     |

| Spectrum monitor measurement |                                  |
|------------------------------|----------------------------------|
| Frequency span               | 15 MHz max                       |
| RBW                          | 1.53 Hz to 400 kHz, 1, 3, 5 step |
| Absolute level accuracy      | ±4 dB                            |

\*1. Carrier search function is applicable for the phase noise, frequency/power/DC current, and spectrum monitor functions when using the E5053A microwave downconverter INPUT port.

**Table 10-30 System phase noise sensitivity (with the E5053A downconverter, standard, 0 dBm input, correlation = 1, start offset frequency = 1 Hz, measurement time = 17.7 sec), typical**

| Input Frequency |      | Offset from carrier (Hz) |       |       |        |        |        |        |        |        |
|-----------------|------|--------------------------|-------|-------|--------|--------|--------|--------|--------|--------|
|                 |      | 1                        | 10    | 100   | 1 k    | 10 k   | 100 k  | 1 M    | 10 M   | 40 M   |
| 3 GHz           | typ. | -39.0                    | -78.7 | -99.5 | -124.4 | -135.3 | -137.5 | -153.5 | -164.5 | -167.6 |
| 10 GHz          | typ. | -34.6                    | -71.8 | -91.1 | -116.1 | -124.1 | -128.1 | -147.1 | -156.6 | -160.0 |
| 18 GHz          | typ. | -31.6                    | -66.5 | -85.3 | -110.3 | -121.2 | -125.3 | -141.3 | -150.7 | -154.2 |
| 26.5 GHz        | typ. | -29.0                    | -63.2 | -81.8 | -106.8 | -117.8 | -121.8 | -137.8 | -147.3 | -150.8 |

**Figure 10-9 SSB Phase Noise Sensitivity (with the E5053A downconverter, standard, 0 dBm input, correlation = 1, start offset frequency = 1 Hz, measurement time = 17.7 sec), typical**

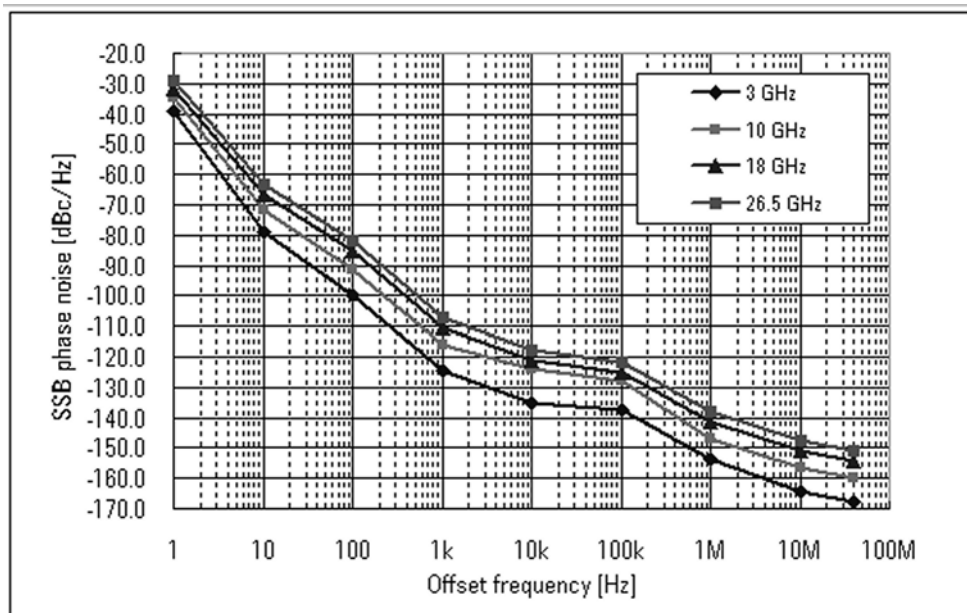

e5052auj401 6

---

## Clock jitter Analysis

Table 10-31

E5001A SSA-J Precision Clock Jitter Analysis Software

| Description               | Specification                                                                                                                                                                                                                                         |
|---------------------------|-------------------------------------------------------------------------------------------------------------------------------------------------------------------------------------------------------------------------------------------------------|
| Measurement parameters    | <ul style="list-style-type: none"><li>• Random jitter (RJ)</li><li>• Periodic jitter (PJ)<br/>PJ (p-p), PJ (<math>\delta</math>-<math>\delta</math>), PJ (rms)</li><li>• Jitter trend (TJ vs time)</li><li>• Total jitter (TJ)<br/>TJ (p-p)</li></ul> |
| Jitter spectrum bandwidth | 1 Hz to 40 MHz (Standard)<br>10 Hz to 40 MHz (Option 011)                                                                                                                                                                                             |

---

## **A** **Manual Changes**

This appendix contains the information required to adapt this manual to versions or configurations of the E5052A manufactured earlier than the current printing date of this manual. The information in this manual applies directly to E5052A units having the serial number printed on the title page of this manual.

---

## Manual Changes

To adapt this manual to your E5052A, refer to Table A-1 and Table A-2.

**Table A-1** Manual Changes by Serial Number

| Serial Prefix or Number | Make Manual Changes |
|-------------------------|---------------------|
| MY442 or later          | Change 4            |

**Table A-2** Manual Changes by Firmware Version

| Version          | Make Manual Changes |
|------------------|---------------------|
| A.01.10 or later | Change 1            |
| A.01.50 or later | Change 2            |
| A.02.00 or later | Change 3            |
| A.02.50 or later | Change 5            |

The ten-character serial number is stamped on the serial number plate (Figure A-1) on the rear panel.

**Figure A-1** Example of Serial Number Plate



e5052apj029



## Change 5

The following functions are newly integrated into the firmware version A.02.50 onward. They are not supported by firmware version A.02.00 or earlier.

- Allan variance and jitter calculation in phase noise measurement (PN)
- Addition of 20 MHz to the offset stop frequency in phase noise measurement (PN)
- Addition of 25 kHz and 3.125 kHz to the test frequency range of the narrow band in transient measurement (TR)
- Y-axis offset setting
- Function to make 0 degree reference variable when measuring phase in transient measurement (TR)
- Averaging trigger function
- Function to detect the end of measurement using the \*OPC? command (except for VBA)
- Function to invert display color of a LCD display and color setting
- The number of markers changed from six to ten
- Function to set the minimum value and maximum value of X-axis
- Annotation in the user window and function that frequency and signal level are copied to the user window when traces of the phase noise measurement are copied to the user window.
- Linearity evaluation of FM chirp signal
- Timing control of external trigger in transient measurement (TR)
- Function to have the 11970 external mixer which equals to or is more than 26.5 Ghz correspond to this instrument by VBA
- Clock jitter measurement by VBA (E5001A)
- Setting the minimum level for spurious judgement
- User recovery function \*1
- Expansion of the maximum number of display characters in the eco window up to 2000
- Expansion of the frequency offset setting range when using downconverter to 330 GHz, and the setting range of harmonic to 34

## Change 4

The equipment with prefix MY441 or earlier does not support the USB (USBTMC) interface port nor the removable hard disk function.

---

\*1. This function is available when the volume label on the C drive is CL250 or higher.

### Change 3

The following functions are newly integrated into the firmware version A.02.00 onward. They are not supported by firmware version A.01.50 or earlier.

- Support E5053A microwave downconverter
- Support external mixer
- User calibration function
- Frequency offset function
- Support USB (USBTMC) interface port
- When option 011 is installed, the IF gain setting by the PN measurement mode is changed from 10 dB fixation to 0, 10, and 20 dB selection.
- Eight digit display is added to the number of display digits of Y axes.
- Questionable Downconverter Status Register is added to the status register.

For the function addition of the above-mentioned, there is a case that becomes an initial value and a setting range different from a standard composition (when only the E5052A is used).

### Change 2

The following functions are newly integrated into the firmware version A.01.50 onward. They are not supported by firmware version A.01.10 or earlier.

- Limit test function
- Auto frequency control function
- X-axis labels
- User preset
- Copy function of measurement result to user window
- Recall function of state file from softkey
- Selectable trace layout in frequency/power measurement mode.
- Integrated phase noise, jitter and residual FM measurement in phase noise measurement
- Selectable quality level on phase noise measurement
- Display the progress of phase noise measurement
- Display spurious power value on phase noise measurement
- Moving function of harmonics to the center on spectrum monitor measurement
- Supporting  $\Delta$ Hz, % and ppm data formats on frequency measurement
- Supporting 200 kHz frequency range on transient measurement
- Offset adding function to phase reference frequency on transient measurement

## Change 1

The functions listed below are limited when option 011 is installed.

**Table A-3 Limited functions when option 011 is installed**

| Functions            | Limitations                                 |
|----------------------|---------------------------------------------|
| [PN] Start frequency | Minimum value is 10 Hz                      |
| [PN] Correlation     | Not Available (The value is fixed as 1)     |
| [PN] IF Gain         | Not Available (The value is fixed as 10 dB) |
| [FP] Trigger Mode    | Tester mode only                            |

The SCPI commands that related the limited functions above have also the limitations on the initial values and the range of parameters.

Manual Changes  
**Manual Changes**

---

## **B** Troubleshooting

This Chapter explains the steps to take in troubleshooting when your Agilent E5052A appears to be operating improperly. Explanations are also given for the error warning messages displayed on the screen.

## Troubleshooting

This section explains the steps you should take when you believe the Agilent E5052A is operating improperly. The results of these simple investigative procedures may help you avoid the down-time and inconvenience of repair service. The troubleshooting instructions are divided into three categories:

- ❑ “Troubleshooting during Startup” on page 352
- ❑ “Troubleshooting during Operation” on page 353
- ❑ “Troubleshooting for External Devices” on page 355

### Troubleshooting during Startup

#### The system does not start up

- Turning on (I) the standby switch does not start up the system.
  - Confirm that the power cable is properly plugged in.
  - Confirm that the line switch on the rear panel is turned on (○). For information on the line switch on the rear panel, see “7. Line Switch (Always ON)” on page 47.

When taking all of the above measures does not restore normal operation, there is a possibility of a device failure. Unplug the power cable immediately and contact Agilent Technologies’ Customer Contact given at the end of this guide or the company from which you bought the device.

#### The system starts up, but the normal measurement screen does not appear

- The system starts up, but it automatically shuts down immediately.
- The system starts up, but it enters the service mode (the instrument status bar in the lower right part of the screen displays **SVC** in red).
- The measurement screen appears after startup, but the date and time displayed on the instrument status bar in the lower right part of the screen differ greatly from the previous settings.
- The measurement screen appears after startup, but the power-on test fails with Error Message 200 appearing against a red background in the instrument message/warning area in the lower left part of the screen.
  - Execute system recovery. For information on the execution procedure, see “System Recovery” on page 296.

There is a possibility of a device failure. Contact Agilent Technologies’ Customer Contact given at the end of this guide or the company from which you bought the device.

---

#### NOTE

**Occasionally, a few pixels may appear on the screen as a fixed point of blue, green or red. Please note that this is not a failure and does not affect the performance of your product.**

---

## Troubleshooting during Operation

### The sweep action stops during measurement or is not executed

- The sweep action stops during measurement or is not executed, but the front keys and softkeys are operational.

There is a possibility of a device failure. Contact Agilent Technologies' Customer Contact given at the end of this guide or the company from which you bought the device.

### The error message “RF level overload” is displayed

- During measurement of the DUT, Error Messages 240 “RF level overload” on page 361 is displayed.  
 This error occurs when the input to the RF IN port exceeds the maximum input level in the measurement. The measurement value obtained in such a case is not correct. In the worst case, a failure (damage to the receiver) may occur.
  - Change the measurement condition so that the input to the RF IN port does not exceed the maximum input level.

When this message is displayed with nothing connected to the RF IN port, there is a possibility of a device failure. Contact Agilent Technologies' Customer Contact given at the end of this guide or the company from which you bought the device.

### A clearly abnormal measurement value

- The measurement value is not reproducible, or clearly abnormal.
  - Confirm that the DUT, connection cables, and other parts are connected correctly.
  - Confirm that the connectors and cables used to connect the DUT are free from damage or poor contact.

When taking all of these measures does not result in a correct measurement value, there is a possibility of a device failure. Contact Agilent Technologies' Customer Contact given at the end of this guide or the company from which you bought the device.

### The system cannot be operated manually (front panel keys, keyboard, touch screen and mouse)

- The keyboard or mouse becomes inoperable.
  - Confirm that the keyboard or mouse is connected correctly. When it is connected correctly, turn off the power and restart the system.
- The front panel key or keyboard becomes inoperable.
  - Using the mouse, turn **System – Mics Setup – Key Lock – Front Panel & Keyboard Lock OFF**.
- The touch screen becomes inoperable.
  - Using the front panel keys, turn **System – Mics Setup – Key Lock – Touch Screen & Mouse Lock OFF**.
  - Execute the calibration of the touch screen. For information on the execution procedure, see “Calibration of the Touch Screen” on page 306.
- The mouse becomes inoperable.

## Troubleshooting

### Troubleshooting

- Using the front panel keys, turn **System – Mics Setup – Key Lock – Touch Screen & Mouse Lock OFF**.
- All of the front panel keys, keyboard, and mouse become inoperable.
  - Confirm that the keyboard or mouse is connected correctly. When it is connected correctly, turn off the power and restart the system.
- The keyboard and mouse have been connected after power-on.
  - Turn off the power and restart the system.

When taking all of these measures does not recover operability, there is a possibility of a device failure. Contact Agilent Technologies' Customer Contact given at the end of this guide or the company from which you bought the device.

#### **The screen freezes and all operations become impossible**

- The measurement in progress or screen update is stalled and all of the front panel keys, keyboard, mouse, and touch screen are inoperable.
  - Press the standby switch to turn off the power and restart the system.

If a similar symptom reappears, there is a possibility of a device failure. Contact Agilent Technologies' Customer Contact given at the end of this guide or the company from which you bought the device.

#### **The System Freezes while in Operation.**

- The system freezes while in operation.
  - Press the standby switch to turn off the power and restart the system.

#### **The rear cooling fan does not operate**

There is a possibility of a device failure. Contact Agilent Technologies' Customer Contact given at the end of this guide or the company from which you bought the device.

#### **You cannot save a file in a floppy disk**

- You cannot save a file on a floppy disk.
  - Confirm that the floppy disk is initialized. If not, initialize it.
  - Confirm that the floppy disk is inserted correctly. Insert a floppy disk until the eject button pops up fully.
  - Confirm that the floppy disk is not write-protected. If it is, unprotect the disk.
  - Confirm that the floppy disk has free space. If it does not, delete unnecessary files or use a new floppy disk.

When taking all of these measures does not make it possible to save a file, there is a possibility of a device failure. Contact Agilent Technologies' Customer Contact given at the end of this guide or the company from which you bought the device.



### **You cannot read a file from a floppy disk**

- You cannot read a file from a floppy disk.
  - Confirm that the floppy disk is inserted correctly. Insert the floppy disk until the eject button pops up fully.
  - A stored file may be damaged by a magnetic field. Confirm that the file can be read on a PC.

When taking all of these measures does not make it possible to read the file, there is a possibility of a device failure. Contact Agilent Technologies' Customer Contact given at the end of this guide or the company from which you bought the device.

### **An error or warning message appears**

When an error or warning message is displayed on the instrument message/warning area in the lower part of the screen, refer to Error Messages on page 356 and Warning Messages on page 363.

## **Troubleshooting for External Devices**

### **Cannot Output to a Printer**

- Cannot output a measurement screen or data to a printer.
- Attempting to output to a printer causes Error Messages 40 and 41 on page 361 to appear.
  - Confirm that the power to the printer is on and that the power cable is connected correctly.
  - Confirm that the connector cable of the printer is connected correctly.
  - Confirm that the printer is online.
  - Confirm that the printer has not run out of paper.
  - Confirm that the printer has not run out of ink.

When taking all of these measures does not result in printer output, there is a possibility of a device failure. Contact Agilent Technologies' Customer Contact given at the end of this guide or the company from which you bought the device.

### **GPIB does not respond to an external controller/fails to function normally**

- A GPIB device does not respond to the external controller or fails to function normally.
  - Confirm that the GPIB address is defined correctly.
  - Confirm that the GPIB cable is connected.
  - Confirm that another instrument connected by the GPIB cable has the same GPIB address.
  - Confirm that the GPIB cable connection forms a loop.

When taking all of these measures does not result in correct operation of the GPIB device, there is a possibility of a device failure. Contact Agilent Technologies' Customer Contact given at the end of this guide or the company from which you bought the device.

## Error Messages

An error message is displayed against a red background in the instrument message/warning area in the lower-left part of the screen. Touching **Entry Off** key at the front panel or executing the **:DISPlay:MESSage:CLEar** command clears the error message.

Moreover, about a specific error message, when a sweep is started again, the display of an error message may disappear. Errors caused by operation of a front panel key simply appear on the display; with a few exceptions, these are not stored in the error queue.

The log of an error message, a maximum of 100 pieces are recorded, and it can go back and check from the newest error. The following procedures perform the procedure of elimination of an error check and an error log. This operation can be performed only from a front panel. It cannot be operated by the "SCPI" command.

**[System]** - **Error Log - View Error Log**

**[System]** - **Error Log - Clear Error Log**

An error with a positive error number is one uniquely defined for this instrument. On the other hand, an error with a negative error number is basically one defined for common GPIB devices in IEEE488.2

### A

120

#### AFC Failed

This error message appears when the Automatic frequency control function could not follow the fluctuation in the measurement condition or automatic frequency control function was set on, however, the power or control voltage is not being applied to the DUT. For the corrective actions, refer to the error message "AFC out of loop" and the warning message "DC output on required in AFC".

330

#### AFC out of loop

The Automatic frequency control function could not follow the fluctuation in the measurement condition, and did not converge on the target frequency. Possible problems and corrective action are shown below.

- Press **[DC Control]** - **Auto Freq Control - Sensitivity** to specify a proper tuning sensitivity.
- Press **[DC Control]** - **Auto Freq Control - Max Iteration** to specify a value larger than the current setting.
- Press **[DC Control]** - **Auto Freq Control - Max Ctrl Voltage Limit** to specify a maximum value larger than the current setting. Be careful not to set a value that exceeds the DUT's maximum acceptable value.
- Press **[DC Control]** - **DC control Delay** to specify a value larger than the current setting.

51

#### A21 flash ROM write error

This error occurs when writing the system calibration data to ROM on the A21 board fails. Contact Agilent Technologies' Customer Contact given at the end of this guide or the company from which you bought the device.

## D

- 222      **Data out of range**
- A data element (not violating the standard) outside the range defined by this instrument has been received. This error occurs, for example, when an integer-based command for which the parameter can be rounded exceeds the range of -65536 to +65536 or when a real-number-based command for which the parameter can be rounded exceeds the range of -9.9e37 to +9.9e37.
- 280      **DC control overload**
- The current through the DC CONTROL connector is too large.
- 270      **DC power overload**
- The current through the DC POWER connector is too large.
- 373      **Downconverter Fan Stop**
- This error occurs when the fan of the downconverter stops. Contact Agilent Technologies' Customer Contact given at the end of this guide or the company from which you bought the device.
- 354      **Downconverter IF not found**
- This error occurs when the down-converted signal does not fall into the expected IF range. The deviation between the set nominal frequency and the actual input signal's frequency may be too large. Execute the carrier search function, and set a correct nominal frequency.
- 352      **Downconverter Oven Cold**
- This error may occur due to the unlocked PLL because the oven is not heated sufficiently for some time after the downconverter is turned on. Heat the oven for some time with the power on.
- 374      **Downconverter P5V power fail**
- This error occurs when the 5-V power of the downconverter fails. A device failure is suspected. Contact Agilent Technologies' Customer Contact given at the end of this guide or the company from which you bought the device.
- 353      **Downconverter Ref Input Level Low**
- This error occurs when the level of the 10-MHz reference signal to the downconverter is low.
- 372      **Downconverter Ref PLL unlocked**
- This error occurs when the PLL circuit of the downconverter is unlocked during measurement. This error may occur when the carrier frequency of the measurement sample is unstable.
- It may occur also due to the same reason as "Downconverter Oven Cold."
- 375      **Downconverter test failed**
- This error occurs when the self-test of the downconverter fails. A device failure is suspected. Contact Agilent Technologies' Customer Contact given at the end of this guide or the company from which you bought the device.
- 371      **Downconverter Unlock local**
- This error occurs when the local of the downconverter cannot be locked. A device failure is

suspected. Contact Agilent Technologies' Customer Contact given at the end of this guide or the company from which you bought the device.

## E

-200

### Execution error

An error associated with execution has been generated for which this instrument cannot specify the error message. This code shows the occurrence of an error associated with execution, as defined in 11.5.1.1.5, IEEE488.2.

## F

72

### Failed to copy file

This error occurs when copying a file (MMEM:COPY command) fails.

74

### Failed to create directory

This error occurs when creating a directory (MMEM:MDIR command) fails.

73

### Failed to delete file

This error occurs when deleting a file (MMEM:DEL command) fails.

91

### Failed to execute user defined key

In the user menu function, this error occurs when a disabled softkey is executed.

61

### Failed to hide trace

In the user window, this error occurs when the show trace "OFF" command is executed to turn off the remaining trace on the window. At least one trace should be visible at all times.

60

### Failed to hide window

This error occurs when the show window "OFF" command is executed to turn off the remaining window on the screen. At least one window should be visible at all times.

70

### Failed to read file

This error occurs when a VBA project file (MMEM:LOAD:PROG command) or other type of file cannot be read normally.

90

### Failed to stop program

This error occurs when stopping a program fails.

71

### Failed to write file

This error occurs when the display image (MMEM:STOR:IMAG command) for the LCD screen, a VBA project file (MMEM:STOR:PROG command) or other type of file cannot be written normally.

-257

### File name error

A file name error. This message appears when an error exists in the file name and thus a command is not executed correctly. This error occurs, for example, when you try to copy to an improper file name.

-256

### File name not found

The file name specified is not found and thus the command is not executed correctly. This error occurs, for example, when you try to read a file that does not exist in a disk or a disk

|      |                                                                                                                                                                                                                                                                                                                                                                                                                                                                                                                                                                                                                                                                                                                                                                                                                         |
|------|-------------------------------------------------------------------------------------------------------------------------------------------------------------------------------------------------------------------------------------------------------------------------------------------------------------------------------------------------------------------------------------------------------------------------------------------------------------------------------------------------------------------------------------------------------------------------------------------------------------------------------------------------------------------------------------------------------------------------------------------------------------------------------------------------------------------------|
|      | is not correctly inserted into the drive.                                                                                                                                                                                                                                                                                                                                                                                                                                                                                                                                                                                                                                                                                                                                                                               |
| 80   | <p><b>File transfer failed</b></p> <p>This error occurs when writing data into or reading data from a file (MMEM:DATA command) fails.</p>                                                                                                                                                                                                                                                                                                                                                                                                                                                                                                                                                                                                                                                                               |
|      | <b>I</b>                                                                                                                                                                                                                                                                                                                                                                                                                                                                                                                                                                                                                                                                                                                                                                                                                |
| 213  | <p><b>IF A/D overflow</b></p> <p>This message appears when the internal IF level is too high and it exceeds the internal A/D converter input range. In the phase noise measurement, check that the DUT's carrier signal is within the selected frequency band. Also, the message may appear if a DUT that has a large noise level and an unstable output level is measured. When measuring phase noise in such a case, decrease the IF Gain value or increase the sweep start value if possible. In the spectrum monitor measurement, decrease the DUT's carrier level, or set the reference level or input attenuator value larger than the current setting. In the transient measurement, decrease the DUT's carrier level, or set the max input level or input attenuator value larger than the current setting.</p> |
| 260  | <p><b>IF Level Overload</b></p> <p>The IF level is too high. Set the input attenuator value larger than the current setting.</p>                                                                                                                                                                                                                                                                                                                                                                                                                                                                                                                                                                                                                                                                                        |
| 312  | <p><b>IF not found</b></p> <p>The IF signal cannot be found. In the phase noise measurement, this error occurs when no signal is inputted to the RF IN, or the input level to the RF IN is too low. Also, the message may appear if a DUT that has an unstable output level is measured, or if the carrier frequency of a DUT is out of the specified frequency band. Aside from the above reasons, there is the possibility of a device failure. Contact an Agilent Technologies sales office or the company from which you bought the device.</p>                                                                                                                                                                                                                                                                     |
| -224 | <p><b>Illegal parameter value</b></p> <p>The parameter value is improperly set.</p>                                                                                                                                                                                                                                                                                                                                                                                                                                                                                                                                                                                                                                                                                                                                     |
| -282 | <p><b>Illegal program name</b></p> <p>This error occurs when a nonexistent VBA program name is specified by the PROG:SEL:NAME command.</p>                                                                                                                                                                                                                                                                                                                                                                                                                                                                                                                                                                                                                                                                              |
| -213 | <p><b>Init ignored</b></p> <p>Because another measurement is in progress, the request for initiating a measurement ("INIT" command) is ignored.</p>                                                                                                                                                                                                                                                                                                                                                                                                                                                                                                                                                                                                                                                                     |
| 250  | <p><b>Insufficient IF Level</b></p> <p>The IF level is too low. Set the input attenuator value smaller than the current setting.</p>                                                                                                                                                                                                                                                                                                                                                                                                                                                                                                                                                                                                                                                                                    |
| 230  | <p><b>Insufficient RF Level</b></p> <p>The input level to the RF IN connector is too low.</p>                                                                                                                                                                                                                                                                                                                                                                                                                                                                                                                                                                                                                                                                                                                           |
|      | <b>L</b>                                                                                                                                                                                                                                                                                                                                                                                                                                                                                                                                                                                                                                                                                                                                                                                                                |
| 101  | <p><b>License installation failed</b></p> <p>This error occurs when an invalid license code is input during installation of the E5001</p>                                                                                                                                                                                                                                                                                                                                                                                                                                                                                                                                                                                                                                                                               |

SSA-J license.

77

**Load VBA program failed**

This error occurs when loading a VBA program file fails.

**M**

20

**Marker search failed**

This error occurs when marker search fails.

-109

**Missing parameter**

The number of parameters is less than that required for the command, or the parameter has not been entered.

**N**

351

**No downconverter unit connected**

This error occurs when the downconverter is not turned on or when the USB (USBTMC) cable is not connected even though the downconverter is enabled. Disable the downconverter, turn on the downconverter, or connect the USB (USBTMC) cable.

111

**No signal found**

This error message appears when a carrier is outside the selected frequency band or the attenuator is improperly set during execution of the **Carrier to** function. Set the attenuator to 0 in case you measure a DUT whose output is less than - 15 dBm.

**O**

100

**Option not installed**

The command received has been ignored because of the mismatch between the contents of an option for this instrument and the command.

This error is not generated by front key operations.

**P**

-220

**Parameter error**

When a parameter-related error other than Errors -221 through -229 occurs, that error is displayed.

-108

**Parameter not allowed**

The number of parameters exceeds that required for the command.

See the command reference to confirm the required number of parameters.

210

**Phase lock loop unlocked**

This error occurs when the PLL circuit of the instrument becomes unlocked while the measurement is in progress. This message may appear if the DUT's carrier signal is unstable. If this message is displayed in the phase noise measurement, the following problems and corrective actions are shown below.

- The DUT's noise level is too large, or a large level spurious component exists in the

|      |                                                                                                                                                                                                                                                                                                                                                                    |
|------|--------------------------------------------------------------------------------------------------------------------------------------------------------------------------------------------------------------------------------------------------------------------------------------------------------------------------------------------------------------------|
|      | measurement range.                                                                                                                                                                                                                                                                                                                                                 |
|      | Verify the spectrum of the DUT's output signal.                                                                                                                                                                                                                                                                                                                    |
|      | Decrease the IF Gain value, or increase the sweep start value when possible.                                                                                                                                                                                                                                                                                       |
|      | <ul style="list-style-type: none"> <li>• The DUT's output signal is being modulated in frequency.<br/>Stop the frequency modulation.</li> <li>• A large harmonics component is included in the DUT's output signal.<br/>Insert a low-pass filter between the DUT's output terminal and the E5052A RF IN connector to eliminate the harmonics component.</li> </ul> |
| 211  | <b>PLL frequency range over</b>                                                                                                                                                                                                                                                                                                                                    |
|      | This error occurs when the internal PLL circuit becomes unlocked while the measurement is in progress. This error may occur when the frequency of the input signal is out of range.                                                                                                                                                                                |
| 212  | <b>PLL Input overflow</b>                                                                                                                                                                                                                                                                                                                                          |
|      | This error occurs when the internal PLL circuit becomes unlocked while the measurement is in progress. This error may occur when the level of the input signal is too large.                                                                                                                                                                                       |
| 200  | <b>Power on test failed</b>                                                                                                                                                                                                                                                                                                                                        |
|      | This error occurs when the power-on test fails, indicating a failure of the instrument. Contact an Agilent Technologies sales office or the company from which you bought the instrument.                                                                                                                                                                          |
| 40   | <b>Printer error</b>                                                                                                                                                                                                                                                                                                                                               |
|      | This error occurs when the previous printing is still in progress or the printer fails (offline, short of paper, etc.) at the time of outputting the display image on the LCD screen to the printer (HCOP:IMM command).                                                                                                                                            |
| 41   | <b>Print failed</b>                                                                                                                                                                                                                                                                                                                                                |
|      | This error occurs when printing fails for reasons other than Error 40, Printer error.                                                                                                                                                                                                                                                                              |
| -284 | <b>Program currently running</b>                                                                                                                                                                                                                                                                                                                                   |
|      | This error occurs when the PROG:SEL:STAT RUN command is executed when the VBA program is in the Run state.                                                                                                                                                                                                                                                         |
| -286 | <b>Program runtime error</b>                                                                                                                                                                                                                                                                                                                                       |
|      | An error occurring when VBA is executed.                                                                                                                                                                                                                                                                                                                           |
|      | <b>R</b>                                                                                                                                                                                                                                                                                                                                                           |
| 75   | <b>Recall failed</b>                                                                                                                                                                                                                                                                                                                                               |
|      | This error occurs when reading an instrument status file (State01.sta, etc.) (MMEM:LOAD:STAT command) fails.                                                                                                                                                                                                                                                       |
| 220  | <b>RF freq out of range</b>                                                                                                                                                                                                                                                                                                                                        |
|      | This error occurs when the DUT's output frequency is not within the measurement range.                                                                                                                                                                                                                                                                             |
| 240  | <b>RF level overload</b>                                                                                                                                                                                                                                                                                                                                           |
|      | This error occurs when the input to the RF IN port exceeds the maximum input level in the measurement. The measurement value obtained in such a case is not correct. In the worst                                                                                                                                                                                  |

case, a failure (damage to the receiver) may occur.

## S

76

### Save failed

This error occurs when writing an instrument status file (State01.sta, etc.) (MMEM:STOR:STAT command) fails.

78

### Save VBA program failed

This error occurs when saving a VBA program file fails.

-310

### System error

One of the errors designated as “system errors” in this instrument has occurred.

## T

110

### Target freq out of range

This error indicates the 2nd, 3rd, or nth order harmonics is not within the E5052A measurement range. At this time, the previous measurement conditions still remain (any of sweep parameters are not changed).

-223

### Too much data

The block-, expression-, or character-string-type program data that have been received conform with the standard but exceed the amount that can be processed under the conditions of the memory or conditions specific to memory-related devices. In this instrument, this error occurs when the number of characters exceeds 254 in a character-string parameter.

-211

### Trigger ignored

This instrument receives and detects a trigger command (“TRIG”) or an external trigger signal, but it is ignored due to the timing conditions (the instrument is not in the wait-for-trigger state, for example). Change the setup so that a trigger command or an external trigger signal can be sent after the instrument has entered the wait-for-trigger state.

## U

-113

### Undefined header

A command not defined in this instrument, although not illegal in the syntactic structure, has been received. See the command reference and use correct commands.

311

### Unlock local

This error occurs when the internal Local signal of the instrument cannot be unlocked. There is the possibility of a device failure. Contact an Agilent Technologies sales office or the company from which you bought the device.



## Warning Message

A warning message is displayed in the instrument message/Warning area in the lower-left part of the display against a gray background. Touching **Entry Off** key at the front panel executing the **:DISPlay:MESSage:CLEAr** command clears the message. Moreover, about a specific warning message, when a sweep is started again, a warning message may disappear.

This message simply appears on the display, since it is not known to remote environments such as a GPIB. This message is not displayed when another error message (against a red background) has already been displayed in the instrument message/Warning area.

The warning messages for this instrument are as follows:

571

### **DC control out of limit**

This message occurs when the specified DC control voltage or the sweep start/stop DC control voltage for the frequency & power measurement is out of the maximum/minimum allowed voltage of DC control.

580

### **DC control output on required in AFC**

The automatic frequency control function was set on, however, the power or control voltage is not being applied to the DUT. Verify that the control voltage output is set to ON.

570

### **DC power out of limit**

This message occurs when the specified DC power voltage or the sweep start/stop DC power voltage for the frequency & power measurement is out of the maximum/minimum allowance voltage of DC control.

560

### **Incompatible recall file**

This message occurs when an incompatible file is read.

550

### **Marker tracking failed**

This message occurs when marker tracking fails.

503

### **Set RF ATT 0dB**

This message occurs when the input attenuator is set improperly. Set the input attenuator to 0 dB.

504

### **Set RF ATT 5dB**

This message occurs when the input attenuator is set improperly. Set the input attenuator to 5 dB.

505

### **Set RF ATT 10dB**

This message occurs when the input attenuator is set improperly. Set the input attenuator to 10 dB.

506

### **Set RF ATT 15dB**

This message occurs when the input attenuator is set improperly. Set the input attenuator to 15 dB.

507

### **Set RF ATT 20dB**

This message occurs when the input attenuator is set improperly. Set the input attenuator to

Troubleshooting  
**Warning Message**

20 dB.

508

**Set RF ATT 25dB**

This message occurs when the input attenuator is set improperly. Set the input attenuator to 25 dB.

510

**Set RF ATT 30dB**

This message occurs when the input attenuator is set improperly. Set the input attenuator to 30 dB.

511

**Set RF ATT 35dB**

This message occurs when the input attenuator is set improperly. Set the input attenuator to 35 dB.

---

## **C** List of Default Values

This appendix gives the default values, settings for Save/Recall of an object, and settings for backing up an object when using the Agilent E5052A.

## List of Default Values, Save/Recall Settings, and Backup Settings

The table below shows the following settings for the Agilent E5052A.

- Factory-shipped settings
- Settings valid when you press **Preset** - **Factory** key (Or when you execute the **:SYST:PRES** command)

---

### NOTE

Pressing **Preset** - **User** recalls the Autorec.sta in the F drive.

- Settings valid when you execute the **\*RST** command
- Settings that permit Save/Recall of a setup state

In the table, states that can be saved/recalled are denoted in the following manner:

\* : Save/Recall can be performed

Blank: Save/Recall cannot be performed

- Settings that are backed up (set state not affected by turning power ON/OFF)

In the table, a setting that is automatically backed up is denoted in the following manner:

\* : Backup operation performed

Blank: Backup operation not performed

- Available means of defining a setting

In the table, the following symbols are used to denote the method(s) that can be used to define a setting.

K: Using the front panel key (including the mouse and keyboard)

C: Using the SCPI command or COM object

---

### NOTE

In the table, the “<<” symbol shows that the setup is the same as that in the box to the left.

## FP Menu

| Key Operation             | Factory-shipped Setting                                                             | Default Value |      | Save / Recall | Backup | Avaible Means of Defining a Setting |
|---------------------------|-------------------------------------------------------------------------------------|---------------|------|---------------|--------|-------------------------------------|
|                           |                                                                                     | Preset        | *RST |               |        |                                     |
| <b>Attenuator</b>         |                                                                                     |               |      |               |        |                                     |
| Input Attenuator          | 5 dB                                                                                | <<            | <<   | *             |        | K/C                                 |
| <b>Average</b>            |                                                                                     |               |      |               |        |                                     |
| Averaging                 | OFF                                                                                 | <<            | <<   | *             |        | K/C                                 |
| Averaging Restart         |                                                                                     |               |      |               |        | K/C                                 |
| Avg Factor                | 16                                                                                  | <<            | <<   | *             |        | K/C                                 |
| <b>DC Control Voltage</b> |                                                                                     |               |      |               |        |                                     |
| <b>Auto Freq Control</b>  |                                                                                     |               |      |               |        |                                     |
| AFC Status                | OFF                                                                                 | <<            | <<   | *             |        | K/C                                 |
| Frequency Band            | 300 M - 7 GHz                                                                       | <<            | <<   | *             |        | K/C                                 |
| Max Ctrl Voltage Limit    | 35 V                                                                                | <<            | <<   | *             |        | K/C                                 |
| Max Input Level           | 0 dBm                                                                               | <<            | <<   | *             |        | K/C                                 |
| Max Iteration             | 10                                                                                  | <<            | <<   | *             |        | K/C                                 |
| Min Ctrl Voltage Limit    | -15 V                                                                               | <<            | <<   | *             |        | K/C                                 |
| Sensitivity               | 10 MHz/V                                                                            | <<            | <<   | *             |        | K/C                                 |
| Target                    | 1 GHz                                                                               | <<            | <<   | *             |        | K/C                                 |
| Tolerance                 | 1 kHz                                                                               | <<            | <<   | *             |        | K/C                                 |
| Control Voltage Cal       | OFF                                                                                 | <<            | <<   |               |        | K/C                                 |
| DC Control Delay          | 100 ms                                                                              | <<            | <<   | *             |        | K/C                                 |
| DC Control Output         | OFF                                                                                 | <<            | <<   |               |        | K/C                                 |
| DC Control Voltage        | 0 V                                                                                 | <<            | <<   | *             |        | K/C                                 |
| Max Ctrl Voltage Limit    | 35 V                                                                                | <<            | <<   | *             |        | K/C                                 |
| Min Ctrl Voltage Limit    | -15 V                                                                               | <<            | <<   | *             |        | K/C                                 |
| <b>DC Power Voltage</b>   |                                                                                     |               |      |               |        |                                     |
| DC Power Delay            | 100 ms                                                                              | <<            | <<   | *             |        | K/C                                 |
| DC Power Output           | OFF                                                                                 | <<            | <<   |               |        | K/C                                 |
| DC Power Voltage          | 0 V                                                                                 | <<            | <<   | *             |        | K/C                                 |
| Max Pwr Voltage Limit     | 16 V                                                                                | <<            | <<   | *             |        | K/C                                 |
| Min Pwr Voltage Limit     | 0 V                                                                                 | <<            | <<   | *             |        | K/C                                 |
| <b>Display</b>            |                                                                                     |               |      |               |        |                                     |
| Allocate                  |  | <<            | <<   | *             |        | K/C                                 |
| Edit Title Label          | ""                                                                                  | <<            | <<   | *             |        | K/C                                 |
| Color Type                | "Normal"                                                                            | <<            | <<   | *             |        | K/C                                 |

List of Default Values  
FP Menu

| Key Operation               | Factory-shipped Setting | Default Value |      | Save / Recall | Backup | Available Means of Defining a Setting |
|-----------------------------|-------------------------|---------------|------|---------------|--------|---------------------------------------|
|                             |                         | Preset        | *RST |               |        |                                       |
| <b>Limit Test</b>           |                         |               |      |               |        |                                       |
| Delete Lower Limit Line     |                         |               |      |               |        | K/C                                   |
| Delete Upper Limit Line     |                         |               |      |               |        | K/C                                   |
| Fail Sign                   | ON                      | <<            | <<   | *             |        | K/C                                   |
| Import Lower Limit Line ... |                         |               |      |               |        | K/C                                   |
| Import Upper Limit Line ... |                         |               |      |               |        | K/C                                   |
| Limit Line                  | ON                      | <<            | <<   | *             |        | K/C                                   |
| Limit Test                  | OFF                     | <<            | <<   | *             |        | K/C                                   |
| <b>Marker Information</b>   | Left                    | <<            | <<   | *             |        | K/C                                   |
| <b>Meas Condition</b>       | ON                      | <<            | <<   | *             |        | K/C                                   |
| <b>Relative Y-Scale</b>     | OFF                     | <<            | <<   | *             |        | K/C                                   |
| <b>Security Level</b>       | None                    | <<            | <<   | *             |        | K/C                                   |
| <b>Title Label</b>          | OFF                     | <<            | <<   | *             |        | K/C                                   |
| <b>Update</b>               | ON                      | <<            | <<   | *             |        | K/C                                   |
| <b>Y # of Digits</b>        | 4-digits                | <<            | <<   | *             |        | K/C                                   |
| <b>Format</b>               |                         |               |      |               |        |                                       |
| Frequency Format            | Hz                      | <<            | <<   | *             |        | K/C                                   |
| Frequency Reference         | 0 Hz                    | <<            | <<   | *             |        | K/C                                   |
| Sensitivity Aperture        | 1 %                     | <<            | <<   | *             |        | K/C                                   |
| <b>Input Port</b>           |                         |               |      |               |        |                                       |
| Down Converter              |                         |               |      |               |        |                                       |
| Down Converter              | OFF                     | <<            | <<   | *             |        | K/C                                   |
| External Mixer              | Not Used                | <<            | <<   | *             |        | K/C                                   |
| RF Input                    | Down Converter          | <<            | <<   | *             |        | K/C                                   |
| <b>Macro Setup</b>          |                         |               |      |               |        |                                       |
| E5052 Event                 | OFF                     |               |      |               |        | K/C                                   |
| Echo Window Menu            |                         |               |      |               |        |                                       |
| Clear Echo                  |                         |               |      |               |        | K/C                                   |
| Echo Font Size              | 11                      |               |      |               |        | K/C                                   |
| Echo Window                 | OFF                     |               |      |               |        | K/C                                   |
| User Menu                   |                         |               |      |               |        |                                       |
| User Label 1                |                         |               |      |               |        | K/C                                   |
| <b>Marker</b>               |                         |               |      |               |        |                                       |
| Clear Marker Menu           |                         |               |      |               |        |                                       |
| Marker 1                    | OFF                     | <<            | <<   | *             |        | K/C                                   |
| Couple                      | OFF                     | <<            | <<   | *             |        | K/C                                   |
| Marker List                 | OFF                     | <<            | <<   | *             |        | K/C                                   |

| Key Operation          | Factory-shipped Setting | Default Value |      | Save / Recall | Backup | Available Means of Defining a Setting |
|------------------------|-------------------------|---------------|------|---------------|--------|---------------------------------------|
|                        |                         | Preset        | *RST |               |        |                                       |
| <b>More Functions</b>  |                         |               |      |               |        |                                       |
| Discrete               | OFF                     | <<            | <<   | *             |        | K/C                                   |
| Ref Marker             | 1                       | <<            | <<   | *             |        | K/C                                   |
| Ref Marker Mode        | OFF                     | <<            | <<   | *             |        | K/C                                   |
| <b>Marker Function</b> |                         |               |      |               |        |                                       |
| Analysis Range (X)     | Band Marker             | <<            | <<   | *             |        | K/C                                   |
| Analysis Range (Y)     | Band Marker             | <<            | <<   | *             |        | K/C                                   |
| Analysis Type          | Off                     | <<            | <<   | *             |        | K/C                                   |
| <b>Band Marker X</b>   |                         |               |      |               |        |                                       |
| Band Marker X          | OFF                     | <<            | <<   | *             |        | K/C                                   |
| Center                 | 0 V                     |               |      |               |        | K/C                                   |
| Span                   | 2 TV                    |               |      |               |        | K/C                                   |
| Start                  | -1 TV                   | <<            | <<   | *             |        | K/C                                   |
| Stop                   | 1 TV                    | <<            | <<   | *             |        | K/C                                   |
| <b>Band Marker Y</b>   |                         |               |      |               |        |                                       |
| Band Marker Y          | OFF                     | <<            | <<   | *             |        | K/C                                   |
| Center                 | 0 Hz                    |               |      |               |        | K/C                                   |
| Span                   | 2 THz                   |               |      |               |        | K/C                                   |
| Start                  | -1 THz                  | <<            | <<   | *             |        | K/C                                   |
| Stop                   | 1 THz                   | <<            | <<   | *             |        | K/C                                   |
| Couple                 | OFF                     | <<            | <<   | *             |        | K/C                                   |
| <b>Marker Search</b>   |                         |               |      |               |        |                                       |
| <b>Band Marker X</b>   |                         |               |      |               |        |                                       |
| Band Marker X          | OFF                     | <<            | <<   | *             |        | K/C                                   |
| Center                 | 0 V                     |               |      |               |        | K/C                                   |
| Span                   | 2 TV                    |               |      |               |        | K/C                                   |
| Start                  | -1 TV                   | <<            | <<   | *             |        | K/C                                   |
| Stop                   | 1 TV                    | <<            | <<   | *             |        | K/C                                   |
| <b>Band Marker Y</b>   |                         |               |      |               |        |                                       |
| Band Marker Y          | OFF                     | <<            | <<   | *             |        | K/C                                   |
| Center                 | 0 Hz                    |               |      |               |        | K/C                                   |
| Span                   | 2 THz                   |               |      |               |        | K/C                                   |
| Start                  | -1 THz                  | <<            | <<   | *             |        | K/C                                   |
| Stop                   | 1 THz                   | <<            | <<   | *             |        | K/C                                   |
| Couple                 | OFF                     | <<            | <<   | *             |        | K/C                                   |
| <b>Peak</b>            |                         |               |      |               |        |                                       |
| Peak Excursion         | 0 Hz                    | <<            | <<   | *             |        | K/C                                   |
| Peak Polarity          | Positive                | <<            | <<   | *             |        | K/C                                   |
| Search Left            |                         |               |      |               |        | K/C                                   |
| Search Peak            |                         |               |      |               |        | K/C                                   |
| Search Peak All        |                         |               |      |               |        | K/C                                   |
| Search Right           |                         |               |      |               |        | K/C                                   |

C. List of Default Values

List of Default Values  
FP Menu

| Key Operation           | Factory-shipped Setting | Default Value |      | Save / Recall | Backup | Available Means of Defining a Setting |
|-------------------------|-------------------------|---------------|------|---------------|--------|---------------------------------------|
|                         |                         | Preset        | *RST |               |        |                                       |
| Search Max              |                         |               |      |               |        | K/C                                   |
| Search Min              |                         |               |      |               |        | K/C                                   |
| Search Range (X)        | Full Range              | <<            | <<   | *             |        | K/C                                   |
| Search Range (Y)        | Full Range              | <<            | <<   | *             |        | K/C                                   |
| Target                  |                         |               |      |               |        |                                       |
| Search Left             |                         |               |      |               |        | K/C                                   |
| Search Right            |                         |               |      |               |        | K/C                                   |
| Search Target           |                         |               |      |               |        | K/C                                   |
| Search Transition       | Both                    | <<            | <<   | *             |        | K/C                                   |
| Search Value            | 0 Hz                    | <<            | <<   | *             |        | K/C                                   |
| Tracking                | Off                     | <<            | <<   | *             |        | K/C                                   |
| <b>Measurement View</b> |                         |               |      |               |        |                                       |
| Freq & Power            | Selected Phase Noise    | <<            | <<   | *             |        | K/C                                   |
| Phase Noise             | Selected Phase Noise    | <<            | <<   | *             |        | K/C                                   |
| Show Window             |                         |               |      |               |        |                                       |
| Freq & Power            | ON                      | <<            | <<   | *             |        | K/C                                   |
| Phase Noise             | ON                      | <<            | <<   | *             |        | K/C                                   |
| Spectrum Monitor        | ON                      | <<            | <<   | *             |        | K/C                                   |
| Transient               | ON                      | <<            | <<   | *             |        | K/C                                   |
| User                    | OFF                     | <<            | <<   | *             |        | K/C                                   |
| Spectrum Monitor        | Selected Phase Noise    | <<            | <<   | *             |        | K/C                                   |
| Transient               | Selected Phase Noise    | <<            | <<   | *             |        | K/C                                   |
| User                    | Selected Phase Noise    | <<            | <<   | *             |        | K/C                                   |
| <b>Save/Recall</b>      |                         |               |      |               |        |                                       |
| Save State              |                         |               |      |               |        |                                       |
| Save Type               | State Only              |               |      |               |        | K/C                                   |
| <b>Scale</b>            |                         |               |      |               |        |                                       |
| Auto Scale              |                         |               |      |               |        | K/C                                   |
| Auto Scale All          |                         |               |      |               |        | K/C                                   |
| Divisions               | 10                      | <<            | <<   | *             |        | K/C                                   |
| Marker -> Reference     |                         |               |      |               |        | K/C                                   |
| Reference Position      | 5 Div                   | <<            | <<   | *             |        | K/C                                   |
| Reference Value         | 1.5 GHz                 | <<            | <<   | *             |        | K/C                                   |
| Scale/Div               | 100 MHz/Div             | <<            | <<   | *             |        | K/C                                   |
| X Axis                  |                         |               |      |               |        |                                       |
| Auto                    | ON                      | <<            | <<   | *             |        | K/C                                   |
| Band Marker -> X Axis   |                         |               |      |               |        | K/C                                   |
| Left                    | 0 V                     | <<            | <<   | *             |        | K/C                                   |
| Right                   | 100 uV                  | <<            | <<   | *             |        | K/C                                   |



| Key Operation                 | Factory-shipped Setting | Default Value |      | Save / Recall | Backup | Avaible Means of Defining a Setting |
|-------------------------------|-------------------------|---------------|------|---------------|--------|-------------------------------------|
|                               |                         | Preset        | *RST |               |        |                                     |
| <b>Setup</b>                  |                         |               |      |               |        |                                     |
| Carrier Search                |                         |               |      |               |        | K/C                                 |
| Freq Resolution               | 64 kHz                  | <<            | <<   | *             |        | K/C                                 |
| Frequency Band                | 300 M - 7 GHz           | <<            | <<   | *             |        | K/C                                 |
| Nominal Frequency             | 3 GHz                   | <<            | <<   | *             |        | K/C                                 |
| Max Input Level               | 0 dBm                   | <<            | <<   | *             |        | K/C                                 |
| Point Delay                   | 0 s                     | <<            | <<   | *             |        | K/C                                 |
| Points                        | 201                     | <<            | <<   | *             |        | K/C                                 |
| Sweep Parameter               | Control Voltage         | <<            | <<   | *             |        | K/C                                 |
| <b>Start/Center</b>           |                         |               |      |               |        |                                     |
| DC Control Center             | 50 uV                   |               |      |               |        | K/C                                 |
| DC Control Span               | 100 uV                  |               |      |               |        | K/C                                 |
| DC Control Start              | 0 V                     | <<            | <<   | *             |        | K/C                                 |
| DC Control Stop               | 100 uV                  | <<            | <<   | *             |        | K/C                                 |
| DC Power Center               | 500 uV                  |               |      |               |        | K/C                                 |
| DC Power Span                 | 1 mV                    |               |      |               |        | K/C                                 |
| DC Power Start                | 0 V                     | <<            | <<   | *             |        | K/C                                 |
| DC Power Stop                 | 1 mV                    | <<            | <<   | *             |        | K/C                                 |
| <b>Stop/Span</b>              |                         |               |      |               |        |                                     |
| DC Control Center             | 50 uV                   |               |      |               |        | K/C                                 |
| DC Control Span               | 100 uV                  |               |      |               |        | K/C                                 |
| DC Control Start              | 0 V                     | <<            | <<   | *             |        | K/C                                 |
| DC Control Stop               | 100 uV                  | <<            | <<   | *             |        | K/C                                 |
| DC Power Center               | 500 uV                  |               |      |               |        | K/C                                 |
| DC Power Span                 | 1 mV                    |               |      |               |        | K/C                                 |
| DC Power Start                | 0 V                     | <<            | <<   | *             |        | K/C                                 |
| DC Power Stop                 | 1 mV                    | <<            | <<   | *             |        | K/C                                 |
| <b>System</b>                 |                         |               |      |               |        |                                     |
| Abort Printing                |                         |               |      |               |        | K/C                                 |
| Backlight                     | ON                      |               |      |               |        | K/C                                 |
| Dump Screen Image...          |                         |               |      |               |        | K                                   |
| <b>Instrument Setup</b>       |                         |               |      |               |        |                                     |
| <b>Correction</b>             |                         |               |      |               |        |                                     |
| File Dialog...                |                         |               |      |               |        | K/C                                 |
| Import Power Correction Table |                         |               |      |               |        | K/C                                 |
| Power Correction              | OFF                     | <<            | <<   | *             |        | K/C                                 |

C. List of Default Values

List of Default Values  
FP Menu

| Key Operation                             | Factory-shipped Setting    | Default Value |      | Save / Recall | Backup | Available Means of Defining a Setting |
|-------------------------------------------|----------------------------|---------------|------|---------------|--------|---------------------------------------|
|                                           |                            | Preset        | *RST |               |        |                                       |
| <b>Down Converter Manual Setup</b>        |                            |               |      |               |        |                                       |
| Current                                   | 0 A                        | <<            | <<   | *             |        | K/C                                   |
| Current                                   | 0 A                        | <<            | <<   | *             |        | K/C                                   |
| IF Gain 1                                 | 0 dB                       | <<            | <<   | *             |        | K/C                                   |
| IF Gain 2                                 | 0 dB                       | <<            | <<   | *             |        | K/C                                   |
| LO1 Frequency                             | 2.975 GHz                  | <<            | <<   | *             |        | K/C                                   |
| LO1 Level                                 | 10 dBm                     | <<            | <<   | *             |        | K/C                                   |
| LO2 Frequency                             | 2.975 GHz                  | <<            | <<   | *             |        | K/C                                   |
| LO2 Level                                 | 10 dBm                     | <<            | <<   | *             |        | K/C                                   |
| Mixer 1 Bias                              | OFF                        | <<            | <<   | *             |        | K/C                                   |
| Mixer 2 Bias                              | OFF                        | <<            | <<   | *             |        | K/C                                   |
| $\Delta$ IF = IF2 - IF1                   | 0 Hz                       | <<            | <<   | *             |        | K/C                                   |
| <b>Frequency Offset (User Down Conv.)</b> |                            |               |      |               |        |                                       |
| Conversion Mode                           | $RF = n * LO + IF$         | <<            | <<   | *             |        | K/C                                   |
| Frequency Offset                          | OFF                        | <<            | <<   | *             |        | K/C                                   |
| Harmonic #                                | 1                          | <<            | <<   | *             |        | K/C                                   |
| LO Frequency                              | 3 GHz                      | <<            | <<   | *             |        | K/C                                   |
| Invert Image                              | OFF                        | <<            | <<   | *             |        | K/C                                   |
| <b>Misc Setup</b>                         |                            |               |      |               |        |                                       |
| <b>Beeper</b>                             |                            |               |      |               |        |                                       |
| Beep Complete                             | ON                         | <<            | <<   | *             |        | K/C                                   |
| Beep Warning                              | OFF                        | <<            | <<   | *             |        | K/C                                   |
| Test Beep Complete                        |                            |               |      |               |        | K/C                                   |
| Test Beep Warning                         |                            |               |      |               |        | K/C                                   |
| <b>Clock Setup</b>                        |                            |               |      |               |        |                                       |
| Set Date and Time                         |                            |               |      |               |        | K                                     |
| Show Clock                                | ON                         | <<            | <<   | *             |        | K/C                                   |
| <b>Color Setup</b>                        |                            |               |      |               |        |                                       |
| <b>Invert</b>                             |                            |               |      |               |        |                                       |
| Background                                | Red:255 Green:255 Blue:255 | <<            | <<   | *             |        | K/C                                   |
| Data Trace 1                              | Red:0 Green:0 Blue:255     | <<            | <<   | *             |        | K/C                                   |
| Data Trace 2                              | Red:255 Green:0 Blue:0     | <<            | <<   | *             |        | K/C                                   |
| Data Trace 3                              | Red:255 Green:0 Blue:255   | <<            | <<   | *             |        | K/C                                   |
| Data Trace 4                              | Red:0 Green:255 Blue:0     | <<            | <<   | *             |        | K/C                                   |
| Data Trace 5                              | Red:0 Green:0 Blue:255     | <<            | <<   | *             |        | K/C                                   |
| Data Trace 6                              | Red:255 Green:0 Blue:0     | <<            | <<   | *             |        | K/C                                   |
| Data Trace 7                              | Red:255 Green:0 Blue:255   | <<            | <<   | *             |        | K/C                                   |

| Key Operation  | Factory-shipped Setting    | Default Value |      | Save / Recall | Backup | Avaible Means of Defining a Setting |
|----------------|----------------------------|---------------|------|---------------|--------|-------------------------------------|
|                |                            | Preset        | *RST |               |        |                                     |
| Data Trace 8   | Red:0 Green:255 Blue:0     | <<            | <<   | *             |        | K/C                                 |
| Graticule Main | Red:128 Green:128 Blue:128 | <<            | <<   | *             |        | K/C                                 |
| Graticule Sub  | Red:192 Green:192 Blue:192 | <<            | <<   | *             |        | K/C                                 |
| Limit Fail     | Red:0 Green:255 Blue:255   | <<            | <<   | *             |        | K/C                                 |
| Limit Line     | Red:95 Green:223 Blue:223  | <<            | <<   | *             |        | K/C                                 |
| Mem Trace 1    | Red:128 Green:128 Blue:255 | <<            | <<   | *             |        | K/C                                 |
| Mem Trace 2    | Red:255 Green:128 Blue:128 | <<            | <<   | *             |        | K/C                                 |
| Mem Trace 3    | Red:255 Green:128 Blue:255 | <<            | <<   | *             |        | K/C                                 |
| Mem Trace 4    | Red:128 Green:255 Blue:128 | <<            | <<   | *             |        | K/C                                 |
| Mem Trace 5    | Red:128 Green:128 Blue:255 | <<            | <<   | *             |        | K/C                                 |
| Mem Trace 6    | Red:255 Green:128 Blue:128 | <<            | <<   | *             |        | K/C                                 |
| Mem Trace 7    | Red:255 Green:128 Blue:255 | <<            | <<   | *             |        | K/C                                 |
| Mem Trace 8    | Red:128 Green:255 Blue:128 | <<            | <<   | *             |        | K/C                                 |
| Reset Color    |                            |               |      |               |        | K/C                                 |
| Normal         |                            |               |      |               |        |                                     |
| Background     | Red:0 Green:0 Blue:0       | <<            | <<   | *             |        | K/C                                 |
| Data Trace 1   | Red:255 Green:255 Blue:0   | <<            | <<   | *             |        | K/C                                 |
| Data Trace 2   | Red:0 Green:255 Blue:255   | <<            | <<   | *             |        | K/C                                 |
| Data Trace 3   | Red:0 Green:255 Blue:0     | <<            | <<   | *             |        | K/C                                 |
| Data Trace 4   | Red:255 Green:0 Blue:255   | <<            | <<   | *             |        | K/C                                 |
| Data Trace 5   | Red:255 Green:255 Blue:0   | <<            | <<   | *             |        | K/C                                 |
| Data Trace 6   | Red:0 Green:255 Blue:255   | <<            | <<   | *             |        | K/C                                 |
| Data Trace 7   | Red:0 Green:255 Blue:0     | <<            | <<   | *             |        | K/C                                 |
| Data Trace 8   | Red:255 Green:0 Blue:255   | <<            | <<   | *             |        | K/C                                 |
| Graticule Main | Red:127 Green:127 Blue:127 | <<            | <<   | *             |        | K/C                                 |
| Graticule Sub  | Red:63 Green:63 Blue:63    | <<            | <<   | *             |        | K/C                                 |
| Limit Fail     | Red:255 Green:0 Blue:0     | <<            | <<   | *             |        | K/C                                 |
| Limit Line     | Red:160 Green:32 Blue:32   | <<            | <<   | *             |        | K/C                                 |
| Mem Trace 1    | Red:127 Green:127 Blue:0   | <<            | <<   | *             |        | K/C                                 |
| Mem Trace 2    | Red:0 Green:127 Blue:127   | <<            | <<   | *             |        | K/C                                 |
| Mem Trace 3    | Red:0 Green:127 Blue:0     | <<            | <<   | *             |        | K/C                                 |
| Mem Trace 4    | Red:127 Green:0 Blue:127   | <<            | <<   | *             |        | K/C                                 |
| Mem Trace 5    | Red:127 Green:127 Blue:0   | <<            | <<   | *             |        | K/C                                 |
| Mem Trace 6    | Red:0 Green:127 Blue:127   | <<            | <<   | *             |        | K/C                                 |
| Mem Trace 7    | Red:0 Green:127 Blue:0     | <<            | <<   | *             |        | K/C                                 |
| Mem Trace 8    | Red:127 Green:0 Blue:127   | <<            | <<   | *             |        | K/C                                 |
| Reset Color    |                            |               |      |               |        | K/C                                 |

C. List of Default Values

List of Default Values  
FP Menu

| Key Operation                   | Factory-shipped Setting | Default Value |      | Save / Recall | Backup | Available Means of Defining a Setting |
|---------------------------------|-------------------------|---------------|------|---------------|--------|---------------------------------------|
|                                 |                         | Preset        | *RST |               |        |                                       |
| Control Panel                   |                         |               |      |               |        | K                                     |
| GPIB Setup                      |                         |               |      |               |        |                                       |
| System Controller Configuration |                         |               |      |               |        |                                       |
| Talker/Listener Address         | 17                      | <<            | <<   | *             |        | K/C                                   |
| Key Lock                        |                         |               |      |               |        |                                       |
| Front Panel & Keyboard Lock     | OFF                     | <<            | <<   | *             |        | K/C                                   |
| Touch Screen & Mouse Lock       | OFF                     | <<            | <<   | *             |        | K/C                                   |
| Network Setup                   |                         |               |      |               |        |                                       |
| MAC Address                     |                         |               |      |               |        |                                       |
| Network Configuration...        |                         |               |      |               |        | K                                     |
| Network Identification...       |                         |               |      |               |        | K                                     |
| SICL-LAN Address                | 17                      | <<            | <<   | *             |        | K/C                                   |
| SICL-LAN Server                 | OFF                     | <<            | <<   | *             |        | K/C                                   |
| Socket Server                   | OFF                     | <<            | <<   | *             |        | K/C                                   |
| Telnet Server                   | OFF                     | <<            | <<   | *             |        | K/C                                   |
| Print                           |                         |               |      |               |        | K                                     |
| Printer Setup...                |                         |               |      |               |        | K                                     |
| Product Information             |                         |               |      |               |        | K                                     |
| Trace View                      |                         |               |      |               |        |                                       |
| Aperture                        | 1.5 %                   | <<            | <<   | *             |        | K/C                                   |
| Copy to User                    |                         |               |      |               |        | K/C                                   |
| Data Hold                       | Off                     | <<            | <<   | *             |        | K/C                                   |
| Data Math                       | Off                     | <<            | <<   | *             |        | K/C                                   |
| Display Trace                   | Data                    | <<            | <<   | *             |        | K/C                                   |
| Marker -> -Offset               |                         |               |      |               |        | K/C                                   |
| Memory Trace                    |                         |               |      |               |        |                                       |
| Line (Y = AX + B)               |                         |               |      |               |        |                                       |
| A                               | 0                       | <<            | <<   | *             |        | K/C                                   |
| B                               | 0                       | <<            | <<   | *             |        | K/C                                   |
| Data Trace -> A, B              |                         |               |      |               |        | K/C                                   |
| Set Line to Memory              |                         |               |      |               |        | K/C                                   |
| Offset                          | 0                       | <<            | <<   | *             |        | K/C                                   |

| Key Operation           | Factory-shipped Setting | Default Value |      | Save / Recall | Backup | Avaible Means of Defining a Setting |
|-------------------------|-------------------------|---------------|------|---------------|--------|-------------------------------------|
|                         |                         | Preset        | *RST |               |        |                                     |
| <b>Persistence</b>      |                         |               |      |               |        |                                     |
| Clear Persistent Data   |                         |               |      |               |        | K/C                                 |
| Persistece Mode         | OFF                     | <<            | <<   | *             |        | K/C                                 |
| <b>Smoothing</b>        | OFF                     | <<            | <<   | *             |        | K/C                                 |
| <b>Trace Label</b>      | "Freq"                  | <<            | <<   | *             |        | K/C                                 |
| <b>Trigger</b>          |                         |               |      |               |        |                                     |
| Average Trigger         | OFF                     |               |      | *             |        | K/C                                 |
| Ext Trig Polarity       | Negative                | <<            | <<   | *             |        | K/C                                 |
| Mode                    | Analyzer(standard)      | <<            | <<   | *             |        | K/C                                 |
|                         | Tester(option 011)      | <<            | <<   | *             |        | K/C                                 |
| Source                  | Internal                | <<            | <<   | *             |        | K/C                                 |
| Trigger to Freq & Power | Selected Phase Noise    | <<            | <<   | *             |        | K/C                                 |

## PN Menu

| Key Operation             | Factory-shipped Setting | Default Value |      | Save / Recall | Backup | Available Means of Defining a Setting |
|---------------------------|-------------------------|---------------|------|---------------|--------|---------------------------------------|
|                           |                         | Preset        | *RST |               |        |                                       |
| <b>Attenuator</b>         |                         |               |      |               |        |                                       |
| Input Attenuator          | 5 dB                    | <<            | <<   | *             |        | K/C                                   |
| <b>Average</b>            |                         |               |      |               |        |                                       |
| Averaging                 | OFF                     | <<            | <<   | *             |        | K/C                                   |
| Averaging Restart         |                         |               |      |               |        | K/C                                   |
| Avg Factor                | 16                      | <<            | <<   | *             |        | K/C                                   |
| Correlation               | 1                       | <<            | <<   | *             |        | K/C                                   |
| <b>DC Control Voltage</b> |                         |               |      |               |        |                                       |
| <b>Auto Freq Control</b>  |                         |               |      |               |        |                                       |
| AFC Status                | OFF                     | <<            | <<   | *             |        | K/C                                   |
| Frequency Band            | 300 M - 7 GHz           | <<            | <<   | *             |        | K/C                                   |
| Max Ctrl Voltage Limit    | 35 V                    | <<            | <<   | *             |        | K/C                                   |
| Max Input Level           | 0 dBm                   | <<            | <<   | *             |        | K/C                                   |
| Max Iteration             | 10                      | <<            | <<   | *             |        | K/C                                   |
| Min Ctrl Voltage Limit    | -15 V                   | <<            | <<   | *             |        | K/C                                   |
| Sensitivity               | 10 MHz/V                | <<            | <<   | *             |        | K/C                                   |
| Target                    | 1 GHz                   | <<            | <<   | *             |        | K/C                                   |
| Tolerance                 | 1 kHz                   | <<            | <<   | *             |        | K/C                                   |
| Control Voltage Cal       | OFF                     | <<            | <<   |               |        | K/C                                   |
| DC Control Delay          | 100 ms                  | <<            | <<   | *             |        | K/C                                   |
| DC Control Output         | OFF                     | <<            | <<   |               |        | K/C                                   |
| DC Control Voltage        | 0 V                     | <<            | <<   | *             |        | K/C                                   |
| Max Ctrl Voltage Limit    | 35 V                    | <<            | <<   | *             |        | K/C                                   |
| Min Ctrl Voltage Limit    | -15 V                   | <<            | <<   | *             |        | K/C                                   |
| <b>DC Power Voltage</b>   |                         |               |      |               |        |                                       |
| DC Power Delay            | 100 ms                  | <<            | <<   | *             |        | K/C                                   |
| DC Power Output           | OFF                     | <<            | <<   |               |        | K/C                                   |
| DC Power Voltage          | 0 V                     | <<            | <<   | *             |        | K/C                                   |
| Max Pwr Voltage Limit     | 16 V                    | <<            | <<   | *             |        | K/C                                   |
| Min Pwr Voltage Limit     | 0 V                     | <<            | <<   | *             |        | K/C                                   |
| <b>Display</b>            |                         |               |      |               |        |                                       |
| Edit Title Label          | ""                      | <<            | <<   | *             |        | K/C                                   |
| Color Type                | "Normal"                | <<            | <<   | *             |        | K/C                                   |

| Key Operation               | Factory-shipped Setting | Default Value |      | Save / Recall | Backup | Avaible Means of Defining a Setting |
|-----------------------------|-------------------------|---------------|------|---------------|--------|-------------------------------------|
|                             |                         | Preset        | *RST |               |        |                                     |
| <b>Limit Test</b>           |                         |               |      |               |        |                                     |
| Delete Lower Limit Line     |                         |               |      |               |        | K/C                                 |
| Delete Upper Limit Line     |                         |               |      |               |        | K/C                                 |
| Fail Sign                   | ON                      | <<            | <<   | *             |        | K/C                                 |
| Import Lower Limit Line ... |                         |               |      |               |        | K/C                                 |
| Import Upper Limit Line ... |                         |               |      |               |        | K/C                                 |
| Limit Line                  | ON                      | <<            | <<   | *             |        | K/C                                 |
| Limit Test                  | OFF                     | <<            | <<   | *             |        | K/C                                 |
| Marker Information          | Right                   | <<            | <<   | *             |        | K/C                                 |
| Meas Condition              | ON                      | <<            | <<   | *             |        | K/C                                 |
| Relative Y-Scale            | OFF                     | <<            | <<   | *             |        | K/C                                 |
| Title Label                 | OFF                     | <<            | <<   | *             |        | K/C                                 |
| Update                      | ON                      | <<            | <<   | *             |        | K/C                                 |
| Y # of Digits               | 4-digits                | <<            | <<   | *             |        | K/C                                 |
| <b>Input Port</b>           |                         |               |      |               |        |                                     |
| Down Converter              |                         |               |      |               |        |                                     |
| Down Converter              | OFF                     | <<            | <<   | *             |        | K/C                                 |
| External Mixer              | Not Used                | <<            | <<   | *             |        | K/C                                 |
| RF Input                    | Down Converter          | <<            | <<   | *             |        | K/C                                 |
| <b>Macro Setup</b>          |                         |               |      |               |        |                                     |
| E5052 Event                 | OFF                     |               |      |               |        | K/C                                 |
| Echo Window Menu            |                         |               |      |               |        |                                     |
| Clear Echo                  |                         |               |      |               |        | K/C                                 |
| Echo Font Size              | 11                      |               |      |               |        | K/C                                 |
| Echo Window                 | OFF                     |               |      |               |        | K/C                                 |
| User Menu                   |                         |               |      |               |        |                                     |
| User Label 1                |                         |               |      |               |        | K/C                                 |
| <b>Marker</b>               |                         |               |      |               |        |                                     |
| Clear Marker Menu           |                         |               |      |               |        |                                     |
| Marker 1                    | OFF                     | <<            | <<   | *             |        | K/C                                 |
| Marker List                 | OFF                     | <<            | <<   | *             |        | K/C                                 |
| More Functions              |                         |               |      |               |        |                                     |
| Discrete                    | OFF                     | <<            | <<   | *             |        | K/C                                 |
| Ref Marker                  | 1                       | <<            | <<   | *             |        | K/C                                 |
| Ref Marker Mode             | OFF                     | <<            | <<   | *             |        | K/C                                 |

C. List of Default Values

List of Default Values  
PN Menu

| Key Operation          | Factory-shipped Setting | Default Value |      | Save / Recall | Backup | Available Means of Defining a Setting |
|------------------------|-------------------------|---------------|------|---------------|--------|---------------------------------------|
|                        |                         | Preset        | *RST |               |        |                                       |
| <b>Marker Function</b> |                         |               |      |               |        |                                       |
| Analysis Range (X)     | Band Marker             | <<            | <<   | *             |        | K/C                                   |
| Analysis Range (Y)     | Band Marker             | <<            | <<   | *             |        | K/C                                   |
| Analysis Type          | Off                     | <<            | <<   | *             |        | K/C                                   |
| <b>Band Marker X</b>   |                         |               |      |               |        |                                       |
| Band Marker X          | OFF                     | <<            | <<   | *             |        | K/C                                   |
| Center                 | 0 Hz                    |               |      |               |        | K/C                                   |
| Span                   | 2 THz                   |               |      |               |        | K/C                                   |
| Start                  | -1 THz                  | <<            | <<   | *             |        | K/C                                   |
| Stop                   | 1 THz                   | <<            | <<   | *             |        | K/C                                   |
| <b>Band Marker Y</b>   |                         |               |      |               |        |                                       |
| Band Marker Y          | OFF                     | <<            | <<   | *             |        | K/C                                   |
| Center                 | 0 dBc/Hz                |               |      |               |        | K/C                                   |
| Span                   | 2 TdBc/Hz               |               |      |               |        | K/C                                   |
| Start                  | -1 TdBc/Hz              | <<            | <<   | *             |        | K/C                                   |
| Stop                   | 1 TdBc/Hz               | <<            | <<   | *             |        | K/C                                   |
| <b>Marker Search</b>   |                         |               |      |               |        |                                       |
| <b>Band Marker X</b>   |                         |               |      |               |        |                                       |
| Band Marker X          | OFF                     | <<            | <<   | *             |        | K/C                                   |
| Center                 | 0 Hz                    |               |      |               |        | K/C                                   |
| Span                   | 2 THz                   |               |      |               |        | K/C                                   |
| Start                  | -1 THz                  | <<            | <<   | *             |        | K/C                                   |
| Stop                   | 1 THz                   | <<            | <<   | *             |        | K/C                                   |
| <b>Band Marker Y</b>   |                         |               |      |               |        |                                       |
| Band Marker Y          | OFF                     | <<            | <<   | *             |        | K/C                                   |
| Center                 | 0 dBc/Hz                |               |      |               |        | K/C                                   |
| Span                   | 2 TdBc/Hz               |               |      |               |        | K/C                                   |
| Start                  | -1 TdBc/Hz              | <<            | <<   | *             |        | K/C                                   |
| Stop                   | 1 TdBc/Hz               | <<            | <<   | *             |        | K/C                                   |
| <b>Peak</b>            |                         |               |      |               |        |                                       |
| Peak Excursion         | 0 dB                    | <<            | <<   | *             |        | K/C                                   |
| Peak Polarity          | Positive                | <<            | <<   | *             |        | K/C                                   |
| Search Left            |                         |               |      |               |        | K/C                                   |
| Search Peak            |                         |               |      |               |        | K/C                                   |
| Search Peak All        |                         |               |      |               |        | K/C                                   |
| Search Right           |                         |               |      |               |        | K/C                                   |
| Search Max             |                         |               |      |               |        | K/C                                   |
| Search Min             |                         |               |      |               |        | K/C                                   |
| Search Range (X)       | Full Range              | <<            | <<   | *             |        | K/C                                   |
| Search Range (Y)       | Full Range              | <<            | <<   | *             |        | K/C                                   |



| Key Operation           | Factory-shipped Setting | Default Value |      | Save / Recall | Backup | Avaible Means of Defining a Setting |
|-------------------------|-------------------------|---------------|------|---------------|--------|-------------------------------------|
|                         |                         | Preset        | *RST |               |        |                                     |
| <b>Target</b>           |                         |               |      |               |        |                                     |
| Search Left             |                         |               |      |               |        | K/C                                 |
| Search Right            |                         |               |      |               |        | K/C                                 |
| Search Target           |                         |               |      |               |        | K/C                                 |
| Search Transition       | Both                    | <<            | <<   | *             |        | K/C                                 |
| Search Value            | 0 dBc/Hz                | <<            | <<   | *             |        | K/C                                 |
| Tracking                | Off                     | <<            | <<   | *             |        | K/C                                 |
| <b>Marker To</b>        |                         |               |      |               |        |                                     |
| Marker -> Start         |                         |               |      |               |        | K/C                                 |
| Marker -> Stop          |                         |               |      |               |        | K/C                                 |
| <b>Measurement View</b> |                         |               |      |               |        |                                     |
| Freq & Power            | Selected Phase Noise    | <<            | <<   | *             |        | K/C                                 |
| Phase Noise             | Selected Phase Noise    | <<            | <<   | *             |        | K/C                                 |
| Show Window             |                         |               |      |               |        |                                     |
| Freq & Power            | ON                      | <<            | <<   | *             |        | K/C                                 |
| Phase Noise             | ON                      | <<            | <<   | *             |        | K/C                                 |
| Spectrum Monitor        | ON                      | <<            | <<   | *             |        | K/C                                 |
| Transient               | ON                      | <<            | <<   | *             |        | K/C                                 |
| User                    | OFF                     | <<            | <<   | *             |        | K/C                                 |
| Spectrum Monitor        | Selected Phase Noise    | <<            | <<   | *             |        | K/C                                 |
| Transient               | Selected Phase Noise    | <<            | <<   | *             |        | K/C                                 |
| User                    | Selected Phase Noise    | <<            | <<   | *             |        | K/C                                 |
| <b>Save/Recall</b>      |                         |               |      |               |        |                                     |
| Save State              |                         |               |      |               |        |                                     |
| Save Type               | State Only              |               |      |               |        | K/C                                 |
| <b>Scale</b>            |                         |               |      |               |        |                                     |
| Auto Scale              |                         |               |      |               |        | K/C                                 |
| Divisions               | 16                      | <<            | <<   | *             |        | K/C                                 |
| Marker -> Reference     |                         |               |      |               |        | K/C                                 |
| Reference Position      | 16 Div                  | <<            | <<   | *             |        | K/C                                 |
| Reference Value         | -20 dBc/Hz              | <<            | <<   | *             |        | K/C                                 |
| Scale/Div               | 10 dB/Div               | <<            | <<   | *             |        | K/C                                 |
| X Axis                  |                         |               |      |               |        |                                     |
| Auto                    | ON                      | <<            | <<   | *             |        | K/C                                 |
| Band Marker -> X Axis   |                         |               |      |               |        | K/C                                 |
| Left                    | 1 kHz                   | <<            | <<   | *             |        | K/C                                 |
| Right                   | 10 MHz                  | <<            | <<   | *             |        | K/C                                 |

C. List of Default Values

List of Default Values  
PN Menu

| Key Operation                      | Factory-shipped Setting | Default Value |      | Save / Recall | Backup | Avaible Means of Defining a Setting |
|------------------------------------|-------------------------|---------------|------|---------------|--------|-------------------------------------|
|                                    |                         | Preset        | *RST |               |        |                                     |
| <b>Setup</b>                       |                         |               |      |               |        |                                     |
| Carrier Search                     |                         |               |      |               |        | K/C                                 |
| Frequency Band                     | 300 M - 7 GHz           | <<            | <<   | *             |        | K/C                                 |
| IF Gain                            | 20 dB                   | <<            | <<   | *             |        | K/C                                 |
| LO PhNoise Optimize                | L(f) for < 150 kHz      | <<            | <<   | *             |        | K/C                                 |
| Measurement Quality                | Normal                  | <<            | <<   | *             |        | K/C                                 |
| Nominal Frequency                  | 3 GHz                   | <<            | <<   | *             |        | K/C                                 |
| <b>Start</b>                       |                         |               |      |               |        |                                     |
| 100Hz                              | 1 kHz                   | <<            | <<   | *             |        | K/C                                 |
| 10Hz                               | 1 kHz                   | <<            | <<   | *             |        | K/C                                 |
| 1Hz                                | 1 kHz                   | <<            | <<   | *             |        | K/C                                 |
| 1kHz                               | 1 kHz                   | <<            | <<   | *             |        | K/C                                 |
| <b>Stop</b>                        |                         |               |      |               |        |                                     |
| 100kHz                             | 10 MHz                  | <<            | <<   | *             |        | K/C                                 |
| 10MHz                              | 10 MHz                  | <<            | <<   | *             |        | K/C                                 |
| 1MHz                               | 10 MHz                  | <<            | <<   | *             |        | K/C                                 |
| 40MHz                              | 10 MHz                  | <<            | <<   | *             |        | K/C                                 |
| 5MHz                               | 10 MHz                  | <<            | <<   | *             |        | K/C                                 |
| <b>System</b>                      |                         |               |      |               |        |                                     |
| Abort Printing                     |                         |               |      |               |        | K/C                                 |
| Backlight                          | ON                      |               |      |               |        | K/C                                 |
| Dump Screen Image...               |                         |               |      |               |        | K                                   |
| <b>Instrument Setup</b>            |                         |               |      |               |        |                                     |
| <b>Correction</b>                  |                         |               |      |               |        |                                     |
| File Dialog...                     |                         |               |      |               |        | K/C                                 |
| Import Power Correction Table      |                         |               |      |               |        | K/C                                 |
| Power Correction                   | OFF                     | <<            | <<   | *             |        | K/C                                 |
| <b>Down Converter Manual Setup</b> |                         |               |      |               |        |                                     |
| Current                            | 0 A                     | <<            | <<   | *             |        | K/C                                 |
| Current                            | 0 A                     | <<            | <<   | *             |        | K/C                                 |
| IF Gain 1                          | 0 dB                    | <<            | <<   | *             |        | K/C                                 |
| IF Gain 2                          | 0 dB                    | <<            | <<   | *             |        | K/C                                 |
| LO1 Frequency                      | 2.975 GHz               | <<            | <<   | *             |        | K/C                                 |
| LO1 Level                          | 10 dBm                  | <<            | <<   | *             |        | K/C                                 |
| LO2 Frequency                      | 2.975 GHz               | <<            | <<   | *             |        | K/C                                 |
| LO2 Level                          | 10 dBm                  | <<            | <<   | *             |        | K/C                                 |
| Mixer 1 Bias                       | OFF                     | <<            | <<   | *             |        | K/C                                 |
| Mixer 2 Bias                       | OFF                     | <<            | <<   | *             |        | K/C                                 |
| $\Delta$ IF = IF2 - IF1            | 0 Hz                    | <<            | <<   | *             |        | K/C                                 |

| Key Operation                      | Factory-shipped Setting    | Default Value |      | Save / Recall | Backup | Available Means of Defining a Setting |
|------------------------------------|----------------------------|---------------|------|---------------|--------|---------------------------------------|
|                                    |                            | Preset        | *RST |               |        |                                       |
| Frequency Offset (User Down Conv.) |                            |               |      |               |        |                                       |
| Conversion Mode                    | RF = n * LO + IF           | <<            | <<   | *             |        | K/C                                   |
| Frequency Offset                   | OFF                        | <<            | <<   | *             |        | K/C                                   |
| Harmonic #                         | 1                          | <<            | <<   | *             |        | K/C                                   |
| LO Frequency                       | 3 GHz                      | <<            | <<   | *             |        | K/C                                   |
| PN Ext. Prescaler                  |                            |               |      |               |        |                                       |
| Division                           | 1                          | <<            | <<   | *             |        | K/C                                   |
| Output Power Level                 | 0 dBm                      | <<            | <<   | *             |        | K/C                                   |
| Invert Image                       | OFF                        | <<            | <<   | *             |        | K/C                                   |
| Misc Setup                         |                            |               |      |               |        |                                       |
| Beeper                             |                            |               |      |               |        |                                       |
| Beep Complete                      | ON                         | <<            | <<   | *             |        | K/C                                   |
| Beep Warning                       | OFF                        | <<            | <<   | *             |        | K/C                                   |
| Test Beep Complete                 |                            |               |      |               |        | K/C                                   |
| Test Beep Warning                  |                            |               |      |               |        | K/C                                   |
| Clock Setup                        |                            |               |      |               |        |                                       |
| Set Date and Time                  |                            |               |      |               |        | K                                     |
| Show Clock                         | ON                         | <<            | <<   | *             |        | K/C                                   |
| Color Setup                        |                            |               |      |               |        |                                       |
| Invert                             |                            |               |      |               |        |                                       |
| Background                         | Red:255 Green:255 Blue:255 | <<            | <<   | *             |        | K/C                                   |
| Data Trace 1                       | Red:0 Green:0 Blue:255     | <<            | <<   | *             |        | K/C                                   |
| Data Trace 2                       | Red:255 Green:0 Blue:0     | <<            | <<   | *             |        | K/C                                   |
| Data Trace 3                       | Red:255 Green:0 Blue:255   | <<            | <<   | *             |        | K/C                                   |
| Data Trace 4                       | Red:0 Green:255 Blue:0     | <<            | <<   | *             |        | K/C                                   |
| Data Trace 5                       | Red:0 Green:0 Blue:255     | <<            | <<   | *             |        | K/C                                   |
| Data Trace 6                       | Red:255 Green:0 Blue:0     | <<            | <<   | *             |        | K/C                                   |
| Data Trace 7                       | Red:255 Green:0 Blue:255   | <<            | <<   | *             |        | K/C                                   |
| Data Trace 8                       | Red:0 Green:255 Blue:0     | <<            | <<   | *             |        | K/C                                   |
| Graticule Main                     | Red:128 Green:128 Blue:128 | <<            | <<   | *             |        | K/C                                   |
| Graticule Sub                      | Red:192 Green:192 Blue:192 | <<            | <<   | *             |        | K/C                                   |
| Limit Fail                         | Red:0 Green:255 Blue:255   | <<            | <<   | *             |        | K/C                                   |
| Limit Line                         | Red:95 Green:223 Blue:223  | <<            | <<   | *             |        | K/C                                   |
| Mem Trace 1                        | Red:128 Green:128 Blue:255 | <<            | <<   | *             |        | K/C                                   |
| Mem Trace 2                        | Red:255 Green:128 Blue:128 | <<            | <<   | *             |        | K/C                                   |
| Mem Trace 3                        | Red:255 Green:128 Blue:255 | <<            | <<   | *             |        | K/C                                   |

C. List of Default Values

List of Default Values  
PN Menu

| Key Operation                   | Factory-shipped Setting    | Default Value |      | Save / Recall | Backup | Available Means of Defining a Setting |
|---------------------------------|----------------------------|---------------|------|---------------|--------|---------------------------------------|
|                                 |                            | Preset        | *RST |               |        |                                       |
| Mem Trace 4                     | Red:128 Green:255 Blue:128 | <<            | <<   | *             |        | K/C                                   |
| Mem Trace 5                     | Red:128 Green:128 Blue:255 | <<            | <<   | *             |        | K/C                                   |
| Mem Trace 6                     | Red:255 Green:128 Blue:128 | <<            | <<   | *             |        | K/C                                   |
| Mem Trace 7                     | Red:255 Green:128 Blue:255 | <<            | <<   | *             |        | K/C                                   |
| Mem Trace 8                     | Red:128 Green:255 Blue:128 | <<            | <<   | *             |        | K/C                                   |
| Reset Color                     |                            |               |      |               |        | K/C                                   |
| <b>Normal</b>                   |                            |               |      |               |        |                                       |
| Background                      | Red:0 Green:0 Blue:0       | <<            | <<   | *             |        | K/C                                   |
| Data Trace 1                    | Red:255 Green:255 Blue:0   | <<            | <<   | *             |        | K/C                                   |
| Data Trace 2                    | Red:0 Green:255 Blue:255   | <<            | <<   | *             |        | K/C                                   |
| Data Trace 3                    | Red:0 Green:255 Blue:0     | <<            | <<   | *             |        | K/C                                   |
| Data Trace 4                    | Red:255 Green:0 Blue:255   | <<            | <<   | *             |        | K/C                                   |
| Data Trace 5                    | Red:255 Green:255 Blue:0   | <<            | <<   | *             |        | K/C                                   |
| Data Trace 6                    | Red:0 Green:255 Blue:255   | <<            | <<   | *             |        | K/C                                   |
| Data Trace 7                    | Red:0 Green:255 Blue:0     | <<            | <<   | *             |        | K/C                                   |
| Data Trace 8                    | Red:255 Green:0 Blue:255   | <<            | <<   | *             |        | K/C                                   |
| Graticule Main                  | Red:127 Green:127 Blue:127 | <<            | <<   | *             |        | K/C                                   |
| Graticule Sub                   | Red:63 Green:63 Blue:63    | <<            | <<   | *             |        | K/C                                   |
| Limit Fail                      | Red:255 Green:0 Blue:0     | <<            | <<   | *             |        | K/C                                   |
| Limit Line                      | Red:160 Green:32 Blue:32   | <<            | <<   | *             |        | K/C                                   |
| Mem Trace 1                     | Red:127 Green:127 Blue:0   | <<            | <<   | *             |        | K/C                                   |
| Mem Trace 2                     | Red:0 Green:127 Blue:127   | <<            | <<   | *             |        | K/C                                   |
| Mem Trace 3                     | Red:0 Green:127 Blue:0     | <<            | <<   | *             |        | K/C                                   |
| Mem Trace 4                     | Red:127 Green:0 Blue:127   | <<            | <<   | *             |        | K/C                                   |
| Mem Trace 5                     | Red:127 Green:127 Blue:0   | <<            | <<   | *             |        | K/C                                   |
| Mem Trace 6                     | Red:0 Green:127 Blue:127   | <<            | <<   | *             |        | K/C                                   |
| Mem Trace 7                     | Red:0 Green:127 Blue:0     | <<            | <<   | *             |        | K/C                                   |
| Mem Trace 8                     | Red:127 Green:0 Blue:127   | <<            | <<   | *             |        | K/C                                   |
| Reset Color                     |                            |               |      |               |        | K/C                                   |
| Control Panel                   |                            |               |      |               |        | K                                     |
| <b> GPIB Setup</b>              |                            |               |      |               |        |                                       |
| System Controller Configuration |                            |               |      |               |        |                                       |
| Talker/Listener Address         | 17                         | <<            | <<   | *             |        | K/C                                   |
| <b>Key Lock</b>                 |                            |               |      |               |        |                                       |
| Front Panel & Keyboard Lock     | OFF                        | <<            | <<   | *             |        | K/C                                   |
| Touch Screen & Mouse Lock       | OFF                        | <<            | <<   | *             |        | K/C                                   |

| Key Operation             | Factory-shipped Setting | Default Value |      | Save / Recall | Backup | Available Means of Defining a Setting |
|---------------------------|-------------------------|---------------|------|---------------|--------|---------------------------------------|
|                           |                         | Preset        | *RST |               |        |                                       |
| <b>Network Setup</b>      |                         |               |      |               |        |                                       |
| MAC Address               |                         |               |      |               |        |                                       |
| Network Configuration...  |                         |               |      |               |        | K                                     |
| Network Identification... |                         |               |      |               |        | K                                     |
| SICL-LAN Address          | 17                      | <<            | <<   | *             |        | K/C                                   |
| SICL-LAN Server           | OFF                     | <<            | <<   | *             |        | K/C                                   |
| Socket Server             | OFF                     | <<            | <<   | *             |        | K/C                                   |
| Telnet Server             | OFF                     | <<            | <<   | *             |        | K/C                                   |
| <b>Print</b>              |                         |               |      |               |        | K                                     |
| Printer Setup...          |                         |               |      |               |        | K                                     |
| Product Information       |                         |               |      |               |        | K                                     |
| <b>Trace View</b>         |                         |               |      |               |        |                                       |
| Aperture                  | 1.5 %                   | <<            | <<   | *             |        | K/C                                   |
| Copy to User              |                         |               |      |               |        | K/C                                   |
| Data Hold                 | Off                     | <<            | <<   | *             |        | K/C                                   |
| Data Math                 | Off                     | <<            | <<   | *             |        | K/C                                   |
| Display Trace             | Data                    | <<            | <<   | *             |        | K/C                                   |
| Marker -> -Offset         |                         |               |      |               |        | K/C                                   |
| Offset                    | 0 dBc/Hz                | <<            | <<   | *             |        | K/C                                   |
| Persistence               |                         |               |      |               |        |                                       |
| Clear Persistent Data     |                         |               |      |               |        | K/C                                   |
| Persistence Mode          | OFF                     | <<            | <<   | *             |        | K/C                                   |
| Smoothing                 | OFF                     | <<            | <<   | *             |        | K/C                                   |
| Spurious                  | Normalized (dBc/Hz)     | <<            | <<   | *             |        | K/C                                   |
| Clear Threshold Table     |                         |               |      |               |        | K/C                                   |
| Explorer                  |                         |               |      |               |        | K                                     |
| Import Threshold Table... |                         |               |      |               |        | K/C                                   |
| Minimum Spur Level        | -500 dBc                | <<            | <<   | *             |        | K/C                                   |
| Spurious List             |                         |               |      |               |        | K                                     |
| Trace Label               | "Phase Noise"           | <<            | <<   | *             |        | K/C                                   |
| <b>Trigger</b>            |                         |               |      |               |        |                                       |
| Average Trigger           | OFF                     |               |      | *             |        | K/C                                   |
| Ext Trig Polarity         | Negative                | <<            | <<   | *             |        | K/C                                   |
| Source                    | Internal                | <<            | <<   | *             |        | K/C                                   |
| Trigger to Phase Noise    | Selected Phase Noise    | <<            | <<   | *             |        | K/C                                   |

C. List of Default Values

## SP Menu

| Key Operation             | Factory-shipped Setting | Default Value |      | Save / Recall | Backup | Available Means of Defining a Setting |
|---------------------------|-------------------------|---------------|------|---------------|--------|---------------------------------------|
|                           |                         | Preset        | *RST |               |        |                                       |
| <b>Attenuator</b>         |                         |               |      |               |        |                                       |
| Input Attenuator          | 5 dB                    | <<            | <<   | *             |        | K/C                                   |
| <b>Average/BW</b>         |                         |               |      |               |        |                                       |
| Averaging                 | OFF                     | <<            | <<   | *             |        | K/C                                   |
| Averaging Restart         |                         |               |      |               |        | K/C                                   |
| Averaging Type            | Log-Pwr Avg             | <<            | <<   | *             |        | K/C                                   |
| Avg Factor                | 16                      | <<            | <<   | *             |        | K/C                                   |
| RBW                       | 25 kHz                  | <<            | <<   | *             |        | K/C                                   |
| <b>DC Control Voltage</b> |                         |               |      |               |        |                                       |
| <b>Auto Freq Control</b>  |                         |               |      |               |        |                                       |
| AFC Status                | OFF                     | <<            | <<   | *             |        | K/C                                   |
| Frequency Band            | 300 M - 7 GHz           | <<            | <<   | *             |        | K/C                                   |
| Max Ctrl Voltage Limit    | 35 V                    | <<            | <<   | *             |        | K/C                                   |
| Max Input Level           | 0 dBm                   | <<            | <<   | *             |        | K/C                                   |
| Max Iteration             | 10                      | <<            | <<   | *             |        | K/C                                   |
| Min Ctrl Voltage Limit    | -15 V                   | <<            | <<   | *             |        | K/C                                   |
| Sensitivity               | 10 MHz/V                | <<            | <<   | *             |        | K/C                                   |
| Target                    | 1 GHz                   | <<            | <<   | *             |        | K/C                                   |
| Tolerance                 | 1 kHz                   | <<            | <<   | *             |        | K/C                                   |
| Control Voltage Cal       | OFF                     | <<            | <<   |               |        | K/C                                   |
| DC Control Delay          | 100 ms                  | <<            | <<   | *             |        | K/C                                   |
| DC Control Output         | OFF                     | <<            | <<   |               |        | K/C                                   |
| DC Control Voltage        | 0 V                     | <<            | <<   | *             |        | K/C                                   |
| Max Ctrl Voltage Limit    | 35 V                    | <<            | <<   | *             |        | K/C                                   |
| Min Ctrl Voltage Limit    | -15 V                   | <<            | <<   | *             |        | K/C                                   |
| <b>DC Power Voltage</b>   |                         |               |      |               |        |                                       |
| DC Power Delay            | 100 ms                  | <<            | <<   | *             |        | K/C                                   |
| DC Power Output           | OFF                     | <<            | <<   |               |        | K/C                                   |
| DC Power Voltage          | 0 V                     | <<            | <<   | *             |        | K/C                                   |
| Max Pwr Voltage Limit     | 16 V                    | <<            | <<   | *             |        | K/C                                   |
| Min Pwr Voltage Limit     | 0 V                     | <<            | <<   | *             |        | K/C                                   |
| <b>Display</b>            |                         |               |      |               |        |                                       |
| Edit Title Label          | ""                      | <<            | <<   | *             |        | K/C                                   |
| Color Type                | "Normal"                | <<            | <<   | *             |        | K/C                                   |

| Key Operation               | Factory-shipped Setting | Default Value |      | Save / Recall | Backup | Available Means of Defining a Setting |
|-----------------------------|-------------------------|---------------|------|---------------|--------|---------------------------------------|
|                             |                         | Preset        | *RST |               |        |                                       |
| <b>Limit Test</b>           |                         |               |      |               |        |                                       |
| Delete Lower Limit Line     |                         |               |      |               |        | K/C                                   |
| Delete Upper Limit Line     |                         |               |      |               |        | K/C                                   |
| Fail Sign                   | ON                      | <<            | <<   | *             |        | K/C                                   |
| Import Lower Limit Line ... |                         |               |      |               |        | K/C                                   |
| Import Upper Limit Line ... |                         |               |      |               |        | K/C                                   |
| Limit Line                  | ON                      | <<            | <<   | *             |        | K/C                                   |
| Limit Test                  | OFF                     | <<            | <<   | *             |        | K/C                                   |
| <b>Marker Information</b>   | Left                    | <<            | <<   | *             |        | K/C                                   |
| <b>Meas Condition</b>       | ON                      | <<            | <<   | *             |        | K/C                                   |
| <b>Relative Y-Scale</b>     | OFF                     | <<            | <<   | *             |        | K/C                                   |
| <b>Security Level</b>       | None                    | <<            | <<   | *             |        | K/C                                   |
| <b>Title Label</b>          | OFF                     | <<            | <<   | *             |        | K/C                                   |
| <b>Update</b>               | ON                      | <<            | <<   | *             |        | K/C                                   |
| <b>Y # of Digits</b>        | 4-digits                | <<            | <<   | *             |        | K/C                                   |
| <b>Format</b>               |                         |               |      |               |        |                                       |
| Detector Mode               | Positive                | <<            | <<   | *             |        | K/C                                   |
| Format                      | dBm                     | <<            | <<   | *             |        | K/C                                   |
| <b>Input Port</b>           |                         |               |      |               |        |                                       |
| Down Converter              |                         |               |      |               |        |                                       |
| Down Converter              | OFF                     | <<            | <<   | *             |        | K/C                                   |
| External Mixer              | Not Used                | <<            | <<   | *             |        | K/C                                   |
| RF Input                    | Down Converter          | <<            | <<   | *             |        | K/C                                   |
| <b>Macro Setup</b>          |                         |               |      |               |        |                                       |
| E5052 Event                 | OFF                     |               |      |               |        | K/C                                   |
| Echo Window Menu            |                         |               |      |               |        |                                       |
| Clear Echo                  |                         |               |      |               |        | K/C                                   |
| Echo Font Size              | 11                      |               |      |               |        | K/C                                   |
| Echo Window                 | OFF                     |               |      |               |        | K/C                                   |
| User Menu                   |                         |               |      |               |        |                                       |
| User Label 1                |                         |               |      |               |        | K/C                                   |
| <b>Marker</b>               |                         |               |      |               |        |                                       |
| Clear Marker Menu           |                         |               |      |               |        |                                       |
| Marker 1                    | OFF                     | <<            | <<   | *             |        | K/C                                   |
| Marker List                 | OFF                     | <<            | <<   | *             |        | K/C                                   |
| More Functions              |                         |               |      |               |        |                                       |
| Discrete                    | OFF                     | <<            | <<   | *             |        | K/C                                   |
| Ref Marker                  | 1                       | <<            | <<   | *             |        | K/C                                   |
| Ref Marker Mode             | OFF                     | <<            | <<   | *             |        | K/C                                   |

C. List of Default Values

List of Default Values  
SP Menu

| Key Operation          | Factory-shipped Setting | Default Value |      | Save / Recall | Backup | Available Means of Defining a Setting |
|------------------------|-------------------------|---------------|------|---------------|--------|---------------------------------------|
|                        |                         | Preset        | *RST |               |        |                                       |
| <b>Marker Function</b> |                         |               |      |               |        |                                       |
| Analysis Range (X)     | Band Marker             | <<            | <<   | *             |        | K/C                                   |
| Analysis Range (Y)     | Band Marker             | <<            | <<   | *             |        | K/C                                   |
| Analysis Type          | Off                     | <<            | <<   | *             |        | K/C                                   |
| <b>Band Marker X</b>   |                         |               |      |               |        |                                       |
| Band Marker X          | OFF                     | <<            | <<   | *             |        | K/C                                   |
| Center                 | 0 Hz                    |               |      |               |        | K/C                                   |
| Span                   | 2 THz                   |               |      |               |        | K/C                                   |
| Start                  | -1 THz                  | <<            | <<   | *             |        | K/C                                   |
| Stop                   | 1 THz                   | <<            | <<   | *             |        | K/C                                   |
| <b>Band Marker Y</b>   |                         |               |      |               |        |                                       |
| Band Marker Y          | OFF                     | <<            | <<   | *             |        | K/C                                   |
| Center                 | 0 dBm                   |               |      |               |        | K/C                                   |
| Span                   | 2 TdB                   |               |      |               |        | K/C                                   |
| Start                  | -1 TdBm                 | <<            | <<   | *             |        | K/C                                   |
| Stop                   | 1 TdBm                  | <<            | <<   | *             |        | K/C                                   |
| <b>Marker Search</b>   |                         |               |      |               |        |                                       |
| <b>Band Marker X</b>   |                         |               |      |               |        |                                       |
| Band Marker X          | OFF                     | <<            | <<   | *             |        | K/C                                   |
| Center                 | 0 Hz                    |               |      |               |        | K/C                                   |
| Span                   | 2 THz                   |               |      |               |        | K/C                                   |
| Start                  | -1 THz                  | <<            | <<   | *             |        | K/C                                   |
| Stop                   | 1 THz                   | <<            | <<   | *             |        | K/C                                   |
| <b>Band Marker Y</b>   |                         |               |      |               |        |                                       |
| Band Marker Y          | OFF                     | <<            | <<   | *             |        | K/C                                   |
| Center                 | 0 dBm                   |               |      |               |        | K/C                                   |
| Span                   | 2 TdB                   |               |      |               |        | K/C                                   |
| Start                  | -1 TdBm                 | <<            | <<   | *             |        | K/C                                   |
| Stop                   | 1 TdBm                  | <<            | <<   | *             |        | K/C                                   |
| <b>Peak</b>            |                         |               |      |               |        |                                       |
| Peak Excursion         | 0 dB                    | <<            | <<   | *             |        | K/C                                   |
| Peak Polarity          | Positive                | <<            | <<   | *             |        | K/C                                   |
| Search Left            |                         |               |      |               |        | K/C                                   |
| Search Peak            |                         |               |      |               |        | K/C                                   |
| Search Peak All        |                         |               |      |               |        | K/C                                   |
| Search Right           |                         |               |      |               |        | K/C                                   |
| Search Max             |                         |               |      |               |        | K/C                                   |
| Search Min             |                         |               |      |               |        | K/C                                   |
| Search Range (X)       | Full Range              | <<            | <<   | *             |        | K/C                                   |
| Search Range (Y)       | Full Range              | <<            | <<   | *             |        | K/C                                   |



| Key Operation           | Factory-shipped Setting | Default Value |      | Save / Recall | Backup | Available Means of Defining a Setting |
|-------------------------|-------------------------|---------------|------|---------------|--------|---------------------------------------|
|                         |                         | Preset        | *RST |               |        |                                       |
| <b>Target</b>           |                         |               |      |               |        |                                       |
| Search Left             |                         |               |      |               |        | K/C                                   |
| Search Right            |                         |               |      |               |        | K/C                                   |
| Search Target           |                         |               |      |               |        | K/C                                   |
| Search Transition       | Both                    | <<            | <<   | *             |        | K/C                                   |
| Search Value            | 0 dBm                   | <<            | <<   | *             |        | K/C                                   |
| Tracking                | Off                     | <<            | <<   | *             |        | K/C                                   |
| <b>Marker To</b>        |                         |               |      |               |        |                                       |
| Marker -> Center        |                         |               |      |               |        | K/C                                   |
| Marker -> Start         |                         |               |      |               |        | K/C                                   |
| Marker -> Stop          |                         |               |      |               |        | K/C                                   |
| <b>Measurement View</b> |                         |               |      |               |        |                                       |
| Freq & Power            | Selected Phase Noise    | <<            | <<   | *             |        | K/C                                   |
| Phase Noise             | Selected Phase Noise    | <<            | <<   | *             |        | K/C                                   |
| Show Window             |                         |               |      |               |        |                                       |
| Freq & Power            | ON                      | <<            | <<   | *             |        | K/C                                   |
| Phase Noise             | ON                      | <<            | <<   | *             |        | K/C                                   |
| Spectrum Monitor        | ON                      | <<            | <<   | *             |        | K/C                                   |
| Transient               | ON                      | <<            | <<   | *             |        | K/C                                   |
| User                    | OFF                     | <<            | <<   | *             |        | K/C                                   |
| Spectrum Monitor        | Selected Phase Noise    | <<            | <<   | *             |        | K/C                                   |
| Transient               | Selected Phase Noise    | <<            | <<   | *             |        | K/C                                   |
| User                    | Selected Phase Noise    | <<            | <<   | *             |        | K/C                                   |
| <b>Save/Recall</b>      |                         |               |      |               |        |                                       |
| Save State              |                         |               |      |               |        |                                       |
| Save Type               | State Only              |               |      |               |        | K/C                                   |
| <b>Scale</b>            |                         |               |      |               |        |                                       |
| Auto Scale              |                         |               |      |               |        | K/C                                   |
| Divisions               | 10                      | <<            | <<   | *             |        | K/C                                   |
| Marker -> Reference     |                         |               |      |               |        | K/C                                   |
| Reference Position      | 10 Div                  | <<            | <<   | *             |        | K/C                                   |
| Reference Value         | 10 dBm                  | <<            | <<   | *             |        | K/C                                   |
| Scale/Div               | 10 dB/Div               | <<            | <<   | *             |        | K/C                                   |
| X Axis                  |                         |               |      |               |        |                                       |
| Auto                    | ON                      | <<            | <<   | *             |        | K/C                                   |
| Band Marker -> X Axis   |                         |               |      |               |        | K/C                                   |
| Left                    | 992.5 MHz               | <<            | <<   | *             |        | K/C                                   |
| Right                   | 1.0075 GHz              | <<            | <<   | *             |        | K/C                                   |

C. List of Default Values

List of Default Values  
SP Menu

| Key Operation                 | Factory-shipped Setting | Default Value |      | Save / Recall | Backup | Available Means of Defining a Setting |
|-------------------------------|-------------------------|---------------|------|---------------|--------|---------------------------------------|
|                               |                         | Preset        | *RST |               |        |                                       |
| <b>Setup</b>                  |                         |               |      |               |        |                                       |
| Reference Level               | 5 dBm                   | <<            | <<   | *             |        | K/C                                   |
| <b>Start/Center</b>           |                         |               |      |               |        |                                       |
| Carrier To                    |                         |               |      |               |        |                                       |
| Carrier -> Center             |                         |               |      |               |        | K/C                                   |
| Carrier x # -> Center         |                         |               |      |               |        | K/C                                   |
| Carrier x 2 -> Center         |                         |               |      |               |        | K/C                                   |
| Carrier x 3 -> Center         |                         |               |      |               |        | K/C                                   |
| Frequency Band                | 300 M - 7 GHz           | <<            | <<   | *             |        | K/C                                   |
| Harmonic #                    | 4                       | <<            | <<   | *             |        | K                                     |
| Center                        | 1 GHz                   | <<            | <<   | *             |        | K/C                                   |
| Span                          | 15 MHz                  | <<            | <<   | *             |        | K/C                                   |
| Start                         | 992.5 MHz               | <<            | <<   | *             |        | K/C                                   |
| Stop                          | 1.0075 GHz              | <<            | <<   | *             |        | K/C                                   |
| <b>Stop/Span</b>              |                         |               |      |               |        |                                       |
| Carrier To                    |                         |               |      |               |        |                                       |
| Carrier -> Center             |                         |               |      |               |        | K/C                                   |
| Carrier x # -> Center         |                         |               |      |               |        | K/C                                   |
| Carrier x 2 -> Center         |                         |               |      |               |        | K/C                                   |
| Carrier x 3 -> Center         |                         |               |      |               |        | K/C                                   |
| Frequency Band                | 300 M - 7 GHz           | <<            | <<   | *             |        | K/C                                   |
| Harmonic #                    | 4                       | <<            | <<   | *             |        | K                                     |
| Center                        | 1 GHz                   | <<            | <<   | *             |        | K/C                                   |
| Span                          | 15 MHz                  | <<            | <<   | *             |        | K/C                                   |
| Start                         | 992.5 MHz               | <<            | <<   | *             |        | K/C                                   |
| Stop                          | 1.0075 GHz              | <<            | <<   | *             |        | K/C                                   |
| <b>System</b>                 |                         |               |      |               |        |                                       |
| Abort Printing                |                         |               |      |               |        | K/C                                   |
| Backlight                     | ON                      |               |      |               |        | K/C                                   |
| Dump Screen Image...          |                         |               |      |               |        | K                                     |
| <b>Instrument Setup</b>       |                         |               |      |               |        |                                       |
| Correction                    |                         |               |      |               |        |                                       |
| File Dialog...                |                         |               |      |               |        | K/C                                   |
| Import Power Correction Table |                         |               |      |               |        | K/C                                   |
| Power Correction              | OFF                     | <<            | <<   | *             |        | K/C                                   |

| Key Operation                             | Factory-shipped Setting    | Default Value |      | Save / Recall | Backup | Available Means of Defining a Setting |
|-------------------------------------------|----------------------------|---------------|------|---------------|--------|---------------------------------------|
|                                           |                            | Preset        | *RST |               |        |                                       |
| <b>Down Converter Manual Setup</b>        |                            |               |      |               |        |                                       |
| Current                                   | 0 A                        | <<            | <<   | *             |        | K/C                                   |
| Current                                   | 0 A                        | <<            | <<   | *             |        | K/C                                   |
| IF Gain 1                                 | 0 dB                       | <<            | <<   | *             |        | K/C                                   |
| IF Gain 2                                 | 0 dB                       | <<            | <<   | *             |        | K/C                                   |
| LO1 Frequency                             | 2.975 GHz                  | <<            | <<   | *             |        | K/C                                   |
| LO1 Level                                 | 10 dBm                     | <<            | <<   | *             |        | K/C                                   |
| LO2 Frequency                             | 2.975 GHz                  | <<            | <<   | *             |        | K/C                                   |
| LO2 Level                                 | 10 dBm                     | <<            | <<   | *             |        | K/C                                   |
| Mixer 1 Bias                              | OFF                        | <<            | <<   | *             |        | K/C                                   |
| Mixer 2 Bias                              | OFF                        | <<            | <<   | *             |        | K/C                                   |
| $\Delta$ IF = IF2 - IF1                   | 0 Hz                       | <<            | <<   | *             |        | K/C                                   |
| <b>Frequency Offset (User Down Conv.)</b> |                            |               |      |               |        |                                       |
| Conversion Mode                           | $RF = n * LO + IF$         | <<            | <<   | *             |        | K/C                                   |
| Frequency Offset                          | OFF                        | <<            | <<   | *             |        | K/C                                   |
| Harmonic #                                | 1                          | <<            | <<   | *             |        | K/C                                   |
| LO Frequency                              | 3 GHz                      | <<            | <<   | *             |        | K/C                                   |
| <b>Invert Image</b>                       | OFF                        | <<            | <<   | *             |        | K/C                                   |
| <b>Misc Setup</b>                         |                            |               |      |               |        |                                       |
| <b>Beeper</b>                             |                            |               |      |               |        |                                       |
| Beep Complete                             | ON                         | <<            | <<   | *             |        | K/C                                   |
| Beep Warning                              | OFF                        | <<            | <<   | *             |        | K/C                                   |
| Test Beep Complete                        |                            |               |      |               |        | K/C                                   |
| Test Beep Warning                         |                            |               |      |               |        | K/C                                   |
| <b>Clock Setup</b>                        |                            |               |      |               |        |                                       |
| Set Date and Time                         |                            |               |      |               |        | K                                     |
| Show Clock                                | ON                         | <<            | <<   | *             |        | K/C                                   |
| <b>Color Setup</b>                        |                            |               |      |               |        |                                       |
| <b>Invert</b>                             |                            |               |      |               |        |                                       |
| Background                                | Red:255 Green:255 Blue:255 | <<            | <<   | *             |        | K/C                                   |
| Data Trace 1                              | Red:0 Green:0 Blue:255     | <<            | <<   | *             |        | K/C                                   |
| Data Trace 2                              | Red:255 Green:0 Blue:0     | <<            | <<   | *             |        | K/C                                   |
| Data Trace 3                              | Red:255 Green:0 Blue:255   | <<            | <<   | *             |        | K/C                                   |
| Data Trace 4                              | Red:0 Green:255 Blue:0     | <<            | <<   | *             |        | K/C                                   |
| Data Trace 5                              | Red:0 Green:0 Blue:255     | <<            | <<   | *             |        | K/C                                   |
| Data Trace 6                              | Red:255 Green:0 Blue:0     | <<            | <<   | *             |        | K/C                                   |
| Data Trace 7                              | Red:255 Green:0 Blue:255   | <<            | <<   | *             |        | K/C                                   |

C. List of Default Values

List of Default Values  
SP Menu

| Key Operation  | Factory-shipped Setting    | Default Value |      | Save / Recall | Backup | Available Means of Defining a Setting |
|----------------|----------------------------|---------------|------|---------------|--------|---------------------------------------|
|                |                            | Preset        | *RST |               |        |                                       |
| Data Trace 8   | Red:0 Green:255 Blue:0     | <<            | <<   | *             |        | K/C                                   |
| Graticule Main | Red:128 Green:128 Blue:128 | <<            | <<   | *             |        | K/C                                   |
| Graticule Sub  | Red:192 Green:192 Blue:192 | <<            | <<   | *             |        | K/C                                   |
| Limit Fail     | Red:0 Green:255 Blue:255   | <<            | <<   | *             |        | K/C                                   |
| Limit Line     | Red:95 Green:223 Blue:223  | <<            | <<   | *             |        | K/C                                   |
| Mem Trace 1    | Red:128 Green:128 Blue:255 | <<            | <<   | *             |        | K/C                                   |
| Mem Trace 2    | Red:255 Green:128 Blue:128 | <<            | <<   | *             |        | K/C                                   |
| Mem Trace 3    | Red:255 Green:128 Blue:255 | <<            | <<   | *             |        | K/C                                   |
| Mem Trace 4    | Red:128 Green:255 Blue:128 | <<            | <<   | *             |        | K/C                                   |
| Mem Trace 5    | Red:128 Green:128 Blue:255 | <<            | <<   | *             |        | K/C                                   |
| Mem Trace 6    | Red:255 Green:128 Blue:128 | <<            | <<   | *             |        | K/C                                   |
| Mem Trace 7    | Red:255 Green:128 Blue:255 | <<            | <<   | *             |        | K/C                                   |
| Mem Trace 8    | Red:128 Green:255 Blue:128 | <<            | <<   | *             |        | K/C                                   |
| Reset Color    |                            |               |      |               |        | K/C                                   |
| <b>Normal</b>  |                            |               |      |               |        |                                       |
| Background     | Red:0 Green:0 Blue:0       | <<            | <<   | *             |        | K/C                                   |
| Data Trace 1   | Red:255 Green:255 Blue:0   | <<            | <<   | *             |        | K/C                                   |
| Data Trace 2   | Red:0 Green:255 Blue:255   | <<            | <<   | *             |        | K/C                                   |
| Data Trace 3   | Red:0 Green:255 Blue:0     | <<            | <<   | *             |        | K/C                                   |
| Data Trace 4   | Red:255 Green:0 Blue:255   | <<            | <<   | *             |        | K/C                                   |
| Data Trace 5   | Red:255 Green:255 Blue:0   | <<            | <<   | *             |        | K/C                                   |
| Data Trace 6   | Red:0 Green:255 Blue:255   | <<            | <<   | *             |        | K/C                                   |
| Data Trace 7   | Red:0 Green:255 Blue:0     | <<            | <<   | *             |        | K/C                                   |
| Data Trace 8   | Red:255 Green:0 Blue:255   | <<            | <<   | *             |        | K/C                                   |
| Graticule Main | Red:127 Green:127 Blue:127 | <<            | <<   | *             |        | K/C                                   |
| Graticule Sub  | Red:63 Green:63 Blue:63    | <<            | <<   | *             |        | K/C                                   |
| Limit Fail     | Red:255 Green:0 Blue:0     | <<            | <<   | *             |        | K/C                                   |
| Limit Line     | Red:160 Green:32 Blue:32   | <<            | <<   | *             |        | K/C                                   |
| Mem Trace 1    | Red:127 Green:127 Blue:0   | <<            | <<   | *             |        | K/C                                   |
| Mem Trace 2    | Red:0 Green:127 Blue:127   | <<            | <<   | *             |        | K/C                                   |
| Mem Trace 3    | Red:0 Green:127 Blue:0     | <<            | <<   | *             |        | K/C                                   |
| Mem Trace 4    | Red:127 Green:0 Blue:127   | <<            | <<   | *             |        | K/C                                   |
| Mem Trace 5    | Red:127 Green:127 Blue:0   | <<            | <<   | *             |        | K/C                                   |
| Mem Trace 6    | Red:0 Green:127 Blue:127   | <<            | <<   | *             |        | K/C                                   |
| Mem Trace 7    | Red:0 Green:127 Blue:0     | <<            | <<   | *             |        | K/C                                   |
| Mem Trace 8    | Red:127 Green:0 Blue:127   | <<            | <<   | *             |        | K/C                                   |
| Reset Color    |                            |               |      |               |        | K/C                                   |

| Key Operation                   | Factory-shipped Setting | Default Value |      | Save / Recall | Backup | Available Means of Defining a Setting |
|---------------------------------|-------------------------|---------------|------|---------------|--------|---------------------------------------|
|                                 |                         | Preset        | *RST |               |        |                                       |
| Control Panel                   |                         |               |      |               |        | K                                     |
| GPIB Setup                      |                         |               |      |               |        |                                       |
| System Controller Configuration |                         |               |      |               |        |                                       |
| Talker/Listener Address         | 17                      | <<            | <<   | *             |        | K/C                                   |
| Key Lock                        |                         |               |      |               |        |                                       |
| Front Panel & Keyboard Lock     | OFF                     | <<            | <<   | *             |        | K/C                                   |
| Touch Screen & Mouse Lock       | OFF                     | <<            | <<   | *             |        | K/C                                   |
| Network Setup                   |                         |               |      |               |        |                                       |
| MAC Address                     |                         |               |      |               |        |                                       |
| Network Configuration...        |                         |               |      |               |        | K                                     |
| Network Identification...       |                         |               |      |               |        | K                                     |
| SICL-LAN Address                | 17                      | <<            | <<   | *             |        | K/C                                   |
| SICL-LAN Server                 | OFF                     | <<            | <<   | *             |        | K/C                                   |
| Socket Server                   | OFF                     | <<            | <<   | *             |        | K/C                                   |
| Telnet Server                   | OFF                     | <<            | <<   | *             |        | K/C                                   |
| Print                           |                         |               |      |               |        | K                                     |
| Printer Setup...                |                         |               |      |               |        | K                                     |
| Product Information             |                         |               |      |               |        | K                                     |
| Trace View                      |                         |               |      |               |        |                                       |
| Aperture                        | 1.5 %                   | <<            | <<   | *             |        | K/C                                   |
| Copy to User                    |                         |               |      |               |        | K/C                                   |
| Data Hold                       | Off                     | <<            | <<   | *             |        | K/C                                   |
| Data Math                       | Off                     | <<            | <<   | *             |        | K/C                                   |
| Display Trace                   | Data                    | <<            | <<   | *             |        | K/C                                   |
| Marker -> -Offset               |                         |               |      |               |        | K/C                                   |
| Offset                          | 0 dBm                   | <<            | <<   | *             |        | K/C                                   |
| Persistence                     |                         |               |      |               |        |                                       |
| Clear Persistent Data           |                         |               |      |               |        | K/C                                   |
| Persistence Mode                | OFF                     | <<            | <<   | *             |        | K/C                                   |
| Smoothing                       | OFF                     | <<            | <<   | *             |        | K/C                                   |
| Trace Label                     | "Spectrum"              | <<            | <<   | *             |        | K/C                                   |

C. List of Default Values

List of Default Values  
**SP Menu**

| Key Operation                      | Factory-shipped Setting | Default Value |      | Save / Recall | Backup | Available Means of Defining a Setting |
|------------------------------------|-------------------------|---------------|------|---------------|--------|---------------------------------------|
|                                    |                         | Preset        | *RST |               |        |                                       |
| <b>Trigger</b>                     |                         |               |      |               |        |                                       |
| <b>Average Trigger</b>             | OFF                     |               |      | *             |        | K/C                                   |
| <b>Ext Trig Polarity</b>           | Negative                | <<            | <<   | *             |        | K/C                                   |
| <b>Source</b>                      | Internal                | <<            | <<   | *             |        | K/C                                   |
| <b>Trigger to Spectrum Monitor</b> | Selected Phase Noise    | <<            | <<   | *             |        | K/C                                   |

## TR Menu

| Key Operation             | Factory-shipped Setting | Default Value |      | Save / Recall | Backup | Available Means of Defining a Setting |
|---------------------------|-------------------------|---------------|------|---------------|--------|---------------------------------------|
|                           |                         | Preset        | *RST |               |        |                                       |
| <b>Attenuator</b>         |                         |               |      |               |        |                                       |
| Input Attenuator          | 5 dB                    | <<            | <<   | *             |        | K/C                                   |
| <b>Average</b>            |                         |               |      |               |        |                                       |
| Averaging                 | OFF                     | <<            | <<   | *             |        | K/C                                   |
| Averaging Restart         |                         |               |      |               |        | K/C                                   |
| Avg Factor                | 16                      | <<            | <<   | *             |        | K/C                                   |
| <b>DC Control Voltage</b> |                         |               |      |               |        |                                       |
| <b>Auto Freq Control</b>  |                         |               |      |               |        |                                       |
| AFC Status                | OFF                     | <<            | <<   | *             |        | K/C                                   |
| Frequency Band            | 300 M - 7 GHz           | <<            | <<   | *             |        | K/C                                   |
| Max Ctrl Voltage Limit    | 35 V                    | <<            | <<   | *             |        | K/C                                   |
| Max Input Level           | 0 dBm                   | <<            | <<   | *             |        | K/C                                   |
| Max Iteration             | 10                      | <<            | <<   | *             |        | K/C                                   |
| Min Ctrl Voltage Limit    | -15 V                   | <<            | <<   | *             |        | K/C                                   |
| Sensitivity               | 10 MHz/V                | <<            | <<   | *             |        | K/C                                   |
| Target                    | 1 GHz                   | <<            | <<   | *             |        | K/C                                   |
| Tolerance                 | 1 kHz                   | <<            | <<   | *             |        | K/C                                   |
| Control Voltage Cal       | OFF                     | <<            | <<   |               |        | K/C                                   |
| DC Control Delay          | 100 ms                  | <<            | <<   | *             |        | K/C                                   |
| DC Control Output         | OFF                     | <<            | <<   |               |        | K/C                                   |
| DC Control Voltage        | 0 V                     | <<            | <<   | *             |        | K/C                                   |
| Max Ctrl Voltage Limit    | 35 V                    | <<            | <<   | *             |        | K/C                                   |
| Min Ctrl Voltage Limit    | -15 V                   | <<            | <<   | *             |        | K/C                                   |
| <b>DC Power Voltage</b>   |                         |               |      |               |        |                                       |
| DC Power Delay            | 100 ms                  | <<            | <<   | *             |        | K/C                                   |
| DC Power Output           | OFF                     | <<            | <<   |               |        | K/C                                   |
| DC Power Voltage          | 0 V                     | <<            | <<   | *             |        | K/C                                   |
| Max Pwr Voltage Limit     | 16 V                    | <<            | <<   | *             |        | K/C                                   |
| Min Pwr Voltage Limit     | 0 V                     | <<            | <<   | *             |        | K/C                                   |
| <b>Display</b>            |                         |               |      |               |        |                                       |
| Edit Title Label          | ""                      | <<            | <<   | *             |        | K/C                                   |
| Color Type                | "Normal"                | <<            | <<   | *             |        | K/C                                   |

List of Default Values  
TR Menu

| Key Operation               | Factory-shipped Setting | Default Value |      | Save / Recall | Backup | Avaible Means of Defining a Setting |
|-----------------------------|-------------------------|---------------|------|---------------|--------|-------------------------------------|
|                             |                         | Preset        | *RST |               |        |                                     |
| <b>Limit Test</b>           |                         |               |      |               |        |                                     |
| Delete Lower Limit Line     |                         |               |      |               |        | K/C                                 |
| Delete Upper Limit Line     |                         |               |      |               |        | K/C                                 |
| Fail Sign                   | ON                      | <<            | <<   | *             |        | K/C                                 |
| Import Lower Limit Line ... |                         |               |      |               |        | K/C                                 |
| Import Upper Limit Line ... |                         |               |      |               |        | K/C                                 |
| Limit Line                  | ON                      | <<            | <<   | *             |        | K/C                                 |
| Limit Test                  | OFF                     | <<            | <<   | *             |        | K/C                                 |
| Marker Information          | Left                    | <<            | <<   | *             |        | K/C                                 |
| Meas Condition              | ON                      | <<            | <<   | *             |        | K/C                                 |
| Relative Y-Scale            | OFF                     | <<            | <<   | *             |        | K/C                                 |
| Security Level              | None                    | <<            | <<   | *             |        | K/C                                 |
| Title Label                 | OFF                     | <<            | <<   | *             |        | K/C                                 |
| Update                      | ON                      | <<            | <<   | *             |        | K/C                                 |
| Y # of Digits               | 4-digits                | <<            | <<   | *             |        | K/C                                 |
| <b>Format</b>               |                         |               |      |               |        |                                     |
| Frequency Format            | Hz                      | <<            | <<   | *             |        | K/C                                 |
| Frequency Reference         | 0 Hz                    | <<            | <<   | *             |        | K/C                                 |
| Marker -> Phase X Reference |                         |               |      |               |        | K/C                                 |
| Phase Unit                  | Deg                     | <<            | <<   | *             |        | K/C                                 |
| Phase X Reference           | 11.0096 s               | <<            | <<   | *             |        | K/C                                 |
| Wrap Phase                  | ON                      | <<            | <<   | *             |        | K/C                                 |
| <b>Input Port</b>           |                         |               |      |               |        |                                     |
| Down Converter              |                         |               |      |               |        |                                     |
| Down Converter              | OFF                     | <<            | <<   | *             |        | K/C                                 |
| External Mixer              | Not Used                | <<            | <<   | *             |        | K/C                                 |
| RF Input                    | Down Converter          | <<            | <<   | *             |        | K/C                                 |
| <b>Macro Setup</b>          |                         |               |      |               |        |                                     |
| E5052 Event                 | OFF                     |               |      |               |        | K/C                                 |
| Echo Window Menu            |                         |               |      |               |        |                                     |
| Clear Echo                  |                         |               |      |               |        | K/C                                 |
| Echo Font Size              | 11                      |               |      |               |        | K/C                                 |
| Echo Window                 | OFF                     |               |      |               |        | K/C                                 |
| User Menu                   |                         |               |      |               |        |                                     |
| User Label 1                |                         |               |      |               |        | K/C                                 |



| Key Operation            | Factory-shipped Setting | Default Value |      | Save / Recall | Backup | Available Means of Defining a Setting |
|--------------------------|-------------------------|---------------|------|---------------|--------|---------------------------------------|
|                          |                         | Preset        | *RST |               |        |                                       |
| <b>Marker</b>            |                         |               |      |               |        |                                       |
| <b>Clear Marker Menu</b> |                         |               |      |               |        |                                       |
| Marker 1                 | OFF                     | <<            | <<   | *             |        | K/C                                   |
| Couple                   | OFF                     | <<            | <<   | *             |        | K/C                                   |
| Marker List              | OFF                     | <<            | <<   | *             |        | K/C                                   |
| <b>More Functions</b>    |                         |               |      |               |        |                                       |
| Discrete                 | OFF                     | <<            | <<   | *             |        | K/C                                   |
| Ref Marker               | 1                       | <<            | <<   | *             |        | K/C                                   |
| Ref Marker Mode          | OFF                     | <<            | <<   | *             |        | K/C                                   |
| <b>Marker Function</b>   |                         |               |      |               |        |                                       |
| Analysis Range (X)       | Band Marker             | <<            | <<   | *             |        | K/C                                   |
| Analysis Range (Y)       | Band Marker             | <<            | <<   | *             |        | K/C                                   |
| Analysis Type            | Off                     | <<            | <<   | *             |        | K/C                                   |
| <b>Band Marker X</b>     |                         |               |      |               |        |                                       |
| Band Marker X            | OFF                     | <<            | <<   | *             |        | K/C                                   |
| Center                   | 0 s                     |               |      |               |        | K/C                                   |
| Span                     | 2 Ts                    |               |      |               |        | K/C                                   |
| Start                    | -1 Ts                   | <<            | <<   | *             |        | K/C                                   |
| Stop                     | 1 Ts                    | <<            | <<   | *             |        | K/C                                   |
| <b>Band Marker Y</b>     |                         |               |      |               |        |                                       |
| Band Marker Y            | OFF                     | <<            | <<   | *             |        | K/C                                   |
| Center                   | 0 Hz                    |               |      |               |        | K/C                                   |
| Span                     | 2 THz                   |               |      |               |        | K/C                                   |
| Start                    | -1 THz                  | <<            | <<   | *             |        | K/C                                   |
| Stop                     | 1 THz                   | <<            | <<   | *             |        | K/C                                   |
| Couple                   | OFF                     | <<            | <<   | *             |        | K/C                                   |
| <b>Marker Search</b>     |                         |               |      |               |        |                                       |
| <b>Band Marker X</b>     |                         |               |      |               |        |                                       |
| Band Marker X            | OFF                     | <<            | <<   | *             |        | K/C                                   |
| Center                   | 0 s                     |               |      |               |        | K/C                                   |
| Span                     | 2 Ts                    |               |      |               |        | K/C                                   |
| Start                    | -1 Ts                   | <<            | <<   | *             |        | K/C                                   |
| Stop                     | 1 Ts                    | <<            | <<   | *             |        | K/C                                   |
| <b>Band Marker Y</b>     |                         |               |      |               |        |                                       |
| Band Marker Y            | OFF                     | <<            | <<   | *             |        | K/C                                   |
| Center                   | 0 Hz                    |               |      |               |        | K/C                                   |
| Span                     | 2 THz                   |               |      |               |        | K/C                                   |
| Start                    | -1 THz                  | <<            | <<   | *             |        | K/C                                   |
| Stop                     | 1 THz                   | <<            | <<   | *             |        | K/C                                   |
| Couple                   | OFF                     | <<            | <<   | *             |        | K/C                                   |

C. List of Default Values

List of Default Values  
TR Menu

| Key Operation             | Factory-shipped Setting | Default Value |      | Save / Recall | Backup | Available Means of Defining a Setting |
|---------------------------|-------------------------|---------------|------|---------------|--------|---------------------------------------|
|                           |                         | Preset        | *RST |               |        |                                       |
| <b>Peak</b>               |                         |               |      |               |        |                                       |
| Peak Excursion            | 0 Hz                    | <<            | <<   | *             |        | K/C                                   |
| Peak Polarity             | Positive                | <<            | <<   | *             |        | K/C                                   |
| Search Left               |                         |               |      |               |        | K/C                                   |
| Search Peak               |                         |               |      |               |        | K/C                                   |
| Search Peak All           |                         |               |      |               |        | K/C                                   |
| Search Right              |                         |               |      |               |        | K/C                                   |
| Search Max                |                         |               |      |               |        | K/C                                   |
| Search Min                |                         |               |      |               |        | K/C                                   |
| Search Range (X)          | Full Range              | <<            | <<   | *             |        | K/C                                   |
| Search Range (Y)          | Full Range              | <<            | <<   | *             |        | K/C                                   |
| <b>Target</b>             |                         |               |      |               |        |                                       |
| Search Left               |                         |               |      |               |        | K/C                                   |
| Search Right              |                         |               |      |               |        | K/C                                   |
| Search Target             |                         |               |      |               |        | K/C                                   |
| Search Transition         | Both                    | <<            | <<   | *             |        | K/C                                   |
| Search Value              | 0 Hz                    | <<            | <<   | *             |        | K/C                                   |
| Tracking                  | Off                     | <<            | <<   | *             |        | K/C                                   |
| <b>Marker To</b>          |                         |               |      |               |        |                                       |
| Marker -> Phase Reference |                         |               |      |               |        | K/C                                   |
| Marker -> Target Freq     |                         |               |      |               |        | K/C                                   |
| <b>Measurement View</b>   |                         |               |      |               |        |                                       |
| Freq & Power              | Selected Phase Noise    | <<            | <<   | *             |        | K/C                                   |
| Phase Noise               | Selected Phase Noise    | <<            | <<   | *             |        | K/C                                   |
| <b>Show Window</b>        |                         |               |      |               |        |                                       |
| Freq & Power              | ON                      | <<            | <<   | *             |        | K/C                                   |
| Phase Noise               | ON                      | <<            | <<   | *             |        | K/C                                   |
| Spectrum Monitor          | ON                      | <<            | <<   | *             |        | K/C                                   |
| Transient                 | ON                      | <<            | <<   | *             |        | K/C                                   |
| User                      | OFF                     | <<            | <<   | *             |        | K/C                                   |
| Spectrum Monitor          | Selected Phase Noise    | <<            | <<   | *             |        | K/C                                   |
| Transient                 | Selected Phase Noise    | <<            | <<   | *             |        | K/C                                   |
| User                      | Selected Phase Noise    | <<            | <<   | *             |        | K/C                                   |
| <b>Save/Recall</b>        |                         |               |      |               |        |                                       |
| Save State                |                         |               |      |               |        |                                       |
| Save Type                 | State Only              |               |      |               |        | K/C                                   |

| Key Operation           | Factory-shipped Setting | Default Value |      | Save / Recall | Backup | Available Means of Defining a Setting |
|-------------------------|-------------------------|---------------|------|---------------|--------|---------------------------------------|
|                         |                         | Preset        | *RST |               |        |                                       |
| <b>Scale</b>            |                         |               |      |               |        |                                       |
| Auto Scale              |                         |               |      |               |        | K/C                                   |
| Auto Scale All          |                         |               |      |               |        | K/C                                   |
| Divisions               | 10                      | <<            | <<   | *             |        | K/C                                   |
| Marker -> Reference     |                         |               |      |               |        | K/C                                   |
| Reference Position      | 5 Div                   | <<            | <<   | *             |        | K/C                                   |
| Reference Value         | 800 MHz                 | <<            | <<   | *             |        | K/C                                   |
| Scale/Div               | 80 MHz/Div              | <<            | <<   | *             |        | K/C                                   |
| <b>X Axis</b>           |                         |               |      |               |        |                                       |
| Auto                    | ON                      | <<            | <<   | *             |        | K/C                                   |
| Band Marker -> X Axis   |                         |               |      |               |        | K/C                                   |
| Left                    | -50 ms                  | <<            | <<   | *             |        | K/C                                   |
| Right                   | 50 ms                   | <<            | <<   | *             |        | K/C                                   |
| <b>Setup</b>            |                         |               |      |               |        |                                       |
| Freq Range              | 25.6 MHz                | <<            | <<   | *             |        | K/C                                   |
| Max Input Level         | 0 dBm                   | <<            | <<   | *             |        | K/C                                   |
| Phase Reference         | 1 GHz                   | <<            | <<   | *             |        | K/C                                   |
| Recalc Phase Reference  |                         |               |      |               |        |                                       |
| Phase Ref. Offset       | 0 Hz                    | <<            | <<   | *             |        | K/C                                   |
| Target Freq             | 1 GHz                   | <<            | <<   | *             |        | K/C                                   |
| <b>Video Trigger</b>    |                         |               |      |               |        |                                       |
| Minimum Power Level     | -20 dB                  | <<            | <<   | *             |        | K/C                                   |
| Narrow Freq             | 1 GHz                   | <<            | <<   | *             |        | K/C                                   |
| Wide Freq               | 1 GHz                   | <<            | <<   | *             |        | K/C                                   |
| Wide Freq Range         | 400 M - 1.2 GHz         | <<            | <<   | *             |        | K/C                                   |
| Wide Max Frequency      | 1.2 GHz                 | <<            | <<   | *             |        | K/C                                   |
| <b>Span</b>             |                         |               |      |               |        |                                       |
| Narrow Ref Position     | Center                  | <<            | <<   | *             |        | K/C                                   |
| Narrow Settings -> Wide |                         |               |      |               |        | K/C                                   |
| Narrow Span             | 100 ms                  | <<            | <<   | *             |        | K/C                                   |
| Narrow Time Offset      | 0 s                     | <<            | <<   | *             |        | K/C                                   |
| Wide Ref Position       | Center                  | <<            | <<   | *             |        | K/C                                   |
| Wide Settings -> Narrow |                         |               |      |               |        | K/C                                   |
| Wide Span               | 100 ms                  | <<            | <<   | *             |        | K/C                                   |
| Wide Time Offset        | 0 s                     | <<            | <<   | *             |        | K/C                                   |

C. List of Default Values

List of Default Values  
TR Menu

| Key Operation                             | Factory-shipped Setting | Default Value |      | Save / Recall | Backup | Available Means of Defining a Setting |
|-------------------------------------------|-------------------------|---------------|------|---------------|--------|---------------------------------------|
|                                           |                         | Preset        | *RST |               |        |                                       |
| <b>System</b>                             |                         |               |      |               |        |                                       |
| Abort Printing                            |                         |               |      |               |        | K/C                                   |
| Backlight                                 | ON                      |               |      |               |        | K/C                                   |
| Dump Screen Image...                      |                         |               |      |               |        | K                                     |
| <b>Instrument Setup</b>                   |                         |               |      |               |        |                                       |
| <b>Correction</b>                         |                         |               |      |               |        |                                       |
| File Dialog...                            |                         |               |      |               |        | K/C                                   |
| Import Power Correction Table             |                         |               |      |               |        | K/C                                   |
| Power Correction                          | OFF                     | <<            | <<   | *             |        | K/C                                   |
| <b>Down Converter Manual Setup</b>        |                         |               |      |               |        |                                       |
| Current                                   | 0 A                     | <<            | <<   | *             |        | K/C                                   |
| Current                                   | 0 A                     | <<            | <<   | *             |        | K/C                                   |
| IF Gain 1                                 | 0 dB                    | <<            | <<   | *             |        | K/C                                   |
| IF Gain 2                                 | 0 dB                    | <<            | <<   | *             |        | K/C                                   |
| LO1 Frequency                             | 2.975 GHz               | <<            | <<   | *             |        | K/C                                   |
| LO1 Level                                 | 10 dBm                  | <<            | <<   | *             |        | K/C                                   |
| LO2 Frequency                             | 2.975 GHz               | <<            | <<   | *             |        | K/C                                   |
| LO2 Level                                 | 10 dBm                  | <<            | <<   | *             |        | K/C                                   |
| Mixer 1 Bias                              | OFF                     | <<            | <<   | *             |        | K/C                                   |
| Mixer 2 Bias                              | OFF                     | <<            | <<   | *             |        | K/C                                   |
| $\Delta F = IF2 - IF1$                    | 0 Hz                    | <<            | <<   | *             |        | K/C                                   |
| <b>Frequency Offset (User Down Conv.)</b> |                         |               |      |               |        |                                       |
| Conversion Mode                           | $RF = n * LO + IF$      | <<            | <<   | *             |        | K/C                                   |
| Frequency Offset                          | OFF                     | <<            | <<   | *             |        | K/C                                   |
| Harmonic #                                | 1                       | <<            | <<   | *             |        | K/C                                   |
| LO Frequency                              | 3 GHz                   | <<            | <<   | *             |        | K/C                                   |
| Invert Image                              | OFF                     | <<            | <<   | *             |        | K/C                                   |
| <b>Misc Setup</b>                         |                         |               |      |               |        |                                       |
| <b>Beeper</b>                             |                         |               |      |               |        |                                       |
| Beep Complete                             | ON                      | <<            | <<   | *             |        | K/C                                   |
| Beep Warning                              | OFF                     | <<            | <<   | *             |        | K/C                                   |
| Test Beep Complete                        |                         |               |      |               |        | K/C                                   |
| Test Beep Warning                         |                         |               |      |               |        | K/C                                   |

| Key Operation      | Factory-shipped Setting    | Default Value |      | Save / Recall | Backup | Avaible Means of Defining a Setting |
|--------------------|----------------------------|---------------|------|---------------|--------|-------------------------------------|
|                    |                            | Preset        | *RST |               |        |                                     |
| <b>Clock Setup</b> |                            |               |      |               |        |                                     |
| Set Date and Time  |                            |               |      |               |        | K                                   |
| Show Clock         | ON                         | <<            | <<   | *             |        | K/C                                 |
| <b>Color Setup</b> |                            |               |      |               |        |                                     |
| <b>Invert</b>      |                            |               |      |               |        |                                     |
| Background         | Red:255 Green:255 Blue:255 | <<            | <<   | *             |        | K/C                                 |
| Data Trace 1       | Red:0 Green:0 Blue:255     | <<            | <<   | *             |        | K/C                                 |
| Data Trace 2       | Red:255 Green:0 Blue:0     | <<            | <<   | *             |        | K/C                                 |
| Data Trace 3       | Red:255 Green:0 Blue:255   | <<            | <<   | *             |        | K/C                                 |
| Data Trace 4       | Red:0 Green:255 Blue:0     | <<            | <<   | *             |        | K/C                                 |
| Data Trace 5       | Red:0 Green:0 Blue:255     | <<            | <<   | *             |        | K/C                                 |
| Data Trace 6       | Red:255 Green:0 Blue:0     | <<            | <<   | *             |        | K/C                                 |
| Data Trace 7       | Red:255 Green:0 Blue:255   | <<            | <<   | *             |        | K/C                                 |
| Data Trace 8       | Red:0 Green:255 Blue:0     | <<            | <<   | *             |        | K/C                                 |
| Graticule Main     | Red:128 Green:128 Blue:128 | <<            | <<   | *             |        | K/C                                 |
| Graticule Sub      | Red:192 Green:192 Blue:192 | <<            | <<   | *             |        | K/C                                 |
| Limit Fail         | Red:0 Green:255 Blue:255   | <<            | <<   | *             |        | K/C                                 |
| Limit Line         | Red:95 Green:223 Blue:223  | <<            | <<   | *             |        | K/C                                 |
| Mem Trace 1        | Red:128 Green:128 Blue:255 | <<            | <<   | *             |        | K/C                                 |
| Mem Trace 2        | Red:255 Green:128 Blue:128 | <<            | <<   | *             |        | K/C                                 |
| Mem Trace 3        | Red:255 Green:128 Blue:255 | <<            | <<   | *             |        | K/C                                 |
| Mem Trace 4        | Red:128 Green:255 Blue:128 | <<            | <<   | *             |        | K/C                                 |
| Mem Trace 5        | Red:128 Green:128 Blue:255 | <<            | <<   | *             |        | K/C                                 |
| Mem Trace 6        | Red:255 Green:128 Blue:128 | <<            | <<   | *             |        | K/C                                 |
| Mem Trace 7        | Red:255 Green:128 Blue:255 | <<            | <<   | *             |        | K/C                                 |
| Mem Trace 8        | Red:128 Green:255 Blue:128 | <<            | <<   | *             |        | K/C                                 |
| Reset Color        |                            |               |      |               |        | K/C                                 |
| <b>Normal</b>      |                            |               |      |               |        |                                     |
| Background         | Red:0 Green:0 Blue:0       | <<            | <<   | *             |        | K/C                                 |
| Data Trace 1       | Red:255 Green:255 Blue:0   | <<            | <<   | *             |        | K/C                                 |
| Data Trace 2       | Red:0 Green:255 Blue:255   | <<            | <<   | *             |        | K/C                                 |
| Data Trace 3       | Red:0 Green:255 Blue:0     | <<            | <<   | *             |        | K/C                                 |
| Data Trace 4       | Red:255 Green:0 Blue:255   | <<            | <<   | *             |        | K/C                                 |
| Data Trace 5       | Red:255 Green:255 Blue:0   | <<            | <<   | *             |        | K/C                                 |
| Data Trace 6       | Red:0 Green:255 Blue:255   | <<            | <<   | *             |        | K/C                                 |
| Data Trace 7       | Red:0 Green:255 Blue:0     | <<            | <<   | *             |        | K/C                                 |
| Data Trace 8       | Red:255 Green:0 Blue:255   | <<            | <<   | *             |        | K/C                                 |
| Graticule Main     | Red:127 Green:127 Blue:127 | <<            | <<   | *             |        | K/C                                 |
| Graticule Sub      | Red:63 Green:63 Blue:63    | <<            | <<   | *             |        | K/C                                 |
| Limit Fail         | Red:255 Green:0 Blue:0     | <<            | <<   | *             |        | K/C                                 |

C. List of Default Values

List of Default Values  
TR Menu

| Key Operation                   | Factory-shipped Setting  | Default Value |      | Save / Recall | Backup | Avaible Means of Defining a Setting |
|---------------------------------|--------------------------|---------------|------|---------------|--------|-------------------------------------|
|                                 |                          | Preset        | *RST |               |        |                                     |
| Limit Line                      | Red:160 Green:32 Blue:32 | <<            | <<   | *             |        | K/C                                 |
| Mem Trace 1                     | Red:127 Green:127 Blue:0 | <<            | <<   | *             |        | K/C                                 |
| Mem Trace 2                     | Red:0 Green:127 Blue:127 | <<            | <<   | *             |        | K/C                                 |
| Mem Trace 3                     | Red:0 Green:127 Blue:0   | <<            | <<   | *             |        | K/C                                 |
| Mem Trace 4                     | Red:127 Green:0 Blue:127 | <<            | <<   | *             |        | K/C                                 |
| Mem Trace 5                     | Red:127 Green:127 Blue:0 | <<            | <<   | *             |        | K/C                                 |
| Mem Trace 6                     | Red:0 Green:127 Blue:127 | <<            | <<   | *             |        | K/C                                 |
| Mem Trace 7                     | Red:0 Green:127 Blue:0   | <<            | <<   | *             |        | K/C                                 |
| Mem Trace 8                     | Red:127 Green:0 Blue:127 | <<            | <<   | *             |        | K/C                                 |
| Reset Color                     |                          |               |      |               |        | K/C                                 |
| Control Panel                   |                          |               |      |               |        | K                                   |
| GPIB Setup                      |                          |               |      |               |        |                                     |
| System Controller Configuration |                          |               |      |               |        |                                     |
| Talker/Listener Address         | 17                       | <<            | <<   | *             |        | K/C                                 |
| Key Lock                        |                          |               |      |               |        |                                     |
| Front Panel & Keyboard Lock     | OFF                      | <<            | <<   | *             |        | K/C                                 |
| Touch Screen & Mouse Lock       | OFF                      | <<            | <<   | *             |        | K/C                                 |
| Network Setup                   |                          |               |      |               |        |                                     |
| MAC Address                     |                          |               |      |               |        |                                     |
| Network Configuration...        |                          |               |      |               |        | K                                   |
| Network Identification...       |                          |               |      |               |        | K                                   |
| SICL-LAN Address                | 17                       | <<            | <<   | *             |        | K/C                                 |
| SICL-LAN Server                 | OFF                      | <<            | <<   | *             |        | K/C                                 |
| Socket Server                   | OFF                      | <<            | <<   | *             |        | K/C                                 |
| Telnet Server                   | OFF                      | <<            | <<   | *             |        | K/C                                 |
| Print                           |                          |               |      |               |        | K                                   |
| Printer Setup...                |                          |               |      |               |        | K                                   |
| Product Information             |                          |               |      |               |        | K                                   |

| Key Operation           | Factory-shipped Setting | Default Value |      | Save / Recall | Backup | Available Means of Defining a Setting |
|-------------------------|-------------------------|---------------|------|---------------|--------|---------------------------------------|
|                         |                         | Preset        | *RST |               |        |                                       |
| <b>Time Offset</b>      |                         |               |      |               |        |                                       |
| Narrow Ref Position     | Center                  | <<            | <<   | *             |        | K/C                                   |
| Narrow Settings -> Wide |                         |               |      |               |        | K/C                                   |
| Narrow Span             | 100 ms                  | <<            | <<   | *             |        | K/C                                   |
| Narrow Time Offset      | 0 s                     | <<            | <<   | *             |        | K/C                                   |
| Wide Ref Position       | Center                  | <<            | <<   | *             |        | K/C                                   |
| Wide Settings -> Narrow |                         |               |      |               |        | K/C                                   |
| Wide Span               | 100 ms                  | <<            | <<   | *             |        | K/C                                   |
| Wide Time Offset        | 0 s                     | <<            | <<   | *             |        | K/C                                   |
| <b>Trace View</b>       |                         |               |      |               |        |                                       |
| Aperture                | 1.5 %                   | <<            | <<   | *             |        | K/C                                   |
| Copy to User            |                         |               |      |               |        | K/C                                   |
| Data Hold               | Off                     | <<            | <<   | *             |        | K/C                                   |
| Data Math               | Off                     | <<            | <<   | *             |        | K/C                                   |
| Display Trace           | Data                    | <<            | <<   | *             |        | K/C                                   |
| Marker -> -Offset       |                         |               |      |               |        | K/C                                   |
| <b>Memory Trace</b>     |                         |               |      |               |        |                                       |
| Line (Y = AX + B)       |                         |               |      |               |        |                                       |
| A                       |                         | 0             | <<   | <<            | *      | K/C                                   |
| B                       |                         | 0             | <<   | <<            | *      | K/C                                   |
| Data Trace -> A, B      |                         |               |      |               |        | K/C                                   |
| Set Line to Memory      |                         |               |      |               |        | K/C                                   |
| Offset                  | 0 Hz                    | <<            | <<   | *             |        | K/C                                   |
| <b>Persistence</b>      |                         |               |      |               |        |                                       |
| Clear Persistent Data   |                         |               |      |               |        | K/C                                   |
| Persistence Mode        |                         | OFF           | <<   | <<            | *      | K/C                                   |
| Smoothing               | OFF                     | <<            | <<   | *             |        | K/C                                   |
| Trace Label             | "WB Freq"               | <<            | <<   | *             |        | K/C                                   |
| <b>Trigger</b>          |                         |               |      |               |        |                                       |
| Average Trigger         | OFF                     |               |      | *             |        | K/C                                   |
| Ext Trig Adj.           | 0 s                     | <<            | <<   | *             |        | K/C                                   |
| Ext Trig Polarity       | Negative                | <<            | <<   | *             |        | K/C                                   |
| Source                  | Internal                | <<            | <<   | *             |        | K/C                                   |
| Trigger to Transient    | Selected Phase Noise    | <<            | <<   | *             |        | K/C                                   |

C. List of Default Values

## USER Menu

| Key Operation               | Factory-shipped Setting | Default Value |      | Save / Recall | Backup | Available Means of Defining a Setting |
|-----------------------------|-------------------------|---------------|------|---------------|--------|---------------------------------------|
|                             |                         | Preset        | *RST |               |        |                                       |
| <b>Attenuator</b>           |                         |               |      |               |        |                                       |
| Input Attenuator            | 5 dB                    | <<            | <<   | *             |        | K/C                                   |
| <b>DC Control Voltage</b>   |                         |               |      |               |        |                                       |
| <b>Auto Freq Control</b>    |                         |               |      |               |        |                                       |
| AFC Status                  | OFF                     | <<            | <<   | *             |        | K/C                                   |
| Frequency Band              | 300 M - 7 GHz           | <<            | <<   | *             |        | K/C                                   |
| Max Ctrl Voltage Limit      | 35 V                    | <<            | <<   | *             |        | K/C                                   |
| Max Input Level             | 0 dBm                   | <<            | <<   | *             |        | K/C                                   |
| Max Iteration               | 10                      | <<            | <<   | *             |        | K/C                                   |
| Min Ctrl Voltage Limit      | -15 V                   | <<            | <<   | *             |        | K/C                                   |
| Sensitivity                 | 10 MHz/V                | <<            | <<   | *             |        | K/C                                   |
| Target                      | 1 GHz                   | <<            | <<   | *             |        | K/C                                   |
| Tolerance                   | 1 kHz                   | <<            | <<   | *             |        | K/C                                   |
| Control Voltage Cal         | OFF                     | <<            | <<   |               |        | K/C                                   |
| DC Control Delay            | 100 ms                  | <<            | <<   | *             |        | K/C                                   |
| DC Control Output           | OFF                     | <<            | <<   |               |        | K/C                                   |
| DC Control Voltage          | 0 V                     | <<            | <<   | *             |        | K/C                                   |
| Max Ctrl Voltage Limit      | 35 V                    | <<            | <<   | *             |        | K/C                                   |
| Min Ctrl Voltage Limit      | -15 V                   | <<            | <<   | *             |        | K/C                                   |
| <b>DC Power Voltage</b>     |                         |               |      |               |        |                                       |
| DC Power Delay              | 100 ms                  | <<            | <<   | *             |        | K/C                                   |
| DC Power Output             | OFF                     | <<            | <<   |               |        | K/C                                   |
| DC Power Voltage            | 0 V                     | <<            | <<   | *             |        | K/C                                   |
| Max Pwr Voltage Limit       | 16 V                    | <<            | <<   | *             |        | K/C                                   |
| Min Pwr Voltage Limit       | 0 V                     | <<            | <<   | *             |        | K/C                                   |
| <b>Display</b>              |                         |               |      |               |        |                                       |
| Edit Title Label            | ""                      | <<            | <<   | *             |        | K/C                                   |
| Color Type                  | "Normal"                | <<            | <<   | *             |        | K/C                                   |
| <b>Limit Test</b>           |                         |               |      |               |        |                                       |
| Delete Lower Limit Line     |                         |               |      |               |        | K/C                                   |
| Delete Upper Limit Line     |                         |               |      |               |        | K/C                                   |
| Fail Sign                   | ON                      | <<            | <<   | *             |        | K/C                                   |
| Import Lower Limit Line ... |                         |               |      |               |        | K/C                                   |
| Import Upper Limit Line ... |                         |               |      |               |        | K/C                                   |



| Key Operation          | Factory-shipped Setting                          | Default Value |      | Save / Recall | Backup | Available Means of Defining a Setting |
|------------------------|--------------------------------------------------|---------------|------|---------------|--------|---------------------------------------|
|                        |                                                  | Preset        | *RST |               |        |                                       |
| Limit Line             | ON                                               | <<            | <<   | *             |        | K/C                                   |
| Limit Test             | OFF                                              | <<            | <<   | *             |        | K/C                                   |
| Marker Information     | Left                                             | <<            | <<   | *             |        | K/C                                   |
| Meas Condition         | ON                                               | <<            | <<   | *             |        | K/C                                   |
| Relative Y-Scale       | OFF                                              | <<            | <<   | *             |        | K/C                                   |
| Security Level         | None                                             | <<            | <<   | *             |        | K/C                                   |
| Title Label            | OFF                                              | <<            | <<   | *             |        | K/C                                   |
| Update                 | ON                                               | <<            | <<   | *             |        | K/C                                   |
| Y # of Digits          | 4-digits                                         | <<            | <<   | *             |        | K/C                                   |
| <b>Input Port</b>      |                                                  |               |      |               |        |                                       |
| Down Converter         |                                                  |               |      |               |        |                                       |
| Down Converter         | OFF                                              | <<            | <<   | *             |        | K/C                                   |
| External Mixer         | Not Used                                         | <<            | <<   | *             |        | K/C                                   |
| RF Input               | Down Converter                                   | <<            | <<   | *             |        | K/C                                   |
| <b>Macro Setup</b>     |                                                  |               |      |               |        |                                       |
| E5052 Event            | OFF                                              |               |      |               |        | K/C                                   |
| Echo Window Menu       |                                                  |               |      |               |        |                                       |
| Clear Echo             |                                                  |               |      |               |        | K/C                                   |
| Echo Font Size         | 11                                               |               |      |               |        | K/C                                   |
| Echo Window            | OFF                                              |               |      |               |        | K/C                                   |
| User Menu              |                                                  |               |      |               |        |                                       |
| User Label 1           |                                                  |               |      |               |        | K/C                                   |
| <b>Marker</b>          |                                                  |               |      |               |        |                                       |
| Clear Marker Menu      |                                                  |               |      |               |        |                                       |
| Marker 1               | OFF                                              | <<            | <<   | *             |        | K/C                                   |
| Couple                 | OFF                                              | <<            | <<   | *             |        | K/C                                   |
| Marker List            | OFF                                              | <<            | <<   | *             |        | K/C                                   |
| More Functions         |                                                  |               |      |               |        |                                       |
| Discrete               | OFF                                              | <<            | <<   | *             |        | K/C                                   |
| Ref Marker             | 1                                                | <<            | <<   | *             |        | K/C                                   |
| Ref Marker Mode        | OFF                                              | <<            | <<   | *             |        | K/C                                   |
| <b>Marker Function</b> |                                                  |               |      |               |        |                                       |
| Analysis Range (X)     | Band Marker                                      | <<            | <<   | *             |        | K/C                                   |
| Analysis Range (Y)     | Band Marker                                      | <<            | <<   | *             |        | K/C                                   |
| Analysis Type          | Off                                              | <<            | <<   | *             |        | K/C                                   |
| Band Marker X          |                                                  |               |      |               |        |                                       |
| Band Marker X          | OFF                                              | <<            | <<   | *             |        | K/C                                   |
| Center                 | 0<br>(The unit changes by the selected trace.)   |               |      |               |        | K/C                                   |
| Span                   | 2T<br>(The unit changes by the selected trace.)  |               |      |               |        | K/C                                   |
| Start                  | -1T<br>(The unit changes by the selected trace.) | <<            | <<   | *             |        | K/C                                   |

C. List of Default Values

List of Default Values  
**USER Menu**

| Key Operation        | Factory-shipped Setting                          | Default Value |      | Save / Recall | Backup | Avaible Means of Defining a Setting |
|----------------------|--------------------------------------------------|---------------|------|---------------|--------|-------------------------------------|
|                      |                                                  | Preset        | *RST |               |        |                                     |
| Stop                 | IT<br>(The unit changes by the selected trace.)  | <<            | <<   | *             |        | K/C                                 |
| <b>Band Marker Y</b> |                                                  |               |      |               |        |                                     |
| Band Marker Y        | OFF                                              | <<            | <<   | *             |        | K/C                                 |
| Center               | 0<br>(The unit changes by the selected trace.)   |               |      |               |        | K/C                                 |
| Span                 | 2T<br>(The unit changes by the selected trace.)  |               |      |               |        | K/C                                 |
| Start                | -IT<br>(The unit changes by the selected trace.) | <<            | <<   | *             |        | K/C                                 |
| Stop                 | IT<br>(The unit changes by the selected trace.)  | <<            | <<   | *             |        | K/C                                 |
| Couple               | OFF                                              | <<            | <<   | *             |        | K/C                                 |
| <b>Marker Search</b> |                                                  |               |      |               |        |                                     |
| <b>Band Marker X</b> |                                                  |               |      |               |        |                                     |
| Band Marker X        | OFF                                              | <<            | <<   | *             |        | K/C                                 |
| Center               | 0<br>(The unit changes by the selected trace.)   |               |      |               |        | K/C                                 |
| Span                 | 2T<br>(The unit changes by the selected trace.)  |               |      |               |        | K/C                                 |
| Start                | -IT<br>(The unit changes by the selected trace.) | <<            | <<   | *             |        | K/C                                 |
| Stop                 | IT<br>(The unit changes by the selected trace.)  | <<            | <<   | *             |        | K/C                                 |
| <b>Band Marker Y</b> |                                                  |               |      |               |        |                                     |
| Band Marker Y        | OFF                                              | <<            | <<   | *             |        | K/C                                 |
| Center               | 0<br>(The unit changes by the selected trace.)   |               |      |               |        | K/C                                 |
| Span                 | 2T<br>(The unit changes by the selected trace.)  |               |      |               |        | K/C                                 |
| Start                | -IT<br>(The unit changes by the selected trace.) | <<            | <<   | *             |        | K/C                                 |
| Stop                 | IT<br>(The unit changes by the selected trace.)  | <<            | <<   | *             |        | K/C                                 |
| Couple               | OFF                                              | <<            | <<   | *             |        | K/C                                 |
| <b>Peak</b>          |                                                  |               |      |               |        |                                     |
| Peak Excursion       | 0<br>(The unit changes by the selected trace.)   | <<            | <<   | *             |        | K/C                                 |
| Peak Polarity        | Positive                                         | <<            | <<   | *             |        | K/C                                 |
| Search Left          |                                                  |               |      |               |        | K/C                                 |
| Search Peak          |                                                  |               |      |               |        | K/C                                 |
| Search Peak All      |                                                  |               |      |               |        | K/C                                 |
| Search Right         |                                                  |               |      |               |        | K/C                                 |
| Search Max           |                                                  |               |      |               |        | K/C                                 |
| Search Min           |                                                  |               |      |               |        | K/C                                 |
| Search Range (X)     | Full Range                                       | <<            | <<   | *             |        | K/C                                 |

| Key Operation         | Factory-shipped Setting                        | Default Value |      | Save / Recall | Backup | Avaible Means of Defining a Setting |
|-----------------------|------------------------------------------------|---------------|------|---------------|--------|-------------------------------------|
|                       |                                                | Preset        | *RST |               |        |                                     |
| Search Range (Y)      | Full Range                                     | <<            | <<   | *             |        | K/C                                 |
| Target                |                                                |               |      |               |        |                                     |
| Search Left           |                                                |               |      |               |        | K/C                                 |
| Search Right          |                                                |               |      |               |        | K/C                                 |
| Search Target         |                                                |               |      |               |        | K/C                                 |
| Target Transition     | Both                                           | <<            | <<   | *             |        | K/C                                 |
| Target Value          | 0<br>(The unit changes by the selected trace.) | <<            | <<   | *             |        | K/C                                 |
| Tracking              | Off                                            | <<            | <<   | *             |        | K/C                                 |
| Measurement View      |                                                |               |      |               |        |                                     |
| Freq & Power          | Selected Phase Noise                           | <<            | <<   | *             |        | K/C                                 |
| Phase Noise           | Selected Phase Noise                           | <<            | <<   | *             |        | K/C                                 |
| Show Window           |                                                |               |      |               |        |                                     |
| Freq & Power          | ON                                             | <<            | <<   | *             |        | K/C                                 |
| Phase Noise           | ON                                             | <<            | <<   | *             |        | K/C                                 |
| Spectrum Monitor      | ON                                             | <<            | <<   | *             |        | K/C                                 |
| Transient             | ON                                             | <<            | <<   | *             |        | K/C                                 |
| User                  | OFF                                            | <<            | <<   | *             |        | K/C                                 |
| Spectrum Monitor      | Selected Phase Noise                           | <<            | <<   | *             |        | K/C                                 |
| Transient             | Selected Phase Noise                           | <<            | <<   | *             |        | K/C                                 |
| User                  | Selected Phase Noise                           | <<            | <<   | *             |        | K/C                                 |
| Save/Recall           |                                                |               |      |               |        |                                     |
| Save State            |                                                |               |      |               |        |                                     |
| Save Type             | State Only                                     |               |      |               |        | K/C                                 |
| Scale                 |                                                |               |      |               |        |                                     |
| Auto Scale            |                                                |               |      |               |        | K/C                                 |
| Auto Scale All        |                                                |               |      |               |        | K/C                                 |
| Divisions             | 10                                             | <<            | <<   | *             |        | K/C                                 |
| Marker -> Reference   |                                                |               |      |               |        | K/C                                 |
| Reference Position    | This parameter changes by the selected trace.  | <<            | <<   | *             |        | K/C                                 |
| Reference Value       | This parameter changes by the selected trace.  | <<            | <<   | *             |        | K/C                                 |
| Scale/Div             | This parameter changes by the selected trace.  | <<            | <<   | *             |        | K/C                                 |
| X Axis                |                                                |               |      |               |        |                                     |
| Auto                  | ON                                             | <<            | <<   | *             |        | K/C                                 |
| Band Marker -> X Axis |                                                |               |      |               |        | K/C                                 |
| Left                  | 0                                              | <<            | <<   | *             |        | K/C                                 |
| Right                 | 100                                            | <<            | <<   | *             |        | K/C                                 |

C. List of Default Values

List of Default Values  
USER Menu

| Key Operation                      | Factory-shipped Setting | Default Value |      | Save / Recall | Backup | Available Means of Defining a Setting |
|------------------------------------|-------------------------|---------------|------|---------------|--------|---------------------------------------|
|                                    |                         | Preset        | *RST |               |        |                                       |
| X Axis Type                        | Linear                  | <<            | <<   | *             |        | K/C                                   |
| X Unit                             | U                       | <<            | <<   | *             |        | K/C                                   |
| Y Unit                             | U                       | <<            | <<   | *             |        | K/C                                   |
| <b>System</b>                      |                         |               |      |               |        |                                       |
| Abort Printing                     |                         |               |      |               |        | K/C                                   |
| Backlight                          | ON                      |               |      |               |        | K/C                                   |
| Dump Screen Image...               |                         |               |      |               |        | K                                     |
| Instrument Setup                   |                         |               |      |               |        |                                       |
| Correction                         |                         |               |      |               |        |                                       |
| File Dialog...                     |                         |               |      |               |        | K/C                                   |
| Import Power Correction Table      |                         |               |      |               |        | K/C                                   |
| Power Correction                   | OFF                     | <<            | <<   | *             |        | K/C                                   |
| Down Converter Manual Setup        |                         |               |      |               |        |                                       |
| Current                            | 0 A                     | <<            | <<   | *             |        | K/C                                   |
| Current                            | 0 A                     | <<            | <<   | *             |        | K/C                                   |
| IF Gain 1                          | 0 dB                    | <<            | <<   | *             |        | K/C                                   |
| IF Gain 2                          | 0 dB                    | <<            | <<   | *             |        | K/C                                   |
| LO1 Frequency                      | 2.975 GHz               | <<            | <<   | *             |        | K/C                                   |
| LO1 Level                          | 10 dBm                  | <<            | <<   | *             |        | K/C                                   |
| LO2 Frequency                      | 2.975 GHz               | <<            | <<   | *             |        | K/C                                   |
| LO2 Level                          | 10 dBm                  | <<            | <<   | *             |        | K/C                                   |
| Mixer 1 Bias                       | OFF                     | <<            | <<   | *             |        | K/C                                   |
| Mixer 2 Bias                       | OFF                     | <<            | <<   | *             |        | K/C                                   |
| $\Delta$ IF = IF2 - IF1            | 0 Hz                    | <<            | <<   | *             |        | K/C                                   |
| Frequency Offset (User Down Conv.) |                         |               |      |               |        |                                       |
| Conversion Mode                    | $RF = n * LO + IF$      | <<            | <<   | *             |        | K/C                                   |
| Frequency Offset                   | OFF                     | <<            | <<   | *             |        | K/C                                   |
| Harmonic #                         | 1                       | <<            | <<   | *             |        | K/C                                   |
| LO Frequency                       | 3 GHz                   | <<            | <<   | *             |        | K/C                                   |
| Invert Image                       | OFF                     | <<            | <<   | *             |        | K/C                                   |
| Misc Setup                         |                         |               |      |               |        |                                       |
| Beeper                             |                         |               |      |               |        |                                       |
| Beep Complete                      | ON                      | <<            | <<   | *             |        | K/C                                   |
| Beep Warning                       | OFF                     | <<            | <<   | *             |        | K/C                                   |
| Test Beep Complete                 |                         |               |      |               |        | K/C                                   |
| Test Beep Warning                  |                         |               |      |               |        | K/C                                   |

| Key Operation      | Factory-shipped Setting    | Default Value |      | Save / Recall | Backup | Available Means of Defining a Setting |
|--------------------|----------------------------|---------------|------|---------------|--------|---------------------------------------|
|                    |                            | Preset        | *RST |               |        |                                       |
| <b>Clock Setup</b> |                            |               |      |               |        |                                       |
| Set Date and Time  |                            |               |      |               |        | K                                     |
| Show Clock         | ON                         | <<            | <<   | *             |        | K/C                                   |
| <b>Color Setup</b> |                            |               |      |               |        |                                       |
| <b>Invert</b>      |                            |               |      |               |        |                                       |
| Background         | Red:255 Green:255 Blue:255 | <<            | <<   | *             |        | K/C                                   |
| Data Trace 1       | Red:0 Green:0 Blue:255     | <<            | <<   | *             |        | K/C                                   |
| Data Trace 2       | Red:255 Green:0 Blue:0     | <<            | <<   | *             |        | K/C                                   |
| Data Trace 3       | Red:255 Green:0 Blue:255   | <<            | <<   | *             |        | K/C                                   |
| Data Trace 4       | Red:0 Green:255 Blue:0     | <<            | <<   | *             |        | K/C                                   |
| Data Trace 5       | Red:0 Green:0 Blue:255     | <<            | <<   | *             |        | K/C                                   |
| Data Trace 6       | Red:255 Green:0 Blue:0     | <<            | <<   | *             |        | K/C                                   |
| Data Trace 7       | Red:255 Green:0 Blue:255   | <<            | <<   | *             |        | K/C                                   |
| Data Trace 8       | Red:0 Green:255 Blue:0     | <<            | <<   | *             |        | K/C                                   |
| Graticule Main     | Red:128 Green:128 Blue:128 | <<            | <<   | *             |        | K/C                                   |
| Graticule Sub      | Red:192 Green:192 Blue:192 | <<            | <<   | *             |        | K/C                                   |
| Limit Fail         | Red:0 Green:255 Blue:255   | <<            | <<   | *             |        | K/C                                   |
| Limit Line         | Red:95 Green:223 Blue:223  | <<            | <<   | *             |        | K/C                                   |
| Mem Trace 1        | Red:128 Green:128 Blue:255 | <<            | <<   | *             |        | K/C                                   |
| Mem Trace 2        | Red:255 Green:128 Blue:128 | <<            | <<   | *             |        | K/C                                   |
| Mem Trace 3        | Red:255 Green:128 Blue:255 | <<            | <<   | *             |        | K/C                                   |
| Mem Trace 4        | Red:128 Green:255 Blue:128 | <<            | <<   | *             |        | K/C                                   |
| Mem Trace 5        | Red:128 Green:128 Blue:255 | <<            | <<   | *             |        | K/C                                   |
| Mem Trace 6        | Red:255 Green:128 Blue:128 | <<            | <<   | *             |        | K/C                                   |
| Mem Trace 7        | Red:255 Green:128 Blue:255 | <<            | <<   | *             |        | K/C                                   |
| Mem Trace 8        | Red:128 Green:255 Blue:128 | <<            | <<   | *             |        | K/C                                   |
| Reset Color        |                            |               |      |               |        | K/C                                   |
| <b>Normal</b>      |                            |               |      |               |        |                                       |
| Background         | Red:0 Green:0 Blue:0       | <<            | <<   | *             |        | K/C                                   |
| Data Trace 1       | Red:255 Green:255 Blue:0   | <<            | <<   | *             |        | K/C                                   |
| Data Trace 2       | Red:0 Green:255 Blue:255   | <<            | <<   | *             |        | K/C                                   |
| Data Trace 3       | Red:0 Green:255 Blue:0     | <<            | <<   | *             |        | K/C                                   |
| Data Trace 4       | Red:255 Green:0 Blue:255   | <<            | <<   | *             |        | K/C                                   |
| Data Trace 5       | Red:255 Green:255 Blue:0   | <<            | <<   | *             |        | K/C                                   |
| Data Trace 6       | Red:0 Green:255 Blue:255   | <<            | <<   | *             |        | K/C                                   |
| Data Trace 7       | Red:0 Green:255 Blue:0     | <<            | <<   | *             |        | K/C                                   |
| Data Trace 8       | Red:255 Green:0 Blue:255   | <<            | <<   | *             |        | K/C                                   |
| Graticule Main     | Red:127 Green:127 Blue:127 | <<            | <<   | *             |        | K/C                                   |
| Graticule Sub      | Red:63 Green:63 Blue:63    | <<            | <<   | *             |        | K/C                                   |
| Limit Fail         | Red:255 Green:0 Blue:0     | <<            | <<   | *             |        | K/C                                   |

C. List of Default Values

List of Default Values  
**USER Menu**

| Key Operation                   | Factory-shipped Setting  | Default Value |      | Save / Recall | Backup | Avaible Means of Defining a Setting |
|---------------------------------|--------------------------|---------------|------|---------------|--------|-------------------------------------|
|                                 |                          | Preset        | *RST |               |        |                                     |
| Limit Line                      | Red:160 Green:32 Blue:32 | <<            | <<   | *             |        | K/C                                 |
| Mem Trace 1                     | Red:127 Green:127 Blue:0 | <<            | <<   | *             |        | K/C                                 |
| Mem Trace 2                     | Red:0 Green:127 Blue:127 | <<            | <<   | *             |        | K/C                                 |
| Mem Trace 3                     | Red:0 Green:127 Blue:0   | <<            | <<   | *             |        | K/C                                 |
| Mem Trace 4                     | Red:127 Green:0 Blue:127 | <<            | <<   | *             |        | K/C                                 |
| Mem Trace 5                     | Red:127 Green:127 Blue:0 | <<            | <<   | *             |        | K/C                                 |
| Mem Trace 6                     | Red:0 Green:127 Blue:127 | <<            | <<   | *             |        | K/C                                 |
| Mem Trace 7                     | Red:0 Green:127 Blue:0   | <<            | <<   | *             |        | K/C                                 |
| Mem Trace 8                     | Red:127 Green:0 Blue:127 | <<            | <<   | *             |        | K/C                                 |
| Reset Color                     |                          |               |      |               |        | K/C                                 |
| Control Panel                   |                          |               |      |               |        | K                                   |
| GPIB Setup                      |                          |               |      |               |        |                                     |
| System Controller Configuration |                          |               |      |               |        |                                     |
| Talker/Listener Address         | 17                       | <<            | <<   | *             |        | K/C                                 |
| Key Lock                        |                          |               |      |               |        |                                     |
| Front Panel & Keyboard Lock     | OFF                      | <<            | <<   | *             |        | K/C                                 |
| Touch Screen & Mouse Lock       | OFF                      | <<            | <<   | *             |        | K/C                                 |
| Network Setup                   |                          |               |      |               |        |                                     |
| MAC Address                     |                          |               |      |               |        |                                     |
| Network Configuration...        |                          |               |      |               |        | K                                   |
| Network Identification...       |                          |               |      |               |        | K                                   |
| SICL-LAN Address                | 17                       | <<            | <<   | *             |        | K/C                                 |
| SICL-LAN Server                 | OFF                      | <<            | <<   | *             |        | K/C                                 |
| Socket Server                   | OFF                      | <<            | <<   | *             |        | K/C                                 |
| Telnet Server                   | OFF                      | <<            | <<   | *             |        | K/C                                 |
| Print                           |                          |               |      |               |        | K                                   |
| Printer Setup...                |                          |               |      |               |        | K                                   |
| Product Information             |                          |               |      |               |        | K                                   |

| Key Operation             | Factory-shipped Setting | Default Value |      | Save / Recall | Backup | Avaiable Means of Defining a Setting |
|---------------------------|-------------------------|---------------|------|---------------|--------|--------------------------------------|
|                           |                         | Preset        | *RST |               |        |                                      |
| <b>Trace View</b>         |                         |               |      |               |        |                                      |
| Aperture                  | 1.5 %                   | <<            | <<   | *             |        | K/C                                  |
| Copy to User              |                         |               |      |               |        | K/C                                  |
| Data Hold                 | Off                     | <<            | <<   | *             |        | K/C                                  |
| Data Math                 | Off                     | <<            | <<   | *             |        | K/C                                  |
| Display Trace             | Data                    | <<            | <<   | *             |        | K/C                                  |
| Enable Trace              |                         |               |      |               |        |                                      |
| Trace 1                   | ON                      | <<            | <<   | *             |        | K/C                                  |
| Marker -> -Offset         |                         |               |      |               |        | K/C                                  |
| Offset                    | 0                       | <<            | <<   | *             |        | K/C                                  |
| Persistence               |                         |               |      |               |        |                                      |
| Clear All Persistent Data |                         |               |      |               |        | K/C                                  |
| Persistence Mode          | OFF                     | <<            | <<   | *             |        | K/C                                  |
| Smoothing                 | OFF                     | <<            | <<   | *             |        | K/C                                  |
| Trace Annotation          | ""                      | <<            | <<   | *             |        | K/C                                  |
| Trace Label               | "Tr1"                   | <<            | <<   | *             |        | K/C                                  |

**NOTE**

The user menu is not displayed to press **Presets** - **Factory** key or to execute **:SYST:PRES** command. This is because the user menu is not set in the setting when the factory is shipped.

The initial value that has been described to the user menu in the initial value table is a value that internally has the E5052A.

List of Default Values  
**USER Menu**



---

## **D** **Softkey Functions**

This appendix explains the functions of softkeys and hardkeys supplied on the Agilent E5052A.

## Phanse Noise Menu (Top Menu)

| Key Operation                                  | Function                                                                                                                                                        |
|------------------------------------------------|-----------------------------------------------------------------------------------------------------------------------------------------------------------------|
| <b>Double-click on each softkey menu title</b> | Displays the top menu of each menu item below. A preset operation will not cancel the menu display. Refer the PN menu about detail of following each menu item. |
| Measurement View                               | Same as <b>Meas</b> .                                                                                                                                           |
| Input                                          | Same as <b>Scale</b> .                                                                                                                                          |
| Scale                                          | Same as <b>Scale</b> .                                                                                                                                          |
| Format                                         | Same as <b>Format</b> .                                                                                                                                         |
| Display                                        | Same as <b>Display</b> .                                                                                                                                        |
| Average                                        | Same as <b>Avg</b> .                                                                                                                                            |
| Attenuator                                     | Same as <b>Cal</b> .                                                                                                                                            |
| Start                                          | Displays the same softkey for setting up the sweep range that appears when <b>Start</b> , or <b>Span</b> is pressed.                                            |
| Stop                                           | Displays the same softkey for setting up the sweep range that appears when <b>Start</b> , or <b>Span</b> is pressed.                                            |
| DC Conrol Voltage                              | Same as <b>Sweep Setup</b> .                                                                                                                                    |
| DC Power Voltage                               | Same as <b>Sweep Setup</b> .                                                                                                                                    |
| Setup                                          | Same as <b>Sweep Setup</b> .                                                                                                                                    |
| Trigger                                        | Same as <b>Trigger</b> .                                                                                                                                        |
| Marker                                         | Same as <b>Marker</b> .                                                                                                                                         |
| Marker Search                                  | Same as <b>Marker Search</b> .                                                                                                                                  |
| Marker To                                      | Same as <b>Marker Search</b> .                                                                                                                                  |
| Marker Function                                | Same as <b>Marker Fctn</b> .                                                                                                                                    |
| Macro Setup                                    | Same as <b>Macro Setup</b> .                                                                                                                                    |
| Save/Recall                                    | Same as <b>Save/Recall</b> .                                                                                                                                    |
| System                                         | Same as <b>System</b> .                                                                                                                                         |
| Preset                                         | Same as <b>Preset</b> .                                                                                                                                         |

## PN Menu

Table D-1 PN Menu

| Key Operation                      | Function                                                                                     | SCPI Command                                              |
|------------------------------------|----------------------------------------------------------------------------------------------|-----------------------------------------------------------|
| <b>Attenuator</b>                  |                                                                                              |                                                           |
| <b>Input Attenuator</b>            | Sets/reads Input Attenuator level on 5dB Step                                                | :SENS:ATT:LEV                                             |
| <b>Average</b>                     |                                                                                              |                                                           |
| <b>Averaging</b>                   | Turns on/off averaging function                                                              | :SENS:PN[1-1]:AVER:STAT                                   |
| <b>Averaging Restart</b>           | Restart averaging                                                                            | :SENS:PN[1-1]:AVER:CLE                                    |
| <b>Avg Factor</b>                  | Sets/reads average count                                                                     | :SENS:PN[1-1]:AVER:COUN                                   |
| <b>Correlation</b>                 | Sets/reads the number of correlation                                                         | :SENS:PN[1-1]:CORR:COUN                                   |
| <b>DC Control Voltage</b>          |                                                                                              |                                                           |
| <b>Auto Freq Control</b>           |                                                                                              |                                                           |
| <b>AFC Status</b>                  | Turns on/off the auto frequency control function<br>Executes the auto frequency control once | :SOUR:VOLT:CONT:AFC[:STAT<br>]<br>:SOUR:VOLT:CONT:AFC:IMM |
| <b>Frequency Band</b>              | Sets/reads the frequency band in the auto frequency control function                         | :SOUR:VOLT:CONT:AFC:FBAN                                  |
| <b>Max Ctrl Voltage Limit</b>      | Sets/reads the maximum DC control voltage limit                                              | :SOUR:VOLT:CONT:AFC:LIM:<br>HIGH                          |
| <b>Max Input Level</b>             | Sets/reads the maximum input level                                                           | :SENS:FP[1-1]:POW:INP:LEV:M<br>AX                         |
| <b>Max Iteration</b>               | Sets/reads the maximum number of iterations for the DC control voltage-setting loops         | :SOUR:VOLT:CONT:AFC:ITER                                  |
| <b>Min Ctrl Voltage Limit</b>      | Sets/reads the minimum DC control voltage limit                                              | :SOUR:VOLT:CONT:AFC:LIM:<br>LOW                           |
| <b>Sensitivity</b>                 | Sets/reads the tuning sensitivity                                                            | :SOUR:VOLT:CONT:AFC:SENS                                  |
| <b>Target</b>                      | Sets/reads the target frequency in the auto frequency control function                       | :SOUR:VOLT:CONT:AFC:TARG                                  |
| <b>Tolerance</b>                   | Sets/reads the tolerance limit                                                               | :SOUR:VOLT:CONT:AFC:TOL                                   |
| <b>Control Voltage Cal</b>         | Enables DC Control voltage calibration                                                       | :SOUR:VOLT:CONT:CORR[:ST<br>AT]                           |
| <b>DC Control Delay</b>            | Sets/reads DC Control delay (sec)                                                            | :SOUR:VOLT:CONT:DEL                                       |
| <b>DC Control Output</b>           | Turns on/off DC Control voltage                                                              | :SOUR:VOLT:CONT:LEV:STAT                                  |
| <b>DC Control Voltage</b>          | Sets/reads DC Control voltage                                                                | :SOUR:VOLT:CONT:LEV:AMP<br>L                              |
| <b>Execute Control Voltage Cal</b> | Execute DC control voltage calibration                                                       | :SOUR:VOLT:CONT:CORR:CO<br>LL:ACQ                         |
| <b>Max Ctrl Voltage Limit</b>      | Sets/reads the maximum DC control voltage limit                                              | :SOUR:VOLT:CONT:LIM:HIGH                                  |

**Table D-1 PN Menu**

| Key Operation                      | Function                                                     | SCPI Command                             |
|------------------------------------|--------------------------------------------------------------|------------------------------------------|
| <b>Min Ctrl Voltage Limit</b>      | Sets/reads the minimum DC control voltage limit              | :SOUR:VOLT:CONT:LIM:LOW                  |
| <b>DC Power Voltage</b>            |                                                              |                                          |
| <b>DC Power Delay</b>              | Sets/reads DC Power delay (sec)                              | :SOUR:VOLT:POW:DEL                       |
| <b>DC Power Output</b>             | Turns on/off DC Power voltage                                | :SOUR:VOLT:POW:LEV:STAT                  |
| <b>DC Power Voltage</b>            | Sets/reads DC Power voltage                                  | :SOUR:VOLT:POW:LEV:AMPL                  |
| <b>Max Pwr Voltage Limit</b>       | Sets/reads the maximum DC Power voltage limit                | :SOUR:VOLT:POW:LIM:HIGH                  |
| <b>Min Pwr Voltage Limit</b>       | Sets/reads the minimum DC Power voltage limit                | :SOUR:VOLT:POW:LIM:LOW                   |
| <b>Display</b>                     |                                                              |                                          |
| <b>Edit Title Label</b>            | Edit the measurement window title label                      | :DISP:PN[1-1]:LAB:DATA                   |
| <b>Color Type</b>                  | Sets/Reads the display type of the display (normal/inverted) | :DISP:IMAG                               |
| <b>Limit Test</b>                  |                                                              |                                          |
| <b>Delete Lower Limit Line</b>     | Clears the lower limit line                                  | :CALC:PN[1-1]:TRAC[1-1]:LIM:LOW:SEGM:CLE |
| <b>Delete Upper Limit Line</b>     | Clears the upper limit line                                  | :CALC:PN[1-1]:TRAC[1-1]:LIM:UPP:SEGM:CLE |
| <b>Explorer</b>                    |                                                              |                                          |
| <b>Fail Sign</b>                   | Turns on/off the limit test judgement display                | :DISP:PN[1-1]:LIM:FSIG                   |
| <b>Import Lower Limit Line ...</b> | Reads the lower limit line                                   | :MMEM:PN[1-1]:TRAC[1-1]:LOAD:LIM:LOW     |
| <b>Import Upper Limit Line ...</b> | Reads the upper limit line                                   | :MMEM:PN[1-1]:TRAC[1-1]:LOAD:LIM:UPP     |
| <b>Limit Line</b>                  | Turns on/off the limit line                                  | :DISP:PN[1-1]:TRAC[1-1]:LIM:LINE         |
| <b>Limit Test</b>                  | Turns on/off the limit test function                         | :CALC:PN[1-1]:TRAC[1-1]:LIM[:STAT]       |
| <b>Marker Information</b>          | Sets/reads the marker information position                   | :DISP:PN[1-1]:ANN:MARK:POS               |
| <b>Meas Condition</b>              | Turns on/off measurement conditions                          | :DISP:PN[1-1]:ANN:MEAS:STAT              |
| <b>Relative Y-Scale</b>            | Turns on/off relative Y-scale                                | :DISP:PN[1-1]:GRAT:AXIS:Y:REL            |
| <b>Security Level</b>              | Sets/recalls the security level                              | :SYST:SEC[:LEV]                          |
| <b>Title Label</b>                 | Turns on/off the measurement window title label              | :DISP:PN[1-1]:LAB:STAT                   |
| <b>Update</b>                      | Turns on/off the trace updates                               | :DISP:ENAB                               |
| <b>Y # of Digits</b>               | Selects the number of digits (Y-axis)                        | :DISP:PN[1-1]:GRAT:AXIS:Y:STAT           |

**Table D-1 PN Menu**

| Key Operation           | Function                                                            | SCPI Command             |
|-------------------------|---------------------------------------------------------------------|--------------------------|
| <b>Input Port</b>       |                                                                     |                          |
| <b>Downconverter</b>    |                                                                     |                          |
| Downconverter           | Sets the use of the downconverter on or off, or reads its setting   | :SENS:DCON[:STAT]        |
| RF Input                | Sets/reads the signal supplied to the RF input port                 | :SENS:DCON:INP           |
| External Mixer          | Sets the use of the external mixer on or off and reads its settings | :SENS:DCON:MEXT          |
| <b>Macro Setup</b>      |                                                                     |                          |
| <b>Application</b>      |                                                                     |                          |
| Jitter                  | Executes clock jitter analysis (VBA)                                |                          |
| mmWave                  | Executes phase-noise measurement (VBA)                              |                          |
| E5052 Event             | Turns on/off the E5052 VBA event callback function                  | :PROG:COM:EVEN           |
| <b>Echo Window Menu</b> |                                                                     |                          |
| Clear Echo              | Clears echo window                                                  | :DISP:ECHO:CLE           |
| Echo Font Size          | Sets/reads the font size on Echo window                             | :DISP:ECHO:FSIZ          |
| Echo Window             | Turns on./off the Echo window                                       | :DISP:ECHO:STAT          |
| Load & Run              | Load and execute the macro selected on file names.                  |                          |
| Select Macro            | Sets/reads the name of the program to be selected                   | :PROG:SEL:NAME           |
| Stop                    | Set/reads the state of the selected program                         | :PROG:SEL:STAT           |
| <b>User Menu</b>        |                                                                     |                          |
| User Label 1            | Execute the macro assigned under the user defined softkey           | :PROG:SKEY:ITEM[1-8]:IMM |
| User Label 2            | Execute the macro assigned under the user defined softkey           | :PROG:SKEY:ITEM[1-8]:IMM |
| User Label 3            | Execute the macro assigned under the user defined softkey           | :PROG:SKEY:ITEM[1-8]:IMM |
| User Label 4            | Execute the macro assigned under the user defined softkey           | :PROG:SKEY:ITEM[1-8]:IMM |
| User Label 5            | Execute the macro assigned under the user defined softkey           | :PROG:SKEY:ITEM[1-8]:IMM |
| User Label 6            | Execute the macro assigned under the user defined softkey           | :PROG:SKEY:ITEM[1-8]:IMM |
| User Label 7            | Execute the macro assigned under the user defined softkey           | :PROG:SKEY:ITEM[1-8]:IMM |
| User Label 8            | Execute the macro assigned under the user defined softkey           | :PROG:SKEY:ITEM[1-8]:IMM |
| <b>VBA Editor Menu</b>  |                                                                     |                          |
| Close Editor            | Close VBA editor                                                    |                          |
| Load Project            | Loads program                                                       | :MMEM:LOAD:PROG          |
| New Project             | Open new VBA project                                                |                          |
| Open Editor             | Open VBA editor                                                     |                          |
| Save Project            | Save VBA project                                                    | :MMEM:STOR:PROG          |

**Table D-1 PN Menu**

| Key Operation             | Function                                         | SCPI Command                            |
|---------------------------|--------------------------------------------------|-----------------------------------------|
| <b>Marker</b>             |                                                  |                                         |
| <b>Clear Marker Menu</b>  |                                                  |                                         |
| <b>All OFF</b>            | Clears all the markers                           |                                         |
| <b>Marker 1</b>           | Turns on/off marker 1                            | :CALC:PN[1-1]:TRAC[1-1]:MARK[1-10]:STAT |
| :                         |                                                  |                                         |
| :                         |                                                  |                                         |
| <b>Marker 10</b>          | Turns on/off marker 10                           | :CALC:PN[1-1]:TRAC[1-1]:MARK[1-10]:STAT |
| <b>Marker 1</b>           | Turns on/off marker 1                            | :CALC:PN[1-1]:TRAC[1-1]:MARK[1-10]:STAT |
| :                         |                                                  |                                         |
| :                         |                                                  |                                         |
| <b>Marker 6</b>           | Turns on/off marker 6                            | :CALC:PN[1-1]:TRAC[1-1]:MARK[1-10]:STAT |
| <b>Marker List</b>        | Turns on/off the marker list                     | :DISP:PN[1-1]:TABL[:STAT]               |
| <b>More Functions</b>     |                                                  |                                         |
| <b>Discrete</b>           | Sets/reads marker movement (Continuous/Discrete) | :CALC:PN[1-1]:ALLT:MARK:DISC:STAT       |
| <b>Ref Marker</b>         | Sets/reads marker reference number               | :CALC:PN[1-1]:ALLT:MARK:REF:NUMB        |
| <b>Ref Marker Mode</b>    | Turns on/off delta marker mode                   | :CALC:PN[1-1]:ALLT:MARK:REF:STAT        |
| <b>More Markers</b>       |                                                  |                                         |
| <b>Marker 7</b>           | Turns on/off marker 7                            | :CALC:PN[1-1]:TRAC[1-1]:MARK[1-10]:STAT |
| :                         |                                                  |                                         |
| :                         |                                                  |                                         |
| <b>Marker 10</b>          | Turns on/off marker 10                           | :CALC:PN[1-1]:TRAC[1-1]:MARK[1-10]:STAT |
| <b>Marker Function</b>    |                                                  |                                         |
| <b>Analysis Range (X)</b> | Sets/reads analysis/search range (X-axis)        | :CALC:PN[1-1]:TRAC[1-1]:FUNCTION:DOM:X  |
| <b>Analysis Range (Y)</b> | Sets/reads analysis/search range (Y-axis)        | :CALC:PN[1-1]:TRAC[1-1]:FUNCTION:DOM:Y  |
| <b>Analysis Type</b>      | Sets/reads analysis type                         | :CALC:PN[1-1]:TRAC[1-1]:FUNCTION:TYPE   |
| <b>Band Marker X</b>      |                                                  |                                         |
| <b>Band Marker X</b>      | Turns on/off bandmarker X                        | :CALC:PN[1-1]:TRAC[1-1]:BDM:X:STAT      |

**Table D-1 PN Menu**

| Key Operation        | Function                                    | SCPI Command                       |
|----------------------|---------------------------------------------|------------------------------------|
| <b>Center</b>        | Sets/reads the center value of bandmarker X | :CALC:PN[1-1]:TRAC[1-1]:BDM:X:CENT |
| <b>Span</b>          | Sets/reads the span value of bandmarker X   | :CALC:PN[1-1]:TRAC[1-1]:BDM:X:SPAN |
| <b>Start</b>         | Sets/reads the start value of bandmarker X  | :CALC:PN[1-1]:TRAC[1-1]:BDM:X:STAR |
| <b>Stop</b>          | Sets/reads the stop value of bandmarker X   | :CALC:PN[1-1]:TRAC[1-1]:BDM:X:STOP |
| <b>Band Marker Y</b> |                                             |                                    |
| <b>Band Marker Y</b> | Turns on/off bandmarker Y                   | :CALC:PN[1-1]:TRAC[1-1]:BDM:Y:STAT |
| <b>Center</b>        | Sets/reads the center value of bandmarker Y | :CALC:PN[1-1]:TRAC[1-1]:BDM:Y:CENT |
| <b>Span</b>          | Sets/reads the span value of bandmarker Y   | :CALC:PN[1-1]:TRAC[1-1]:BDM:Y:SPAN |
| <b>Start</b>         | Sets/reads the start value of bandmarker Y  | :CALC:PN[1-1]:TRAC[1-1]:BDM:Y:STAR |
| <b>Stop</b>          | Sets/reads the stop value of bandmarker Y   | :CALC:PN[1-1]:TRAC[1-1]:BDM:Y:STOP |
| <b>Marker Search</b> |                                             |                                    |
| <b>Band Marker X</b> |                                             |                                    |
| <b>Band Marker X</b> | Turns on/off bandmarker X                   | :CALC:PN[1-1]:TRAC[1-1]:BDM:X:STAT |
| <b>Center</b>        | Sets/reads the center value of bandmarker X | :CALC:PN[1-1]:TRAC[1-1]:BDM:X:CENT |
| <b>Span</b>          | Sets/reads the span value of bandmarker X   | :CALC:PN[1-1]:TRAC[1-1]:BDM:X:SPAN |
| <b>Start</b>         | Sets/reads the start value of bandmarker X  | :CALC:PN[1-1]:TRAC[1-1]:BDM:X:STAR |
| <b>Stop</b>          | Sets/reads the stop value of bandmarker X   | :CALC:PN[1-1]:TRAC[1-1]:BDM:X:STOP |
| <b>Band Marker Y</b> |                                             |                                    |
| <b>Band Marker Y</b> | Turns on/off bandmarker Y                   | :CALC:PN[1-1]:TRAC[1-1]:BDM:Y:STAT |
| <b>Center</b>        | Sets/reads the center value of bandmarker Y | :CALC:PN[1-1]:TRAC[1-1]:BDM:Y:CENT |
| <b>Span</b>          | Sets/reads the span value of bandmarker Y   | :CALC:PN[1-1]:TRAC[1-1]:BDM:Y:SPAN |
| <b>Start</b>         | Sets/reads the start value of bandmarker Y  | :CALC:PN[1-1]:TRAC[1-1]:BDM:Y:STAR |

**Table D-1 PN Menu**

| Key Operation             | Function                                       | SCPI Command                                      |
|---------------------------|------------------------------------------------|---------------------------------------------------|
| <b>Stop</b>               | Sets/reads the stop value of bandmarker Y      | :CALC:PN[1-1]:TRAC[1-1]:BDM:Y:STOP                |
| <b>Peak</b>               |                                                |                                                   |
| <b>Peak Excursion</b>     | Sets/reads the peak excursion value            | :CALC:PN[1-1]:TRAC[1-1]:MARK[1-10]:SEAR:PEAK:EXC  |
| <b>Peak Polarity</b>      | Sets/reads the marker peak-search polarity     | :CALC:PN[1-1]:TRAC[1-1]:MARK[1-10]:SEAR:PEAK:POL  |
| <b>Search Left</b>        | Execute marker peak search left                | :CALC:PN[1-1]:TRAC[1-1]:MARK[1-10]:SEAR:EXEC:LPE  |
| <b>Search Peak</b>        | Execute marker peak search                     | :CALC:PN[1-1]:TRAC[1-1]:MARK[1-10]:SEAR:EXEC:PEAK |
| <b>Search Peak All</b>    | Execute marker search all                      | :CALC:PN[1-1]:TRAC[1-1]:ALLM:SEAR:PEAK            |
| <b>Search Right</b>       | Execute marker peak search right               | :CALC:PN[1-1]:TRAC[1-1]:MARK[1-10]:SEAR:EXEC:RPE  |
| <b>Search Max</b>         | Execute marker search maximum                  | :CALC:PN[1-1]:TRAC[1-1]:MARK[1-10]:SEAR:EXEC:MAX  |
| <b>Search Min</b>         | Execute marker search minimum                  | :CALC:PN[1-1]:TRAC[1-1]:MARK[1-10]:SEAR:EXEC:MIN  |
| <b>Search Range (X)</b>   | Sets/reads marker search range (X-axis)        | :CALC:PN[1-1]:TRAC[1-1]:ALLM:SEAR:DOM:X           |
| <b>Search Range (Y)</b>   | Sets/reads marker search range (Y-axis)        | :CALC:PN[1-1]:TRAC[1-1]:ALLM:SEAR:DOM:Y           |
| <b>Target</b>             |                                                |                                                   |
| <b>Search Left</b>        | Execute marker target search left              | :CALC:PN[1-1]:TRAC[1-1]:MARK[1-10]:SEAR:EXEC:LTAR |
| <b>Search Right</b>       | Execute marker target search right             | :CALC:PN[1-1]:TRAC[1-1]:MARK[1-10]:SEAR:EXEC:RTAR |
| <b>Search Target</b>      | Execute marker target search                   | :CALC:PN[1-1]:TRAC[1-1]:MARK[1-10]:SEAR:EXEC:TARG |
| <b>Target Transition</b>  | Sets/reads the target transition definition    | :CALC:PN[1-1]:TRAC[1-1]:MARK[1-10]:SEAR:TARG:TRAN |
| <b>Target Value</b>       | Sets/reads the marker target value             | :CALC:PN[1-1]:TRAC[1-1]:MARK[1-10]:SEAR:TARG:Y    |
| <b>Tracking</b>           | Sets/reads the marker tracking type            | :CALC:PN[1-1]:TRAC[1-1]:MARK[1-10]:SEAR:TRAC:TYPE |
| <b>Marker To</b>          |                                                |                                                   |
| <b>Marker -&gt; Start</b> | Sets/reads the marker value to the start value | :SENS:PN[1-1]:FREQ:STAR                           |
| <b>Marker -&gt; Stop</b>  | Sets/reads the marker value to the stop value  | :SENS:PN[1-1]:FREQ:STOP                           |



**Table D-1 PN Menu**

| Key Operation             | Function                                                      | SCPI Command                            |
|---------------------------|---------------------------------------------------------------|-----------------------------------------|
| <b>Measurement View</b>   |                                                               |                                         |
| <b>Freq &amp; Power</b>   | Selects frequency, power and DC current measurement window    | :DISP:WIND:ACT                          |
| <b>Phase Noise</b>        | Selects phase noise measurement window                        | :DISP:WIND:ACT                          |
| <b>Show Window</b>        |                                                               |                                         |
| <b>Freq &amp; Power</b>   | Turns on/off frequency, power and DC current measurement mode | :DISP:FP[1-1]:STAT                      |
| <b>Phase Noise</b>        | Turns on/off phase noise measurement mode                     | :DISP:PN[1-1]:STAT                      |
| <b>Spectrum Monitor</b>   | Turns on/off spectrum monitor mode                            | :DISP:SP[1-1]:STAT                      |
| <b>Transient</b>          | Turns on/off transient measurement mode                       | :DISP:TR[1-1]:STAT                      |
| <b>User</b>               | Turns on/off user defined window                              | :DISP:USER[1-1]:STAT                    |
| <b>Spectrum Monitor</b>   | Selects spectrum monitor mode                                 | :DISP:WIND:ACT                          |
| <b>Transient</b>          | Selects transient measurement mode                            | :DISP:WIND:ACT                          |
| <b>User</b>               | Selects user defined window                                   | :DISP:WIND:ACT                          |
| <b>Preset</b>             |                                                               |                                         |
| <b>Factory</b>            | Preset instrument to the initial setup state                  | :SYST:PRES                              |
| <b>User</b>               | Preset instrument and recalls the Autorec.sta in the F drive  |                                         |
| <b>Save/Recall</b>        |                                                               |                                         |
| <b>Explorer...</b>        | Open windows explorer                                         |                                         |
| <b>Recall by filename</b> | Recalls state file by file name                               | :MMEM:LOAD:STAT                         |
| <b>Recall State</b>       |                                                               |                                         |
| <b>Autorec</b>            | Recalls settings                                              | :MMEM:LOAD:STAT                         |
| <b>File Dialog...</b>     | Open file dialog                                              |                                         |
| <b>State01</b>            | Recalls state file from register 1                            | :MMEM:LOAD:STAT                         |
| <b>State02</b>            | Recalls state file from register 2                            | :MMEM:LOAD:STAT                         |
| <b>State03</b>            | Recalls state file from register 3                            | :MMEM:LOAD:STAT                         |
| <b>State04</b>            | Recalls state file from register 4                            | :MMEM:LOAD:STAT                         |
| <b>State05</b>            | Recalls state file from register 5                            | :MMEM:LOAD:STAT                         |
| <b>State06</b>            | Recalls state file from register 6                            | :MMEM:LOAD:STAT                         |
| <b>Save Data Trace</b>    | Saves trace data                                              | :MMEM:PN[1-1]:TRAC[1-1]:ST<br>OR[:DATA] |
| <b>Save Memory Trace</b>  | Saves memory trace data                                       | :MMEM:PN[1-1]:TRAC[1-1]:ST<br>OR:MEM    |

**Table D-1 PN Menu**

| Key Operation                   | Function                                                                                    | SCPI Command                                                               |
|---------------------------------|---------------------------------------------------------------------------------------------|----------------------------------------------------------------------------|
| <b>Save State</b>               |                                                                                             |                                                                            |
| <b>Autorec</b>                  | Save settings                                                                               | :MMEM:STOR:STAT                                                            |
| <b>File Dialog...</b>           | Open file dialog                                                                            |                                                                            |
| <b>Save Type</b>                | Select instrument state type (Entire or instrument state only)                              | :MMEM:STOR:STYP                                                            |
| <b>State01</b>                  | Save state file to register 1                                                               | :MMEM:STOR:STAT                                                            |
| <b>State02</b>                  | Save state file to register 2                                                               | :MMEM:STOR:STAT                                                            |
| <b>State03</b>                  | Save state file to register 3                                                               | :MMEM:STOR:STAT                                                            |
| <b>State04</b>                  | Save state file to register 4                                                               | :MMEM:STOR:STAT                                                            |
| <b>State05</b>                  | Save state file to register 5                                                               | :MMEM:STOR:STAT                                                            |
| <b>State06</b>                  | Save state file to register 6                                                               | :MMEM:STOR:STAT                                                            |
| <b>Scale</b>                    |                                                                                             |                                                                            |
| <b>Auto Scale</b>               | Execute autoscale                                                                           | :DISP:PN[1-1]:TRAC[1-1]:Y[:SCAL]:AUTO                                      |
| <b>Divisions</b>                | Sets/reads Y-scale divisions                                                                | :DISP:PN[1-1]:Y[:SCAL]:DIV                                                 |
| <b>Marker -&gt; Reference</b>   | Sets the marker value to the reference level                                                | :DISP:PN[1-1]:TRAC[1-1]:Y[:SCAL]:RLEV                                      |
| <b>Reference Position</b>       | Sets/reads reference position                                                               | :DISP:PN[1-1]:TRAC[1-1]:Y[:SCAL]:RPOS                                      |
| <b>Reference Value</b>          | Sets/reads the reference level value                                                        | :DISP:PN[1-1]:TRAC[1-1]:Y[:SCAL]:RLEV                                      |
| <b>Scale/Div</b>                | Sets/reads scale per division                                                               | :DISP:PN[1-1]:TRAC[1-1]:Y[:SCAL]:PDIV                                      |
| <b>X Axis</b>                   |                                                                                             |                                                                            |
| <b>Auto</b>                     | Sets/Reads automatic setting of the X-axis display range to the stimulus value              | :DISP:PN[1-1]:TRAC[1-1]:X:SCAL:AUTO                                        |
| <b>Band Marker -&gt; X Axis</b> | Sets the X-axis band marker range to the X-axis display range of a graph                    | :DISP:PN[1-1]:TRAC[1-1]:X:SCAL:LEFT<br>:DISP:PN[1-1]:TRAC[1-1]:X:SCAL:RIGH |
| <b>Left</b>                     | Sets/Reads the start value of the X-axis display range                                      | :DISP:PN[1-1]:TRAC[1-1]:X:SCAL:LEFT                                        |
| <b>Right</b>                    | Sets/Reads the stop value of the X-axis display range                                       | :DISP:PN[1-1]:TRAC[1-1]:X:SCAL:RIGH                                        |
| <b>Setup</b>                    |                                                                                             |                                                                            |
| <b>Carrier Search</b>           | Searches carrier signal and reflects the result to the input frequency of the downconverter | :SENS:FP[1-1]:DCON:SSE:EXEC                                                |
| <b>Frequency Band</b>           | Selects frequency band                                                                      | :SENS:PN[1-1]:FBAN                                                         |
| <b>IF Gain</b>                  | Sets/reads the IF Gain                                                                      | :SENS:PN[1-1]:IFG                                                          |

**Table D-1 PN Menu**

| Key Operation                        | Function                                                         | SCPI Command                       |
|--------------------------------------|------------------------------------------------------------------|------------------------------------|
| <b>LO PhNoise Optimize</b>           | Sets/reads phase noise Local bandwidth optimization.             | :SENS:PN[1-1]:LOB                  |
| <b>Measurement Quality</b>           | Sets/reads the quality level                                     | :SENS:PN[1-1]:SEGT[:MEAS][:QUAL]   |
| <b>Nominal Frequency</b>             | Sets/reads input frequency of the downconverter                  | :SENS:FP[1-1]:DCON:FREQ            |
| <b>Start</b>                         |                                                                  |                                    |
| <b>100Hz</b>                         | Sets 100Hz to the start frequency                                | :SENS:PN[1-1]:FREQ:STAR            |
| <b>10Hz</b>                          | Sets 10Hz to the start frequency                                 | :SENS:PN[1-1]:FREQ:STAR            |
| <b>1Hz</b>                           | Sets 1Hz to the start frequency                                  | :SENS:PN[1-1]:FREQ:STAR            |
| <b>1kHz</b>                          | Sets 1kHz to the start frequency                                 | :SENS:PN[1-1]:FREQ:STAR            |
| <b>Stop</b>                          |                                                                  |                                    |
| <b>100kHz</b>                        | Sets 100kHz to the stop frequency                                | :SENS:PN[1-1]:FREQ:STOP            |
| <b>10MHz</b>                         | Sets 10MHz to the stop frequency                                 | :SENS:PN[1-1]:FREQ:STOP            |
| <b>1MHz</b>                          | Sets 1MHz to the stop frequency                                  | :SENS:PN[1-1]:FREQ:STOP            |
| <b>20MHz</b>                         | Sets 20MHz to the stop frequency                                 | :SENS:PN[1-1]:FREQ:STOP            |
| <b>40MHz</b>                         | Sets 40MHz to the stop frequency                                 | :SENS:PN[1-1]:FREQ:STOP            |
| <b>5MHz</b>                          | Sets 5MHz to the stop frequency                                  | :SENS:PN[1-1]:FREQ:STOP            |
| <b>System</b>                        |                                                                  |                                    |
| <b>Abort Printing</b>                | Aborts printing                                                  | :HCOP:ABOR                         |
| <b>Backlight</b>                     | Turns on/off backlight                                           | :SYST:BACK:STAT                    |
| <b>Dump Screen Image</b>             | Save screen image                                                | :MMEM:STOR:IMAG                    |
| <b>Instrument Setup</b>              |                                                                  |                                    |
| <b>Correction</b>                    |                                                                  |                                    |
| <b>File Dialog ...</b>               | Loads correction data for a specified power                      | :MMEM:LOAD:CORR:POW                |
| <b>Import Power Correction Table</b> | Loads correction data for a specified power                      | :MMEM:LOAD:CORR:POW                |
| <b>Power Correction</b>              | Sets user the user calibration on or off or reads its setting    | :SENS:CORR:POW:STAT                |
| <b>Downconverter Manual Setup</b>    |                                                                  |                                    |
| <b>Current</b>                       | Sets/reads the bias current to be supplied to the external mixer | :SENS:DCON:MAN:MEXT[1-2]:BIAS:CURR |
| <b>IF Gain 1</b>                     | Sets/reads the IF gain of the external mixer                     | :SENS:DCON:MAN:IFG[1-2]            |
| <b>IF Gain 2</b>                     |                                                                  |                                    |

**Table D-1 PN Menu**

| Key Operation                                | Function                                                                              | SCPI Command                       |
|----------------------------------------------|---------------------------------------------------------------------------------------|------------------------------------|
| <b>LO1 Frequency</b><br><b>LO2 Frequency</b> | Sets/reads the LO frequency of the external mixer                                     | :SENS:DCON:MAN:LO[1-2]:FREQ        |
| <b>LO1 Level</b><br><b>LO2 Level</b>         | Sets/reads the LO level of the external mixer                                         | :SENS:DCON:MAN:LO[1-2]:LEV         |
| <b>Mixer 1 Bias</b><br><b>Mixer 2 Bias</b>   | Sets the bias current supplied to the external mixer on or off and reads its settings | :SENS:DCON:MAN:MEXT[1-2]:BIAS:STAT |
| $\Delta F = IF2 - IF1$                       | Sets/reads the differential frequency between CH1 and CH2 from the external mixer     | :SENS:DCON:MAN:IFD                 |
| <b>Frequency Offset (User Downconv.)</b>     |                                                                                       |                                    |
| <b>Conversion Mode</b>                       | Sets/reads the conversion mode of the frequency offset                                | :SENS:UDC:MODE                     |
| <b>Frequency Offset</b>                      | Sets/reads the frequency offset                                                       | :SENS:UDC:STAT                     |
| <b>Harmonic #</b>                            | Sets/reads the frequency offset factor                                                | :SENS:UDC:HARM                     |
| <b>LO Frequency</b>                          | Sets/reads the LO frequency of the frequency offset                                   | :SENS:UDC:LO                       |
| <b>PN Ext. Prescaler</b>                     |                                                                                       |                                    |
| <b>Division</b>                              | Sets/Reads the frequency-dividing ratio                                               | :SENS:PN[1-1]:EPR:DIV              |
| <b>Output Power Level</b>                    | Sets/Reads the output level of the frequency divider                                  | :SENS:PN[1-1]:EPR:POW              |
| <b>Invert Image</b>                          | Selects print mode                                                                    | :HCOP:IMAG                         |
| <b>Misc Setup</b>                            |                                                                                       |                                    |
| <b>Beeper</b>                                |                                                                                       |                                    |
| <b>Beep Complete</b>                         | Turns on/off the beep for operation completion                                        | :SYST:BEEP:COMP:STAT               |
| <b>Beep Warning</b>                          | Turns on/off the beep for warning                                                     | :SYST:BEEP:WARN:STAT               |
| <b>Test Beep Complete</b>                    | Makes beep sound for operation completion                                             | :SYST:BEEP:COMP:IMM                |
| <b>Test Beep Warning</b>                     | Makes beep sound for warning                                                          | :SYST:BEEP:WARN:IMM                |
| <b>Clock Setup</b>                           |                                                                                       |                                    |
| <b>Set Date and Time</b>                     | Set/reads system time<br>Set/reads system date                                        | :SYST:TIME<br>:SYST:DATE           |
| <b>Show Clock</b>                            | Turns on/off internal clock display                                                   | :DISP:CLOC                         |

**Table D-1 PN Menu**

| Key Operation         | Function                                                       | SCPI Command                |
|-----------------------|----------------------------------------------------------------|-----------------------------|
| <b>Color Setup</b>    |                                                                |                             |
| <b>Invert</b>         | Sets each color when the inverted display is selected          |                             |
| <b>Background</b>     | Sets/Reads the background color                                | :DISP:COL2:BACK[:VAL]       |
| <b>Data Trace 1</b>   | Sets/Reads the color of the data trace of trace 1              | :DISP:COL2:TRAC1:DATA[:VAL] |
| :                     |                                                                |                             |
| <b>Data Trace 8</b>   | Sets/Reads the color of the data trace of trace 8              | :DISP:COL2:TRAC8:DATA[:VAL] |
| <b>Graticule Main</b> | Sets/Reads the color of the graph                              | :DISP:COL2:GRAT1[:VAL]      |
| <b>Graticule Sub</b>  | Sets/Reads the color of the grid line of the graph             | :DISP:COL2:GRAT2[:VAL]      |
| <b>Limit Fail</b>     | Sets/Reads the limit display color                             | :DISP:COL2:LIM1[:VAL]       |
| <b>Limit Line</b>     | Sets/Reads the color of the limit line                         | :DISP:COL2:LIM2[:VAL]       |
| <b>Mem Trace 1</b>    | Sets/Reads the color of the memory trace of trace 1            | :DISP:COL2:TRAC1:MEM[:VAL]  |
| :                     |                                                                |                             |
| <b>Mem Trace 8</b>    | Sets/Reads the color of the memory trace of trace 8            | :DISP:COL2:TRAC8:MEM[:VAL]  |
| <b>Reset Color</b>    | Resets the display color to the factory preset default setting | :DISP:COL2:RES              |
| <b>Normal</b>         | Sets each color when the normal display is selected            |                             |
| <b>Background</b>     | Sets/Reads the background color                                | :DISP:COL1:BACK[:VAL]       |
| <b>Data Trace 1</b>   | Sets/Reads the color of the data trace of trace 1              | :DISP:COL1:TRAC1:DATA[:VAL] |
| :                     |                                                                |                             |
| <b>Data Trace 8</b>   | Sets/Reads the color of the data trace of trace 8              | :DISP:COL1:TRAC8:DATA[:VAL] |
| <b>Graticule Main</b> | Sets/Reads the color of the graph                              | :DISP:COL1:GRAT1[:VAL]      |
| <b>Graticule Sub</b>  | Sets/Reads the color of the grid lines in the graph            | :DISP:COL1:GRAT2[:VAL]      |
| <b>Limit Fail</b>     | Sets/Reads the limit display color                             | :DISP:COL1:LIM1[:VAL]       |
| <b>Limit Line</b>     | Sets/Reads the color of the limit line                         | :DISP:COL1:LIM2[:VAL]       |
| <b>Mem Trace 1</b>    | Sets/Reads the color of the memory trace of trace 1            | :DISP:COL1:TRAC1:MEM[:VAL]  |

Table D-1 PN Menu

| Key Operation                          | Function                                                                                              | SCPI Command               |
|----------------------------------------|-------------------------------------------------------------------------------------------------------|----------------------------|
| :                                      |                                                                                                       |                            |
| :                                      |                                                                                                       |                            |
| <b>Mem Trace 8</b>                     | Sets/Reads the color of the memory trace of trace 8                                                   | :DISP:COL1:TRAC8:MEM[:VAL] |
| <b>Reset Color</b>                     | Resets the display color to the factory preset default setting                                        | :DISP:COL1:RES             |
| <b>Control Panel ...</b>               | Open control panel                                                                                    |                            |
| <b>GPIB Setup</b>                      |                                                                                                       |                            |
| <b>System Controller Configuration</b> | Turns on/off system controller mode                                                                   |                            |
| <b>Talker/Listener Address</b>         | Sets/the address for controlling the analyzer from a controller via GPIB                              |                            |
| <b>Key Lock</b>                        |                                                                                                       |                            |
| <b>Front Panel &amp; Keyboard Lock</b> | Disables from panel/keyboard operations                                                               | :SYST:KLOC:KBD             |
| <b>Touch Screen &amp; Mouse Lock</b>   | Disables from touch screen/mouse operations                                                           | :SYST:KLOC:MOUS            |
| <b>Network Setup</b>                   |                                                                                                       |                            |
| <b>MAC Address</b>                     | Sets MAC address                                                                                      |                            |
| <b>Network Configuration ...</b>       | Enables/disables network connections                                                                  |                            |
| <b>Network Identification ...</b>      | Sets network ID of the instrument                                                                     |                            |
| <b>SICL-LAN Address</b>                | Sets SICL-LAN address                                                                                 |                            |
| <b>SICL-LAN Server</b>                 | Enables/disables SICL-LAN server                                                                      |                            |
| <b>Socket Server</b>                   | Enables/disables Socket server                                                                        |                            |
| <b>Telnet Server</b>                   | Enables/disables Telnet server                                                                        |                            |
| <b>Print</b>                           | Outputs print                                                                                         | :HCOP:IMM                  |
| <b>Printer Setup ...</b>               | Executes printer setup                                                                                |                            |
| <b>Product Information</b>             | Reads product information                                                                             |                            |
| <b>Service Menu</b>                    |                                                                                                       |                            |
| <b>Administrator Menu</b>              | Displays softkeys associated with Administrator Menu. This function is not available to general users |                            |

**Table D-1 PN Menu**

| Key Operation                 | Function                                                                                         | SCPI Command                         |
|-------------------------------|--------------------------------------------------------------------------------------------------|--------------------------------------|
| <b>Error Log</b>              |                                                                                                  |                                      |
| <b>Clear Error Log</b>        | Clears the error log                                                                             |                                      |
| <b>View Error Log ...</b>     | Displays the error log                                                                           |                                      |
| <b>Install Option License</b> |                                                                                                  |                                      |
| <b>Jitter</b>                 | Enters license for clock jitter analysis                                                         |                                      |
| <b>Service Function</b>       | Displays softkeys associated with Service Menu. This function is not available to general users. |                                      |
| <b>Test Menu</b>              |                                                                                                  |                                      |
| <b>Power On Test</b>          | Performs internal test                                                                           |                                      |
| <b>Display Test</b>           | Performs display test                                                                            |                                      |
| <b>Front Panel</b>            | Performs front panel key (hard key) test                                                         |                                      |
| <b>Adjust Touch Screen</b>    | Performs touch screen calibration                                                                |                                      |
| <b>E5053A Test</b>            | Displays the connection status of E5053A                                                         |                                      |
| <b>Trace View</b>             |                                                                                                  |                                      |
| <b>Aperture</b>               | Smoothing aperture                                                                               | :CALC:PN[1-1]:TRAC[1-1]:SMO:APER     |
| <b>Copy to User</b>           | Copies trace data to the user trace                                                              | :CALC:PN[1-1]:TRAC[1-1]:DATA:COPY    |
| <b>Data -&gt; Mem</b>         | Copy data to memory                                                                              | :CALC:PN[1-1]:TRAC[1-1]:MATH:MEM     |
| <b>Data Hold</b>              | Data hold                                                                                        | :CALC:PN[1-1]:TRAC[1-1]:HOLD         |
| <b>Data Math</b>              | Sets/reads math operation type                                                                   | :CALC:PN[1-1]:TRAC[1-1]:MATH:FUNC    |
| <b>Display Trace</b>          | Shows data and/or memory trace                                                                   | :DISP:PN[1-1]:TRAC[1-1]:MODE         |
| <b>Marker -&gt; -Offset</b>   | Sets sign-inverted data value of the data trace's active marker to the offset value              | :CALC:PN[1-1]:TRAC[1-1]:MATH:OFFS    |
| <b>Offset</b>                 | Sets/Reads the offset value of the data trace                                                    | :CALC:PN[1-1]:TRAC[1-1]:MATH:OFFS    |
| <b>Persistence</b>            |                                                                                                  |                                      |
| <b>Clear Persistent Data</b>  | Clears persistent mode                                                                           | :DISP:PN[1-1]:TRAC[1-4]:PERSIST:CLE  |
| <b>Persistence Mode</b>       | Sets/reads persistent mode                                                                       | :DISP:PN[1-1]:TRAC[1-4]:PERSIST:STAT |

**Table D-1 PN Menu**

| Key Operation                     | Function                                                                                           | SCPI Command                                                          |
|-----------------------------------|----------------------------------------------------------------------------------------------------|-----------------------------------------------------------------------|
| <b>Smoothing</b>                  | Smoothing on/off                                                                                   | :CALC:PN[1-1]:TRAC[1-1]:SMO:STAT                                      |
| <b>Spurious</b>                   |                                                                                                    |                                                                       |
| <b>Clear Threshold Table</b>      | Clears the threshold data                                                                          | :CALC:PN[1-1]:TRAC[1-1]:SPUR:THR:TABL:CLE                             |
| <b>Import Threshold Table ...</b> | Reads the threshold data                                                                           | :MMEM:PN[1-1]:TRAC[1-1]:LOAD:SPUR:THR                                 |
| <b>Minimum Spur Level</b>         | Sets/Reads the minimum spurious level                                                              | :CALC:PN[1-1]:TRAC[1-1]:SPUR:THR:LEV:MIN                              |
| <b>Normalized (dBc/Hz)</b>        | Disables the spurious power value display                                                          | :CALC:PN[1-1]:TRAC[1-1]:SPUR:POW<br>:CALC:PN[1-1]:TRAC[1-1]:SPUR:OMIS |
| <b>Omit</b>                       | Enables the spurious display omission                                                              | :CALC:PN[1-1]:TRAC[1-1]:SPUR:OMIS                                     |
| <b>Power (dBc)</b>                | Enables the spurious power value display                                                           | :CALC:PN[1-1]:TRAC[1-1]:SPUR:POW                                      |
| <b>Spurious List</b>              | Display the spurious data                                                                          |                                                                       |
| <b>Trace Label</b>                | Edit trace title label                                                                             | :DISP:PN[1-1]:TRAC[1-1]:LAB:DATA                                      |
| <b>Trigger</b>                    |                                                                                                    |                                                                       |
| <b>Average Trigger</b>            | Sets/Reads the averaging trigger function                                                          | :TRIG:AVER                                                            |
| <b>Continuous</b>                 | Sets/reads trigger continuous mode                                                                 | :INIT:PN[1-1]:CONT<br>:INIT:PN[1-1]:IMM                               |
| <b>Ext Trig Polarity</b>          | External trigger polarity                                                                          | :TRIG:EXT:SLOP                                                        |
| <b>Hold</b>                       | Sets trigger mode to waiting-for-trigger state                                                     | :INIT:PN[1-1]:IMM                                                     |
| <b>Manual Trigger</b>             | move once to waiting-for-trigger state                                                             | :INIT:PN[1-1]:IMM                                                     |
| <b>Restart</b>                    | move once to waiting-for-trigger state                                                             | :INIT:PN[1-1]:IMM                                                     |
| <b>Single</b>                     | always move to waiting-for-trigger state after measuring<br>move once to waiting-for-trigger state | :INIT:PN[1-1]:CONT<br>:INIT:PN[1-1]:IMM                               |
| <b>Source</b>                     | trigger source                                                                                     | :TRIG:PN[1-1]:SOUR                                                    |
| <b>Trigger to Phase Noise</b>     | select measurement mode                                                                            | :TRIG:MODE                                                            |



## Spectrum Monitor Menu (Top Menu)

| Key Operation                                  | Function                                                                                                             |
|------------------------------------------------|----------------------------------------------------------------------------------------------------------------------|
| <b>Double-click on each softkey menu title</b> | Displays the top menu of each menu item below. Refer the SP menu about detail of following each menu item.           |
| <b>Measurement View</b>                        | Same as <b>Meas</b> .                                                                                                |
| <b>Input</b>                                   | Same as <b>Scale</b> .                                                                                               |
| <b>Scale</b>                                   | Same as <b>Scale</b> .                                                                                               |
| <b>Format</b>                                  | Same as <b>Format</b> .                                                                                              |
| <b>Display</b>                                 | Same as <b>Display</b> .                                                                                             |
| <b>Average</b>                                 | Same as <b>Avg</b> .                                                                                                 |
| <b>Attenuator</b>                              | Same as <b>Cal</b> .                                                                                                 |
| <b>Start/Center</b>                            | Displays the same softkey for setting up the sweep range that appears when <b>Start</b> , or <b>Span</b> is pressed. |
| <b>Stop/Span</b>                               | Displays the same softkey for setting up the sweep range that appears when <b>Start</b> , or <b>Span</b> is pressed. |
| <b>DC Conrol Voltage</b>                       | Same as <b>Sweep Setup</b> .                                                                                         |
| <b>DC Power Voltage</b>                        | Same as <b>Sweep Setup</b> .                                                                                         |
| <b>Setup</b>                                   | Same as <b>Sweep Setup</b> .                                                                                         |
| <b>Trigger</b>                                 | Same as <b>Trigger</b> .                                                                                             |
| <b>Marker</b>                                  | Same as <b>Marker</b> .                                                                                              |
| <b>Marker Search</b>                           | Same as <b>Marker Search</b> .                                                                                       |
| <b>Marker To</b>                               | Same as <b>Marker Search</b> .                                                                                       |
| <b>Marker Function</b>                         | Same as <b>Marker Fctn</b> .                                                                                         |
| <b>Macro Setup</b>                             | Same as <b>Macro Setup</b> .                                                                                         |
| <b>Save/Recall</b>                             | Same as <b>Save/Recall</b> .                                                                                         |
| <b>System</b>                                  | Same as <b>System</b> .                                                                                              |
| <b>Preset</b>                                  | Same as <b>Preset</b> .                                                                                              |

## SP Menu

Table D-2 SP Menu

| Key Operation                      | Function                                                                                     | SCPI Command                                              |
|------------------------------------|----------------------------------------------------------------------------------------------|-----------------------------------------------------------|
| <b>Attenuator</b>                  |                                                                                              |                                                           |
| <b>Input Attenuator</b>            | Sets/reads Input Attenuator level on 5dB Step                                                | :SENS:ATT:LEV                                             |
| <b>Average/BW</b>                  |                                                                                              |                                                           |
| <b>Averaging</b>                   | Turns on/off averaging function                                                              | :SENS:SP[1-1]:AVER:STAT                                   |
| <b>Averaging Restart</b>           | Restart averaging                                                                            | :SENS:SP[1-1]:AVER:CLE                                    |
| <b>Averaging Type</b>              | Sets/reads averaging type                                                                    | :SENS:SP[1-1]:AVER:TYPE                                   |
| <b>Avg Factor</b>                  | Sets/reads the averaging count                                                               | :SENS:SP[1-1]:AVER:COUN                                   |
| <b>RBW</b>                         | Sets/reads RBW value                                                                         | :SENS:SP[1-1]:BAND:RES                                    |
| <b>DC Control Voltage</b>          |                                                                                              |                                                           |
| <b>Auto Freq Control</b>           |                                                                                              |                                                           |
| <b>AFC Status</b>                  | Turns on/off the auto frequency control function<br>Executes the auto frequency control once | :SOUR:VOLT:CONT:AFC[:STAT<br>]<br>:SOUR:VOLT:CONT:AFC:IMM |
| <b>Frequency Band</b>              | Sets/reads the frequency band in the auto frequency control function                         | :SOUR:VOLT:CONT:AFC:FBAN                                  |
| <b>Max Ctrl Voltage Limit</b>      | Sets/reads the maximum DC control voltage limit                                              | :SOUR:VOLT:CONT:AFC:LIM:<br>HIGH                          |
| <b>Max Input Level</b>             | Sets/reads the maximum input level                                                           | :SOUR:VOLT:CONT:AFC:INP:L<br>EV:MAX                       |
| <b>Max Iteration</b>               | Sets/reads the maximum number of iterations for the DC control voltage-setting loops         | :SOUR:VOLT:CONT:AFC:ITER                                  |
| <b>Min Ctrl Voltage Limit</b>      | Sets/reads the minimum DC control voltage limit                                              | :SOUR:VOLT:CONT:AFC:LIM:<br>LOW                           |
| <b>Sensitivity</b>                 | Sets/reads the tuning sensitivity                                                            | :SOUR:VOLT:CONT:AFC:SENS                                  |
| <b>Target</b>                      | Sets/reads the target frequency in the auto frequency control function                       | :SOUR:VOLT:CONT:AFC:TARG                                  |
| <b>Tolerance</b>                   | Sets/reads the tolerance limit                                                               | :SOUR:VOLT:CONT:AFC:TOL                                   |
| <b>Control Voltage Cal</b>         | Enables DC Control voltage calibration                                                       | :SOUR:VOLT:CONT:CORR[:ST<br>AT]                           |
| <b>DC Control Delay</b>            | Sets/reads DC Control delay (sec)                                                            | :SOUR:VOLT:CONT:DEL                                       |
| <b>DC Control Output</b>           | Turns on/off DC Control voltage                                                              | :SOUR:VOLT:CONT:LEV:STAT                                  |
| <b>DC Control Voltage</b>          | Sets/reads DC Control voltage                                                                | :SOUR:VOLT:CONT:LEV:AMP<br>L                              |
| <b>Execute Control Voltage Cal</b> | Execute DC Control voltage calibration                                                       | :SOUR:VOLT:CONT:CORR:CO<br>LL:ACQ                         |

**Table D-2 SP Menu**

| Key Operation                      | Function                                                     | SCPI Command                             |
|------------------------------------|--------------------------------------------------------------|------------------------------------------|
| <b>Max Ctrl Voltage Limit</b>      | Sets/reads the maximum DC Control voltage limit              | :SOUR:VOLT:CONT:LIM:HIGH                 |
| <b>Min Ctrl Voltage Limit</b>      | Sets/reads the minimum DC Control voltage limit              | :SOUR:VOLT:CONT:LIM:LOW                  |
| <b>DC Power Voltage</b>            |                                                              |                                          |
| <b>DC Power Delay</b>              | Sets/reads DC Power delay (sec)                              | :SOUR:VOLT:POW:DEL                       |
| <b>DC Power Output</b>             | Turns on/off DC Power voltage                                | :SOUR:VOLT:POW:LEV:STAT                  |
| <b>DC Power Voltage</b>            | Sets/reads DC Power voltage                                  | :SOUR:VOLT:POW:LEV:AMPL                  |
| <b>Max Pwr Voltage Limit</b>       | Sets/reads the maximum DC Power voltage limit                | :SOUR:VOLT:POW:LIM:HIGH                  |
| <b>Min Pwr Voltage Limit</b>       | Sets/reads the minimum DC Power voltage limit                | :SOUR:VOLT:POW:LIM:LOW                   |
| <b>Display</b>                     |                                                              |                                          |
| <b>Edit Title Label</b>            | Edits the measurement window title label                     | :DISP:SP[1-1]:LAB:DATA                   |
| <b>Color Type</b>                  | Sets/Reads the display type of the display (normal/inverted) | :DISP:IMAG                               |
| <b>Limit Test</b>                  |                                                              |                                          |
| <b>Delete Lower Limit Line</b>     | Clears the lower limit line                                  | :CALC:SP[1-1]:TRAC[1-1]:LIM:LOW:SEGM:CLE |
| <b>Delete Upper Limit Line</b>     | Clears the upper limit line                                  | :CALC:SP[1-1]:TRAC[1-1]:LIM:UPP:SEGM:CLE |
| <b>Explorer</b>                    |                                                              |                                          |
| <b>Fail Sign</b>                   | Turns on/off the limit test judgement display                | :DISP:SP[1-1]:LIM:FSIG                   |
| <b>Import Lower Limit Line ...</b> | Reads the lower limit line                                   | :MMEM:SP[1-1]:TRAC[1-1]:LOAD:LIM:LOW     |
| <b>Import Upper Limit Line ...</b> | Reads the upper limit line                                   | :MMEM:SP[1-1]:TRAC[1-1]:LOAD:LIM:UPP     |
| <b>Limit Line</b>                  | Turns on/off the limit line                                  | :DISP:SP[1-1]:TRAC[1-1]:LIM:LINE         |
| <b>Limit Test</b>                  | Turns on/off the limit test function                         | :CALC:SP[1-1]:TRAC[1-1]:LIM[:STAT]       |
| <b>Marker Information</b>          | Sets/reads the marker information position                   | :DISP:SP[1-1]:ANN:MARK:POS               |
| <b>Meas Condition</b>              | Turns on/off measurement conditions                          | :DISP:SP[1-1]:ANN:MEAS:STAT              |
| <b>Relative Y-Scale</b>            | Turns on/off relative Y-scale                                | :DISP:SP[1-1]:GRAT:AXIS:Y:REL            |
| <b>Security Level</b>              | Sets/recalls the security level                              | :SYST:SEC[:LEV]                          |
| <b>Title Label</b>                 | Turns on/off measurement window title label                  | :DISP:SP[1-1]:LAB:STAT                   |
| <b>Update</b>                      | Turns on/off trace updates                                   | :DISP:ENAB                               |

**Table D-2 SP Menu**

| Key Operation           | Function                                                            | SCPI Command                   |
|-------------------------|---------------------------------------------------------------------|--------------------------------|
| <b>Y # of Digits</b>    | Selects the number of digits (Y-axis)                               | :DISP:SP[1-1]:GRAT:AXIS:Y:STAT |
| <b>Format</b>           |                                                                     |                                |
| <b>Detector Mode</b>    | Sets/reads the detector mode                                        | :SENS:SP[1-1]:DET:FUNC         |
| <b>Format</b>           | SP format                                                           | :CALC:SP[1-1]:TRAC[1-1]:FORM   |
| <b>Input Port</b>       |                                                                     |                                |
| <b>Downconverter</b>    |                                                                     |                                |
| <b>Downconverter</b>    | Sets the use of the downconverter on or off, or reads its setting   | :SENS:DCON[:STAT]              |
| <b>RF Input</b>         | Sets/reads the signal supplied to the RF input port                 | :SENS:DCON:INP                 |
| <b>External Mixer</b>   | Sets the use of the external mixer on or off and reads its settings | :SENS:DCON:MEXT                |
| <b>Macro Setup</b>      |                                                                     |                                |
| <b>Application</b>      |                                                                     |                                |
| <b>Jitter</b>           | Executes clock jitter analysis (VBA)                                |                                |
| <b>mmWave</b>           | Executes phase-noise measurement (VBA)                              |                                |
| <b>E5052 Event</b>      | Turns on/off the E5052 VBA event callback function                  | :PROG:COM:EVEN                 |
| <b>Echo Window Menu</b> |                                                                     |                                |
| <b>Clear Echo</b>       | Clears Echo window                                                  | :DISP:ECHO:CLE                 |
| <b>Echo Font Size</b>   | Sets/reads the font size on Echo window                             | :DISP:ECHO:FSIZ                |
| <b>Echo Window</b>      | Turns on/off the Echo window                                        | :DISP:ECHO:STAT                |
| <b>Load &amp; Run</b>   | Load and execute the macro selected on file names                   |                                |
| <b>Select Macro</b>     | Sets/reads the name of the program to be selected                   | :PROG:SEL:NAME                 |
| <b>Stop</b>             | Set/reads the state of the selected program                         | :PROG:SEL:STAT                 |
| <b>User Menu</b>        |                                                                     |                                |
| <b>User Label 1</b>     | Execute the macro assigned under the user defined softkey           | :PROG:SKEY:ITEM[1-8]:IMM       |
| <b>User Label 2</b>     | Execute the macro assigned under the user defined softkey           | :PROG:SKEY:ITEM[1-8]:IMM       |
| <b>User Label 3</b>     | Execute the macro assigned under the user defined softkey           | :PROG:SKEY:ITEM[1-8]:IMM       |
| <b>User Label 4</b>     | Execute the macro assigned under the user defined softkey           | :PROG:SKEY:ITEM[1-8]:IMM       |
| <b>User Label 5</b>     | Execute the macro assigned under the user defined softkey           | :PROG:SKEY:ITEM[1-8]:IMM       |
| <b>User Label 6</b>     | Execute the macro assigned under the user defined softkey           | :PROG:SKEY:ITEM[1-8]:IMM       |
| <b>User Label 7</b>     | Execute the macro assigned under the user defined softkey           | :PROG:SKEY:ITEM[1-8]:IMM       |
| <b>User Label 8</b>     | Execute the macro assigned under the user defined softkey           | :PROG:SKEY:ITEM[1-8]:IMM       |

**Table D-2 SP Menu**

| Key Operation            | Function                                         | SCPI Command                            |
|--------------------------|--------------------------------------------------|-----------------------------------------|
| <b>VBA Editor Menu</b>   |                                                  |                                         |
| <b>Close Editor</b>      | Close VBA editor                                 |                                         |
| <b>Load Project</b>      | Loads program                                    | :MMEM:LOAD:PROG                         |
| <b>New Project</b>       | Open new VBA project                             |                                         |
| <b>Open Editor</b>       | Open VBA editor                                  |                                         |
| <b>Save Project</b>      | Save VBA project                                 | :MMEM:STOR:PROG                         |
| <b>Marker</b>            |                                                  |                                         |
| <b>Clear Marker Menu</b> |                                                  |                                         |
| <b>All OFF</b>           | Clears all the markers                           |                                         |
| <b>Marker 1</b>          | Turns on/off marker 1                            | :CALC:SP[1-1]:TRAC[1-1]:MARK[1-10]:STAT |
| :                        |                                                  |                                         |
| :                        |                                                  |                                         |
| <b>Marker 10</b>         | Turns on/off marker 10                           | :CALC:SP[1-1]:TRAC[1-1]:MARK[1-10]:STAT |
| <b>Marker 1</b>          | Turns on/off marker 1                            | :CALC:SP[1-1]:TRAC[1-1]:MARK[1-10]:STAT |
| :                        |                                                  |                                         |
| :                        |                                                  |                                         |
| <b>Marker 6</b>          | Turns on/off marker 6                            | :CALC:SP[1-1]:TRAC[1-1]:MARK[1-10]:STAT |
| <b>Marker List</b>       | Turns on/off the marker list                     | :DISP:SP[1-1]:TABL[:STAT]               |
| <b>More Functions</b>    |                                                  |                                         |
| <b>Discrete</b>          | Sets/reads marker movement (Continuous/Discrete) | :CALC:SP[1-1]:ALLT:MARK:DISC:STAT       |
| <b>Ref Marker</b>        | Sets/reads marker reference number               | :CALC:SP[1-1]:ALLT:MARK:REF:NUMB        |
| <b>Ref Marker Mode</b>   | Turns on/off delta marker mode                   | :CALC:SP[1-1]:ALLT:MARK:REF:STAT        |
| <b>More Markers</b>      |                                                  |                                         |
| <b>Marker 7</b>          | Turns on/off marker 6                            | :CALC:SP[1-1]:TRAC[1-1]:MARK[1-10]:STAT |
| :                        |                                                  |                                         |
| :                        |                                                  |                                         |
| <b>Marker 10</b>         | Turns on/off marker 6                            | :CALC:SP[1-1]:TRAC[1-1]:MARK[1-10]:STAT |

Table D-2 SP Menu

| Key Operation             | Function                                    | SCPI Command                           |
|---------------------------|---------------------------------------------|----------------------------------------|
| <b>Marker Function</b>    |                                             |                                        |
| <b>Analysis Range (X)</b> | Sets/reads analysis/search range (X-axis)   | :CALC:SP[1-1]:TRAC[1-1]:FUNCTION:DOM:X |
| <b>Analysis Range (Y)</b> | Sets/reads analysis/search range (Y-axis)   | :CALC:SP[1-1]:TRAC[1-1]:FUNCTION:DOM:Y |
| <b>Analysis Type</b>      | Sets/reads analysis type                    | :CALC:SP[1-1]:TRAC[1-1]:FUNCTION:TYPE  |
| <b>Band Marker X</b>      |                                             |                                        |
| <b>Band Marker X</b>      | Turns on/off bandmarker X                   | :CALC:SP[1-1]:TRAC[1-1]:BDM:X:STAT     |
| <b>Center</b>             | Sets/reads the center value of bandmarker X | :CALC:SP[1-1]:TRAC[1-1]:BDM:X:CENT     |
| <b>Span</b>               | Sets/reads the span value of bandmarker X   | :CALC:SP[1-1]:TRAC[1-1]:BDM:X:SPAN     |
| <b>Start</b>              | Sets/reads the start value of bandmarker X  | :CALC:SP[1-1]:TRAC[1-1]:BDM:X:STAR     |
| <b>Stop</b>               | Sets/reads the stop value of bandmarker X   | :CALC:SP[1-1]:TRAC[1-1]:BDM:X:STOP     |
| <b>Band Marker Y</b>      |                                             |                                        |
| <b>Band Marker Y</b>      | Turns on/off bandmarker Y                   | :CALC:SP[1-1]:TRAC[1-1]:BDM:Y:STAT     |
| <b>Center</b>             | Sets/reads the center value of bandmarker Y | :CALC:SP[1-1]:TRAC[1-1]:BDM:Y:CENT     |
| <b>Span</b>               | Sets/reads the span value of bandmarker Y   | :CALC:SP[1-1]:TRAC[1-1]:BDM:Y:SPAN     |
| <b>Start</b>              | Sets/reads the start value of bandmarker Y  | :CALC:SP[1-1]:TRAC[1-1]:BDM:Y:STAR     |
| <b>Stop</b>               | Sets/reads the stop value of bandmarker Y   | :CALC:SP[1-1]:TRAC[1-1]:BDM:Y:STOP     |
| <b>Marker Search</b>      |                                             |                                        |
| <b>Band Marker X</b>      |                                             |                                        |
| <b>Band Marker X</b>      | Turns on/off bandmarker X                   | :CALC:SP[1-1]:TRAC[1-1]:BDM:X:STAT     |
| <b>Center</b>             | Sets/reads the center value of bandmarker X | :CALC:SP[1-1]:TRAC[1-1]:BDM:X:CENT     |
| <b>Span</b>               | Sets/reads the span value of bandmarker X   | :CALC:SP[1-1]:TRAC[1-1]:BDM:X:SPAN     |
| <b>Start</b>              | Sets/reads the start value of bandmarker X  | :CALC:SP[1-1]:TRAC[1-1]:BDM:X:STAR     |
| <b>Stop</b>               | Sets/reads the stop value of bandmarker X   | :CALC:SP[1-1]:TRAC[1-1]:BDM:X:STOP     |

**Table D-2 SP Menu**

| Key Operation            | Function                                    | SCPI Command                                          |
|--------------------------|---------------------------------------------|-------------------------------------------------------|
| <b>Band Marker Y</b>     |                                             |                                                       |
| <b>Band Marker Y</b>     | Turns on/off bandmarker Y                   | :CALC:SP[1-1]:TRAC[1-1]:BDM<br>:Y:STAT                |
| <b>Center</b>            | Sets/reads the center value of bandmarker Y | :CALC:SP[1-1]:TRAC[1-1]:BDM<br>:Y:CENT                |
| <b>Span</b>              | Sets/reads the span value of bandmarker Y   | :CALC:SP[1-1]:TRAC[1-1]:BDM<br>:Y:SPAN                |
| <b>Start</b>             | Sets/reads the start value of bandmarker Y  | :CALC:SP[1-1]:TRAC[1-1]:BDM<br>:Y:STAR                |
| <b>Stop</b>              | Sets/reads the stop value of bandmarker Y   | :CALC:SP[1-1]:TRAC[1-1]:BDM<br>:Y:STOP                |
| <b>Peak</b>              |                                             |                                                       |
| <b>Peak Excursion</b>    | Sets/reads the peak excursion value         | :CALC:SP[1-1]:TRAC[1-1]:MAR<br>K[1-10]:SEAR:PEAK:EXC  |
| <b>Peak Polarity</b>     | Sets/reads the marker peak-search polarity  | :CALC:SP[1-1]:TRAC[1-1]:MAR<br>K[1-10]:SEAR:PEAK:POL  |
| <b>Search Left</b>       | Execute marker peak search left             | :CALC:SP[1-1]:TRAC[1-1]:MAR<br>K[1-10]:SEAR:EXEC:LPE  |
| <b>Search Peak</b>       | Execute marker peak search                  | :CALC:SP[1-1]:TRAC[1-1]:MAR<br>K[1-10]:SEAR:EXEC:PEAK |
| <b>Search Peak All</b>   | Execute marker search all                   | :CALC:SP[1-1]:TRAC[1-1]:ALL<br>M:SEAR:PEAK            |
| <b>Search Right</b>      | Execute marker peak search right            | :CALC:SP[1-1]:TRAC[1-1]:MAR<br>K[1-10]:SEAR:EXEC:RPE  |
| <b>Search Max</b>        | Execute marker search maximum               | :CALC:SP[1-1]:TRAC[1-1]:MAR<br>K[1-10]:SEAR:EXEC:MAX  |
| <b>Search Min</b>        | Execute marker search minimum               | :CALC:SP[1-1]:TRAC[1-1]:MAR<br>K[1-10]:SEAR:EXEC:MIN  |
| <b>Search Range (X)</b>  | Sets/reads marker search range (X-axis)     | :CALC:SP[1-1]:TRAC[1-1]:ALL<br>M:SEAR:DOM:X           |
| <b>Search Range (Y)</b>  | Sets/reads marker search range (Y-axis)     | :CALC:SP[1-1]:TRAC[1-1]:ALL<br>M:SEAR:DOM:Y           |
| <b>Target</b>            |                                             |                                                       |
| <b>Search Left</b>       | Execute marker target search left           | :CALC:SP[1-1]:TRAC[1-1]:MAR<br>K[1-10]:SEAR:EXEC:LTAR |
| <b>Search Right</b>      | Execute marker target search right          | :CALC:SP[1-1]:TRAC[1-1]:MAR<br>K[1-10]:SEAR:EXEC:RTAR |
| <b>Search Target</b>     | Execute marker target search                | :CALC:SP[1-1]:TRAC[1-1]:MAR<br>K[1-10]:SEAR:EXEC:TARG |
| <b>Target Transition</b> | Sets/reads the target transition definition | :CALC:SP[1-1]:TRAC[1-1]:MAR<br>K[1-10]:SEAR:TARG:TRAN |

**Table D-2 SP Menu**

| Key Operation           |                            | Function                                                     | SCPI Command                                      |
|-------------------------|----------------------------|--------------------------------------------------------------|---------------------------------------------------|
|                         | <b>Target Value</b>        | Sets/reads the marker target value                           | :CALC:SP[1-1]:TRAC[1-1]:MARK[1-10]:SEAR:TARG:Y    |
|                         | <b>Tracking</b>            | Sets/reads the marker tracking type                          | :CALC:SP[1-1]:TRAC[1-1]:MARK[1-10]:SEAR:TRAC:TYPE |
| <b>Marker To</b>        |                            |                                                              |                                                   |
|                         | <b>Marker -&gt; Center</b> | Sets/reads the center value of frequency span                | :SENS:SP[1-1]:FREQ:CENT                           |
|                         | <b>Marker -&gt; Start</b>  | Sets/reads the start value of frequency span                 | :SENS:SP[1-1]:FREQ:STAR                           |
|                         | <b>Marker -&gt; Stop</b>   | Sets/reads the stop value of frequency span                  | :SENS:SP[1-1]:FREQ:STOP                           |
| <b>Measurement View</b> |                            |                                                              |                                                   |
|                         | <b>Freq &amp; Power</b>    | Selects frequency, power and DC current measurement window   | :DISP:WIND:ACT                                    |
|                         | <b>Phase Noise</b>         | Selects phase noise measurement window                       | :DISP:WIND:ACT                                    |
|                         | <b>Show Window</b>         |                                                              |                                                   |
|                         | <b>Freq &amp; Power</b>    | Turn on/off frequency, power and DC current measurement mode | :DISP:FP[1-1]:STAT                                |
|                         | <b>Phase Noise</b>         | Turns on/off phase noise measurement mode                    | :DISP:PN[1-1]:STAT                                |
|                         | <b>Spectrum Monitor</b>    | Turns on/off spectrum monitor mode                           | :DISP:SP[1-1]:STAT                                |
|                         | <b>Transient</b>           | Turns on/off transient measurement mode                      | :DISP:TR[1-1]:STAT                                |
|                         | <b>User</b>                | Turns on/off user defined window                             | :DISP:USER[1-1]:STAT                              |
|                         | <b>Spectrum Monitor</b>    | Selects spectrum monitor mode                                | :DISP:WIND:ACT                                    |
|                         | <b>Transient</b>           | Selects transient measurement mode                           | :DISP:WIND:ACT                                    |
|                         | <b>User</b>                | Selects user defined window                                  | :DISP:WIND:ACT                                    |
| <b>Preset</b>           |                            |                                                              |                                                   |
|                         | <b>Factory</b>             | Preset instrument to the initial setup state                 | :SYST:PRES                                        |
|                         | <b>User</b>                | Preset instrument and recalls the Autorec.sta in the F drive |                                                   |
| <b>Save/Recall</b>      |                            |                                                              |                                                   |
|                         | <b>Explorer...</b>         | Open windows explorer                                        |                                                   |
|                         | <b>Recall by filename</b>  | Recalls state file by file name                              | :MMEM:LOAD:STAT                                   |
|                         | <b>Recall State</b>        |                                                              |                                                   |
|                         | <b>Autorec</b>             | Recalls settings                                             | :MMEM:LOAD:STAT                                   |
|                         | <b>File Dialog...</b>      | Open file dialog                                             |                                                   |
|                         | <b>State01</b>             | Recalls state file from register 1                           | :MMEM:LOAD:STAT                                   |
|                         | <b>State02</b>             | Recalls state file from register 2                           | :MMEM:LOAD:STAT                                   |
|                         | <b>State03</b>             | Recalls state file from register 3                           | :MMEM:LOAD:STAT                                   |
|                         | <b>State04</b>             | Recalls state file from register 4                           | :MMEM:LOAD:STAT                                   |



**Table D-2 SP Menu**

| Key Operation                   | Function                                                                       | SCPI Command                                                                |
|---------------------------------|--------------------------------------------------------------------------------|-----------------------------------------------------------------------------|
| <b>State05</b>                  | Recalls state file from register 5                                             | :MMEM:LOAD:STAT                                                             |
| <b>State06</b>                  | Recalls state file from register 6                                             | :MMEM:LOAD:STAT                                                             |
| <b>Save Data Trace</b>          | Saves trace data                                                               | :MMEM:SP[1-1]:TRAC[1-1]:STOR[:DATA]                                         |
| <b>Save Memory Trace</b>        | Saves memory trace data                                                        | :MMEM:SP[1-1]:TRAC[1-1]:STOR:MEM                                            |
| <b>Save State</b>               |                                                                                |                                                                             |
| <b>Autorec</b>                  | Save settings                                                                  | :MMEM:STOR:STAT                                                             |
| <b>File Dialog...</b>           | Open file dialog                                                               |                                                                             |
| <b>Save Type</b>                | Select instrument state type (Entire or instrument state only)                 | :MMEM:STOR:STYP                                                             |
| <b>State01</b>                  | Save state file to register 1                                                  | :MMEM:STOR:STAT                                                             |
| <b>State02</b>                  | Save state file to register 2                                                  | :MMEM:STOR:STAT                                                             |
| <b>State03</b>                  | Save state file to register 3                                                  | :MMEM:STOR:STAT                                                             |
| <b>State04</b>                  | Save state file to register 4                                                  | :MMEM:STOR:STAT                                                             |
| <b>State05</b>                  | Save state file to register 5                                                  | :MMEM:STOR:STAT                                                             |
| <b>State06</b>                  | Save state file to register 6                                                  | :MMEM:STOR:STAT                                                             |
| <b>Scale</b>                    |                                                                                |                                                                             |
| <b>Auto Scale</b>               | Execute autoscale                                                              | :DISP:SP[1-1]:TRAC[1-1]:Y[:SCAL]:AUTO                                       |
| <b>Divisions</b>                | Sets/reads Y-scale divisions                                                   | :DISP:SP[1-1]:Y[:SCAL]:DIV                                                  |
| <b>Marker -&gt; Reference</b>   | Sets the marker value to the reference level                                   | :DISP:SP[1-1]:TRAC[1-1]:Y[:SCAL]:RLEV                                       |
| <b>Reference Position</b>       | Sets/reads the reference position                                              | :DISP:SP[1-1]:TRAC[1-1]:Y[:SCAL]:RPOS                                       |
| <b>Reference Value</b>          | Sets/reads the reference level value                                           | :DISP:SP[1-1]:TRAC[1-1]:Y[:SCAL]:RLEV                                       |
| <b>Scale/Div</b>                | Sets/reads scale per division                                                  | :DISP:SP[1-1]:TRAC[1-1]:Y[:SCAL]:PDIV                                       |
| <b>X Axis</b>                   |                                                                                |                                                                             |
| <b>Auto</b>                     | Sets/Reads automatic setting of the X-axis display range to the stimulus value | :DISP:SP[1-1]:TRAC[1-1]:X:SCAL:AUTO                                         |
| <b>Band Marker -&gt; X Axis</b> | Sets the X-axis band marker range to the X-axis display range of a graph       | :DISP:SP[1-1]:TRAC[1-1]:X:SCAL:LEFT<br>:DISP:SP[1-1]:TRAC[1-1]:X:SCAL:RIGHT |
| <b>Left</b>                     | Sets/Reads the start value of the X-axis display range                         | :DISP:SP[1-1]:TRAC[1-1]:X:SCAL:LEFT                                         |
| <b>Right</b>                    | Sets/Reads the stop value of the X-axis display range                          | :DISP:SP[1-1]:TRAC[1-1]:X:SCAL:RIGHT                                        |

Table D-2 SP Menu

| Key Operation         | Function                                                                                                   | SCPI Command                      |
|-----------------------|------------------------------------------------------------------------------------------------------------|-----------------------------------|
| <b>Setup</b>          |                                                                                                            |                                   |
| Reference Level       | Sets/reads the reference level of frequency span                                                           | :SENS:SP[1-1]:POW:RLEV            |
| <b>Start/Center</b>   |                                                                                                            |                                   |
| <b>Carrier To</b>     |                                                                                                            |                                   |
| Carrier -> Center     | Changes the center frequency to the carrier frequency                                                      | :SENS:SP[1-1]:CARR:SET:CEN<br>T 1 |
| Carrier x 2 -> Center | Changes the center frequency to 2 times the carrier frequency                                              | :SENS:SP[1-1]:CARR:SET:CEN<br>T 2 |
| Carrier x 3 -> Center | Changes the center frequency to 3 times the carrier frequency                                              | :SENS:SP[1-1]:CARR:SET:CEN<br>T 3 |
| Carrier x # -> Center | Changes the center frequency to # times the carrier frequency (The # is assigned by <b>Harmonic #</b> key) | :SENS:SP[1-1]:CARR:SET:CEN<br>T # |
| Frequency Band        | Sets/reads the carrier frequency band                                                                      | :SENSe:SP[1-1]:CARRier:FBAN<br>d  |
| Harmonic #            | Sets the magnification of carrier frequency when center frequency is set                                   |                                   |
| Center                | Sets/reads the center value of frequency span                                                              | :SENS:SP[1-1]:FREQ:CENT           |
| Span                  | Sets/reads the span value of frequency span                                                                | :SENS:SP[1-1]:FREQ:SPAN           |
| Start                 | Sets/reads the start value of frequency span                                                               | :SENS:SP[1-1]:FREQ:STAR           |
| Stop                  | Sets/reads the stop value of frequency span                                                                | :SENS:SP[1-1]:FREQ:STOP           |
| <b>Stop/Span</b>      |                                                                                                            |                                   |
| <b>Carrier To</b>     |                                                                                                            |                                   |
| Carrier -> Center     | Changes the center frequency to the carrier frequency                                                      | :SENS:SP[1-1]:CARR:SET:CEN<br>T 1 |
| Carrier x 2 -> Center | Changes the center frequency to 2 times the carrier frequency                                              | :SENS:SP[1-1]:CARR:SET:CEN<br>T 2 |
| Carrier x 3 -> Center | Changes the center frequency to 3 times the carrier frequency                                              | :SENS:SP[1-1]:CARR:SET:CEN<br>T 3 |
| Carrier x # -> Center | Changes the center frequency to # times the carrier frequency (The # is assigned by <b>Harmonic #</b> key) | :SENS:SP[1-1]:CARR:SET:CEN<br>T # |
| Frequency Band        | Sets/reads the carrier frequency band                                                                      | :SENSe:SP[1-1]:CARRier:FBAN<br>d  |
| Harmonic #            | Sets the magnification of carrier frequency when center frequency is set                                   |                                   |
| Center                | Sets/reads the center value of frequency span                                                              | :SENS:SP[1-1]:FREQ:CENT           |
| Span                  | Sets/reads the span value of frequency span                                                                | :SENS:SP[1-1]:FREQ:SPAN           |
| Start                 | Sets/reads the start value of frequency span                                                               | :SENS:SP[1-1]:FREQ:STAR           |
| Stop                  | Sets/reads the stop value of frequency span                                                                | :SENS:SP[1-1]:FREQ:STOP           |

**Table D-2 SP Menu**

| Key Operation                                | Function                                                                              | SCPI Command                       |
|----------------------------------------------|---------------------------------------------------------------------------------------|------------------------------------|
| <b>System</b>                                |                                                                                       |                                    |
| <b>Abort Printing</b>                        | Aborts printing                                                                       | :HCOP:ABOR                         |
| <b>Backlight</b>                             | Turns on/off backlight                                                                | :SYST:BACK:STAT                    |
| <b>Dump Screen Image</b>                     | Save screen image                                                                     | :MMEM:STOR:IMAG                    |
| <b>Instrument Setup</b>                      |                                                                                       |                                    |
| <b>Correction</b>                            |                                                                                       |                                    |
| <b>File Dialog ...</b>                       | Loads correction data for a specified power                                           | :MMEM:LOAD:CORR:POW                |
| <b>Import Power Correction Table</b>         | Loads correction data for a specified power                                           | :MMEM:LOAD:CORR:POW                |
| <b>Power Correction</b>                      | Sets user the user calibration on or off or reads its setting                         | :SENS:CORR:POW:STAT                |
| <b>Downconverter Manual Setup</b>            |                                                                                       |                                    |
| <b>Current</b>                               | Sets/reads the bias current to be supplied to the external mixer                      | :SENS:DCON:MAN:MEXT[1-2]:BIAS:CURR |
| <b>IF Gain 1</b><br><b>IF Gain 2</b>         | Sets/reads the IF gain of the external mixer                                          | :SENS:DCON:MAN:IFG[1-2]            |
| <b>LO1 Frequency</b><br><b>LO2 Frequency</b> | Sets/reads the LO frequency of the external mixer                                     | :SENS:DCN:MAN:LO[1-2]:FRE<br>Q     |
| <b>LO1 Level</b><br><b>LO2 Level</b>         | Sets/reads the LO level of the external mixer                                         | :SENS:DCON:MAN:LO[1-2]:LE<br>V     |
| <b>Mixer 1 Bias</b><br><b>Mixer 2 Bias</b>   | Sets the bias current supplied to the external mixer on or off and reads its settings | :SENS:DCON:MAN:MEXT[1-2]:BIAS:STAT |
| $\Delta F = IF2 - IF1$                       | Sets/reads the differential frequency between CH1 and CH2 from the external mixer     | :SENS:DCON:MAN:IFD                 |
| <b>Frequency Offset (User Downconv.)</b>     |                                                                                       |                                    |
| <b>Conversion Mode</b>                       | Sets/reads the conversion mode of the frequency offset                                | :SNES:UDC:MODE                     |
| <b>Frequency Offset</b>                      | Sets/reads the frequency offset                                                       | :SENS:UDC:STAT                     |
| <b>Harmonic #</b>                            | Sets/reads the frequency offset factor                                                | :SENS:UDC:HARM                     |
| <b>LO Frequency</b>                          | Sets/reads the LO frequency of the frequency offset                                   | :SENS:UDC:LO                       |

Table D-2 SP Menu

| Key Operation             | Function                                                       | SCPI Command                |
|---------------------------|----------------------------------------------------------------|-----------------------------|
| <b>Invert Image</b>       | Selects print mode                                             | :HCOP:IMAG                  |
| <b>Misc Setup</b>         |                                                                |                             |
| <b>Beeper</b>             |                                                                |                             |
| <b>Beep Complete</b>      | Turns on/off the beep for operation completion                 | :SYST:BEEP:COMP:STAT        |
| <b>Beep Warning</b>       | Turns on/off the beep for warning                              | :SYST:BEEP:WARN:STAT        |
| <b>Test Beep Complete</b> | Makes beep sound for operation completion                      | :SYST:BEEP:COMP:IMM         |
| <b>Test Beep Warning</b>  | Makes beep sound for warning                                   | :SYST:BEEP:WARN:IMM         |
| <b>Clock Setup</b>        |                                                                |                             |
| <b>Set Date and Time</b>  | Set/reads system time                                          | :SYST:TIME                  |
|                           | Set/reads system date                                          | :SYST:DATE                  |
| <b>Show Clock</b>         | Turns on/off internal clock display                            | :DISP:CLOC                  |
| <b>Color Setup</b>        |                                                                |                             |
| <b>Invert</b>             | Sets each color when the inverted display is selected          |                             |
| <b>Background</b>         | Sets/Reads the background color                                | :DISP:COL2:BACK[:VAL]       |
| <b>Data Trace 1</b>       | Sets/Reads the color of the data trace of trace 1              | :DISP:COL2:TRAC1:DATA[:VAL] |
| :                         |                                                                |                             |
| :                         |                                                                |                             |
| <b>Data Trace 8</b>       | Sets/Reads the color of the data trace of trace 8              | :DISP:COL2:TRAC8:DATA[:VAL] |
| <b>Graticule Main</b>     | Sets/Reads the color of the graph                              | :DISP:COL2:GRAT1[:VAL]      |
| <b>Graticule Sub</b>      | Sets/Reads the color of the grid lines in the graph            | :DISP:COL2:GRAT2[:VAL]      |
| <b>Limit Fail</b>         | Sets/Reads the limit display color                             | :DISP:COL2:LIM1[:VAL]       |
| <b>Limit Line</b>         | Sets/Reads the color of the limit line                         | :DISP:COL2:LIM2[:VAL]       |
| <b>Mem Trace 1</b>        | Sets/Reads the color of the memory trace of trace 1            | :DISP:COL2:TRAC1:MEM[:VAL]  |
| :                         |                                                                |                             |
| :                         |                                                                |                             |
| <b>Mem Trace 8</b>        | Sets/Reads the color of the memory trace of trace 8            | :DISP:COL2:TRAC8:MEM[:VAL]  |
| <b>Reset Color</b>        | Resets the display color to the factory preset default setting | :DISP:COL2:RES              |

**Table D-2 SP Menu**

| Key Operation                          | Function                                                                  | SCPI Command                |
|----------------------------------------|---------------------------------------------------------------------------|-----------------------------|
| <b>Normal</b>                          | Sets each color when the normal display is selected                       |                             |
| <b>Background</b>                      | Sets/Reads the background color                                           | :DISP:COL1:BACK[:VAL]       |
| <b>Data Trace 1</b>                    | Sets/Reads the color of the data trace of trace 1                         | :DISP:COL1:TRAC1:DATA[:VAL] |
| :                                      |                                                                           |                             |
| <b>Data Trace 8</b>                    | Sets/Reads the color of the data trace of trace 8                         | :DISP:COL1:TRAC8:DATA[:VAL] |
| <b>Graticule Main</b>                  | Sets/Reads the color of the graph                                         | :DISP:COL1:GRAT1[:VAL]      |
| <b>Graticule Sub</b>                   | Sets/Reads the color of the grid lines in the graph                       | :DISP:COL1:GRAT2[:VAL]      |
| <b>Limit Fail</b>                      | Sets/Reads the limit display color                                        | :DISP:COL1:LIM1[:VAL]       |
| <b>Limit Line</b>                      | Sets/Reads the color of the limit line                                    | :DISP:COL1:LIM2[:VAL]       |
| <b>Mem Trace 1</b>                     | Sets/Reads the color of the memory trace of trace 1                       | :DISP:COL1:TRAC1:MEM[:VAL]  |
| :                                      |                                                                           |                             |
| <b>Mem Trace 8</b>                     | Sets/Reads the color of the memory trace of trace 8                       | :DISP:COL1:TRAC8:MEM[:VAL]  |
| <b>Reset Color</b>                     | Resets the display color to the factory preset default setting            | :DISP:COL1:RES              |
| <b>Control Panel ...</b>               | Open control panel                                                        |                             |
| <b>GPIB Setup</b>                      |                                                                           |                             |
| <b>System Controller Configuration</b> | Turns on/off system controller mode                                       |                             |
| <b>Talker/Listener Address</b>         | Sets the address for controlling the analyzer from a controller via GPIB. |                             |
| <b>Key Lock</b>                        |                                                                           |                             |
| <b>Front Panel &amp; Keyboard Lock</b> | Disables from panel / keyboard operations                                 | :SYST:KLOC:KBD              |
| <b>Touch Screen &amp; Mouse Lock</b>   | Disables from touch screen / mouse operations                             | :SYST:KLOC:MOUS             |
| <b>Network Setup</b>                   |                                                                           |                             |
| <b>MAC Address</b>                     | Sets MAC address                                                          |                             |
| <b>Network Configuration ...</b>       | Enables/disables network connections                                      |                             |

Softkey Functions  
SP Menu

Table D-2 SP Menu

| Key Operation                     | Function                                                                                              | SCPI Command                      |
|-----------------------------------|-------------------------------------------------------------------------------------------------------|-----------------------------------|
| <b>Network Identification ...</b> | Sets network ID of the instrument                                                                     |                                   |
| <b>SICL-LAN Address</b>           | Sets SICL-LAN address                                                                                 |                                   |
| <b>SICL-LAN Server</b>            | Enables/disables SICL-LAN server                                                                      |                                   |
| <b>Socket Server</b>              | Enables/disables Socket server                                                                        |                                   |
| <b>Telnet Server</b>              | Enables/disables Telnet server                                                                        |                                   |
| <b>Print</b>                      | Outputs print                                                                                         | :HCOP:IMM                         |
| <b>Printer Setup ...</b>          | Execute printer setup                                                                                 |                                   |
| <b>Product Information</b>        | Reads product information                                                                             |                                   |
| <b>Service Menu</b>               |                                                                                                       |                                   |
| <b>Administrator Menu</b>         | Displays softkeys associated with Administrator Menu. This function is not available to general users |                                   |
| <b>Error Log</b>                  |                                                                                                       |                                   |
| <b>Clear Error Log</b>            | Clears the error log                                                                                  |                                   |
| <b>View Error Log ...</b>         | Displays the error log                                                                                |                                   |
| <b>Install Option License</b>     |                                                                                                       |                                   |
| <b>Jitter</b>                     | Enters the lincense for clock jitter analysis (VBA)                                                   |                                   |
| <b>Service Function</b>           | Displays softkeys associated with Service Menu. This function is not available to general users.      |                                   |
| <b>Test Menu</b>                  |                                                                                                       |                                   |
| <b>Power On Test</b>              | Performs internal test                                                                                |                                   |
| <b>Display Test</b>               | Performs display test                                                                                 |                                   |
| <b>Front Panel</b>                | Performs front panel key (hard key) test                                                              |                                   |
| <b>Adjust Touch Screen</b>        | Performs touch screen calibration                                                                     |                                   |
| <b>E5053A Test</b>                | Displays the connection status of E5053A                                                              |                                   |
| <b>Trace View</b>                 |                                                                                                       |                                   |
| <b>Aperture</b>                   | Smoothing aperture                                                                                    | :CALC:SP[1-1]:TRAC[1-1]:SMO:APER  |
| <b>Copy to User</b>               | Copies trace data to the user trace                                                                   | :CALC:SP[1-1]:TRAC[1-1]:DATA:COPY |
| <b>Data -&gt; Mem</b>             | Copy data to memory                                                                                   | :CALC:SP[1-1]:TRAC[1-1]:MATH:MEM  |

**Table D-2 SP Menu**

| Key Operation                      | Function                                                                                           | SCPI Command                            |
|------------------------------------|----------------------------------------------------------------------------------------------------|-----------------------------------------|
| <b>Data Hold</b>                   | Data hold                                                                                          | :CALC:SP[1-1]:TRAC[1-1]:HOLD            |
| <b>Data Math</b>                   | Sets/reads math operation type                                                                     | :CALC:SP[1-1]:TRAC[1-1]:MATH:FUNC       |
| <b>Display Trace</b>               | Shows data and/or memory trace                                                                     | :DISP:SP[1-1]:TRAC[1-1]:MODE            |
| <b>Marker -&gt; -Offset</b>        | Sets the sign-inverted data value of the data trace's active marker to the offset value            | :CALC:SP[1-1]:TRAC[1-1]:MATH:OFFS       |
| <b>Offset</b>                      | Sets/Reads the offset value of the data trace                                                      | :CALC:SP[1-1]:TRAC[1-1]:MATH:OFFS       |
| <b>Persistence</b>                 |                                                                                                    |                                         |
| <b>Clear Persistent Data</b>       | Clears persistent mode                                                                             | :DISP:SP[1-1]:TRAC[1-4]:PERS:CLE        |
| <b>Persistence Mode</b>            | Sets/reads persistent mode                                                                         | :DISP:SP[1-1]:TRAC[1-4]:PERS:STAT       |
| <b>Smoothing</b>                   | Smoothing on/off                                                                                   | :CALC:SP[1-1]:TRAC[1-1]:SMO:STAT        |
| <b>Trace Label</b>                 | Edits trace title label                                                                            | :DISP:SP[1-1]:TRAC[1-1]:LAB:DATA        |
| <b>Trigger</b>                     |                                                                                                    |                                         |
| <b>Average Trigger</b>             | Sets/Reads the averaging trigger function                                                          | :TRIG:AVER                              |
| <b>Continuous</b>                  | Sets/reads trigger continuous mode                                                                 | :INIT:SP[1-1]:CONT<br>:INIT:SP[1-1]:IMM |
| <b>Ext Trig Polarity</b>           | External trigger polarity                                                                          | :TRIG:EXT:SLOP                          |
| <b>Hold</b>                        | Sets trigger mode to waiting-for-trigger state                                                     | :INIT:SP[1-1]:IMM                       |
| <b>Manual Trigger</b>              | move once to waiting-for-trigger state                                                             | :INIT:SP[1-1]:IMM                       |
| <b>Restart</b>                     | move once to waiting-for-trigger state                                                             | :INIT:SP[1-1]:IMM                       |
| <b>Single</b>                      | always move to waiting-for-trigger state after measuring<br>move once to waiting-for-trigger state | :INIT:SP[1-1]:CONT<br>:INIT:SP[1-1]:IMM |
| <b>Source</b>                      | trigger source                                                                                     | :TRIG:SP[1-1]:SOUR                      |
| <b>Trigger to Spectrum Monitor</b> | select measurement mode                                                                            | :TRIG:MODE                              |

## Frequency Power Menu (Top Menu)

| Key Operation                                  | Function                                                                                                             |
|------------------------------------------------|----------------------------------------------------------------------------------------------------------------------|
| <b>Double-click on each softkey menu title</b> | Displays the top menu of each menu item below. Refer the FP menu about detail of following each menu item.           |
| Measurement View                               | Same as <b>Meas</b> .                                                                                                |
| Input                                          | Same as <b>Scale</b> .                                                                                               |
| Scale                                          | Same as <b>Scale</b> .                                                                                               |
| Format                                         | Same as <b>Format</b> .                                                                                              |
| Display                                        | Same as <b>Display</b> .                                                                                             |
| Average                                        | Same as <b>Avg</b> .                                                                                                 |
| Attenuator                                     | Same as <b>Cal</b> .                                                                                                 |
| Start/Center                                   | Displays the same softkey for setting up the sweep range that appears when <b>Start</b> , or <b>Span</b> is pressed. |
| Stop/Span                                      | Displays the same softkey for setting up the sweep range that appears when <b>Start</b> , or <b>Span</b> is pressed. |
| DC Conrol Voltage                              | Same as <b>Sweep Setup</b> .                                                                                         |
| DC Power Voltage                               | Same as <b>Sweep Setup</b> .                                                                                         |
| Setup                                          | Same as <b>Sweep Setup</b> .                                                                                         |
| Trigger                                        | Same as <b>Trigger</b> .                                                                                             |
| Marker                                         | Same as <b>Marker</b> .                                                                                              |
| Marker Search                                  | Same as <b>Marker Search</b> .                                                                                       |
| Marker To                                      | Same as <b>Marker Search</b> .                                                                                       |
| Marker Function                                | Same as <b>Marker Fctn</b> .                                                                                         |
| Macro Setup                                    | Same as <b>Macro Setup</b> .                                                                                         |
| Save/Recall                                    | Same as <b>Save/Recall</b> .                                                                                         |
| System                                         | Same as <b>System</b> .                                                                                              |
| Preset                                         | Same as <b>Preset</b> .                                                                                              |



## FP Menu

Table D-3 FP Menu

| Key Operation                      | Function                                                                                       | SCPI Command                                              |
|------------------------------------|------------------------------------------------------------------------------------------------|-----------------------------------------------------------|
| <b>Attenuator</b>                  |                                                                                                |                                                           |
| <b>Input Attenuator</b>            | Sets/reads Input Attenuator level on 5dB Step                                                  | :SENS:ATT:LEV                                             |
| <b>Average</b>                     |                                                                                                |                                                           |
| <b>Averaging</b>                   | Turns on/off averaging function                                                                | :SENS:FP[1-1]:AVER:STAT                                   |
| <b>Averaging Restart</b>           | Restart averaging                                                                              | :SENS:FP[1-1]:AVER:CLE                                    |
| <b>Avg Factor</b>                  | Sets/reads averaging count                                                                     | :SENS:FP[1-1]:AVER:COUN                                   |
| <b>DC Control Voltage</b>          |                                                                                                |                                                           |
| <b>Auto Freq Control</b>           |                                                                                                |                                                           |
| <b>AFC Status</b>                  | Turns on/off the auto frequency control function.<br>Executes the auto frequency control once. | :SOUR:VOLT:CONT:AFC[:STAT<br>]<br>:SOUR:VOLT:CONT:AFC:IMM |
| <b>Frequency Band</b>              | Sets/reads the frequency band in the auto frequency control function                           | :SOUR:VOLT:CONT:AFC:FBAN                                  |
| <b>Max Ctrl Voltage Limit</b>      | Sets/reads the maximum DC control voltage limit                                                | :SOUR:VOLT:CONT:AFC:LIM:<br>HIGH                          |
| <b>Max Input Level</b>             | Sets/reads the maximum input level                                                             | :SOUR:VOLT:CONT:AFC:INP:L<br>EV:MAX                       |
| <b>Max Iteration</b>               | Sets/reads the maximum number of iterations for the DC control voltage-setting loops           | :SOUR:VOLT:CONT:AFC:ITER                                  |
| <b>Min Ctrl Voltage Limit</b>      | Sets/reads the minimum DC control voltage limit                                                | :SOUR:VOLT:CONT:AFC:LIM:<br>LOW                           |
| <b>Sensitivity</b>                 | Sets/reads the tuning sensitivity                                                              | :SOUR:VOLT:CONT:AFC:SENS                                  |
| <b>Target</b>                      | Sets/reads the target frequency in the auto frequency control function                         | :SOUR:VOLT:CONT:AFC:TARG                                  |
| <b>Tolerance</b>                   | Sets/reads the tolerance limit                                                                 | :SOUR:VOLT:CONT:AFC:TOL                                   |
| <b>Control Voltage Cal</b>         | Enables DC Control voltage calibration                                                         | :SOUR:VOLT:CONT:CORR[:ST<br>AT]                           |
| <b>DC Control Delay</b>            | Sets/reads DC Control delay (sec)                                                              | :SOUR:VOLT:CONT:DEL                                       |
| <b>DC Control Output</b>           | Turns on/off DC Control voltage                                                                | :SOUR:VOLT:CONT:LEV:STAT                                  |
| <b>DC Control Voltage</b>          | Sets/reads DC Control voltage                                                                  | :SOUR:VOLT:CONT:LEV:AMP<br>L                              |
| <b>Execute Control Voltage Cal</b> | Execute DC Control voltage calibration                                                         | :SOUR:VOLT:CONT:CORR:CO<br>LL:ACQ                         |
| <b>Max Ctrl Voltage Limit</b>      | Sets/reads the maximum DC Control voltage limit                                                | :SOUR:VOLT:CONT:LIM:HIGH                                  |
| <b>Min Ctrl Voltage Limit</b>      | Sets/reads the minimum DC Control voltage limit                                                | :SOUR:VOLT:CONT:LIM:LOW                                   |

**Table D-3 FP Menu**

| Key Operation                      | Function                                                     | SCPI Command                             |
|------------------------------------|--------------------------------------------------------------|------------------------------------------|
| <b>DC Power Voltage</b>            |                                                              |                                          |
| <b>DC Power Delay</b>              | Sets/reads DC Power delay (sec)                              | :SOUR:VOLT:POW:DEL                       |
| <b>DC Power Output</b>             | Turns on/off DC Power voltage                                | :SOUR:VOLT:POW:LEV:STAT                  |
| <b>DC Power Voltage</b>            | Sets/reads DC Power voltage                                  | :SOUR:VOLT:POW:LEV:AMPL                  |
| <b>Max Pwr Voltage Limit</b>       | Sets/reads the maximum DC Power voltage limit                | :SOUR:VOLT:POW:LIM:HIGH                  |
| <b>Min Pwr Voltage Limit</b>       | Sets/reads the minimum DC Power voltage limit                | :SOUR:VOLT:POW:LIM:LOW                   |
| <b>Display</b>                     |                                                              |                                          |
| <b>Allocate</b>                    | Sets/reads the trace layout                                  | :DISP:FP[1-1]:SPL                        |
| <b>Edit Title Label</b>            | Edit the measurement window title label                      | :DISP:FP[1-1]:LAB:DATA                   |
| <b>Color Type</b>                  | Sets/Reads the display type of the display (normal/inverted) | :DISP:IMAG                               |
| <b>Limit Test</b>                  |                                                              |                                          |
| <b>Delete Lower Limit Line</b>     | Clears the lower limit line                                  | :CALC:FP[1-1]:TRAC[1-4]:LIM:LOW:SEGM:CLE |
| <b>Delete Upper Limit Line</b>     | Clears the upper limit line                                  | :CALC:FP[1-1]:TRAC[1-4]:LIM:UPP:SEGM:CLE |
| <b>Explorer</b>                    |                                                              |                                          |
| <b>Fail Sign</b>                   | Turns on/off the limit test judgement display                | :DISP:FP[1-1]:LIM:FSIG                   |
| <b>Import Lower Limit Line ...</b> | Reads the lower limit line                                   | :MMEM:FP[1-1]:TRAC[1-4]:LOAD:LIM:LOW     |
| <b>Import Upper Limit Line ...</b> | Reads the upper limit line                                   | :MMEM:FP[1-1]:TRAC[1-4]:LOAD:LIM:UPP     |
| <b>Limit Line</b>                  | Turns on/off the limit line                                  | :DISP:FP[1-1]:TRAC[1-4]:LIM:LINE         |
| <b>Limit Test</b>                  | Turns on/off the limit test function                         | :CALC:FP[1-1]:TRAC[1-4]:LIM[:STAT]       |
| <b>Marker Information</b>          | Sets/reads the marker information position                   | :DISP:FP[1-1]:ANN:MARK:POS               |
| <b>Meas Condition</b>              | Turns on/off measurement conditions                          | :DISP:FP[1-1]:ANN:MEAS:STAT              |
| <b>Relative Y-Scale</b>            | Turns on/off relative Y-scale                                | :DISP:FP[1-1]:GRAT:AXIS:Y:REL            |
| <b>Security Level</b>              | Sets/recalls the security level                              | :SYST:SEC[:LEV]                          |
| <b>Title Label</b>                 | Turns on/off the measurement window title label              | :DISP:FP[1-1]:LAB:STAT                   |
| <b>Update</b>                      | Turns on/off the trace updates                               | :DISP:ENAB                               |
| <b>Y # of Digits</b>               | Selects the number of digits (Y-axis)                        | :DISP:FP[1-1]:GRAT:AXIS:Y:STAT           |

**Table D-3 FP Menu**

| Key Operation               | Function                                                            | SCPI Command                      |
|-----------------------------|---------------------------------------------------------------------|-----------------------------------|
| <b>Format</b>               |                                                                     |                                   |
| <b>Frequency Format</b>     | Selects frequency format (Hz or Hz/V)                               | :CALC:FP[1-1]:TRAC[1-4]:FORM:FREQ |
| <b>Frequency Reference</b>  | Sets/reads the frequency reference.                                 | :CALC:FP[1-1]:TRAC[1-4]:REF:FREQ  |
| <b>Sensitivity Aperture</b> | Sets/reads the sensitivity aperture                                 | :CALC:FP[1-1]:TRAC[1-4]:SAP       |
| <b>Input Port</b>           |                                                                     |                                   |
| <b>Downconverter</b>        |                                                                     |                                   |
| <b>Downconverter</b>        | Sets the use of the downconverter on or off, or reads its setting   | :SENS:DCON[:STAT]                 |
| <b>RF Input</b>             | Sets/reads the signal supplied to the RF input port                 | :SENS:DCON:INP                    |
| <b>External Mixer</b>       | Sets the use of the external mixer on or off and reads its settings | :SENS:DCON:MEXT                   |
| <b>Macro Setup</b>          |                                                                     |                                   |
| <b>Application</b>          |                                                                     |                                   |
| <b>Jitter</b>               | Executes clock jitter analysis (VBA)                                |                                   |
| <b>mmWave</b>               | Executes phase-noise measurement (VBA)                              |                                   |
| <b>E5052 Event</b>          | Turns on/off the E5052 VBA event callback function                  | :PROG:COM:EVEN                    |
| <b>Echo Window Menu</b>     |                                                                     |                                   |
| <b>Clear Echo</b>           | Clears Echo window                                                  | :DISP:ECHO:CLE                    |
| <b>Echo Font Size</b>       | Sets/reads the font size on Echo window                             | :DISP:ECHO:FSIZ                   |
| <b>Echo Window</b>          | Turns on/off the Echo window                                        | :DISP:ECHO:STAT                   |
| <b>Load &amp; Run</b>       | Load and execute the macro selected on file names.                  |                                   |
| <b>Select Macro</b>         | Sets/reads the name of the program to be selected                   | :PROG:SEL:NAME                    |
| <b>Stop</b>                 | Sets/reads the state of the selected program                        | :PROG:SEL:STAT                    |
| <b>User Menu</b>            |                                                                     |                                   |
| <b>User Label 1</b>         | Execute the macro assigned under the user defined softkey           | :PROG:SKEY:ITEM[1-8]:IMM          |
| <b>User Label 2</b>         | Execute the macro assigned under the user defined softkey           | :PROG:SKEY:ITEM[1-8]:IMM          |
| <b>User Label 3</b>         | Execute the macro assigned under the user defined softkey           | :PROG:SKEY:ITEM[1-8]:IMM          |
| <b>User Label 4</b>         | Execute the macro assigned under the user defined softkey           | :PROG:SKEY:ITEM[1-8]:IMM          |
| <b>User Label 5</b>         | Execute the macro assigned under the user defined softkey           | :PROG:SKEY:ITEM[1-8]:IMM          |
| <b>User Label 6</b>         | Execute the macro assigned under the user defined softkey           | :PROG:SKEY:ITEM[1-8]:IMM          |
| <b>User Label 7</b>         | Execute the macro assigned under the user defined softkey           | :PROG:SKEY:ITEM[1-8]:IMM          |
| <b>User Label 8</b>         | Execute the macro assigned under the user defined softkey           | :PROG:SKEY:ITEM[1-8]:IMM          |

Softkey Functions  
FP Menu

Table D-3 FP Menu

| Key Operation            | Function                                         | SCPI Command                            |
|--------------------------|--------------------------------------------------|-----------------------------------------|
| <b>VBA Editor Menu</b>   |                                                  |                                         |
| Close Editor             | close VBA editor                                 |                                         |
| Load Project             | Load program                                     | :MMEM:LOAD:PROG                         |
| New Project              | Open new VBA project                             |                                         |
| Open Editor              | Open VBA editor                                  |                                         |
| Save Project             | Save VBA Project                                 | :MMEM:STOR:PROG                         |
| <b>Marker</b>            |                                                  |                                         |
| <b>Clear Marker Menu</b> |                                                  |                                         |
| All OFF                  | Clears all the markers                           |                                         |
| Marker 1                 | Turns on/off marker 1                            | :CALC:FP[1-1]:TRAC[1-4]:MARK[1-10]:STAT |
| :                        |                                                  |                                         |
| :                        |                                                  |                                         |
| Marker 10                | Turns on/off marker 10                           | :CALC:FP[1-1]:TRAC[1-4]:MARK[1-10]:STAT |
| Couple                   | Turns on/off marker coupling function            | :CALC:FP[1-1]:ALLT:MARK:COUP:STAT       |
| Marker 1                 | Turns on/off marker 1                            | :CALC:FP[1-1]:TRAC[1-4]:MARK[1-10]:STAT |
| :                        |                                                  |                                         |
| :                        |                                                  |                                         |
| Marker 6                 | Turns on/off marker 6                            | :CALC:FP[1-1]:TRAC[1-4]:MARK[1-10]:STAT |
| Marker List              | Turns on/off the marker list                     | :DISP:FP[1-1]:TABL[:STAT]               |
| <b>More Functions</b>    |                                                  |                                         |
| Discrete                 | Sets/reads marker movement (Continuous/Discrete) | :CALC:FP[1-1]:ALLT:MARK:DISC:STAT       |
| Ref Marker               | Sets/reads marker reference number               | :CALC:FP[1-1]:ALLT:MARK:REF:NUMB        |
| Ref Marker Mode          | Turns on/off delta marker mode                   | :CALC:FP[1-1]:ALLT:MARK:REF:STAT        |
| <b>More Markers</b>      |                                                  |                                         |
| Marker 7                 | Turns on/off marker 7                            | :CALC:FP[1-1]:TRAC[1-4]:MARK[1-10]:STAT |
| :                        |                                                  |                                         |
| :                        |                                                  |                                         |
| Marker 10                | Turns on/off marker 10                           | :CALC:FP[1-1]:TRAC[1-4]:MARK[1-10]:STAT |

**Table D-3 FP Menu**

| Key Operation             | Function                                    | SCPI Command                           |
|---------------------------|---------------------------------------------|----------------------------------------|
| <b>Marker Function</b>    |                                             |                                        |
| <b>Analysis Range (X)</b> | Sets/reads analysis/search range (X-axis)   | :CALC:FP[1-1]:TRAC[1-4]:FUNCTION:DOM:X |
| <b>Analysis Range (Y)</b> | Sets/reads analysis/search range (Y-axis)   | :CALC:FP[1-1]:TRAC[1-4]:FUNCTION:DOM:Y |
| <b>Analysis Type</b>      | Sets/reads analysis type                    | :CALC:FP[1-1]:TRAC[1-4]:FUNCTION:TYPE  |
| <b>Band Marker X</b>      |                                             |                                        |
| <b>Band Marker X</b>      | Turns on/off bandmarker X                   | :CALC:FP[1-1]:TRAC[1-4]:BDM:X:STAT     |
| <b>Center</b>             | Sets/reads the center value of bandmarker X | :CALC:FP[1-1]:TRAC[1-4]:BDM:X:CENT     |
| <b>Span</b>               | Sets/reads the span value of bandmarker X   | :CALC:FP[1-1]:TRAC[1-4]:BDM:X:SPAN     |
| <b>Start</b>              | Sets/reads the start value of bandmarker X  | :CALC:FP[1-1]:TRAC[1-4]:BDM:X:STAR     |
| <b>Stop</b>               | Sets/reads the stop value of bandmarker X   | :CALC:FP[1-1]:TRAC[1-4]:BDM:X:STOP     |
| <b>Band Marker Y</b>      |                                             |                                        |
| <b>Band Marker Y</b>      | Turns on/off bandmarker Y                   | :CALC:FP[1-1]:TRAC[1-4]:BDM:Y:STAT     |
| <b>Center</b>             | Sets/reads the center value of bandmarker Y | :CALC:FP[1-1]:TRAC[1-4]:BDM:Y:CENT     |
| <b>Span</b>               | Sets/reads the span value of bandmarker Y   | :CALC:FP[1-1]:TRAC[1-4]:BDM:Y:SPAN     |
| <b>Start</b>              | Sets/reads the start value of bandmarker Y  | :CALC:FP[1-1]:TRAC[1-4]:BDM:Y:STAR     |
| <b>Stop</b>               | Sets/reads the stop value of bandmarker Y   | :CALC:FP[1-1]:TRAC[1-4]:BDM:Y:STOP     |
| <b>Couple</b>             | Turns on/off bandmarker coupling function   | :CALC:FP[1-1]:ALLT:BDM:X:COUP:STAT     |
| <b>Marker Search</b>      |                                             |                                        |
| <b>Band Marker X</b>      |                                             |                                        |
| <b>Band Marker X</b>      | Turns on/off bandmarker X                   | :CALC:FP[1-1]:TRAC[1-4]:BDM:X:STAT     |
| <b>Center</b>             | Sets/reads the center value of bandmarker X | :CALC:FP[1-1]:TRAC[1-4]:BDM:X:CENT     |
| <b>Span</b>               | Sets/reads the span value of bandmarker X   | :CALC:FP[1-1]:TRAC[1-4]:BDM:X:SPAN     |
| <b>Start</b>              | Sets/reads the start value of bandmarker X  | :CALC:FP[1-1]:TRAC[1-4]:BDM:X:STAR     |

**Table D-3 FP Menu**

| Key Operation           | Function                                    | SCPI Command                                          |
|-------------------------|---------------------------------------------|-------------------------------------------------------|
| <b>Stop</b>             | Sets/reads the stop value of bandmarker X   | :CALC:FP[1-1]:TRAC[1-4]:BDM<br>:X:STOP                |
| <b>Band Marker Y</b>    |                                             |                                                       |
| <b>Band Marker Y</b>    | Turns on/off bandmarker Y                   | :CALC:FP[1-1]:TRAC[1-4]:BDM<br>:Y:STAT                |
| <b>Center</b>           | Sets/reads the center value of bandmarker Y | :CALC:FP[1-1]:TRAC[1-4]:BDM<br>:Y:CENT                |
| <b>Span</b>             | Sets/reads the span value of bandmarker Y   | :CALC:FP[1-1]:TRAC[1-4]:BDM<br>:Y:SPAN                |
| <b>Start</b>            | Sets/reads the start value of bandmarker Y  | :CALC:FP[1-1]:TRAC[1-4]:BDM<br>:Y:STAR                |
| <b>Stop</b>             | Sets/reads the stop value of bandmarker Y   | :CALC:FP[1-1]:TRAC[1-4]:BDM<br>:Y:STOP                |
| <b>Couple</b>           | Turns on/off bandmarker coupling function   | :CALC:FP[1-1]:ALLT:BDM:X:C<br>OUP:STAT                |
| <b>Peak</b>             |                                             |                                                       |
| <b>Peak Excursion</b>   | Sets/reads the peak excursion value         | :CALC:FP[1-1]:TRAC[1-4]:MAR<br>K[1-10]:SEAR:PEAK:EXC  |
| <b>Peak Polarity</b>    | Sets/reads the marker peak-search polarity  | :CALC:FP[1-1]:TRAC[1-4]:MAR<br>K[1-10]:SEAR:PEAK:POL  |
| <b>Search Left</b>      | Execute marker peak search left             | :CALC:FP[1-1]:TRAC[1-4]:MAR<br>K[1-10]:SEAR:EXEC:LPE  |
| <b>Search Peak</b>      | Execute marker peak search                  | :CALC:FP[1-1]:TRAC[1-4]:MAR<br>K[1-10]:SEAR:EXEC:PEAK |
| <b>Search Peak All</b>  | Execute marker search all                   | :CALC:FP[1-1]:TRAC[1-4]:ALL<br>M:SEAR:PEAK            |
| <b>Search Right</b>     | Execute marker peak search right            | :CALC:FP[1-1]:TRAC[1-4]:MAR<br>K[1-10]:SEAR:EXEC:RPE  |
| <b>Search Max</b>       | Execute marker search maximum               | :CALC:FP[1-1]:TRAC[1-4]:MAR<br>K[1-10]:SEAR:EXEC:MAX  |
| <b>Search Min</b>       | Execute marker search minimum               | :CALC:FP[1-1]:TRAC[1-4]:MAR<br>K[1-10]:SEAR:EXEC:MIN  |
| <b>Search Range (X)</b> | Sets/reads marker search range (X-axis)     | :CALC:FP[1-1]:TRAC[1-4]:ALL<br>M:SEAR:DOM:X           |
| <b>Search Range (Y)</b> | Sets/reads marker search range (Y-axis)     | :CALC:FP[1-1]:TRAC[1-4]:ALL<br>M:SEAR:DOM:Y           |
| <b>Target</b>           |                                             |                                                       |
| <b>Search Left</b>      | Execute marker target search left           | :CALC:FP[1-1]:TRAC[1-4]:MAR<br>K[1-10]:SEAR:EXEC:LTAR |
| <b>Search Right</b>     | Execute marker target search right          | :CALC:FP[1-1]:TRAC[1-4]:MAR<br>K[1-10]:SEAR:EXEC:RTAR |

**Table D-3 FP Menu**

| Key Operation              | Function                                                                                                                         | SCPI Command                                                |
|----------------------------|----------------------------------------------------------------------------------------------------------------------------------|-------------------------------------------------------------|
| <b>Search Target</b>       | Execute marker target search                                                                                                     | :CALC:FP[1-1]:TRAC[1-4]:MARK[1-10]:SEAR:EXEC:TARG           |
| <b>Target Transition</b>   | Sets/reads the target transition definition                                                                                      | :CALC:FP[1-1]:TRAC[1-4]:MARK[1-10]:SEAR:TARG:TRAN           |
| <b>Target Value</b>        | Sets/reads the marker target value                                                                                               | :CALC:FP[1-1]:TRAC[1-4]:MARK[1-10]:SEAR:TARG:Y              |
| <b>Tracking</b>            | Sets/reads the marker tracking type                                                                                              | :CALC:FP[1-1]:TRAC[1-4]:MARK[1-10]:SEAR:TRAC:TYPE           |
| <b>Marker To</b>           |                                                                                                                                  |                                                             |
| <b>Marker -&gt; Center</b> | Sets the marker value to the center value of DC Control voltage<br>Sets the marker value to the center value of DC Power voltage | :SOUR:FP[1-1]:VOLT:CONT:CENT<br>:SOUR:FP[1-1]:VOLT:POW:CENT |
| <b>Marker -&gt; Start</b>  | Sets the marker value to the start value of DC Control voltage<br>Sets the marker value to the start value of DC Power voltage   | :SOUR:FP[1-1]:VOLT:CONT:STAR<br>:SOUR:FP[1-1]:VOLT:POW:STAR |
| <b>Marker -&gt; Stop</b>   | Sets the marker value to the stop value of DC Control voltage<br>Sets the marker value to the stop value of DC Power voltage     | :SOUR:FP[1-1]:VOLT:CONT:STOP<br>:SOUR:FP[1-1]:VOLT:POW:STOP |
| <b>Measurement View</b>    |                                                                                                                                  |                                                             |
| <b>Freq &amp; Power</b>    | Selects frequency,power and DC current measurement window                                                                        | :DISP:WIND:ACT                                              |
| <b>Phase Noise</b>         | Selects phase noise measurement window                                                                                           | :DISP:WIND:ACT                                              |
| <b>Show Window</b>         |                                                                                                                                  |                                                             |
| <b>Freq &amp; Power</b>    | Turns on/off frequency,power and DC current measurement mode                                                                     | :DISP:FP[1-1]:STAT                                          |
| <b>Phase Noise</b>         | Turns on/off noise measurement mode                                                                                              | :DISP:PN[1-1]:STAT                                          |
| <b>Spectrum Monitor</b>    | Turns on/off spectrum monitor mode                                                                                               | :DISP:SP[1-1]:STAT                                          |
| <b>Transient</b>           | Turns on/off transient measurement mode                                                                                          | :DISP:TR[1-1]:STAT                                          |
| <b>User</b>                | Turns on/off user defined window                                                                                                 | :DISP:USER[1-1]:STAT                                        |
| <b>Spectrum Monitor</b>    | Selects spectrum monitor mode                                                                                                    | :DISP:WIND:ACT                                              |
| <b>Transient</b>           | Selects transient monitor mode                                                                                                   | :DISP:WIND:ACT                                              |
| <b>User</b>                | Selects user defined window                                                                                                      | :DISP:WIND:ACT                                              |
| <b>Preset</b>              |                                                                                                                                  |                                                             |
| <b>Factory</b>             | Preset instrument to the initial setup state                                                                                     | :SYST:PRES                                                  |
| <b>User</b>                | Preset instrument and recalls the Autorec.sta in the F drive                                                                     |                                                             |

Softkey Functions  
FP Menu

Table D-3 FP Menu

| Key Operation       | Function                                                                              | SCPI Command                              |
|---------------------|---------------------------------------------------------------------------------------|-------------------------------------------|
| <b>Save/Recall</b>  |                                                                                       |                                           |
| Explorer...         | Open windows explorer                                                                 |                                           |
| Recall by filename  | Recalls state file by file name                                                       | :MMEM:LOAD:STAT                           |
| <b>Recall State</b> |                                                                                       |                                           |
| Autorec             | Recalls settings                                                                      | :MMEM:LOAD:STAT                           |
| File Dialog...      | Open file dialog                                                                      |                                           |
| State01             | Recalls state file from register 1                                                    | :MMEM:LOAD:STAT                           |
| State02             | Recalls state file from register 2                                                    | :MMEM:LOAD:STAT                           |
| State03             | Recalls state file from register 3                                                    | :MMEM:LOAD:STAT                           |
| State04             | Recalls state file from register 4                                                    | :MMEM:LOAD:STAT                           |
| State05             | Recalls state file from register 5                                                    | :MMEM:LOAD:STAT                           |
| State06             | Recalls state file from register 6                                                    | :MMEM:LOAD:STAT                           |
| Save Data Trace     | Saves trace data                                                                      | :MMEM:FP[1-1]:TRAC[1-4]:ST<br>OR[:DATA]   |
| Save Memory Trace   | Saves memory trace data                                                               | :MMEM:FP[1-1]:TRAC[1-4]:ST<br>OR:MEM      |
| <b>Save State</b>   |                                                                                       |                                           |
| Autorec             | Save settings                                                                         | :MMEM:STOR:STAT                           |
| File Dialog...      | Open file dialog                                                                      |                                           |
| Save Type           | Selects instrument state type (Entire or instrument state only)                       | :MMEM:STOR:STYP                           |
| State01             | Save state file to register 1                                                         | :MMEM:STOR:STAT                           |
| State02             | Save state file to register 2                                                         | :MMEM:STOR:STAT                           |
| State03             | Save state file to register 3                                                         | :MMEM:STOR:STAT                           |
| State04             | Save state file to register 4                                                         | :MMEM:STOR:STAT                           |
| State05             | Save state file to register 5                                                         | :MMEM:STOR:STAT                           |
| State06             | Save state file to register 6                                                         | :MMEM:STOR:STAT                           |
| <b>Scale</b>        |                                                                                       |                                           |
| Auto Scale          | Execute autoscale                                                                     | :DISP:FP[1-1]:TRAC[1-4]:Y[:SC<br>AL]:AUTO |
| Auto Scale All      | Execute autoscale for all traces on frequency,power and DC current measurement window | :DISP:FP[1-1]:ALLT:Y:SCAL:A<br>UTO        |
| Divisions           | Sets/reads Y-scale divisions                                                          | :DISP:FP[1-1]:Y[:SCAL]:DIV                |
| Marker -> Reference | Sets the marker value to the reference level                                          | :DISP:FP[1-1]:TRAC[1-4]:Y[:SC<br>AL]:RLEV |
| Reference Position  | Sets/reads reference position                                                         | :DISP:FP[1-1]:TRAC[1-4]:Y[:SC<br>AL]:RPOS |



**Table D-3 FP Menu**

| Key Operation                   | Function                                                                                    | SCPI Command                                                                |
|---------------------------------|---------------------------------------------------------------------------------------------|-----------------------------------------------------------------------------|
| <b>Reference Value</b>          | Sets/reads the reference level value                                                        | :DISP:FP[1-1]:TRAC[1-4]:Y[:SCAL]:RLEV                                       |
| <b>Scale/Div</b>                | Sets/reads scale per division                                                               | :DISP:FP[1-1]:TRAC[1-4]:Y[:SCAL]:PDIV                                       |
| <b>X Axis</b>                   |                                                                                             |                                                                             |
| <b>Auto</b>                     | Sets/Reads automatic setting of the X-axis display range to the stimulus value              | :DISP:FP[1-1]:TRAC[1-4]:X:SCAL:AUTO                                         |
| <b>Band Marker -&gt; X Axis</b> | Sets the X-axis band marker range to the X-axis display range of a graph                    | :DISP:FP[1-1]:TRAC[1-4]:X:SCAL:LEFT<br>:DISP:FP[1-1]:TRAC[1-4]:X:SCAL:RIGHT |
| <b>Left</b>                     | Sets/Reads the start value of the X-axis display range                                      | :DISP:FP[1-1]:TRAC[1-4]:X:SCAL:LEFT                                         |
| <b>Right</b>                    | Sets/Reads the stop value of the X-axis display range                                       | :DISP:FP[1-1]:TRAC[1-4]:X:SCAL:RIGHT                                        |
| <b>Setup</b>                    |                                                                                             |                                                                             |
| <b>Carrier Search</b>           | Searches carrier signal and reflects the result to the input frequency of the downconverter | :SENS:FP[1-1]DCON:SSE:EXEC                                                  |
| <b>Freq Resolution</b>          | Sets/reads frequency resolution                                                             | :SENS:FP[1-1]:FREQ:RES                                                      |
| <b>Frequency Band</b>           | Selects frequency band                                                                      | :SENS:FP[1-1]:FBAN                                                          |
| <b>Max Input Level</b>          | Sets/reads the maximum input level of the downconverter in order to determine the IF Gain   | :SENS:FP[1-1]:POW:INP:LEV:MAX                                               |
| <b>Nominal Frequency</b>        | Sets/reads the input frequency to be supplied to the downconverter                          | :SENS:FP[1-1]:DCON:FREQ                                                     |
| <b>Point Delay</b>              | Sets/reads the point delay value                                                            | :SENS:FP[1-1]:SWE:DWEL                                                      |
| <b>Points</b>                   | Sets/reads the number of measurement points                                                 | :SOUR:FP[1-1]:SWE:POIN                                                      |
| <b>Sweep Parameter</b>          | Sets/reads sweep parameter                                                                  | :SOUR:FP[1-1]:SWE:PAR                                                       |
| <b>Start/Center</b>             |                                                                                             |                                                                             |
| <b>DC Control Center</b>        | Sets/reads the center value of DC Control voltage                                           | :SOUR:FP[1-1]:VOLT:CONT:CENT                                                |
| <b>DC Control Span</b>          | Sets/reads the span value of DC Control voltage                                             | :SOUR:FP[1-1]:VOLT:CONT:SPAN                                                |
| <b>DC Control Start</b>         | Sets/reads the start value of DC Control voltage                                            | :SOUR:FP[1-1]:VOLT:CONT:START                                               |
| <b>DC Control Stop</b>          | Sets/reads the stop value of DC Control voltage                                             | :SOUR:FP[1-1]:VOLT:CONT:STOP                                                |
| <b>DC Power Center</b>          | Sets/reads the center value of DC Power voltage                                             | :SOUR:FP[1-1]:VOLT:POW:CENT                                                 |
| <b>DC Power Span</b>            | Sets/reads the span value of DC Power voltage                                               | :SOUR:FP[1-1]:VOLT:POW:SPAN                                                 |

**Table D-3 FP Menu**

| Key Operation                        | Function                                                         | SCPI Command                       |
|--------------------------------------|------------------------------------------------------------------|------------------------------------|
| <b>DC Power Start</b>                | Sets/reads the start value of DC Power voltage                   | :SOUR:FP[1-1]:VOLT:POW:STAR        |
| <b>DC Power Stop</b>                 | Sets/reads the stop value of DC Power voltage                    | :SOUR:FP[1-1]:VOLT:POW:STOP        |
| <b>Stop/Span</b>                     |                                                                  |                                    |
| <b>DC Control Center</b>             | Sets/reads the center value of DC Power voltage                  | :SOUR:FP[1-1]:VOLT:CONT:CENT       |
| <b>DC Control Span</b>               | Sets/reads the span value of DC Power voltage                    | :SOUR:FP[1-1]:VOLT:CONT:SPAN       |
| <b>DC Control Start</b>              | Sets/reads the start value of DC Power voltage                   | :SOUR:FP[1-1]:VOLT:CONT:STAR       |
| <b>DC Control Stop</b>               | Sets/reads the stop value of DC Control voltage                  | :SOUR:FP[1-1]:VOLT:CONT:STOP       |
| <b>DC Power Center</b>               | Sets/reads the center value of DC Power voltage                  | :SOUR:FP[1-1]:VOLT:POW:CENT        |
| <b>DC Power Span</b>                 | Sets/reads the span value of DC Power voltage                    | :SOUR:FP[1-1]:VOLT:POW:SPAN        |
| <b>DC Power Start</b>                | Sets/reads the start value of DC Power voltage                   | :SOUR:FP[1-1]:VOLT:POW:STAR        |
| <b>DC Power Stop</b>                 | Sets/reads the stop value of DC Power voltage                    | :SOUR:FP[1-1]:VOLT:POW:STOP        |
| <b>System</b>                        |                                                                  |                                    |
| <b>Abort Printing</b>                | Aborts printing                                                  | :HCOP:ABOR                         |
| <b>Backlight</b>                     | Turns on/off backlight                                           | :SYST:BACK:STAT                    |
| <b>Instrument Setup</b>              |                                                                  |                                    |
| <b>Correction</b>                    |                                                                  |                                    |
| <b>File Dialog ...</b>               | Loads correction data for a specified power                      | :MMEM:LOAD:CORR:POW                |
| <b>Import Power Correction Table</b> | Loads correction data for a specified power                      | :MMEM:LOAD:CORR:POW                |
| <b>Power Correction</b>              | Sets user the user calibration on or off or reads its setting    | :SENS:CORR:POW:STAT                |
| <b>Downconverter Manual Setup</b>    |                                                                  |                                    |
| <b>Current</b>                       | Sets/reads the bias current to be supplied to the external mixer | :SENS:DCON:MAN:MEXT[1-2]:BIAS:CURR |
| <b>IF Gain 1</b><br><b>IF Gain 2</b> | Sets/reads the IF gain of the external mixer                     | :SENS:DCON:MAN:IFG[1-2]            |

**Table D-3 FP Menu**

| Key Operation                                | Function                                                                              | SCPI Command                       |
|----------------------------------------------|---------------------------------------------------------------------------------------|------------------------------------|
| <b>LO1 Frequency</b><br><b>LO2 Frequency</b> | Sets/reads the LO frequency of the external mixer                                     | :SNES:DCON:MAN:LO[1-2]:FREQ        |
| <b>LO1 Level</b><br><b>LO2 Level</b>         | Sets/reads the LO level of the external mixer                                         | :SENS:DCON:MAN:LO[1-2]:LEVEL       |
| <b>Mixer 1 Bias</b><br><b>Mixer 2 Bias</b>   | Sets the bias current supplied to the external mixer on or off and reads its settings | :SENS:DCON:MAN:MEXT[1-2]:BIAS:STAT |
| $\Delta F = IF2 - IF1$                       | Sets/reads the differential frequency between CH1 and CH2 from the external mixer     | :SENS:DCON:MAN:IFD                 |
| <b>Frequency Offset (User Downconv.)</b>     |                                                                                       |                                    |
| <b>Conversion Mode</b>                       | Sets/reads the conversion mode of the frequency offset                                | :SENS:UDC:MODE                     |
| <b>Frequency Offset</b>                      | Sets/reads the frequency offset                                                       | :SENS:UDC:STAT                     |
| <b>Harmonic #</b>                            | Sets/reads the frequency offset factor                                                | :SENS:UDC:HARM                     |
| <b>LO Frequency</b>                          | Sets/reads the LO frequency of the frequency offset                                   | :SENS:UDC:LO                       |
| <b>Dump Screen Image</b>                     | Save screen image                                                                     | :MMEM:STOR:IMAG                    |
| <b>Error Log</b>                             |                                                                                       |                                    |
| <b>Clear Error Log</b>                       | Clear error log                                                                       |                                    |
| <b>View Error Log...</b>                     | Display error log                                                                     |                                    |
| <b>Invert Image</b>                          | Selects print mode                                                                    | :HCOP:IMAG                         |
| <b>Misc Setup</b>                            |                                                                                       |                                    |
| <b>Beeper</b>                                |                                                                                       |                                    |
| <b>Beep Complete</b>                         | Turns on/off the beep for operation completion                                        | :SYST:BEEP:COMP:STAT               |
| <b>Beep Warning</b>                          | Turns on/off the beep for warning                                                     | :SYST:BEEP:WARN:STAT               |
| <b>Test Beep Complete</b>                    | Make beep sound for operation completion                                              | :SYST:BEEP:COMP:IMM                |
| <b>Test Beep Warning</b>                     | Makes beep sound for warning                                                          | :SYST:BEEP:WARN:IMM                |
| <b>Clock Setup</b>                           |                                                                                       |                                    |
| <b>Set Date and Time</b>                     | Sets/reads system time<br>Sets/reads system date                                      | :SYST:TIME<br>:SYST:DATE           |
| <b>Show Clock</b>                            | Turns on/off internal clock display                                                   | :DISP:CLOC                         |

Table D-3 FP Menu

| Key Operation         | Function                                                       | SCPI Command                |
|-----------------------|----------------------------------------------------------------|-----------------------------|
| <b>Color Setup</b>    |                                                                |                             |
| <b>Invert</b>         | Sets each color when the inverted display is selected          |                             |
| <b>Background</b>     | Sets/Reads the background color                                | :DISP:COL2:BACK[:VAL]       |
| <b>Data Trace 1</b>   | Sets/Reads the color of the data trace of trace 1              | :DISP:COL2:TRAC1:DATA[:VAL] |
| :                     |                                                                |                             |
| <b>Data Trace 8</b>   | Sets/Reads the color of the data trace of trace 8              | :DISP:COL2:TRAC8:DATA[:VAL] |
| <b>Graticule Main</b> | Sets/Reads the color of the graph                              | :DISP:COL2:GRAT1[:VAL]      |
| <b>Graticule Sub</b>  | Sets/Reads the color of the grid lines in the graph            | :DISP:COL2:GRAT2[:VAL]      |
| <b>Limit Fail</b>     | Sets/Reads the limit display color                             | :DISP:COL2:LIM1[:VAL]       |
| <b>Limit Line</b>     | Sets/Reads the color of the limit line                         | :DISP:COL2:LIM2[:VAL]       |
| <b>Mem Trace 1</b>    | Sets/Reads the color of the memory trace of trace 1            | :DISP:COL2:TRAC1:MEM[:VAL]  |
| :                     |                                                                |                             |
| <b>Mem Trace 8</b>    | Sets/Reads the color of the memory trace of trace 8            | :DISP:COL2:TRAC8:MEM[:VAL]  |
| <b>Reset Color</b>    | Resets the display color to the factory preset default setting | :DISP:COL2:RES              |
| <b>Normal</b>         | Sets each color when the normal display is selected            |                             |
| <b>Background</b>     | Sets/Reads the background color                                | :DISP:COL1:BACK[:VAL]       |
| <b>Data Trace 1</b>   | Sets/Reads the color of the data trace of trace 1              | :DISP:COL1:TRAC1:DATA[:VAL] |
| :                     |                                                                |                             |
| <b>Data Trace 8</b>   | Sets/Reads the color of the data trace of trace 8              | :DISP:COL1:TRAC8:DATA[:VAL] |
| <b>Graticule Main</b> | Sets/Reads the color of the graph                              | :DISP:COL1:GRAT1[:VAL]      |
| <b>Graticule Sub</b>  | Sets/Reads the color of the grid lines in the graph            | :DISP:COL1:GRAT2[:VAL]      |
| <b>Limit Fail</b>     | Sets/Reads the limit display color                             | :DISP:COL1:LIM1[:VAL]       |
| <b>Limit Line</b>     | Sets/Reads the color of the limit line                         | :DISP:COL1:LIM2[:VAL]       |
| <b>Mem Trace 1</b>    | Sets/Reads the color of the memory trace of trace 1            | :DISP:COL1:TRAC1:MEM[:VAL]  |

**Table D-3 FP Menu**

| Key Operation                          | Function                                                                                               | SCPI Command                |
|----------------------------------------|--------------------------------------------------------------------------------------------------------|-----------------------------|
| :                                      |                                                                                                        |                             |
| :                                      |                                                                                                        |                             |
| <b>Mem Trace 8</b>                     | Sets/Reads the color of the memory trace of trace 8                                                    | :DISP:COL1:TRAC8:MEM[:VAL ] |
| <b>Reset Color</b>                     | Resets the display color to the factory preset default setting                                         | :DISP:COL1:RES              |
| <b>Control Panel ...</b>               | Open control panel                                                                                     |                             |
| <b>GPIB Setup</b>                      |                                                                                                        |                             |
| <b>System Controller Configuration</b> | Turns on/off system controller mode                                                                    |                             |
| <b>Talker/Listener Address</b>         | Sets/reads talker/listener GPIB address of the                                                         |                             |
| <b>Key Lock</b>                        |                                                                                                        |                             |
| <b>Front Panel &amp; Keyboard Lock</b> | Disables from panelkeyboard operations                                                                 | :SYST:KLOC:KBD              |
| <b>Touch Screen &amp; Mouse Lock</b>   | Disables from mouse/touch screen operations                                                            | :SYST:KLOC:MOUS             |
| <b>Network Setup</b>                   |                                                                                                        |                             |
| <b>MAC Address</b>                     | Sets MAC address                                                                                       |                             |
| <b>Network Configuration ...</b>       | Enables/disables network connections                                                                   |                             |
| <b>Network Identification ...</b>      | Sets network ID of the instrument                                                                      |                             |
| <b>SICL-LAN Address</b>                | Sets SICL-LAN address                                                                                  |                             |
| <b>SICL-LAN Server</b>                 | Enables/disables SICL-LAN server                                                                       |                             |
| <b>Socket Server</b>                   | Enables/disables Socket server                                                                         |                             |
| <b>Telnet Server</b>                   | Enables/disables telnet server                                                                         |                             |
| <b>Print</b>                           | Output print                                                                                           | :HCOP:IMM                   |
| <b>Printer Setup ...</b>               | Execute printer setup                                                                                  |                             |
| <b>Service Menu</b>                    |                                                                                                        |                             |
| <b>Administrator Menu</b>              | Displays softkeys associated with Administrator Menu. This function is not available to general users. |                             |

Softkey Functions  
FP Menu

Table D-3 FP Menu

| Key Operation                 | Function                                                                                         | SCPI Command                      |
|-------------------------------|--------------------------------------------------------------------------------------------------|-----------------------------------|
| <b>Error Log</b>              |                                                                                                  |                                   |
| <b>Clear Error Log</b>        | Clears the error log                                                                             |                                   |
| <b>View Error Log ...</b>     | Displays the error log                                                                           |                                   |
| <b>Install Option License</b> |                                                                                                  |                                   |
| <b>Jitter</b>                 | Enters the license for clock jitter analysis                                                     |                                   |
| <b>Service Function</b>       | Displays softkeys associated with Service Menu. This function is not available to general users. |                                   |
| <b>Test Menu</b>              |                                                                                                  |                                   |
| <b>Power On Test</b>          | Performs internal test                                                                           |                                   |
| <b>Display Test</b>           | Performs display test                                                                            |                                   |
| <b>Front Panel</b>            | Performs front panel key (hard key) test                                                         |                                   |
| <b>Adjust Touch Screen</b>    | Performs touch screen calibration                                                                |                                   |
| <b>E5053A Test</b>            | Displays the connection status of <b>E5053A</b>                                                  |                                   |
| <b>Trace View</b>             |                                                                                                  |                                   |
| <b>Aperture</b>               | Smoothing aperture                                                                               | :CALC:FP[1-1]:TRAC[1-4]:SMO:APER  |
| <b>Copy to User</b>           | Copies trace data to the user trace                                                              | :CALC:FP[1-1]:TRAC[1-4]:DATA:COPY |
| <b>Data -&gt; Mem</b>         | Copy data to memory                                                                              | :CALC:FP[1-1]:TRAC[1-4]:MATH:MEM  |
| <b>Data Hold</b>              | Data hold                                                                                        | :CALC:FP[1-1]:TRAC[1-4]:HOLD      |
| <b>Data Math</b>              | Sets/reads math operation type                                                                   | :CALC:FP[1-1]:TRAC[1-4]:MATH:FUNC |
| <b>Display Trace</b>          | Shows data and/or memory trace                                                                   | :DISP:FP[1-1]:TRAC[1-4]:MODE      |
| <b>Marker -&gt; -Offset</b>   | Sets the sign-inverted data value of the data trace's active marker to the offset value          | :CALC:FP[1-1]:TRAC[1-4]:MATH:OFFS |
| <b>Memory Trace</b>           |                                                                                                  |                                   |
| <b>Line (Y = AX + B)</b>      |                                                                                                  |                                   |
| <b>A</b>                      | Sets/Reads regression line coefficient a (slope)                                                 | :CALC:FP[1-1]:TRAC[1-4]:LINE:A    |
| <b>B</b>                      | Sets/Reads regression line coefficient b (intercept)                                             | :CALC:FP[1-1]:TRAC[1-4]:LINE:B    |

**Table D-3 FP Menu**

| Key Operation                      | Function                                                                                           | SCPI Command                                                                                                |
|------------------------------------|----------------------------------------------------------------------------------------------------|-------------------------------------------------------------------------------------------------------------|
| <b>Data Trace -&gt; A, B</b>       | Assigns the measurement results to regression line coefficients (a, b)                             | :CALC:FP[1-1]:TRAC[1-4]:FUNC:LREG:DATA?<br>:CALC:FP[1-1]:TRAC[1-4]:LINE:A<br>:CALC:FP[1-1]:TRAC[1-4]:LINE:B |
| <b>Set Line to Memory</b>          | Sets the obtained regression line to the memory trace                                              | :CALC:FP[1-1]:TRAC[1-4]:LINE:MEM                                                                            |
| <b>Offset</b>                      | Sets/Reads the offset value of the data trace                                                      | :CALC:FP[1-1]:TRAC[1-4]:MATH:OFFS                                                                           |
| <b>Persistence</b>                 |                                                                                                    |                                                                                                             |
| <b>Clear Persistent Data</b>       | Clears persistent mode                                                                             | :DISP:FP[1-1]:TRAC[1-4]:PERS:CLE                                                                            |
| <b>Persistence Mode</b>            | Sets/reads persistent mode                                                                         | :DISP:FP[1-1]:TRAC[1-4]:PERS:STAT                                                                           |
| <b>Smoothing</b>                   | Smoothing on/off                                                                                   | :CALC:FP[1-1]:TRAC[1-4]:SMO:STAT                                                                            |
| <b>Trace Label</b>                 | Edits trace title label                                                                            | :DISP:FP[1-1]:TRAC[1-4]:LAB:DATA                                                                            |
| <b>Trigger</b>                     |                                                                                                    |                                                                                                             |
| <b>Average Trigger</b>             | Sets/Reads the averaging trigger function                                                          | :TRIG:AVER                                                                                                  |
| <b>Continuous</b>                  | always move to waiting-for-trigger state after measuring<br>move once to waiting-for-trigger state | :INIT:FP[1-1]:CONT<br>:INIT:FP[1-1]:IMM                                                                     |
| <b>Ext Trig Polarity</b>           | External trigger polarity                                                                          | :TRIG:EXT:SLOP                                                                                              |
| <b>Hold</b>                        | Sets trigger mode to waiting-for-trigger state                                                     | :INIT:FP[1-1]:IMM                                                                                           |
| <b>Manual Trigger</b>              | move once to waiting-for-trigger state                                                             | :INIT:FP[1-1]:IMM                                                                                           |
| <b>Mode</b>                        | Sets/reads instrument mode to analyzer or tester mode <sup>*1</sup>                                | :TRIG:FP[1-1]:MODE <sup>*2</sup>                                                                            |
| <b>Restart</b>                     | move once to waiting-for-trigger state                                                             | :INIT:FP[1-1]:IMM                                                                                           |
| <b>Single</b>                      | always move to waiting-for-trigger state after measuring<br>move once to waiting-for-trigger state | :INIT:FP[1-1]:CONT<br>:INIT:FP[1-1]:IMM                                                                     |
| <b>Source</b>                      | trigger source                                                                                     | :TRIG:FP[1-1]:SOUR                                                                                          |
| <b>Trigger to Freq &amp; Power</b> | select measurement mode                                                                            | :TRIG:MODE                                                                                                  |

\*1. Only “Tester” mode is available when option 011 is installed.

\*2. “Option not installed” error message is generated when setting the trigger mode to analyzer mode with the instrument for the option 011.

## Transient Menu (Top Menu)

| Key Operation                                  | Function                                                                                                             |
|------------------------------------------------|----------------------------------------------------------------------------------------------------------------------|
| <b>Double-click on each softkey menu title</b> | Displays the top menu of each menu item below. Refer the TR menu about detail of following each menu item.           |
| Measurement View                               | Same as <b>Meas</b> .                                                                                                |
| Input                                          | Same as <b>Scale</b> .                                                                                               |
| Scale                                          | Same as <b>Scale</b> .                                                                                               |
| Format                                         | Same as <b>Format</b> .                                                                                              |
| Display                                        | Same as <b>Display</b> .                                                                                             |
| Average                                        | Same as <b>Avg</b> .                                                                                                 |
| Attenuator                                     | Same as <b>Cal</b> .                                                                                                 |
| Time Offset                                    | Displays the same softkey for setting up the sweep range that appears when <b>Start</b> , or <b>Span</b> is pressed. |
| Span                                           | Displays the same softkey for setting up the sweep range that appears when <b>Start</b> , or <b>Span</b> is pressed. |
| DC Conrol Voltage                              | Same as <b>Sweep Setup</b> .                                                                                         |
| DC Power Voltage                               | Same as <b>Sweep Setup</b> .                                                                                         |
| Setup                                          | Same as <b>Sweep Setup</b> .                                                                                         |
| Trigger                                        | Same as <b>Trigger</b> .                                                                                             |
| Marker                                         | Same as <b>Marker</b> .                                                                                              |
| Marker Search                                  | Same as <b>Marker Search</b> .                                                                                       |
| Marker To                                      | Same as <b>Marker Search</b> .                                                                                       |
| Marker Function                                | Same as <b>Marker Fctn</b> .                                                                                         |
| Macro Setup                                    | Same as <b>Macro Setup</b> .                                                                                         |
| Save/Recall                                    | Same as <b>Save/Recall</b> .                                                                                         |
| System                                         | Same as <b>System</b> .                                                                                              |
| Preset                                         | Same as <b>Preset</b> .                                                                                              |



## TR Menu

Table D-4 TR Menu

| Key Operation                      | Function                                                                                       | SCPI Command                                              |
|------------------------------------|------------------------------------------------------------------------------------------------|-----------------------------------------------------------|
| <b>Attenuator</b>                  |                                                                                                |                                                           |
| <b>Input Attenuator</b>            | Sets/reads Input Attenuator level on 5dB Step                                                  | :SENS:ATT:LEV                                             |
| <b>Average</b>                     |                                                                                                |                                                           |
| <b>Averaging</b>                   | Turn on/off averaging function                                                                 | :SENS:TR[1-1]:AVER:STAT                                   |
| <b>Averaging Restart</b>           | Restart averaging                                                                              | :SENS:TR[1-1]:AVER:CLE                                    |
| <b>Avg Factor</b>                  | Sets/reads averaging count                                                                     | :SENS:TR[1-1]:AVER:COUN                                   |
| <b>DC Control Voltage</b>          |                                                                                                |                                                           |
| <b>Auto Freq Control</b>           |                                                                                                |                                                           |
| <b>AFC Status</b>                  | Turns on/off the auto frequency control function.<br>Executes the auto frequency control once. | :SOUR:VOLT:CONT:AFC[:STAT<br>]<br>:SOUR:VOLT:CONT:AFC:IMM |
| <b>Frequency Band</b>              | Sets/reads the frequency band in the auto frequency control function                           | :SOUR:VOLT:CONT:AFC:FBAN                                  |
| <b>Max Ctrl Voltage Limit</b>      | Sets/reads the maximum DC control voltage limit                                                | :SOUR:VOLT:CONT:AFC:LIM:<br>HIGH                          |
| <b>Max Input Level</b>             | Sets/reads the maximum input level                                                             | :SOUR:VOLT:CONT:AFC:INP:L<br>EV:MAX                       |
| <b>Max Iteration</b>               | Sets/reads the maximum number of iterations for the DC control voltage-setting loops           | :SOUR:VOLT:CONT:AFC:ITER                                  |
| <b>Min Ctrl Voltage Limit</b>      | Sets/reads the minimum DC control voltage limit                                                | :SOUR:VOLT:CONT:AFC:LIM:<br>LOW                           |
| <b>Sensitivity</b>                 | Sets/reads the tuning sensitivity                                                              | :SOUR:VOLT:CONT:AFC:SENS                                  |
| <b>Target</b>                      | Sets/reads the target frequency in the auto frequency control function                         | :SOUR:VOLT:CONT:AFC:TARG                                  |
| <b>Tolerance</b>                   | Sets/reads the tolerance limit                                                                 | :SOUR:VOLT:CONT:AFC:TOL                                   |
| <b>Control Voltage Cal</b>         | Enables DC Control voltage calibration                                                         | :SOUR:VOLT:CONT:CORR[:ST<br>AT]                           |
| <b>DC Control Delay</b>            | Sets/reads DC Control delay (sec)                                                              | :SOUR:VOLT:CONT:DEL                                       |
| <b>DC Control Output</b>           | Turns on/off DC Control voltage                                                                | :SOUR:VOLT:CONT:LEV:STAT                                  |
| <b>DC Control Voltage</b>          | Sets/reads DC Control voltage                                                                  | :SOUR:VOLT:CONT:LEV:AMP<br>L                              |
| <b>Execute Control Voltage Cal</b> | Execute DC Control voltage calibration                                                         | :SOUR:VOLT:CONT:CORR:CO<br>LL:ACQ                         |
| <b>Max Ctrl Voltage Limit</b>      | Sets/reads the maximum DC control voltage limit                                                | :SOUR:VOLT:CONT:LIM:HIGH                                  |
| <b>Min Ctrl Voltage Limit</b>      | Sets/reads the minimum DC control voltage limit                                                | :SOUR:VOLT:CONT:LIM:LOW                                   |

**Table D-4 TR Menu**

| Key Operation                      | Function                                                     | SCPI Command                             |
|------------------------------------|--------------------------------------------------------------|------------------------------------------|
| <b>DC Power Voltage</b>            |                                                              |                                          |
| <b>DC Power Delay</b>              | Sets/reads DC Power delay (sec)                              | :SOUR:VOLT:POW:DEL                       |
| <b>DC Power Output</b>             | Turns on/off DC Power voltage                                | :SOUR:VOLT:POW:LEV:STAT                  |
| <b>DC Power Voltage</b>            | Sets/reads DC Power voltage                                  | :SOUR:VOLT:POW:LEV:AMPL                  |
| <b>Max Pwr Voltage Limit</b>       | Sets/reads the maximum DC Power voltage limit                | :SOUR:VOLT:POW:LIM:HIGH                  |
| <b>Min Pwr Voltage Limit</b>       | Sets/reads the minimum DC Power voltage limit                | :SOUR:VOLT:POW:LIM:LOW                   |
| <b>Display</b>                     |                                                              |                                          |
| <b>Edit Title Label</b>            | Edits the measurement window title label                     | :DISP:TR[1-1]:LAB:DATA                   |
| <b>Color Type</b>                  | Sets/Reads the display type of the display (normal/inverted) | :DISP:IMAG                               |
| <b>Limit Test</b>                  |                                                              |                                          |
| <b>Delete Lower Limit Line</b>     | Clears the lower limit line                                  | :CALC:TR[1-1]:TRAC[1-4]:LIM:LOW:SEGM:CLE |
| <b>Delete Upper Limit Line</b>     | Clears the upper limit line                                  | :CALC:TR[1-1]:TRAC[1-4]:LIM:UPP:SEGM:CLE |
| <b>Explorer</b>                    |                                                              |                                          |
| <b>Fail Sign</b>                   | Turns on/off the limit test judgement display                | :DISP:TR[1-1]:LIM:FSIG                   |
| <b>Import Lower Limit Line ...</b> | Reads the lower limit line                                   | :MMEM:TR[1-1]:TRAC[1-4]:LOAD:LIM:LOW     |
| <b>Import Upper Limit Line ...</b> | Reads the upper limit line                                   | :MMEM:TR[1-1]:TRAC[1-4]:LOAD:LIM:UPP     |
| <b>Limit Line</b>                  | Turns on/off the limit line                                  | :DISP:TR[1-1]:TRAC[1-4]:LIM:LINE         |
| <b>Limit Test</b>                  | Turns on/off the limit test function                         | :CALC:TR[1-1]:TRAC[1-4]:LIM[:STAT]       |
| <b>Marker Information</b>          | Sets/reads the marker information position                   | :DISP:TR[1-1]:ANN:MARK:POS               |
| <b>Meas Condition</b>              | Turns on/off measurement conditions                          | :DISP:TR[1-1]:ANN:MEAS:STAT              |
| <b>Relative Y-Scale</b>            | Turns on/off relative Y-scale                                | :DISP:TR[1-1]:GRAT:AXIS:Y:REL            |
| <b>Security Level</b>              | Sets/recalls the security level                              | :SYST:SEC[:LEV]                          |
| <b>Title Label</b>                 | Turns on/off the measurement window title label              | :DISP:TR[1-1]:LAB:STAT                   |
| <b>Update</b>                      | Turns on/off trace updates                                   | :DISP:ENAB                               |
| <b>Y # of Digits</b>               | Selects the number of digits (Y-axis)                        | :DISP:TR[1-1]:GRAT:AXIS:Y:STAT           |

Table D-4 TR Menu

| Key Operation                         | Function                                                                                                 | SCPI Command                           |
|---------------------------------------|----------------------------------------------------------------------------------------------------------|----------------------------------------|
| <b>Format</b>                         |                                                                                                          |                                        |
| <b>Frequency Format</b>               | Sets/reads the frequency format                                                                          | :CALC:TR[1-1]:TRAC[1-4]:FORM:FREQ      |
| <b>Frequency Reference</b>            | Sets/reads the reference frequency                                                                       | :CALC:TR[1-1]:TRAC[1-4]:REF:FREQ       |
| <b>Marker -&gt; Phase X Reference</b> | Sets/Reads the data value of the active marker's position to 0 degree reference of phase                 | :CALC:TR[1-1]:TRAC[1-4]:FORM:PHAS:XREF |
| <b>Phase Unit</b>                     | Selects phase format on transient measurement                                                            | :CALC:TR[1-1]:TRAC[1-4]:FORM:PHAS:UNIT |
| <b>Phase X Reference</b>              | Sets/Reads the data value of the active trace's specified X-axis position to 0 degree reference of phase | :CALC:TR[1-1]:TRAC[1-4]:FORM:PHAS:XREF |
| <b>Wrap Phase</b>                     | Turns on/off wrap-phase                                                                                  | :CALC:TR[1-1]:TRAC[1-4]:FORM:PHAS:WRAP |
| <b>Input Port</b>                     |                                                                                                          |                                        |
| <b>Downconverter</b>                  |                                                                                                          |                                        |
| <b>Downconverter</b>                  | Sets the use of the downconverter on or off, or reads its setting                                        | :SENS:DCON[:STAT]                      |
| <b>RF Input</b>                       | Sets/reads the signal supplied to the RF input port                                                      | :SENS:DCON:INP                         |
| <b>External Mixer</b>                 | Sets the use of the external mixer on or off and reads its settings                                      | :SENS:DCON:MEXT                        |
| <b>Macro Setup</b>                    |                                                                                                          |                                        |
| <b>Application</b>                    |                                                                                                          |                                        |
| <b>Jitter</b>                         | Executes clock jitter analysis (VBA)                                                                     |                                        |
| <b>mmWave</b>                         | Executes phase-noise measurement (VBA)                                                                   |                                        |
| <b>E5052 Event</b>                    | Turns on/off the E5052 VBA event callback function                                                       | :PROG:COM:EVEN                         |
| <b>Echo Window Menu</b>               |                                                                                                          |                                        |
| <b>Clear Echo</b>                     | Clears Echo window                                                                                       | :DISP:ECHO:CLE                         |
| <b>Echo Font Size</b>                 | Sets/reads the font size on Echo window                                                                  | :DISP:ECHO:FSIZ                        |
| <b>Echo Window</b>                    | Turns on/off the Echo window                                                                             | :DISP:ECHO:STAT                        |
| <b>Load &amp; Run</b>                 | Load and execute the macro selected on file names.                                                       |                                        |
| <b>Select Macro</b>                   | Sets/reads the name of the program to be selected                                                        | :PROG:SEL:NAME                         |
| <b>Stop</b>                           | Set/reads the state of the selected program                                                              | :PROG:SEL:STAT                         |
| <b>User Menu</b>                      |                                                                                                          |                                        |
| <b>User Label 1</b>                   | Execute the macro assigned under the user defined softkey                                                | :PROG:SKEY:ITEM[1-8]:IMM               |
| <b>User Label 2</b>                   | Execute the macro assigned under the user defined softkey                                                | :PROG:SKEY:ITEM[1-8]:IMM               |
| <b>User Label 3</b>                   | Execute the macro assigned under the user defined softkey                                                | :PROG:SKEY:ITEM[1-8]:IMM               |
| <b>User Label 4</b>                   | Execute the macro assigned under the user defined softkey                                                | :PROG:SKEY:ITEM[1-8]:IMM               |
| <b>User Label 5</b>                   | Execute the macro assigned under the user defined softkey                                                | :PROG:SKEY:ITEM[1-8]:IMM               |

Softkey Functions  
TR Menu

**Table D-4 TR Menu**

| Key Operation            | Function                                                  | SCPI Command                            |
|--------------------------|-----------------------------------------------------------|-----------------------------------------|
| <b>User Label 6</b>      | Execute the macro assigned under the user defined softkey | :PROG:SKEY:ITEM[1-8]:IMM                |
| <b>User Label 7</b>      | Execute the macro assigned under the user defined softkey | :PROG:SKEY:ITEM[1-8]:IMM                |
| <b>User Label 8</b>      | Execute the macro assigned under the user defined softkey | :PROG:SKEY:ITEM[1-8]:IMM                |
| <b>VBA Editor Menu</b>   |                                                           |                                         |
| <b>Close Editor</b>      | Close VBA editor                                          |                                         |
| <b>Load Project</b>      | Loads program                                             | :MMEM:LOAD:PROG                         |
| <b>New Project</b>       | Open new VBA project                                      |                                         |
| <b>Open Editor</b>       | Open VBA editor                                           |                                         |
| <b>Save Project</b>      | Save VBA project                                          | :MMEM:STOR:PROG                         |
| <b>Marker</b>            |                                                           |                                         |
| <b>Clear Marker Menu</b> |                                                           |                                         |
| <b>All OFF</b>           | Clears all the markers                                    |                                         |
| <b>Marker 1</b>          | Turns on/off marker 1                                     | :CALC:TR[1-1]:TRAC[1-4]:MARK[1-10]:STAT |
| :                        |                                                           |                                         |
| :                        |                                                           |                                         |
| <b>Marker 10</b>         | Turns on/off marker 10                                    | :CALC:TR[1-1]:TRAC[1-4]:MARK[1-10]:STAT |
| <b>Couple</b>            | Turns on/off marker coupling function                     | :CALC:TR[1-1]:ALLT:MARK:COUP:STAT       |
| <b>Marker 1</b>          | Turns on/off marker 1                                     | :CALC:TR[1-1]:TRAC[1-4]:MARK[1-10]:STAT |
| :                        |                                                           |                                         |
| :                        |                                                           |                                         |
| <b>Marker 6</b>          | Turns on/off marker 6                                     | :CALC:TR[1-1]:TRAC[1-4]:MARK[1-10]:STAT |
| <b>Marker List</b>       | Turns on/off the marker list                              | :DISP:TR[1-1]:TABL[:STAT]               |
| <b>More Functions</b>    |                                                           |                                         |
| <b>Discrete</b>          | Sets/reads marker movement (Continuous/Discrete)          | :CALC:TR[1-1]:ALLT:MARK:DISC:STAT       |
| <b>Ref Marker</b>        | Sets/reads marker reference number                        | :CALC:TR[1-1]:ALLT:MARK:REF:NUMB        |
| <b>Ref Marker Mode</b>   | Turns on/off delta marker mode                            | :CALC:TR[1-1]:ALLT:MARK:REF:STAT        |

**Table D-4 TR Menu**

| Key Operation             | Function                                    | SCPI Command                            |
|---------------------------|---------------------------------------------|-----------------------------------------|
| <b>More Markers</b>       |                                             |                                         |
| <b>Marker 7</b>           | Turns on/off marker 7                       | :CALC:TR[1-1]:TRAC[1-4]:MARK[1-10]:STAT |
| :                         |                                             |                                         |
| :                         |                                             |                                         |
| <b>Marker 10</b>          | Turns on/off marker 10                      | :CALC:TR[1-1]:TRAC[1-4]:MARK[1-10]:STAT |
| <b>Marker Function</b>    |                                             |                                         |
| <b>Analysis Range (X)</b> | Sets/reads analysis/search range (X-axis)   | :CALC:TR[1-1]:TRAC[1-4]:FUNCTION:DOM:X  |
| <b>Analysis Range (Y)</b> | Sets/reads analysis/search range (Y-axis)   | :CALC:TR[1-1]:TRAC[1-4]:FUNCTION:DOM:Y  |
| <b>Analysis Type</b>      | Sets/reads analysis type                    | :CALC:TR[1-1]:TRAC[1-4]:FUNCTION:TYPE   |
| <b>Band Marker X</b>      |                                             |                                         |
| <b>Band Marker X</b>      | Turn on/off bandmarker X                    | :CALC:TR[1-1]:TRAC[1-4]:BDM:X:STAT      |
| <b>Center</b>             | Sets/reads the center value of bandmarker X | :CALC:TR[1-1]:TRAC[1-4]:BDM:X:CENT      |
| <b>Span</b>               | Sets/reads the span value of bandmarker X   | :CALC:TR[1-1]:TRAC[1-4]:BDM:X:SPAN      |
| <b>Start</b>              | Sets/reads the start value of bandmarker X  | :CALC:TR[1-1]:TRAC[1-4]:BDM:X:STAR      |
| <b>Stop</b>               | Sets/reads the stop value of bandmarker X   | :CALC:TR[1-1]:TRAC[1-4]:BDM:X:STOP      |
| <b>Band Marker Y</b>      |                                             |                                         |
| <b>Band Marker Y</b>      | Turn on/off bandmarker Y                    | :CALC:TR[1-1]:TRAC[1-4]:BDM:Y:STAT      |
| <b>Center</b>             | Sets/reads the center value of bandmarker Y | :CALC:TR[1-1]:TRAC[1-4]:BDM:Y:CENT      |
| <b>Span</b>               | Sets/reads the span value of bandmarker Y   | :CALC:TR[1-1]:TRAC[1-4]:BDM:Y:SPAN      |
| <b>Start</b>              | Sets/reads the start value of bandmarker Y  | :CALC:TR[1-1]:TRAC[1-4]:BDM:Y:STAR      |
| <b>Stop</b>               | Sets/reads the stop value of bandmarker Y   | :CALC:TR[1-1]:TRAC[1-4]:BDM:Y:STOP      |
| <b>Couple</b>             | Turns on/off bandmarker coupling function   | :CALC:TR[1-1]:ALLT:BDM:X:COUP:STAT      |

**Table D-4 TR Menu**

| Key Operation          | Function                                    | SCPI Command                                      |
|------------------------|---------------------------------------------|---------------------------------------------------|
| <b>Marker Search</b>   |                                             |                                                   |
| <b>Band Marker X</b>   |                                             |                                                   |
| <b>Band Marker X</b>   | Turn on/off bandmarker X                    | :CALC:TR[1-1]:TRAC[1-4]:BDM:X:STAT                |
| <b>Center</b>          | Sets/reads the center value of bandmarker X | :CALC:TR[1-1]:TRAC[1-4]:BDM:X:CENT                |
| <b>Span</b>            | Sets/reads the span value of bandmarker X   | :CALC:TR[1-1]:TRAC[1-4]:BDM:X:SPAN                |
| <b>Start</b>           | Sets/reads the start value of bandmarker X  | :CALC:TR[1-1]:TRAC[1-4]:BDM:X:STAR                |
| <b>Stop</b>            | Sets/reads the stop value of bandmarker X   | :CALC:TR[1-1]:TRAC[1-4]:BDM:X:STOP                |
| <b>Band Marker Y</b>   |                                             |                                                   |
| <b>Band Marker Y</b>   | Turn on/off bandmarker Y                    | :CALC:TR[1-1]:TRAC[1-4]:BDM:Y:STAT                |
| <b>Center</b>          | Sets/reads the center value of bandmarker Y | :CALC:TR[1-1]:TRAC[1-4]:BDM:Y:CENT                |
| <b>Span</b>            | Sets/reads the span value of bandmarker Y   | :CALC:TR[1-1]:TRAC[1-4]:BDM:Y:SPAN                |
| <b>Start</b>           | Sets/reads the start value of bandmarker Y  | :CALC:TR[1-1]:TRAC[1-4]:BDM:Y:STAR                |
| <b>Stop</b>            | Sets/reads the stop value of bandmarker Y   | :CALC:TR[1-1]:TRAC[1-4]:BDM:Y:STOP                |
| <b>Couple</b>          | Turns on/off bandmarker coupling function   | :CALC:TR[1-1]:ALLT:BDM:X:COUP:STAT                |
| <b>Peak</b>            |                                             |                                                   |
| <b>Peak Excursion</b>  | Sets/reads the peak excursion value         | :CALC:TR[1-1]:TRAC[1-4]:MARK[1-10]:SEAR:PEAK:EXC  |
| <b>Peak Polarity</b>   | Sets/reads the marker peak-search polarity  | :CALC:TR[1-1]:TRAC[1-4]:MARK[1-10]:SEAR:PEAK:POL  |
| <b>Search Left</b>     | Execute marker peak search left             | :CALC:TR[1-1]:TRAC[1-4]:MARK[1-10]:SEAR:EXEC:LPE  |
| <b>Search Peak</b>     | Execute marker peak search                  | :CALC:TR[1-1]:TRAC[1-4]:MARK[1-10]:SEAR:EXEC:PEAK |
| <b>Search Peak All</b> | Execute marker search all                   | :CALC:TR[1-1]:TRAC[1-4]:ALLM:SEAR:PEAK            |
| <b>Search Right</b>    | Execute marker peak search right            | :CALC:TR[1-1]:TRAC[1-4]:MARK[1-10]:SEAR:EXEC:RPE  |

**Table D-4 TR Menu**

| Key Operation                       | Function                                                      | SCPI Command                                      |
|-------------------------------------|---------------------------------------------------------------|---------------------------------------------------|
| <b>Search Max</b>                   | Execute marker search maximum                                 | :CALC:TR[1-1]:TRAC[1-4]:MARK[1-10]:SEAR:EXEC:MAX  |
| <b>Search Min</b>                   | Execute marker search minimum                                 | :CALC:TR[1-1]:TRAC[1-4]:MARK[1-10]:SEAR:EXEC:MIN  |
| <b>Search Range (X)</b>             | Sets/reads marker search range (X-axis)                       | :CALC:TR[1-1]:TRAC[1-4]:ALLM:SEAR:DOM:X           |
| <b>Search Range (Y)</b>             | Sets/reads marker search range (Y-axis)                       | :CALC:TR[1-1]:TRAC[1-4]:ALLM:SEAR:DOM:Y           |
| <b>Target</b>                       |                                                               |                                                   |
| <b>Search Left</b>                  | Execute marker target search left                             | :CALC:TR[1-1]:TRAC[1-4]:MARK[1-10]:SEAR:EXEC:LTAR |
| <b>Search Right</b>                 | Execute marker target search right                            | :CALC:TR[1-1]:TRAC[1-4]:MARK[1-10]:SEAR:EXEC:RTAR |
| <b>Search Target</b>                | Execute marker target search                                  | :CALC:TR[1-1]:TRAC[1-4]:MARK[1-10]:SEAR:EXEC:TARG |
| <b>Target Transition</b>            | Sets/reads the target transition definition                   | :CALC:TR[1-1]:TRAC[1-4]:MARK[1-10]:SEAR:TARG:TRAN |
| <b>Target Value</b>                 | Sets/reads the marker target value                            | :CALC:TR[1-1]:TRAC[1-4]:MARK[1-10]:SEAR:TARG:Y    |
| <b>Tracking</b>                     | Sets/reads the marker tracking type                           | :CALC:TR[1-1]:TRAC[1-4]:MARK[1-10]:SEAR:TRAC:TYPE |
| <b>Marker To</b>                    |                                                               |                                                   |
| <b>Marker -&gt; Phase Reference</b> | phase reference frequency                                     | :SENS:TR[1-1]:NARR:FREQ:PREF                      |
| <b>Marker -&gt; Target Freq</b>     | target frequency                                              | :SENS:TR[1-1]:NARR:FREQ:TARG                      |
| <b>Measurement View</b>             |                                                               |                                                   |
| <b>Freq &amp; Power</b>             | Selects frequency, power and DC current measurement window    | :DISP:WIND:ACT                                    |
| <b>Phase Noise</b>                  | Selects phase noise measurement window                        | :DISP:WIND:ACT                                    |
| <b>Show Window</b>                  |                                                               |                                                   |
| <b>Freq &amp; Power</b>             | Turns on/off frequency, power and DC current measurement mode | :DISP:FP[1-1]:STAT                                |
| <b>Phase Noise</b>                  | Turns on/off phase noise measurement mode                     | :DISP:PN[1-1]:STAT                                |
| <b>Spectrum Monitor</b>             | Turns on/off spectrum monitor mode                            | :DISP:SP[1-1]:STAT                                |
| <b>Transient</b>                    | Turns on/off transient measurement mode                       | :DISP:TR[1-1]:STAT                                |
| <b>User</b>                         | Turns on/off user defined window                              | :DISP:USER[1-1]:STAT                              |
| <b>Spectrum Monitor</b>             | Selects spectrum monitor mode                                 | :DISP:WIND:ACT                                    |
| <b>Transient</b>                    | Selects transient measurement mode                            | :DISP:WIND:ACT                                    |
| <b>User</b>                         | Selects user defined window                                   | :DISP:WIND:ACT                                    |

**Table D-4 TR Menu**

| Key Operation             | Function                                                         | SCPI Command                          |
|---------------------------|------------------------------------------------------------------|---------------------------------------|
| <b>Preset</b>             |                                                                  |                                       |
| <b>Factory</b>            | Preset instrument to the initial setup state                     | :SYST:PRES                            |
| <b>User</b>               | Preset instrument and recalls the Autorec.sta in the F drive     |                                       |
| <b>Save/Recall</b>        |                                                                  |                                       |
| <b>Explorer...</b>        | Open windows explorer                                            |                                       |
| <b>Recall by filename</b> | Recalls state file by file name                                  | :MMEM:LOAD:STAT                       |
| <b>Recall State</b>       |                                                                  |                                       |
| <b>Autorec</b>            | Recalls settings                                                 | :MMEM:LOAD:STAT                       |
| <b>File Dialog...</b>     | Open file dialog                                                 |                                       |
| <b>State01</b>            | Recalls state file from register 1                               | :MMEM:LOAD:STAT                       |
| <b>State02</b>            | Recalls state file from register 2                               | :MMEM:LOAD:STAT                       |
| <b>State03</b>            | Recalls state file from register 3                               | :MMEM:LOAD:STAT                       |
| <b>State04</b>            | Recalls state file from register 4                               | :MMEM:LOAD:STAT                       |
| <b>State05</b>            | Recalls state file from register 5                               | :MMEM:LOAD:STAT                       |
| <b>State06</b>            | Recalls state file from register 6                               | :MMEM:LOAD:STAT                       |
| <b>Save Data Trace</b>    | Saves trace data                                                 | :MMEM:TR[1-1]:TRAC[1-4]:STOR[:DATA]   |
| <b>Save Memory Trace</b>  | Saves memory trace data                                          | :MMEM:TR[1-1]:TRAC[1-4]:STOR:MEM      |
| <b>Save State</b>         |                                                                  |                                       |
| <b>Autorec</b>            | Save settings                                                    | :MMEM:STOR:STAT                       |
| <b>File Dialog...</b>     | Open file dialog                                                 |                                       |
| <b>Save Type</b>          | Selects instrument state type (Entire or instrument state only)  | :MMEM:STOR:STYP                       |
| <b>State01</b>            | Save state file to register 1                                    | :MMEM:STOR:STAT                       |
| <b>State02</b>            | Save state file to register 2                                    | :MMEM:STOR:STAT                       |
| <b>State03</b>            | Save state file to register 3                                    | :MMEM:STOR:STAT                       |
| <b>State04</b>            | Save state file to register 4                                    | :MMEM:STOR:STAT                       |
| <b>State05</b>            | Save state file to register 5                                    | :MMEM:STOR:STAT                       |
| <b>State06</b>            | Save state file to register 6                                    | :MMEM:STOR:STAT                       |
| <b>Scale</b>              |                                                                  |                                       |
| <b>Auto Scale</b>         | Execute autoscale                                                | :DISP:TR[1-1]:TRAC[1-4]:Y[:SCAL]:AUTO |
| <b>Auto Scale All</b>     | Execute autoscale for all traces on transient measurement window | :DISP:TR[1-1]:ALLT:Y:SCAL:AUTO        |
| <b>Divisions</b>          | Sets/reads Y-scale divisions                                     | :DISP:TR[1-1]:Y[:SCAL]:DIV            |



**Table D-4 TR Menu**

| Key Operation                       | Function                                                                       | SCPI Command                                                                |
|-------------------------------------|--------------------------------------------------------------------------------|-----------------------------------------------------------------------------|
| <b>Marker -&gt; Reference</b>       | Sets the marker value to the reference level                                   | :DISP:TR[1-1]:TRAC[1-4]:Y[:SCAL]:RLEV                                       |
| <b>Reference Position</b>           | Sets/reads reference position                                                  | :DISP:TR[1-1]:TRAC[1-4]:Y[:SCAL]:RPOS                                       |
| <b>Reference Value</b>              | Sets/reads reference level value                                               | :DISP:TR[1-1]:TRAC[1-4]:Y[:SCAL]:RLEV                                       |
| <b>Scale/Div</b>                    | Sets/reads scale per division                                                  | :DISP:TR[1-1]:TRAC[1-4]:Y[:SCAL]:PDIV                                       |
| <b>Trigger Freq -&gt; Reference</b> | Sets the trigger frequency to the reference level                              | :DISP:TR[1-1]:TRAC[1-4]:Y[:SCAL]:RLEV                                       |
| <b>X Axis</b>                       |                                                                                |                                                                             |
| <b>Auto</b>                         | Sets/Reads automatic setting of the X-axis display range to the stimulus value | :DISP:TR[1-1]:TRAC[1-4]:X:SCAL:AUTO                                         |
| <b>Band Marker -&gt; X Axis</b>     | Sets the X-axis band marker range to the X-axis display range of a graph       | :DISP:TR[1-1]:TRAC[1-4]:X:SCAL:LEFT<br>:DISP:TR[1-1]:TRAC[1-4]:X:SCAL:RIGHT |
| <b>Left</b>                         | Sets/Reads the start value of the X-axis display range                         | :DISP:TR[1-1]:TRAC[1-4]:X:SCAL:LEFT                                         |
| <b>Right</b>                        | Sets/Reads the stop value of the X-axis display range                          | :DISP:TR[1-1]:TRAC[1-4]:X:SCAL:RIGHT                                        |
| <b>Setup</b>                        |                                                                                |                                                                             |
| <b>Freq Range</b>                   | Sets/reads frequency transient range (Narrowband)                              | :SENS:TR[1-1]:NARR:FREQ:RANG                                                |
| <b>Max Input Level</b>              | Sets/reads maximum input level                                                 | :SENS:TR[1-1]:POW:INP:LEV:MAX                                               |
| <b>Phase Reference</b>              | Sets/reads phase reference frequency                                           | :SENS:TR[1-1]:NARR:FREQ:REF                                                 |
| <b>Recalc Phase Reference</b>       |                                                                                |                                                                             |
| <b>Phase Ref. Offset</b>            | Sets/reads the offset value of the phase reference frequency                   | :CALC:TR[1-1]:TRAC[1-4]:FORM:PHAS:PREF:OFFS                                 |
| <b>Target Freq</b>                  | Sets/reads target frequency                                                    | :SENS:TR[1-1]:NARR:FREQ:TARG                                                |
| <b>Video Trigger</b>                |                                                                                |                                                                             |
| <b>Minimum Power Level</b>          | Sets/reads video trigger threshold level relative to max input level           | :TRIG:TR[1-1]:NARR:VID:THR                                                  |
| <b>Narrow Freq</b>                  | Sets/reads video trigger frequency value (Narrowband)                          | :TRIG:TR[1-1]:NARR:VID:FREQ:CENT                                            |
| <b>Wide Freq</b>                    | Sets/reads video trigger frequency value (Wideband)                            | :TRIG:TR[1-1]:WIDE:VID:FREQ:CENT                                            |

**Table D-4 TR Menu**

| Key Operation                        | Function                                                         | SCPI Command                       |
|--------------------------------------|------------------------------------------------------------------|------------------------------------|
| <b>Wide Freq Range</b>               | Set/reads transient frequency range (Wideband)                   | :SENS:TR[1-1]:WIDE:FREQ:MAX        |
| <b>Wide Max Frequency</b>            | Set/get transient frequency range in the wideband mode           | :SENS:TR[1-1]:WIDE:FREQ:MAX        |
| <b>Span</b>                          |                                                                  |                                    |
| <b>Narrow Ref Position</b>           | Sets/reads reference position for time span                      | :SENS:TR[1-1]:NARR:TIME:REF        |
| <b>Narrow Settings -&gt; Wide</b>    | Sets narrowband mode settings to wideband mode settings          |                                    |
| <b>Narrow Span</b>                   | Sets/reads time span (Narrowband)                                | :SENS:TR[1-1]:NARR:TIME:SPAN       |
| <b>Narrow Time Offset</b>            | Sets/reads time offset(delay) relative to the reference point    | :SENS:TR[1-1]:NARR:TIME:OFFS       |
| <b>Wide Ref Position</b>             | Sets/reads reference position                                    | :SENS:TR[1-1]:WIDE:TIME:REF        |
| <b>Wide Settings -&gt; Narrow</b>    | Sets wideband mode settings to narrowband mode settings          |                                    |
| <b>Wide Span</b>                     | Sets/reads time span (Wideband)                                  | :SENS:TR[1-1]:WIDE:TIME:SPAN       |
| <b>Wide Time Offset</b>              | Sets/reads time offset(delay) relative to the reference point    | :SENS:TR[1-1]:WIDE:TIME:OFFS       |
| <b>System</b>                        |                                                                  |                                    |
| <b>Abort Printing</b>                | Aborts printing                                                  | :HCOP:ABOR                         |
| <b>Backlight</b>                     | Turns on/off backlight                                           | :SYST:BACK:STAT                    |
| <b>Dump Screen Image</b>             | Save screen image                                                | :MMEM:STOR:IMAG                    |
| <b>Instrument Setup</b>              |                                                                  |                                    |
| <b>Correction</b>                    |                                                                  |                                    |
| <b>File Dialog ...</b>               | Loads correction data for a specified power                      | :MMEM:LOAD:CORR:POW                |
| <b>Import Power Correction Table</b> | Loads correction data for a specified power                      | :MMEM:LOAD:CORR:POW                |
| <b>Power Correction</b>              | Sets user the user calibration on or off or reads its setting    | :SENS:CORR:POW:STAT                |
| <b>Downconverter Manual Setup</b>    |                                                                  |                                    |
| <b>Current</b>                       | Sets/reads the bias current to be supplied to the external mixer | :SENS:DCON:MAN:MEXT[1-2]:BIAS:CURR |
| <b>IF Gain 1</b>                     | Sets/reads the IF gain of the external mixer                     | :SENS:DCON:MAN:IFG[1-2]            |
| <b>IF Gain 2</b>                     |                                                                  |                                    |

**Table D-4 TR Menu**

| Key Operation                     | Function                                                                              | SCPI Command                       |
|-----------------------------------|---------------------------------------------------------------------------------------|------------------------------------|
| LO1 Frequency                     | Sets/reads the LO frequency of the external mixer                                     | :SENS:DCON:MAN:LO[1-2]:FREQ        |
| LO2 Frequency                     |                                                                                       |                                    |
| LO1 Level                         | Sets/reads the LO level of the external mixer                                         | :SENS:DCON:MAN:LO[1-2]:LEVEL       |
| LO2 Level                         |                                                                                       |                                    |
| Mixer 1 Bias                      | Sets the bias current supplied to the external mixer on or off and reads its settings | :SENS:DCON:MAN:MEXT[1-2]:BIAS:STAT |
| Mixer 2 Bias                      |                                                                                       |                                    |
| $\Delta F = IF2 - IF1$            | Sets/reads the differential frequency between CH1 and CH2 from the external mixer     | :SENS:DCON:MAN:IFD                 |
| Frequency Offset (User Downconv.) |                                                                                       |                                    |
| Conversion Mode                   | Sets/reads the conversion mode of the frequency offset                                | :SENS:UDC:MODE                     |
| Frequency Offset                  | Sets/reads the frequency offset                                                       | :SENS:UDC:STAT                     |
| Harmonic #                        | Sets/reads the frequency offset factor                                                | :SENS:UDC:HARM                     |
| LO Frequency                      | Sets/reads the LO frequency of the frequency offset                                   | :SENS:UDC:LO                       |
| Invert Image                      | Selects print mode                                                                    | :HCOP:IMAG                         |
| Misc Setup                        |                                                                                       |                                    |
| Beeper                            |                                                                                       |                                    |
| Beep Complete                     | Turns on/off the beep for operation completion                                        | :SYST:BEEP:COMP:STAT               |
| Beep Warning                      | Turns on/off the beep for warning                                                     | :SYST:BEEP:WARN:STAT               |
| Test Beep Complete                | Makes beep sound for operation completion                                             | :SYST:BEEP:COMP:IMM                |
| Test Beep Warning                 | Makes beep sound for warning                                                          | :SYST:BEEP:WARN:IMM                |
| Clock Setup                       |                                                                                       |                                    |
| Set Date and Time                 | Set/reads system time<br>Set/reads system date                                        | :SYST:TIME<br>:SYST:DATE           |
| Show Clock                        | Turns on/off internal clock display                                                   | :DISP:CLOC                         |
| Color Setup                       |                                                                                       |                                    |
| Invert                            | Sets each color when the inverted display is selected                                 |                                    |
| Background                        | Sets/Reads the background color                                                       | :DISP:COL2:BACK[:VAL]              |
| Data Trace 1                      | Sets/Reads the color of the data trace of trace 1                                     | :DISP:COL2:TRAC1:DATA[:VAL]        |

Table D-4 TR Menu

| Key Operation         | Function                                                       | SCPI Command                |
|-----------------------|----------------------------------------------------------------|-----------------------------|
| :                     |                                                                |                             |
| :                     |                                                                |                             |
| <b>Data Trace 8</b>   | Sets/Reads the color of the data trace of trace 8              | :DISP:COL2:TRAC8:DATA[:VAL] |
| <b>Graticule Main</b> | Sets/Reads the color of the graph                              | :DISP:COL2:GRAT1[:VAL]      |
| <b>Graticule Sub</b>  | Sets/Reads the color of the grid lines in the graph            | :DISP:COL2:GRAT2[:VAL]      |
| <b>Limit Fail</b>     | Sets/Reads the limit display color                             | :DISP:COL2:LIM1[:VAL]       |
| <b>Limit Line</b>     | Sets/Reads the color of the limit line                         | :DISP:COL2:LIM2[:VAL]       |
| <b>Mem Trace 1</b>    | Sets/Reads the color of the memory trace of trace 1            | :DISP:COL2:TRAC1:MEM[:VAL]  |
| :                     |                                                                |                             |
| :                     |                                                                |                             |
| <b>Mem Trace 8</b>    | Sets/Reads the color of the memory trace of trace 8            | :DISP:COL2:TRAC8:MEM[:VAL]  |
| <b>Reset Color</b>    | Resets the display color to the factory preset default setting | :DISP:COL2:RES              |
| <b>Normal</b>         | Sets each color when the normal display is selected            |                             |
| <b>Background</b>     | Sets/Reads the background color                                | :DISP:COL1:BACK[:VAL]       |
| <b>Data Trace 1</b>   | Sets/Reads the color of the data trace of trace 1              | :DISP:COL1:TRAC1:DATA[:VAL] |
| :                     |                                                                |                             |
| :                     |                                                                |                             |
| <b>Data Trace 8</b>   | Sets/Reads the color of the data trace of trace 8              | :DISP:COL1:TRAC8:DATA[:VAL] |
| <b>Graticule Main</b> | Sets/Reads the color of the graph                              | :DISP:COL1:GRAT1[:VAL]      |
| <b>Graticule Sub</b>  | Sets/Reads the color of the grid lines in the graph            | :DISP:COL1:GRAT2[:VAL]      |
| <b>Limit Fail</b>     | Sets/Reads the limit display color                             | :DISP:COL1:LIM1[:VAL]       |
| <b>Limit Line</b>     | Sets/Reads the color of the limit line                         | :DISP:COL1:LIM2[:VAL]       |
| <b>Mem Trace 1</b>    | Sets/Reads the color of the memory trace of trace 1            | :DISP:COL1:TRAC1:MEM[:VAL]  |
| :                     |                                                                |                             |
| :                     |                                                                |                             |
| <b>Mem Trace 8</b>    | Sets/Reads the color of the memory trace of trace 8            | :DISP:COL1:TRAC8:MEM[:VAL]  |
| <b>Reset Color</b>    | Resets the display color to the factory preset default setting | :DISP:COL1:RES              |

**Table D-4 TR Menu**

| Key Operation                          | Function                                                                                               | SCPI Command    |
|----------------------------------------|--------------------------------------------------------------------------------------------------------|-----------------|
| <b>Control Panel ...</b>               | Open control panel                                                                                     |                 |
| <b>GPIB Setup</b>                      |                                                                                                        |                 |
| <b>System Controller Configuration</b> | Turns on/off system controller mode                                                                    |                 |
| <b>Talker/Listener Address</b>         | Sets the address for controlling the analyzer from a controller via GPIB                               |                 |
| <b>Key Lock</b>                        |                                                                                                        |                 |
| <b>Front Panel &amp; Keyboard Lock</b> | Disables from panel / keyboard operations                                                              | :SYST:KLOC:KBD  |
| <b>Touch Screen &amp; Mouse Lock</b>   | Disables touch screen / mouse operations                                                               | :SYST:KLOC:MOUS |
| <b>Network Setup</b>                   |                                                                                                        |                 |
| <b>MAC Address</b>                     | Sets MAC address                                                                                       |                 |
| <b>Network Configuration ...</b>       | Enables/disables network connections                                                                   |                 |
| <b>Network Identification ...</b>      | Sets network ID of the instrument                                                                      |                 |
| <b>SICL-LAN Address</b>                | Sets SICL-LAN address                                                                                  |                 |
| <b>SICL-LAN Server</b>                 | Enables/disables SICL-LAN server                                                                       |                 |
| <b>Socket Server</b>                   | Enables/disables Socket server                                                                         |                 |
| <b>Telnet Server</b>                   | Enables/disables Telnet server                                                                         |                 |
| <b>Print</b>                           | Outputs print                                                                                          | :HCOP:IMM       |
| <b>Printer Setup ...</b>               | Execute printer setup                                                                                  |                 |
| <b>Product Information</b>             | Reads product information                                                                              |                 |
| <b>Service Menu</b>                    |                                                                                                        |                 |
| <b>Administrator Menu</b>              | Displays softkeys associated with Administrator Menu. This function is not available to general users. |                 |
| <b>Error Log</b>                       |                                                                                                        |                 |
| <b>Clear Error Log</b>                 | Clears the error log                                                                                   |                 |
| <b>View Error Log ...</b>              | Displays the error log                                                                                 |                 |

**Table D-4 TR Menu**

| Key Operation                     | Function                                                                                         | SCPI Command                      |
|-----------------------------------|--------------------------------------------------------------------------------------------------|-----------------------------------|
| <b>Install Option License</b>     |                                                                                                  |                                   |
| <b>Jitter</b>                     | Enters the license for clock jitter analysis                                                     |                                   |
| <b>Service Function</b>           | Displays softkeys associated with Service Menu. This function is not available to general users. |                                   |
| <b>Test Menu</b>                  |                                                                                                  |                                   |
| <b>Power On Test</b>              | Performs internal test                                                                           |                                   |
| <b>Display Test</b>               | Performs display test                                                                            |                                   |
| <b>Front Panel</b>                | Performs front panel key (hard key) test                                                         |                                   |
| <b>Adjust Touch Screen</b>        | Performs touch screen calibration                                                                |                                   |
| <b>E5053A Test</b>                | Displays the connection status of E5053A                                                         |                                   |
| <b>Time Offset</b>                |                                                                                                  |                                   |
| <b>Narrow Ref Position</b>        | Sets/reads reference position for time span (Narrowband mode)                                    | :SENS:TR[1-1]:NARR:TIME:REF       |
| <b>Narrow Settings -&gt; Wide</b> | Sets narrowband mode settings to wideband mode settings                                          |                                   |
| <b>Narrow Span</b>                | Sets/reads time span (Narrowband mode)                                                           | :SENS:TR[1-1]:NARR:TIME:SPAN      |
| <b>Narrow Time Offset</b>         | Sets/reads time offset(delay) relative to the reference point                                    | :SENS:TR[1-1]:NARR:TIME:OFFS      |
| <b>Wide Ref Position</b>          | Sets/reads reference position for time span (Wideband mode)                                      | :SENS:TR[1-1]:WIDE:TIME:REF       |
| <b>Wide Settings -&gt; Narrow</b> | Sets wideband mode settings to narrowband mode settings                                          |                                   |
| <b>Wide Span</b>                  | Sets/reads time span (Wideband mode)                                                             | :SENS:TR[1-1]:WIDE:TIME:SPAN      |
| <b>Wide Time Offset</b>           | Sets/reads time offset(delay) relative to the reference point                                    | :SENS:TR[1-1]:WIDE:TIME:OFFS      |
| <b>Trace View</b>                 |                                                                                                  |                                   |
| <b>Aperture</b>                   | Sets/reads smoothing aperture value                                                              | :CALC:TR[1-1]:TRAC[1-4]:SMO:APER  |
| <b>Copy to User</b>               | Copies trace data to the user trace                                                              | :CALC:TR[1-1]:TRAC[1-4]:DATA:COPY |
| <b>Data -&gt; Mem</b>             | Copy data to memory                                                                              | :CALC:TR[1-1]:TRAC[1-4]:MATH:MEM  |
| <b>Data Hold</b>                  | Data hold                                                                                        | :CALC:TR[1-1]:TRAC[1-4]:HOLD      |
| <b>Data Math</b>                  | Sets/reads math operation type                                                                   | :CALC:TR[1-1]:TRAC[1-4]:MATH:FUNC |

**Table D-4 TR Menu**

| Key Operation                | Function                                                                                           | SCPI Command                                                                                                |
|------------------------------|----------------------------------------------------------------------------------------------------|-------------------------------------------------------------------------------------------------------------|
| <b>Display Trace</b>         | Shows data and/or memory trace                                                                     | :DISP:TR[1-1]:TRAC[1-4]:MODE                                                                                |
| <b>Marker -&gt; -Offset</b>  | Sets sign-inverted data value of the data trace's active marker to the offset value                | :CALC:TR[1-1]:TRAC[1-4]:MATH:OFFS                                                                           |
| <b>Memory Trace</b>          |                                                                                                    |                                                                                                             |
| <b>Line (Y = AX + B)</b>     |                                                                                                    |                                                                                                             |
| <b>A</b>                     | Sets/Reads regression line coefficient a (slope)                                                   | :CALC:TR[1-1]:TRAC[1-4]:LINE:A                                                                              |
| <b>B</b>                     | Sets/Reads regression line coefficient b (intercept)                                               | :CALC:TR[1-1]:TRAC[1-4]:LINE:B                                                                              |
| <b>Data Trace -&gt; A, B</b> | Assigns the measurement results to regression line coefficients (a, b)                             | :CALC:TR[1-1]:TRAC[1-4]:FUNC:LREG:DATA?<br>:CALC:TR[1-1]:TRAC[1-4]:LINE:A<br>:CALC:TR[1-1]:TRAC[1-4]:LINE:B |
| <b>Set Line to Memory</b>    | Sets the obtained regression line to the memory trace                                              | :CALC:TR[1-1]:TRAC[1-4]:LINE:MEM                                                                            |
| <b>Offset</b>                | Sets/Reads the offset value of the data trace                                                      | :CALC:TR[1-1]:TRAC[1-4]:MATH:OFFS                                                                           |
| <b>Persistence</b>           |                                                                                                    |                                                                                                             |
| <b>Clear Persistent Data</b> | Clears persistent mode                                                                             | :DISP:TR[1-1]:TRAC[1-4]:PERSIST:CLE                                                                         |
| <b>Persistence Mode</b>      | Sets/reads persistent mode                                                                         | :DISP:TR[1-1]:TRAC[1-4]:PERSIST:STAT                                                                        |
| <b>Smoothing</b>             | Turn on/off smoothing function                                                                     | :CALC:TR[1-1]:TRAC[1-4]:SMO:STAT                                                                            |
| <b>Trace Label</b>           | Edit trace title label                                                                             | :DISP:TR[1-1]:TRAC[1-4]:LAB:DATA                                                                            |
| <b>Trigger</b>               |                                                                                                    |                                                                                                             |
| <b>Average Trigger</b>       | Sets/Reads the averaging trigger function                                                          | :TRIG:AVER                                                                                                  |
| <b>Continuous</b>            | Sets/reads trigger continuous mode                                                                 | :INIT:TR[1-1]:CONT<br>:INIT:TR[1-1]:IMM                                                                     |
| <b>Ext Trig Adj.</b>         | Sets/Reads the offset of the waiting time for external trigger                                     | :TRIG:TR[1-1]:ETTA                                                                                          |
| <b>Ext Trig Polarity</b>     | External trigger polarity                                                                          | :TRIG:EXT:SLOP                                                                                              |
| <b>Hold</b>                  | Sets trigger mode to waiting-for-trigger state                                                     | :INIT:TR[1-1]:IMM                                                                                           |
| <b>Manual Trigger</b>        | move once to waiting-for-trigger state                                                             | :INIT:TR[1-1]:IMM                                                                                           |
| <b>Restart</b>               | move once to waiting-for-trigger state                                                             | :INIT:TR[1-1]:IMM                                                                                           |
| <b>Single</b>                | always move to waiting-for-trigger state after measuring<br>move once to waiting-for-trigger state | :INIT:TR[1-1]:CONT<br>:INIT:TR[1-1]:IMM                                                                     |

Softkey Functions  
TR Menu

**Table D-4 TR Menu**

| Key Operation        | Function                | SCPI Command       |
|----------------------|-------------------------|--------------------|
| Source               | trigger source          | :TRIG:TR[1-1]:SOUR |
| Trigger to Transient | select measurement mode | :TRIG:MODE         |



## User Defined Menu (Top Menu)

| Key Operation                                  | Function                                                                                                             |
|------------------------------------------------|----------------------------------------------------------------------------------------------------------------------|
| <b>Double-click on each softkey menu title</b> | Displays the top menu of each menu item below. Refer the USER menu about detail of following each menu item.         |
| <b>Measurement View</b>                        | Same as <b>Meas</b> .                                                                                                |
| <b>Input</b>                                   | Same as <b>Scale</b> .                                                                                               |
| <b>Scale</b>                                   | Same as <b>Scale</b> .                                                                                               |
| <b>Format</b>                                  | Same as <b>Format</b> .                                                                                              |
| <b>Display</b>                                 | Same as <b>Display</b> .                                                                                             |
| <b>Average</b>                                 | Same as <b>Avg</b> .                                                                                                 |
| <b>Attenuator</b>                              | Same as <b>Cal</b> .                                                                                                 |
| <b>Start/Center</b>                            | Displays the same softkey for setting up the sweep range that appears when <b>Start</b> , or <b>Span</b> is pressed. |
| <b>Stop/Span</b>                               | Displays the same softkey for setting up the sweep range that appears when <b>Start</b> , or <b>Span</b> is pressed. |
| <b>DC Conrol Voltage</b>                       | Same as <b>Sweep Setup</b> .                                                                                         |
| <b>DC Power Voltage</b>                        | Same as <b>Sweep Setup</b> .                                                                                         |
| <b>Setup</b>                                   | Same as <b>Sweep Setup</b> .                                                                                         |
| <b>Trigger</b>                                 | Same as <b>Trigger</b> .                                                                                             |
| <b>Marker</b>                                  | Same as <b>Marker</b> .                                                                                              |
| <b>Marker Search</b>                           | Same as <b>Marker Search</b> .                                                                                       |
| <b>Marker To</b>                               | Same as <b>Marker Search</b> .                                                                                       |
| <b>Marker Function</b>                         | Same as <b>Marker Fctn</b> .                                                                                         |
| <b>Macro Setup</b>                             | Same as <b>Macro Setup</b> .                                                                                         |
| <b>Save/Recall</b>                             | Same as <b>Save/Recall</b> .                                                                                         |
| <b>System</b>                                  | Same as <b>System</b> .                                                                                              |
| <b>Preset</b>                                  | Same as <b>Preset</b> .                                                                                              |

## USER Menu

**Table D-5 User Menu**

| Key Operation                      | Function                                                                                       | SCPI Command                                              |
|------------------------------------|------------------------------------------------------------------------------------------------|-----------------------------------------------------------|
| <b>Attenuator</b>                  |                                                                                                |                                                           |
| <b>Input Attenuator</b>            | Sets/reads Input Attenuator level on 5dB Step                                                  | :SENS:ATT:LEV                                             |
| <b>DC Control Voltage</b>          |                                                                                                |                                                           |
| <b>Auto Freq Control</b>           |                                                                                                |                                                           |
| <b>AFC Status</b>                  | Turns on/off the auto frequency control function.<br>Executes the auto frequency control once. | :SOUR:VOLT:CONT:AFC[:STAT<br>]<br>:SOUR:VOLT:CONT:AFC:IMM |
| <b>Frequency Band</b>              | Sets/reads the frequency band in the auto frequency control function                           | :SOUR:VOLT:CONT:AFC:FBAN                                  |
| <b>Max Ctrl Voltage Limit</b>      | Sets/reads the maximum DC control voltage limit                                                | :SOUR:VOLT:CONT:AFC:LIM:<br>HIGH                          |
| <b>Max Input Level</b>             | Sets/reads the maximum input level                                                             | :SOUR:VOLT:CONT:AFC:INP:L<br>EV:MAX                       |
| <b>Max Iteration</b>               | Sets/reads the maximum number of iterations for the DC control voltage-setting loops           | :SOUR:VOLT:CONT:AFC:ITER                                  |
| <b>Min Ctrl Voltage Limit</b>      | Sets/reads the minimum DC control voltage limit                                                | :SOUR:VOLT:CONT:AFC:LIM:<br>LOW                           |
| <b>Sensitivity</b>                 | Sets/reads the tuning sensitivity                                                              | :SOUR:VOLT:CONT:AFC:SENS                                  |
| <b>Target</b>                      | Sets/reads the target frequency in the auto frequency control function                         | :SOUR:VOLT:CONT:AFC:TARG                                  |
| <b>Tolerance</b>                   | Sets/reads the tolerance limit                                                                 | :SOUR:VOLT:CONT:AFC:TOL                                   |
| <b>Control Voltage Cal</b>         | Enables DC Control voltage calibration                                                         | :SOUR:VOLT:CONT:CORR[:ST<br>AT]                           |
| <b>DC Control Delay</b>            | Sets/reads DC Control delay (sec)                                                              | :SOUR:VOLT:CONT:DEL                                       |
| <b>DC Control Output</b>           | Turns on/off DC Control voltage                                                                | :SOUR:VOLT:CONT:LEV:STAT                                  |
| <b>DC Control Voltage</b>          | Sets/reads DC Control voltage                                                                  | :SOUR:VOLT:CONT:LEV:AMP<br>L                              |
| <b>Execute Control Voltage Cal</b> | Execute DC Control voltage calibration                                                         | :SOUR:VOLT:CONT:CORR:CO<br>LL:ACQ                         |
| <b>Max Ctrl Voltage Limit</b>      | Sets/reads the maximum DC Control voltage limit                                                | :SOUR:VOLT:CONT:LIM:HIGH                                  |
| <b>Min Ctrl Voltage Limit</b>      | Sets/reads the minimum DC Control voltage limit                                                | :SOUR:VOLT:CONT:LIM:LOW                                   |
| <b>DC Power Voltage</b>            |                                                                                                |                                                           |
| <b>DC Power Delay</b>              | Sets/reads DC Power delay (sec)                                                                | :SOUR:VOLT:POW:DEL                                        |
| <b>DC Power Output</b>             | Turns on/off DC Power voltage                                                                  | :SOUR:VOLT:POW:LEV:STAT                                   |
| <b>DC Power Voltage</b>            | Sets/reads DC Power voltage                                                                    | :SOUR:VOLT:POW:LEV:AMPL                                   |

**Table D-5 User Menu**

| Key Operation                      | Function                                                            | SCPI Command                               |
|------------------------------------|---------------------------------------------------------------------|--------------------------------------------|
| <b>Max Pwr Voltage Limit</b>       | Sets/reads the maximum DC Power voltage limit                       | :SOUR:VOLT:POW:LIM:HIGH                    |
| <b>Min Pwr Voltage Limit</b>       | Sets/reads the minimum DC Power voltage limit                       | :SOUR:VOLT:POW:LIM:LOW                     |
| <b>Display</b>                     |                                                                     |                                            |
| <b>Edit Title Label</b>            | Edit the measurement window title label                             | :DISP:USER[1-1]:LAB:DATA                   |
| <b>Color Type</b>                  | Sets/Reads the display type of the display (normal/inverted)        | :DISP:IMAG                                 |
| <b>Limit Test</b>                  |                                                                     |                                            |
| <b>Delete Lower Limit Line</b>     | Clears the lower limit line                                         | :CALC:USER[1-1]:TRAC[1-8]:LIM:LOW:SEGM:CLE |
| <b>Delete Upper Limit Line</b>     | Clears the upper limit line                                         | :CALC:USER[1-1]:TRAC[1-8]:LIM:UPP:SEGM:CLE |
| <b>Explorer</b>                    |                                                                     |                                            |
| <b>Fail Sign</b>                   | Turns on/off the limit test judgement display                       | :DISP:USER[1-1]:LIM:FSIG                   |
| <b>Import Lower Limit Line ...</b> | Reads the lower limit line                                          | :MMEM:USER[1-1]:TRAC[1-8]:LOAD:LIM:LOW     |
| <b>Import Upper Limit Line ...</b> | Reads the upper limit line                                          | :MMEM:USER[1-1]:TRAC[1-8]:LOAD:LIM:UPP     |
| <b>Limit Line</b>                  | Turns on/off the limit line                                         | :DISP:USER[1-1]:TRAC[1-8]:LIM:LINE         |
| <b>Limit Test</b>                  | Turns on/off the limit test function                                | :CALC:USER[1-1]:TRAC[1-8]:LIM[:STAT]       |
| <b>Marker Information</b>          | Sets/reads the marker information position                          | :DISP:USER[1-1]:ANN:MARK:POS               |
| <b>Meas Condition</b>              | Turns on/off measurement conditions                                 | :DISP:USER[1-1]:ANN:MEAS:STAT              |
| <b>Relative Y-Scale</b>            | Turns on/off relative Y-scale                                       | :DISP:USER[1-1]:GRAT:AXIS:Y:REL            |
| <b>Security Level</b>              | Sets/recalls the security level                                     | :SYST:SEC[:LEV]                            |
| <b>Title Label</b>                 | Turns on/off the measurement window title label                     | :DISP:USER[1-1]:LAB:STAT                   |
| <b>Update</b>                      | Turns on/off the trace updates                                      | :DISP:ENAB                                 |
| <b>Y # of Digits</b>               | Selects the number of digits (Y-axis)                               | :DISP:USER[1-1]:GRAT:AXIS:Y:STAT           |
| <b>Input Port</b>                  |                                                                     |                                            |
| <b>Downconverter</b>               |                                                                     |                                            |
| <b>Downconverter</b>               | Sets the use of the downconverter on or off, or reads its setting   | :SENS:DCON[:STAT]                          |
| <b>RF Input</b>                    | Sets/reads the signal supplied to the RF input port                 | :SENS:DCON:INP                             |
| <b>External Mixer</b>              | Sets the use of the external mixer on or off and reads its settings | :SENS:DCON:MEXT                            |

**Table D-5 User Menu**

| Key Operation            | Function                                                  | SCPI Command                                  |
|--------------------------|-----------------------------------------------------------|-----------------------------------------------|
| <b>Macro Setup</b>       |                                                           |                                               |
| <b>Application</b>       |                                                           |                                               |
| <b>Jitter</b>            | Executes clock jitter analysis (VBA)                      |                                               |
| <b>mmWave</b>            | Executes phase-noise measurement (VBA)                    |                                               |
| <b>E5052 Event</b>       | Turns on/off the E5052 VBA event callback function        | :PROG:COM:EVEN                                |
| <b>Echo Window Menu</b>  |                                                           |                                               |
| <b>Clear Echo</b>        | Clears Echo window                                        | :DISP:ECHO:CLE                                |
| <b>Echo Font Size</b>    | Sets/reads the font size on Echo window                   | :DISP:ECHO:FSIZ                               |
| <b>Echo Window</b>       | Turn on/off the Echo window                               | :DISP:ECHO:STAT                               |
| <b>Load &amp; Run</b>    | Load and execute the macro selected on file names.        |                                               |
| <b>Select Macro</b>      | Sets/reads the name of the program to be selected         | :PROG:SEL:NAME                                |
| <b>Stop</b>              | Sets/reads the state of the selected program              | :PROG:SEL:STAT                                |
| <b>User Menu</b>         |                                                           |                                               |
| <b>User Label 1</b>      | Execute the macro assigned under the user defined softkey | :PROG:SKEY:ITEM[1-8]:IMM                      |
| <b>User Label 2</b>      | Execute the macro assigned under the user defined softkey | :PROG:SKEY:ITEM[1-8]:IMM                      |
| <b>User Label 3</b>      | Execute the macro assigned under the user defined softkey | :PROG:SKEY:ITEM[1-8]:IMM                      |
| <b>User Label 4</b>      | Execute the macro assigned under the user defined softkey | :PROG:SKEY:ITEM[1-8]:IMM                      |
| <b>User Label 5</b>      | Execute the macro assigned under the user defined softkey | :PROG:SKEY:ITEM[1-8]:IMM                      |
| <b>User Label 6</b>      | Execute the macro assigned under the user defined softkey | :PROG:SKEY:ITEM[1-8]:IMM                      |
| <b>User Label 7</b>      | Execute the macro assigned under the user defined softkey | :PROG:SKEY:ITEM[1-8]:IMM                      |
| <b>User Label 8</b>      | Execute the macro assigned under the user defined softkey | :PROG:SKEY:ITEM[1-8]:IMM                      |
| <b>VBA Editor Menu</b>   |                                                           |                                               |
| <b>Close Editor</b>      | Close VBA editor                                          |                                               |
| <b>Load Project</b>      | Loads program                                             | :MMEM:LOAD:PROG                               |
| <b>New Project</b>       | Open new VBA project                                      |                                               |
| <b>Open Editor</b>       | Open VBA editor                                           |                                               |
| <b>Save Project</b>      | Save VBA project                                          | :MMEM:STOR:PROG                               |
| <b>Marker</b>            |                                                           |                                               |
| <b>Clear Marker Menu</b> |                                                           |                                               |
| <b>All OFF</b>           | Clears all the markers                                    |                                               |
| <b>Marker 1</b>          | Turns on/off marker 1                                     | :CALC:USER[1-1]:TRAC[1-8]:<br>MARK[1-10]:STAT |
| :                        |                                                           |                                               |
| :                        |                                                           |                                               |

**Table D-5 User Menu**

| Key Operation             | Function                                         | SCPI Command                              |
|---------------------------|--------------------------------------------------|-------------------------------------------|
| <b>Marker 10</b>          | Turns on/off marker 10                           | :CALC:USER[1-1]:TRAC[1-8]:MARK[1-10]:STAT |
| <b>Couple</b>             | Turns on/off marker coupling function            | :CALC:USER[1-1]:ALLT:MARK:COUP:STAT       |
| <b>Marker 1</b>           | Turns on/off marker 1                            | :CALC:USER[1-1]:TRAC[1-8]:MARK[1-10]:STAT |
| :                         |                                                  |                                           |
| :                         |                                                  |                                           |
| <b>Marker 6</b>           | Turns on/off marker 6                            | :CALC:USER[1-1]:TRAC[1-8]:MARK[1-10]:STAT |
| <b>Marker List</b>        | Turns on/off the marker list                     | :DISP:USER[1-1]:TABL[:STAT]               |
| <b>More Functions</b>     |                                                  |                                           |
| <b>Discrete</b>           | Sets/reads marker movement (Continuous/Discrete) | :CALC:USER[1-1]:ALLT:MARK:DISC:STAT       |
| <b>Ref Marker</b>         | Sets/reads marker reference number               | :CALC:USER[1-1]:ALLT:MARK:REF:NUMB        |
| <b>Ref Marker Mode</b>    | Turns on/off delta marker mode                   | :CALC:USER[1-1]:ALLT:MARK:REF:STAT        |
| <b>More Markers</b>       |                                                  |                                           |
| <b>Marker 7</b>           | Turns on/off marker 7                            | :CALC:USER[1-1]:TRAC[1-8]:MARK[1-10]:STAT |
| :                         |                                                  |                                           |
| :                         |                                                  |                                           |
| <b>Marker 10</b>          | Turns on/off marker 10                           | :CALC:USER[1-1]:TRAC[1-8]:MARK[1-10]:STAT |
| <b>Marker Function</b>    |                                                  |                                           |
| <b>Analysis Range (X)</b> | Sets/reads analysis/search range (X-axis)        | :CALC:USER[1-1]:TRAC[1-8]:FUNC:DOM:X      |
| <b>Analysis Range (Y)</b> | Sets/reads analysis/search range (Y-axis)        | :CALC:USER[1-1]:TRAC[1-8]:FUNC:DOM:Y      |
| <b>Analysis Type</b>      | Sets/reads analysis type                         | :CALC:USER[1-1]:TRAC[1-8]:FUNC:TYPE       |
| <b>Band Marker X</b>      |                                                  |                                           |
| <b>Band Marker X</b>      | Turns on/off bandmarker X                        | :CALC:USER[1-1]:TRAC[1-8]:BDM:X:STAT      |
| <b>Center</b>             | Sets/reads the center value of bandmarker X      | :CALC:USER[1-1]:TRAC[1-8]:BDM:X:CENT      |
| <b>Span</b>               | Sets/reads the span value of bandmarker X        | :CALC:USER[1-1]:TRAC[1-8]:BDM:X:SPAN      |
| <b>Start</b>              | Sets/reads the start value of bandmarker X       | :CALC:USER[1-1]:TRAC[1-8]:BDM:X:STAR      |

**Table D-5 User Menu**

| Key Operation        | Function                                    | SCPI Command                         |
|----------------------|---------------------------------------------|--------------------------------------|
| <b>Stop</b>          | Sets/reads the stop value of bandmarker X   | :CALC:USER[1-1]:TRAC[1-8]:BDM:X:STOP |
| <b>Band Marker Y</b> |                                             |                                      |
| <b>Band Marker Y</b> | Turns on/off bandmarker Y                   | :CALC:USER[1-1]:TRAC[1-8]:BDM:Y:STAT |
| <b>Center</b>        | Sets/reads the center value of bandmarker Y | :CALC:USER[1-1]:TRAC[1-8]:BDM:Y:CENT |
| <b>Span</b>          | Sets/reads the span value of bandmarker Y   | :CALC:USER[1-1]:TRAC[1-8]:BDM:Y:SPAN |
| <b>Start</b>         | Sets/reads the start value of bandmarker Y  | :CALC:USER[1-1]:TRAC[1-8]:BDM:Y:STAR |
| <b>Stop</b>          | Sets/reads the stop value of bandmarker Y   | :CALC:USER[1-1]:TRAC[1-8]:BDM:Y:STOP |
| <b>Couple</b>        | Turns on/off bandmarker coupling function   | :CALC:USER[1-1]:ALLT:BDM:X:COUP:STAT |
| <b>Marker Search</b> |                                             |                                      |
| <b>Band Marker X</b> |                                             |                                      |
| <b>Band Marker X</b> | Turns on/off bandmarker X                   | :CALC:USER[1-1]:TRAC[1-8]:BDM:X:STAT |
| <b>Center</b>        | Sets/reads the center value of bandmarker X | :CALC:USER[1-1]:TRAC[1-8]:BDM:X:CENT |
| <b>Span</b>          | Sets/reads the span value of bandmarker X   | :CALC:USER[1-1]:TRAC[1-8]:BDM:X:SPAN |
| <b>Start</b>         | Sets/reads the start value of bandmarker X  | :CALC:USER[1-1]:TRAC[1-8]:BDM:X:STAR |
| <b>Stop</b>          | Sets/reads the stop value of bandmarker X   | :CALC:USER[1-1]:TRAC[1-8]:BDM:X:STOP |
| <b>Band Marker Y</b> |                                             |                                      |
| <b>Band Marker Y</b> | Turns on/off bandmarker Y                   | :CALC:USER[1-1]:TRAC[1-8]:BDM:Y:STAT |
| <b>Center</b>        | Sets/reads the center value of bandmarker Y | :CALC:USER[1-1]:TRAC[1-8]:BDM:Y:CENT |
| <b>Span</b>          | Sets/reads the span value of bandmarker Y   | :CALC:USER[1-1]:TRAC[1-8]:BDM:Y:SPAN |
| <b>Start</b>         | Sets/reads the start value of bandmarker Y  | :CALC:USER[1-1]:TRAC[1-8]:BDM:Y:STAR |
| <b>Stop</b>          | Sets/reads the stop value of bandmarker Y   | :CALC:USER[1-1]:TRAC[1-8]:BDM:Y:STOP |
| <b>Couple</b>        | Turns on/off bandmarker coupling function   | :CALC:USER[1-1]:ALLT:BDM:X:COUP:STAT |

**Table D-5 User Menu**

| Key Operation            | Function                                                   | SCPI Command                                         |
|--------------------------|------------------------------------------------------------|------------------------------------------------------|
| <b>Peak</b>              |                                                            |                                                      |
| <b>Peak Excursion</b>    | Sets/reads the peak excursion value                        | :CALC:USER[1-1]:TRAC[1-8]:MARK[1-10]:SEAR:PEAK:EXC   |
| <b>Peak Polarity</b>     | Sets/reads the marker peak-search polarity                 | :CALC:USER[1-1]:TRAC[1-8]:MARK[1-10]:SEAR:PEAK:POL   |
| <b>Search Left</b>       | Execute marker peak search left                            | :CALC:USER[1-1]:TRAC[1-8]:MARK[1-10]:SEAR:EXEC:LPE   |
| <b>Search Peak</b>       | Execute marker peak search                                 | :CALC:USER[1-1]:TRAC[1-8]:MARK[1-10]:SEAR:EXEC:PEAK  |
| <b>Search Peak All</b>   | Execute marker search all                                  | :CALC:USER[1-1]:TRAC[1-8]:ALLM:SEAR:PEAK             |
| <b>Search Right</b>      | Execute marker peak search right                           | :CALC:USER[1-1]:TRAC[1-8]:MARK[1-10]:SEAR:EXEC:RPE   |
| <b>Search Max</b>        | Execute marker search maximum                              | :CALC:USER[1-1]:TRAC[1-8]:MARK[1-10]:SEAR:EXEC:MAX   |
| <b>Search Min</b>        | Execute marker search minimum                              | :CALC:USER[1-1]:TRAC[1-8]:MARK[1-10]:SEAR:EXEC:MIN   |
| <b>Search Range (X)</b>  | Sets/reads marker search range (X-axis)                    | :CALC:USER[1-1]:TRAC[1-8]:ALLM:SEAR:DOM:X            |
| <b>Search Range (Y)</b>  | Sets/reads marker search range (Y-axis)                    | :CALC:USER[1-1]:TRAC[1-8]:ALLM:SEAR:DOM:Y            |
| <b>Target</b>            |                                                            |                                                      |
| <b>Search Left</b>       | Execute marker target search left                          | :CALC:USER[1-1]:TRAC[1-8]:MARK[1-10]:SEAR:EXEC:LTA R |
| <b>Search Right</b>      | Execute marker target search right                         | :CALC:USER[1-1]:TRAC[1-8]:MARK[1-10]:SEAR:EXEC:RTA R |
| <b>Search Target</b>     | Execute marker target search                               | :CALC:USER[1-1]:TRAC[1-8]:MARK[1-10]:SEAR:EXEC:TAR G |
| <b>Target Transition</b> | Sets/reads the target transition definition                | :CALC:USER[1-1]:TRAC[1-8]:MARK[1-10]:SEAR:TARG:TRA N |
| <b>Target Value</b>      | Sets/reads the marker target value                         | :CALC:USER[1-1]:TRAC[1-8]:MARK[1-10]:SEAR:TARG:Y     |
| <b>Tracking</b>          | Sets/reads the marker tracking type                        | :CALC:USER[1-1]:TRAC[1-8]:MARK[1-10]:SEAR:TRAC:TYP E |
| <b>Measurement View</b>  |                                                            |                                                      |
| <b>Freq &amp; Power</b>  | Selects frequency, power and DC current measurement window | :DISP:WIND:ACT                                       |
| <b>Phase Noise</b>       | Selects phase noise measurement window                     | :DISP:WIND:ACT                                       |

Table D-5 User Menu

| Key Operation             | Function                                                        | SCPI Command                          |
|---------------------------|-----------------------------------------------------------------|---------------------------------------|
| <b>Show Window</b>        |                                                                 |                                       |
| <b>Freq &amp; Power</b>   | Turns on/off frequency, power and DC current measurement mode   | :DISP:FP[1-1]:STAT                    |
| <b>Phase Noise</b>        | Turns on/off phase noise measurement mode                       | :DISP:PN[1-1]:STAT                    |
| <b>Spectrum Monitor</b>   | Turns on/off spectrum monitor mode                              | :DISP:SP[1-1]:STAT                    |
| <b>Transient</b>          | Turns on/off transient measurement mode                         | :DISP:TR[1-1]:STAT                    |
| <b>User</b>               | Turns on/off user defined window                                | :DISP:USER[1-1]:STAT                  |
| <b>Spectrum Monitor</b>   | Selects spectrum monitor mode                                   | :DISP:WIND:ACT                        |
| <b>Transient</b>          | Selects transient measurement mode                              | :DISP:WIND:ACT                        |
| <b>User</b>               | Selects user defined window                                     | :DISP:WIND:ACT                        |
| <b>Preset</b>             |                                                                 |                                       |
| <b>Factory</b>            | Preset instrument to the initial setup state                    | :SYST:PRES                            |
| <b>User</b>               | Preset instrument and recalls the Autorec.sta in the F drive    |                                       |
| <b>Save/Recall</b>        |                                                                 |                                       |
| <b>Explorer...</b>        | Open windows explorer                                           |                                       |
| <b>Recall by filename</b> | Recalls state file by file name                                 | :MMEM:LOAD:STAT                       |
| <b>Recall State</b>       |                                                                 |                                       |
| <b>Autorec</b>            | Recalls settings                                                | :MMEM:LOAD:STAT                       |
| <b>File Dialog...</b>     | Open file dialog                                                |                                       |
| <b>State01</b>            | Recalls state file from register 1                              | :MMEM:LOAD:STAT                       |
| <b>State02</b>            | Recalls state file from register 2                              | :MMEM:LOAD:STAT                       |
| <b>State03</b>            | Recalls state file from register 3                              | :MMEM:LOAD:STAT                       |
| <b>State04</b>            | Recalls state file from register 4                              | :MMEM:LOAD:STAT                       |
| <b>State05</b>            | Recalls state file from register 5                              | :MMEM:LOAD:STAT                       |
| <b>State06</b>            | Recalls state file from register 6                              | :MMEM:LOAD:STAT                       |
| <b>Save Data Trace</b>    | Saves trace data                                                | :MMEM:USER[1-1]:TRAC[1-8]:STOR[:DATA] |
| <b>Save Memory Trace</b>  | Saves memory trace data                                         | :MMEM:USER[1-1]:TRAC[1-8]:STOR:MEM    |
| <b>Save State</b>         |                                                                 |                                       |
| <b>Autorec</b>            | Save settings                                                   | :MMEM:STOR:STAT                       |
| <b>File Dialog...</b>     | Open file dialog                                                |                                       |
| <b>Save Type</b>          | Selects instrument state type (Entire or instrument state only) | :MMEM:STOR:STYP                       |
| <b>State01</b>            | Save state file to register 1                                   | :MMEM:STOR:STAT                       |



**Table D-5 User Menu**

| Key Operation                   | Function                                                                       | SCPI Command                                                                   |
|---------------------------------|--------------------------------------------------------------------------------|--------------------------------------------------------------------------------|
| <b>State02</b>                  | Save state file to register 2                                                  | :MMEM:STOR:STAT                                                                |
| <b>State03</b>                  | Save state file to register 3                                                  | :MMEM:STOR:STAT                                                                |
| <b>State04</b>                  | Save state file to register 4                                                  | :MMEM:STOR:STAT                                                                |
| <b>State05</b>                  | Save state file to register 5                                                  | :MMEM:STOR:STAT                                                                |
| <b>State06</b>                  | Save state file to register 6                                                  | :MMEM:STOR:STAT                                                                |
| <b>Scale</b>                    |                                                                                |                                                                                |
| <b>Auto Scale</b>               | Execute autoscale                                                              | :DISP:USER[1-1]:TRAC[1-8]:Y[:SCAL]:AUTO                                        |
| <b>Auto Scale All</b>           | Execute autoscale for all traces on user defined window                        | :DISP:USER[1-1]:ALLT:Y:SCAL:AUTO                                               |
| <b>Divisions</b>                | Sets/reads Y-scale divisions                                                   | :DISP:USER[1-1]:Y[:SCAL]:DIV                                                   |
| <b>Marker -&gt; Reference</b>   | Sets the marker value to the reference level                                   | :DISP:USER[1-1]:TRAC[1-8]:Y[:SCAL]:RLEV                                        |
| <b>Reference Position</b>       | Sets/reads reference position                                                  | :DISP:USER[1-1]:TRAC[1-8]:Y[:SCAL]:RPOS                                        |
| <b>Reference Value</b>          | Sets/reads the reference level value                                           | :DISP:USER[1-1]:TRAC[1-8]:Y[:SCAL]:RLEV                                        |
| <b>Scale/Div</b>                | Sets/reads scale per division                                                  | :DISP:USER[1-1]:TRAC[1-8]:Y[:SCAL]:PDIV                                        |
| <b>X Axis</b>                   |                                                                                |                                                                                |
| <b>Auto</b>                     | Sets/Reads automatic setting of the X-axis display range to the stimulus value | :DISP:USER[1-1]:TRAC[1-8]:X:SCAL:AUTO                                          |
| <b>Band Marker -&gt; X Axis</b> | Sets the X-axis band marker range to the X-axis display range of a graph       | :DISP:USER[1-1]:TRAC[1-8]:X:SCAL:LEFT<br>:DISP:USER[1-1]:TRAC[1-8]:X:SCAL:RIGH |
| <b>Left</b>                     | Sets/Reads the start value of the X-axis display range                         | :DISP:USER[1-1]:TRAC[1-8]:X:SCAL:LEFT                                          |
| <b>Right</b>                    | Sets/Reads the stop value of the X-axis display range                          | :DISP:USER[1-1]:TRAC[1-8]:X:SCAL:RIGH                                          |
| <b>X Axis Type</b>              | Sets/reads the display type of the x axis                                      | :DISP:USER[1-1]:TRAC[1-8]:X:TYPE                                               |
| <b>X Unit</b>                   | Sets/reads X-axis unit                                                         | :DISP:USER[1-1]:TRAC[1-8]:X:UNIT                                               |
| <b>Y Unit</b>                   | Sets/reads Y-axis unit                                                         | :DISP:USER[1-1]:TRAC[1-8]:Y:UNIT                                               |
| <b>System</b>                   |                                                                                |                                                                                |
| <b>Abort Printing</b>           | Aborts printing                                                                | :HCOP:ABOR                                                                     |
| <b>Backlight</b>                | Turns on/off backlight                                                         | :SYST:BACK:STAT                                                                |
| <b>Dump Screen Image</b>        | Save screen image                                                              | :MMEM:STOR:IMAG                                                                |

**Table D-5 User Menu**

| Key Operation                                | Function                                                                              | SCPI Command                       |
|----------------------------------------------|---------------------------------------------------------------------------------------|------------------------------------|
| <b>Instrument Setup</b>                      |                                                                                       |                                    |
| <b>Correction</b>                            |                                                                                       |                                    |
| <b>File Dialog ...</b>                       | Loads correction data for a specified power                                           | :MMEM:LOAD:CORR:POW                |
| <b>Import Power Correction Table</b>         | Loads correction data for a specified power                                           | :MMEM:LOAD:CORR:POW                |
| <b>Power Correction</b>                      | Sets user the user calibration on or off or reads its setting                         | :SENS:CORR:POW:STAT                |
| <b>Downconverter Manual Setup</b>            |                                                                                       |                                    |
| <b>Current</b>                               | Sets/reads the bias current to be supplied to the external mixer                      | :SENS:DCON:MAN:MEXT[1-2]:BIAS:CURR |
| <b>IF Gain 1</b><br><b>IF Gain 2</b>         | Sets/reads the IF gain of the external mixer                                          | :SENS:DCON:MAN:IFG[1-2]            |
| <b>LO1 Frequency</b><br><b>LO2 Frequency</b> | Sets/reads the LO frequency of the external mixer                                     | :SENS:DCON:MAN:LO[1-2]:FREQUENCY   |
| <b>LO1 Level</b><br><b>LO2 Level</b>         | Sets/reads the LO level of the external mixer                                         | :SENS:DCON:MAN:LO[1-2]:LEVEL       |
| <b>Mixer 1 Bias</b><br><b>Mixer 2 Bias</b>   | Sets the bias current supplied to the external mixer on or off and reads its settings | :SENS:DCON:MAN:MEXT[1-2]:BIAS:STAT |
| <b><math>\Delta</math>IF = IF2 - IF1</b>     | Sets/reads the differential frequency between CH1 and CH2 from the external mixer     | :SENS:DCON:MAN:IFD                 |
| <b>Frequency Offset (User Downconv.)</b>     |                                                                                       |                                    |
| <b>Conversion Mode</b>                       | Sets/reads the conversion mode of the frequency offset                                | :SENS:UDC:MODE                     |
| <b>Frequency Offset</b>                      | Sets/reads the frequency offset                                                       | :SENS:UDC:STAT                     |
| <b>Harmonic #</b>                            | Sets/reads the frequency offset factor                                                | :SENS:UDC:HARM                     |
| <b>LO Frequency</b>                          | Sets/reads the LO frequency of the frequency offset                                   | :SENS:UDC:LO                       |
| <b>Invert Image</b>                          | Selects print mode                                                                    | :HCOP:IMAG                         |
| <b>Misc Setup</b>                            |                                                                                       |                                    |
| <b>Beeper</b>                                |                                                                                       |                                    |
| <b>Beep Complete</b>                         | Turns on/off the beep for operation completion                                        | :SYST:BEEP:COMP:STAT               |
| <b>Beep Warning</b>                          | Turns on/off the beep for warning                                                     | :SYST:BEEP:WARN:STAT               |

Table D-5 User Menu

| Key Operation             | Function                                                       | SCPI Command                |
|---------------------------|----------------------------------------------------------------|-----------------------------|
| <b>Test Beep Complete</b> | Makes beep sound for operation completion                      | :SYST:BEEP:COMP:IMM         |
| <b>Test Beep Warning</b>  | Makes beep sound for warning                                   | :SYST:BEEP:WARN:IMM         |
| <b>Clock Setup</b>        |                                                                |                             |
| <b>Set Date and Time</b>  | Set/reads system time                                          | :SYST:TIME                  |
|                           | Set/reads system date                                          | :SYST:DATE                  |
| <b>Show Clock</b>         | Turns on/off internal clock display                            | :DISP:CLOC                  |
| <b>Color Setup</b>        |                                                                |                             |
| <b>Invert</b>             | Sets each color when the inverted display is selected          |                             |
| <b>Background</b>         | Sets/Reads the background color                                | :DISP:COL2:BACK[:VAL]       |
| <b>Data Trace 1</b>       | Sets/Reads the color of the data trace of trace 1              | :DISP:COL2:TRAC1:DATA[:VAL] |
| :                         |                                                                |                             |
| :                         |                                                                |                             |
| <b>Data Trace 8</b>       | Sets/Reads the color of the data trace of trace 8              | :DISP:COL2:TRAC8:DATA[:VAL] |
| <b>Graticule Main</b>     | Sets/Reads the color of the graph                              | :DISP:COL2:GRAT1[:VAL]      |
| <b>Graticule Sub</b>      | Sets/Reads the color of the grid lines in the graph            | :DISP:COL2:GRAT2[:VAL]      |
| <b>Limit Fail</b>         | Sets/Reads the limit display color                             | :DISP:COL2:LIM1[:VAL]       |
| <b>Limit Line</b>         | Sets/Reads the color of the limit line                         | :DISP:COL2:LIM2[:VAL]       |
| <b>Mem Trace 1</b>        | Sets/Reads the color of the memory trace of trace 1            | :DISP:COL2:TRAC1:MEM[:VAL]  |
| :                         |                                                                |                             |
| :                         |                                                                |                             |
| <b>Mem Trace 8</b>        | Sets/Reads the color of the memory trace of trace 8            | :DISP:COL2:TRAC8:MEM[:VAL]  |
| <b>Reset Color</b>        | Resets the display color to the factory preset default setting | :DISP:COL2:RES              |
| <b>Normal</b>             |                                                                |                             |
| <b>Background</b>         | Sets/Reads the background color                                | :DISP:COL1:BACK[:VAL]       |
| <b>Data Trace 1</b>       | Sets/Reads the color of the data trace of trace 1              | :DISP:COL1:TRAC1:DATA[:VAL] |
| :                         |                                                                |                             |
| :                         |                                                                |                             |
| <b>Data Trace 8</b>       | Sets/Reads the color of the data trace of trace 8              | :DISP:COL1:TRAC8:DATA[:VAL] |

**Table D-5 User Menu**

| Key Operation                          | Function                                                                 | SCPI Command               |
|----------------------------------------|--------------------------------------------------------------------------|----------------------------|
| <b>Graticule Main</b>                  | Sets/Reads the color of the graph                                        | :DISP:COL1:GRAT1[:VAL]     |
| <b>Graticule Sub</b>                   | Sets/Reads the color of the grid lines in the graph                      | :DISP:COL1:GRAT2[:VAL]     |
| <b>Limit Fail</b>                      | Sets/Reads the limit display color                                       | :DISP:COL1:LIM1[:VAL]      |
| <b>Limit Line</b>                      | Sets/Reads the color of the limit line                                   | :DISP:COL1:LIM2[:VAL]      |
| <b>Mem Trace 1</b>                     | Sets/Reads the color of the memory trace of trace 1                      | :DISP:COL1:TRAC1:MEM[:VAL] |
| :                                      |                                                                          |                            |
| :                                      |                                                                          |                            |
| <b>Mem Trace 8</b>                     | Sets/Reads the color of the memory trace of trace 8                      | :DISP:COL1:TRAC8:MEM[:VAL] |
| <b>Reset Color</b>                     | Resets the display color to the factory preset default setting           | :DISP:COL1:RES             |
| <b>Control Panel ...</b>               | Open control panel                                                       |                            |
| <b>GPIB Setup</b>                      |                                                                          |                            |
| <b>System Controller Configuration</b> | Turns on/off system controller mode                                      |                            |
| <b>Talker/Listener Address</b>         | Sets the address for controlling the analyzer from a controller via GPIB |                            |
| <b>Key Lock</b>                        |                                                                          |                            |
| <b>Front Panel &amp; Keyboard Lock</b> | Disables from panel / keyboard operations                                | :SYST:KLOC:KBD             |
| <b>Touch Screen &amp; Mouse Lock</b>   | Disables touch screen / mouse operations                                 | :SYST:KLOC:MOUS            |
| <b>Network Setup</b>                   |                                                                          |                            |
| <b>MAC Address</b>                     | Sets MAC address                                                         |                            |
| <b>Network Configuration</b>           | Enables/disables network connections                                     |                            |
| <b>Network Identification</b>          | Sets network ID of the instrument                                        |                            |
| <b>SICL-LAN Address</b>                | Sets SICL-LAN address                                                    |                            |
| <b>SICL-LAN Server</b>                 | Enables/disables SICL-LAN server                                         |                            |
| <b>Socket Server</b>                   | Enables/disables Socket server                                           |                            |
| <b>Telnet Server</b>                   | Enables/disables Telnet server                                           |                            |
| <b>Print</b>                           | Outputs print                                                            | :HCOP:IMM                  |
| <b>Printer Setup ...</b>               | Execute printer setup                                                    |                            |

**Table D-5 User Menu**

| Key Operation                 | Function                                                                                              | SCPI Command                        |
|-------------------------------|-------------------------------------------------------------------------------------------------------|-------------------------------------|
| <b>Product Information</b>    | Reads product information                                                                             |                                     |
| <b>Service Menu</b>           |                                                                                                       |                                     |
| <b>Administrator Menu</b>     | Displays softkeys associated with Administrator Menu. This function is not available to general users |                                     |
| <b>Error Log</b>              |                                                                                                       |                                     |
| <b>Clear Error Log</b>        | Clears the error log                                                                                  |                                     |
| <b>View Error Log ...</b>     | Displays the error log                                                                                |                                     |
| <b>Install Option License</b> |                                                                                                       |                                     |
| <b>Jitter</b>                 | Enters the license for clock jitter analysis (VBA)                                                    |                                     |
| <b>Service Function</b>       | Displays softkeys associated with Service Menu. This function is not available to general users       |                                     |
| <b>Test Menu</b>              |                                                                                                       |                                     |
| <b>Power On Test</b>          | Performs internal test                                                                                |                                     |
| <b>Display Test</b>           | Performs display test                                                                                 |                                     |
| <b>Front Panel</b>            | Performs front panel key (hard key) test                                                              |                                     |
| <b>Adjust Touch Screen</b>    | Performs touch screen calibration                                                                     |                                     |
| <b>E5053A Test</b>            | Displays the connection status of E5053A                                                              |                                     |
| <b>Trace View</b>             |                                                                                                       |                                     |
| <b>Aperture</b>               | Smoothing aperture                                                                                    | :CALC:USER[1-1]:TRAC[1-8]:SMO:APER  |
| <b>Copy to User</b>           | Copies trace data to the user trace                                                                   | :CALC:USER[1-1]:TRAC[1-8]:DATA:COPY |
| <b>Data -&gt; Mem</b>         | Copy data to memory                                                                                   | :CALC:USER[1-1]:TRAC[1-8]:MATH:MEM  |
| <b>Data Hold</b>              | Data hold                                                                                             | :CALC:USER[1-1]:TRAC[1-8]:HOLD      |
| <b>Data Math</b>              | Sets/reads math operation type                                                                        | :CALC:USER[1-1]:TRAC[1-8]:MATH:FUNC |
| <b>Display Trace</b>          | Shows data and/or memory trace                                                                        | :DISP:USER[1-1]:TRAC[1-8]:MODE      |
| <b>Enable Trace</b>           |                                                                                                       |                                     |
| <b>Trace 1</b>                | Enables/disables data trace 1                                                                         | :DISP:USER[1-1]:TRAC[1-8]:STAT      |
| <b>Trace 2</b>                | Enables/disables data trace 2                                                                         | :DISP:USER[1-1]:TRAC[1-8]:STAT      |

**Table D-5 User Menu**

| Key Operation                    | Function                                                                                | SCPI Command                         |
|----------------------------------|-----------------------------------------------------------------------------------------|--------------------------------------|
| <b>Trace 3</b>                   | Enables/disables data trace 3                                                           | :DISP:USER[1-1]:TRAC[1-8]:STAT       |
| <b>Trace 4</b>                   | Enables/disables data trace 4                                                           | :DISP:USER[1-1]:TRAC[1-8]:STAT       |
| <b>Trace 5</b>                   | Enables/disables data trace 5                                                           | :DISP:USER[1-1]:TRAC[1-8]:STAT       |
| <b>Trace 6</b>                   | Enables/disables data trace 6                                                           | :DISP:USER[1-1]:TRAC[1-8]:STAT       |
| <b>Trace 7</b>                   | Enables/disables data trace 7                                                           | :DISP:USER[1-1]:TRAC[1-8]:STAT       |
| <b>Trace 8</b>                   | Enables/disables data trace 8                                                           | :DISP:USER[1-1]:TRAC[1-8]:STAT       |
| <b>Marker -&gt; -Offset</b>      | Sets the sign-inverted data value of the data trace's active marker to the offset value | :CALC:USER[1-1]:TRAC[1-8]:MATH:OFFS  |
| <b>Offset</b>                    | Sets/Reads the offset value of the data trace                                           | :CALC:USER[1-1]:TRAC[1-8]:MATH:OFFS  |
| <b>Persistence</b>               |                                                                                         |                                      |
| <b>Clear All Persistent Data</b> | Clears persistent data from all traces                                                  | :DISP:USER[1-1]:ALLT:PERS:CLE        |
| <b>Persistence Mode</b>          | Enables/Disables persistence mode                                                       | :DISP:USER[1-1]:TRAC[1-8]:PERS:STAT  |
| <b>Smoothing</b>                 | Smoothing on/off                                                                        | :CALC:USER[1-1]:TRAC[1-8]:SMO:STAT   |
| <b>Trace Annotation</b>          | Edits trace annotation                                                                  | :DISP:USER[1-1]:TRAC[1-8]:ANN:DATA   |
| <b>Trace Label</b>               | Edits trace title label                                                                 | :DISP:USER[1-1]:TRAC[1-8]:LABEL:DATA |



**A**

active measurement window, 24  
 active trace, 24  
 AFC, 88  
 AgtmmWave, 193  
 Allan Variance, 118  
 analyzer mode, 78  
 assistance, 5  
 Attenuator, 96, 100, 104, 115, 126, 140, 144, 148, 153  
 Auto Frequency Control, 88  
 Averaging, 84, 110, 121, 134

**B**

Backing Up the Data, 292  
 Bandmarker, 208  
 Bandmarker Coupling, 210  
 Basic Measurement, 77  
 Beeper, 286  
 Bit Error Rate, 251  
 bit error rate, 251

**C**

Calibration of the Touch Screen, 306  
 Carrier Frequency Band, 81, 107, 120  
 certification, 5  
 Chirped FM signal, 241  
 Cleaning the Instrument, 307  
 Clipboard, 246  
 Color, 288  
 Comparing Traces, 222  
 Comparing Traces in User window, 224  
 Configuring the Network, 276  
 Connecting a LAN cable, 63  
 Connecting a printer, 64  
 Connecting the mouse and keyboard, 62

**D**

Data Analysis, 199  
 Data Entry Bar, 35  
 Data Math, 222  
 Data Trace, 222  
 Deterministic Jitter, 251  
 deterministic jitter, 251  
 DC Control Voltage, 86  
 DC Control Voltage Calibration, 38, 86  
 DC control voltage delay, 91  
 DC Power Voltage, 86  
 DC power voltage delay, 91  
 Detector Mode, 124  
 Discrete Marker Mode, 205  
 Display mode, 288  
 documentation map, 7  
 Documentation Warranty, 5  
 DUT Interface, 32

**E**

E5001A, 250, 344  
 Error Messages, 356  
 exclusive remedies, 5  
 external mixer, 178  
 External Reference Signal Input Connector, 48  
 External Trigger, 137  
 External Trigger Input Connector, 47

**F**

File Recall, 229, 235  
 File Save, 229, 232  
 Firmware Revision, 290  
 Firmware Version, 346  
 Format, 124  
 Free-running Source Measurement, 189  
 Frequency Format, 94, 138, 142  
 frequency offset, 181  
 Frequency Reference Signal, 48  
 Frequency Resolution, 83  
 Frequency/Power Measurement, 78  
 Front Panel, 22  
 Fuses, 65

**G**

GPIB, 47, 268  
 GPIB Address, 268  
 GPIB Connector, 47

**H**

Handle Kit, 59, 60  
 Harmonic Mixer, 186  
 Hiding Numeric Information, 243  
 High Stability Frequency Reference Output Connector, 48  
 Histogram, 253  
 history  
     manual printing, 2

**I**

IF Gain, 114  
 Information on Maintenance, 291  
 Initial Registration, 70  
 Installation, 51  
 Instrument Status Bar, 38  
 Internal Clock, 73  
 Internal Reference Signal Output Connector, 48  
 Invert color, 288  
 Invert Image, 247  
 IP Address, 277

**J**

Jitter Components, 250  
 jitter components, 250  
 Jitter Measurement, 249, 344  
 jitter measurement, 249



Jitter Trend, 253  
jitter trend, 253

## L

LAN, 47, 63, 276  
LAN Port, 47  
LCD Screen, 23  
LCD Screen Backlight, 287  
Limit Line  
    Defining, 227  
Limit test, 225  
    Creating/Editing, 227  
Limit test ON/OFF, 228  
List of Default Values, 365  
Locking the Front Keys, Keyboard, and Mouse, 285

## M

Maintenance, 75  
Making backup files, 292  
Managing Files/Folders, 237  
Manual Changes, 345  
manual printing history, 2  
Marker, 44, 200  
Marker Coupling, 206  
Marker Information, 44  
Marker List, 207  
Marker Response, 201  
Marker Search, 200, 208  
Mean, 220  
Measurement Quality, 109  
Measurement Resolution Bandwidth, 122  
Measurement Status, 38  
Measurement Window, 41  
Memory Trace, 222  
microwave downconverter, 160  
Millimeter Wave Phase Noise Measurement, 184, 188  
Mouse, 273

## O

Offset Frequency, 109  
Operating environment, 56  
Operational Manual, 7  
Option Number, 290  
Overview of Functions, 21

## P

Parts with Limited Service Life, 308  
PDF, 253  
Peak Deviation, 216  
Peak Polarity, 216  
Peak Search, 216  
Peak Search All, 218  
Peak-to-Peak, 220  
Periodic Jitter, 251  
periodic jitter, 251  
Phase Noise, 106

phase noise characteristics, 108  
Phase Noise Measurement, 106  
Phase Unit, 151  
Point Delay, 91  
Power Cable, 65  
Power Cable Receptacle, 48  
Power Divider, 184  
Power Supply, 65  
Precautions, 17  
Prescaler, 191  
Printer Driver, 245  
Printing Screen Image, 245  
probability density function, 253  
probability distribution of jitter, 253  
Product Information, 290  
Programming Manual, 7  
PtoP, 220

## R

Rack-mount and Handle Kit, 59, 61  
Rack-mount Kit, 59, 61  
Random Jitter, 251  
random jitter, 251  
Rear Panel, 46  
Recommended Calibration Period, 309  
Reference Marker, 204  
Reference Marker Mode, 204  
Reference Position, 132  
Regression Line, 241  
Regular Calibration, 309  
Relative Value, 204  
Removable Hard Disk, 293  
    purchase, 293  
Repair, 309  
Replacement, 309  
Result Output, 199

## S

safety  
    symbols, 4  
safety summary, 3  
Sample Program, 7  
Saving Display Screen, 244  
Scale, 200  
Screen Capture, 246  
SDev, 220  
Search Tracking, 212  
Search Transition, 214  
Security Level, 243  
Self-test, 75  
Sensitivity Aperture, 94, 138, 142  
Serial Number, 48, 290, 346  
Setting the GPIB, 268  
Setting the Mouse, 273  
Smoothing, 97, 100, 104, 115, 127, 140, 144, 148, 153  
Softkey Functions, 411  
Softkey Menu Bar, 36

- 
- Specifications, 311
    - Automation, 340
    - DC Power/Control Voltage Setting, 338
    - Frequency/RF Power/DC Current Measurements, 321
    - Function differences between standard and option 011, 341
    - General Information, 331
    - Measurement capabilities, 338
    - Phase Noise Measurement, 313
    - Port Output (DC Power/Control), 329
    - Spectrum Monitor, 328
    - Storage, 339
    - System capabilities, 339
    - System performance with E5053A Microwave Downconverter, 342
    - Test Port Input, 330
    - Trace functions, 339
    - Transient Measurement, 324
  - Specifications and Supplemental Information, 311
  - Spectrum Monitor Measurement, 119
  - SSA-J, 250
  - Standard Deviation, 220
  - Standby Switch, 23
  - Statistics Data, 44
  - Stimulus, 200
  - Supported printers, 245
  - Sweep Offset, 132
  - Sweep Parameter, 83, 91, 92
  - Sweep Time, 132
  - System Recovery, 296
- T**
- Target Frequency, 130
  - Target Search, 214
  - tester mode, 78
  - The Control and Management Functions, 267
  - Total Jitter, 251
  - total jitter, 251
  - touch screen, 23
  - Trace Data, 239
  - Trace layout, 79
  - Trace Memory, 240
  - Transient Measurement, 129
  - Trigger Source, 38, 84, 110, 122, 134
  - Troubleshooting, 351
  - Turning the Power OFF, 68
  - Turning the Power ON, 68
  - typeface conventions, 6
- U**
- USB (USBTMC) Interface Port, 49
  - USB Mass Storage Device, 284
  - USB/GPIB Interface, 268
  - user calibration, 155
  - User Mixer, 193
  - User Recovery, 303
  - User window, 224
- V**
- VBA Programming Manual, 7
  - Video Trigger, 135
- W**
- Warning Message, 363
  - Windows 2000, 70
  - Wrap Phase, 151

# REGIONAL SALES AND SUPPORT OFFICES

*For more information about Agilent Technologies test and measurement products, applications, services, and for a current sales office listing, visit our web site: <http://www.agilent.com/find/tmdir>. You can also contact one of the following centers and ask for a test and measurement sales representative. 21/01/2004*

## United States:

Test and Measurement Call Center  
(tel) 1 800 452-4844  
(fax) 1 888 900-8921

## Australia/New Zealand:

(tel) (61 3) 9210-5555 (Australia)  
(fax) (61 3) 9210-5899  
(tel) (64 4) 939-0636 (New Zealand)  
(fax) (64 4) 972-5364

## Canada:

Test and Measurement Call Center  
(tel) 1 877 894-4414  
(fax) 1 888 900-8921

## Asia Pacific:

(tel) (65) 6375-8100  
(fax) (65) 6836-0252  
Email: [tm\\_asia@agilent.com](mailto:tm_asia@agilent.com)

## China:

(tel) 800 810-0189  
(fax) 800 820-2816

## Europe:

(tel) (31 20) 547-2323  
(fax) (31 20) 547-2390

## Japan:

Call Center  
(tel) 0120 421-345  
(tel) (81) 426 56-7832  
(fax) (81) 426 56-7840

## Korea:

(tel) (82 2) 2004-5004  
(fax) (82 2) 2004-5115

## Latin America:

(tel) (305) 269-7500  
(fax) (305) 269-7599

## Taiwan:

(tel) 0800 047 866  
(fax) 0800 286 331