

Agilent Technologies
89441A Installation and
Verification Guide

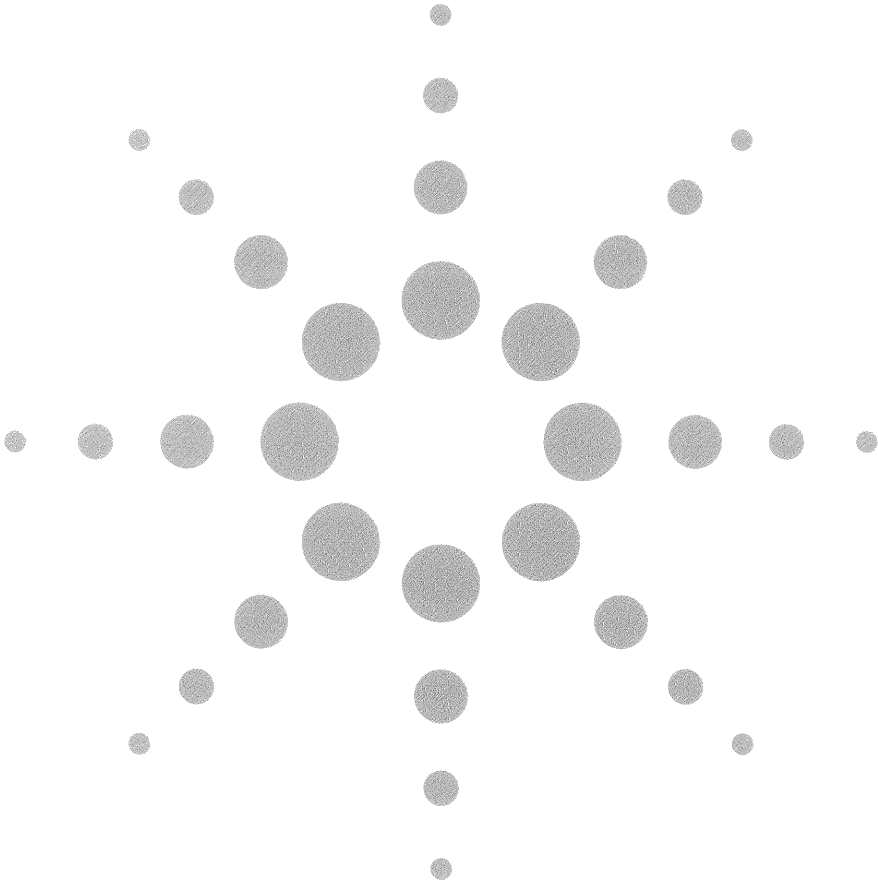

Agilent Technologies

6

(

Agilent Technologies 89441A Installation and Verification Guide

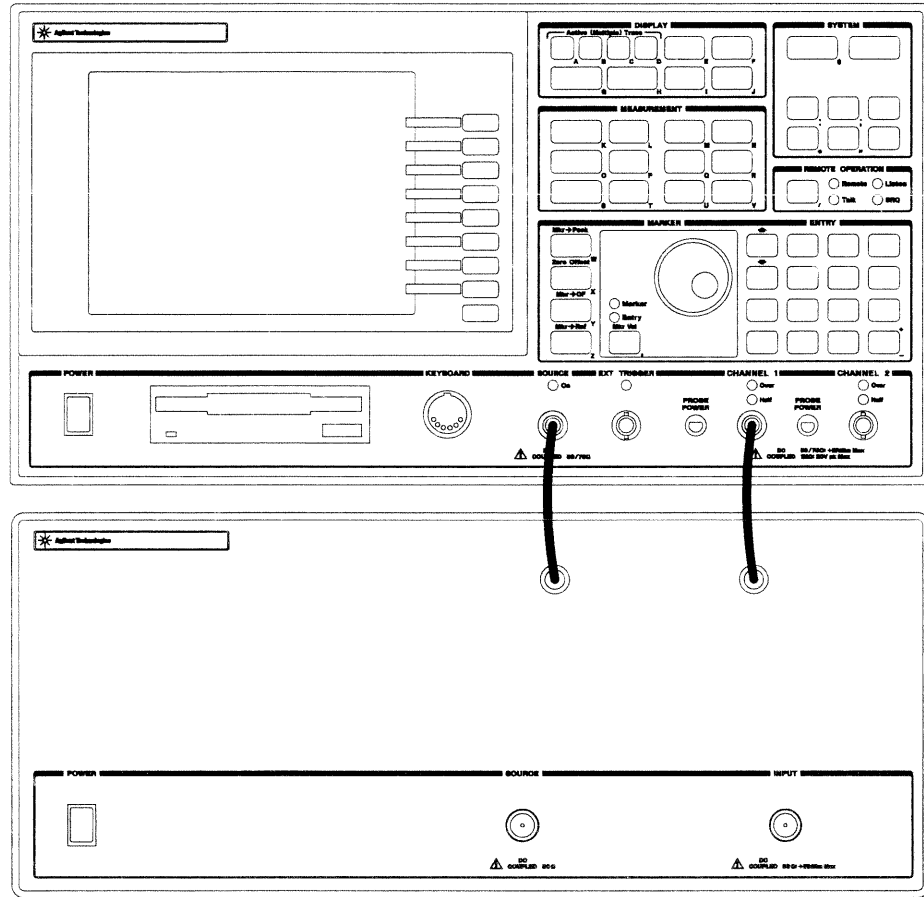

Agilent Technologies Part Number 89441-90077
For instruments with firmware version A.08.00
Printed in U.S.A.

Print Date: June, 2000
© Agilent Technologies 1994, 1996, 2000. All rights reserved.
8600 Soper Hill Road Everett, Washington 98205-1298 U.S.A.

The Analyzer at a Glance

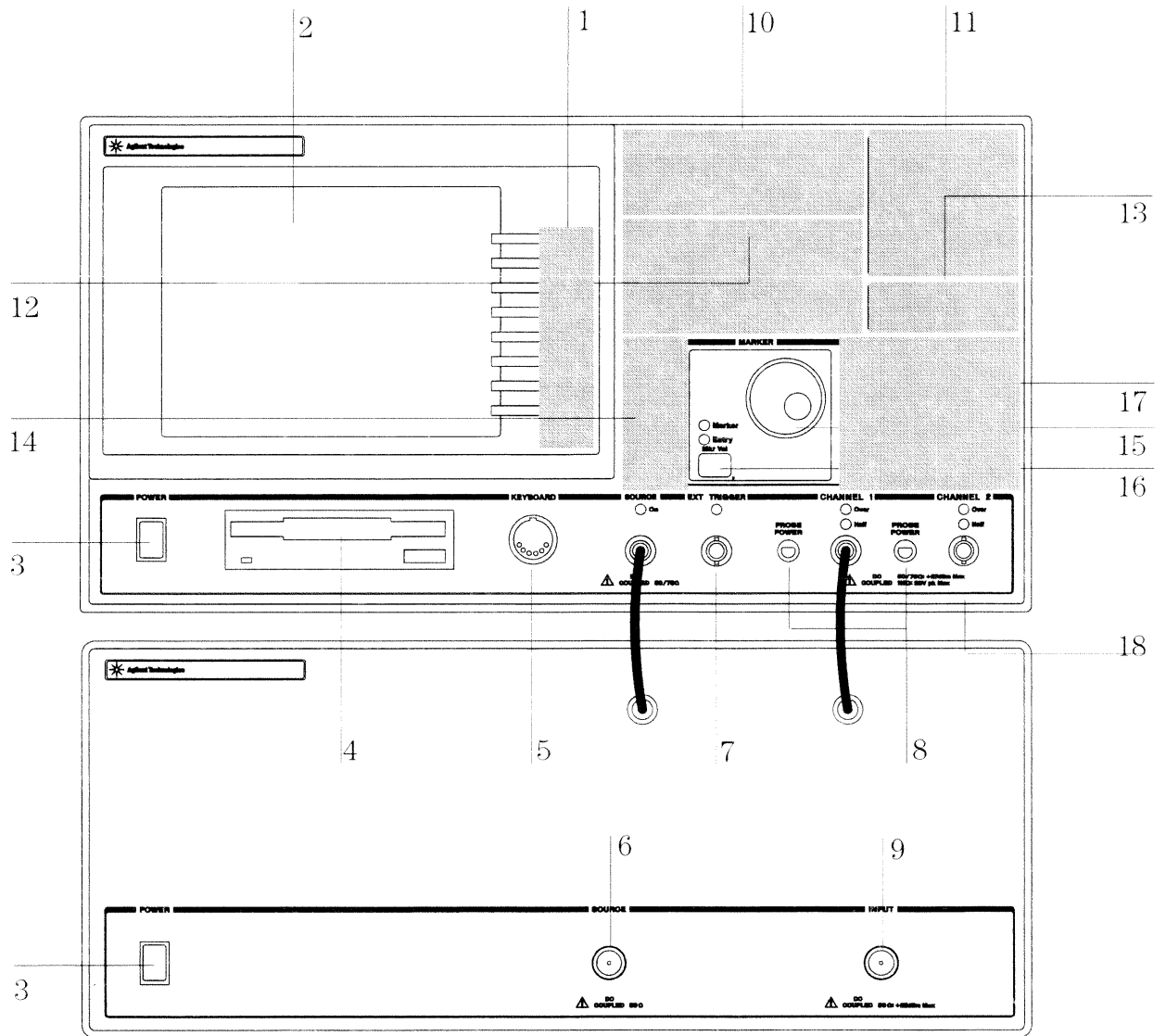

Front Panel

1-A softkey's function changes as different menus are displayed. Its current function is determined by the video label to its left, on the analyzer's screen.

2-The analyzer's screen is divided into two main areas. The menu area, a narrow column at the screen's right edge, displays softkey labels. The data area, the remaining portion of the screen, displays traces and other data.

3-The POWER switch turns the analyzer on and off.

4-Use a 3.5-inch flexible disk (DS,HD) in this disk drive to save your work.

5-The KEYBOARD connector allows you to attach an optional keyboard to the analyzer. The keyboard is most useful for writing and editing HP Instrument BASIC programs.

6-The SOURCE connector routes the analyzer's source output to your DUT. If option AY8 (internal RF source) is installed, the connector is a type-N. If option AY8 is not installed, the connector is a BNC. Output impedance is selectable: 50 ohms or 75 ohms with option 1D7 (minimum loss pads).

7-The EXT TRIGGER connector lets you provide an external trigger for the analyzer.

8-The PROBE POWER connectors provide power for various HP active probes.

9-The INPUT connector routes your test signal or DUT output to the analyzer's receiver. Input impedance is selectable: 50 ohms or 75 ohms with option 1D7 (minimum loss pads).

10-Use the DISPLAY hardkeys and their menus to select and manipulate trace data and to select display options for that data.

11-Use the SYSTEM hardkeys and their menus to control various system functions (online help, plotting, presetting, and so on).

12-Use the MEASUREMENT hardkeys and their menus to control the analyzer's receiver and source, and to specify other measurement parameters.

13-The REMOTE OPERATION hardkey and LED indicators allow you to set up and monitor the activity of remote devices.

14-Use the MARKER hardkeys and their menus to control marker positioning and marker functions.

15-The knob's primary purpose is to move a marker along the trace. But you can also use it to change values during numeric entry, move a cursor during text entry, or select a hypertext link in help topics.

16-Use the Marker/Entry key to determine the knob's function. With the Marker indicator illuminated, the knob moves a marker along the trace. With the Entry indicator illuminated, the knob changes numeric entry values.

17-Use the ENTRY hardkeys to change the value of numeric parameters or to enter numeric characters in text strings.

18-The optional CHANNEL 2 input connector routes your test signal or DUT output to the analyzer's receiver. Input impedance is selectable: 50 ohms, 75 ohms, or 1 megohm. For ease of upgrading, the CHANNEL 2 BNC connector is installed even if option AY7 (second input channel) is not installed.

For more details on the front panel, display the online help topic "Front Panel." See the chapter "Using Online Help" if you are not familiar with using the online help index.

This page left intentionally blank.

Options and Accessories

To determine if an option is installed, press [**System Utility**] [option setup]. Installed options are also listed on the analyzer's rear panel.

To order an option to upgrade your Agilent 89441A, order Agilent 89441U followed by the option number.

Option Description	Agilent 89441U Option	
Internal RF Source	AY8	
High Precision Frequency Reference	AYC	
Vector Modulation Analysis	AYA	
Waterfall and Spectrogram	AYB	
Digital Video Modulation Analysis and Adaptive Equalization	AYH	
Add Adaptive Equalization to option AYA	AYJ	
Second 10 MHz Input Channel	AY7	
Extend Time Capture to 1 megasample	AY9	
4 megabyte Extended RAM and Additional I/O	UFG	
Advanced LAN Support (requires option UFG)	UG7	
Agilent Instrument BASIC	1C2	
50 - 75 Ohm Minimum Loss Pads	1D7	
PC-Style Keyboard and Cable	U.S. version	1F0
PC-Style Keyboard and Cable	German version	1F1
PC-Style Keyboard and Cable	Spanish version	1F2
PC-Style Keyboard and Cable	French version	1F3
PC-Style Keyboard and Cable	U.K. version	1F4
PC-Style Keyboard and Cable	Italian version	1F5
PC-Style Keyboard and Cable	Swedish version	1F6
Front Handle Kit	AX3	
Rack Flange Kit	AX4	
Flange and Handle Kit	AX5	
Extra Manual Set	OB1	
Extra Instrument BASIC Manuals	OBU	
Service Manual	OB3	
Firmware Update Kit	UE2	

The accessories listed in the following table are supplied with the Agilent 89441A.

Supplied Accessories

Line Power Cable (see page 1-4)

Rear Panel Lock Foot Kit (Agilent 5062-3999)

BNC Cable - 12 inch (Agilent 8120-1838)

2 BNC Cables - 8.5 inch (HP 8120-2682)

Coax BNC(m)-to-coax BNC(m) Connector (Agilent 1250-1499, deleted with option AY4)

Type N-to-BNC Adapter (Agilent 1250-0780, 2 with option AY8)

Serial Interface Interconnect Cable (Agilent 8120-6230)

Interconnect Cable EMI Suppressor (Agilent 9170 1521)

Standard Data Format Utilities (Agilent 5061-8056)

Agilent Technologies 89441A Operator's Guide

Agilent Technologies 89441A Getting Started Guide

Agilent Technologies 89441A Installation and Verification Guide

Agilent Technologies 89400 Series GPIB Command Reference

GPIB Programmer's Guide

Agilent Technologies 89400 Series GPIB Quick Reference

Agilent 89400 Series Documentation Roadmap

The accessories listed in the following table are available for the Agilent 89441A.

Available Accessories	Part Number
Agilent 89411A 21.4 MHz Down Converter	Agilent 89411A
<i>Agilent 89400 Series Using Agilent Instrument BASIC</i>	Agilent 89441-90013
<i>Agilent Instrument BASIC User's Handbook</i>	Agilent E2083-90005
<i>Spectrum and Network Measurements</i>	Agilent 5960-5718
Box of ten 3.5-inch double-sided, double-density disks	Agilent 92192A
Active Probe	Agilent 41800A
Active Probe	Agilent 54701A
Active Divider Probe	Agilent 1124A
Resistor Divider Probe	Agilent 10020A
Differential Probe (requires Agilent 1142A)	Agilent 1141A
Probe Control and Power Module	Agilent 1142A
50 Ohm RF Bridge	Agilent 86205A
Switch/Control Unit	Agilent 3488A
High-Performance Switch/Control Unit	Agilent 3235A
GPIB Cable - 1 meter	Agilent 10833A
GPIB Cable - 2 meter	Agilent 10833B
GPIB Cable - 4 meter	Agilent 10833C
GPIB Cable - 0.5 meter	Agilent 10833D
HP Printer or Plotter	(contact your local Hewlett-Packard sales representative)

This page left intentionally blank.

Safety Summary

The following general safety precautions must be observed during all phases of operation of this instrument. Failure to comply with these precautions or with specific warnings elsewhere in this manual violates safety standards of design, manufacture, and intended use of the instrument. Agilent Technologies, Inc. assumes no liability for the customer's failure to comply with these requirements.

GENERAL

This product is a Safety Class 1 instrument (provided with a protective earth terminal). The protective features of this product may be impaired if it is used in a manner not specified in the operation instructions.

All Light Emitting Diodes (LEDs) used in this product are Class 1 LEDs as per IEC 60825-1.

ENVIRONMENTAL CONDITIONS

This instrument is intended for indoor use in an installation category II, pollution degree 2 environment. It is designed to operate at a maximum relative humidity of 95% and at altitudes of up to 2000 meters. Refer to the specifications tables for the ac mains voltage requirements and ambient operating temperature range.

BEFORE APPLYING POWER

Verify that the product is set to match the available line voltage, the correct fuse is installed, and all safety precautions are taken. Note the instrument's external markings described under Safety Symbols.

GROUND THE INSTRUMENT

To minimize shock hazard, the instrument chassis and cover must be connected to an electrical protective earth ground. The instrument must be connected to the ac power mains through a grounded power cable, with the ground wire firmly connected to an electrical ground (safety ground) at the power outlet. Any interruption of the protective (grounding) conductor or disconnection of the protective earth terminal will cause a potential shock hazard that could result in personal injury.

FUSES

Only fuses with the required rated current, voltage, and specified type (normal blow, time delay, etc.) should be used. Do not use repaired fuses or short-circuited fuse holders. To do so could cause a shock or fire hazard.

DO NOT OPERATE IN AN EXPLOSIVE ATMOSPHERE

Do not operate the instrument in the presence of flammable gases or fumes.

DO NOT REMOVE THE INSTRUMENT COVER

Operating personnel must not remove instrument covers. Component replacement and internal adjustments must be made only by qualified service personnel.

Instruments that appear damaged or defective should be made inoperative and secured against unintended operation until they can be repaired by qualified service personnel.

WARNING

The WARNING sign denotes a hazard. It calls attention to a procedure, practice, or the like, which, if not correctly performed or adhered to, could result in personal injury. Do not proceed beyond a WARNING sign until the indicated conditions are fully understood and met.

Caution

The CAUTION sign denotes a hazard. It calls attention to an operating procedure, or the like, which, if not correctly performed or adhered to, could result in damage to or destruction of part or all of the product. Do not proceed beyond a CAUTION sign until the indicated conditions are fully understood and met.

Safety Symbols



Warning, risk of electric shock



Caution, refer to accompanying documents



Alternating current



Both direct and alternating current



Earth (ground) terminal



Protective earth (ground) terminal



Frame or chassis terminal



Terminal is at earth potential.



Standby (supply). Units with this symbol are not completely disconnected from ac mains when this switch is off

Notation Conventions

Before you use this book, it is important to understand the types of keys on the front panel of the analyzer and how they are denoted in this book.

Hardkeys Hardkeys are front-panel buttons whose functions are always the same. Hardkeys have a label printed directly on the key. In this book, they are printed like this: [**Hardkey**].

Softkeys Softkeys are keys whose functions change with the analyzer's current menu selection. A softkey's function is indicated by a video label to the left of the key (at the edge of the analyzer's screen). In this book, softkeys are printed like this: [softkey].

Toggle Softkeys Some softkeys toggle through multiple settings for a parameter. Toggle softkeys have a word highlighted (of a different color) in their label. Repeated presses of a toggle softkey changes which word is highlighted with each press of the softkey. In this book, toggle softkey presses are shown with the requested toggle state in bold type as follows:

"Press [key name **on**]" means "press the softkey [key name] until the selection **on** is active."

Shift Functions In addition to their normal labels, keys with blue lettering also have a shift function. This is similar to shift keys on a pocket calculator or the shift function on a typewriter or computer keyboard. Using a shift function is a two-step process. First, press the blue [**Shift**] key (at this point, the message "shift" appears on the display). Then press the key with the shift function you want to enable. Shift function are printed as two key presses, like this:
[**Shift**] [**Shift Function**]

Numeric Entries Numeric values may be entered by using the numeric keys in the lower right hand ENTRY area of the analyzer front panel. In this book values which are to be entered from these keys are indicated only as numerals in the text, like this:
Press 50, [enter]

Ghosted Softkeys A softkey label may be shown in the menu when it is inactive. This occurs when a softkey function is not appropriate for a particular measurement or not available with the current analyzer configuration. To show that a softkey function is not available, the analyzer "ghosts" the inactive softkey label. A ghosted softkey appears less bright than a normal softkey. Settings/values may be changed while they are inactive. If this occurs, the new settings are effective when the configuration changes such that the softkey function becomes active.

In This Book

This guide provides instructions for installing and verifying the performance of the Agilent 89441A DC-2650 MHz Vector Signal Analyzer.

Chapter 1, “Preparing the Analyzer for Use,” provides step-by-step instructions for getting the analyzer ready to use and instructions on cleaning the screen, storing, and transporting.

Chapter 2, “Verifying Specifications,” provides step-by-step instructions for installing and running the semiautomated performance test software. This chapter also provides illustrations that show the equipment set up for each test and a copy of the test records.

This page left intentionally blank

Table of Contents

1 Preparing the Analyzer for Use

- To do the incoming inspection 1-5
- To connect the sections 1-7
- To install the analyzer 1-9
- To change the IF section's line-voltage switch 1-10
- To change the RF section's line-voltage switch 1-11
- To change the IF section's fuse 1-12
- To change the RF section's fuse 1-13
- To connect the analyzer to a LAN 1-14
- To connect the analyzer to a serial device 1-15
- To connect the analyzer to a parallel device 1-15
- To connect the analyzer to an GPIB device 1-16
- To connect the analyzer to an external monitor 1-17
- To connect the optional keyboard 1-18
- To connect the optional minimum loss pad 1-20
- To clean the screen 1-21
- To store the analyzer 1-21
- To transport the analyzer 1-22
- If the IF section will not power up 1-23
- If the RF section will not power up 1-24
- If the analyzer's stop frequency is 10 MHz 1-25

2 Verifying Specifications

- To load the program 2-10
- To run the program in semiautomated mode 2-11
- To run the program without a printer 2-13
- To run the program in manual mode 2-15
- To set up the self test 2-16
- To set up the amplitude accuracy test 2-17
- To set up the amplitude linearity test 2-23
- To set up the amp_phase match test 2-25
- To set up the intermodulation distortion test 2-27

To set up the input coupling test 2-30
To set up the input trigger test 2-32
To set up the external trigger test 2-34
To set up the external arm test 2-35
To set up the harmonic distortion test 2-36
To set up the input capacitance test 2-39
To set up the input resistance test 2-42
To set up the dc offset test 2-44
To set up the spurious signals test 2-45
To set up the noise test 2-46
To set up the cross talk test 2-47
To set up the anti-alias filter test 2-49
To set up the input rtn loss test 2-51
To set up the source rtn loss test 2-55
To set up the source amplitude accuracy test 2-58
To set up the source distortion test 2-59
To set up the RF-amplitude accuracy test 2-60
To set up the phase noise test 2-62
To set up the LO spurs test 2-63
To set up the RF-spurious signals test 2-64
To set up the RF-harmonic distortion test 2-65
To set up the frequency accuracy test 2-67
To set up the RF-noise test 2-68
To set up the RF residuals test 2-69
To set up the RF-source amplitude accuracy test 2-70
To set up the RF-source IF-flatness test 2-71
To set up the RF-source spurious test 2-72
To set up the RF-source distortion test 2-73
To set up the RF-source noise test 2-74
Performance Test Record 1 through 23
Operation Verification Test Record 1 through 12

Index

Agilent 89400-Series Documentation Roadmap

About this edition

Need Assistance?

1

Preparing the Analyzer for Use

Preparing the Analyzer for Use

This chapter contains instructions for inspecting and installing the Agilent 89441A DC-2650 MHz Vector Signal Analyzer. This chapter also includes instructions for cleaning the screen, transporting and storing the analyzer.

Power Requirements

The analyzer can operate from a single-phase ac power source supplying voltages as shown in the table. With all options installed, the total power consumption of both sections is less than 1025 VA.

AC Line Voltage	
Range	Frequency
90-140 Vrms	47-63 Hz
198-264 Vrms	47-63 Hz

The line-voltage selector switches are set at the factory to match the most commonly used line voltage in the country of destination; the appropriate fuses are also installed. To check or change either the line-voltage selector switch or the fuse, see the appropriate sections later in this chapter.

Warning

Only a qualified service person, aware of the hazards involved, should measure the line voltage.

Caution

Before applying ac line power to the analyzer, ensure the line-voltage selector switches are set for the proper line voltage and the correct line fuses are installed in the fuse holders.

Power Cable and Grounding Requirements

On the GPIB connector, pin 12 and pins 18 through 24 are tied to chassis ground and the GPIB cable shield. The instrument frame, chassis, covers, and all exposed metal surfaces including the connectors' outer shell are connected to chassis ground. However, if channel 2 in the IF section is not installed, the channel 2 BNC connector's outer shell is not connected to chassis ground.

Warning

DO NOT interrupt the protective earth ground or "float" the Agilent 89441A DC-2650 MHz Vector Signal Analyzer. This action could expose the operator to potentially hazardous voltages.

The analyzer is equipped with two three-conductor power cords which ground the analyzer when plugged into appropriate receptacles. The type of power cable plug shipped with each analyzer depends on the country of destination. The following figure shows available power cables and plug configurations.

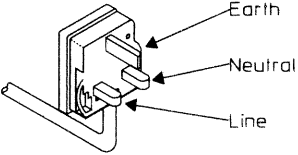
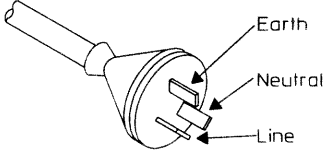
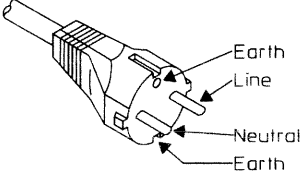
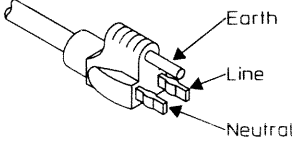
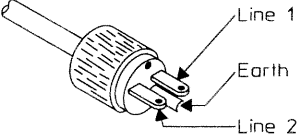
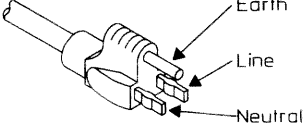
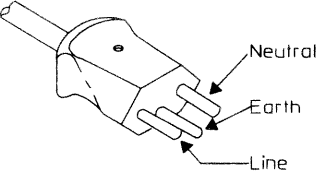
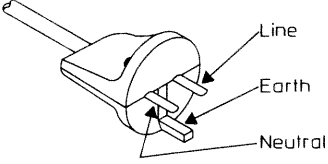
<p>United Kingdom Option 900</p>  <p>PLUG*: BS 1363A CABLE*: P/N 8120-1351</p> <p>220V-5A OPERATION</p>	<p>Australia/New Zealand Option 901</p>  <p>PLUG*: NZSS 198/AS C112 CABLE*: P/N 8120-1369</p> <p>220V-6A OPERATION</p>
<p>Continental Europe Option 902</p>  <p>PLUG*: CEE7-V11 CABLE*: P/N 8120-1689</p> <p>220V-6A OPERATION</p>	<p>North America Option 903</p>  <p>PLUG*: NEMA 5-15P CABLE*: P/N 8120-1378</p> <p>125V-10A** OPERATION</p>
<p>North America Option 904</p>  <p>PLUG*: NEMA-6-15P CABLE*: P/N 8120-0698</p> <p>250V-6A** OPERATION</p>	<p>Japan Option 918</p>  <p>PLUG*: MITI 41-9692 CABLE*: P/N 8120-4753</p> <p>125V-12A OPERATION</p>
<p>Switzerland Option 906</p>  <p>PLUG*: SEV 1011.1959-24507 TYPE 12 CABLE*: P/N 8120-2104</p> <p>220V-6A OPERATION</p>	<p>Denmark Option 912</p>  <p>PLUG*: DHCR 107 CABLE*: P/N 8120-2956</p> <p>220V-6A OPERATION</p>

*The number shown for the plug is the industry identifier for the plug only, the number shown for the cable is an Agilent part number for a complete cable including the plug.

**UL listed for use in the United States of America.

Warning

The power cable plug must be inserted into an outlet provided with a protective earth terminal. Defeating the protection of the grounded analyzer cabinet can subject the operator to lethal voltages.

To do the incoming inspection

The Agilent 89441A DC-2650 MHz Vector Signal Analyzer was carefully inspected both mechanically and electrically before shipment. It should be free of marks or scratches, and it should meet its published specifications upon receipt.

- 1** Inspect the analyzer for physical damage incurred in transit. If the analyzer was damaged in transit, do the following:
 - Save all packing materials.
 - File a claim with the carrier.
 - Call your Agilent Technologies sales and service office.

Warning

If the analyzer is mechanically damaged, the integrity of the protective earth ground may be interrupted. Do not connect the analyzer to power if it is damaged.

- 2** Check that the line-voltage selector switches are set for the local line voltage.

The line-voltage selector switches are set at the factory to match the most commonly used line voltage in the country of destination. To check or change the line-voltage selector switches, see “To change the IF section’s line-voltage switch” and “To change the RF section’s line-voltage switch.”

- 3** Check that the correct line fuses are installed in the fuse holders.

The fuses are installed at the factory for the most commonly used line voltage in the country of destination. The analyzer’s IF section requires an 8 amp, 250 volt, normal blow fuse for 115 V operation and a 4 amp, 250 volt, normal blow fuse for 230 volt operation. The analyzer’s RF section requires a 3 amp, 250 volt, slow blow fuse for 100/120 volt operation and a 1.5 amp, 250 volt, slow blow fuse for 220/240 volt operation. For instructions on removing the fuse or fuse part numbers, see “To change the IF section’s fuse” and “To change the RF section’s fuse.”

- 4** Connect the IF section to the RF section.

For instructions on connecting the sections, see “To connect the sections.”

- 5** Using the supplied power cords, plug the analyzer’s IF section and RF section into appropriate receptacles.

The analyzer is shipped with two three-conductor power cords that ground the analyzer when plugged into appropriate receptacles. The type of power cable plug shipped with each analyzer depends on the country of destination.

- 6 Set the RF section's rear panel line switch and front panel power switch to on.**
Press the "I" symbol end of the rocker-switches located on the lower right of the rear panel and on the lower left of the front panel. The RF section provides standby power for the high precision frequency reference. The rear-panel line switch interrupts all power including standby power when you press the "O" symbol end of the switch. The front-panel power switch interrupts all power except standby power when you press the "O" symbol end of the switch.
- 7 Set the IF section's power switch to on.**
Press the "I" symbol end of the rocker-switch located on the lower left of the front panel. The analyzer requires about 30 seconds to complete its power-on routine.
- 8 Test the electrical performance of the analyzer using the operation verification or the performance tests in chapter 2, "Verifying Specifications."**
The operation verification tests verify the basic operating integrity of the analyzer; these tests take about 2.5 hours to complete and are a subset of the performance tests. The performance tests verify that the analyzer meets its performance specifications; these tests take about 5 hours to complete.

To connect the sections

Do NOT use the IF section's EXT REF OUT connector or optional OVEN REF OUT connector as an external reference output.

1 Attach the IF section to the RF section.

If the hardware is not installed, follow the instructions supplied with the Rear Panel Lock Foot Kit. If the hardware is already installed, slide the IF section on top of the RF section making sure the front lock-links engage the IF section's frame. Screw the rear lock feet together.

2 Connect the RF section's SERIAL 2 port to the IF section's SERIAL 2 port using the supplied serial interface interconnect cable. Make sure the end of the cable with the EMI suppressor is connected to the IF section.

3 Connect the RF section's OVEN REF OUT connector to the EXT REF IN connector using the supplied coax BNC-to-coax BNC connector.

If the RF section does not have the OVEN REF OUT connector (option AY4, Delete High Precision Frequency Reference), connect a 1 MHz, 2 MHz, 5 MHz, or 10 MHz sine or square wave, with an amplitude greater than 0 dBm to the RF section's EXT REF IN connector. For best residual phase-noise, use 10 MHz with an amplitude greater than or equal to 5 dBm. See the *Agilent 89441A Technical Data* publication for specifications that require the high precision frequency reference.

4 Connect the RF section's 10 MHz REF TO IF SECTION connector to the IF section's EXT REF IN connector using the supplied 12-inch BNC-to-BNC cable.

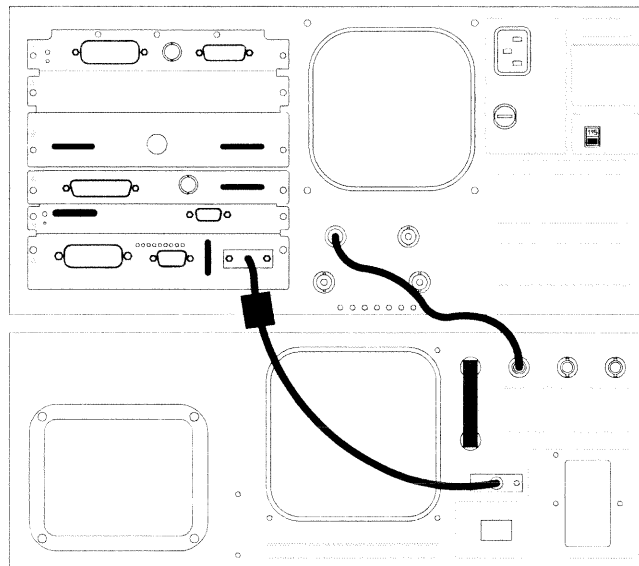

- 5** Connect the IF section's SOURCE connector to the RF section's IN connector using the supplied 8.5-inch BNC-to-BNC cable.
- 6** Connect the IF section's CHANNEL 1 connector to the RF section's OUT connector using the supplied 8.5-inch BNC-to-BNC cable.

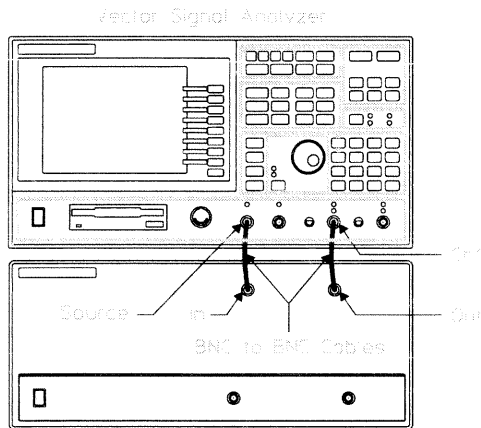

To install the analyzer

The analyzer is shipped with plastic feet in place, ready for use as a portable bench analyzer. The plastic feet are shaped to make full-width modular instruments self-align when they are stacked.

- **Install the analyzer to allow free circulation of cooling air.**
Cooling air enters the analyzer through the rear panel and exhausts through both sides.

Warning

To prevent potential fire or shock hazard, do not expose the analyzer to rain or other excessive moisture.

- **Protect the analyzer from moisture and temperatures or temperature changes that cause condensation within the analyzer.**
The operating environment specifications for the analyzer are listed in the *Agilent 89441A Technical Data* publication.

Caution

Use of the equipment in an environment containing dirt, dust, or corrosive substances will drastically reduce the life of the disk drive and the flexible disks. The flexible disks should be stored in a dry, static-free environment.

- **To install the analyzer in an equipment cabinet, follow the instructions shipped with the rack mount kits.**

To change the IF section's line-voltage switch

The line-voltage selector switch is set at the factory to match the most commonly used line voltage in the country of destination.

- 1 Unplug the power cord from the IF section (the section with "Agilent 89410A" silk screened on its lower right rear panel).
- 2 Slide the line voltage selector switch to the proper setting for the local line voltage.
- 3 Check that the proper fuse is installed. See "To change the IF section's fuse."

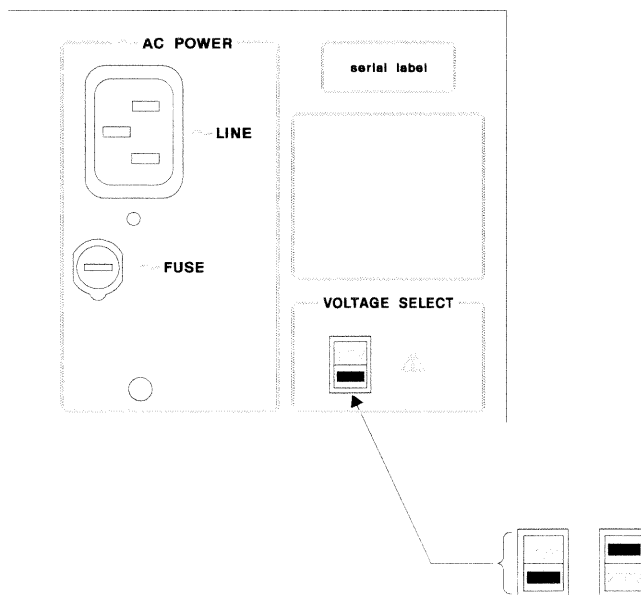

Range	AC Line Voltage		Voltage Select Switch
		Frequency	
90-140 Vrms		47-440 Hz	115
198-264 Vrms		47-63 Hz	230

Warning

Only a qualified service person, aware of the hazards involved, should measure the line voltage.

To change the RF section's line-voltage switch

The line-voltage selector switch is set at the factory to match the most commonly used line voltage in the country of destination.

- 1 Unplug the power cord from the RF section (the section with "Agilent 89431A" silk screened on its lower left rear panel).
- 2 Using a small screw driver, pry open the power selector cover.

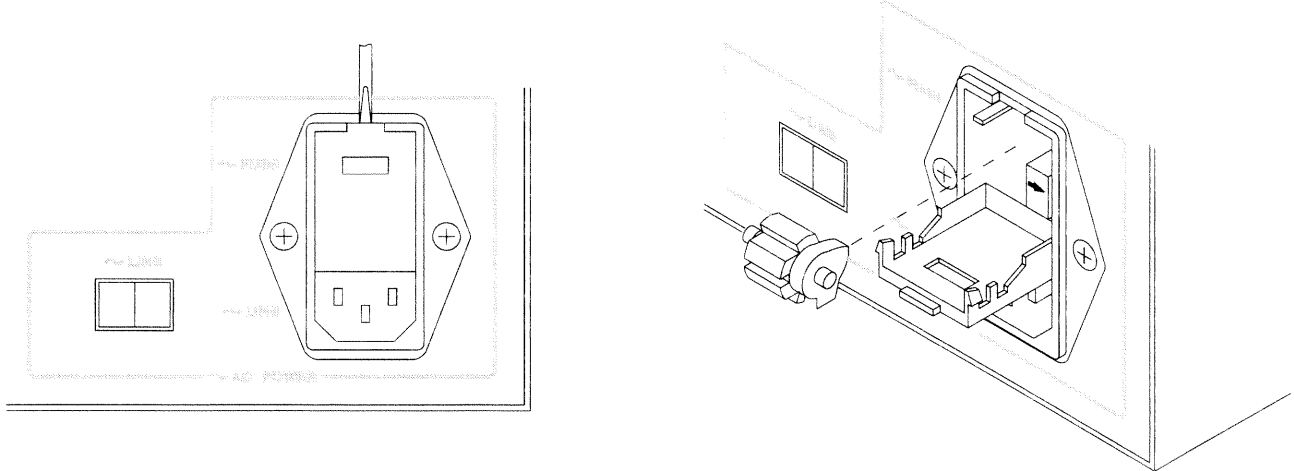

- 3 Remove the cylindrical line voltage selector.
- 4 Position the cylindrical line voltage selector so the required voltage will be facing out of the power selector, then reinstall.

AC Line Voltage

Range	Frequency	Selector Switch
90-110 Vrms	47-63 Hz	100
103-140 Vrms	47-63 Hz	120
198-242 Vrms	47-63 Hz	220
216-264 Vrms	47-63 Hz	240

Warning

Only a qualified service person, aware of the hazards involved, should measure the line voltage.

- 5 Check that the proper fuse is installed. See "To change the RF section's fuse."
- 6 Close the power selector by pushing firmly on the power selector cover.
- 7 Check that the correct line voltage appears through the power selector cover.

To change the IF section's fuse

The fuse is installed at the factory to match the most commonly used line voltage in the country of destination.

- 1 Unplug the power cord from the IF section (the section with "Agilent 89410A" silk screened on its lower right rear panel).
- 2 Using a small screw driver, press in and turn the fuse holder cap counter-clockwise. Remove when the fuse cap is free from the housing.

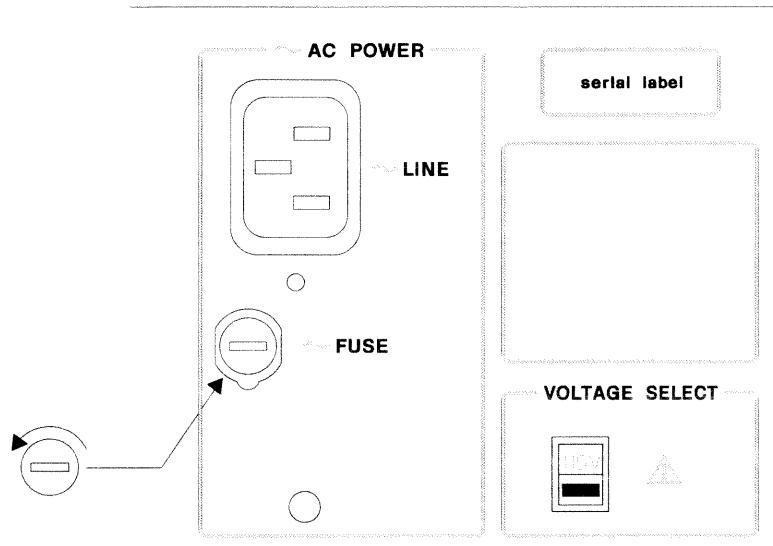

- 3 Pull the fuse from the fuse holder cap.
- 4 To reinstall, select the proper fuse and place in the fuse holder cap.

AC Line Voltage		Voltage Select Switch	Agilent Part Number	Fuse
Range	Frequency			Type
90-140 Vrms	47-440 Hz	115	2110-0342	8 A 250 V Normal Blow
198-264 Vrms	47-63 Hz	230	2110-0055	4 A 250 V Normal Blow

- 5 Place the fuse holder cap in the housing and turn clockwise while pressing in.

To change the RF section's fuse

The fuse is installed at the factory to match the most commonly used line voltage in the country of destination.

- 1** Unplug the power cord from the RF section (the section with "Agilent 89431A" silk screened on its lower left rear panel).
- 2** Using a small screw driver, pry open the power selector cover.

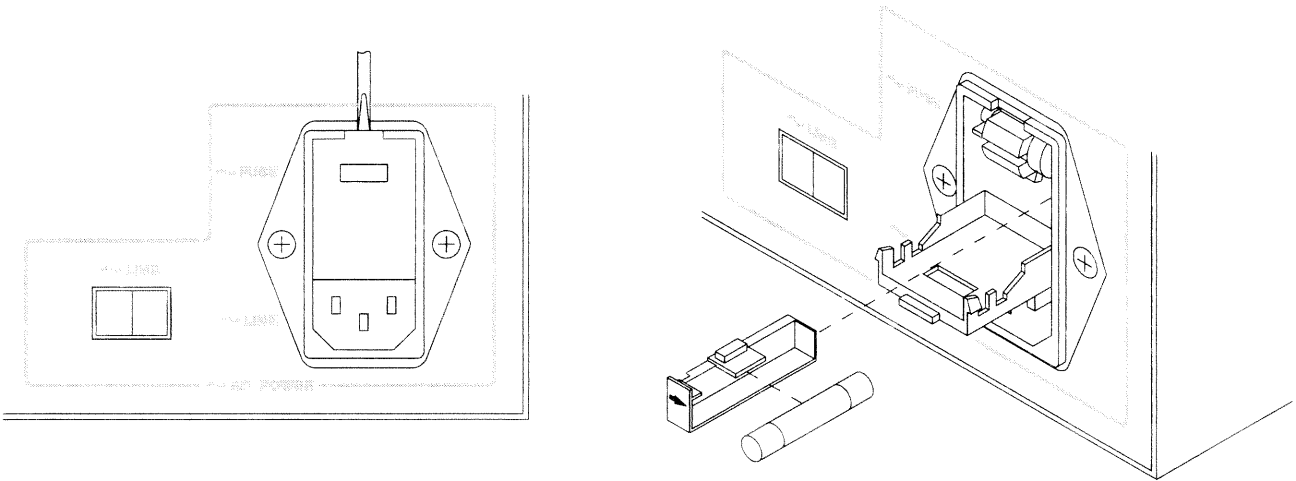

- 3** Pull the white fuse holder out of the power selector and remove the fuse from the fuse holder.
- 4** Select the proper fuse and place in the fuse holder.

AC Line Voltage			Fuse	
Range	Frequency		Agilent Part Number	Type
90-110 Vrms	47-63 Hz	100	2110-0381	3 A 250 V Slow Blow
103-140 Vrms	47-63 Hz	120	2110-0381	3 A 250 V Slow Blow
198-242 Vrms	47-63 Hz	220	2110-0304	1.5 A 250 V Slow Blow
216-264 Vrms	47-63 Hz	240	2110-0304	1.5 A 250 V Slow Blow

- 5** Align the white arrow on top of the fuse holder with the white arrow on the power selector cover. All three arrows should point in the same direction. Push the fuse holder into the top slot of the power selector.
- 6** Close the power selector by pushing firmly on the power selector cover.
- 7** Check that the correct line voltage appears through the power selector cover.

To connect the analyzer to a LAN

Analyzers with option UFG, 4 megabyte extended RAM and additional I/O, have a ThinLAN and AUI (attachment unit interface) port for connecting the analyzer to the LAN (local area network).

- 1** Set the IF section's power switch to off (**O**).
- 2** Connect the ThinLAN BNC cable to the ThinLAN port or the appropriate media access unit (MAU) to the AUI port.
- 3** Set the IF section's power switch to on (**I**).
- 4** Press the following keys:

[**Local/Setup**]

[LAN setup]

[LAN port setup]

[port select **ThinLAN (BNC)**] OR [port select **AUI (MAU)**]

[IP address]

internet protocol address

[enter]

[**Return**]

[LAN power-on **active**]

See your LAN system administrator for the internet protocol address. Your LAN system administrator can also tell you if you need to set the gateway address or subnet mask.

To connect the analyzer to a serial device

The IF section's Serial 1 port is a 9-pin, EIA-574 port that can interface with a printer or plotter. The total allowable transmission path length is 15 meters.

- Connect the IF section's SERIAL 1 port to a printer or plotter using a 9-pin female to 25-pin RS-232-C cable.

Part Number	Cable Description
Agilent 24542G	9-pin female EIA-574 to 25-pin male RS-232
HP 24542H	9-pin female EIA-574 to 25-pin female RS-232

To connect the analyzer to a parallel device

The IF section's Parallel Port is a 25-pin, Centronics port. The Parallel Port can interface with PCL printers or HP-GL plotters.

- Connect the IF section's rear panel PARALLEL PORT connector to a plotter or printer using a Centronics interface cable.

To connect the analyzer to an GPIB device

The analyzer is compatible with the General Purpose Interface Bus (GPIB). Total allowable transmission path length is 2 meters times the number of devices or 20 meters, whichever is less. Operating distances can be extended using an GPIB Extender.

Analyzers with option UFG, 4 megabytes extended RAM and additional I/O, have an additional GPIB connector. The additional GPIB connector, SYSTEM INTERCONNECT, is only for connecting to the spectrum analyzer that is used with the Agilent 89411A 21.4 MHz Down Converter.

- Connect the analyzer's rear panel GPIB connector to an GPIB device using an GPIB interface cable.

Caution

The analyzer contains metric threaded GPIB cable mounting studs as opposed to English threads. Use only metric threaded GPIB cable lock screws to secure the cable to the analyzer. Metric threaded fasteners are black, while English threaded fasteners are silver.

For GPIB programming information, see the *Agilent 89400 GPIB Series Command Reference*.

To connect the analyzer to an external monitor

The External Monitor connector is a 15-pin connector with standard VGA pinout. The External Monitor connector can interface with an external, multi-scanning monitor. The monitor must have a 25.5 kHz horizontal scan rate, a 60 Hz vertical refresh rate, and must conform to EIA-343-A standards.

- **Connect the analyzer's rear panel EXTERNAL MONITOR connector to an external monitor using an appropriate cable.**
For additional information, see "EXTERNAL MONITOR connector" in the analyzer's online help.

To connect the optional keyboard

The analyzer may be connected to an optional external keyboard. The keyboard remains active *even when the analyzer is not in alpha entry mode*. This means that you can operate the analyzer using the external keyboard rather than the front panel. Pressing the appropriate keyboard key does the same thing as pressing a hardkey or a softkey on the analyzer's front panel.

- 1 Set the IF section's power switch to on (I).
- 2 Connect the round plug on the keyboard cable to the KEYBOARD connector on the analyzer's front panel. Make sure to align the plug with the connector pins.

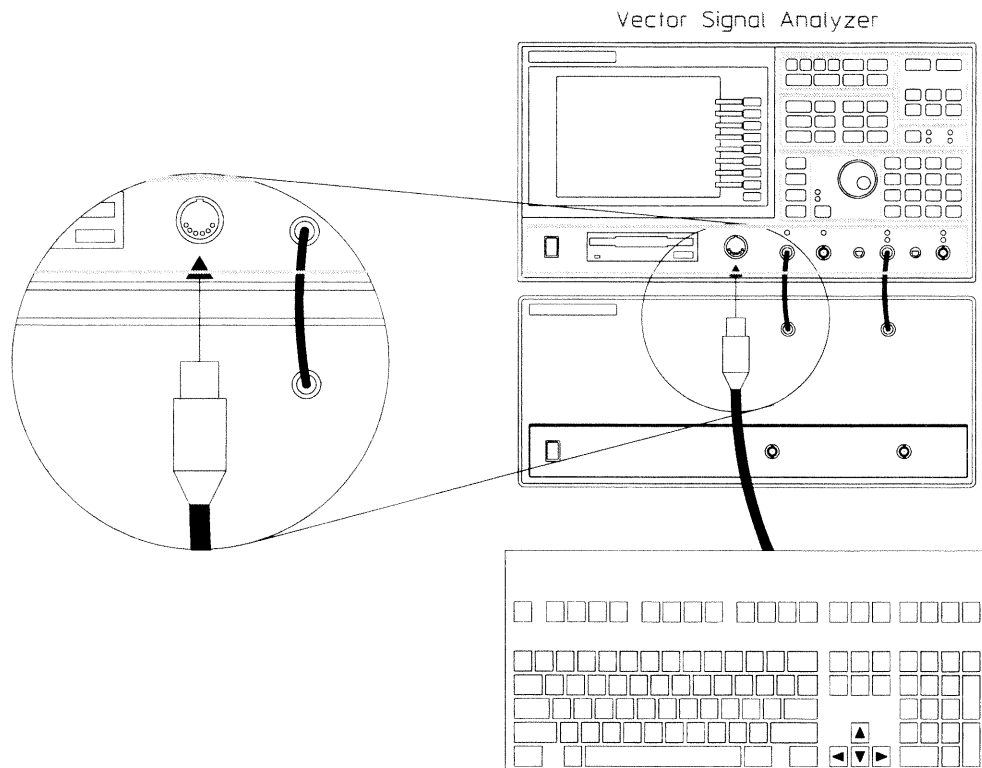

- 3 Connect the other end of the keyboard cable to the keyboard.

Caution

In addition to the U.S. English keyboard, the Agilent 89441A DC-2650 MHz Vector Signal Analyzer supports U.K. English, German, French, Italian, Spanish, and Swedish. Use only the Agilent Technologies approved keyboard for this product. Agilent Technologies does not warrant damage or performance loss caused by a non-approved keyboard. See the beginning of this guide for part numbers of approved Agilent Technologies keyboards.

- 4** To configure your analyzer for a keyboard other than U.S. English, press **[System Utility]** [keyboard type]. Then press the appropriate softkey to select the language.

Configuring your analyzer to use a keyboard other than U.S. English only ensures that the analyzer recognizes the proper keys for that particular keyboard. Configuring your analyzer to use another keyboard *does not* localize the on-screen annotation or the analyzer's online HELP facility.

To connect the optional minimum loss pad

The minimum loss pad (option 1D7) provides a 50 ohm matched impedance to the Agilent 89441A and a 75 Ω matched impedance to the device under test.

- 1** Connect the minimum loss pad to the RF section's INPUT or SOURCE connector.
- 2** Connect a 75 Ω cable between the minimum loss pad and the device under test. Use either a 75 Ω type-N cable or the supplied 75 Ω type-N(m)-to-BNC(f) adapter and a 75 Ω BNC cable.

Caution

Do NOT connect a 50 Ω cable or adapter to the 75 Ω minimum loss pad. The center pin is larger in a 50 Ω type-N connector than in a 75 Ω type-N connector. Connecting a 50 Ω type-N connector to the 75 Ω minimum loss pad will damage the 75 Ω minimum loss pad.

To clean the screen

The analyzer screen is covered with a plastic diffuser screen (this is not removable by the operator). Under normal operating conditions, the only cleaning required will be an occasional dusting. However, if a foreign material adheres itself to the screen, do the following:

- 1** Set the IF section's power switch to off (**O**).
- 2** Remove the power cord.
- 3** Dampen a soft, lint-free cloth with a mild detergent mixed in water.
- 4** Carefully wipe the screen.

Caution

Do not apply any water mixture directly to the screen or allow moisture to go behind the front panel. Moisture behind the front panel will severely damage the instrument.

To prevent damage to the screen, do not use cleaning solutions other than the above.

To store the analyzer

- Store the analyzer in a clean, dry, and static free environment. For other requirements, see environmental specifications in the *Agilent 89441A Technical Data* publication.

To transport the analyzer

- Disconnect the IF section from the RF section and package each section using the original factory packaging or packaging identical to the factory packaging. Containers and materials identical to those used in factory packaging are available through Agilent Technologies offices.
- If returning the analyzer to Agilent Technologies for service, attach a tag to each container describing the following:
 - Type of service required
 - Return address
 - Model number
 - Full serial numberIn any correspondence, refer to the analyzer by model number and both serial numbers.
- Mark the containers **FRAGILE** to ensure careful handling.
- If necessary to package the analyzer in containers other than original packaging, observe the following (use of other packaging is not recommended):
 - Wrap each section in heavy paper or anti-static plastic.
 - Protect the front panels with cardboard.
 - Use double-wall cartons made of at least 350-pound test material.
 - Cushion each section to prevent damage.

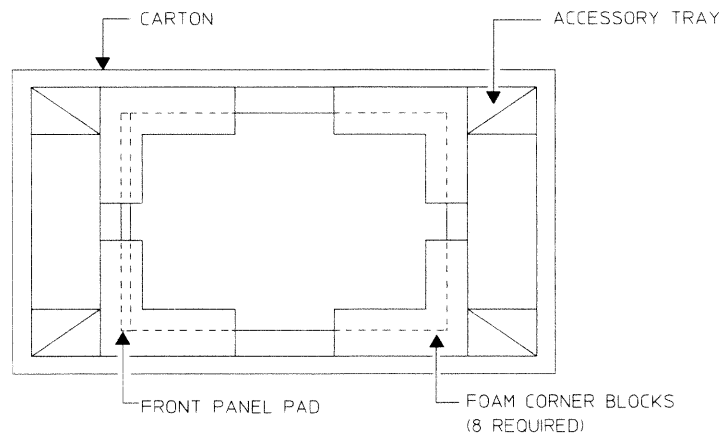

Caution

Do not use styrene pellets in any shape as packing material for the analyzer. The pellets do not adequately cushion the analyzer and do not prevent the analyzer from shifting in the carton. In addition, the pellets create static electricity which can damage electronic components.

If the IF section will not power up

- Check that the power cord is connected to the IF section and to a live power source.
- Check that the front-panel switch is on (I).
- Check that the voltage selector switch is set properly.
See "To change the IF section's line-voltage switch" on page 1-10.
- Check that the fuse is good.
See "To change the IF section's fuse" on page 1-12.
- Check that the IF section's air circulation is not blocked.
Cooling air enters the IF section through the rear panel and exhausts through both sides. If the IF section's air circulation is blocked, the IF section powers down to prevent damage from excessive temperatures. The IF section remains off until it cools down and its power switch is set to off (O) then to on (I).
- Obtain service, if necessary. See "Need Assistance?" at the end of this guide.

If the RF section will not power up

- Check that the power cord is connected to the RF section and to a live power source.
- Check that the RF section's rear panel line switch and front panel power switch are on (I).
- Check that the voltage selector switch is set properly.
See "To change the RF section's line-voltage switch" on page 1-11.
- Check that the fuse is good.
See "To change the RF section's fuse" on page 1-13.
- Check that the RF section's air circulation is not blocked.
Cooling air enters the RF section through the rear panel and exhausts through both sides. If the RF section's air circulation is blocked, the RF section powers down to prevent damage from excessive temperatures. The RF section turns back on when it cools down.
- Obtain service, if necessary. See "Need Assistance?" at the end of this guide.

If the analyzer's stop frequency is 10 MHz

- Check that the RF section's fan is running.
If the fan is not running, see "If the RF section will not power up."
- Check that the Serial 2 port on the IF section and on the RF section are connected together.
- Press [**Instrument Mode**] and check that the receiver softkey displays "RF section (2-2650 MHz)."
If the receiver softkey does not display "RF section (2-2650 MHz)" press
[receiver]
[RF section (2-2650 MHz)].
- Leaving the RF section on, turn the IF section off (**O**) then on (**I**).
The IF section will not detect the RF section if the RF section was not on before the IF section performs the power-on routine.
- Obtain service, if necessary. See "Need Assistance?" at the end of this guide.

2

Verifying Specifications

Verifying Specifications

This chapter tells you how to use the *Agilent 89441A Auto Performance Test* disk. The performance test disk contains a program that semiautomates the operation verification tests and performance tests.

After you review this chapter, follow the directions in “To load the program” then continue with one of the following:

- “To run the program in semiautomated mode”
- “To run the program without a printer”
- “To run the program in manual mode”

Caution

Before applying line power to the analyzer or testing its electrical performance, see chapter 1, “Preparing the Analyzer for Use.”

Overview

The *Auto Performance Test* disk contains a program (ITM_89441A) and two procedure files (OP_VERIFY and PERFORMAN). ITM_89441A is the test manager program. OP_VERIFY is the operation verification procedure file and PERFORMAN is the performance test procedure file. The procedure files contain an ordered list of tests, and each test contains one or more measurements. Since ITM_89441A reads the procedure files, the disk must remain in the disk drive during testing.

If you do not have a keyboard connected to the analyzer, use the numeric key pad and the alpha keys when the program prompts you to type in information. See the analyzer’s help text for a description of the alpha keys.

If a test fails, contact your local Agilent Technologies sales and service office or have a qualified service technician see chapter 1, “Troubleshooting the Analyzer,” in the *Agilent 89431A Service Guide*.

Features of the Program

- The program can automatically create a printout similar to the test records at the back of this chapter.
- The program can beep when equipment connections need to be changed.
- The program can start the test sequence at any test in the operation verification or performance test list.
- The program can stop after each measurement or alternatively, only if a failure occurs.
- The program can be run in manual mode.

Test Duration

The operation verification tests require approximately four hours to complete in semiautomated mode. The performance tests require approximately five hours to complete in semiautomated mode.

Calibration Cycle

To verify that the Agilent 89441A DC-2650 MHz Vector Signal Analyzer is meeting its published specifications, do the performance tests every 12 months. The RF performance tests check the IF and RF sections together as a single instrument. Therefore, the RF performance tests must be repeated if the RF section is connected to a different IF section.

Recommended Test Equipment

The following table lists the recommended equipment needed to test the performance of the Agilent 89441A DC-2650 MHz Vector Signal Analyzer. Other equipment may be substituted for the recommended model if it meets or exceeds the listed critical specifications. When substitutions are made, you may have to modify the procedures to accommodate the different operating characteristics.

The table also identifies the test equipment that is controlled by this program. If you use a test instrument that is not controlled by the program, the program prompts you to set the instrument state during testing.

Also, if you want the test record to be automatically printed, you need an GPIB printer. If you want the printer to automatically leave top and bottom margins on every page, enable perforation skip mode (see your printer's manual for directions). If you do not have an GPIB printer you must record the results of each test in the test records. These test records may be reproduced without written permission of Agilent Technologies.

Recommended Test Equipment

Instrument	Critical Specifications	Recommended Model
Baseband Spectrum Analyzer	Frequency range 100 Hz to 40 MHz Amplitude range -60 to +15 dBm Dynamic range < -67 dBc Tracking Source @ 0 dBm Impedance 50 Ω and 75 Ω External reference input	HP 3585B† Alternate HP 3585A† HP 3588A† HP 3589A†
Digital Multimeter	10 M Ω range Accuracy $\pm 0.5\%$	HP/Agilent 3458A† Alternate HP 3455A† HP 3456A† HP 3478A†
Frequency Standard	Accuracy ± 0.5 ppm	HP 5061B
Frequency Synthesizer	Frequency range 3 Hz to 10 MHz Amplitude range -36 to +20 dBm Amplitude resolution 0.01 Hz Impedance 50 Ω Harmonic distortion < -30 dBc Spurious < -70 dBc External reference input	HP/Agilent 3325B† Alternate HP 3325A† HP 3326A†
Milliwatt Power Meter	Range ± 0.2 dBm	
Accuracy ± 0.0625 dB	W&G EPM-1‡	
Power Meter	Accuracy ± 0.125 dB	HP 438A† Alternate (2) HP 436A†
Power Sensor	Frequency range 2 to 2650 MHz Compatible with power meter	(2) HP/Agilent 8482A
Signal Generator	Frequency range 2 MHz to 2.56 GHz Amplitude range -30 to +20 dBm Impedance 50 Ω Spurious < -82 dBc External reference input SSB phase noise @ 640 MHz 100 Hz offset < -108 dBc/Hz 1kHz offset < -116dBc/Hz 10 & 100 kHz offset < -128 dBc/Hz	HP/Agilent 8663A†

† Program controlled test equipment.

‡ Wandel & Goltermann Inc., 1800 Wyatt Drive, Suite 2, Santa Clara, CA 95054 U.S.A. (408) 988-7622

Recommended Test Equipment (continued)

Instrument	Critical Specifications	Recommended Model
1 dB step attenuator (with cal data @ 10 MHz)	Range 0 to 8 dB Accuracy ± 0.03 dB	HP/Agilent 8494G [‡] Alternate HP/Agilent 355C HP/Agilent 8494A/B HP/Agilent 8494H [‡]
10 dB step attenuator (with cal data @ 10 MHz)	Range 0 to 70 dB Accuracy ± 0.03 dB	HP/Agilent 8495G [‡] Alternate HP/Agilent 355D HP/Agilent 8495A/B HP/Agilent 8495H [‡] HP/Agilent 8496A/B HP/Agilent 8496G/H [‡]
50 Ω Directional Bridge	Frequency range 100 kHz to 10 MHz Directivity > 40 dB	HP/Agilent 35677-63502 Alternate HP/Agilent 8721A ^{††}
75 Ω Directional Bridge	Frequency range 100 kHz to 10 MHz Directivity > 40 dB	HP/Agilent 35677-63504 Alternate HP/Agilent 8721A opt 008 ^{††}
Power Splitter	SWR ≤ 1.10 Impedance 50 Ω Two outputs ports	HP/Agilent 11667A
5 MHz Low Pass Filter	Rejection > 52 dB Impedance 50 Ω	TTE # J87-5M-50-613B [†]
10 MHz Low Pass Filter	Rejection > 52 dB Impedance 50 Ω	TTE # J87-10M-50-613B [†]
200 MHz Low Pass Filter	Rejection > 52 dB Impedance 50 Ω	Daden # LA 200-10NN ^{‡‡}
1000 MHz Low Pass Filter	Rejection > 52 dB Impedance 50 Ω	Daden # LA 1000-10NN ^{‡‡}
1800 MHz Low Pass Filter	Rejection > 52 dB Impedance 50 Ω	HP/Agilent 0955-0491 Alternate Daden # LA 1800-10NN ^{‡‡}
50 Ω Feedthrough Termination (2 required for opt AY7)	Accuracy $\pm 0.2\%$	HP/Agilent 11048C

[†] TEE Inc., 2251 Barry Ave, Los Angeles, CA 90064-1400 U.S.A. (310) 478-8224 FAX (310) 445-2791

[‡] Program controlled test equipment via HP/Agilent 11713A Attenuator/Switch Driver (drives two attenuators).

^{††} This equipment will not meet 4:1 measurement uncertainty.

^{‡‡} Daden Associates Inc., 23011 Moulton Parkway, A-12, Laguna Hills, CA 92653 U.S.A. (714) 366-1522
FAX (714) 366-9600

Recommended Test Equipment (continued)

Instrument	Critical Specifications	Recommended Model
100 k Ω Series Resistor †	Value 100 k Ω Accuracy $\pm 1\%$ Power 0.25 W	HP/Agilent 0757-0465
Cables	(4) 50 Ω BNC 75 Ω BNC (2) 50 Ω Type-N	HP/Agilent 8120-1840 HP 8120-0688 HP 15000C (24 inch) or HP 15000D (60 inch)
Adapters	BNC Tee (3) N(m) to BNC(f) N(f) to BNC(f) BNC(f) to Dual Banana Plug(m) BNC(f) to BNC(f) N(m) to BNC(m) 50 Ω N(m) to BNC(m) 75 Ω (2) SMA(m) to BNC(f)	HP/Agilent 1250-0781 HP/Agilent 1250-0780 HP/Agilent 1250-1536 HP/Agilent 1251-2277 HP/Agilent 1250-0080 HP/Agilent 1250-1473 HP/Agilent 1250-1533 HP/Agilent 1250-1462

† See "Suggested Assembly for Series Resistor."

Suggested Assembly for Series Resistor

The following is a suggested assembly for the 100 k Ω series resistor. The 100 k Ω series resistor is required for the Input Capacitance performance test.

- 1 Cut resistor leads to 12 mm on each end.
- 2 Solder one resistor lead to the center conductor of the BNC female connector.
- 3 Solder the conductor center pin to the other lead of the resistor.
- 4 Screw the sleeve and the BNC male connector into place. Tighten securely.

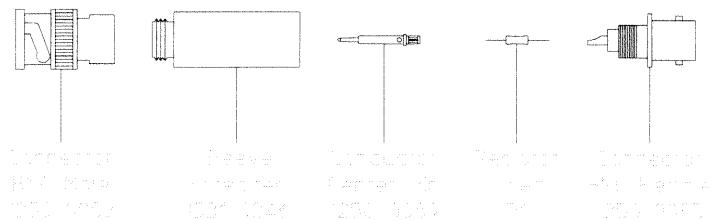

Operation Verification and Performance Tests

The operation verification tests give a high confidence level (>90%) that the Agilent 89441A DC-2650 MHz Vector Signal Analyzer is operating properly and within specifications. The operation verification tests are a subset of the performance tests. The operation verification tests should be used for incoming and after-repair inspections. The performance tests provide the highest level of confidence and are used to verify that the Agilent 89441A DC-2650 MHz Vector Signal Analyzer conforms to its published specifications. Some repairs require a performance test to be done after the repair. The following table lists the operation verification and performance tests.

Operation Verification	Performance Tests
Self Test	Self Test
Amplitude Accuracy	Amplitude Accuracy
Amp_Phase Match	Amplitude Linearity
Input Coupling	Amp_Phase Match
Input Trigger	Intermodulation Distortion
External Trigger	Input Coupling
External Arm	Input Trigger
Harmonic Distortion	External Trigger
DC Offset	External Arm
Spurious Signals	Harmonic Distortion
Noise	Input Capacitance
Source Amplitude Accuracy	Input Resistance
Source Distortion	DC Offset
RF-Amplitude Accuracy	Spurious Signals
Phase Noise	Noise
RF-Spurious Signals	Cross Talk
RF-Harmonic Distortion	Anti-Alias Filter
Frequency Accuracy	Source Amplitude Accuracy
RF-Noise	Input Rtn Loss
RF Residuals	Source Rtn Loss
RF-Source Amplitude Accuracy	Source Distortion
RF-Source IF-Flatness	RF-Amplitude Accuracy
RF-Source Spurious	Phase Noise
RF-Source Distortion	LO Spurs
RF-Source Noise	RF-Spurious Signals
	RF-Harmonic Distortion
	Frequency Accuracy
	RF-Noise
	RF Residuals
	RF-Source Amplitude Accuracy
	RF-Source IF-Flatness
	RF-Source Spurious
	RF-Source Distortion
	RF-Source Noise

Specifications and Performance Tests

The specifications are listed in the *Agilent 89441A Technical Data* publication that was shipped with this guide. The following table lists specifications and the performance test or tests that verify each specification.

Specification	Performance Test
RF	
Frequency	
Stability	
Phase noise	Phase Noise
LO spurious sidebands	LO Spurs
Amplitude	
Accuracy	
Absolute full-scale accuracy	RF-Amplitude Accuracy
Dynamic range	
Harmonic distortion	RF-Harmonic Distortion
General spurious	RF-Spurious Signals
Input noise density	RF Noise
Residual responses	RF Residuals
Source	
Amplitude	
Amplitude accuracy	
Absolute accuracy at 6 MHz	RF-Source Amplitude Accuracy
RF frequency response	RF-Source Amplitude Accuracy
IF flatness	RF-Source IF-Flatness
Dynamic range	
Harmonic distortion	RF-Source Distortion
Non-harmonic spurious	RF-Source Spurious
Average noise level	RF-Source Noise

Specification	Performance Test
Baseband	
Frequency	
Frequency accuracy	Frequency Accuracy
Amplitude	
Amplitude accuracy	Amplitude Accuracy
Absolute full-scale accuracy	Amplitude Accuracy
Amplitude linearity	Amplitude Linearity
Residual dc	DC Offset
Dynamic range	
Harmonic distortion	Harmonic Distortion
Intermodulation distortion	Intermodulation Distortion
Residual (spurious) responses	Spurious Signals
Input noise density	Noise
Crosstalk	Cross Talk
Alias responses	Anti-Alias Filter
Input port	
Coupling	Input Coupling
Impedance	Input Capacitance
Impedance	Input Resistance
Return loss	Input Rtn Loss
Two-channel	
Channel match	Amp Phase Match
Trigger	
Input channel trigger	Input Trigger
External trigger	External Trigger
External arm	External Arm
Source	
Amplitude	
Amplitude accuracy	Source Amplitude Accuracy
Harmonic and other spurious products	Source Distortion
Source port	
Return loss	Source Rtn Loss

To load the program

For information about the program's softkeys, see the menu descriptions near the end of this chapter.

- 1 Set the Agilent 89441A DC-2650 MHz Vector Signal Analyzer's power switch for the IF section to off (**O**), then connect the analyzer, test instruments, and printer using GPIB cables.
- 2 Insert the *Agilent 89441A Auto Performance Test* disk into the analyzer's disk drive, then set the IF section's power switch to on (**I**).
The RF section must be on before the IF section is turned on.
- 3 If you have the optional PC Style Keyboard, connect the keyboard to the analyzer using the keyboard cable (see "To connect the optional keyboard" in chapter 1).
- 4 After the analyzer finishes its power-up calibration routine, press the following keys:

[Local/Setup]

[system controller]

[System Utility]

[memory usage]

[configure meas memory]

[max freq pts]

1601

[enter]

[num math temp]

6

[enter]

[Return]

[Return]

[more]

[diagnostics]

[performance test]

If you get an insufficient memory message, press the following keys then return to the procedure:

[System Utilities]

[memory usage]

[remove RAM disk]

[confirm remove]

If you get a wrong disk message after you press the performance test softkey, check that the correct disk is installed and that the analyzer is properly configured (see "If the analyzer's stop frequency is 10 MHz" at the end of chapter 1).

- 5 Now go to one of the following procedures to continue:
 - "To run the program in semiautomated mode"
 - "To run the program without a printer"
 - "To run the program in manual mode"

To run the program in semiautomated mode

You must have an GPIB printer connected to your system to run the program in semiautomated mode. If you do not have a printer, see “To run the program without a printer” later in this chapter.

- 1** Press the following keys and when the program prompts you, type in the information for the title page of the test record and press [enter]:

[TITLE PAGE]
[TEST FACILITY]
[FACILITY ADDRESS]
[TESTED BY]
[REPORT NUMBER]
[CUSTOMER]
[MORE]
[TEMP]
[HUMIDITY]
[LINE FREQUENCY]
[RETURN]

- 2** Press the following keys and when the program prompts you, type in the equipment configuration information:

[EQUIP CONFIG]
[SYNTHESIZER]
[BASEBAND ANALYZER]
[MULTIMETER]
[MORE]
[STEP_ATT 1DB]
[STEP_ATT 10DB]
[SIGNAL GENERATOR]
[mW-POWER METER]
[MORE]
[POWER METER #1]
[POWER METER #2]
[POWER SENSOR #1]
[POWER SENSOR #2]
[RETURN]

The GPIB address is $100 \times (\text{interface select code}) + (\text{primary address})$. The interface select code for the test equipment and printer is 7 (for example, if the primary address is 8, the GPIB address is 708).

When entering the calibration due date, only four characters are displayed on the screen. However, you can enter up to nine characters and they will be printed.

3 Press the following keys and type in the printer address when the program prompts you:

[TEST CONFIG]
[PRINTER ADDRESS]
[PROCEDURE]
[OP_VERIFY] or [PERFORMAN]
[STOP AFTER]
[LIMIT FAILURE] or [NONE]
[RETURN]

4 Press the following keys to start the test:

[START TESTING]
[START BEGINNING]

When you select [START BEGINNING], the data is written to a file on the disk and printed only after all tests are done. When you select [START MIDDLE] or [ONE TEST], the data is printed immediately after each measurement.

5 Follow the directions on the display.

The directions on the display briefly tell you how to connect test equipment. For detailed illustrations of equipment setup, see the setup illustrations starting on page 2-16.

If you want to pause the program and return the Agilent 89441A DC-2650 MHz Vector Signal Analyzer to front panel control, press **[BASIC]**. To continue the program, press **[Display]** [BASIC display format] [lower] **[BASIC]** [continue]. If you changed any instrument setup states, press [RESTART TEST] to ensure accurate measurement results.

To run the program without a printer

Use this procedure if you do not have an GPIB printer connected to your system.

- 1** Write in the information needed on the title page of the "Performance Test Record" or the "Operation Verification Test Record" (located near the back of this chapter).
- 2** Press the following keys and when the program prompts you, type in the model number and GPIB address:

```
[EQUIP CONFIG]
[SYNTHESIZER]
[BASEBAND ANALYZER]
[MULTIMETER]
[MORE]
[STEP_ATT 1DB]
[STEP_ATT 10DB]
[SIGNAL GENERATOR]
[mW POWER METER]
[MORE]
[POWER METER #1]
[POWER METER #2]
[POWER SENSOR #1]
[POWER SENSOR #2]
[RETURN]
```

The GPIB address equals $100 \times (\text{interface select code}) + (\text{primary address})$. The interface select code for the test equipment and printer is 7 (for example, if the primary address is 8, the GPIB address is 708).

- 3** Press the following keys:

```
[TEST CONFIG]
[PROCEDURE]
[OP_VERIFY] or [PERFORMAN]
[STOP AFTER]
[EACH MEASUREMENT]
[RETURN]
```

- 4** Press the following keys to start the test:

```
[START TESTING]
[START BEGINNING]
```

- 5** Now follow the directions on the display and record every measurement result in the "Performance Test Record" or the "Operation Verification Test Record." The directions on the display briefly tell you how to connect test equipment. For detailed illustrations of equipment setup, see the setup illustrations starting on page 2-16.

If you want to pause the program and return the Agilent 89441A DC-2650 MHz Vector Signal Analyzer to front panel control, press **[BASIC]**. To continue the program, press **[Display]** [BASIC display format] [lower] **[BASIC]** [continue]. If you changed any instrument setup states, press **[RESIART TEST]** to ensure accurate measurement results.

To run the program in manual mode

Use this procedure if you want to run the program in manual mode. You will be prompted to set up all test equipment and you can check the analyzer's setup state after each measurement.

- 1** Press the following keys and when the program prompts you, set all GPIB addresses to 0:

[EQUIP CONFIG]
[SYNTHESIZER]
[BASEBAND ANALYZER]
[MULTIMETER]
[MORE]
[STEP_ATT 1DB]
[STEP_ATT 10DB]
[SIGNAL GENERATOR]
[mW-POWER METER]
[MORE]
[POWER METER #1]
[POWER METER #2]
[POWER SENSOR #1]
[POWER SENSOR #2]
[RETURN]

- 2** Press the following keys:

[TEST CONFIG]
[PROCEDURE]
[OP_VERIFY] or [PERFORMAN]
[STOP AFTER]
[EACH MEASUREMENT]
[RETURN]

- 3** Press the following keys to start the test:

[START TESTING]
[START BEGINNING]

- 4** Now follow the directions on the display and record the measurement result in the test record after every measurement.

If you want to view the analyzer's setup state, press [**BASIC**] [**View State**] [measurement state] or [input/source state]. To continue the program, press [**Display**] [BASIC display format] [lower] [**BASIC**] [continue]. If you changed any instrument setup states, press [RESTART TEST] to ensure accurate measurement results.

The directions on the display briefly tell you how to connect test equipment. For detailed illustrations of equipment setup, see the setup illustrations starting on the next page.

To set up the self test

Performance Test and Operation Verification

This test checks the measurement hardware in the Agilent 89441A. No performance tests should be attempted until the analyzer passes this test. This test takes approximately two minutes to complete and requires no external equipment.

1

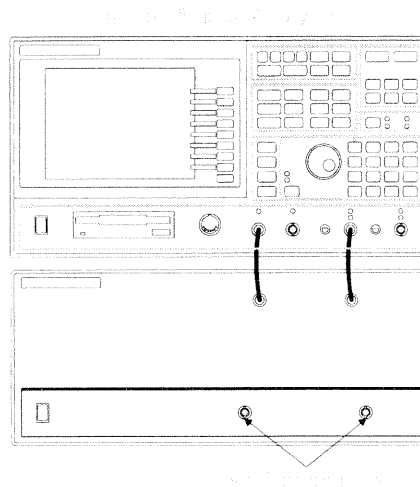

To set up the amplitude accuracy test

Performance Test and Operation Verification

This test verifies that the Agilent 89441A meets its baseband amplitude accuracy specification for absolute full scale accuracy. In this test, the output of the synthesizer is connected to a 1 dB and a 10 dB step attenuator. With the attenuators set to 20 dB, the synthesizer's amplitude is adjusted for a 0 dBm reading on the milliwatt power meter. The output of the attenuators is then connected to the Agilent 89441A, and the attenuators are set for the desired output level. This test checks -30, -18, -6, +6, and +18 dBm at 9.876 MHz and 49.234 kHz in the 50 ohm and 1 Mohm impedance paths. The following lists the attenuator settings for each amplitude:

Amplitude	-30 dBm	-18 dBm	-6 dBm	+6 dBm	+18 dBm
10 dB Step Attenuator	50 dB	30 dB	20 dB	10 dB	0 dB
1 dB Step Attenuator	0 dB	8 dB	6 dB	4 dB	2 dB

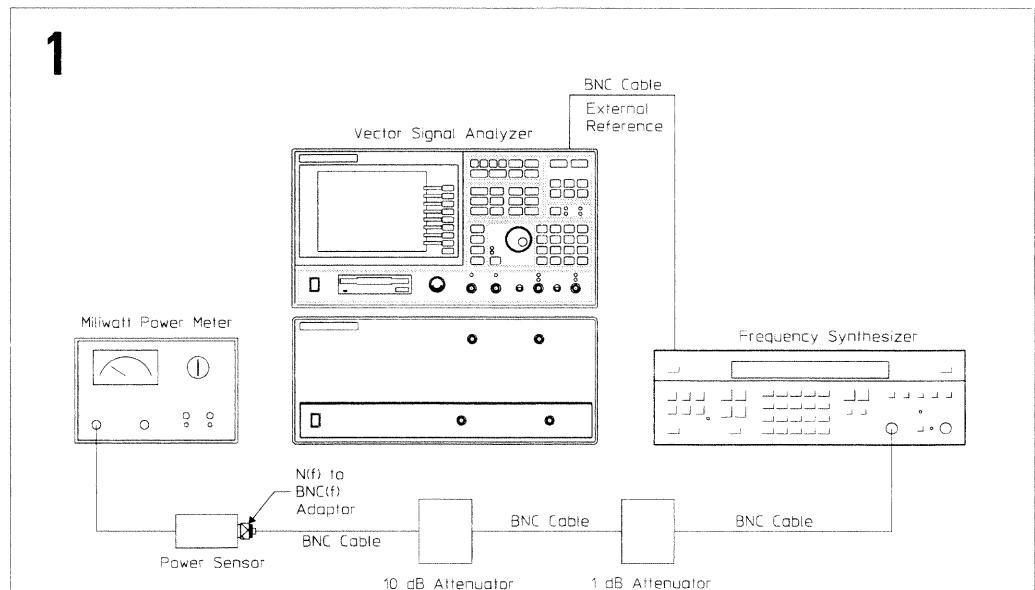

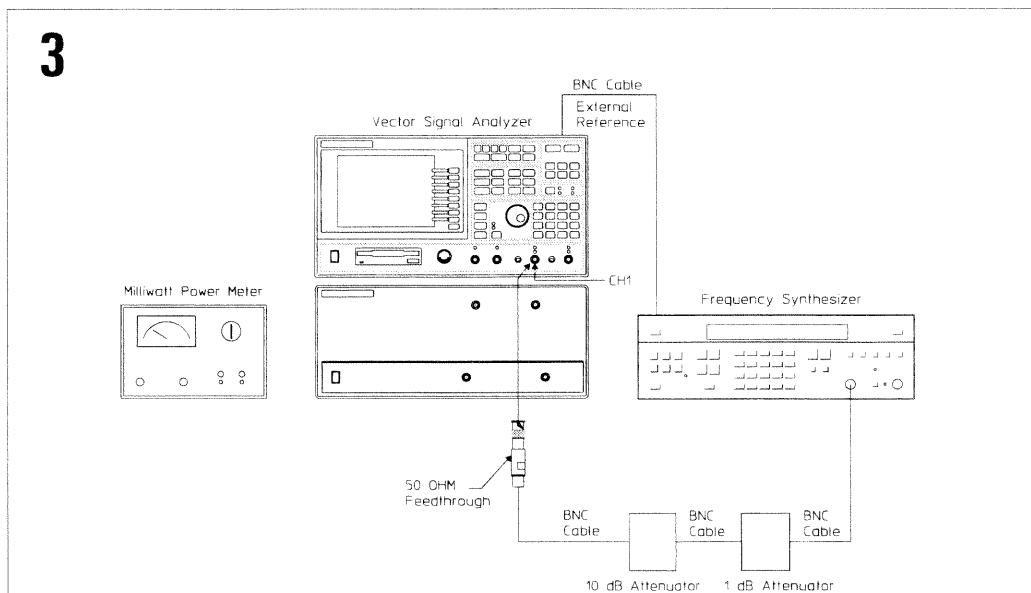
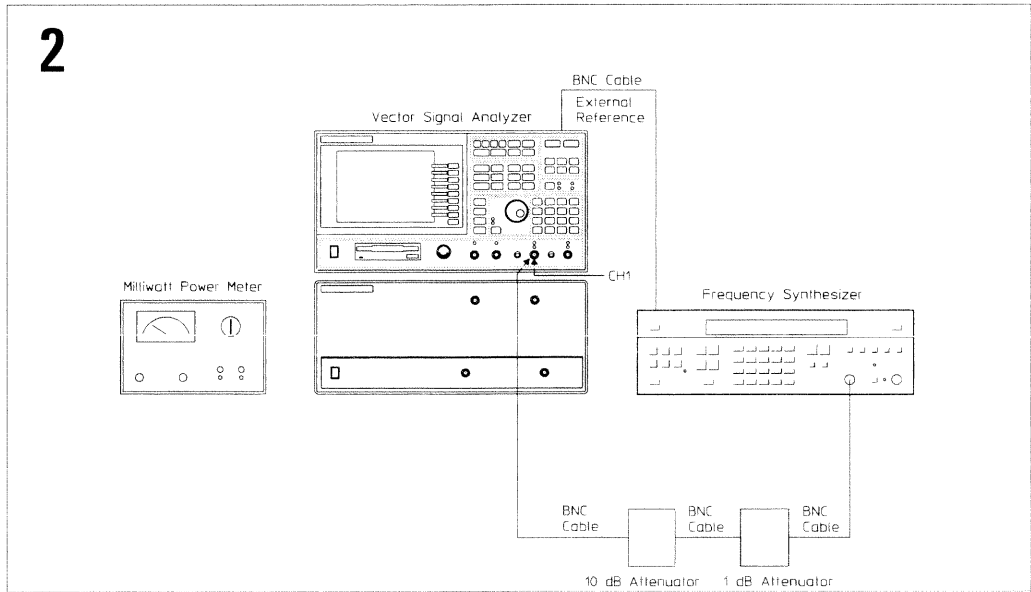

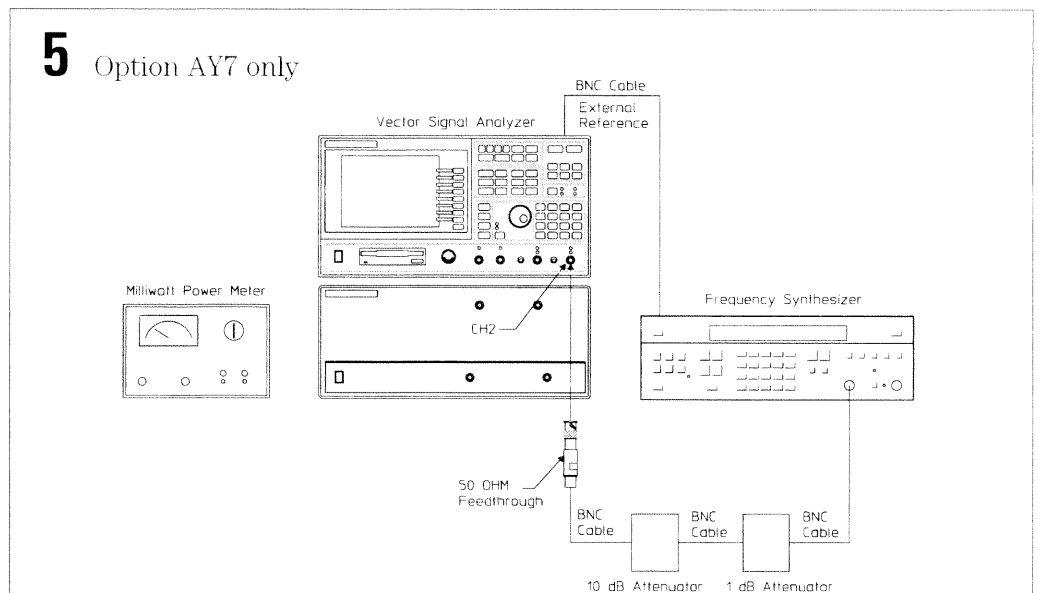
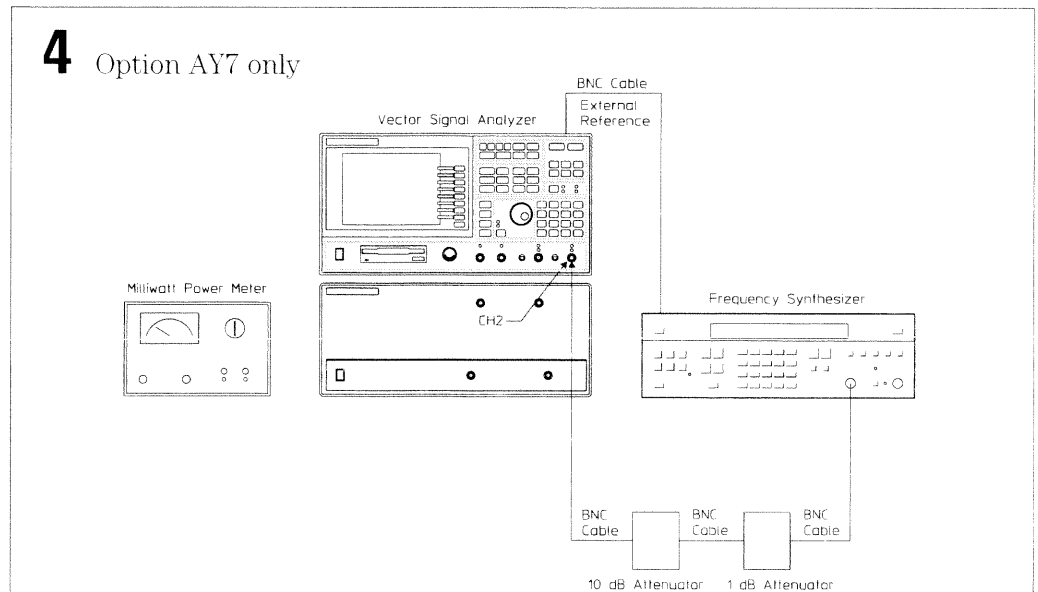

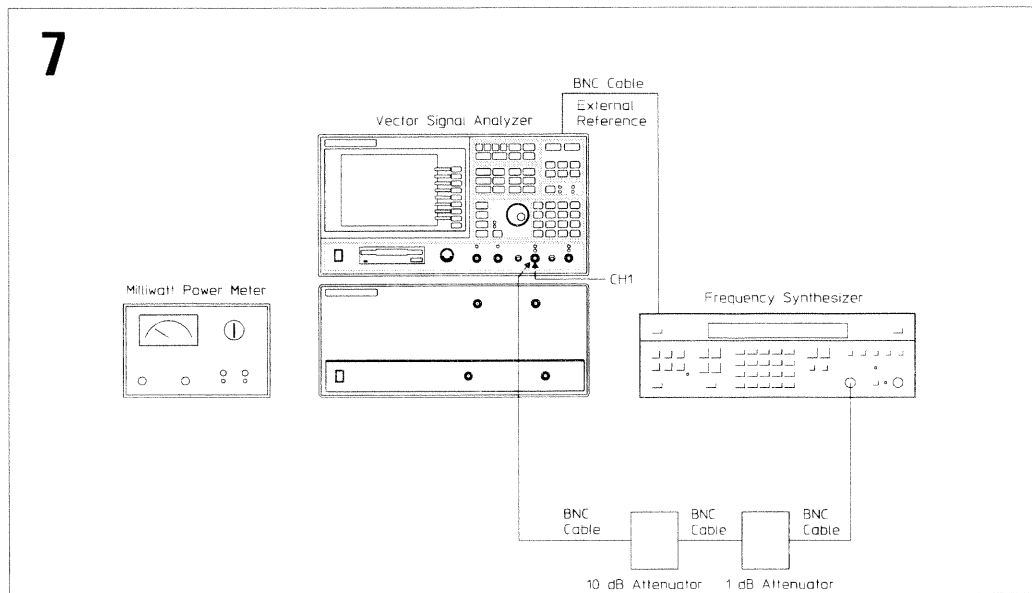
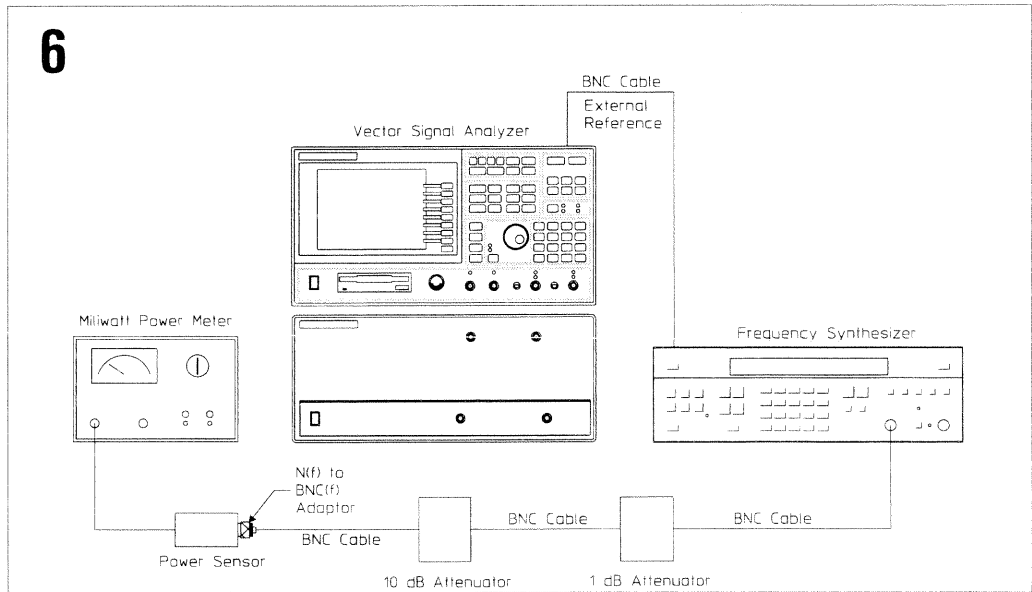

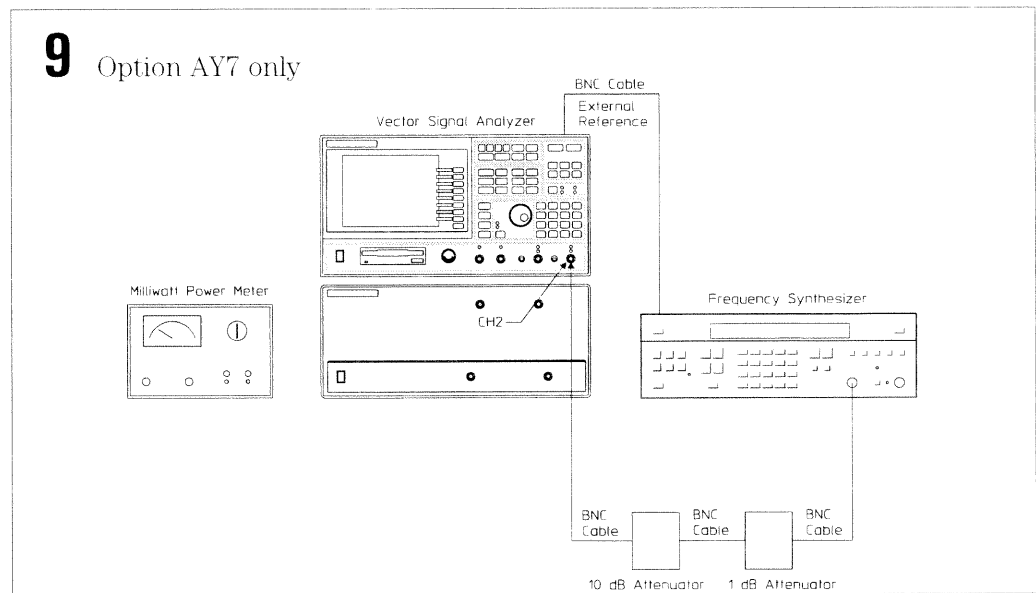
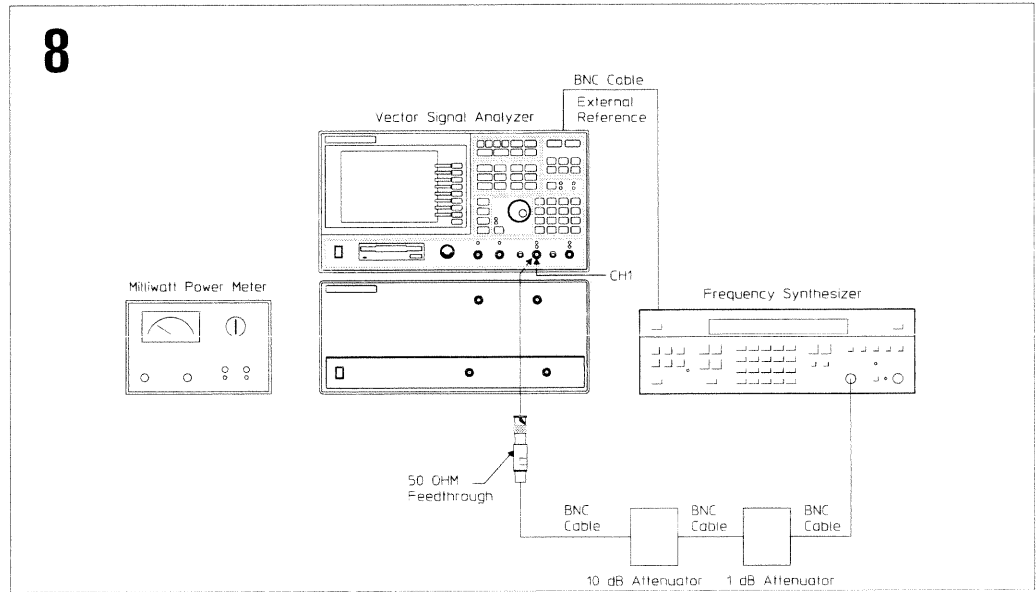

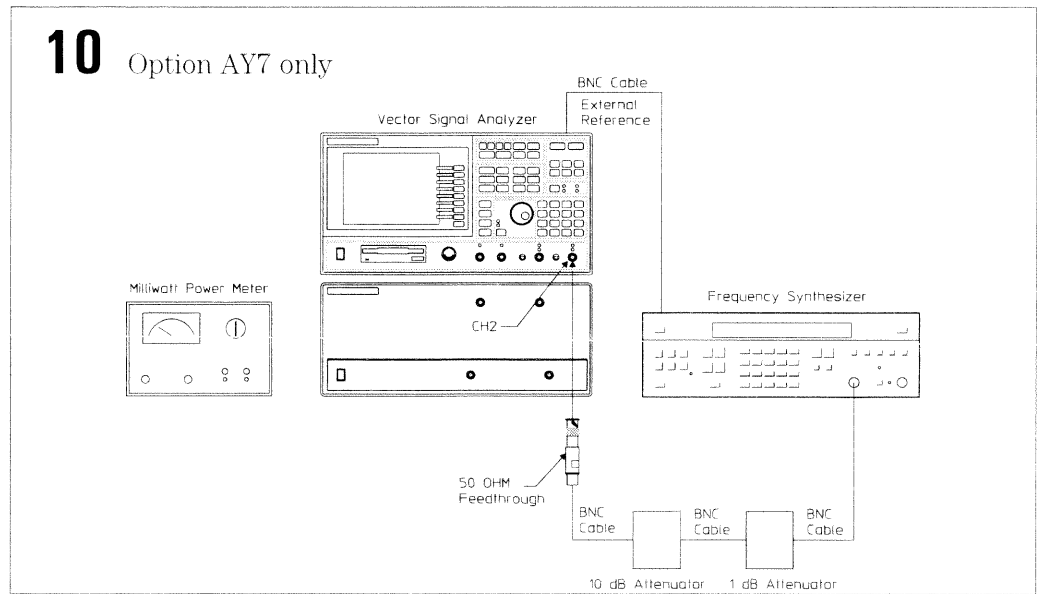

To set up the amplitude linearity test

Performance Test only

This test verifies that the Agilent 89441A meets its baseband amplitude accuracy specification for amplitude linearity. In this test, the IF source is connected to the IF channel 1 or 2 through a 10 dB step attenuator. With the attenuator set to 0 dB, the IF source's output is adjusted for a full scale input. The attenuator is then set to 10 dB and amplitude linearity is checked at -10 dBm. This test checks amplitude linearity at -10 , -20 , -30 , -40 , -50 , -60 and -70 dBm. The source is set to 9.53 MHz, and the 10 dB step attenuator is set to 10, 20, 30, 40, 50, 60 and 70 dB.

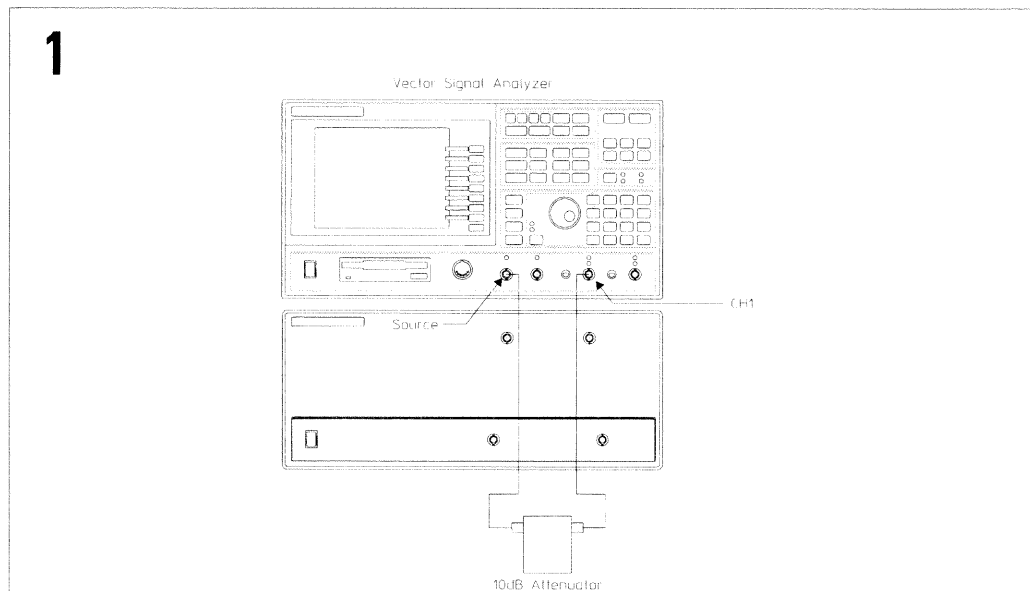

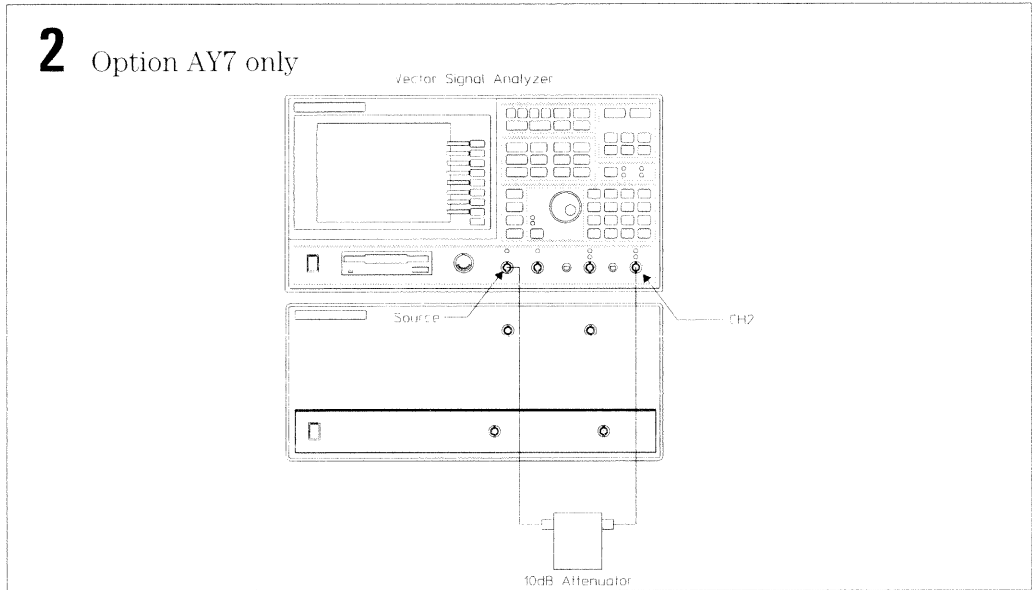

To set up the amp_phase match test

Performance Test and Operation Verification

This test is only for Agilent 89441A's with the optional second channel (option AY7). This test verifies that the Agilent 89441A, option AY7, meets its baseband two-channel specification for channel match. In this test, the Agilent 89441A's source outputs a periodic chirp signal to the power splitter. The power splitter and cables are calibrated by making two measurements and storing the data in the internal data registers. A calibration trace is then computed using the Agilent 89441A's math capabilities. Channel match is then measured using the calibration trace to correct for inaccuracies in the power splitter and cables.

1 Option AY7 only

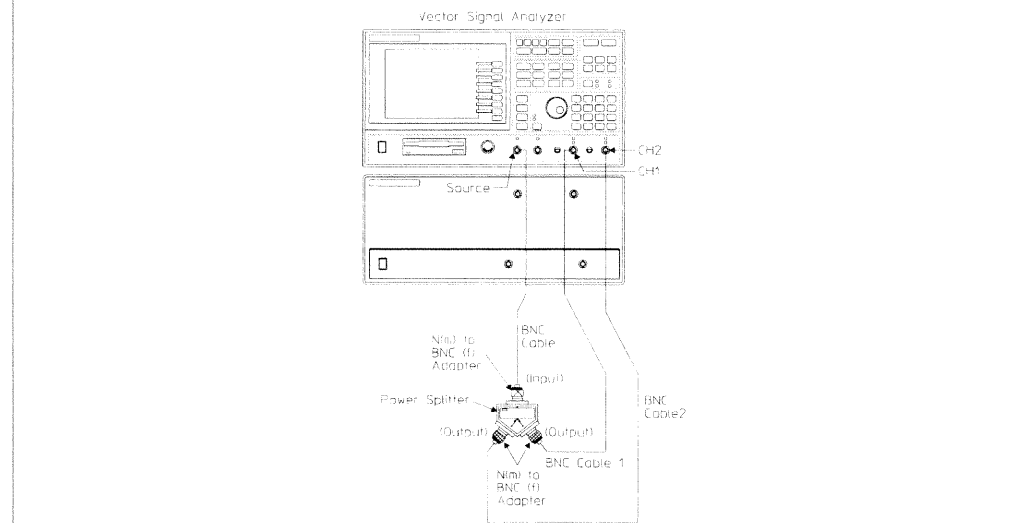

2 Option AY7 only

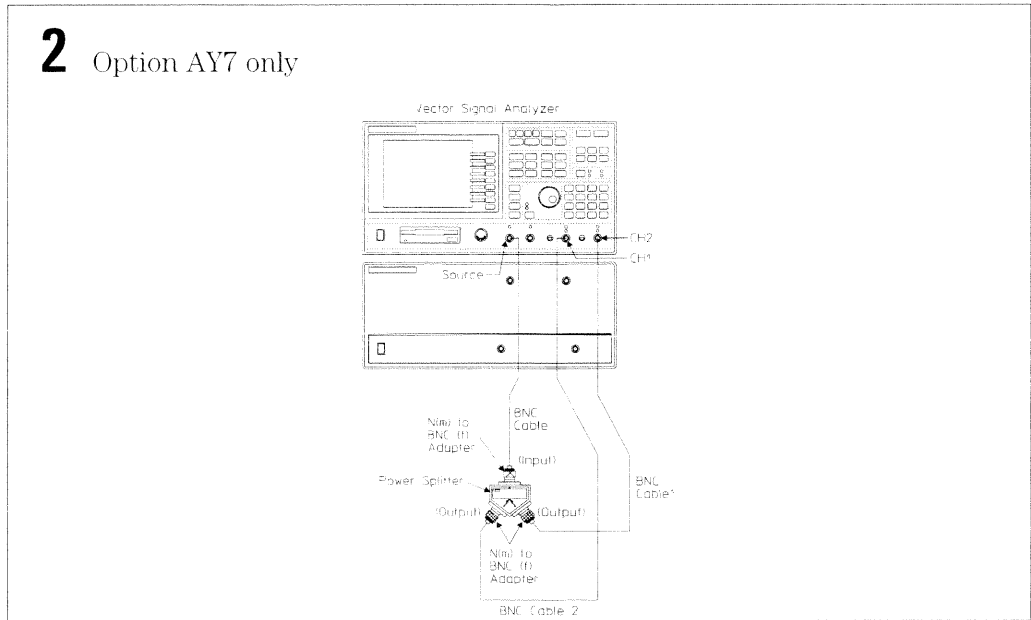

To set up the intermodulation distortion test

Performance Test only

This test verifies that the Agilent 89441A meets its baseband dynamic range specification for intermodulation distortion. In this test, two signals (176.543 kHz and 177.530 kHz) are mixed to provide the Agilent 89441A with a modulated signal. Anytime two signals are mixed, the resultant signal includes the two fundamental frequencies plus their sum and difference frequencies (the sum and difference frequencies are the intermodulation products). The amplitude of each intermodulation product is then measured with the Agilent 89441A. The synthesizer is set to -36 dBm.

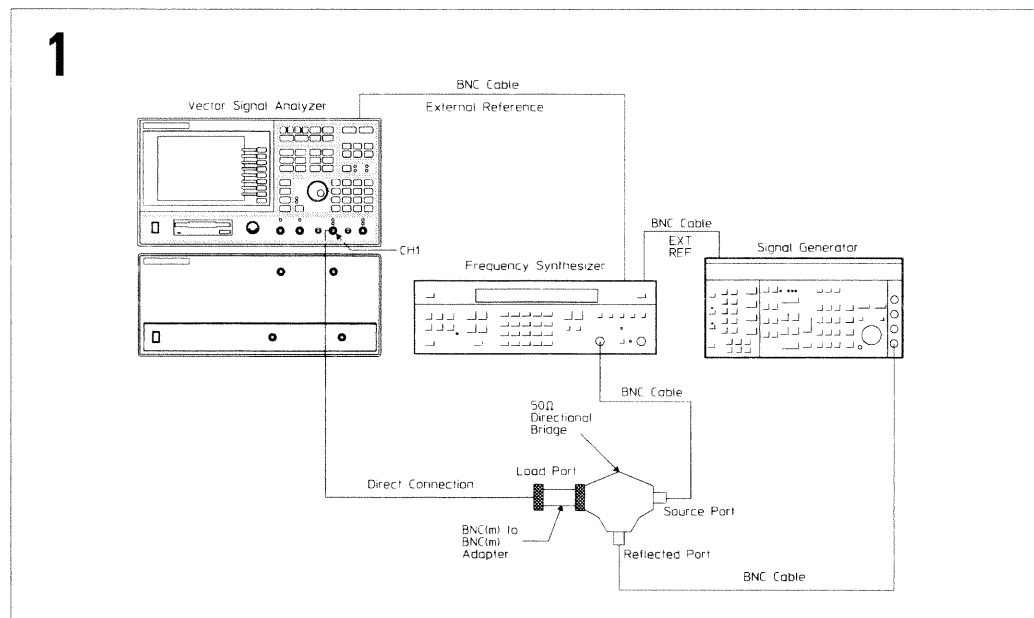

2 Option AY7 only

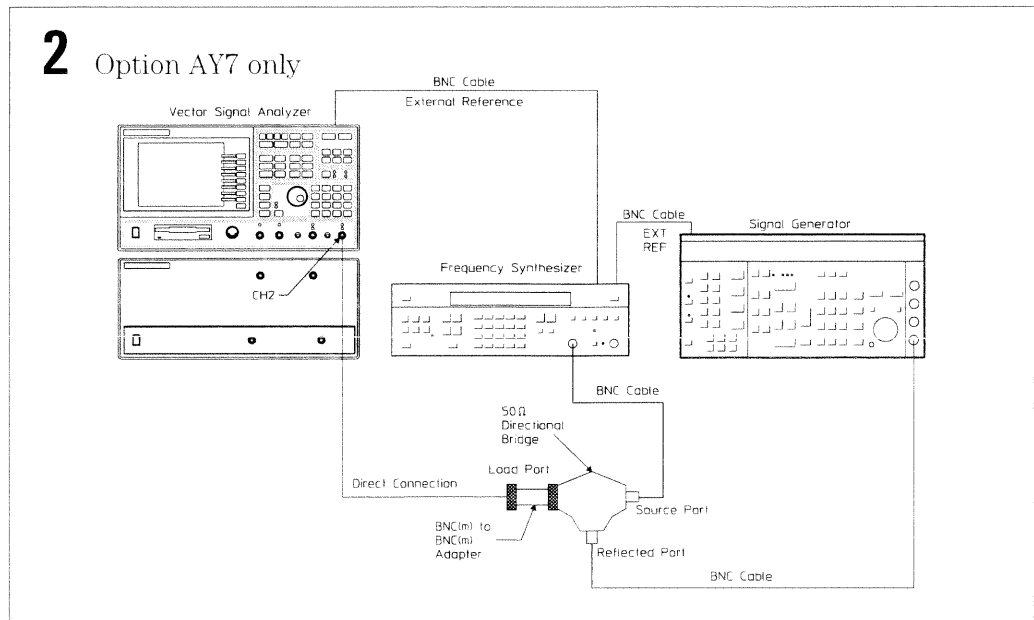

1A Using an HP 3326A

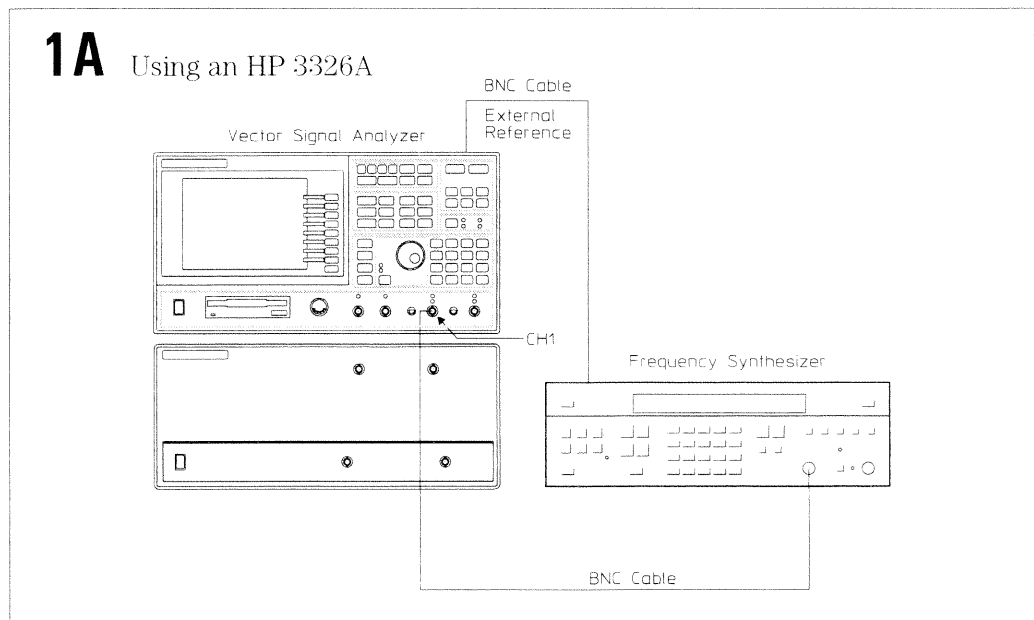

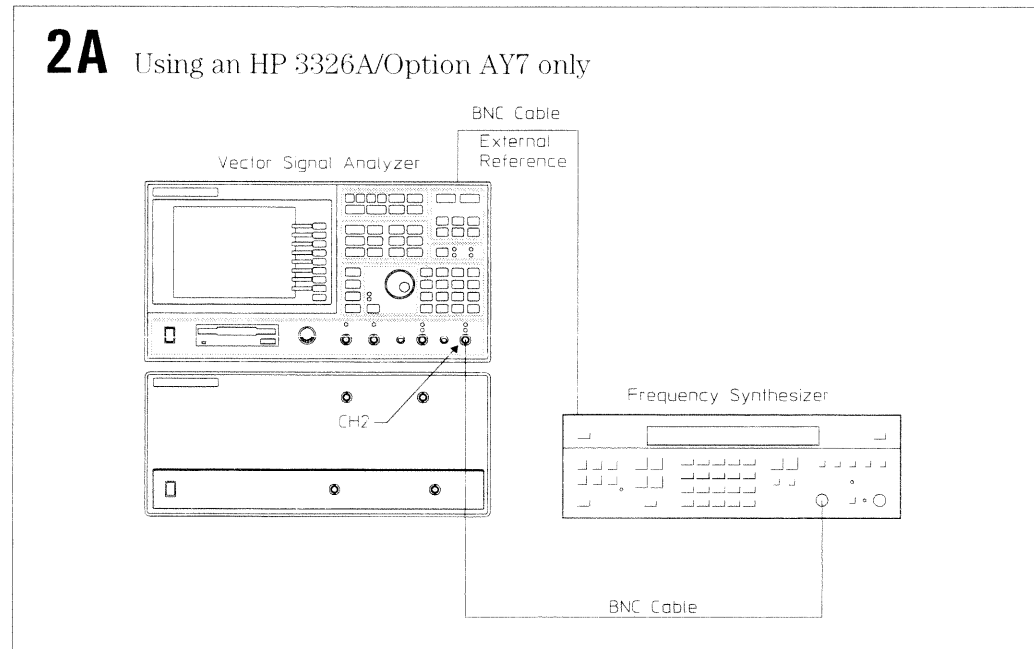

To set up the input coupling test

Performance Test and Operation Verification

This test verifies that the Agilent 89441A meets its baseband input port specification for coupling. In this test, the amplitude of a 3 Hz signal is measured in both ac and dc coupled modes. The values measured determine insertion loss.

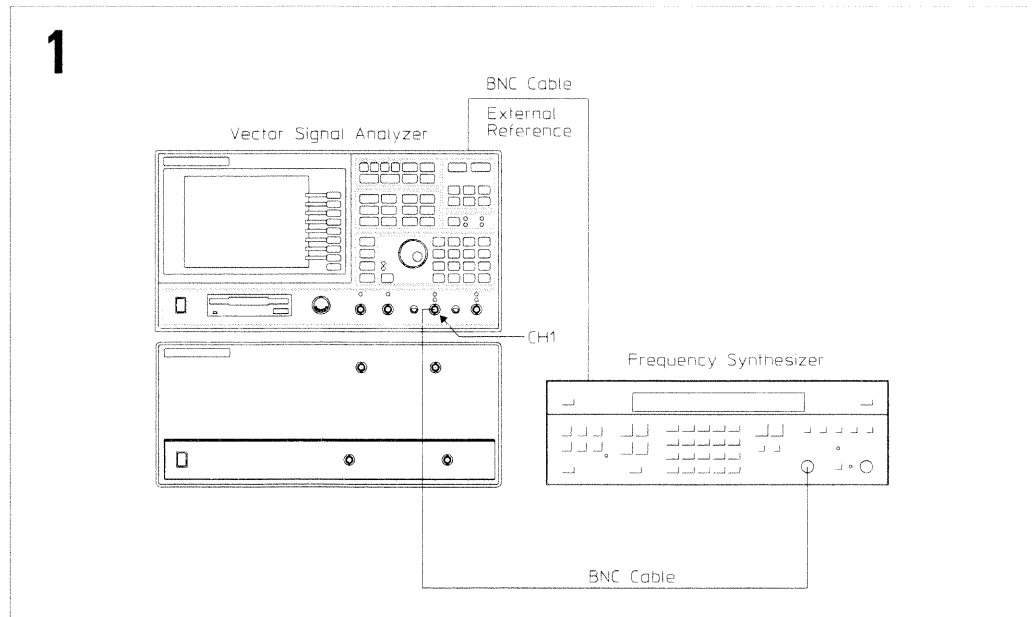

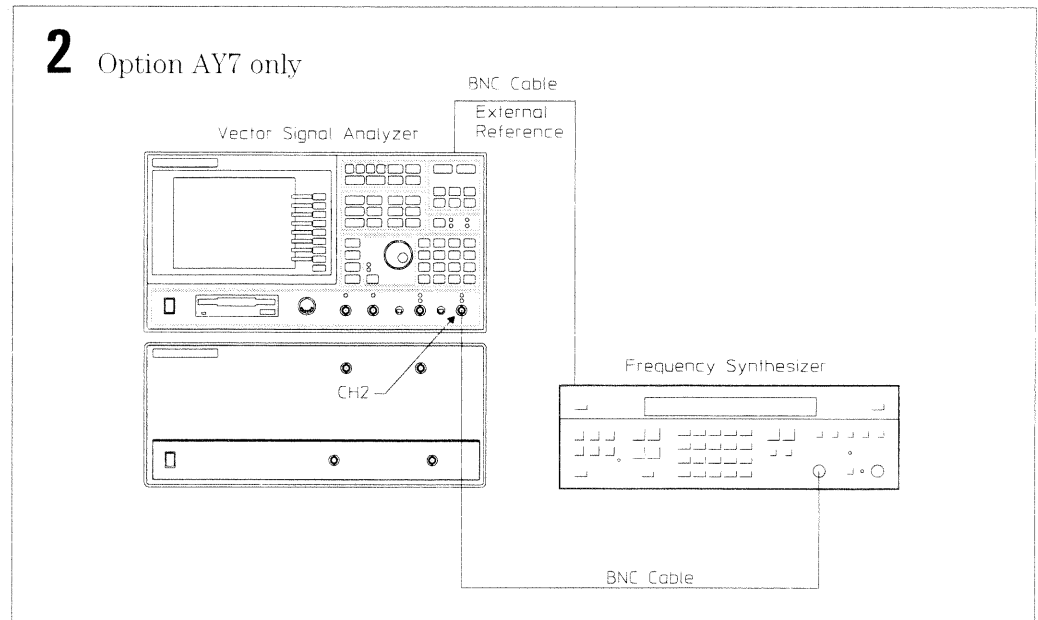

To set up the input trigger test

Performance Test and Operation Verification

This test verifies that the Agilent 89441A meets its baseband trigger specification for input channel trigger. In this test, a signal is connected to the Agilent 89441A. Trigger level and slope are then verified by reading the signal level and slope at 0 seconds in the time record.

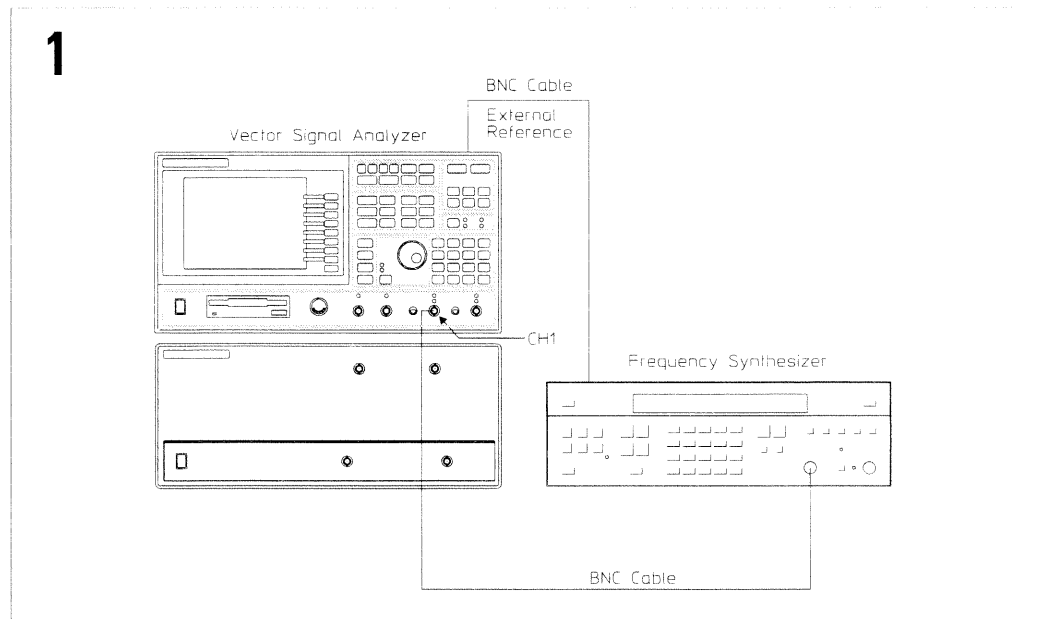

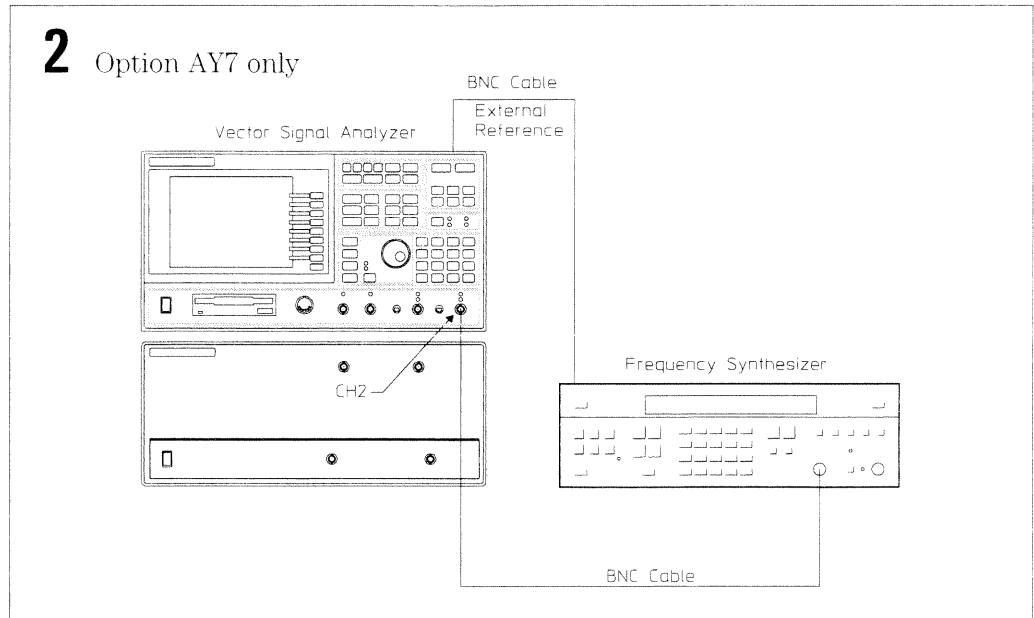

To set up the external trigger test

Performance Test and Operation Verification

This test verifies that the Agilent 89441A meets its baseband trigger specification for external trigger. In this test, a signal is connected to the external trigger input and channel 1. Trigger level and slope are then verified by reading the signal level and slope at 0 seconds in the time record.

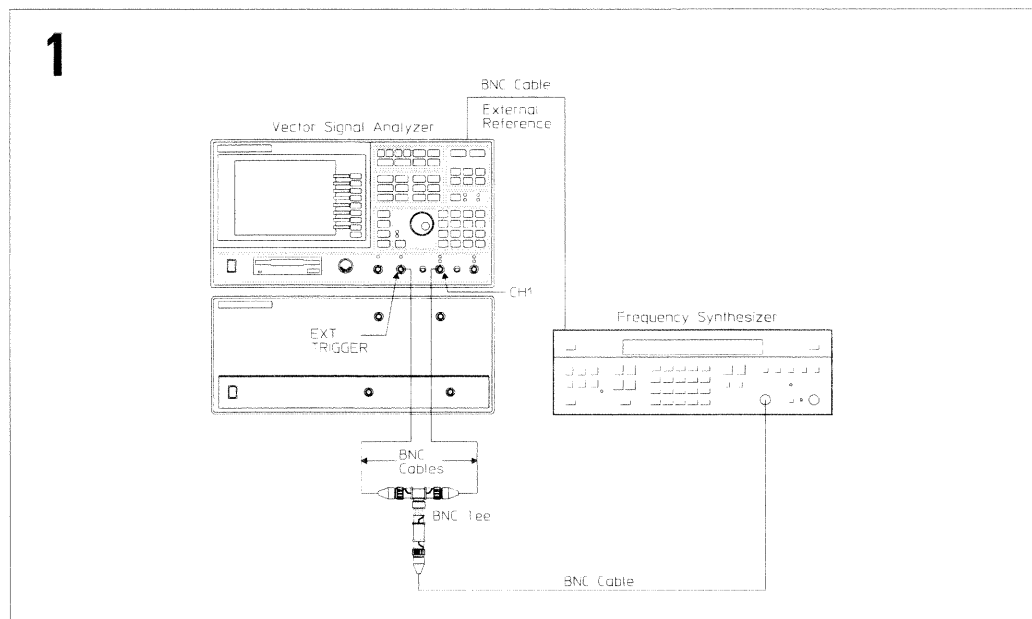

To set up the external arm test

Performance Test and Operation Verification

This test verifies that the Agilent 89441A meets its baseband trigger specification for external arm. In this test, a signal is connected to the external arm input. The signal level is increased until the instrument is armed.

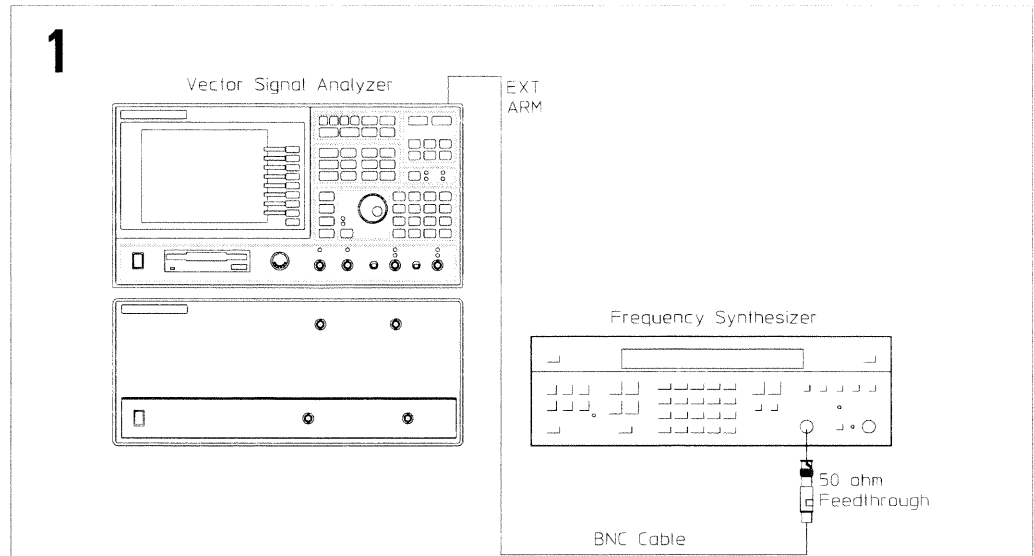

To set up the harmonic distortion test

Performance Test and Operation Verification

This test verifies that the Agilent 89441A meets its baseband dynamic range specification for harmonic distortion. In this test, a low pass filter attenuates the harmonics of a signal from the synthesizer. The analyzer measures the signal and the synthesizer level is adjusted for a full scale input (approximately 2 dBm). The analyzer then measures the second and third harmonics. If the harmonics fall outside the analyzer's frequency range, the analyzer measures the alias frequencies. The synthesizer is set to 9.75 MHz and 3.33 MHz.

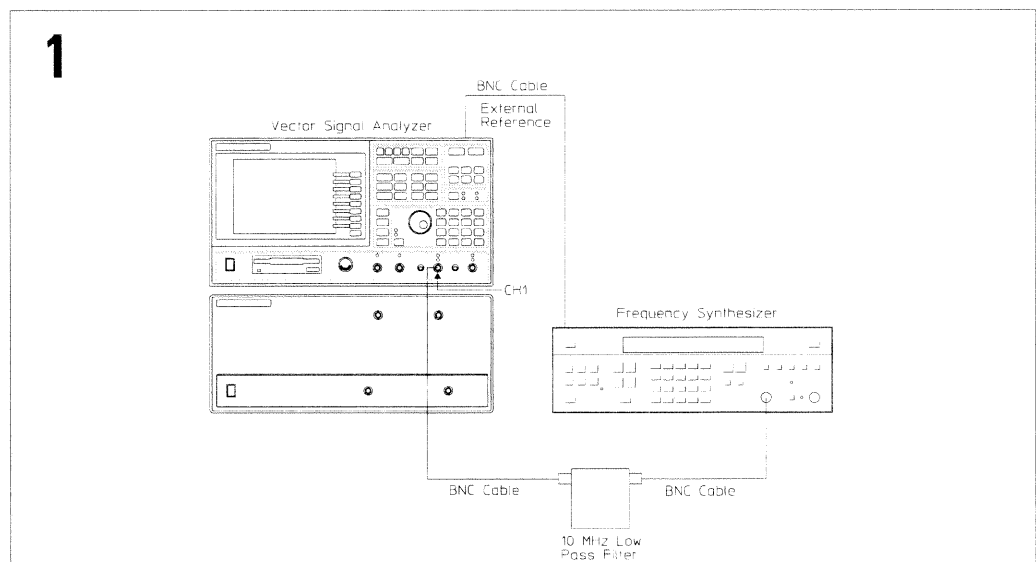

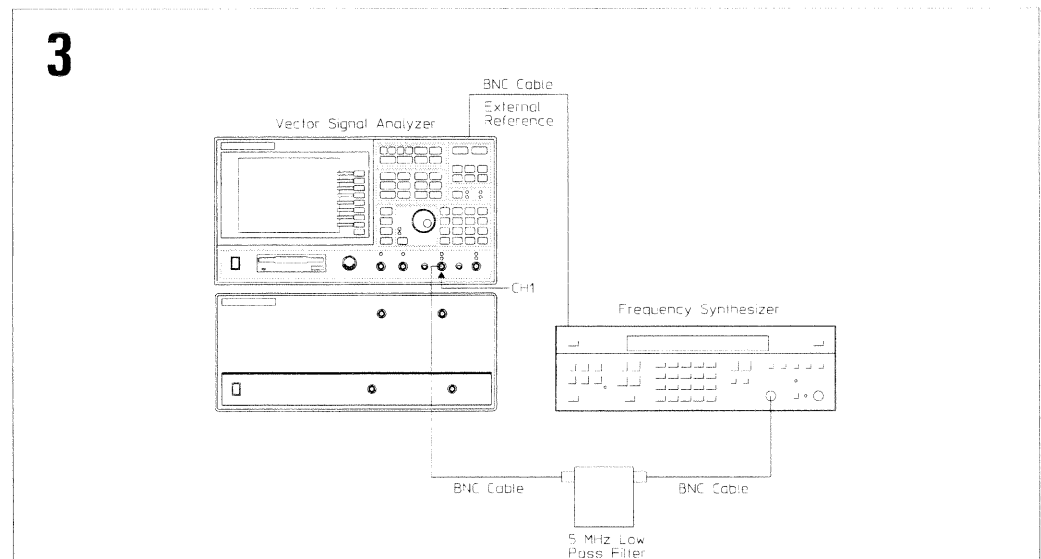
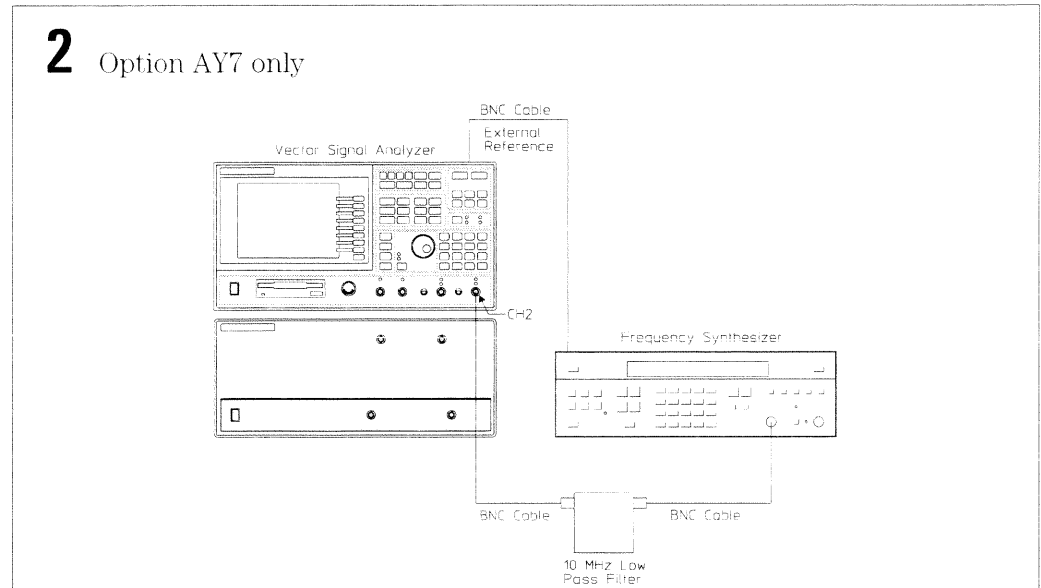

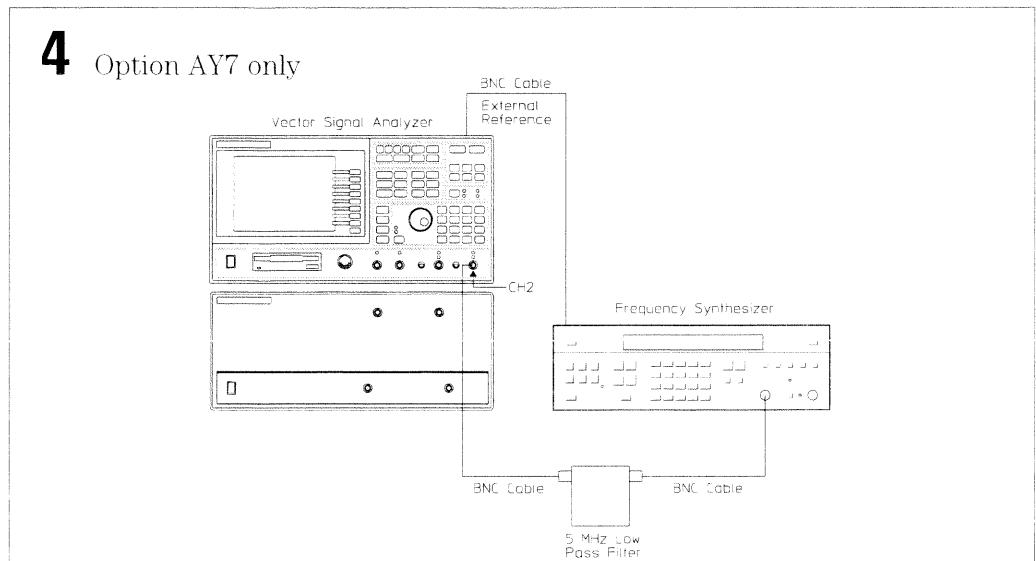

To set up the input capacitance test

Performance Test only

This test verifies that the Agilent 89441A meets its baseband input port specification for impedance. In this test, capacitance is measured using a frequency synthesizer and a 100 k Ω resistor. Capacitance is then calculated using the following formula:

$$C(pf) = C_factor \sqrt{v_{in}^2 / V_c^2 - 1.21} \times 1.0^{12}$$

Where C_factor = 1.59^{-11} at 100 kHz

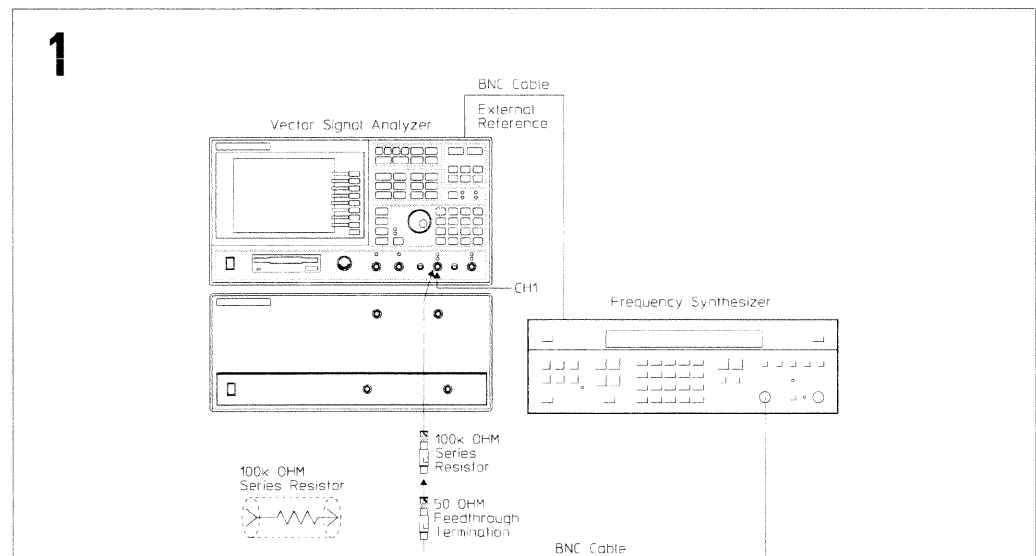

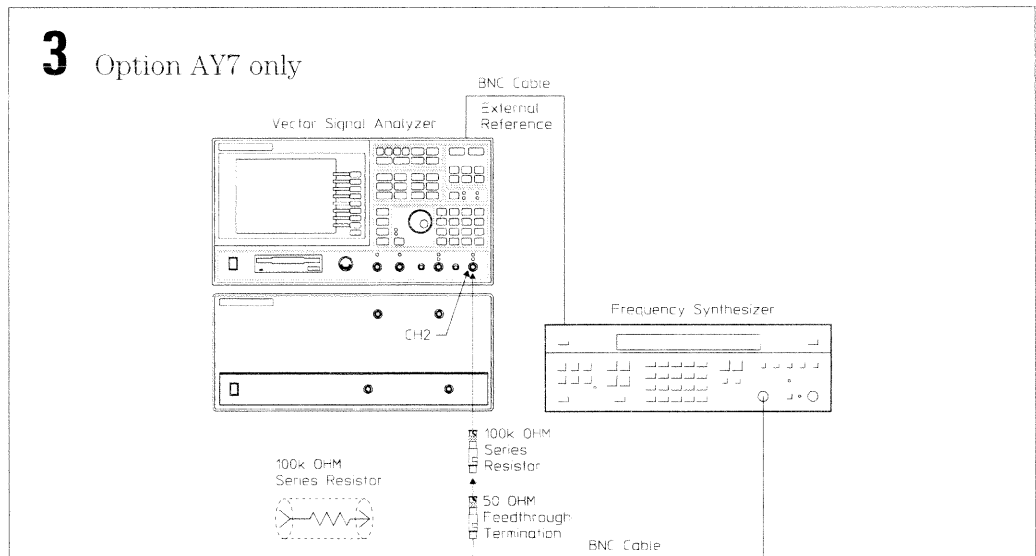
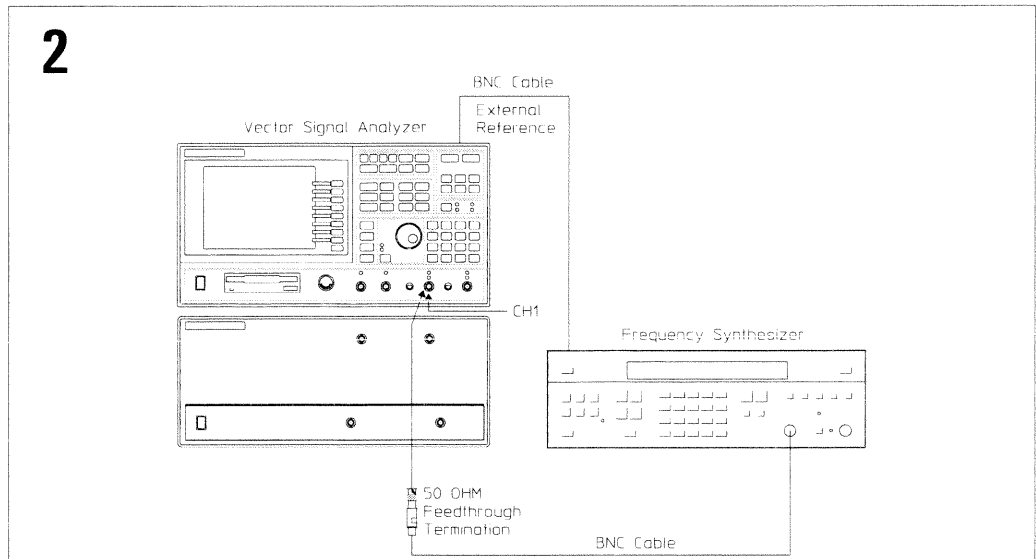

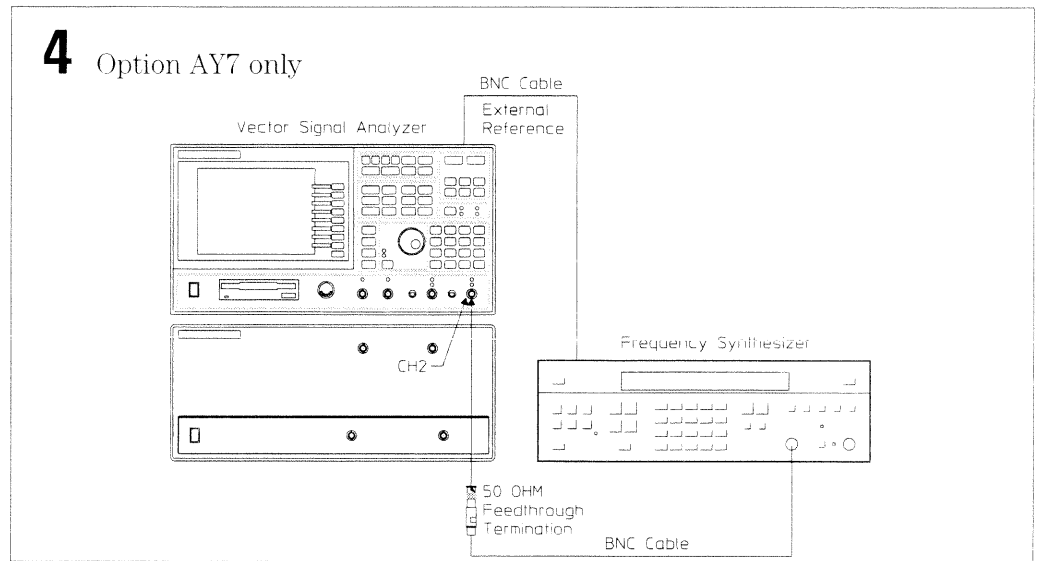

To set up the input resistance test

Performance Test only

This test verifies that the Agilent 89441A meets its baseband input specification for impedance. In this test, input resistance is measured directly using a digital multimeter. The 10 M Ω range is used on the digital multimeter to prevent the current from turning on the overload protection FET in the input circuitry.

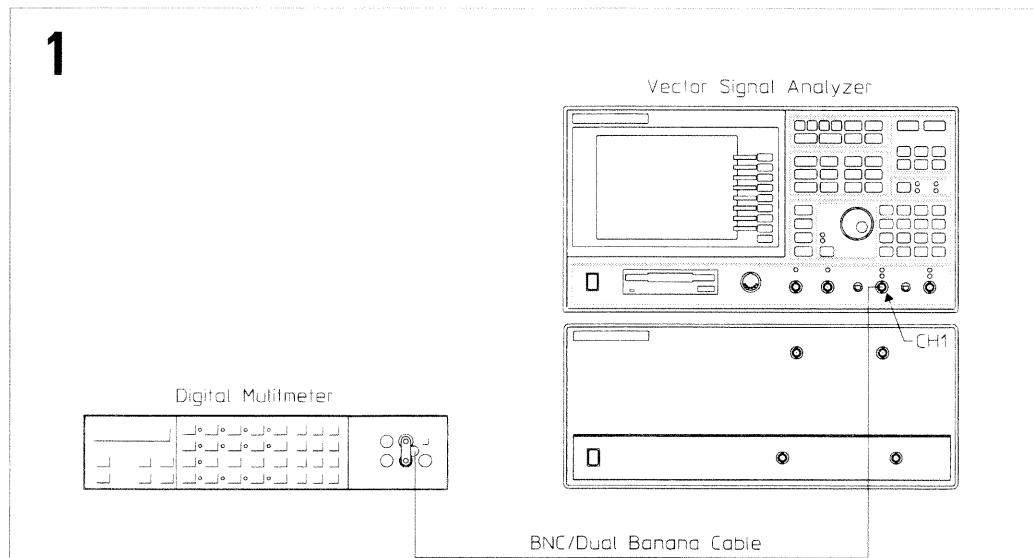

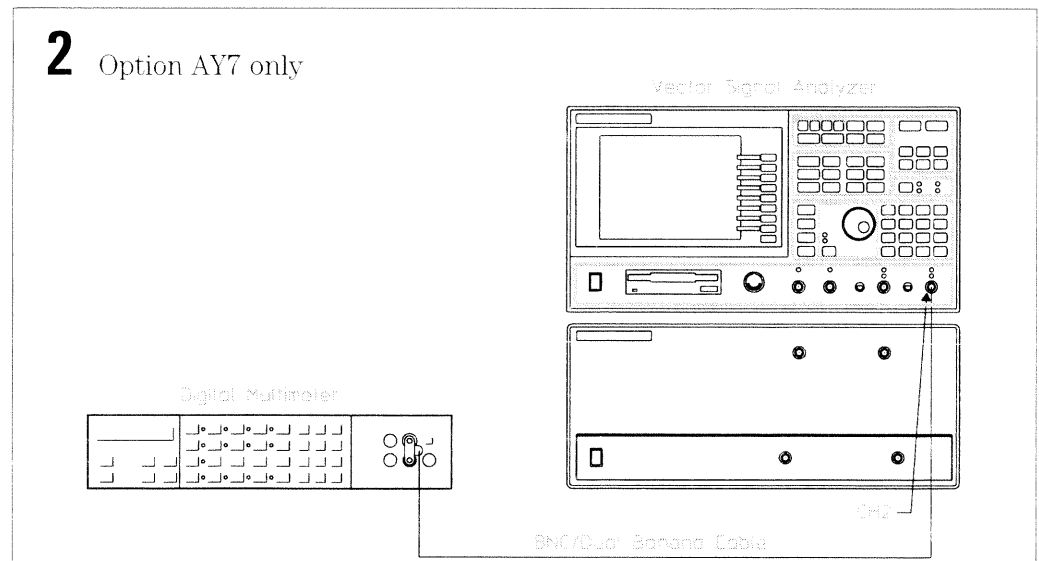

To set up the dc offset test

Performance Test and Operation Verification

This test verifies that the Agilent 89441A meets its baseband amplitude accuracy specification for residual dc. In this test, the 89441A measures its internal residual dc offset at six amplitudes with the filter in and out.

1

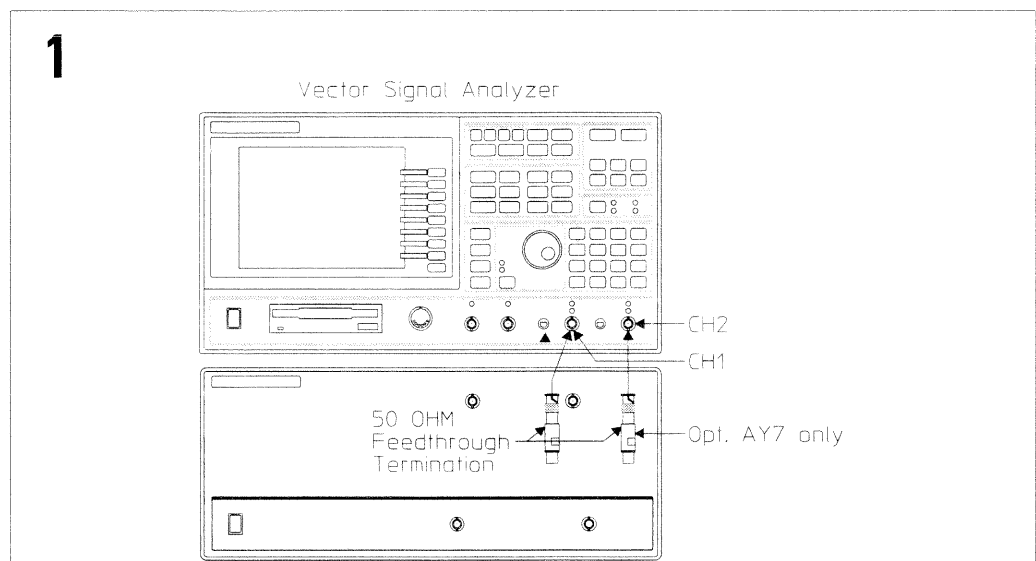

To set up the spurious signals test

Performance Test and Operation Verification

This test verifies that the Agilent 89441A meets its baseband dynamic range specification for residual (spurious) responses. In this test, the 89441A measures its internal spurious signals at six frequencies.

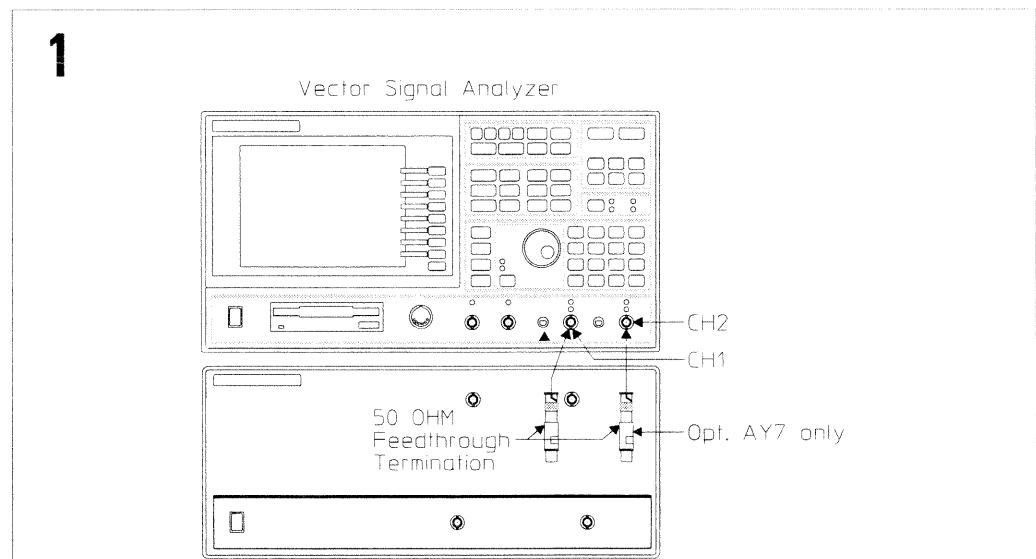
1

To set up the noise test

Performance Test and Operation Verification

This test verifies that the Agilent 89441A meets its baseband dynamic range specification for input noise density. In this test, the 89441A measures its internal noise from 1 kHz to 10 MHz.

1

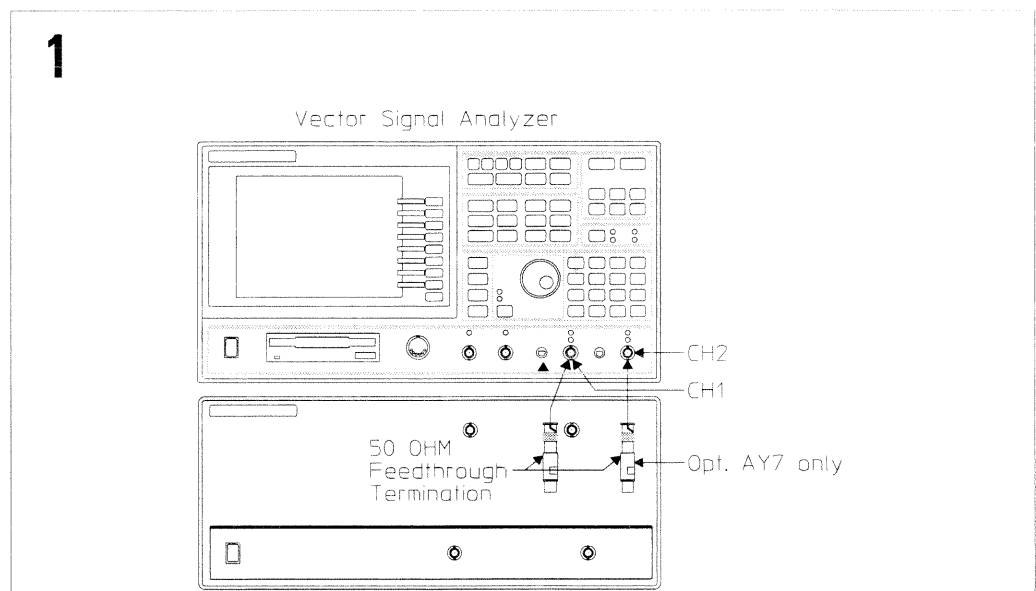

To set up the cross talk test

Performance Test only

This test verifies that the Agilent 89441A meets its baseband dynamic range specification for crosstalk. In this test, the 89441A measures the amount of energy induced from the source or input channel to another input channel. For source-to-receiver crosstalk, the analyzer's source is turned on and set for a high level output, then the signal level at the input is measured. For channel-to-channel crosstalk, a 9.9876 MHz, +20 dBm signal is connected to one channel and the signal level at the other input channel is measured.

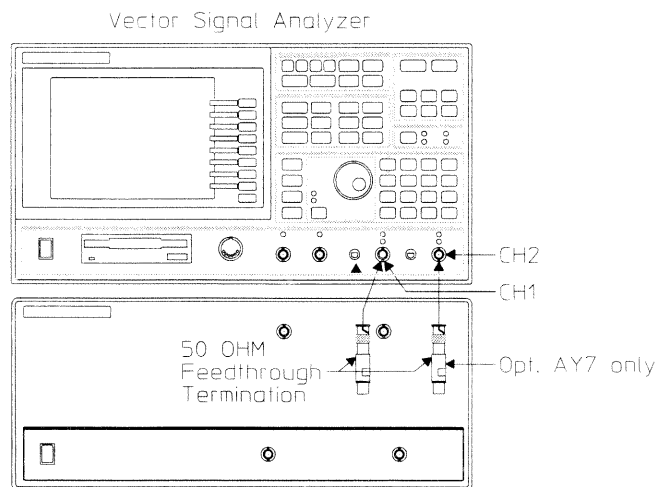
1

2 Option AY7 only

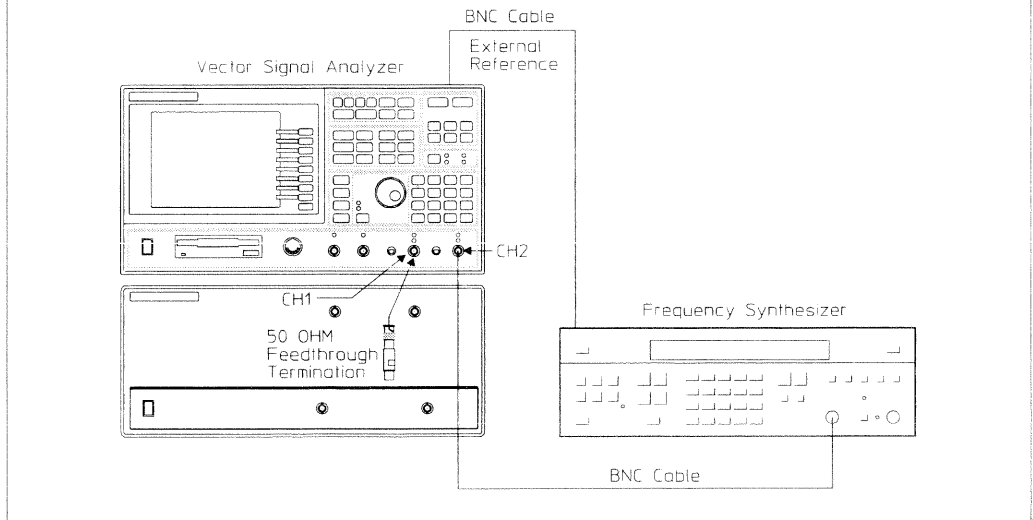

3 Option AY7 only

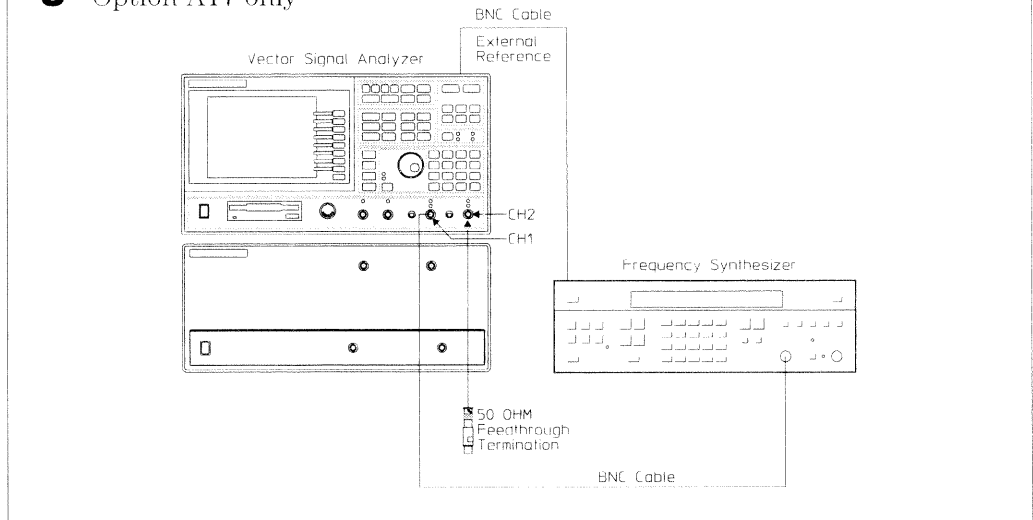

To set up the anti-alias filter test

Performance Test only

This test verifies that the Agilent 89441A meets its baseband dynamic range specification for alias responses. In this test, the 89441A measures the ability of the low pass anti-alias filter to reject frequencies caused by aliasing. Alias frequencies occur when the difference of the input signal frequency and the 89441A's sample rate both fall within the frequency range of interest. Using a signal generator, a signal known to cause an alias frequency is connected to the 89441A. The 89441A then measures the alias frequency to determine how well the alias frequency was rejected. This test checks eight alias frequencies (the "Performance Test Record" at the end of this chapter lists the alias frequencies).

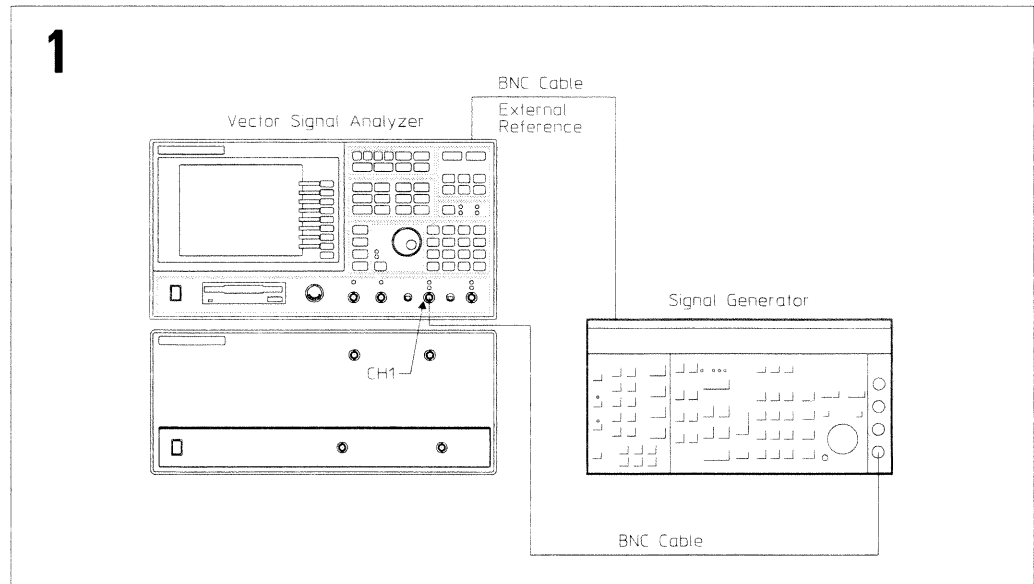

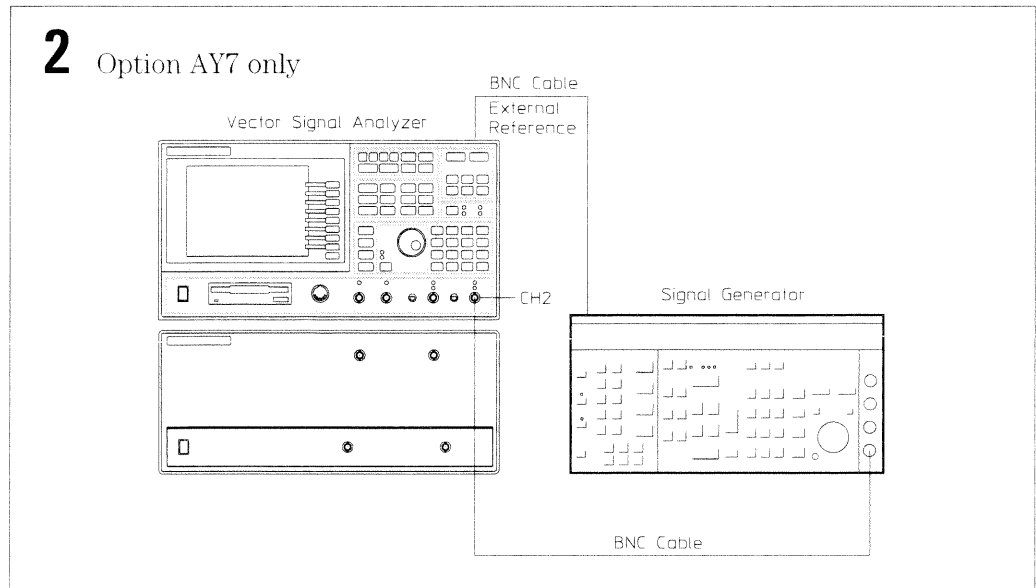

To set up the input rtn loss test

Performance Test only

This test verifies that the Agilent 89441A meets its baseband input port specification for return loss. In this test, a spectrum analyzer with a tracking generator is connected to a directional bridge. A reference measurement is made with the load port of the directional bridge open. The load port is then connected to an input channel and measurements are made for selected input range settings. This test measures both 50 Ω and 75 Ω input impedances. The spectrum analyzer is set for a 100 kHz to 10 MHz frequency range.

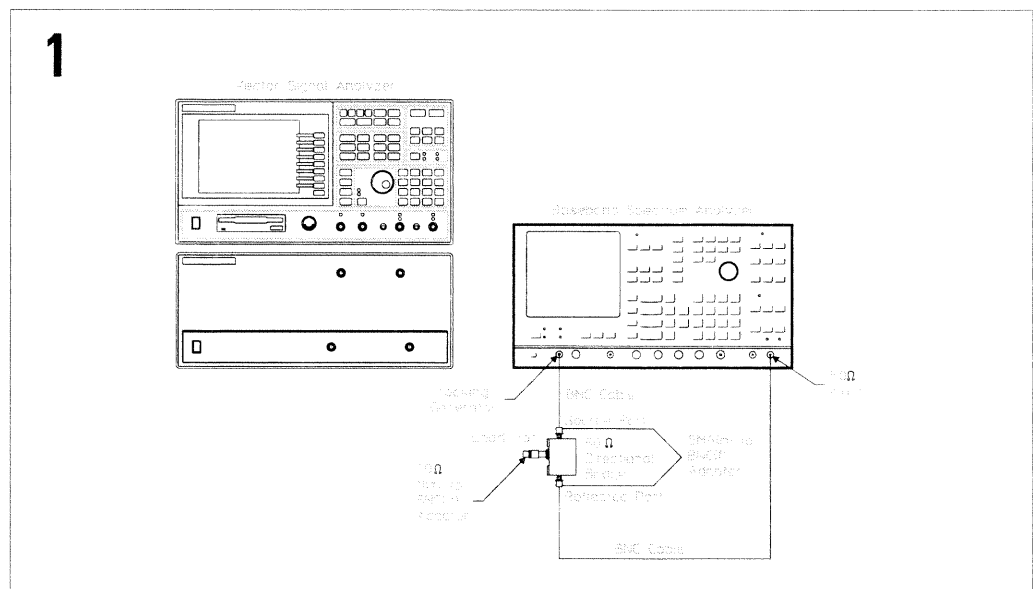

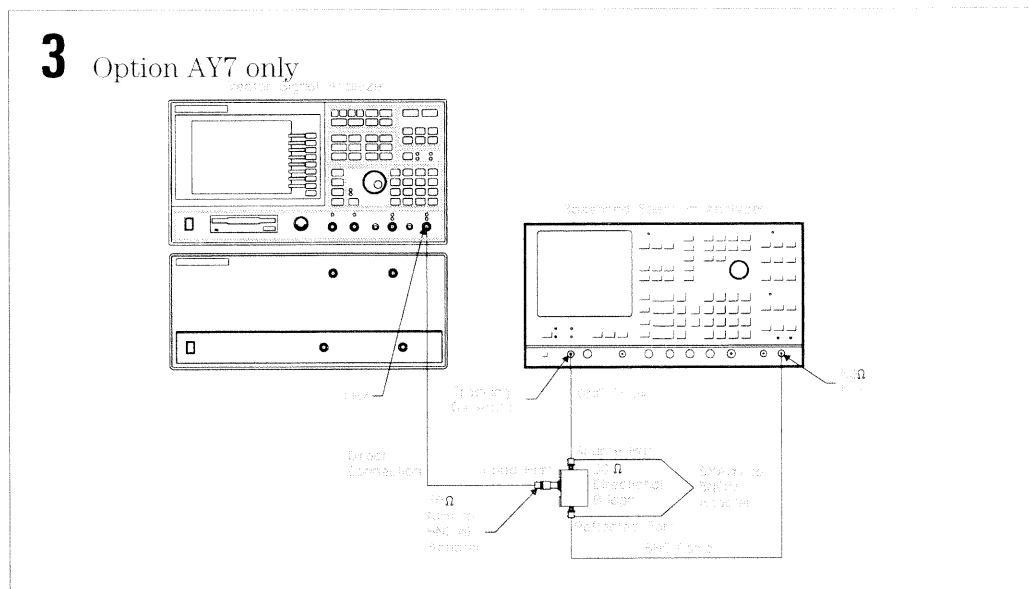
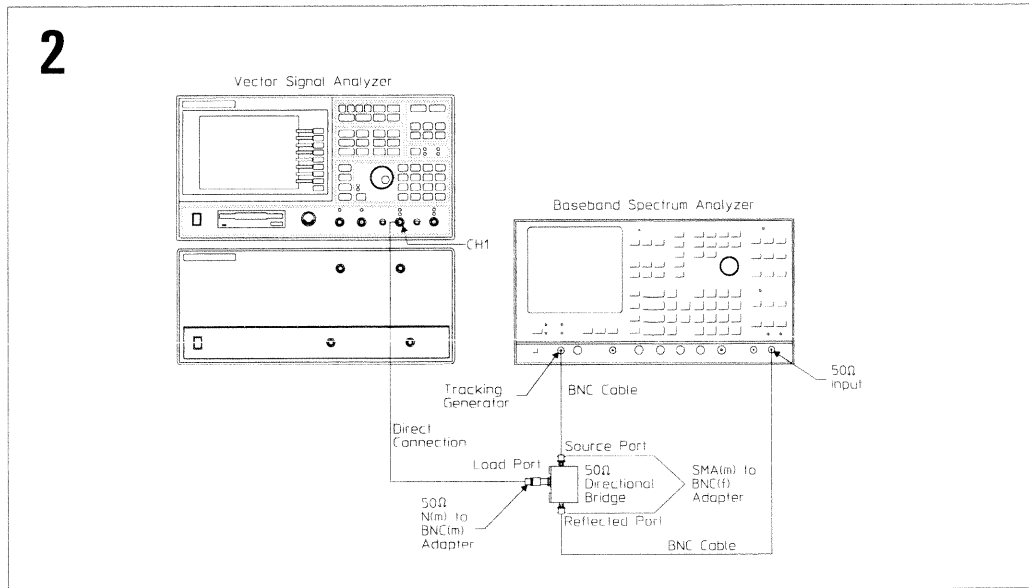

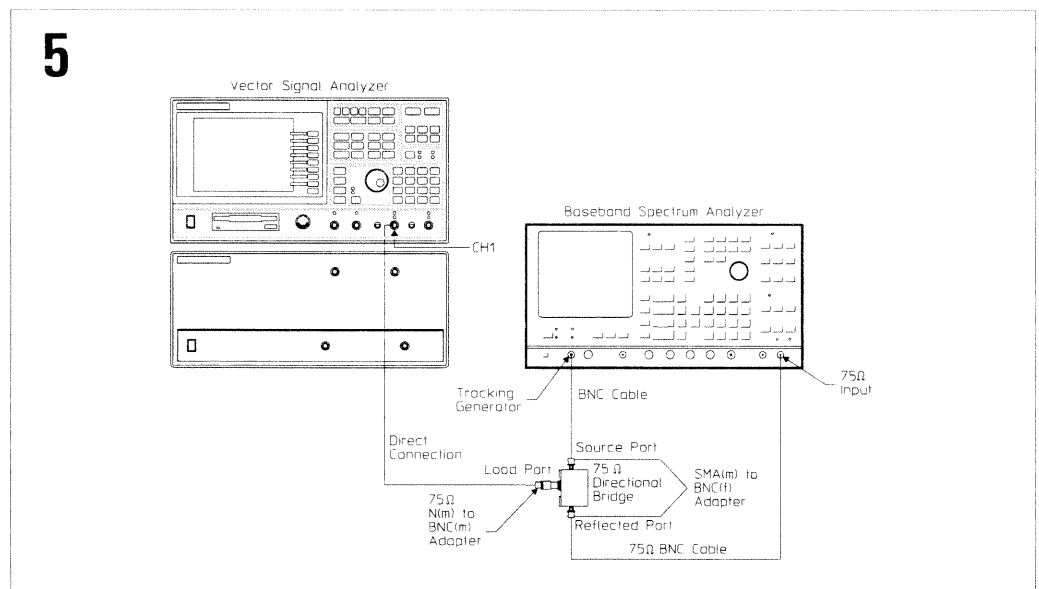
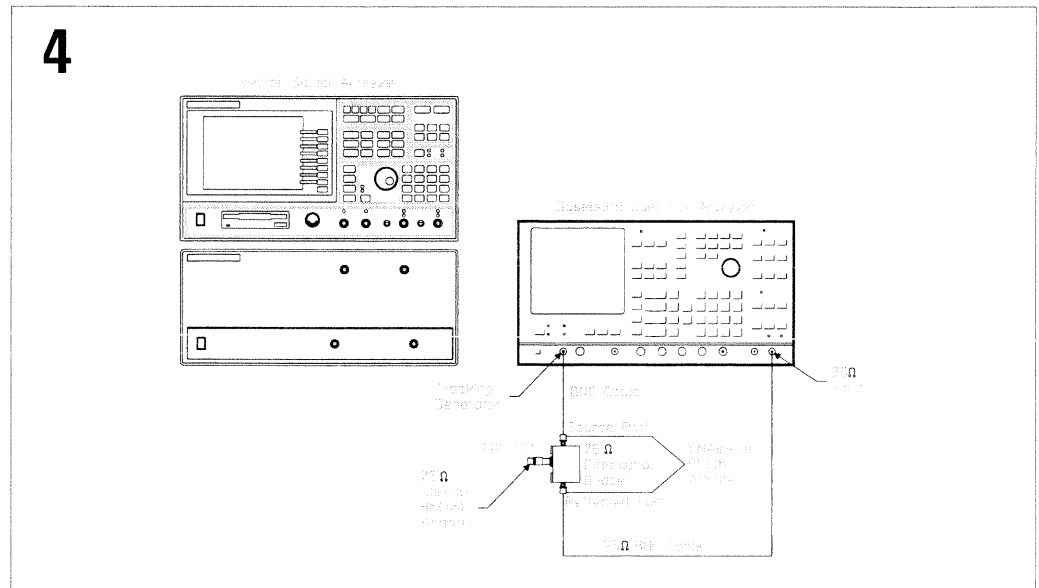

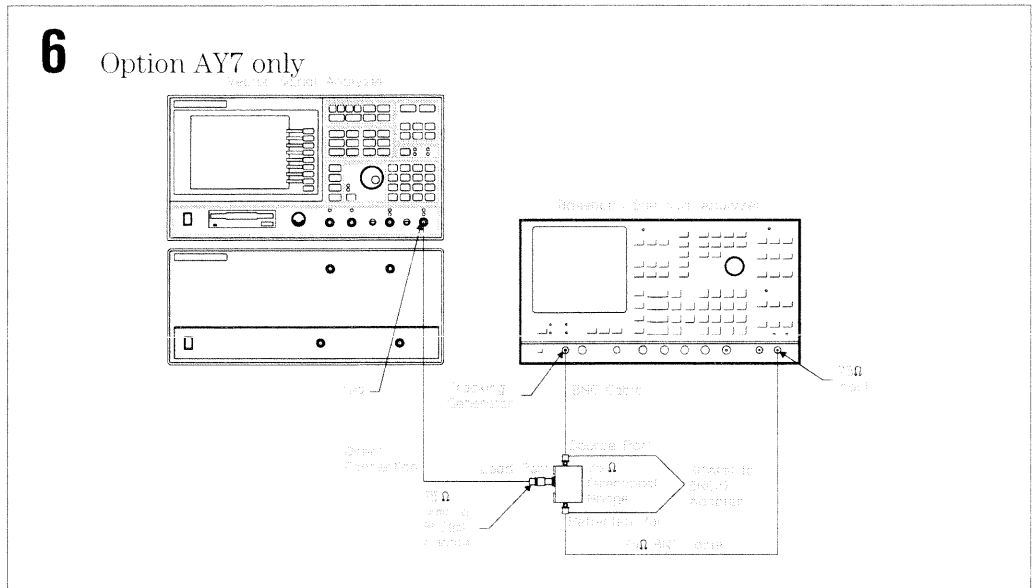

To set up the source rtn loss test

Performance Test only

This test verifies that the Agilent 89441A meets its baseband source port specification for return loss. In this test, a spectrum analyzer with a tracking generator is connected to a directional bridge. A reference measurement is made with the load port of the directional bridge open. The load port is then connected to the 89441A's source and measurements are made for selected attenuator settings. This test measures both 50 and 75 Ω output impedances. The spectrum analyzer is set for a 100 kHz to 10 MHz frequency range.

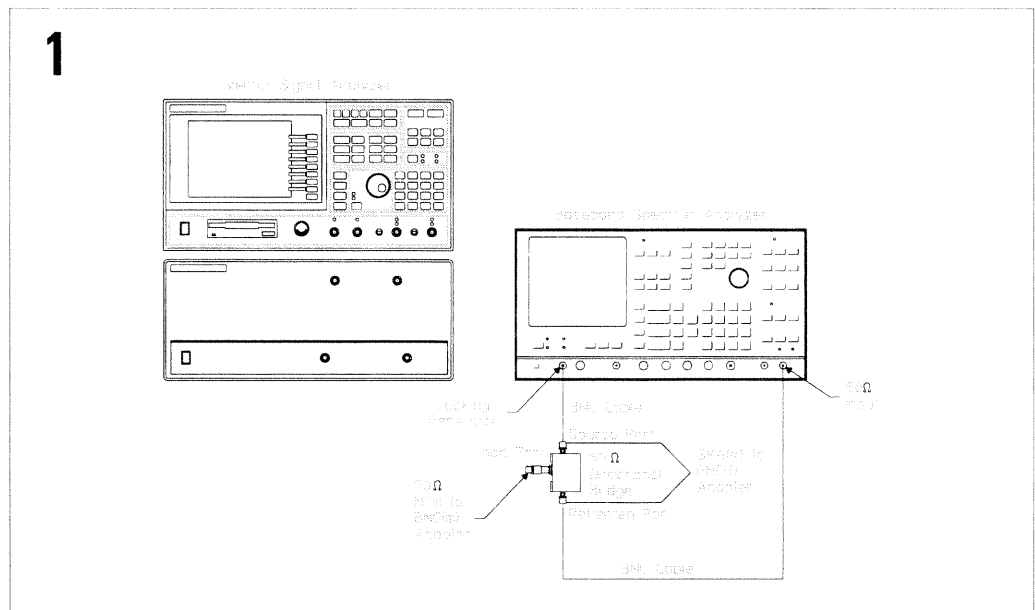

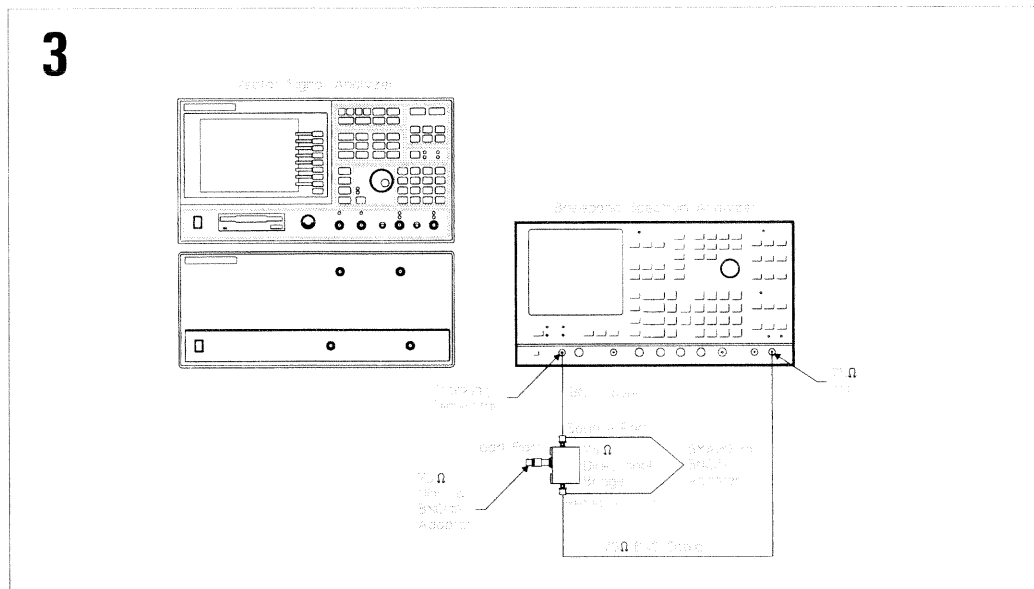
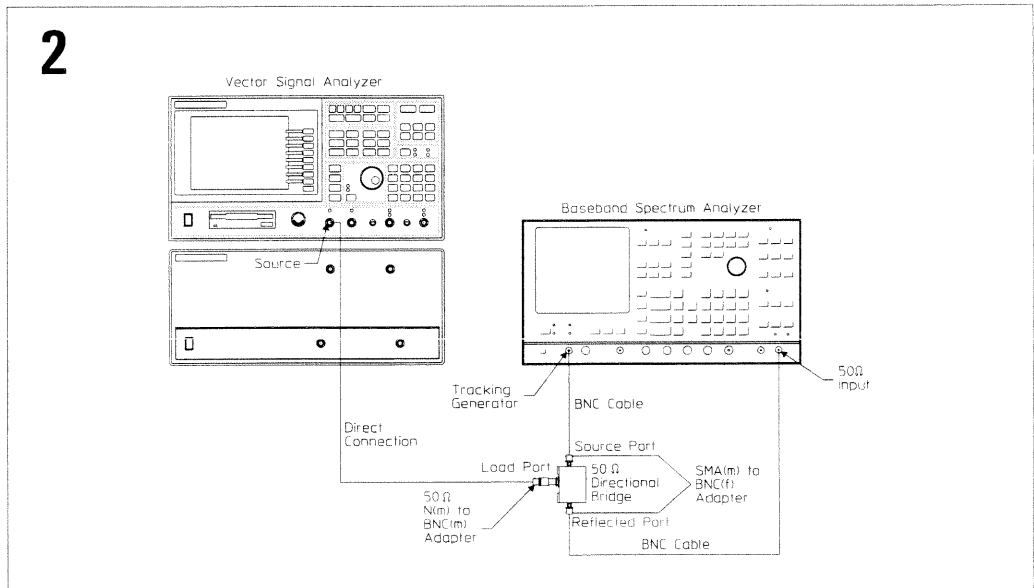

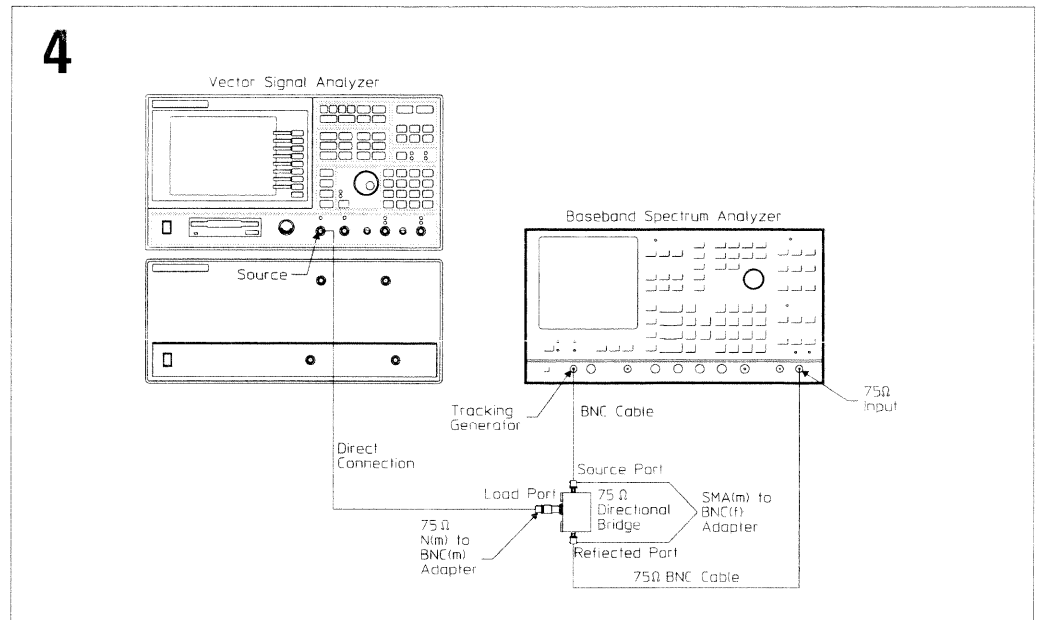

To set up the source amplitude accuracy test

Performance Test and Operation Verification

This test verifies that the Agilent 89441A meets its baseband source specification for amplitude accuracy. In this test, a baseband spectrum analyzer is used to measure the source level at eleven amplitudes and eight frequencies (the "Performance Test Record" at the end of this chapter lists the amplitudes and frequencies).

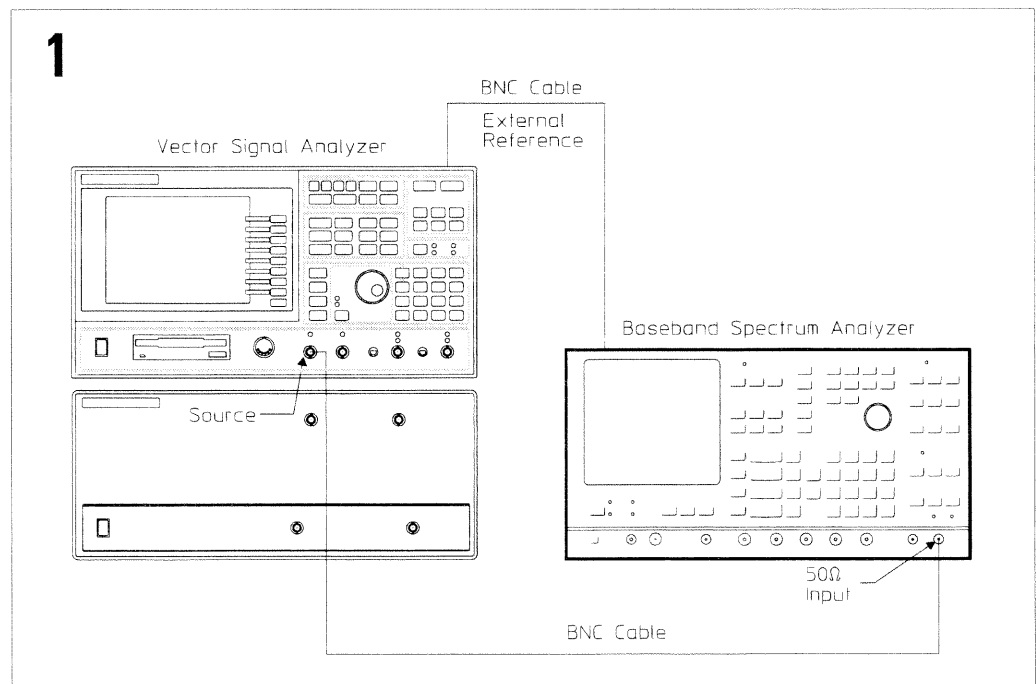

To set up the source distortion test

Performance Test and Operation Verification

This test verifies that the Agilent 89441A meets its baseband source specification for harmonic and other spurious products. In this test, a spectrum analyzer is connected to the 89441A's source. The source is set to five frequencies and two amplitudes while the spectrum analyzer measures distortion and spurious responses from 100 Hz to 40 MHz (the "Performance Test Record" at the end of this chapter lists the frequencies and amplitudes).

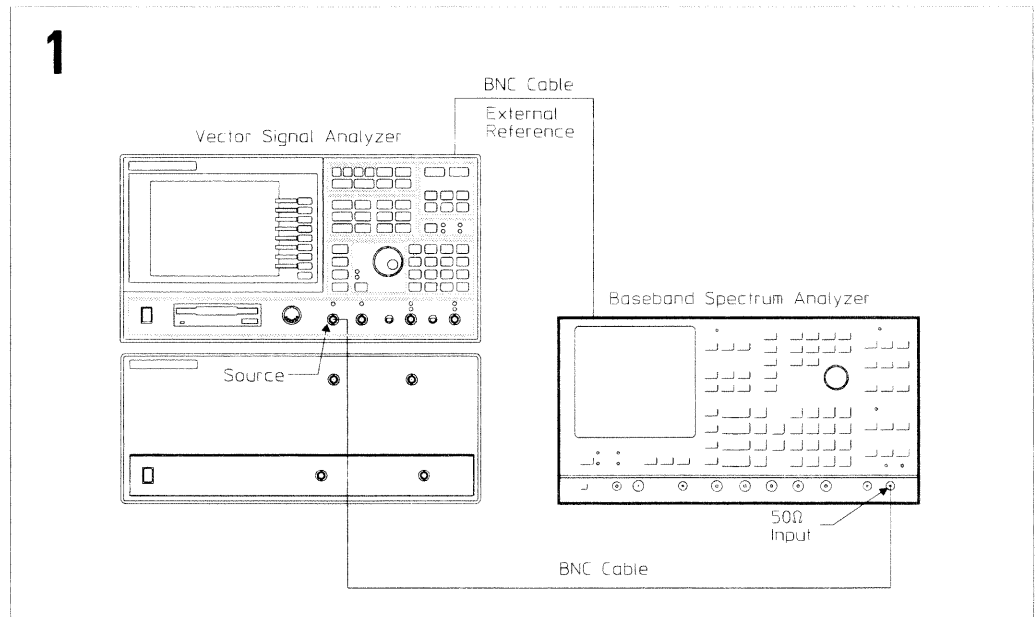

To set up the RF-amplitude accuracy test

Performance Test and Operation Verification

The temperature must be between 20° and 30° C to perform this test.

This test verifies that the Agilent 89441A meets its RF amplitude accuracy specification for absolute full scale accuracy. In this test, a signal generator outputs a signal to the power splitter. One output of the power splitter is measured by a power meter. The other output is measured by the analyzer. The two measurements are then compared. For each range tested, the accuracy is measured at the center frequency of 42 different frequency settings between 2 MHz and 2650 MHz (the "Performance Test Record" at the end of this chapter lists the ranges). The minimum and maximum frequency points are then tested at 7 frequency points offset from the worst case point.

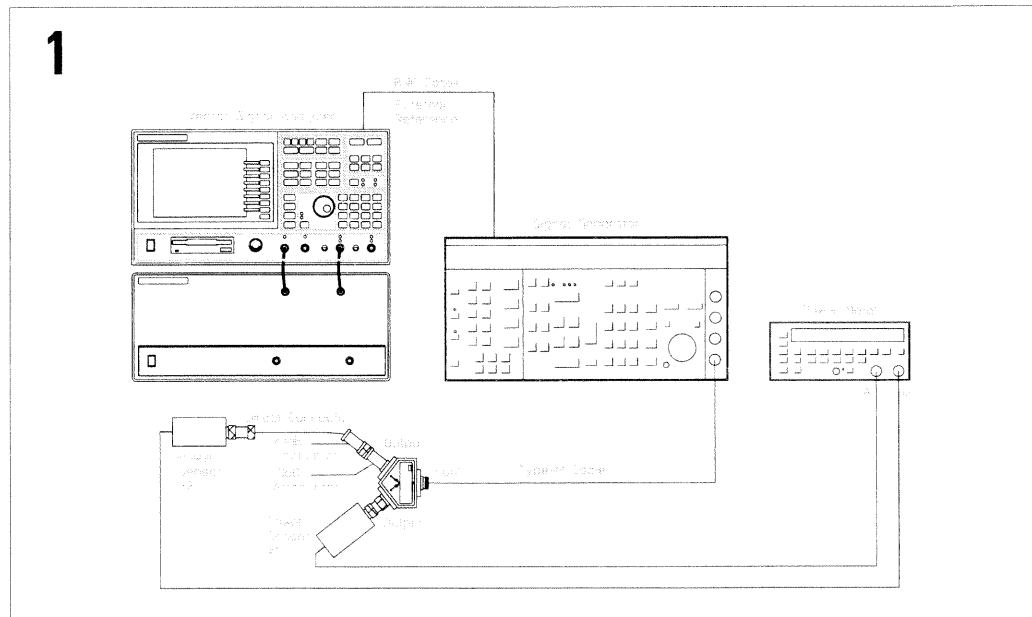

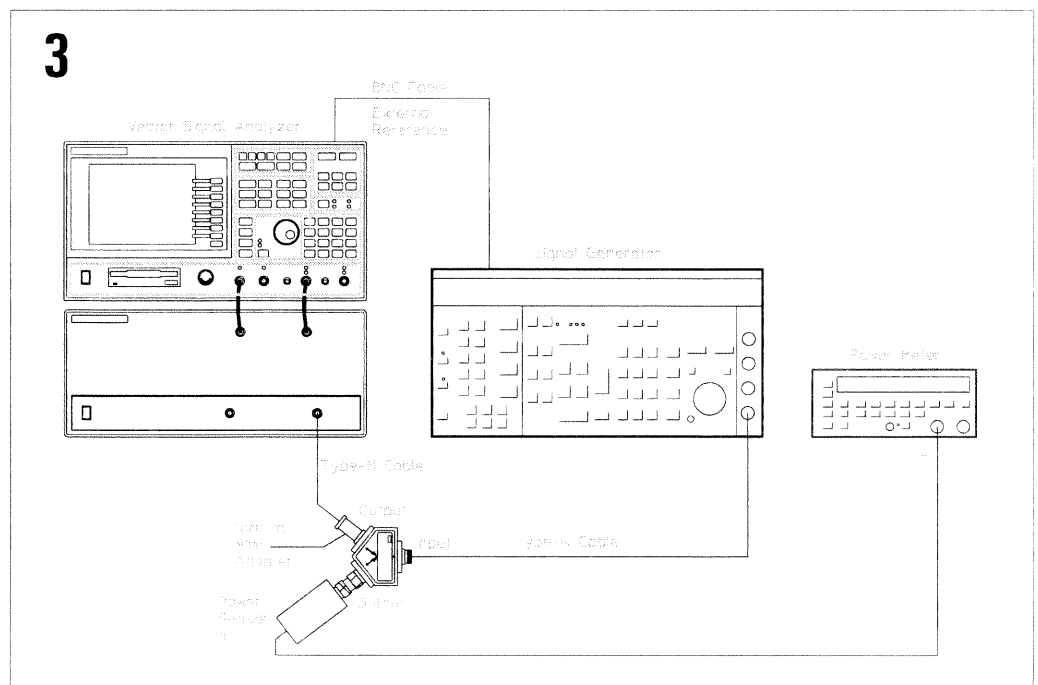
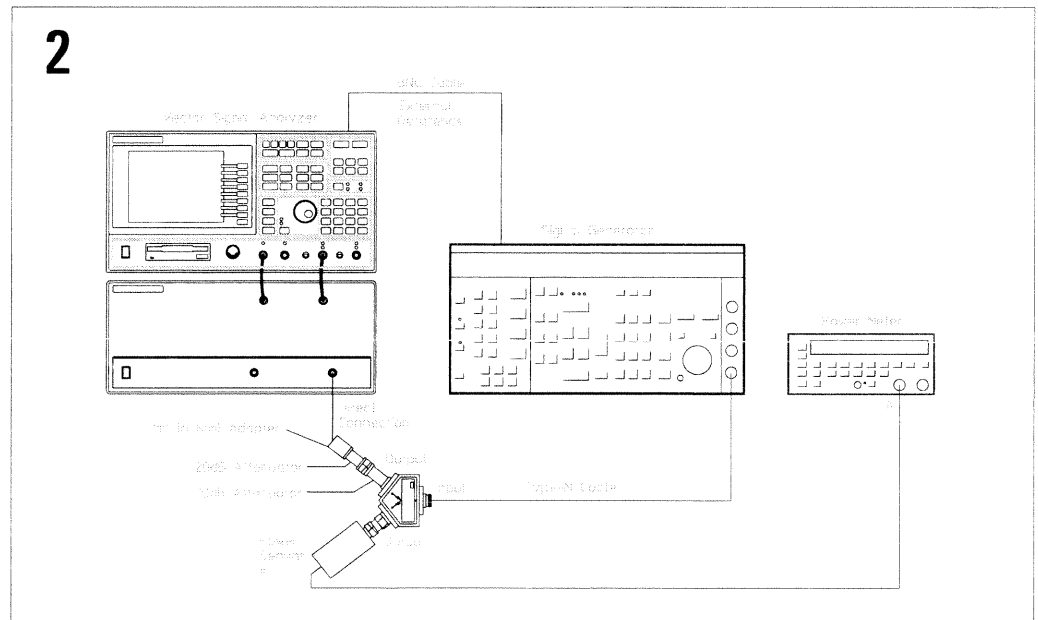

To set up the phase noise test

Performance Test and Operation Verification

This test is only for Agilent 89441A's with the standard high-precision frequency reference installed. This test verifies that the 89441A meets its RF frequency stability specification for phase noise. In this test, a signal generator supplies a clean 640 MHz, -20 dBm signal. The 89441A then measures phase noise at four offsets.

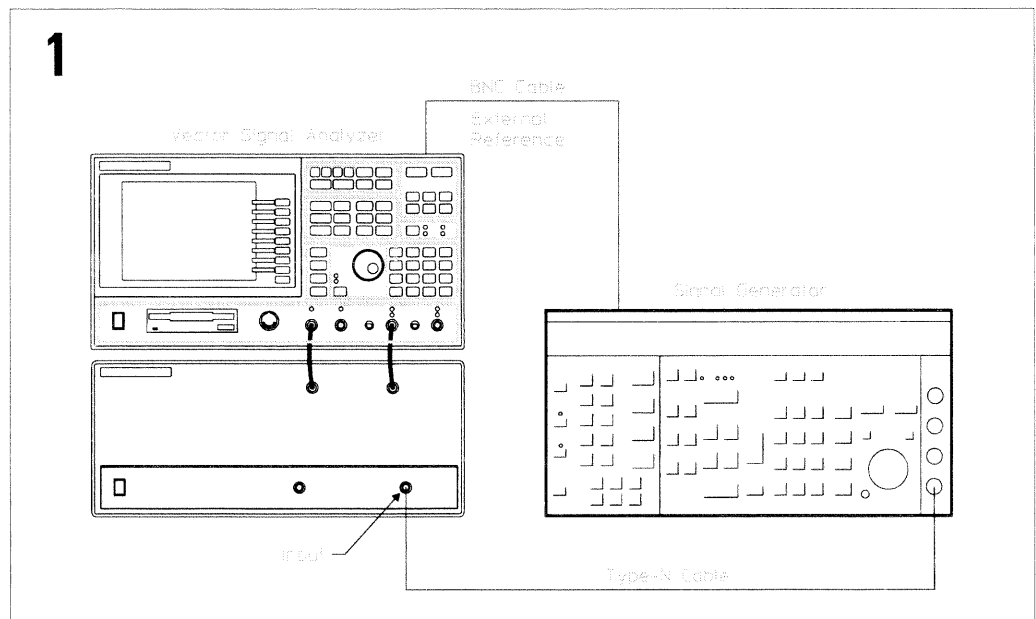

To set up the LO spurs test

Performance Test only

This test is only for Agilent 89441A's with the standard high-precision frequency reference installed. This test verifies that the 89441A meets its RF frequency stability specification for LO spurious sidebands. In this test, a signal generator supplies a clean 596 MHz, -30 dBm signal. The 89441A then measures the sidebands at six offsets.

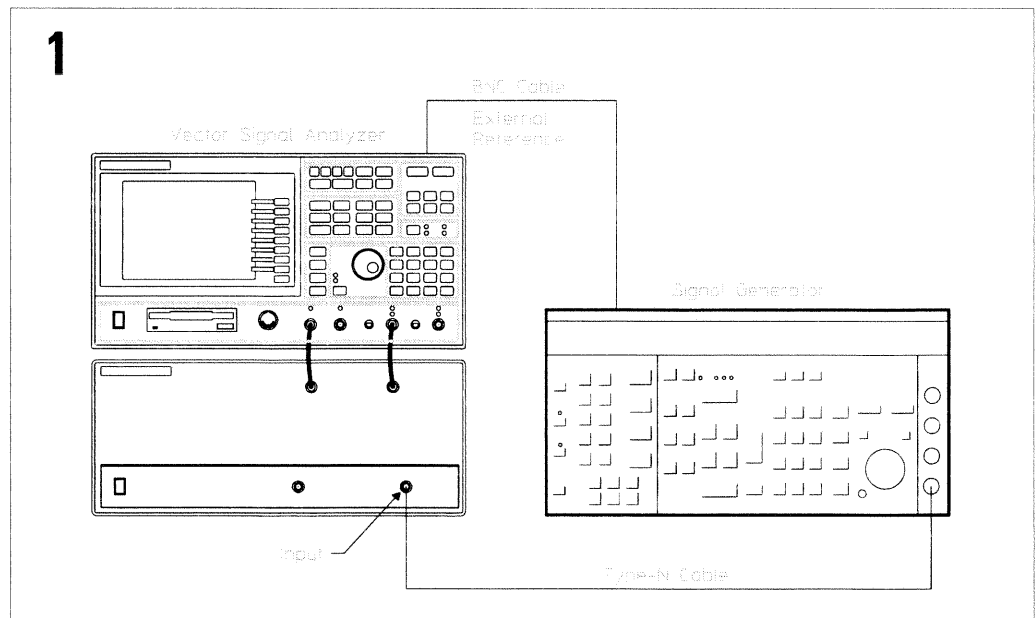

To set up the RF-spurious signals test

Performance Test and Operation Verification

This test verifies that the Agilent 89441A meets its RF dynamic range specification for general spurious. In this test, a signal generator supplies a clean -30 dBm signal. The 89441A then measures the spurious responses at various frequencies (the "Performance Test Record" at the end of this chapter lists the frequencies).

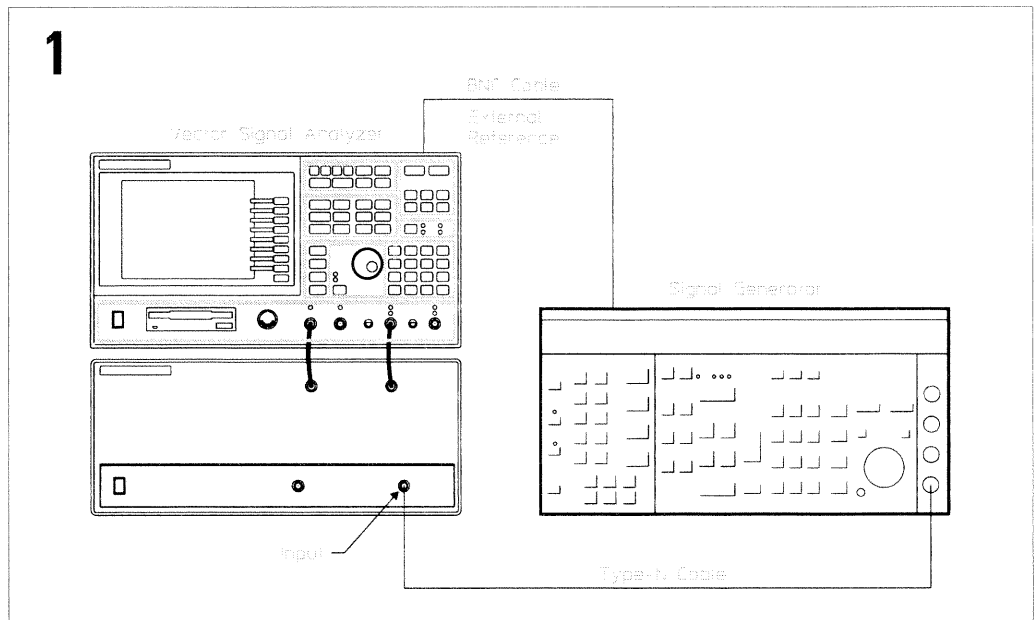

To set up the RF-harmonic distortion test

Performance Test and Operation Verification

This test verifies that the Agilent 89441A meets its RF dynamic range specification for harmonic distortion. In this test, a low pass filter attenuates the harmonics of a full scale signal from the signal generator. The analyzer measures the signal and the signal generator level is adjusted for a full scale input. The analyzer then measures the second and third harmonics (the "Performance Test Record" at the end of this chapter lists the frequencies and harmonics).

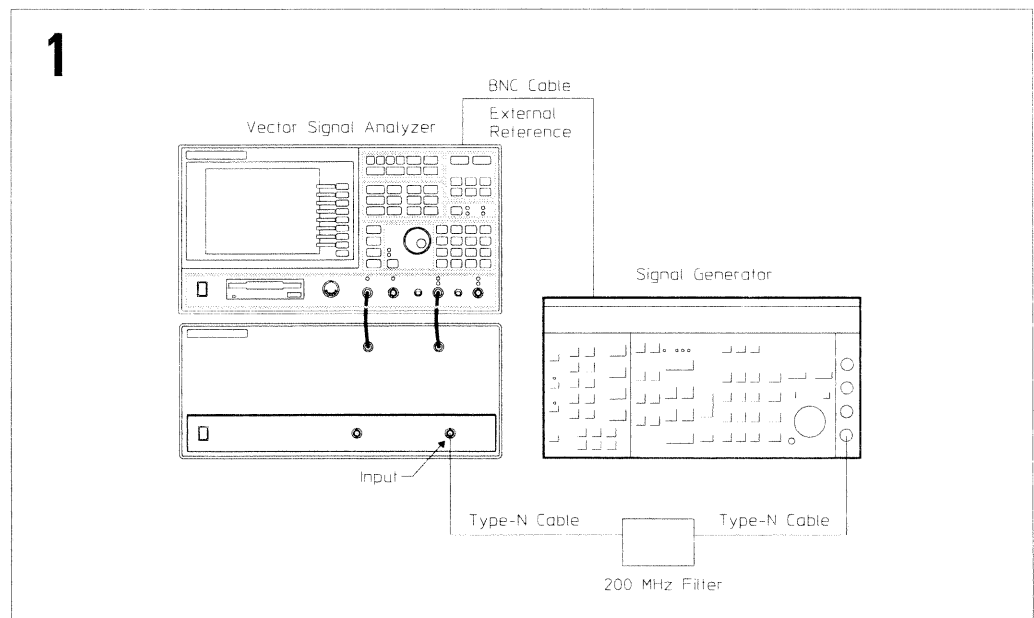

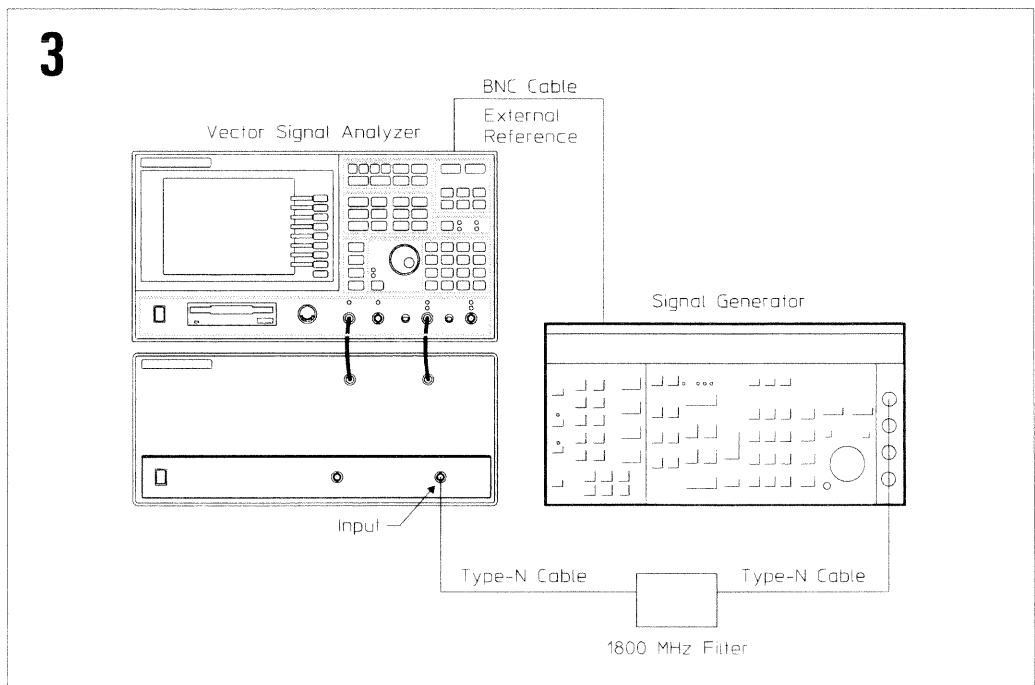
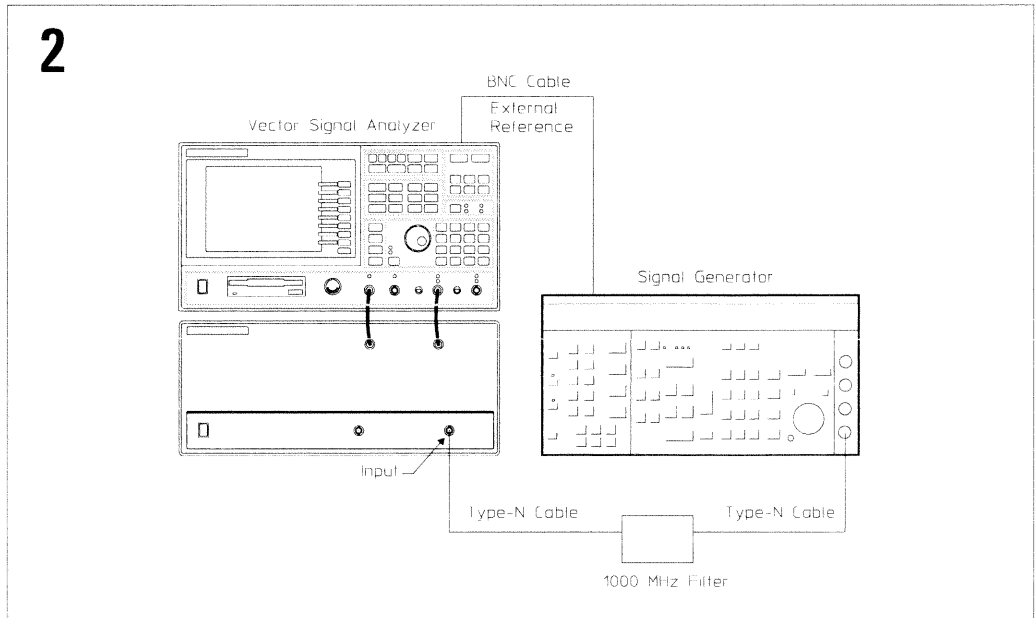

To set up the frequency accuracy test

Performance Test and Operation Verification

The Agilent 89441A must be on for 30 minutes before performing this test.

This test is for Agilent 89441A's with the standard high-precision frequency reference installed. This test verifies that the 89441A meets its baseband frequency accuracy specification. In this test, the analyzer measures the frequency of an accurate 1500 MHz signal. The frequency limits are then calculated using the number of months since the last frequency reference adjustment.

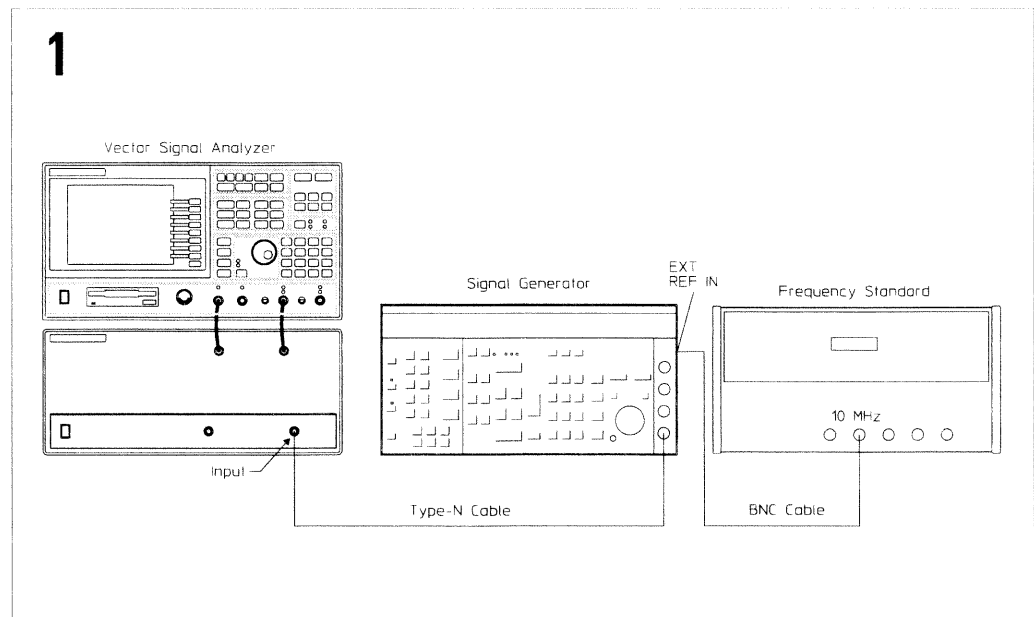
1

To set up the RF-noise test

Performance Test and Operation Verification

The temperature must be between 20° and 30° C to perform this test.

This test verifies that the Agilent 89441A meets its RF dynamic range specification for input noise density. In this test, the 89441A measures its internal noise at 9 frequencies on two ranges.

1

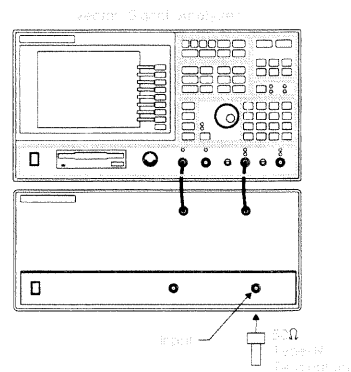

To set up the RF residuals test

Performance Test and Operation Verification.

This test verifies that the Agilent 89441A meets its RF dynamic range specification for residual responses. In this test, the 89441A measures its internal residual responses at 27 frequencies on 2 ranges.

1

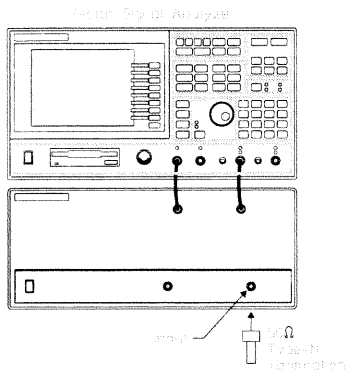

To set up the RF-source amplitude accuracy test

Performance Test and Operation Verification

The temperature must be between 20° and 30° C to perform this test.

This test is only for Agilent 89441A's with the optional RF source (option AY8). This test verifies that the 89441A meets its RF source specification for absolute accuracy. In this test, a power meter sensor is connected to the RF source. The power meter measures the RF source's absolute accuracy from 6 MHz to 2644 MHz at 4 amplitudes (+13 dBm, -5 dBm, -10 dBm, -20 dBm).

1 Option AY8 only

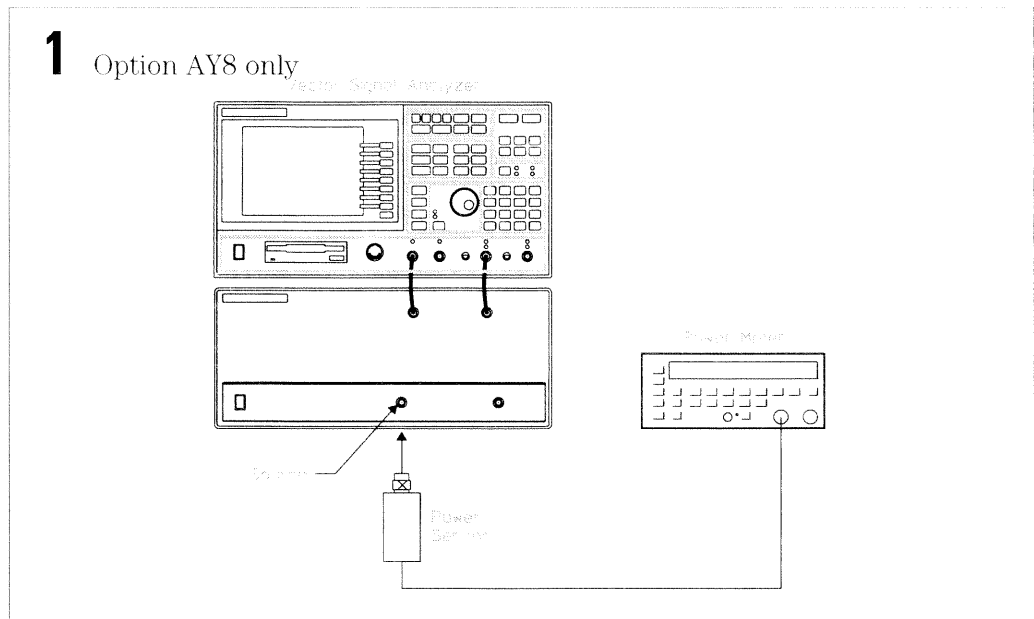

To set up the RF-source IF-flatness test

Performance Test and Operation Verification

The temperature must be between 20° and 30° C to perform this test.

This test is only for Agilent 89441A's with the optional RF source (option AY8). This test verifies that the 89441A meets its RF source specifications for IF flatness. In this test, a power meter sensor is connected to the RF source. The power meter then measures the IF flatness from 897.5 MHz to 904.5 MHz.

1 Option AY8 only

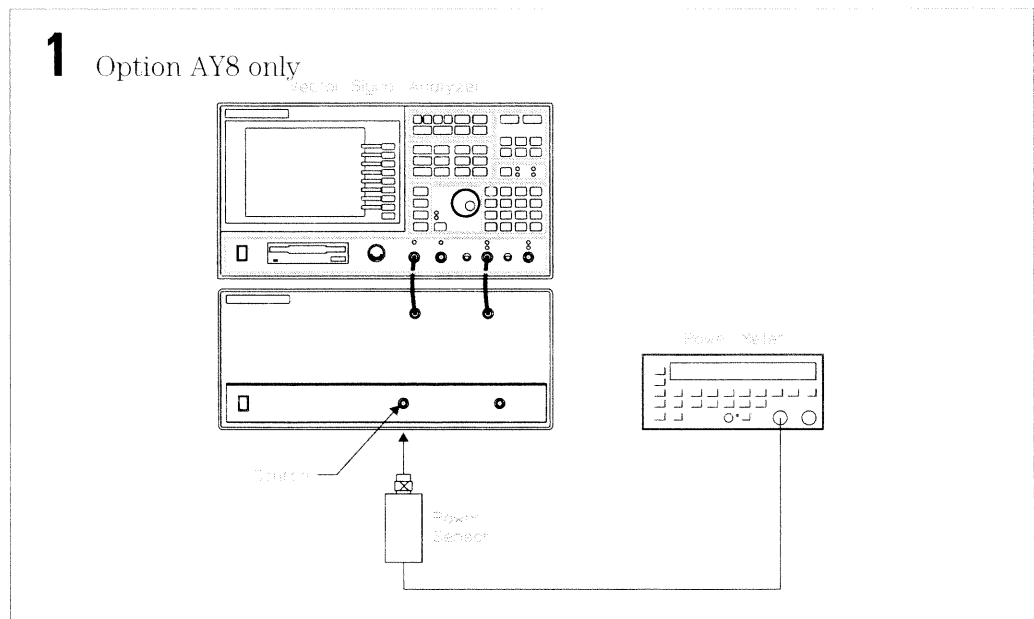

To set up the RF-source spurious test

Performance Test and Operation Verification

This test is only for Agilent 89441A's with the optional RF source (option AY8). This test verifies that the 89441A meets its RF source specification for non-harmonic spurious. In this test, the 89441A measures spurious signals at 10 frequencies and 2 source levels with and without an offset frequency (the "Performance Test Record" at the end of this chapter lists the frequencies and source levels).

1 Option AY8 only

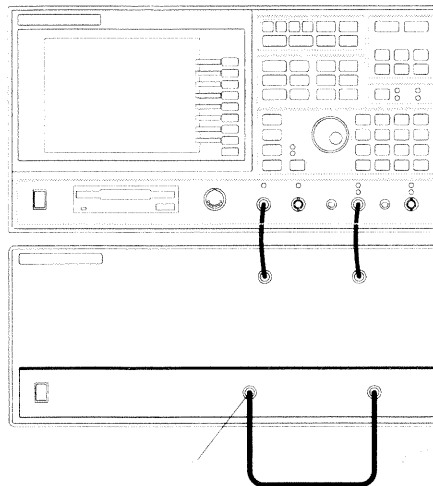

To set up the RF-source distortion test

Performance Test and Operation Verification

This test is only for Agilent 89441A's with the optional RF source (option AY8). This test verifies that the 89441A meets its RF source specification for harmonic distortion. In this test, a spectrum analyzer measures the RF source's 2nd, 3rd, 4th, and 5th harmonics (the "Performance Test Record" at the end of this chapter lists the frequencies and harmonics).

1 Option AY8 only

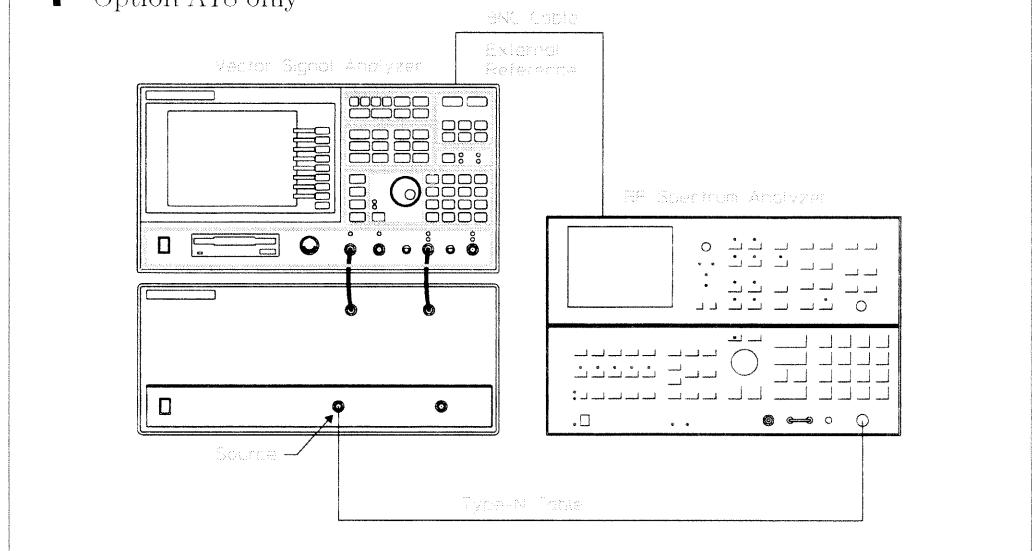

To set up the RF-source noise test

Performance Test and Operation Verification

This test is only for Agilent 89441A's with the optional RF source (option AY8). This test verifies that the 89441A meets its RF source specification for average noise level. In this test, the RF spectrum analyzer measures the noise of the RF source using the marker noise function.

1 Option AY8 only

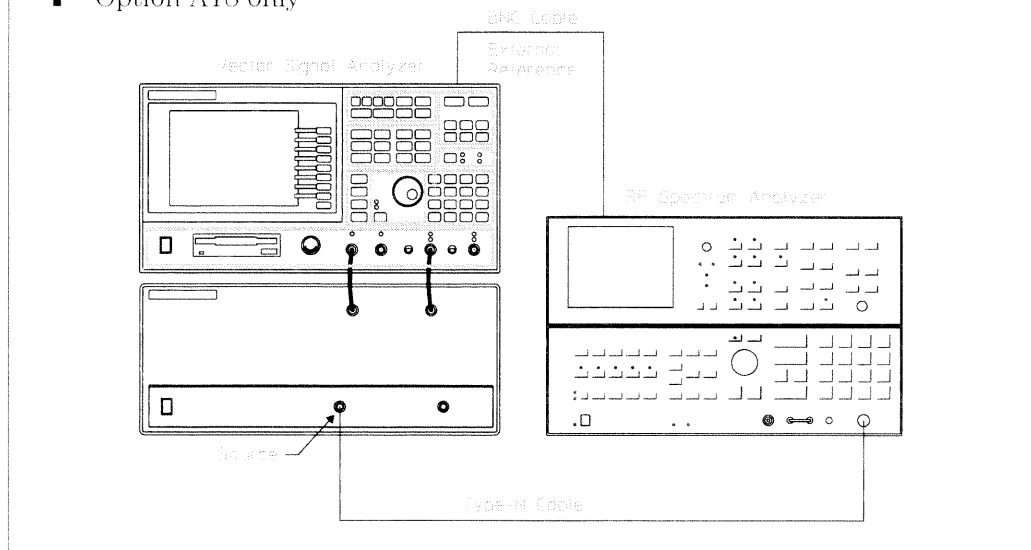

ITM_89441A Main Menu Descriptions

If you do not have a keyboard connected to the analyzer, use the numeric key pad and the alpha keys to enter names or numbers. See the analyzer's help text for a description of the alpha keys.

Load and run the ITM_89441A program to display the following softkeys:

[START TESTING]

Displays a menu that allows you to start testing with any test or to select just one test in the list. Before pressing this softkey, use [TEST CONFIG] and [EQUIP CONFIG]. See "Start Testing Menu Descriptions" for additional information.

[TEST CONFIG]

Displays the test configuration and a menu that allows you to enter the procedure, stop conditions, beeper prompt, and HP-IB address for the analyzer and printer. See "Test Configuration Menu Descriptions" for additional information.

[EQUIP CONFIG]

Displays the test equipment configuration and a menu that allows you to enter the model number, calibration due date, serial number, and HP-IB address for each test instrument. See "Equipment Configuration Menu Descriptions" for additional information.

[TITLE PAGE]

Displays the test record title page information and a menu that allows you to enter information for the analyzer. See "Title Page Menu Descriptions" for additional information.

[STOP ITM]

Stops the ITM_89441A program.

Start Testing Menu Descriptions

Press [START TESTING] to display the following softkeys:

[START BEGINNING]

Prints the test record title page information and starts the selected test procedure at the beginning. The measurement results are written to a file on the disk and printed only after all tests are done.

[START MIDDLE]

Displays a list of all the tests in the selected procedure. Testing starts with the test you select and continues through the remainder of the tests in the list. The measurement results are printed immediately after each measurement.

[ONE TEST]

Displays all the tests in the selected procedure. The test you select is the only test performed. The measurement results are printed immediately after each measurement.

[RETURN]

Returns to the ITM_89441A main menu.

Start a test to display the following softkeys:

[STOP TESTING]

Stops the test and returns to the ITM_89441A main menu.

[RESTART TEST]

Starts the current test over. Any connection prompts are repeated.

[RESTART MEAS]

Starts the current measurement over.

The following softkeys also appear when the program is waiting for you to press [CONTINUE]:

[STOP BEEPING]

Turns off the beeper prompt for the remainder of this measurement.

[CONTINUE]

Continues the test. Press this key after following the directions on the display.

Test Configuration Menu Descriptions

Press [TEST CONFIG] to display the test configuration and the following softkeys:

[HP 89441A ADDRESS]

Prompts you to enter the HP-IB address for the HP 89441A DC-2650 MHz Vector Signal Analyzer.

The HP-IB address equals $100 \times$ (interface select code) + (primary address). The interface select code for the printer and test equipment is 7 (for example, if the primary address is 8, the HP-IB address is 708).

[PRINTER ADDRESS]

Prompts you to enter the HP-IB address for the printer. To disable the printer, set the printer address to 0.

[PROCEDURE]

Prompts you to select the operation verification procedure (OP_VERIFY) or the performance test procedure (PERFORMAN).

[STOP AFTER]

Prompts you to select stop after limit failure, stop after each measurement, or do not stop after a limit failure or measurement. If [Limit Failure] is selected, the program stops after the failing measurement is displayed but before it is printed. At this point you can continue on and print the failing measurement or restart the measurement.

[BEEPER]

Toggles the beeper on and off. When the beeper is on, the program beeps approximately every 2 minutes while waiting for you to follow the directions on the display and press [CONTINUE].

[RETURN]

Returns to the ITM_89441A main menu.

Equipment Configuration Menu Descriptions

Press [EQUIP CONFIG] to display the test equipment configuration and the following softkeys:

[SYNTHESIZER]

Prompts you to enter the model, serial number, HP-IB address, and calibration due date for the frequency synthesizer.

If you select [OTHER] for model, the program prompts you to type in a model, serial number, and calibration due date but not an HP-IB address.

When entering the calibration due date, only four characters are displayed on the screen. However, you can enter up to nine characters and they will be printed.

[BASEBAND ANALYZER]

Prompts you to enter the model, serial number, HP-IB address, and calibration due date for the baseband spectrum analyzer.

[MULTIMETER]

Prompts you to enter the model, serial number, HP-IB address, and calibration due date for the digital multimeter.

[STEP_ATT 1DB]

Prompts you to enter the model, serial number, and calibration due date and data for the 1 dB step attenuator.

[STEP_ATT 10DB]

Prompts you to enter the model, serial number, and calibration due date and data for the 10 dB step attenuator.

[SIGNAL GENERATOR]

Prompts you to enter the model, serial number, HP-IB address, and calibration due date for the signal generator.

[mW-POWER METER]

Prompts you to enter the model, serial number, and calibration due date for the milliwatt power meter.

[POWER METER #1]

Prompts you to enter the model, serial number, HP-IB address, and calibration due date for power meter #1.

POWER METER #2]

Prompts you to enter the model, serial number, HP-IB address, and calibration due date for power meter #2.

[POWER SENSOR #1]

Prompts you to enter the model, serial number, and calibration due date and data for power sensor #1.

[POWER SENSOR#2]

Prompts you to enter the model, serial number, and calibration due date and data for power sensor #2.

[SAVE SETUP]

Saves the current equipment configuration to a file for future recall.

[RECALL SETUP]

Recalls an equipment configuration that was previously saved using [SAVE SETUP].

Title Page Menu Descriptions

Press [TITLE PAGE] to display the title page information and the following softkeys:

[TEST FACILITY]

Prompts you to enter the name or number of the testing entity.

[FACILITY ADDRESS]

Prompts you to enter the address of the testing entity.

[TESTED BY]

Prompts you to enter the name or number of the person performing the test.

[REPORT NUMBER]

Prompts you to enter the analyzer's report number.

[CUSTOMER]

Prompts you to enter the name or number of the person requesting the test.

[SERIAL NUMBER]

Prompts you to enter the analyzer's serial number.

[MORE]

Displays the next page.

[RETURN]

Prompts you to return to the ITM_89441A main menu.

[OPTIONS]

Prompts you to enter the analyzer's options.

[DATE]

Prompts you to enter the test date.

[TEMP]

Prompts you to enter the temperature of the environment during the test.

[HUMIDITY]

Prompts you to enter the humidity of the environment during the test.

[LINE FREQUENCY]

Prompts you to enter the power line frequency.

[MORE]

Displays the first page.

[RETURN]

Returns to the ITM_89441A main menu.

The title page information is printed at the beginning of the test procedure.

Performance Test Record

Test Facility _____

Facility Address _____

Tested By _____

Report Number _____

Customer Name _____

Agilent 89410A Serial Number _____

Agilent 89431A Serial Number _____

Installed Options _____

Date _____

Temperature _____

Humidity _____

Power Line Frequency _____

Test Instruments Used

Instrument	Model	ID or Serial Number	Calibration Due
Synthesizer			
Baseband Analyzer			
Multimeter			
Step Attenuator, 1 dB			
Step Attenuator, 10 dB			
Signal Generator			
Power Meter #1			
Power Meter #2			
Power Sensor #1			
Power Sensor #2			
Milliwatt Power Meter			

Serial Number: _____ Report Number: _____

Self Test

Measurement	Lower Limit	Upper Limit	Measured Value	Pass/Fail
Long Confidence				

Amplitude Accuracy

Measurement	Lower Limit (dBm)	Upper Limit (dBm)	Measured Value (dBm)	Pass/Fail
9.876 MHz, -30 dBm, Ch 1, 50 ohm	-0.5	0.5		
9.876 MHz, -18 dBm, Ch 1, 50 ohm	-0.5	0.5		
9.876 MHz, -6 dBm, Ch 1, 50 ohm	-0.5	0.5		
9.876 MHz, 6 dBm, Ch 1, 50 ohm	-0.5	0.5		
9.876 MHz, 18 dBm, Ch 1, 50 ohm	-0.5	0.5		
9.876 MHz, -30 dBm, Ch 1, 1 Mohm	-0.5	0.5		
9.876 MHz, -18 dBm, Ch 1, 1 Mohm	-0.5	0.5		
9.876 MHz, -6 dBm, Ch 1, 1 Mohm	-0.5	0.5		
9.876 MHz, 6 dBm, Ch 1, 1 Mohm	-0.5	0.5		
9.876 MHz, 18 dBm, Ch 1, 1 Mohm	-0.5	0.5		
9.876 MHz, -30 dBm, Ch 2, 50 ohm †	-0.5	0.5		
9.876 MHz, -18 dBm, Ch 2, 50 ohm †	-0.5	0.5		
9.876 MHz, -6 dBm, Ch 2, 50 ohm †	-0.5	0.5		
9.876 MHz, 6 dBm, Ch 2, 50 ohm †	-0.5	0.5		
9.876 MHz, 18 dBm, Ch 2, 50 ohm †	-0.5	0.5		
9.876 MHz, -30 dBm, Ch 2, 1 Mohm †	-0.5	0.5		
9.876 MHz, -18 dBm, Ch 2, 1 Mohm †	-0.5	0.5		
9.876 MHz, -6 dBm, Ch 2, 1 Mohm †	-0.5	0.5		
9.876 MHz, 6 dBm, Ch 2, 1 Mohm †	-0.5	0.5		
9.876 MHz, 18 dBm, Ch 2, 1 Mohm †	-0.5	0.5		
49.234 kHz, -30 dBm, Ch 1, 50 ohm	-0.5	0.5		
49.234 kHz, -18 dBm, Ch 1, 50 ohm	-0.5	0.5		

† Option AY7 only

Serial Number: _____ Report Number: _____

Amplitude Accuracy (continued)

Measurement	Lower Limit (dBm)	Upper Limit (dBm)	Measured Value (dBm)	Pass/Fail
49.234 kHz, -6 dBm, Ch 1, 50 ohm	-0.5	0.5		
49.234 kHz, 6 dBm, Ch 1, 50 ohm	-0.5	0.5		
49.234 kHz, 18 dBm, Ch 1, 50 ohm	-0.5	0.5		
49.234 kHz, -30 dBm, Ch 1, 1 Mohm	-0.5	0.5		
49.234 kHz, -18 dBm, Ch 1, 1 Mohm	-0.5	0.5		
49.234 kHz, -6 dBm, Ch 1, 1 Mohm	-0.5	0.5		
49.234 kHz, 6 dBm, Ch 1, 1 Mohm	-0.5	0.5		
49.234 kHz, 18 dBm, Ch 1, 1 Mohm	-0.5	0.5		
49.234 kHz, -30 dBm, Ch 2, 50 ohm †	-0.5	0.5		
49.234 kHz, -18 dBm, Ch 2, 50 ohm †	-0.5	0.5		
49.234 kHz, -6 dBm, Ch 2, 50 ohm †	-0.5	0.5		
49.234 kHz, 6 dBm, Ch 2, 50 ohm †	-0.5	0.5		
49.234 kHz, 18 dBm, Ch 2, 50 ohm †	-0.5	0.5		
49.234 kHz, -30 dBm, Ch 2, 1 Mohm †	-0.5	0.5		
49.234 kHz, -18 dBm, Ch 2, 1 Mohm †	-0.5	0.5		
49.234 kHz, -6 dBm, Ch 2, 1 Mohm †	-0.5	0.5		
49.234 kHz, 6 dBm, Ch 2, 1 Mohm †	-0.5	0.5		
49.234 kHz, 18 dBm, Ch 2, 1 Mohm †	-0.5	0.5		

† Option AY7 only

Serial Number: _____ Report Number: _____

Amplitude Linearity

Measurement	Lower Limit (dB)	Upper Limit (dB)	Measured Value (dB)	Pass/Fail
-10 dB, Ch 1	-0.1	0.1		
-20 dB, Ch 1	-0.1	0.1		
-30 dB, Ch 1	-0.1	0.1		
-40 dB, Ch 1	-0.15	0.15		
-50 dB, Ch 1	-0.15	0.15		
-60 dB, Ch 1	-0.2	0.2		
-70 dB, Ch 1	-0.2	0.2		
-10 dB, Ch 2 †	-0.1	0.1		
-20 dB, Ch 2 †	-0.1	0.1		
-30 dB, Ch 2 †	-0.1	0.1		
-40 dB, Ch 2 †	-0.15	0.15		
-50 dB, Ch 2 †	-0.15	0.15		
-60 dB, Ch 2 †	-0.2	0.2		
-70 dB, Ch 2 †	-0.2	0.2		

† Option AY7 only

Serial Number: _____ Report Number: _____

Amp_Phase Match (Option AY7 only)

Measurement	Lower Limit	Upper Limit	Measured Value	Pass/Fail
-30 dBm Magnitude	-0.25 dB	0.25 dB		
-30 dBm Phase	-2 deg	2 deg		
-22 dBm Magnitude	-0.25 dB	0.25 dB		
-22 dBm Phase	-2 deg	2 deg		
-14 dBm Magnitude	-0.25 dB	0.25 dB		
-14 dBm Phase	-2 deg	2 deg		
-6 dBm Magnitude	-0.25 dB	0.25 dB		
-6 dBm Phase	-2 deg	2 deg		
2 dBm Magnitude	-0.25 dB	0.25 dB		
2 dBm Phase	-2 deg	2 deg		
10 dBm Magnitude	-0.25 dB	0.25 dB		
10 dBm Phase	-2 deg	2 deg		

Intermodulation Distortion

Measurement	Lower Limit	Upper Limit (dBm)	Measured Value (dBm)	Pass/Fail
A + B, Ch 1		-111		
B - A, Ch 1		-111		
2A - B, Ch 1		-111		
2B - A, Ch 1		-111		
A + B, Ch 2 †		-111		
B - A, Ch 2 †		-111		
2A - B, Ch 2 †		-111		
2B - A, Ch 2 †		-111		

† Option AY7 only

Serial Number: _____ Report Number: _____

Input Coupling

Measurement	Lower Limit	Upper Limit (dB)	Measured Value (dB)	Pass/Fail
dc – ac, Ch 1		3		
dc – ac, Ch 2 †		3		

† Option AY7 only

Input Trigger

Measurement	Lower Limit (V)	Upper Limit (V)	Measured Value (V)	Pass/Fail
Channel 1, +2 Volt, Slope Positive	1.368	2.632		
Channel 1, +2 Volt, Slope Negative	1.368	2.632		
Channel 1, –2 Volt, Slope Positive	–2.632	–1.368		
Channel 1, –2 Volt, Slope Negative	–2.632	–1.368		
Channel 2, +2 Volt, Slope Positive †	1.368	2.632		
Channel 2, +2 Volt, Slope Negative †	1.368	2.632		
Channel 2, –2 Volt, Slope Positive †	–2.632	–1.368		
Channel 2, –2 Volt, Slope Negative †	–2.632	–1.368		

† Option AY7 only

External Trigger

Measurement	Lower Limit (V)	Upper Limit (V)	Measured Value (V)	Pass/Fail
+ 5 Volt, Slope Positive	4.5	5.5		
+ 5 Volt, Slope Negative	4.5	5.5		
–5 Volt, Slope Positive	–5.5	–4.5		
–5 Volt, Slope Negative	–5.5	–4.5		

Serial Number: _____ Report Number: _____

External Arm

Measurement	Lower Limit (V)	Upper Limit (V)	Measured Value (V)	Pass/Fail
+2 Volt, Region Above	1.5	2.5		
-2 Volt, Region Below	-2.5	-1.5		

Harmonic Distortion

Measurement	Lower Limit	Upper Limit (dBc)	Measured Value (dBc)	Pass/Fail
9.75 MHz 2nd, Ch 1		-75		
9.75 MHz 3rd, Ch 1		-75		
9.75 MHz 2nd, Ch 2 †		-75		
9.75 MHz 3rd, Ch 2 †		-75		
3.33 MHz 2nd, Ch 1		-75		
3.33 MHz 3rd, Ch 1		-75		
3.33 MHz 2nd, Ch 2 †		-75		
3.33 MHz 3rd, Ch 2 †		-75		

† Option AY7 only

Serial Number: _____ Report Number: _____

Input Capacitance

Measurement	Lower Limit	Upper Limit (pF)	Measured Value (pF)	Pass/Fail
Channel 1		80		
Channel 2 †		80		

† Option AY7 only

Input Resistance

Measurement	Lower Limit (MΩ)	Upper Limit (MΩ)	Measured Value (MΩ)	Pass/Fail
20 dBm, Ch 1	0.98	1.02		
-10 dBm, Ch 1	0.98	1.02		
-30 dBm, Ch 1	0.98	1.02		
20 dBm, Ch 2 †	0.98	1.02		
-10 dBm, Ch 2 †	0.98	1.02		
-30 dBm, Ch 2 †	0.98	1.02		

† Option AY7 only

Serial Number: _____ Report Number: _____

DC Offset

Measurement	Lower Limit	Upper Limit (dBfs)	Measured Value (dBfs)	Pass/Fail
-30 dBm, Ch 1, Filter In		-25		
-20 dBm, Ch 1, Filter In		-25		
-10 dBm, Ch 1, Filter In		-25		
0 dBm, Ch 1, Filter In		-25		
+10 dBm, Ch 1, Filter In		-25		
+20 dBm, Ch 1, Filter In		-25		
-30 dBm, Ch 1, Filter Out		-25		
-20 dBm, Ch 1, Filter Out		-25		
-10 dBm, Ch 1, Filter Out		-25		
0 dBm, Ch 1, Filter Out		-25		
+10 dBm, Ch 1, Filter Out		-25		
+20 dBm, Ch 1, Filter Out		-25		
-30 dBm, Ch 2, Filter In †		-25		
-20 dBm, Ch 2, Filter In †		-25		
-10 dBm, Ch 2, Filter In †		-25		
0 dBm, Ch 2, Filter In †		-25		
+10 dBm, Ch 2, Filter In †		-25		
+20 dBm, Ch 2, Filter In †		-25		
-30 dBm, Ch 2, Filter Out †		-25		
-20 dBm, Ch 2, Filter Out †		-25		
-10 dBm, Ch 2, Filter Out †		-25		
0 dBm, Ch 2, Filter Out †		-25		
+10 dBm, Ch 2, Filter Out †		-25		
+20 dBm, Ch 2, Filter Out †		-25		

† Option AY7 only

Serial Number: _____ Report Number: _____

Spurious Signals

Measurement	Lower Limit	Upper Limit (dBm)	Measured Value (dBm)	Pass/Fail
275 Hz Center, 450 Hz Span, Ch 1		-99		
275 Hz Center, 450 Hz Span, Ch 2 †		-99		
25 kHz Center, 10 kHz Span, Ch 1		-99		
25 kHz Center, 10 kHz Span, Ch 2 †		-99		
100 kHz Center, 50 kHz Span, Ch 1		-99		
100 kHz Center, 50 kHz Span, Ch 2 †		-99		
200 kHz Center, 50 kHz Span, Ch 1		-99		
200 kHz Center, 50 kHz Span, Ch 2 †		-99		
300 kHz Center, 50 kHz Span, Ch 1		-99		
300 kHz Center, 50 kHz Span, Ch 2 †		-99		
400 kHz Center, 50 kHz Span, Ch 1		-99		
400 kHz Center, 50 kHz Span, Ch 2 †		-99		

† Option AY7 only

Noise

Measurement	Lower Limit	Upper Limit (dBm/Hz)	Measured Value (dBm/Hz)	Pass/Fail
1 kHz to 40 kHz, Ch 1		-131		
1 kHz to 40 kHz, Ch 2 †		-131		
40 kHz to 10 MHz, Ch 1		-144		
40 kHz to 10 MHz, Ch 2 †		-144		

† Option AY7 only

Serial Number: _____ Report Number: _____

Cross Talk

Measurement	Lower Limit	Upper Limit (dBm)	Measured Value (dBm)	Pass/Fail
Source-to-Ch 1		-115		
Source-to-Ch 2 †		-115		
Ch 2-to-Ch 1 †		-115		
Ch 1-to-Ch 2 †		-115		

† Option AY7 only

Anti-Alias Filter

Measurement	Lower Limit	Upper Limit (dB)	Measured Value (dB)	Pass/Fail
15.654 MHz, Ch 1		-80		
22.454 MHz, Ch 1		-80		
29.254 MHz, Ch 1		-80		
41.254 MHz, Ch 1		-80		
48.054 MHz, Ch 1		-80		
54.854 MHz, Ch 1		-80		
66.854 MHz, Ch 1		-80		
73.654 MHz, Ch 1		-80		
15.654 MHz, Ch 2 †		-80		
22.454 MHz, Ch 2 †		-80		
29.254 MHz, Ch 2 †		-80		
41.254 MHz, Ch 2 †		-80		
48.054 MHz, Ch 2 †		-80		
54.854 MHz, Ch 2 †		-80		
66.854 MHz, Ch 2 †		-80		
73.654 MHz, Ch 2 †		-80		

† Option AY7 only

Serial Number: _____ Report Number: _____

Input Rtn Loss

Measurement	Lower Limit	Upper Limit (dB)	Measured Value (dB)	Pass/Fail
Channel 1, 50 ohm, -20 dBm		-25		
Channel 1, 50 ohm, -22 dBm		-25		
Channel 2, 50 ohm, -20 dBm †		-25		
Channel 2, 50 ohm, -22 dBm †		-25		
Channel 1, 75 ohm, -20 dBm		-20		
Channel 1, 75 ohm, -22 dBm		-20		
Channel 2, 75 ohm, -20 dBm †		-20		
Channel 2, 75 ohm, -22 dBm †		-20		

† Option AY7 only

Source Rtn Loss

Measurement	Lower Limit	Upper Limit (dB)	Measured Value (dB)	Pass/Fail
50 ohm, 0 dB Attenuator		-20		
50 ohm, 10 dB Attenuator		-20		
50 ohm, 20 dB Attenuator		-20		
50 ohm, 40 dB Attenuator		-20		
75 ohm, 0 dB Attenuator		-20		
75 ohm, 10 dB Attenuator		-20		
75 ohm, 20 dB Attenuator		-20		
75 ohm, 40 dB Attenuator		-20		

Serial Number: _____ Report Number: _____

Source Amplitude Accuracy

Measurement	Lower Limit (dB)	Upper Limit (dB)	Measured Value (dB)	Pass/Fail
9.5 MHz, -56 dBm	-2	2		
9.5 MHz, -50 dBm	-2	2		
9.5 MHz, -41 dBm	-1	1		
9.5 MHz, -35 dBm	-1	1		
9.5 MHz, -32 dBm	-1	1		
9.5 MHz, -23 dBm	-1	1		
9.5 MHz, -14 dBm	-1	1		
9.5 MHz, -8 dBm	-1	1		
9.5 MHz, 1 dBm	-1	1		
9.5 MHz, 4 dBm	-1	1		
9.5 MHz, 13 dBm	-1	1		
30 kHz, 13 dBm	-1	1		
1.8 MHz, 13 dBm	-1	1		
3.3 MHz, 13 dBm	-1	1		
4.8 MHz, 13 dBm	-1	1		
6.3 MHz, 13 dBm	-1	1		
7.8 MHz, 13 dBm	-1	1		
9.95 MHz, 13 dBm	-1	1		

Serial Number: _____ Report Number: _____

Source Distortion

Measurement	Lower Limit	Upper Limit (dBc)	Measured Value (dBc)	Pass/Fail
2.395 kHz @ 6 dBm		-55		
7.84 kHz @ 6 dBm		-55		
65.8 kHz @ 6 dBm		-40		
3.925 MHz @ 6 dBm		-40		
9.64 MHz @ 6 dBm		-33		
2.395 kHz @ 13 dBm		-55		
7.84 kHz @ 13 dBm		-55		
65.8 kHz @ 13 dBm		-40		
3.925 MHz @ 13 dBm		-40		
9.64 MHz @ 13 dBm		-33		

RF-Amplitude Accuracy

Measurement	Lower Limit (dB)	Upper Limit (dB)	Measured Value (dB)	Pass/Fail
-45 dBm Range	-1	1		
-35 dBm Range	-1	1		
-25 dBm Range	-1	1		
25 dBm Range	-1.1	1.1		

Phase Noise (With standard high-precision frequency reference only)

Measurement	Lower Limit	Upper Limit (dBc/Hz)	Measured Value (dBc/Hz)	Pass/Fail
100 Hz Offset		-89		
1 kHz Offset		-92		
10 kHz Offset		-93		
100 kHz Offset		-105		

Serial Number: _____ Report Number: _____

LO Spurs (With standard high-precision frequency reference only)

Measurement	Lower Limit	Upper Limit (dBc)	Measured Value (dBc)	Pass/Fail
94.488 kHz Offset		-75		
171.875 kHz Offset		-75		
188.976 kHz Offset		-75		
283.465 kHz Offset		-75		
1.71875 MHz Offset		-75		
10 MHz Offset		-75		

RF-Spurious Signals

Measurement	Lower Limit	Upper Limit (dBc)	Measured Value (dBc)	Pass/Fail
5.5625 MHz Tuned, 1528.5625 MHz Input		-70		
225.875 MHz Tuned, 1748.875 MHz Input		-70		
116.1875 MHz Tuned, 1969.1875 MHz Input		-70		
666.5 MHz Tuned, 2189.5 MHz Input		-70		
1524.3125 MHz Tuned, 1525 MHz Input		-70		

Serial Number: _____ Report Number: _____

RF-Harmonic Distortion

Measurement	Lower Limit	Upper Limit (dBc)	Measured Value (dBc)	Pass/Fail
159.001 MHz, 2nd, -25 dBfs		-75		
159.001 MHz, 3rd, -25 dBfs		-75		
159.001 MHz, 2nd, -30 dBfs		-54		
159.001 MHz, 3rd, -30 dBfs		-54		
679.001 MHz, 2nd, -25 dBfs		-75		
679.001 MHz, 3rd, -25 dBfs		-75		
679.001 MHz, 2nd, -30 dBfs		-54		
679.001 MHz, 3rd, -30 dBfs		-54		
1.31 GHz, 2nd, -25 dBfs		-75		
1.31 GHz, 2nd, -30 dBfs		-54		

Frequency Accuracy (with standard high-precision frequency reference only)

Measurement	Lower Limit (MHz)	Upper Limit (MHz)	Measured Value (MHz)	Pass/Fail
Accuracy at 1500 MHz				

Serial Number: _____ Report Number: _____

RF-Noise

Measurement	Lower Limit	Upper Limit (dBm/Hz)	Measured Value (dBm/Hz)	Pass/Fail
2.345 MHz, -25 dBfs		-140		
23.456 MHz, -25 dBfs		-140		
123.456 MHz, -25 dBfs		-140		
523.456 MHz, -25 dBfs		-140		
923.456 MHz, -25 dBfs		-140		
1.323456 GHz, -25 dBfs		-140		
1.723456 GHz, -25 dBfs		-140		
2.123456 GHz, -25 dBfs		-140		
2.523456 GHz, -25 dBfs		-140		
2.345 MHz, -50 dBfs		-160		
23.45 MHz, -50 dBfs		-160		
123.45 MHz, -50 dBfs		-160		
523.45 MHz, -50 dBfs		-160		
923.45 MHz, -50 dBfs		-160		
1.323456 GHz, -50 dBfs		-160		
1.723456 GHz, -50 dBfs		-160		
2.123456 GHz, -50 dBfs		-160		
2.523456 GHz, -50 dBfs		-160		

Serial Number: _____ Report Number: _____

RF Residuals

Measurement	Lower Limit	Upper Limit (dBc)	Measured Value (dBc)	Pass/Fail
10 MHz, -45 dBfs		-80		
100 MHz, -45 dBfs		-80		
200 MHz, -45 dBfs		-80		
300 MHz, -45 dBfs		-80		
400 MHz, -45 dBfs		-80		
500 MHz, -45 dBfs		-80		
600 MHz, -45 dBfs		-80		
700 MHz, -45 dBfs		-80		
800 MHz, -45 dBfs		-80		
900 MHz, -45 dBfs		-80		
1000 MHz, -45 dBfs		-80		
1100 MHz, -45 dBfs		-80		
1200 MHz, -45 dBfs		-80		
1300 MHz, -45 dBfs		-80		
1400 MHz, -45 dBfs		-80		
1500 MHz, -45 dBfs		-80		
1600 MHz, -45 dBfs		-80		
1700 MHz, -45 dBfs		-80		
1800 MHz, -45 dBfs		-80		
1900 MHz, -45 dBfs		-80		
2000 MHz, -45 dBfs		-80		
2100 MHz, -45 dBfs		-80		
2200 MHz, -45 dBfs		-80		
2300 MHz, -45 dBfs		-80		
2400 MHz, -45 dBfs		-80		
2500 MHz, -45 dBfs		-80		
2600 MHz, -45 dBfs		-80		

Serial Number: _____ Report Number: _____

RF Residuals (continued)

Measurement	Lower Limit	Upper Limit (dBm)	Measured Value (dBm)	Pass/Fail
10 MHz, -50 dBfs		-125		
100 MHz, -50 dBfs		-125		
200 MHz, -50 dBfs		-125		
300 MHz, -50 dBfs		-125		
400 MHz, -50 dBfs		-125		
500 MHz, -50 dBfs		-125		
600 MHz, -50 dBfs		-125		
700 MHz, -50 dBfs		-125		
800 MHz, -50 dBfs		-125		
900 MHz, -50 dBfs		-125		
1000 MHz, -50 dBfs		-125		
1100 MHz, -50 dBfs		-125		
1200 MHz, -50 dBfs		-125		
1300 MHz, -50 dBfs		-125		
1400 MHz, -50 dBfs		-125		
1500 MHz, -50 dBfs		-125		
1600 MHz, -50 dBfs		-125		
1700 MHz, -50 dBfs		-125		
1800 MHz, -50 dBfs		-125		
1900 MHz, -50 dBfs		-125		
2000 MHz, -50 dBfs		-125		
2100 MHz, -50 dBfs		-125		
2200 MHz, -50 dBfs		-125		
2300 MHz, -50 dBfs		-125		
2400 MHz, -50 dBfs		-125		
2500 MHz, -50 dBfs		-125		
2600 MHz, -50 dBfs		-125		

Serial Number: _____ Report Number: _____

RF-Source Amplitude Accuracy (Option AY8 only)

Measurement	Lower Limit (dBm)	Upper Limit (dBm)	Measured Value (dBm)	Pass/Fail
13 dBm accuracy	11.8	14.2		
-5 dBm accuracy	-6.2	-3.8		
-10 dBm accuracy	-11.2	-8.8		
-20 dBm accuracy	-21.2	-18.8		

RF-Source IF-Flatness (Option AY8 only)

Measurement	Lower Limit (dB)	Upper Limit (dB)	Measured Value (dB)	Pass/Fail
IF flatness	-1	1		

RF-Source Spurious (Option AY8 only)

Measurement	Lower Limit	Upper Limit (dBc)	Measured Value (dBc)	Pass/Fail
5.5625 MHz, No Offset, 0 dBm		-40		
5.5625 MHz, Offset, 0 dBm		-40		
270.40625 MHz, No Offset, 0 dBm		-40		
270.40625 MHz, Offset, 0 dBm		-40		
535.25 MHz, No Offset, 0 dBm		-40		
535.25 MHz, Offset, 0 dBm		-40		
800.09375 MHz, No Offset, 0 dBm		-40		
800.09375 MHz, Offset, 0 dBm		-40		
1064.9375 MHz, No Offset, 0 dBm		-40		
1064.9375 MHz, Offset, 0 dBm		-40		
1329.78125 MHz, No Offset, 0 dBm		-40		
1329.78125 MHz, Offset, 0 dBm		-40		
1594.625 MHz, No Offset, 0 dBm		-40		
1594.625 MHz, Offset, 0 dBm		-40		

Serial Number: _____ Report Number: _____

RF-Source Spurious (continued)

Measurement	Lower Limit	Upper Limit (dBc)	Measured Value (dBc)	Pass/Fail
1859.46875 MHz, No Offset, 0 dBm		-40		
1859.46875 MHz, Offset, 0 dBm		-40		
2124.3125 MHz, No Offset, 0 dBm		-40		
2124.3125 MHz, Offset, 0 dBm		-40		
2389.15625 MHz, No Offset, 0 dBm		-40		
2389.15625 MHz, Offset, 0 dBm		-40		
5.5625 MHz, No Offset, -4.99 dBm		-40		
5.5625 MHz, Offset, -4.99 dBm		-40		
270.40625 MHz, No Offset, -4.99 dBm		-40		
270.40625 MHz, Offset, -4.99 dBm		-40		
535.25 MHz, No Offset, -4.99 dBm		-40		
535.25 MHz, Offset, -4.99 dBm		-40		
800.09375 MHz, No Offset, -4.99 dBm		-40		
800.09375 MHz, Offset, -4.99 dBm		-40		
1064.9375 MHz, No Offset, -4.99 dBm		-40		
1064.9375 MHz, Offset, -4.99 dBm		-40		
1329.78125 MHz, No Offset, -4.99 dBm		-40		
1329.78125 MHz, Offset, -4.99 dBm		-40		
1594.625 MHz, No Offset, -4.99 dBm		-40		
1594.625 MHz, Offset, -4.99 dBm		-40		
1859.46875 MHz, No Offset, -4.99 dBm		-40		
1859.46875 MHz, Offset, -4.99 dBm		-40		
2124.3125 MHz, No Offset, -4.99 dBm		-40		
2124.3125 MHz, Offset, -4.99 dBm		-40		
2389.15625 MHz, No Offset, -4.99 dBm		-40		
2389.15625 MHz, Offset, -4.99 dBm		-40		

Serial Number: _____ Report Number: _____

RF-Source Distortion (Option AY8 only)

Measurement	Lower Limit	Upper Limit (dBc)	Measured Value (dBc)	Pass/Fail
2.123 MHz, 2nd		-40		
2.123 MHz, 3rd		-40		
100.123 MHz, 2nd		-40		
100.123 MHz, 3rd		-40		
300.123 MHz, 2nd		-40		
300.123 MHz, 3rd		-40		
500.123 MHz, 2nd		-40		
500.123 MHz, 3rd		-40		
700.123 MHz, 2nd		-40		
700.123 MHz, 3rd		-40		
900.123 MHz, 2nd		-40		
900.123 MHz, 3rd		-40		
1100.123 MHz, 2nd		-40		
1100.123 MHz, 3rd		-40		
1300.123 MHz, 2nd		-40		
1300.123 MHz, 3rd		-40		
1500.123 MHz, 2nd		-40		
1500.123 MHz, 3rd		-40		
1700.123 MHz, 2nd		-40		
1700.123 MHz, 3rd		-40		
1900.123 MHz, 2nd		-40		
1900.123 MHz, 3rd		-40		
2100.123 MHz, 2nd		-40		
2100.123 MHz, 3rd		-40		
2300.123 MHz, 2nd		-40		
2300.123 MHz, 3rd		-40		
2500.123 MHz, 2nd		-40		
2500.123 MHz, 3rd		-40		

Serial Number: _____ Report Number: _____

RF-Source Noise (Option AYS only)

Measurement	Lower Limit	Upper Limit (dBc/Hz)	Measured Value (dBc/Hz)	Pass/Fail
101 MHz, 1 MHz Offset		-120		
2552.046875 MHz, 1 MHz Offset		-120		
2552.046875 MHz, 3 MHz Offset		-120		
2552.046875 MHz, 5 MHz Offset		-120		
2552.046875 MHz, 7 MHz Offset		-120		
2552.046875 MHz, 9 MHz Offset		-120		
2552.046875 MHz, 10 MHz Offset		-120		

Operation Verification Test Record

Test Facility _____

Facility Address _____

Tested By _____

Report Number _____

Customer Name _____

Agilent 89410A Serial Number _____

Agilent 89431A Serial Number _____

Installed Options _____

Date _____

Temperature _____

Humidity _____

Power Line Frequency _____

Test Instruments Used

Instrument	Model	ID or Serial Number	Calibration Due
Synthesizer			
Baseband Analyzer			
Multimeter			
Step Attenuator, 1 dB			
Step Attenuator, 10 dB			
Signal Generator			
Power Meter #1			
Power Meter #2			
Power Sensor #1			
Power Sensor #2			
Milliwatt Power Meter			

Serial Number: _____ Report Number: _____

Self Test

Measurement	Lower Limit	Upper Limit	Measured Value	Pass/Fail
Long Confidence				

Amplitude Accuracy

Measurement	Lower Limit (dBm)	Upper Limit (dBm)	Measured Value (dBm)	Pass/Fail
9.876 MHz, -18 dBm, Ch 1, 50 ohm	-0.5	0.5		
9.876 MHz, 6 dBm, Ch 1, 50 ohm	-0.5	0.5		
9.876 MHz, -18 dBm, Ch 1, 1 Mohm	-0.5	0.5		
9.876 MHz, 6 dBm, Ch 1, 1 Mohm	-0.5	0.5		
9.876 MHz, -18 dBm, Ch 2, 50 ohm †	-0.5	0.5		
9.876 MHz, 6 dBm, Ch 2, 50 ohm †	-0.5	0.5		
9.876 MHz, -18 dBm, Ch 2, 1 Mohm †	-0.5	0.5		
9.876 MHz, 6 dBm, Ch 2, 1 Mohm †	-0.5	0.5		
49.234 kHz, -18 dBm, Ch 1, 50 ohm	-0.5	0.5		
49.234 kHz, 6 dBm, Ch 1, 50 ohm	-0.5	0.5		
49.234 kHz, -18 dBm, Ch 1, 1 Mohm	-0.5	0.5		
49.234 kHz, 6 dBm, Ch 1, 1 Mohm	-0.5	0.5		
49.234 kHz, -18 dBm, Ch 2, 50 ohm †	-0.5	0.5		
49.234 kHz, 6 dBm, Ch 2, 50 ohm †	-0.5	0.5		
49.234 kHz, -18 dBm, Ch 2, 1 Mohm †	-0.5	0.5		
49.234 kHz, 6 dBm, Ch 2, 1 Mohm †	-0.5	0.5		

† Option AY7 only

Serial Number: _____ Report Number: _____

Amp_Phase Match (Option AY7 only)

Measurement	Lower Limit	Upper Limit	Measured Value	Pass/Fail
-30 dBm Magnitude	-0.25 dB	0.25 dB		
-30 dBm Phase	-2 deg	2 deg		
-22 dBm Magnitude	-0.25 dB	0.25 dB		
-22 dBm Phase	-2 deg	2 deg		
-14 dBm Magnitude	-0.25 dB	0.25 dB		
-14 dBm Phase	-2 deg	2 deg		
-6 dBm Magnitude	-0.25 dB	0.25 dB		
-6 dBm Phase	-2 deg	2 deg		
2 dBm Magnitude	-0.25 dB	0.25 dB		
2 dBm Phase	-2 deg	2 deg		
10 dBm Magnitude	-0.25 dB	0.25 dB		
10 dBm Phase	-2 deg	2 deg		

Input Coupling

Measurement	Lower Limit	Upper Limit (dB)	Measured Value (dB)	Pass/Fail
dc – ac, Ch 1		3		
dc – ac, Ch 2 †		3		

† Option AY7 only

Input Trigger

Measurement	Lower Limit (V)	Upper Limit (V)	Measured Value (V)	Pass/Fail
Channel 1, +2 Volt, Slope Negative	1.368	2.632		
Channel 1, -2 Volt, Slope Positive	-2.632	-1.368		
Channel 2, +2 Volt, Slope Negative †	1.368	2.632		
Channel 2, -2 Volt, Slope Positive †	-2.632	-1.368		

† Option AY7 only

Serial Number: _____ Report Number: _____

External Trigger

Measurement	Lower Limit (V)	Upper Limit (V)	Measured Value (V)	Pass/Fail
+ 5 Volt, Slope Negative	4.5	5.5		
-5 Volt, Slope Positive	-5.5	-4.5		

External Arm

Measurement	Lower Limit (V)	Upper Limit (V)	Measured Value (V)	Pass/Fail
+ 2 Volt, Region Above	1.5	2.5		
-2 Volt, Region Below	-2.5	-1.5		

Harmonic Distortion

Measurement	Lower Limit	Upper Limit (dBc)	Measured Value (dBc)	Pass/Fail
9.75 MHz 2nd, Ch 1		-75		
9.75 MHz 3rd, Ch 1		-75		
9.75 MHz 2nd, Ch 2 †		-75		
9.75 MHz 3rd, Ch 2 †		-75		

† Option AY7 only

Serial Number: _____ Report Number: _____

DC Offset

Measurement	Lower Limit	Upper Limit (dBfs)	Measured Value (dBfs)	Pass/Fail
-30 dBm, Ch 1, Filter In		-25		
-20 dBm, Ch 1, Filter In		-25		
-10 dBm, Ch 1, Filter In		-25		
0 dBm, Ch 1, Filter In		-25		
+10 dBm, Ch 1, Filter In		-25		
+20 dBm, Ch 1, Filter In		-25		
-30 dBm, Ch 2, Filter In †		-25		
-20 dBm, Ch 2, Filter In †		-25		
-10 dBm, Ch 2, Filter In †		-25		
0 dBm, Ch 2, Filter In †		-25		
+10 dBm, Ch 2, Filter In †		-25		
+20 dBm, Ch 2, Filter In †		-25		

† Option AY7 only

Serial Number: _____ Report Number: _____

Spurious Signals

Measurement	Lower Limit	Upper Limit (dBm)	Measured Value (dBm)	Pass/Fail
275 Hz Center, 450 Hz Span, Ch 1		-99		
275 Hz Center, 450 Hz Span, Ch 2 †		-99		
25 kHz Center, 10 kHz Span, Ch 1		-99		
25 kHz Center, 10 kHz Span, Ch 2 †		-99		
100 kHz Center, 50 kHz Span, Ch 1		-99		
100 kHz Center, 50 kHz Span, Ch 2 †		-99		
200 kHz Center, 50 kHz Span, Ch 1		-99		
200 kHz Center, 50 kHz Span, Ch 2 †		-99		
300 kHz Center, 50 kHz Span, Ch 1		-99		
300 kHz Center, 50 kHz Span, Ch 2 †		-99		
400 kHz Center, 50 kHz Span, Ch 1		-99		
400 kHz Center, 50 kHz Span, Ch 2 †		-99		

† Option AY7 only

Noise

Measurement	Lower Limit	Upper Limit (dBm/Hz)	Measured Value (dBm/Hz)	Pass/Fail
1 kHz to 40 kHz, Ch 1		-131		
1 kHz to 40 kHz, Ch 2 †		-131		
40 kHz to 10 MHz, Ch 1		-144		
40 kHz to 10 MHz, Ch 2 †		-144		

† Option AY7 only

Serial Number: _____ Report Number: _____

Source Amplitude Accuracy

Measurement	Lower Limit (dB)	Upper Limit (dB)	Measured Value (dB)	Pass/Fail
9.5 MHz, -56 dBm	-2	2		
9.5 MHz, -50 dBm	-2	2		
9.5 MHz, -41 dBm	-1	1		
9.5 MHz, -35 dBm	-1	1		
9.5 MHz, -32 dBm	-1	1		
9.5 MHz, -23 dBm	-1	1		
9.5 MHz, -14 dBm	-1	1		
9.5 MHz, -8 dBm	-1	1		
9.5 MHz, 1 dBm	-1	1		
9.5 MHz, 4 dBm	-1	1		
9.5 MHz, 13 dBm	-1	1		
30 kHz, 13 dBm	-1	1		
1.8 MHz, 13 dBm	-1	1		
3.3 MHz, 13 dBm	-1	1		
4.8 MHz, 13 dBm	-1	1		
6.3 MHz, 13 dBm	-1	1		
7.8 MHz, 13 dBm	-1	1		
9.95 MHz, 13 dBm	-1	1		

Source Distortion

Measurement	Lower Limit	Upper Limit (dBc)	Measured Value (dBc)	Pass/Fail
2.395 kHz @ 6 dBm		-55		
7.84 kHz @ 6 dBm		-55		
65.8 kHz @ 6 dBm		-40		
3.925 MHz @ 6 dBm		-40		
9.64 MHz @ 6 dBm		-33		

Serial Number: _____ Report Number: _____

RF-Amplitude Accuracy

Measurement	Lower Limit (dB)	Upper Limit (dB)	Measured Value (dB)	Pass/Fail
-45 dBm Range	-1	1		
-35 dBm Range	-1	1		
-25 dBm Range	-1	1		
25 dBm Range	-1.1	1.1		

Phase Noise (With standard high-precision frequency reference only)

Measurement	Lower Limit (dBc/Hz)	Upper Limit (dBc/Hz)	Measured Value (dBc/Hz)	Pass/Fail
100 Hz Offset		-96		
1 kHz Offset		-104		
10 kHz Offset		-116		
100 kHz Offset		-116		

Serial Number: _____ Report Number: _____

RF-Harmonic Distortion

Measurement	Lower Limit	Upper Limit (dBc)	Measured Value (dBc)	Pass/Fail
159.001 MHz, 2nd, -30 dBfs		-54		
159.001 MHz, 3rd, -30 dBfs		-54		
679.001 MHz, 2nd, -30 dBfs		-54		
679.001 MHz, 3rd, -30 dBfs		-54		
1.31 GHz, 2nd, -30 dBfs		-54		

Frequency Accuracy

Measurement	Lower Limit (MHz)	Upper Limit (MHz)	Measured Value (MHz)	Pass/Fail
Accuracy at 1500 MHz				

RF-Noise

Measurement	Lower Limit	Upper Limit (dBm/Hz)	Measured Value (dBm/Hz)	Pass/Fail
2.345 MHz, -50 dBfs		-160		
123.456 MHz, -50 dBfs		-160		
923.456 MHz, -50 dBfs		-160		
1.723456 GHz, -50 dBfs		-160		
2.523456 GHz, -50 dBfs		-160		

Serial Number: _____ Report Number: _____

RF Residuals

Measurement	Lower Limit	Upper Limit (dBc)	Measured Value (dBc)	Pass/Fail
10 MHz, -45 dBfs		-80		
100 MHz, -45 dBfs		-80		
200 MHz, -45 dBfs		-80		
300 MHz, -45 dBfs		-80		
400 MHz, -45 dBfs		-80		
500 MHz, -45 dBfs		-80		
600 MHz, -45 dBfs		-80		
700 MHz, -45 dBfs		-80		
800 MHz, -45 dBfs		-80		
900 MHz, -45 dBfs		-80		
1000 MHz, -45 dBfs		-80		
1100 MHz, -45 dBfs		-80		
1200 MHz, -45 dBfs		-80		
1300 MHz, -45 dBfs		-80		
1400 MHz, -45 dBfs		-80		
1500 MHz, -45 dBfs		-80		
1600 MHz, -45 dBfs		-80		
1700 MHz, -45 dBfs		-80		
1800 MHz, -45 dBfs		-80		
1900 MHz, -45 dBfs		-80		
2000 MHz, -45 dBfs		-80		
2100 MHz, -45 dBfs		-80		
2200 MHz, -45 dBfs		-80		
2300 MHz, -45 dBfs		-80		
2400 MHz, -45 dBfs		-80		
2500 MHz, -45 dBfs		-80		
2600 MHz, -45 dBfs		-80		

Serial Number: _____ Report Number: _____

RF-Source Amplitude Accuracy (Option AY8 only)

Measurement	Lower Limit (dBm)	Upper Limit (dBm)	Measured Value (dBm)	Pass/Fail
13 dBm accuracy	11.8	14.2		
-5 dBm accuracy	-6.2	-3.8		
-10 dBm accuracy	-11.2	-8.8		
-20 dBm accuracy	-21.2	-18.8		

RF-Source IF-Flatness (Option AY8 only)

Measurement	Lower Limit (dB)	Upper Limit (dB)	Measured Value (dB)	Pass/Fail
IF flatness	-1	1		

RF-Source Spurious (Option AY8 only)

Measurement	Lower Limit	Upper Limit (dBc)	Measured Value (dBc)	Pass/Fail
5.5625 MHz, No Offset, 0 dBm		-40		
5.5625 MHz, Offset, 0 dBm		-40		
535.25 MHz, No Offset, 0 dBm		-40		
535.25 MHz, Offset, 0 dBm		-40		
1064.9375 MHz, No Offset, 0 dBm		-40		
1064.9375 MHz, Offset, 0 dBm		-40		
1594.625 MHz, No Offset, 0 dBm		-40		
1594.625 MHz, Offset, 0 dBm		-40		
2124.3125 MHz, No Offset, 0 dBm		-40		
2124.3125 MHz, Offset, 0 dBm		-40		

Serial Number: _____ Report Number: _____

RF-Source Distortion (Option AY8 only)

Measurement	Lower Limit	Upper Limit (dBc)	Measured Value (dBc)	Pass/Fail
2.123 MHz, 2nd		-40		
2.123 MHz, 3rd		-40		
300.123 MHz, 2nd		-40		
300.123 MHz, 3rd		-40		
700.123 MHz, 2nd		-40		
700.123 MHz, 3rd		-40		
1100.123 MHz, 2nd		-40		
1100.123 MHz, 3rd		-40		
1500.123 MHz, 2nd		-40		
1500.123 MHz, 3rd		-40		
1900.123 MHz, 2nd		-40		
1900.123 MHz, 3rd		-40		
2300.123 MHz, 2nd		-40		
2300.123 MHz, 3rd		-40		

RF-Source Noise (Option AY8 only)

Measurement	Lower Limit	Upper Limit (dBc/Hz)	Measured Value (dBc/Hz)	Pass/Fail
101 MHz, 1 MHz Offset		-120		
2552.046875 MHz, 1 MHz Offset		-120		
2552.046875 MHz, 3 MHz Offset		-120		
2552.046875 MHz, 5 MHz Offset		-120		
2552.046875 MHz, 7 MHz Offset		-120		
2552.046875 MHz, 9 MHz Offset		-120		
2552.046875 MHz, 10 MHz Offset		-120		

Index

A

ac line voltage 1-2
accessories vii
air circulation 1-9
amplitude performance test
 accuracy 2-17
 accuracy, RF 2-60
 linearity 2-23
 phase match 2-25
 source accuracy 2-58
 source accuracy, RF 2-70
anti-alias filter performance test 2-49
assistance (rear matter)
AUI (attachment unit interface) port
 1-14

C

calibration
 See performance test
capacitance performance test 2-39
centronics port 1-15
channel
 match performance test 2-25
 optional IF input v
circulation, air 1-9
cleaning the screen 1-21
conformity, declaration of (rear matter)
connecting
 frequency reference 1-7
 IF section to RF section 1-7
 minimum loss pad 1-20
connector
 AUI (attachment unit interface) 1-14
 external monitor 1-17
 external reference 1-7
 grounding requirements 1-3
 GPIB 1-16
 input 1-8
 keyboard 1-18
 oven reference 1-7
 parallel 1-15

connector (continued)
 serial 1-15
 source 1-8
 system interconnect 1-16
 ThinLAN 1-14
cooling 1-9
cords, power 1-3
coupling performance test 2-30
crosstalk performance test 2-47

D

dc offset performance test 2-44
disk drive
 flexible disks for vi
 loading performance test 2-10
display
 cleaning 1-21
 connecting external 1-17
distortion performance test
 harmonic 2-36
 harmonic, RF 2-65
 intermodulation 2-27
 source 2-59
 source, RF 2-72 to 2-73

E

environment, operating 1-9
equipment required 2-3
error message
 insufficient memory 2-10
 wrong disk 2-10
external
 arm performance test 2-35
 frequency reference 1-7
 keyboard 1-18
 monitor 1-17
 trigger performance test 2-34

F

- failure
 - power up 1-23
 - stop frequency is 10 MHz 1-25
- firmware version (rear matter)
- flatness
 - source test, RF 2-71
- flexible disks vii
- frequency
 - accuracy performance test 2-67
 - reference 1-7
 - stop frequency is 10 MHz 1-25
- fuse 1-12

G

- grounding requirements 1-3
- GPIB connector 1-16

H

- harmonic distortion
 - performance test 2-36
 - performance test, RF 2-65
- help (rear matter)

I

- IF section
 - connecting to RF section 1-7
 - fuse 1-12
 - model number 1-10
 - voltage selector switch 1-10
- incoming inspection 1-5
- input performance test
 - capacitance 2-39
 - coupling 2-30
 - resistance 2-42
 - return loss 2-51
 - trigger 2-32
- input, ordering optional iv
- installation 1-9
- insufficient memory 2-10
- interface
 - GPIB 1-16
 - LAN (local area network) 1-14
 - parallel 1-15
 - serial 1 1-15
 - serial 2 1-7
- intermodulation distortion test 2-27

K

- keyboard
 - connecting 1-18

L

- LAN (local area network), connecting
 - 1-14
- line voltage
 - IF selector switch 1-10
 - required 1-2
 - RF selector switch 1-11
- linearity performance test 2-23
- LO spurs performance test 2-63
- loading performance test program 2-10

M

- manual mode performance program
 - 2-15
- memory, insufficient 2-10
- menu, performance test 2-75
- minimum loss pad 1-20
- model number
 - IF section 1-10
 - RF section 1-11
- monitor, connecting external 1-17

N

- noise performance test
 - baseband 2-46
 - phase 2-62
 - RF 2-68
 - source, RF 2-74

O

- offset performance test 2-44
- operating environment 1-9
- operation verification
 - confidence level 2-7
 - test list 2-7
- options, ordering v
- oven frequency reference
 - connecting 1-7
 - ordering optional v

P

- parallel port 1-15
- performance test
 - confidence level 2-7
 - cycle 2-3
 - list of 2-7
 - versus specification 2-8

- performance test program
 - controlled equipment 2-3
 - loading 2-10
 - manual mode 2-15
 - overview 2-2
 - semiautomated mode 2-11
 - softkey descriptions 2-75
 - without a printer 2-13
- phase performance test
 - channel match 2-25
 - noise 2-62
- plotter interface 1-15
- power
 - consumption 1-2
 - cords 1-3
 - turn on failure 1-23
- printer
 - interface 1-15
 - running program without 2-13
 - supported by program 2-3
- problem
 - help with (rear matter)
 - IF section will not power up 1-23
 - loading performance test program 2-10
 - RF section will not power up 1-24
 - stop frequency is 10 MHz 1-25
- program
 - See performance test program
- R**
- recommended test equipment 2-3
- reference
 - connecting 1-7
 - ordering optional v
 - performance test 2-67
- requirements
 - grounding 1-3
 - power 1-2
- residual responses test 2-45
- resistance performance test 2-42
- return loss
 - input performance test 2-51
 - source performance test 2-55
- RF performance test
 - amplitude accuracy 2-60
 - harmonic distortion 2-65
 - noise 2-68
 - source amplitude accuracy 2-70
 - source distortion 2-72 to 2-73
 - source IF flatness 2-71
 - source noise 2-74
- RF performance test (continued)
 - spurious signals 2-64
- RF section
 - connecting to IF section 1-7
 - fuse 1-13
 - model number 1-11
 - voltage selector switch 1-11
- running performance test program
 - manual mode 2-15
 - semiautomated mode 2-11
 - without printer 2-13
- S**
- safety
 - See inside front cover
- screen, cleaning 1-21
- self test 2-16
- semiautomated performance program 2-11
- serial
 - 1 port 1-15
 - 2 port 1-7
 - number (rear matter)
- shipping 1-22
- softkey, performance test descriptions 2-75
- software
 - See performance test program
 - version (rear matter)
- source performance test
 - amplitude accuracy 2-58
 - amplitude accuracy, RF 2-70
 - distortion 2-59
 - distortion, RF 2-72 to 2-73
 - flatness 2-71
 - noise 2-74
 - return loss 2-55
- source, ordering optional RF iv
- specifications 2-8
- spurious performance test
 - LO 2-63
 - signals 2-45
 - signals, RF 2-64
- supplied accessories vi
- system interconnect 1-16
- T**
- test
 - duration 2-3
 - records, printing 2-3
- test equipment 2-3
- ThinLAN port 1-14

transporting 1-22
trigger performance test
 external 2-34
 external arm 2-35
 input 2-32

U

upgrading v

V

verification
 See operation verification
voltage selector switch
 IF section 1-10
 RF section 1-11

W

warm up time, performance test 2-67
wrong disk message 2-10

Agilent 89400-Series Documentation Roadmap

If you are thinking about...	And you want to...	Then read the analyzer's...
Unpacking and installing the analyzer	Install the analyzer, or do operation verification or performance verification tests	<i>Installation and Verification Guide</i>
Getting started	Make your first measurements with your new analyzer	<i>Getting Started Guide</i>
	Review measurement concepts	<i>Operator's Guide</i>
	Learn what each key does	Online Help (press the [Help] key)
Making measurements	Learn how to make typical measurements	<i>Getting Started Guide and Operator's Guide</i>
Creating automated measurements (To receive Instrument BASIC and Agilent Instrument BASIC manuals, order option 1C2)	Learn the Agilent Instrument BASIC interface	<i>Agilent 89400-Series Using Agilent Instrument BASIC</i>
	Program with Agilent Instrument BASIC	<i>Agilent Instrument BASIC User's Handbook</i>
Remote operation	Learn about the GPIB and SCPI	<i>GPIB Programmer's Guide</i>
	Find specific GPIB commands quickly	<i>Agilent 89400-Series GPIB Commands: Quick Reference</i>
	Find GPIB command details	<i>Agilent 89400-Series GPIB Command Reference</i>
Using analyzer data with a PC application	Transfer analyzer data to or from a PC (Personal Computer) application	<i>Standard Data Format Utilities: User's Guide</i>
	Display analyzer data on a PC, or display PC data on the analyzer	
Servicing the analyzer (To receive service information, order option 0B3)	Adjust, troubleshoot, or repair the analyzer	<i>Service Guide</i>

89441-90067

1

About this edition

June 2000: This edition was created to accommodate the the transition from Hewlett-Packard to Agilent Technologies

November 1996: In this edition, the *Technical Data* publication was revised to reflect the following new features: adaptive equalization, extended arbitrary source lengths, and peak/average statistics.

September 1995: In this edition, the title page was changed. The *Auto Performance Test* disk changed to revision A.01.02.

July 1995: In this edition, specifications for option AYH, Digital Video Modulation Analysis, were added to the 89441A Technical Data publication.

May 1995: In this edition, the title page was changed. The *Auto Performance Test* disk changed to revision A.01.01. Revision A.01.01 was designed for use with IF section firmware version A.03.00 and RF section firmware version A.00.00.

January 1995: In this edition, performance tests were added for the optional RF source. The *Auto Performance Test* disk changed to revision A.01.00. Revision A.01.00 was designed for use with IF section firmware version A.02.06 and RF section firmware version A.00.04.

July 1994: In this edition, the "Specifications" chapter was replaced with the *89441A Technical Data* publication. The *Auto Performance Test* disk changed to revision A.00.01. Revision A.00.01 was designed for use with IF section firmware version A.02.01 and RF section firmware version A.00.00.

Need Assistance?

If you need assistance, contact your nearest Agilent Technologies Sales and Service Office listed in the Agilent Catalog. You can also find a list of local service representatives on the Web at:

<http://www.agilent.com/services/English/index.html> or contact your nearest regional office listed below.

If you are contacting Agilent Technologies about a problem with your Agilent 89441A Vector Signal Analyzer, please provide the following information:

- Model number: Agilent 89441A
- Serial number:
- Options:
- Date the problem was first encountered:
- Circumstances in which the problem was encountered:
- Can you reproduce the problem?
- What effect does this problem have on you?

You may find the serial number and options from the front panel of your analyzer by executing the following:

Press [**System Utility**], [more], [serial number].

Press [**System Utility**], [options setup].

If you do not have access to the Internet, one of these centers can direct you to your nearest representative:

United States	Test and Measurement Call Center (800) 452-4844 (Toll free in US)
Canada	(905) 206-4725
Europe	(31 20) 547 9900
Japan	Measurement Assistance Center (81) 426 56 7832 (81) 426 56 7840 (FAX)
Latin America	(305) 267 4245 (305) 267 4288 (FAX)
Australia/New Zealand	1 800 629 485 (Australia) 0800 738 378 (New Zealand)
Asia-Pacific	(852) 2599 7777 (FAX) (852) 2506 9285

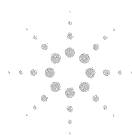

Agilent Technologies