

Agilent Technologies 8935 Series E6381A TDMA Base Station Test Set

Reference Guide

Firmware Version A.02.01 and above



Manufacturing Part Number: E6381-90019

**Revision D
Printed in UK
January 2001**

Notice

Information contained in this document is subject to change without notice.

All Rights Reserved. Reproduction, adaptation, or translation without prior written permission is prohibited, except as allowed under the copyright laws.

This material may be reproduced by or for the U.S. Government pursuant to the Copyright License under the clause at DFARS 52.227-7013 (APR 1988).

© Copyright 2001 Agilent Technologies
All Rights Reserved

General Information

Manufacturer's Declaration	8
Safety Considerations	9
Safety Considerations for This Instrument	10
Product Markings	14
Certification	15
Agilent Technologies Warranty Statement for Commercial Products	17
Assistance	19
Documentation	21
Conventions Used in This Manual	22
Which Document is Required?	22
Trademark Acknowledgements	23
Power Cables	24

Getting Started

Before Connecting a Radio	32
Changing the Test Set's Display	33
Changing the Measurement Screen	33
Changing the Control Fields	35
How do I Verify that the Test Set is Operating Properly?	39
Instrument Functional Check	39

Operating Overview

Displaying TDMA Measurements	45
Displaying Analog Measurements	46
RF Measurements	46
Displaying AF Measurements	48
Displaying Measurement Results on a Meter Scale	50
To display the meter scale	50
To set the meter's end points and scale intervals	50
Using Channel Numbers to Set Analyzer and Generator Frequencies	51
Changing the Increment or Decrement Setting	52
Specifying An Increment Value for the Arrow Keys or Knob	52
Using the Factor of 10 Increment/Decrement Keys	52
Using Measurement Limit Indicators	53
To set high and low limits	53
To reset or remove limits	54
Setting A Measurement Reference	55
To set a reference	55
Averaging Measurements	56
To use measurement averaging	56
How the Test Set Averages Measurements	56

Setting an RF Generator/Analyzer Offset	57
To set an RF Offset	57
Saving and Recalling Instrument Setups	58
To save an instrument setup	58
To recall an instrument setup	58
To remove (clear) an individual save register	59
To clear all save registers	59
Register Names	59
Memory Considerations	60
Instrument Hardware Changes	60
Using USER Keys	61
Using Pre-Defined USER Keys	61
Assigning and Releasing USER Keys	62
Replacing Batteries	63
Initializing (Formatting) a PC Card	64
TDMA Measurement Basics	
Prerequisites	66
TDMA Test Screen Overview	67
Generating and Analyzing TDMA Signals	67
Displaying TDMA Measurements and Instrument Status ..	68
Making TDMA Measurements	69
Measuring Transmitter EVM, Average Power, and Adjacent Channel Power, Channel Power	69
Reference Connections	75
Phase Locking to the Base Station's Reference	75
Setting Attenuator Level for Input Ports	77
Status Codes for the Digital Analyzer	78
How to Decode the Status Codes	78
Error Vector Magnitude (EVM) Measurement Status Codes ..	79
Bit Error Rate (BERT) Measurement Status Codes	80
Adjacent Channel Power (ACP) Measurement Status Codes ..	81
Channel Power and Average Power	81
Mobile Assisted Handoff (MAHO) Status Codes	82
TDMA Tests Using HP-IB	83
Overview of the Test Set's Built-In Tools	
Using the RF Tools Program	89
Loading and Running RF Tools	89
Test Results/BTS Utility Setup	90
Swept Gain	93
Discrete Frequency Insertion Loss	96
Swept Insertion Loss	99

Swept Return Loss	102
Cable Fault	106
Replot Data Files	112
Transfer Stored Data	112
SA (Spectrum Analyzer) Self Calibration ON/OFF	113
Catalog PC (Memory) Card	115
Using the Spectrum Analyzer	116
Automatic Calibration	116
Setting Resolution Bandwidth and Sweep Rate	116
Selecting the Spectrum Analyzer's Controls Menus	117
Using the Delta Markers	117
Using the Spectrum Analyzer Mask	119
Using the Voltmeter and Audio Frequency Counter	123
Using the Oscilloscope (Scope)	125
Selecting the Oscilloscope's Input	126
Selecting the Oscilloscope's Filters	126
Triggering the Oscilloscope	127
Using the Oscilloscope's Marker	127
Using IB_UTIL Programs	128
COPY_PL	128
FILE_XFER	128
RAM_USAGE	128
Securing a Test Procedure	129
Clearing RAM	130
Using the LISTOPTS (list options) Program	131
To run the LISTOPTS program	131
Using the ST_PLT (store or plot) Program	132
To run the ST_PLT program	132
Signaling Encoder and Decoder	
Signaling Encoder and Decoder Basics	134
The Decoder's Signal Source	134
Decoder Frequency Measurements	134
The Encoder	134
AMPS-TACS, NAMPS-NTACS Encoder and Decoder	135
Control and Voice Channel Identifiers	135
Encoder/Decoder Interaction	135
AMPS-TACS, NAMPS-NTACS Decoder	136
Interpreting Decoded Data	136
DTMF Sequence Encoder and Decoder	140
Measurement Limits	140
Function Generator Encoder and Decoder	141
Decoding Considerations	141

Contents

De-emphasis and Input Level	142
Twist and Pre-emphasis	143
Twist	143
Connectors	
Descriptions of Connectors	146
10 MHz REF OUT	146
ANT IN	146
AUDIO IN	147
AUDIO MONITOR OUT	148
AUDIO OUT	149
Chassis Ground	149
DIGITAL MUX OUT	149
DUPLEX OUT	149
EXT SCOPE TRIG IN	150
FRAME CLK OUT	150
GENERATOR DATA IN	150
HP-IB	151
PC Card Slot	151
OPTIONAL CDPD MOD OUT	151
MODULATION INPUT	151
PARALLEL 15	152
PARALLEL 16	152
RF IN/OUT	153
SERIAL 9, 10, and 11	154
SYNTH REF IN	155
TDMA ANALYZER INPUTS	155
TDMA OUTPUTS	156
TDMA REF IN	157
VIDEO OUT	157
Error Messages	
General Information About Error Messages	160
Positive Numbered Error Messages	160
Negative Numbered Error Messages	161
IBASIC Error Messages	161
HP-IB Error Messages	161
Text Only Error Messages	162
The Message Display	163
Non-Recoverable Firmware Error	163
Text Only Error Messages	164

1**General Information**

This chapter contains generic information about the product, safety, warranty, sales and service offices, power cables, and other information.

Manufacturer's Declaration

This statement is provided to comply with the requirements of the German Sound Emission Directive, from 18 January 1991.

This product has the following sound pressure emission specification:

- sound pressure $L_p < 70$ dB(A)
- at the operator position
- under normal operation
- according to ISO 7779:1988/EN 27779:1991 (Type Test).

Herstellerbescheinigung

Diese Information steht im Zusammenhang mit den Anforderungen der Maschinenlärminformationsverordnung vom 18 Januar 1991.

- Schalldruckpegel $L_p < 70$ dB(A).
- Am Arbeitsplatz.
- Normaler Betrieb.
- Nach ISO 7779:1988/EN 27779:1991 (Typprüfung).

Safety Considerations

GENERAL

This product and related documentation must be reviewed for familiarization with safety markings and instructions before operation.

This product has been designed and tested in accordance with IEC Publication 61010-1+A1+A2:1992 Safety Requirements for Electrical Equipment for Measurement, Control and Laboratory Use and has been supplied in a safe condition. This instruction documentation contains information and warnings which must be followed by the user to ensure safe operation and to maintain the product in a safe condition.

SAFETY EARTH GROUND

A uninterruptible safety earth ground must be provided from the main power source to the product input wiring terminals, power cord, or supplied power cord set.

CHASSIS GROUND TERMINAL

To prevent a potential shock hazard, always connect the rear-panel chassis ground terminal to earth ground when operating this instrument from a dc power source.

SAFETY SYMBOLS



Indicates instrument damage can occur if indicated operating limits are exceeded. Refer to the instructions in this guide.



Indicates hazardous voltages.



Indicates earth (ground) terminal

WARNING

A WARNING note denotes a hazard. It calls attention to a procedure, practice, or the like, which, if not correctly performed or adhered to, could result in personal injury. Do not proceed beyond a WARNING sign until the indicated conditions are fully understood and met.

CAUTION

A CAUTION note denotes a hazard. It calls attention to an operation procedure, practice, or the like, which, if not correctly performed or adhered to, could result in damage to or destruction of part or all of the product. Do not proceed beyond an CAUTION note until the indicated conditions are fully understood and met.

Safety Considerations for This Instrument

WARNING

Whenever it is likely that the protection has been impaired, the instrument must be made inoperative and be secured against any unintended operation.

If this instrument is to be energized via an autotransformer (for voltage reduction), make sure the common terminal is connected to the earth terminal of the power source.

If this product is not used as specified, the protection provided by the equipment could be impaired. This product must be used in a normal condition (in which all means for protection are intact) only.

No operator serviceable parts in this product. Refer servicing to qualified personnel. To prevent electrical shock, do not remove covers.

Servicing instructions are for use by qualified personnel only. To avoid electrical shock, do not perform any servicing unless you are qualified to do so.

The opening of covers or removal of parts is likely to expose dangerous voltages. Disconnect the product from all voltage sources while it is being opened.

Adjustments described in the manual are performed with power supplied to the instrument while protective covers are removed. Energy available at many points may, if contacted, result in personal injury.

For Continued protection against fire hazard, replace the line fuse(s) with T 250 V 5.0 A fuse(s) or the same current rating and type. Do not use repaired fuses or short circuited fuseholders.

WARNING



This product is a Safety Class I instrument (provided with a protective earthing ground incorporated in the power cord). The mains plug shall only be inserted in a socket outlet provided with a protective earth contact. Any interruption of the protective conductor inside or outside of the product is likely to make the product dangerous. Intentional interruption is prohibited.

WARNING

Always use the three-prong ac power cord supplied with this product. Failure to ensure adequate earth grounding by not using this cord may cause personal injury and/or product damage.

This product is designed for use in Installation Category II and Pollution Degree 3 per IEC 61010 and IEC 60664 respectively.

This product has autoranging line voltage input, be sure the supply voltage is within the specified range.

To prevent electrical shock, disconnect instrument from mains (line) before cleaning. Use a dry cloth or one slightly dampened with water to clean the external case parts. Do not attempt to clean internally.

Ventilation Requirements: When installing the product in a cabinet, the convection into and out of the product must not be restricted. The ambient temperature (outside the cabinet) must be less than the maximum operating temperature of the product by 4° C for every 100 watts dissipated in the cabinet. If the total power dissipated in the cabinet is greater than 800 watts, then forced convection must be used.

WARNING

RUBIDIUM REFERENCE ASSEMBLY

The optional Rubidium Reference assembly of the Test Set contains the radioactive isotope Rubidium 87. This assembly contains no user serviceable parts. DO NOT attempt to repair it. There is no measurable external radiation. This assembly does not present a safety hazard. This assembly is regulated as a hazardous waste and must be disposed of in accordance with local, state, and federal regulations. For important shipping information, see

FOR GROUND TRANSPORTATION IN THE U.S.A.:

This package conforms to the conditions and limitations specified in 49CFR 173.424 for radioactive material, excepted package – instruments, UN2910.

FOR AIR TRANSPORTATION IN THE U.S.A. AND INTERNATIONAL:

This instrument must be shipped as cargo with the following endorsement in the nature and quantity of goods box on the air waybill, “Radioactive material, excepted package – instruments.”

Figure 1 Rubidium Transportation Labels

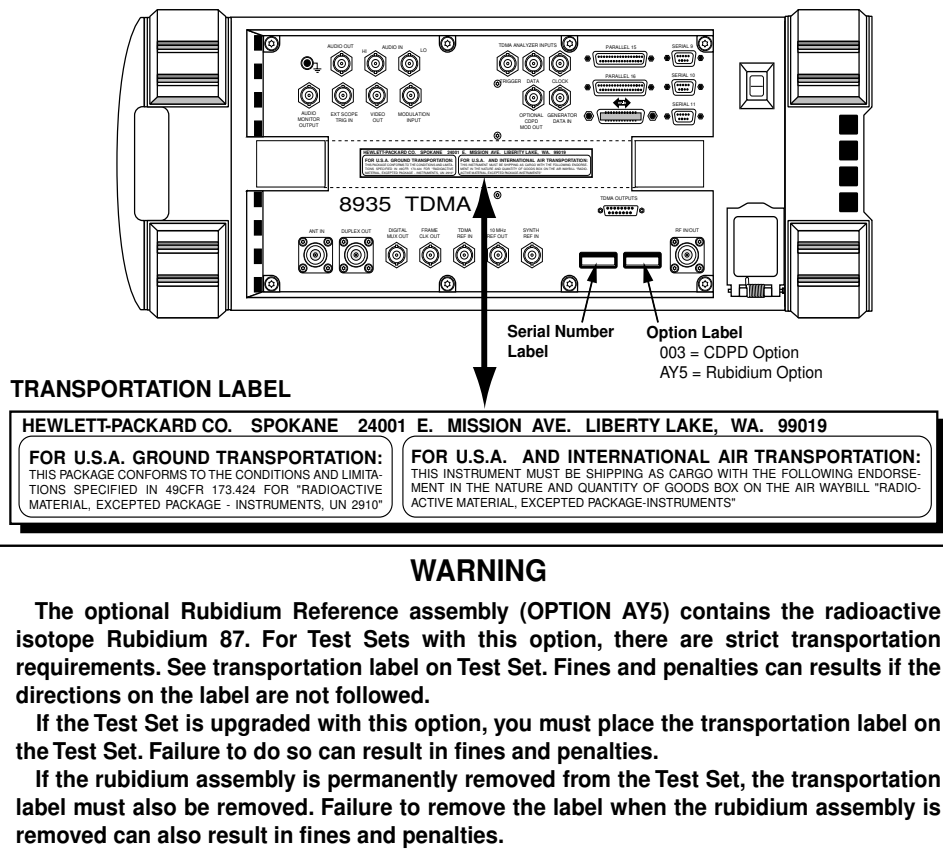

labels.eps

Lifting and Handling

When lifting and handling the Agilent 8935 TDMA Cellular/PCS Base Station Test Set use ergonomically correct procedures. Lift and carry by the strap on the side panel.

When moving the Test Set more than a few feet, be sure to replace the front screen cover.

Consumables

Two AA alkalyne batteries are supplied with the Test Set and must be replaced periodically. When replacing batteries always dispose of old batteries in a conscientious manner, following manufacturer's instructions.

Product Markings



The CE mark shows that the product complies with all relevant European legal Directives (if accompanied by a year, it signifies when the design was proven).



The CSA mark is a registered trademark of the Canadian Standards Association.

Certification

Agilent Technologies certifies that this product met its published specifications at the time of shipment from the factory. Agilent further certifies that its calibration measurements are traceable to the United States National Institute of Standards and Technology, to the extent allowed by the Institute's calibration facility, and to the calibration facilities of other International Standards Organization members.

DECLARATION OF CONFORMITY

According to ISO/IEC Guide 22 and CEN/CENELEC EN45014

Manufacturer's Name: Agilent Technologies UK Limited

Manufacturer's Address: Electronic Products Solutions Group - Queensferry
South Queensferry
West Lothian, EH30 9TG
Scotland, United Kingdom

Declares that the product

Product Name: TDMA PCS Base Station Test Set

Model Number: E6381A

Product Options: This declaration covers all options of the above product as detailed in TCF A-5951-9852-02.

EMC:

Conforms with the protection requirements of European Council Directive 89/336/EEC on the approximation of the laws of the member states relating to electromagnetic compatibility, against EMC test specifications EN 55011:1991 (Group 1, Class A) and EN 50082-1:1992.

As Detailed in: Electromagnetic Compatibility (EMC)
Technical Construction File (TCF) No. A-5951-9852-02.

Assessed by: DTI Appointed Competent Body
EMC Test Centre,
GEC-Marconi Avionics Ltd.,
Maxwell Building,
Donibristle Industrial Park,
Hillend,
Dunfermline
KY11 9LB
Scotland, United Kingdom

Technical Report Number:6893/2201/CBR, dated 23 September 1997

Safety:

The product conforms to the following safety standards:

IEC 61010-1(1990) +A1(1992) +A2(1995) / EN 61010-1:1993
IEC 60825-1(1993) / EN 60825-1:1994
Canada / CSA-C22.2 No. 1010.1-93

The product herewith complies with the requirements of the Low Voltage Directive 73/23/EEC, and carries the CE mark accordingly

South Queensferry, Scotland.

1st November 2000

R M Evans

**R.M. Evans / Manufacturing
Engineering Manager**

For further information, please contact your local Agilent Technologies sales office, agent, or distributor.

Agilent Technologies Warranty Statement for Commercial Products

E6381A TDMA/Cellular PCS Base Station Test Set

**Duration of
Warranty: 1 Year**

1. Agilent warrants Agilent hardware, accessories and supplies against defects in materials and workmanship for the period specified above. If Agilent receives notice of such defects during the warranty period, Agilent will, at its option, either repair or replace products which prove to be defective. Replacement products may be either new or like-new.
2. Agilent warrants that Agilent software will not fail to execute its programming instructions, for the period specified above, due to defects in material and workmanship when properly installed and used. If Agilent receives notice of such defects during the warranty period, Agilent will replace software media which does not execute its programming instructions due to such defects.
3. Agilent does not warrant that the operation of Agilent products will be uninterrupted or error free. If Agilent is unable, within a reasonable time, to repair or replace any product to a condition as warranted, customer will be entitled to a refund of the purchase price upon prompt return of the product.
4. Agilent products may contain remanufactured parts equivalent to new in performance or may have been subject to incidental use.
5. The warranty period begins on the date of delivery or on the date of installation if installed by Agilent. If customer schedules or delays Agilent installation more than 30 days after delivery, warranty begins on the 31st day from delivery.
6. Warranty does not apply to defects resulting from (a) improper or inadequate maintenance or calibration, (b) software, interfacing, parts or supplies not supplied by Agilent, (c) unauthorized modification or misuse, (d) operation outside of the published environmental specifications for the product, or (e) improper site preparation or maintenance.

7. TO THE EXTENT ALLOWED BY LOCAL LAW, THE ABOVE WARRANTIES ARE EXCLUSIVE AND NO OTHER WARRANTY OR CONDITION, WHETHER WRITTEN OR ORAL IS EXPRESSED OR IMPLIED AND Agilent SPECIFICALLY DISCLAIMS ANY IMPLIED WARRANTIES OR CONDITIONS OR MERCHANTABILITY, SATISFACTORY QUALITY, AND FITNESS FOR A PARTICULAR PURPOSE.
8. Agilent will be liable for damage to tangible property per incident up to the greater of \$300,000 or the actual amount paid for the product that is the subject of the claim, and for damages for bodily injury or death, to the extent that all such damages are determined by a court of competent jurisdiction to have been directly caused by a defective Agilent product.
9. TO THE EXTENT ALLOWED BY LOCAL LAW, THE REMEDIES IN THIS WARRANTY STATEMENT ARE CUSTOMER'S SOLE AND EXCLUSIVE REMEDIES. EXCEPT AS INDICATED ABOVE, IN NO EVENT WILL Agilent OR ITS SUPPLIERS BE LIABLE FOR LOSS OF DATA OR FOR DIRECT, SPECIAL, INCIDENTAL, CONSEQUENTIAL (INCLUDING LOST PROFIT OR DATA), OR OTHER DAMAGE, WHETHER BASED IN CONTRACT, TORT, OR OTHERWISE.

FOR CONSUMER TRANSACTIONS IN AUSTRALIA AND NEW ZEALAND: THE WARRANTY TERMS CONTAINED IN THIS STATEMENT, EXCEPT TO THE EXTENT LAWFULLY PERMITTED, DO NOT EXCLUDE RESTRICT OR MODIFY AND ARE IN ADDITION TO THE MANDATORY STATUTORY RIGHTS APPLICABLE TO THE SALE OF THIS PRODUCT TO YOU.

Assistance

Product maintenance agreements and other customer assistance agreements are available for Agilent Technologies products. For any assistance, contact your nearest Agilent Technologies Sales and Service Office.

Table 1-2 Regional Sales and Service Offices

<p>United States of America: Agilent Technologies Test and Measurement Call Center P.O. Box 4026 Englewood, CO 80155-4026</p> <p>(tel) 1 800 452 4844</p>	<p>Canada: Agilent Technologies Canada Inc. 5150 Spectrum Way Mississauga, Ontario L4W 5G1</p> <p>(tel) 1 877 894 4414</p>	<p>Europe: Agilent Technologies European Marketing Organization P.O. Box 999 1180 AZ Amstelveen The Netherlands</p> <p>(tel) (3120) 547 9999</p>
<p>Japan: Agilent Technologies Japan Ltd. Measurement Assistance Center 9-1 Takakura-Cho, Hachioji-Shi, Tokyo 192-8510, Japan</p> <p>(tel) (81) 456-56-7832 (fax) (81) 426-56-7840</p>	<p>Latin America: Agilent Technologies Latin America Region Headquarters 5200 Blue Lagoon Drive, Suite #950 Miami, Florida 33126 U.S. A.</p> <p>(tel) (305) 267 4245 (fax) (305) 267 4286</p>	<p>Australia/New Zealand: Agilent Technologies Australia Pty Ltd. 347 Burwood Highway Forest Hill, Victoria 3131</p> <p>(tel) 1 800 629 485 (Australia) (fax) (61 3) 9272 0749 (tel) 0 800 738 378 (New Zealand) (fax) (64 4) 802 6881</p>
<p>Asia Pacific: Agilent Technologies 24/F, Cityplaza One, 111 Kings Road, Taikoo Shing, Hong Kong</p> <p>(tel) (852) 3197 7777 (fax) (852) 2506 9233</p>		



ATTENTION

Static Sensitive
Devices

This instrument was constructed in an ESD (electro-static discharge) protected environment. This is because most of the semiconductor devices used in this instrument are susceptible to damage by static discharge.

Depending on the magnitude of the charge, device substrates can be punctured or destroyed by contact or mere proximity of a static charge. The result can cause degradation of device performance, early failure, or immediate destruction.

These charges are generated in numerous ways such as simple contact, separation of materials, and normal motions of persons working with static sensitive devices.

When handling or servicing equipment containing static sensitive devices, adequate precautions must be taken to prevent device damage or destruction.

Only those who are thoroughly familiar with industry accepted techniques for handling static sensitive devices should attempt to service circuitry with these devices.

Conventions Used in This Manual

The following conventions are used throughout this manual to help clarify instructions and reduce unnecessary text:

- **Test Set** refers to the Agilent Technologies 8935 Series E6381A TDMA Base Station Test Set.
- Test Set keys are indicated like this: **Preset**
- Test Set screen information, such as a measurement result or an error message, is shown like this: **TX Power 7.21 W**

Which Document is Required?

The following documents are part of the Test Set's document set. Use the table to help you decide which document you need.

Table 1-3 Document Navigation

Document	Part Number	Usage
AMPS Application Guide	E6381-90017	Use this manual for making AMPS base station measurements.
Programmer's Guide	E6380-90018	Use this manual to learn how to program the Test Set.
HP-IB Syntax Guide	E6381-90014	Use this listing of HP-IB syntax when writing control programs for the Test Set.
Assembly Level Repair Guide	E6381-90015	Use this manual to perform calibration on the Test Set and for general service information.
Reference Guide	E6381-90019	Use this manual for general information on accessing and changing settings, general Test Set operation, connector descriptions, and error messages. It also contains information on loading and running the various automated test routines (RF Tools) built in to the Test Set.
HELP Screens	(integral to Test Set)	Pressing the Help key accesses information on a variety of Test Set operations and tests.
CD-ROM	E6381-90020	All user documentation

Trademark Acknowledgements

Hewlett-Packard® and HP® are registered trademarks of Hewlett-Packard Company.

Microsoft, Windows®, and MS-DOS®, are registered trademarks of Microsoft Corporation.

ProComm, is a registered trademark of DataStorm Technologies, Inc.

HyperTerminal© is a registered trademark of Hilgraeve, Incorporated.

Pentium® is a registered trademark of Intel Corporation.

Power Cables

Table 1-4

Plug type	Plug Descriptions male/female	Agilent Part # (cable & plug)	Cable Descriptions
	Straight/Straight Straight/90°	8120-1689 8120-1692	79 inches, mint gray 79 inches, mint gray
Used in the following locations:			
Used in the following locations:			
Bangladesh, Belgium, Benin, Bolivia, Bosnia-Herzegovina, Bulgaria, Burkina Faso, Burma, Burundi, Byelarus			
Cameroon, Canary Islands, Central African Republic, Chad, Chile, Comoros, Congo, Croatia, Czech Republic, Czechoslovakia			
Denmark, Djibouti			
East Germany, Egypt, Estonia, Ethiopia			
Finland, France, French Guiana, French Indian Ocean Areas			
Gabon, Gaza Strip, Georgia, Germany, Gozo, Greece			
Hungary			
Iceland, Indonesia, Iran, Iraq, Israel, Italy, Ivory Coast			
Jordan			
Kazakhstan, Korea, Kyrgystan			
Latvia, Lebanon, Libya, Lithuania, Luxembourg			
Macedonia, Madeira Islands, Malagasy Republic, Mali, Malta, Mauritania, Miquelon, Moldova, Mongolia, Morocco, Mozambique			
Nepal, Netherlands, Netherlands Antilles, Niger, Norway			
Oman			
Pakistan, Paraguay, Poland, Portugal			
Rep. South Africa, Romania, Russia, Rwanda			
Saudi Arabia (220V), Senegal, Slovak Republic, Slovenia, Somalia, Spain, Spanish Africa, Sri Lanka, St. Pierre Islands			
Sweden, Syria			

Table 1-4

Plug type	Plug Descriptions male/female	Agilent Part # (cable & plug)	Cable Descriptions
Tajikistan, Thailand, Togo, Tunisia, Turkey, Turkmenistan			
USSR, Ukraine, Uzbekistan			
Western Africa, Western Sahara			
Yugoslavia			
Zaire			

Table 1-5

Plug Type	Plug Descriptions male/female	Agilent Part # (cable & plug)	Cable Descriptions
	Straight/Straight Straight/90°	8120-0698	90 inches, black
Used in the following locations:			
Peru			

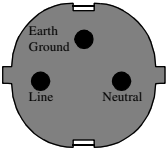
Table 1-6

Plug Type	Plug Descriptions male/female	Agilent Part # (cable & plug)	Cable Descriptions
	Straight/Straight Straight/90°	8120-2104 8120-2296	79 inches, gray 79 inches, gray
Used in the following locations:			
Switzerland			

Table 1-7

Plug Type	Plug Descriptions male/female	Agilent Part # (cable & plug)	Cable Descriptions
 <p>125V</p>	Straight/Straight Straight/90° Straight/Straight	8120-1378 8120-1521 8120-1751	90 inches, jade gray 90 inches, jade gray 90 inches, jade gray
Used in the following locations:			
American Samoa			
Bahamas, Barbados, Belize, Bermuda, Brazil			
Caicos, Cambodia, Canada, Cayman Islands, Columbia, Costa Rica, Cuba			
Dominican Republic			
Ecuador, El Salvador			
French West Indies			
Guam, Guatemala, Guyana			
Haiti, Honduras			
Jamaica			
Korea			
Laos, Leeward and Windward Islands, Liberia			
Mexico, Midway Islands			
Nicaragua			
Other Pacific Islands			
Panama, Philippines, Puerto Rico			
Saudi Arabia (115V, 127V), Suriname			
Taiwan, Tobago, Trinidad, Trust Territories of Pacific Islands			
Turks Island			
United States			
Venezuela, Vietnam, Virgin Islands of the U.S.			
Wake Island			

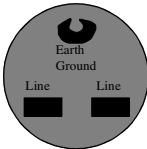
Table 1-8

Plug Type	Plug Descriptions male/female	Agilent Part # (cable & plug)	Cable Descriptions
<p>JIS C 8303, 100 V</p> 	Straight/Straight Straight/90°	8120-4753 8120-4754	90 inches, dark gray 90 inches, dark gray
Used in the following locations:			
Japan			

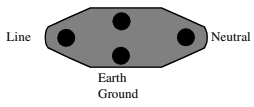
Table 1-9

Plug Type	Plug Descriptions male/female	Agilent Part # (cable & plug)	Cable Descriptions
	90°/Straight 90°/90° Straight/Straight	8120-2956 8120-2957 8120-3997	79 inches, gray 79 inches, gray 79 inches, gray
Used in the following locations:			
Denmark			
Greenland			

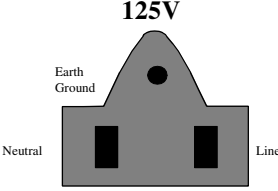
Table 1-10

Plug Type	Plug Descriptions male/female	Agilent Part # (cable & plug)	Cable Description
	Straight/Straight Straight/90°	8120-4211 8120-4600	79 inches, mint gray 79 inches, mint gray
Used in the following locations:			
Botswana			
India			

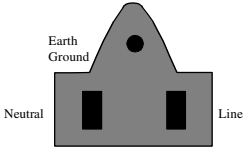
Table 1-10

Plug Type	Plug Descriptions male/female	Agilent Part # (cable & plug)	Cable Description
Lesotho			
Malawi			
South-West Africa (Namibia), Switzerland			
Zambia, Zimbabwe			

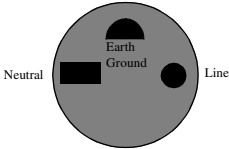
Table 1-11

Plug Type	Plug Descriptions male/female	Agilent Part # (cable & plug)	Cable Descriptions
	Straight/Straight Straight/Straight Straight/90° Straight/90°	8120-1860 8120-1575 8120-2191 8120-4379	60 inches, jade gray 30 inches, jade gray 60 inches, jade gray 15.5 inches, jade gray
Used in the following locations:			
System Cabinets			

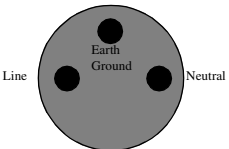
Table 1-12

Plug Type (Male)	Plug Descriptions male/female	Agilent Part # (cable and plug)	Cable Descriptions
	90°/Straight 90°/90°	8120-1351 8120-1703	90 inches, mint gray 90 inches, mint gray
Used in the following locations:			
Bahrain, British Indian Ocean Terr., Brunei			
Canton, Cyprus			
Enderbury Island, Equatorial Guinea			
Falkland Islands, French Pacific Islands			
Gambia, Ghana, Gibraltar, Guinea			
Hong Kong			

Table 1-12

Plug Type (Male)	Plug Descriptions male/female	Agilent Part # (cable and plug)	Cable Descriptions
Ireland			
Kenya, Kuwait			
Macao, Malaysia, Mauritius			
Nigeria			
Qatar			
Seychelles, Sierra Leone, Singapore, Southern Asia, Southern Pacific Islands, St. Helena, Sudan			
Tanzania			
Uganda, United Arab Emirates, United Kingdom			
Yeman (Aden & Sana)			

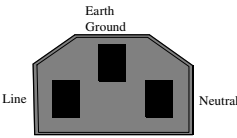
Table 1-13

Plug Type	Plug Descriptions male/female	Agilent Part # (cable & plug)	Cable Descriptions
	Straight/Straight Straight/90°	8120-1369 8120-0696	79 inches, gray 80 inches, gray
Used in the following locations:			
Argentina, Australia			
China (People's Republic)			
New Zealand			
Papua New Guinea			
Uruguay			
Western Samoa			

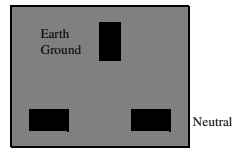
Figure 1-1



ATTENTION **Static Sensitive** **Devices**

This instrument was constructed in an ESD (electro-static discharge) protected environment. This is because most of the semi conductor devices used in this instrument are susceptible to damage by static discharge.

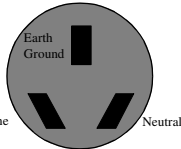
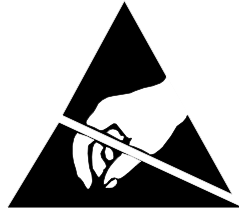
Depending on the magnitude of the charge, device substrates can be punctured or destroyed by contact or mere proximity of a static charge. The result can cause degradation of device performance, early failure, or immediate destruction.

These charges are generated in numerous ways such as simple contact, separation of materials, and normal motions of persons working with static sensitive devices.

When handling or servicing equipment containing static sensitive devices, adequate precautions must be taken to prevent device damage or destruction.

Only those who are thoroughly familiar with industry accepted techniques for handling static sensitive devices should attempt to service circuitry with these devices.

In all instances, measures must be taken to prevent static charge build-up on work surfaces and persons handling the devices.

2 **Getting Started**

- [“Before Connecting a Radio” on page 32](#)
- [“Changing the Measurement Screen” on page 33](#)
- [“Changing the Control Fields” on page 35](#)
- [“Instrument Functional Check” on page 39](#)

Before Connecting a Radio

NOTE The RF IN/OUT port should be used for all transmitter tests when the radio is connected directly to the Test Set. (All transmitter power measurements are made through this port). Off-the-air measurements can be made using the ANT IN port.

CAUTION Overpower Damage — Refer to the Test Set's side panel for maximum input power level at the RF IN/OUT, DUPLEX OUT, and ANT IN connectors. Exceeding these levels can cause permanent instrument damage.

Changing the Test Set's Display

Changing the Measurement Screen

The factory-set power-up screen is the SOFTWARE MENU screen. Refer to your software manual for instructions for loading and running software. See “POWERON Settings” on page 59 for information about changing the power-up screen.

The screen is changed using the GENERATOR/ANALYZER keys, using the title bar at the top of the screen and the cursor-control knob, or by using the UTILS keys (see Figure 2-1 on page 33).

Rotate the knob to move the cursor from field to field or to change settings. Press the knob to make selections. See “Changing the Control Fields” on page 35 for more information about fields.

Figure 2-1 Using the Cursor-Control Knob or Screen Keys

Move the cursor to the title bar and press the knob. Select a screen from the menu.

Push the knob to make a selection. Rotate the knob to move the cursor, or change settings.

Press one of the GENERATOR/ANALYZER or UTILS keys for a shortcut to the measurement or configuration screens.

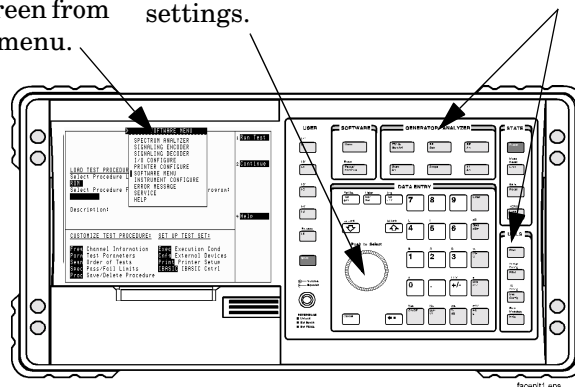

Example 2-1 To change the measurement screen

1. Select the title bar at the top of the screen (placement of the title bar may vary slightly on some screens).
2. Select the measurement screen from the list of choices.

Example 2-2 OR

1. Press a screen key: **TDMA Gen/Anl, RF Gen, RF Anl, Spec Anl, AF Anl, Scope, Prev, Inst Config, Help, Printer Config, I/O Config, Error Message.**

Printer Config, I/O Config, and Error Message are shifted functions (labeled in blue above a key). You must press and release the blue **Shift** key then the key below the blue label to access the screen (or other function) labeled in blue.

Pressing the **Prev** key displays the previous screen.

Changing the Control Fields

There are several types of control fields in the Test Set. This section describes some of the different types of fields.

Unit-of-Measure Field

Unit-of-measure can be changed to display measurements in different values or magnitudes. The unit-of-measure field can also be used to turn a measurement on or off (use the **On/Off Yes** key).

Figure 2-2 Unit-of-Measure Field

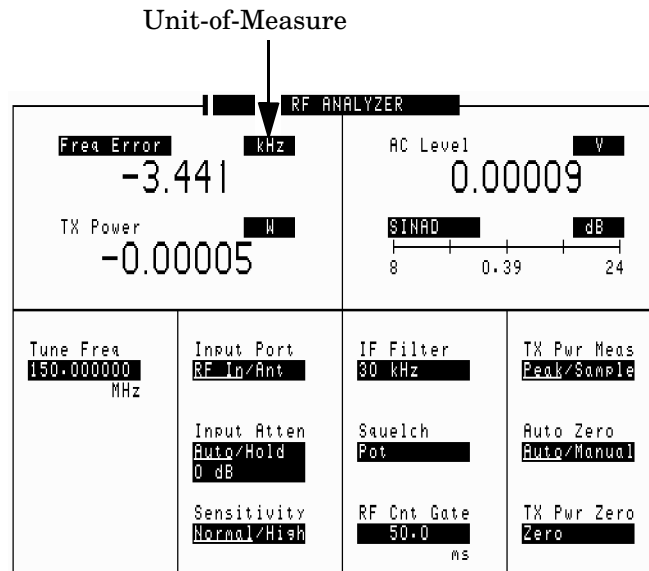

To change a unit-of-measure field

1. Position the cursor at the unit field on the display.
2. Press a key labeled with a different unit-of-measure (such as W).

If the new units are valid, the measurement value is displayed in the unit.

If the new units are not valid, the message `Invalid keystroke.` is displayed and the units are not changed.

Underlined Entry Field

Underlined entry fields provide a choice of two settings (toggle).

Figure 2-3 Underlined Entry Field

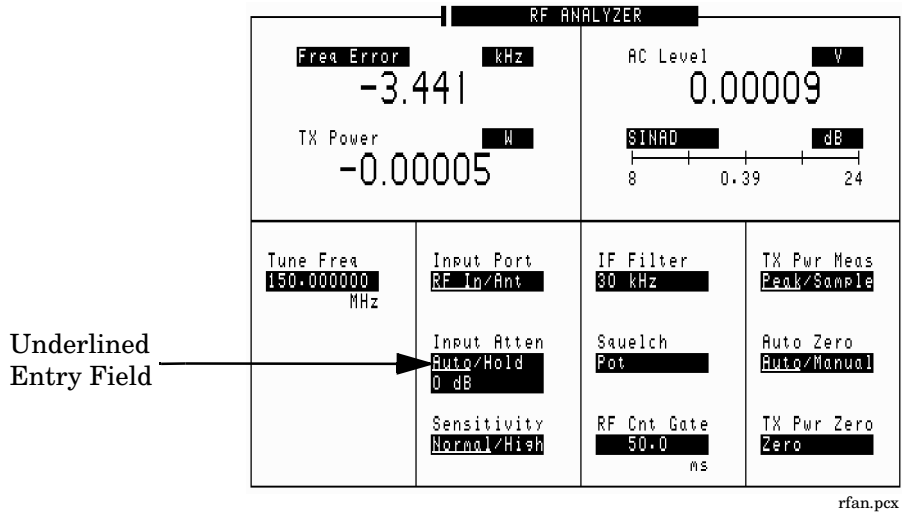

To change an underlined entry

1. Position the cursor at the field.
2. Push the cursor-control knob or the **Enter** key to move the underline under the desired choice.

The underlined setting is immediately activated when selected.

One-of-Many Field

One-of-many fields display a list of choices when selected.

Figure 2-4 One-of-Many Field

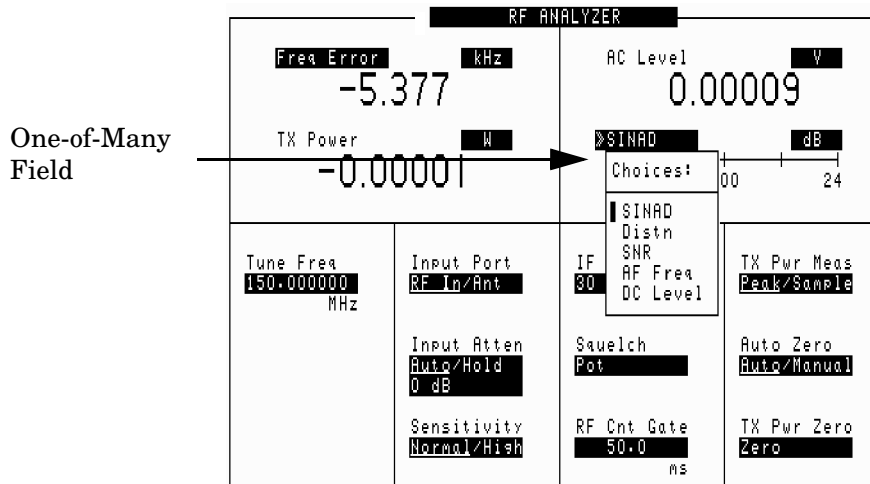

To make a one-of-many choice

1. Position the cursor at the field.
2. Push the cursor-control knob or the **Enter** key to display the choices.
3. Move the cursor through the choices by turning the knob.
4. Push the cursor-control knob or the **Enter** key to make the choice.

The choice is immediately activated when selected.

Numeric-Entry Fields

Values for numeric entry fields can be entered and changed using various methods, depending on your testing needs.

Figure 2-5

Numeric-Entry Field

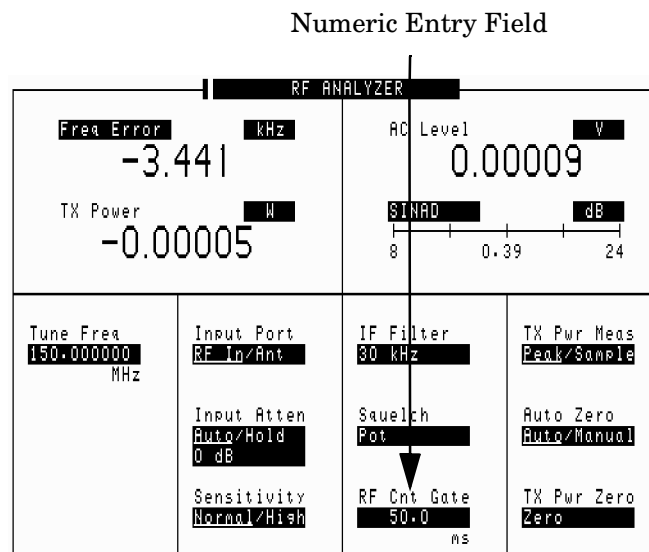

To change a value

1. Position the cursor at the field.
2. Key in the desired number using the DATA ENTRY keys.
3. Press **Enter** to select the choice.

OR

1. Position the cursor at the field.
2. Push the cursor-control knob (the flashing >> cursor appears).
3. Turn the knob to increment or decrement the value. (The current increment value may not be appropriate for your operation. See [“Changing the Increment or Decrement Setting” on page 52.](#))
4. Push the cursor-control knob or the **Enter** key to select the choice.

OR

1. Position the cursor at the field.
2. Push the cursor-control knob to highlight the desired choice.
3. Use the up-arrow or down-arrow keys to increment or decrement the value.

Decimal Values

Decimal values are used for most numeric entry fields. The acceptable entries for decimal values are **0** through **9**, **.**, **+/-**, and **EEX**.

The **+/-** key is used for entering negative numbers.

The **EEX** key is used to enter values in exponential notation. For example to enter 10^{-9} you would enter **1, 0, EEX (Shift, +/-), +/-, 9**.

Hexadecimal Values

Hexadecimal (Hex) values are used for entering some signaling parameters. The acceptable entries values are 0 through 9 and A through F. No unit-of-measure is associated with these values.

Hexadecimal values are either entered from the keypad (A through F are shifted functions) or for some fields, values are selected from a list of choices.

How do I Verify that the Test Set is Operating Properly?

If your Test Set powers-up and displays the SOFTWARE MENU screen, but you suspect an instrument problem, use the Instrument Functional Check to verify operation of the basic instrument functions.

If no failure is indicated by this test, but you still suspect a problem, refer to the “Performance Tests” information in the *Assembly Level Repair Manual*.

Instrument Functional Check

Set up the Test Set for TDMA measurements.

1. Remove any connected cables (except for AC power).
2. Turn instrument power on (if it is not already on).
3. Press **Preset**.
4. Press **Inst Config** and set the RF Display field to Freq.
5. Press **RF Anl** and set the Tune Freq field to 1900 MHz.

Figure 2-6

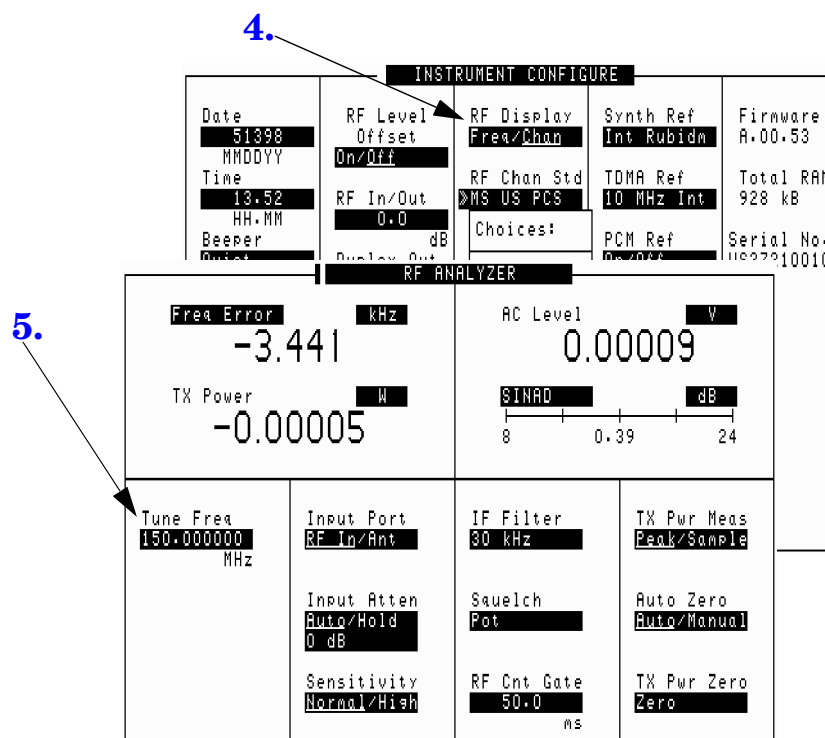

6. Press **RF Gen** and set the RF Gen Freq field to 1900 MHz.
7. Set the Amplitude field to 0.0 dBm.
8. Set the Output Port field to Dupl.

Figure 2-7



9. Connect a cable from the DUPLEX OUT port to the RF IN/OUT port.

Make an EVM measurement.

1. Press **TDMA Gen/Anl**.
2. Set the Std Setup field to EVM Base.
3. Set the Digital Anl field to Cont
4. Set the Trig Type field to Frame Clk.
5. Set the Correlate field to Sync.
6. Set the RF Path field to IQ.
7. Set the digital generator's Slot Type to TDMA Base.
8. Select Send under Digital Gen.

Figure 2-8

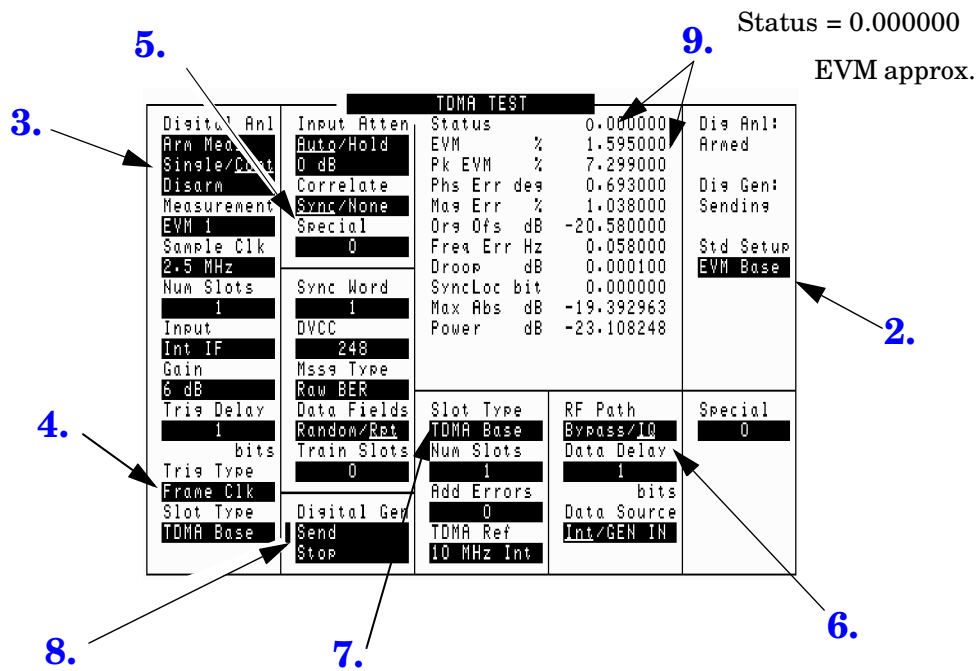

9. Look at the measurement results.

- Status should be 0.000000
- EVM should be approximately 1.5%.

Make an average power (Avg Pwr) measurement.

1. Set the Measurement field to Avg Pwr.

Figure 2-9

1. →

TOMA TEST				
Digital Anl		Status	0.000000	Dis Anl:
Arm Meas		Avg Pwr dBm	-0.673569	Armed
Single/Cont		Max ADC dB	-13.496844	Dis Gen:
Disarm				Idle
Measurement	Avg Pwr			Std Setup
Avg Pwr	Zero			EVM Base
	Special			
	0			
Num Slots	Sync Word			
1	1			
	DVCC			
	248			
	Mess Type			
	Raw BER			
Trig Delay	Data Fields	Slot Type	RF Path	Special
1	Random/Ret	TOMA Mobil	Bypass/IC	0
bits	Train Slots	Num Slots	Data Delay	
Trig Type	0	1	1	
Immediate		Add Errors	bits	
Pwr Gain	Digital Gen	0	Data Source	
Auto/Hold	Send	TOMA Ref	Int/GEN IN	
66 dB	Stop	10 MHz Int		

2. Status = 0.000000
Avg Pwr approx. 0 dBm

2. Look at the measurement results.

- Status should still be 0.000000
- Avg Pwr should be approximately 0 dBm.

3 **Operating Overview**

- “Displaying TDMA Measurements” on page 45
- “Displaying Analog Measurements” on page 46
- “Using Channel Numbers to Set Analyzer and Generator Frequencies” on page 51
- “Changing the Increment or Decrement Setting” on page 52
- “Using Measurement Limit Indicators” on page 53
- “Setting A Measurement Reference” on page 55
- “Averaging Measurements” on page 56
- “Setting an RF Generator/Analyzer Offset” on page 57
- “Saving and Recalling Instrument Setups” on page 58
- “Using USER Keys” on page 61
- “Replacing Batteries” on page 63
- “Initializing (Formatting) a PC Card” on page 64

Displaying TDMA Measurements

TDMA measurements results are displayed on the TDMA TEST screen. Changing the Measurement field displays different measurement results in the measurement display area. See [Figure 3-1](#).

Figure 3-1 TDMA Measurements

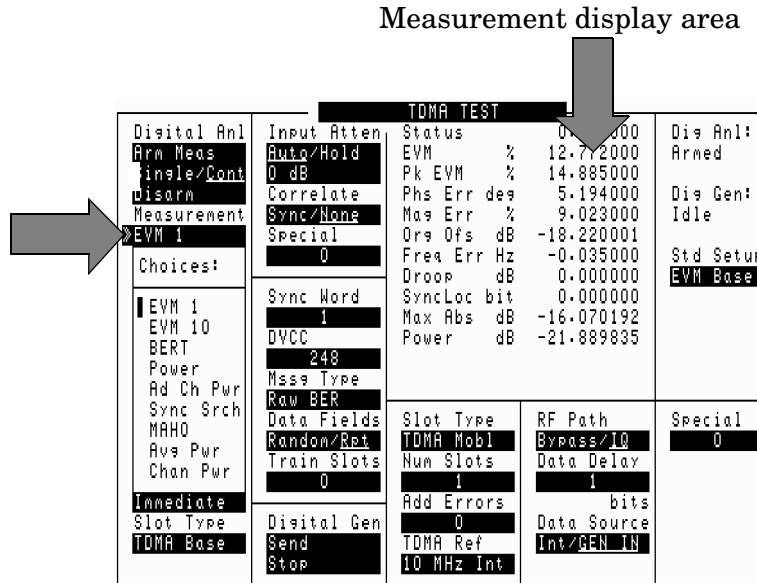

Displaying Analog Measurements

RF Measurements

Frequency Error, Frequency

RF frequency error and RF frequency are displayed on the RF ANALYZER, RF GENERATOR, and AF ANALYZER screens.

Figure 3-2 Displaying RF Frequency or RF Frequency Error

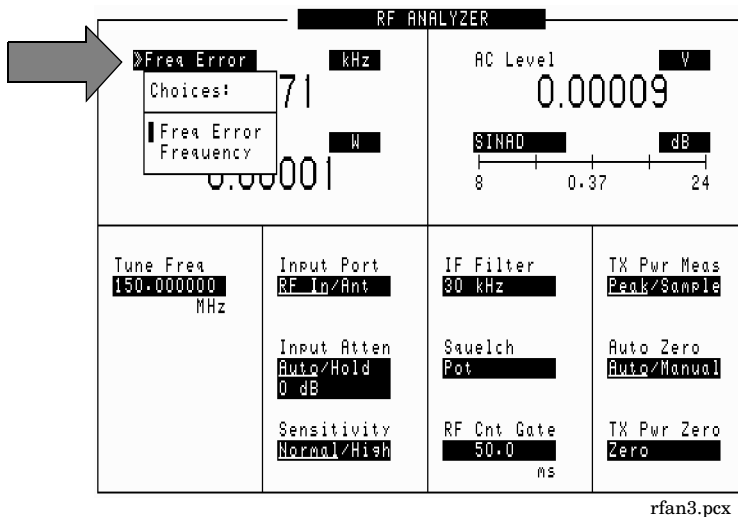

Transmitter (TX) Power

TX Power is only measured and displayed here when the Input Port on the RF ANALYZER screen is set to RF In. If Ant (antenna) is selected, the measurement is replaced by four dashes (- - - -).

Figure 3-3 **Displaying TX Power**

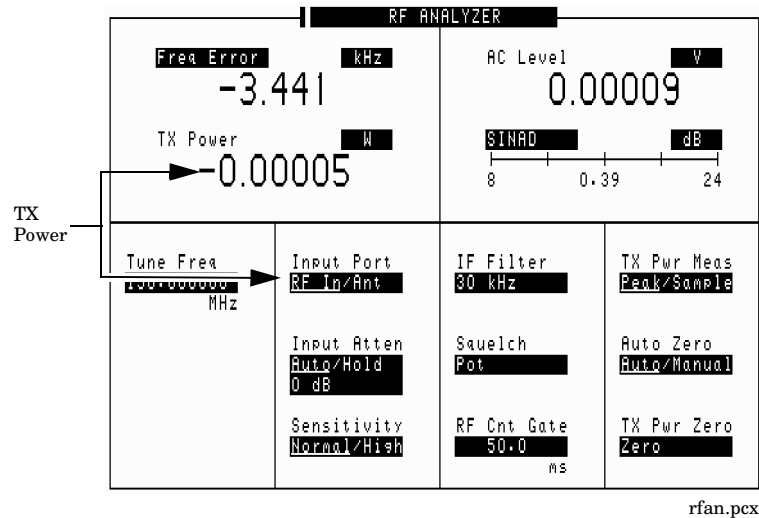

You can measure low power levels on the ANT IN port using the spectrum analyzer.

CAUTION

Connecting a signal of >60 mW to the ANT IN (antenna) port can cause instrument damage (although internal protection circuits can typically withstand a short-duration signal of 1 or 2 Watts). If the overpower circuit is triggered, remove the signal from the ANT IN port and turn the Test Set off and on to reset it.

Displaying AF Measurements

FM Deviation, AM Depth, AC Level

The AF Anl In setting determines the AF analyzer's input and the measurement displayed in the top-right corner of the measurement area (see Figure 3-4). These measurements are displayed on the RF GENERATOR, RF ANALYZER, and AF ANALYZER screens.

Table 3-1 lists the measurement displayed for each AF Anl In setting.

Figure 3-4 Displaying FM Deviation, AM Depth, or AC Level

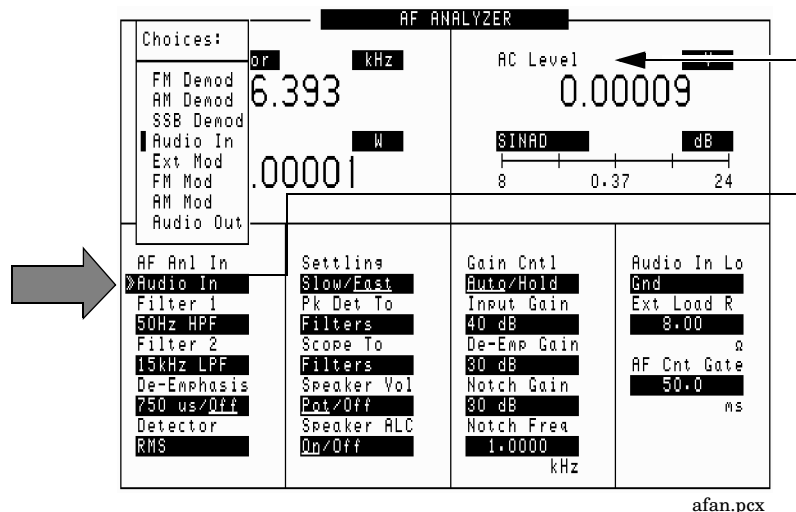

Table 3-1 Selected with the AF Anl In field

Measurement	AF Anl In Setting
FM Deviation	FM Demod, FM Mod
AM Depth	AM Demod, AM Mod
AC Level	SSB Demod, Audio In, Ext Mod, Audio Out

SINAD, Distortion, SNR, AF Frequency, DC Level,

These measurements are available on the RF GENERATOR, RF ANALYZER, and AF ANALYZER screens. See Figure 3-5.

Figure 3-5 Displaying SINAD, Distortion, SNR, DC Level, or AF Frequency

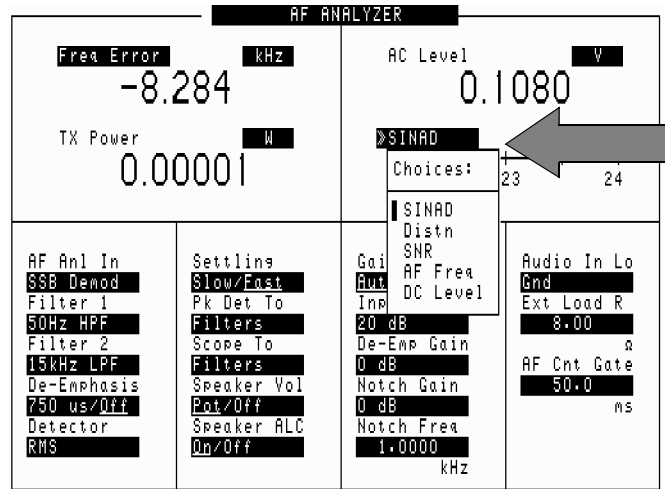

afan2.pcx

Selecting SNR (signal/noise ratio) turns off any other audio measurement.

Distortion Measurements

When making distortion measurements, the setting for the **Notch Freq** field on the AF ANALYZER screen must match the modulation frequency of the signal being analyzed. The default setting for this field is 1 kHz. This setting matches the default frequency for AF generator 1 (**AFGen1 Freq**) setting on the RF GENERATOR screen (this is the signal used to modulate the carrier).

To make distortion measurements at other frequencies, you can manually change the **Notch Freq** field to match the modulation frequency, or you can have the Test Set automatically couple to the **AFGen1 Freq** and **Notch Freq** settings so that they track each other. To couple these functions, go to the INSTRUMENT CONFIGURE screen (press **Inst Config**) and set the **Notch Coupl** field to **AFGen1**.

Displaying Measurement Results on a Meter Scale

Figure 3-6 Displaying the Meter Scale

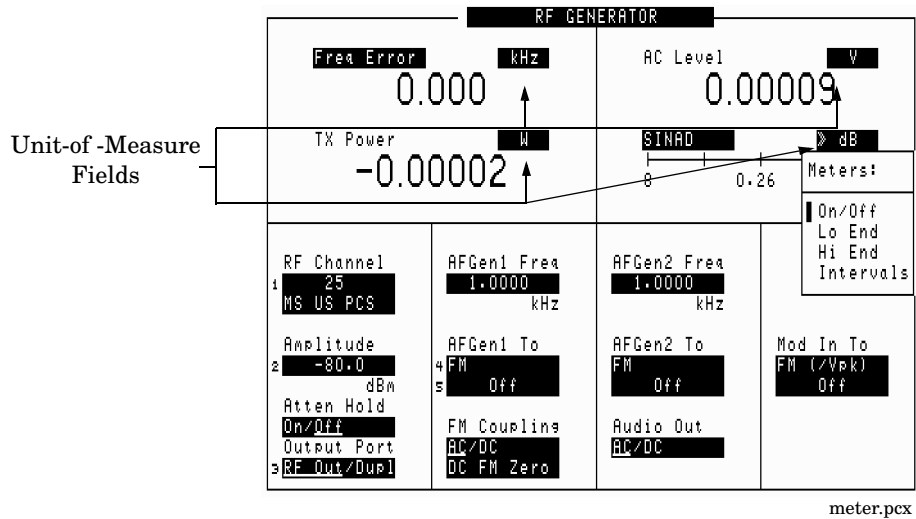

Measurement results can be displayed on a meter scale. The digital numeric value is still displayed (but smaller) under the meter scale.

To display the meter scale

1. Move the cursor to the unit-of-measure field for the measurement you want displayed on the meter.
2. Press and release the blue **Shift** key, then the **Incr Set** key to access the meter function.
3. Select **On/Off** from the **Meters:** menu (or press the **On/Off** key).

To set the meter's end points and scale intervals

1. Use the knob to select the unit-of-measure field for the measurement you want displayed on the meter.
2. Press and release the blue **Shift** key, then the **Incr Set** key to access the meter function.
3. Select **Hi End**, **Lo End**, or **Interval** from the **Meters:** menu and enter the value for your selection, then press the **Enter** key.
4. Repeat steps 2 and 3 until you have set the desired parameters for the meter's scale.

Using Channel Numbers to Set Analyzer and Generator Frequencies

RF analyzer and RF generator frequencies can be entered by channel number (the default setting) or by discrete frequencies (in MHz). The RF Display field on the INSTRUMENT CONFIGURE screen controls which way frequencies are entered. This screen is accessed by pressing the Inst Config key.

If the RF Display field is set to Chan for channel tuning, you also need to set the RF Chan Std field to indicate the standard for your base station (such as North American PCS). This automatically sets the correct frequency offset needed to generate reverse channel signals and analyze forward channel signals for base stations.

If you do not know the channel number of your base station, but know the transmit and receive frequencies, set the RF Display field to Freq. You can then enter these frequencies directly for the RF generator and RF analyzer during tests.

Figure 3-7 Configuration to Use Channel Numbers for RF Generator and Analyzer Settings

Set the **RF Display** field to **Chan** to turn on channel tuning.

Select the **RF Chan Std** field to display a list of system types...
...and then select the channel standard for testing your base stations.

INSTRUMENT CONFIGURE				
Date	RF Level	RF Display	Synth Ref	Firmware
51398	On/Off	Freq/Chan	Int Rubidw	A.00.53
MMDDYY				
Time	RF In/Out	RF Chan Std	TDMA Ref	Total RAM
13.52	0.0	MS US PCS	10 MHz Int	928 kB
HH.MM		Choices:	PCM Ref	Serial No.
Beeper	Duplex Out	MS US PCS	On/Off	US37210010
Quiet	0.0	LS US PCS		
Display	Antenna In	MS AMPS		
User Mssgs	0.0	LS AMPS		
Yes/No		MSL NAMPS		
Range Hold		MSM NAMPS		
Auto All		MSU NAMPS		
Hold All		LSL NAMPS		
State:Auto		LSM NAMPS		
Notch Coupl		LSU NAMPS		
RFGen1/None				
RFGen Volts				
50 ohm/awf				



instenfg.pcx

Changing the Increment or Decrement Setting

Specifying An Increment Value for the Arrow Keys or Knob

The **Incr Set** key is used to assign a specific increment value. The increment value may use different units than the field you are incrementing/decrementing. For instance; if the RF generator's *Amplitude* setting is displayed in dB μ V, you could increment in units of dB or mV.

To change the increment/decrement value

1. Move the cursor to the numeric entry field to be changed.
2. Press **Incr Set**, and enter the desired incremental value and unit-of-measure using the DATA ENTRY keys.
3. Use the down-arrow and up-arrow keys   or cursor control knob to increment the field's value. The field's value changes by the value you set for each key press or knob click.

Using the Factor of 10 Increment/Decrement Keys

The **Incr \times 10** and **Incr \div 10** keys change the increment/decrement value by a factor of 10.

For example, if you set the increment for *Tune Freq* to 10 MHz for every click of the knob or push of the down-arrow or up-arrow keys, pushing **Incr \times 10** changes the increment value to 100 MHz.

Using Measurement Limit Indicators

The **Lo Limit** and **Hi Limit** functions are used to define a measurement “window.” You can set a high limit, a low limit, or both. When limits are assigned, **Lo**, **Hi** or both are indicated on the screen.

A measurement that goes above or below the defined limits causes three things to happen:

1. A message appears at the top of the screen indicating a limit was exceeded.
2. The **Lo** or **Hi** indicator flashes.
3. The beeper beeps (if it is has been enabled in the INSTRUMENT CONFIGURE screen).

Limits are helpful when you can't watch the Test Set's display while you are making an adjustment on the equipment you are testing or repairing. They are also a convenient way of alerting you to long-term measurement drift.

To set high and low limits

1. Position the cursor in front of the unit-of-measure for the measurement for which you are setting limits.
2. Press and release the **Shift** key, then the down-arrow key to access the **Lo Limit** function, and enter the measurement's low-limit value and its unit-of-measure.¹
3. Press and release the **Shift** key, then the up-arrow key to access the **Hi Limit** function, and enter the measurement's high-limit value and its unit-of-measure.¹

1. The fundamental unit for the limits does not have to be the same as the measurement's units. For instance; when measuring AC Level in Volts, you can set high and low limits in units of dBm.

To reset or remove limits

To *reset* a limit that has been exceeded

1. Position the cursor in front of the measurement's unit-of-measure.
2. Press and release the **Shift** key, then the down-arrow (or up-arrow key) to access the **Lo Limit** (or **Hi Limit**) function.
3. Press **Enter** or **Shift** then **Hold** to access the **Meas Reset** function.

To *remove* a limit

1. Position the cursor in front of the unit-of-measure for the assigned limit.
2. Press and release the **Shift** key, then the down-arrow (or up-arrow key) to access the **Lo Limit** (or **Hi Limit**) function, then press the **On/Off** key.

Setting A Measurement Reference

The reference set (Ref Set) function establishes a measurement reference point. This allows you to make a direct comparison between two measurement results, or between a measurement standard and the actual measurement results.

Depending on the type of measurement, referenced measurements are displayed in one of two ways:

1. *Displayed value = Measurement – Reference.* The difference between the measured value and the reference value is displayed.

or

2. *Displayed value = Measurement ÷ Reference.* A ratio of the measured value to the reference value is displayed. This ratio is expressed in dB.

To set a reference

1. Position the cursor in front of the unit-of-measure for the measurement you want to set the reference for.
2. Press and release the **Shift** key, then the **Incr ÷10** key to access the **Ref Set** function.
3. Enter a reference value, then press **Enter**. (To use the currently measured value as a reference, just press **Enter**.)
4. The Reference indicator shows that an internal reference has been set.
5. To turn the reference off press and release the **Shift** key, then the **Incr ÷10** key to access the **Ref Set** function, and then press the **On/Off** key.

Averaging Measurements

The **Avg** (average) function allows you to display the average value of a number of measurements. You enter the number of measurement samples used to calculate and display the measurement average. This dampens the effects of rapidly changing measurements, providing a more usable measurement display.

To use measurement averaging

6. Position the cursor in front of the measurement's unit-of-measure.
7. Press and release the **Shift** key, then the **Incr** $\times 10$ key to access the **Avg** function.
8. Enter the desired number of measurement samples to be used for calculating the average, then press the knob or the **Enter** key.

or

Press **On/Off** to use the currently-displayed number of samples.

9. To turn averaging off, position the cursor in front of the unit-of-measure and press and release the **Shift** key, then the **Incr** $\times 10$ key to access the **Avg** function, then press the **On/Off** key.

How the Test Set Averages Measurements

When the averaging function is first enabled, a numeric average is calculated and displayed each time a measurement is made. This continues until the specified number of samples is reached. From that point on, the averaging function performs an exponential filtering operation that mimics an RC filter.

Because of the exponential response, any large measurement changes result in a displayed value that ramps up or down to the actual measured value.

A measurement reset clears the measurement history for all measurements and starts the averaging process over. (Press and release the **Shift** key then the **Hold** key (**Meas Reset**) to reset the measurement.)

Setting an RF Generator/Analyzer Offset

You can set a fixed frequency offset between the RF generator and the RF analyzer. This feature is convenient for testing radios with a fixed transmit/receive frequency offset.

To set an RF Offset

10. Go to the INSTRUMENT CONFIGURE screen.
11. Set the RF Display field to Freq.
12. Set the RF Offset field to On.
13. Select the (Gen) – (Anl) field and enter the frequency offset value.
14. Go to the RF GENERATOR screen.
15. Select the RF Gen Freq field, and rotate the cursor control knob to vary the RF generator's frequency.
16. Go to the RF ANALYZER screen. Notice that the Tune Freq value changes to maintain the offset between the generator and the analyzer. (You can use the **Prev** key to switch between the generator and analyzer screens.)

Saving and Recalling Instrument Setups

The save and recall functions allow you to store different instrument setups and retrieve them later, eliminating the task of re-configuring the Test Set.

The number of available save registers depends on how many changes were made to the *base* instrument setup for each save. (See “[BASE Settings](#)” on page 60.) The smaller the number of changes, the greater the number of save registers that can be used (typically over 200).

Save/Recall register settings can be saved to internal RAM or to a PC card. Saving registers to a PC card allows you to “back up” the settings in case you need to clear them from memory for running large programs, or when a firmware upgrade is performed (see “[Memory Considerations](#)” on page 60 and “[Initializing \(Formatting\) a PC Card](#)” on page 64).

To save an instrument setup

17. Go to the I/O CONFIGURE screen.
18. Select the storage media using the *Save/Recall* field. (The default is internal memory.)
19. Make any changes to the instrument that you want to save in a register.
20. Press and release the **Shift** key then the **Recall** key to access the **Save** function.
21. Use the DATA ENTRY keys or the *Save :* menu to enter the register’s name.

To recall an instrument setup

22. Select the I/O CONFIGURE screen.
23. Select the media to recall settings from using the *Save/Recall* field. The default is internal memory.
24. Press **Recall**.
25. Use the knob to select the desired setup to be recalled from the *Recall* menu.

To remove (clear) an individual save register

26. Specify where the register is stored using the `Save/Recall` field on the `I/O CONFIGURE` screen.
27. Press **Recall**.
28. Use the knob to position the cursor in front of the register to be removed from the `Recall` menu at the bottom-right of the screen. The register name and percentage of memory occupied by that register are indicated at the top of the screen.
29. Press **Yes On/Off**. A prompt appears, asking if you want to delete the save register.
30. Press **Yes On/Off**.

To clear all save registers

1. Press **Recall**.
2. Use the knob to position the cursor in front of the `*Clr All*` entry in the `Recall` menu at the bottom-right of the screen.
3. Press the knob or press **Enter**. A prompt appears at the top of the screen to verify that you want to clear all registers.
4. Press **Yes On/Off**.

Register Names

You can use any number, letter, or combination of numbers and letters as a name for storing instrument settings. For instance; if you want to save a setup for testing a “Vulcan7” radio, you can save the setting as “VULCAN7”.

Two register names are reserved for special purposes: `POWERON` and `BASE`.

POWERON Settings

When the Test Set is turned on, it uses a set of instrument setup parameters specified at the time of manufacture. You can have the instrument power up in a different state by making the desired changes to the original settings, and then saving them using the name `POWERON`.

The next time the instrument is turned on, the instrument returns to the state present when you saved the `POWERON` setting. For instance; if the `SCOPE` screen was displayed when `POWERON` was saved, it is the screen that is displayed when you turn the instrument on.

BASE Settings

The *BASE* register contains any field settings the user has saved that are different from the instrument preset state. It establishes a reference point for all future saves. If a base is not saved, the preset state is used as the reference.

When you save an instrument setup, the new setup is compared to the base settings, and any *differences* are stored under the register name you supply. Because only differences are stored, a much larger number of instrument setups can be saved than if the contents of every field was saved.

When you recall an instrument setting, every field is reset to the base settings. The saved settings are then used to re-establish the desired instrument setup.

You can define your own base setting. If your desired settings are very different from the preset values, you may want to change the *BASE* register. This will decrease the amount of memory used to save each setup, and allow you to save many more setups.

CAUTION

Since each save/recall register only contains the differences between the setup being saved and the present *base* register settings, changing the base settings causes all other saved setups to be erased from memory (including the *POWERON* setting if one has been saved). Unless you consistently change the same fields to the same value each time you use the instrument, you should avoid creating your own *BASE* settings.

Memory Considerations

When the *Save/Recall* field of the *I/O CONFIGURE* screen is set to *Internal*, programs are saved to the same non-volatile RAM used to create RAM disk(s) and run *IBASIC* programs. By saving a large number of instrument setups, you reduce the amount of RAM available to run programs. If you get a “memory overflow” message while trying to load a program, you must clear one or more save/recall registers to free RAM space.

Instrument Hardware Changes

Recalling a saved register that uses a hardware option that has been removed results in unspecified operation. Re-install the needed option before attempting to recall the associated register(s).

Using USER Keys

You can use user keys to move quickly between fields on the same screen, and to access fields that are not normally available on the screen you are using.

Local user keys are used to move between settings on the screen that is displayed. Five local user keys are available for each screen: **k1**, **k2**, **k3**, **k4**, and **k5**. When the user key is pressed, the cursor instantly moves to, and selects, the assigned field; eliminating the need to turn and push the knob. Using these keys removes any other local user keys you may have set up.

Global user keys are used to access settings that are not available on the current screen. Three global user keys are available: **k1'**, **k2'**, and **k3'**. (Use the **Shift** key to access the global user keys)

Using Pre-Defined USER Keys

To Use the Pre-Assigned Local USER Keys

5. Press and release the **Shift** key, the **k4** key; then the **Enter** key. The numbers 1 through 5 appear in front of various fields. (See [Figure 3-8](#).)
6. Press the USER keys (**k1** to **k5**) and notice how the cursor immediately moves to the corresponding field.
7. To stop using the default user keys, press and release the **Shift** key, then the **k5** key to access the **Release** function; then press the **Enter** key.

Figure 3-8 An Example of Pre-Assigned Local User Keys

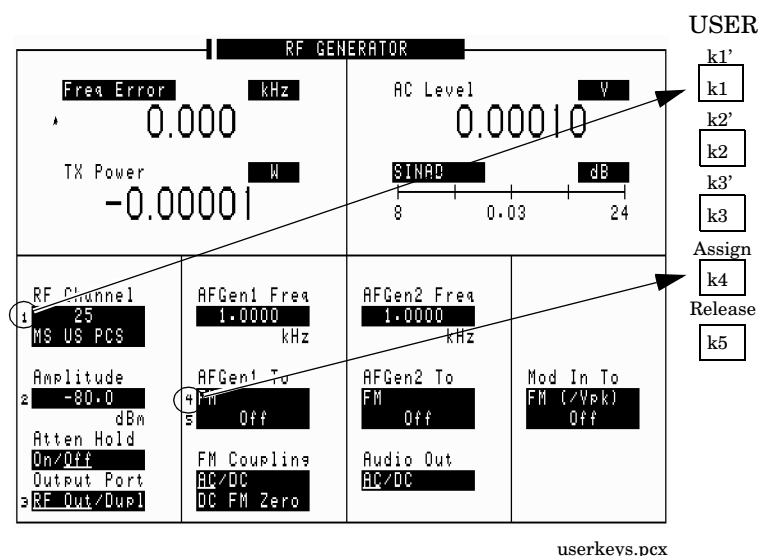

Assigning and Releasing USER Keys

When defining user keys, the **Assign** function is used to create key definitions; the **Release** function removes the definitions. Re-assigning a user key to a different field automatically releases it from its previous setting.

To assign local user keys

8. Move the cursor to the field that you want to assign to a local user key.
9. Press and release the **Shift** key, then the **k4** key to access the **Assign** function. Then press a USER key (**k1-k5**). The user key number appears in front of the field you assigned it to. (Since the cursor is at the newly assigned field, the USER key number is hidden until the cursor is moved.)

To release local user keys

1. Display the screen containing the user key assignment to be removed.
2. Press and release the **Shift** key, then the **k5** key to access the **Release** function; then press the USER key (**k1-k5**).

To assign global user keys

1. Move the cursor to the field you want to assign a global USER key to.
2. Press and release the **Shift** key, then the **k4** key to access the **Assign** function. Then press **Shift** and a USER key (**k1'- k3'**). Unlike a local user key, the user key number *does not* appear at this field; instead, a prompt appears at the top of the screen confirming the key assignment.

To release global user keys

3. Move the cursor to the field with the global user key assigned to it.
4. Press and release the **Shift** key, then the **k5** key to access the **Release** function. Then press **Shift** and the user key to be released.

Replacing Batteries

Test Set backs up its RAM using two battery types.

One type is a set of two AA batteries mounted inside the rear panel of the Test Set. You must periodically change these batteries.

The second type of RAM backup battery is not user serviceable.

CAUTION Failure to take prompt action may result in loss of RAM data including IBASIC programs and SAVE / RECALL states stored in the RAM.

NOTE Do not use rechargeable batteries.

To change the AA batteries, use the following procedure:

1. Turn off power and unplug the Test Set.
2. Remove the six screws in the rear panel using a TX-15 TORX (R) screwdriver.
3. Remove the rear panel.
4. Replace the AA batteries as indicated in the battery holder.
5. Replace the rear panel. Dispose of used batteries properly.

Initializing (Formatting) a PC Card

The Test Set can save a variety of information to SRAM PC Cards; such as save/recall setups, software-generated test data, and spectrum analyzer traces.

Only SRAM cards can be used to store data. Data on flash and One Time Programmable (OTP) cards cannot be used to store data using the Test Set, but can be read by the Test Set.

The SRAM PC card must be initialized before the Test Set can save data to it. This will erase any existing data from the card and format it. This is done using the **PCMCIA** field on the I/O CONFIGURE screen.

- Step 1.** Press the **Shift** key.
- Step 2.** Press the **Inst Config** key.
- Step 3.** Insert the blank SRAM PC card into the PC card slot in the front of the Test Set.
- Step 4.** Read the `Card Status` information (under the `PC Card` field). The `Type` should indicate `RAM`. If it says `ROM`, change the write protect switch on the PC card so that the `TYPE` changes to `RAM`. If the indicated type does not change to `RAM`, the card is either faulty or is not an SRAM card.
- Step 5.** Position the cursor in front of the `PCMCIA (Format Card)` field and press the knob.
- Step 6.** You are prompted to confirm that you want to format the card. Press the **Yes On/Off** key. The card is formatted in about 1 second.

4 TDMA Measurement Basics

Prerequisites

This chapter is an overview of how TDMA measurements are made using the Test Set. The measurement procedures are provided as *generic* test routines. You must know how to get your transceiver to transmit. Refer to your transceiver's documentation, or call the manufacturer, for specific operating information.

You must understand how to access the necessary test screens and alter control settings of the Test Set to use procedures in this chapter. If you are not familiar with the operation of the Test Set, refer to [Chapter 2](#), "Getting Started," on page 31.

TDMA Test Screen Overview

The TDMA TEST screen contains most of the controls used to analyze and generate TDMA signals. The screen is divided into sections representing functional areas (see Figure 4-1). Press the TDMA Gen/Anl key to access this screen. For more information on each field, refer to the *HP-IB Syntax Reference Guide*.

Figure 4-1 The TDMA TEST Screen

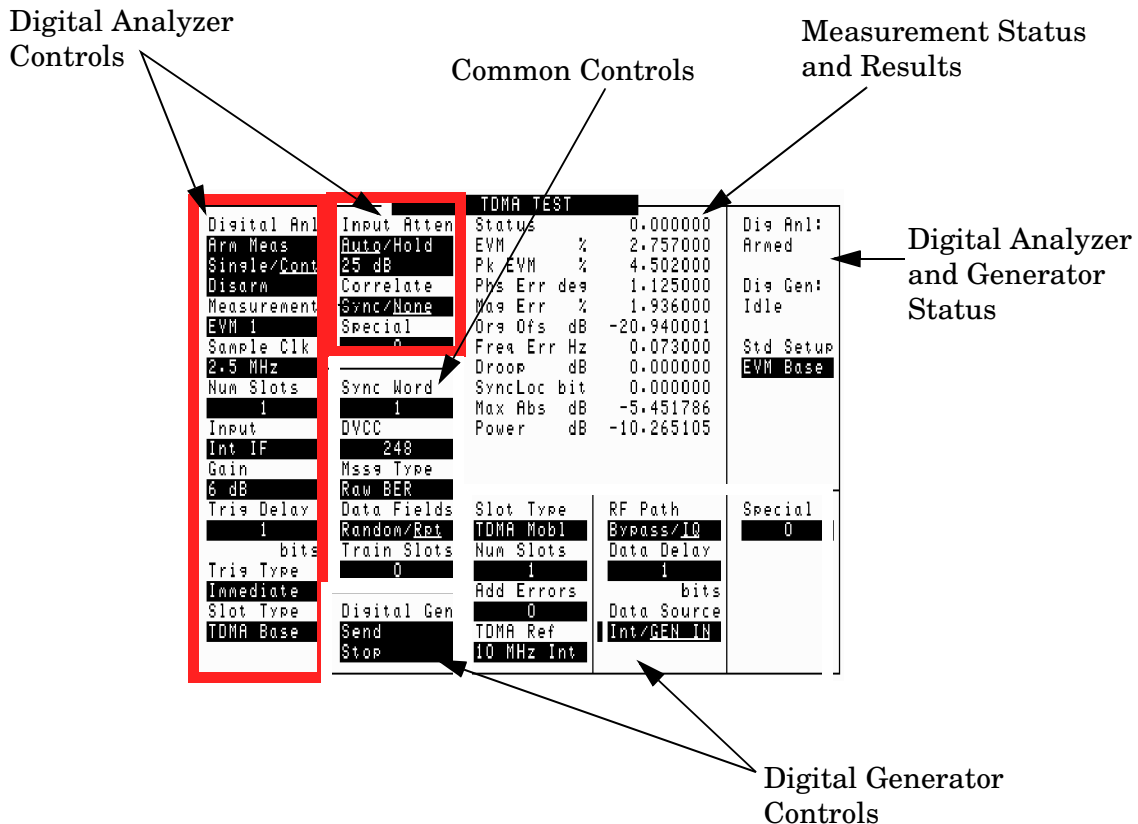

Generating and Analyzing TDMA Signals

- The digital analyzer controls are used to prepare the analyzer to make Pi/4 DQPSK transmitter measurements.
- The digital generator controls are used to generate a Pi/4 DQPSK signal to test TDMA digital cellular receivers.
- The common controls are used to specify information that the digital analyzer and digital generator share for tests.
- The Standard Setup field is used to automatically configure controls on the TDMA TEST screen for specific tests.

Displaying TDMA Measurements and Instrument Status

- The Measurements area displays measurement results. The type of measurements displayed depends on the digital analyzer's Measurement field setting.
- The digital analyzer/ generator Status area tells what the digital analyzer and digital generator are doing:
 - The digital analyzer is either Idle (not making a measurement) or Armed (ready to be triggered by the signal indicated in the digital analyzer's Trig Type field).
 - The digital generator is either Idle or Sending. When idle, the digital generator outputs a constant stream of 00 symbols. When sending, the data stream containing the information defined in the common and RF generator controls is output until the generator is at Idle again.

Digital modulation is only output when the RF Path field is set to IQ. To output an un-modulated RF carrier, set the RF PATH field to Bypass.

Making TDMA Measurements

The TDMA TEST screen provides a broad range of functions that can be used to analyze and generate TDMA signals. The features allows it to be used as a general TDMA measurement instrument or as a powerful development system in a research and development environment.

The following measurement procedures are intended to familiarize you with the basic operations needed to make common TDMA base station transmitter measurements, and is very similar to the instrument functional check on [page 39](#).

To be able to perform these tests, you need to know how to turn your base station's transmitter on and off (and be able to disable call processing if necessary).

Measuring Transmitter EVM, Average Power, and Adjacent Channel Power, Channel Power

- Step 1.** Connect a cable from the TX Antenna port of your base station to the RF IN/OUT port of the Test Set. Verify that the transmitter is off before making this connection.

Figure 4-2

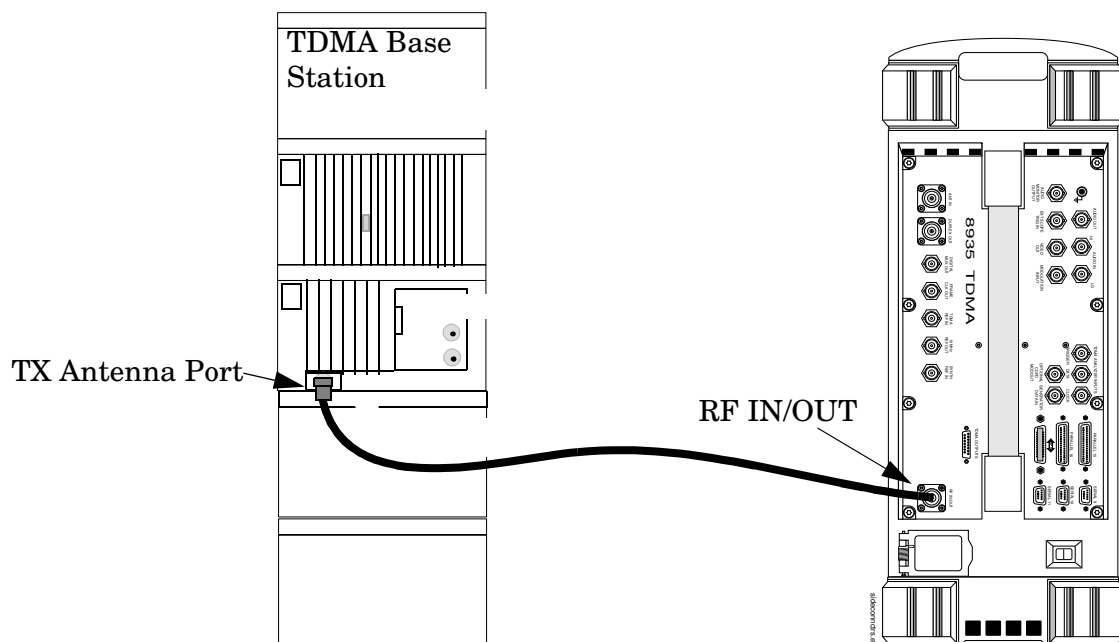

- Step 2.** Tune the Test Set to the transmitter's frequency by pressing the **RF Anl** key and entering the frequency in the Tune Freq field using the DATA ENTRY keys. If you are using channel tuning, enter the RF Channel number (see "Using Channel Numbers to Set Analyzer and Generator Frequencies" on page 51).

Figure 4-3

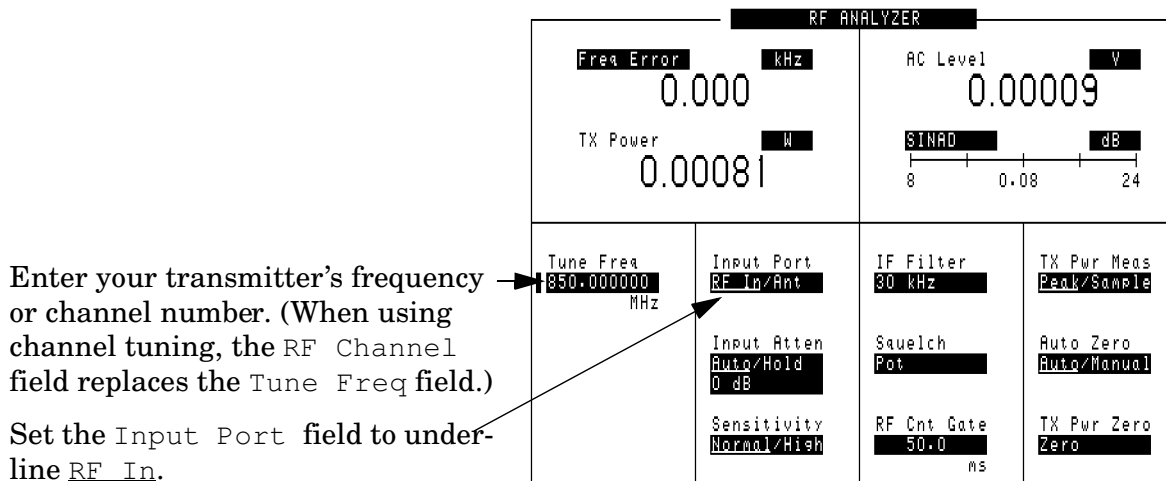

- Step 3.** Tell the Test Set which input port to use by setting the Input Port field to RF In.
- Step 4.** Press the **TDMA Gen/Anl** key.
- Step 5.** Set the Std Setup field to EVM Base. This presets certain controls for the TDMA analyzer to simplify testing.

Figure 4-4 Initial Settings for an EVM Measurement

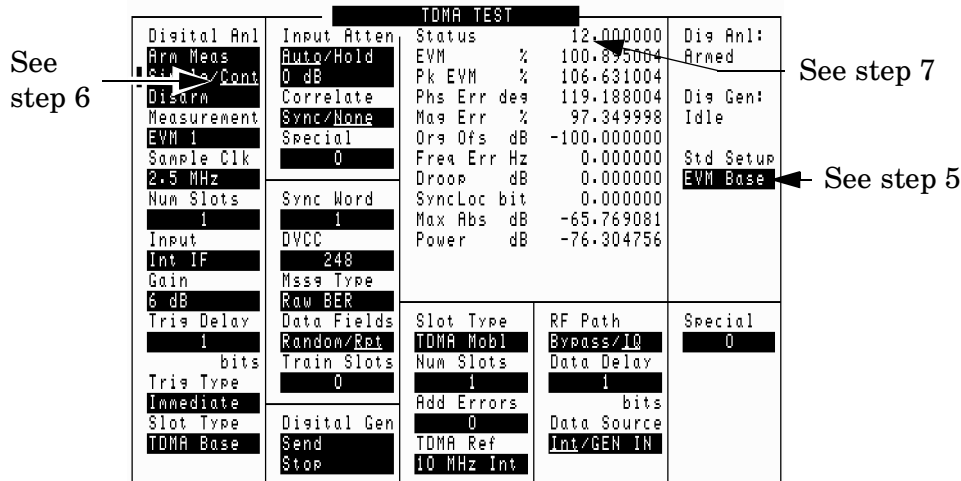

Step 6. Set the Digital Anl field to underline Cont. This tells the analyzer to automatically re-arm itself after being triggered and making a measurement. Because the Trig Type field is already set to Immediate, the analyzer will immediately start displaying measurement values.

Step 7. Look at the measurement Status value. This value tells you if the analyzer made a valid measurement. If the status is 0.000000, the analyzer received a TDMA signal that was of sufficient amplitude for the analyzer to make a valid measurement.

If the status is not 0.000000, the analyzer detected a condition that may make the measurements invalid. For example, since you are not yet transmitting into the Test Set, the signal level into the RF IN/OUT port is probably too low for the analyzer to measure. The status value of 12.000000 (indicated in Figure 4-4) indicates that the input into the analyzer's analog to digital converter (ADC) is too low, and that the analyzer could not find a clock signal (indicating that the carrier may be unmodulated when an IQ modulated signal is expected). See "Status Codes for the Digital Analyzer" on page 78.

Step 8. Set your transmitter to transmit. The status value should change to 0.000000.

Figure 4-5

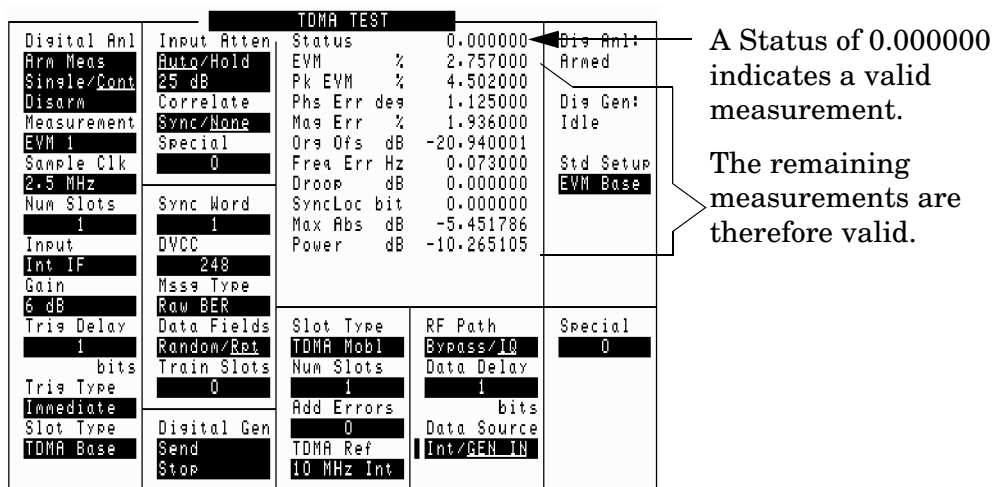

If the status value is not 0.000000, verify that the Max Abs reading is between -0.5 dB and -21.0 dB. If the value is not in this range, refer to "Setting Attenuator Level for Input Ports" on page 77.

Step 9. Read the EVM Measurement Results

Read the Error Vector Magnitude (EVM) and other associated measurements.

NOTE The Power dB measure shown above is a relative measurement; that is, it is referenced to a level used by the analyzer. For an absolute power measurement (dBm, Watts, and so forth), use the Average Power measurement.

Step 10. Select the Measurement field and change it to Avg Pwr to measure average power. The Status should still indicate 0.000000.

Step 11. Disconnect the signal at the input port (RF IN/OUT).

Step 12. Select Zero under Avg Pwr to zero the average power measurement. The message Zeroing Average Power... is displayed while the measurement is being zeroed.

Figure 4-6 Measuring Average Power

Change the Measurement field to Avg Pwr (see step 9).

Zero the average power measurement (see step 11).

TDMA TEST				
Digital Anl		Status	0.000000	Dis Anl:
Arb Mens		Avg Pwr dBm	38.180972	med
Single/Cont		Max ADC dB	-13.761616	
Disarm				Dis Gen:
Measurement	Avg Pwr			Idle
Avg Pwr	Zero			Std Setup
	Special			EVM Base
	0			
Num Slots	1	Sync Word	1	
		DVCC	248	
		Mess Type	Raw BER	
Tris Delay	1	Data Fields	Random/Rst	Slot Type
bits		Train Slots	0	TDMA Mobil
Tris Type	Immediate			RF Path
Pwr Gain	66 dB	Digital Gen	Send	Bypass/IQ
Auto/Hold		Stop		Data Delay
				1
				bits
				Data Source
				Int/GEN IN
				Special
				0

Read the Avg Pwr dBm.

Step 13. After the Zeroing Average Power... message is off the screen, reconnect the input signal.

Step 14. Read the Average Power Measurement Results

Read the average power $Avg\ Pwr\ dBm$. To convert this value to Watts, use the following formula:

Equation 4-1

$$Watts = \frac{10^{\frac{dBm}{10}}}{1000}$$

For example: 30 dBm = 1 Watt, 33 dBm = 2 Watts, 36 dBm = 4 Watts, 39 dBm = 8 Watts, 40 dBm = 10 Watts.

CAUTION

Always use the RF IN/OUT port when measuring average power. If you attempt to use the ANT IN port, you may damage the Test Set if the transmitter's power is >60 mW. Whenever the ANT IN port is used for this measurement, the measured values will be invalid and you will probably see an unstable or non-zero Status display.

Step 15. Select the Measurement field and change it to Ad Ch Pwr to measure adjacent channel power. The Status should still indicate 0.000000.

Figure 4-7 Measuring Adjacent Channel Power

TDMA TEST				
Digital Anl	Input Atten	Status	0.000000	Dis Anl:
Arm Mens	Auto/Hold	AdcMaxAbsdB	-5.537812	Armed
Single/Cont	25 dB	Alt 2 Lo dB	-70.110367	
Disarm	Correlate	Alt Lo dB	-69.005569	Dis Gen:
Measurement	Sync/None	Adj Lo dB	-49.070343	Idle
Ad Ch Pwr	Special	Adj Hi dB	-54.226795	Std Setup
Sample Clk	0	Alt Hi dB	-68.963440	EVM Base
2.5 MHz		Alt 2 Hi dB	-72.208305	
Num Slots	Sync Word			
1	1			
Input	DVCC			
Int IF	248			
Gain	Mssa Type			
6 dB	Raw BER			
Tris Delay	Data Fields	Slot Type	RF Path	Special
1	Random/Ret	TDMA Mobil	Bypass/IG	0
bits	Train Slots	Num Slots	Data Delay	
Tris Type	0	1	1	
Immediate		Add Errors	bits	
Slot Type	Digital Gen	0	Data Source	
TDMA Base	Send	TDMA Ref	Int/GEN IN	
	Stop	10 MHz Int		

Step 16. Read the Adjacent Channel Power Measurement Results

The adjacent (Adj Lo, Adj Hi), alternate (Alt Lo, Alt Hi), and 2nd alternate (Alt 2 Lo, Alt 2 Hi) channel powers are shown for channels 30 kHz, 60 kHz, and 90 kHz above and below the carrier frequency. Values indicate the power in each channel relative to the power at the center frequency of the analyzed signal.

- Step 17.** Select the Measurement field and change it to Chan Pwr to measure channel power.
- Step 18.** Disconnect the signal at the input port (RF IN/OUT).
- Step 19.** Select Calibrate under Chan Pwr Cal to calibrate the channel power measurement. The message Zeroing Average Power... is displayed, then the message Calibrating Channel Power... is displayed while the measurement is being zeroed and calibrated.

Figure 4-8 Measuring Channel Power

TDMA TEST				
Digital Anl	Input Atten	Status	0.000000	Dig Anl:
Arm Meas	Auto/Hold	Ch Pwr dBm	-0.962347	med
Sinale/Cont	25 dB	Max ADC dB	-6.226599	Dig Gen:
Disarm	Chn Pwr Cal			Idle
Measurement	Calibrate			Std Setup
Chan Pwr	Special			EVM Base
	0			
Num Slots	Sync Word			
1	1			
	DVCC			
	248			
	Mess Type			
	Raw BER			
Tris Delay	Data Fields	Slot Type	RF Path	Special
1	Random/Rbt	TDMA Mobil	Bypass/IO	0
bits	Train Slots	Num Slots	Data Delay	
Tris Type	0	1	1	
Immediate		Add Errors	bits	
Ch Pwr Gain	Digital Gen	TDMA Ref	Data Source	
Auto/Hold	Send	10 MHz Int	Int/GEN IN	
12 dB	Stop			

Step 20. Read the Channel Power Measurement Results

The channel power and Max ADC are shown. Channel power is the absolute power level of the RF signal in a 30 kHz bandwidth centered around the RF channel or tune frequency setting.

- Step 21.** After the Calibrating Channel Power... message is off the screen, reconnect the input signal. The Status should still indicate 0.000000.

Reference Connections

Base station receiver tests require a timing signal from the base to the test set to synchronize measurements. This typically involves connecting the timebase or frame clock signal from the base station to the TDMA REF IN port on the Test Set.

Base station transmitter measurements do not require the transmitter to be phase-locked to the Test Set.

Phase Locking to the Base Station's Reference

To use your base station's reference, connect the reference from your base station as shown below, and then select one of the available TDMA Ref field choices on the TDMA TEST screen.

It takes several seconds for the test system to phase lock to a 25 or 50 Hz signal; wait for the front panel REFERENCE - Unlock annunciator to turn off, and the Ext TDMA annunciator to turn on, before making measurements. Also, always connect the reference signal to the test set before selecting the TDMA Ref field choice; this re-initiates the phase-lock routine needed for these low frequencies.

Figure 4-9 Phase Locking the Base Station's Reference

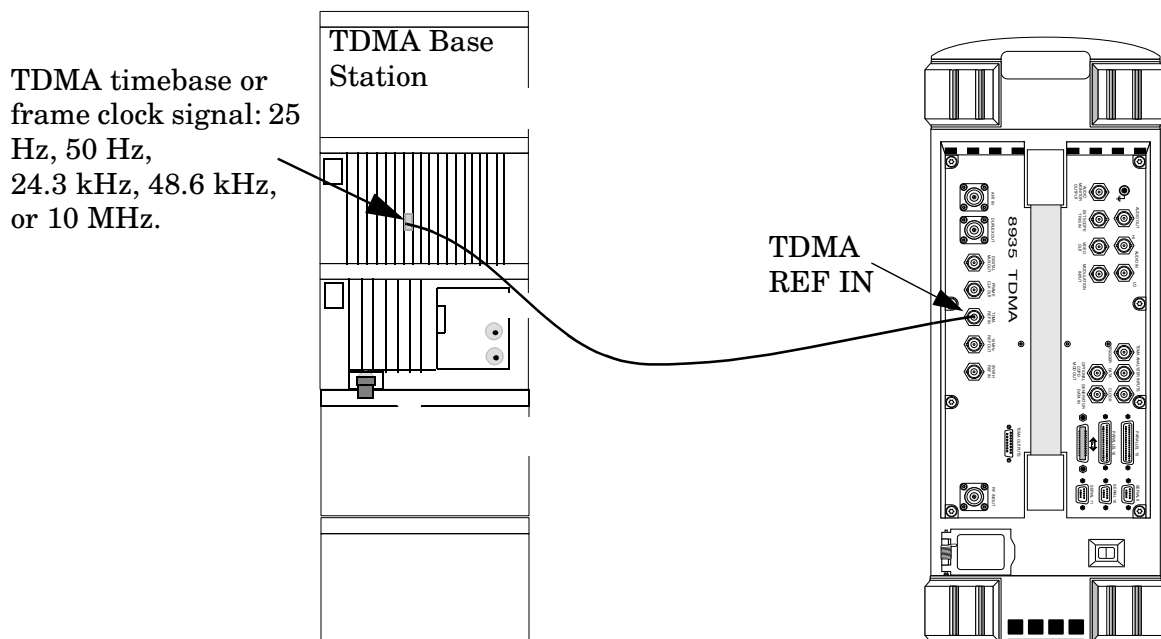
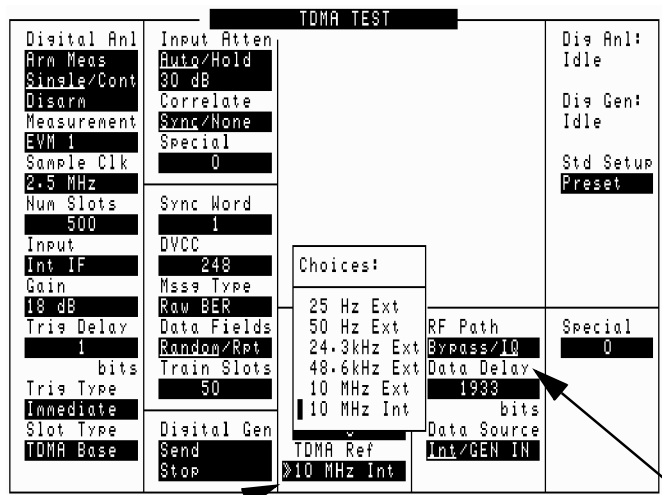

Figure 4-10 **Selecting the External TDMA Reference**



To synchronize the output of the Test Set's TDMA generator with the base station's receiver, set the TDMA Ref field to match the reference signal from the base station.

Also, when generating a TDMA signal, be sure to set the RF Path field to IQ to create IQ-modulated signals.

Setting Attenuator Level for Input Ports

When a measurement is made, the difference between the maximum signal level seen at the digital analyzer's input and the full-scale level needed for the measurement is displayed (in dB) in the `Max Abs` measurement field. For valid measurements, this value should be between 0 and -23 dB. (The closer to 0 dB (full-scale) the better, as long as the level never reaches 0.) This level is affected by three values:

- The amplitude of the TDMA signal connected to the Test Set.
- The RF ANALYZER screen's `Input Atten` setting.
- The TDMA TEST screen's `Gain` setting.

Status Codes for the Digital Analyzer

The `Status` field on the TDMA TEST screen indicates the status of the digital analyzer when making its measurements. The status encodes any errors that might have occurred during the measurement. The status is a bit-mapped collection of the error conditions. A status of 0.000000 means that no errors were reported.

How to Decode the Status Codes

A status of 22 for an error vector magnitude measurement would be decoded as follows (see [Table 4-1 on page 79](#)):

$$\begin{array}{rcccc} 22 & = & 16 & + & 4 & + & 2 \\ & & | & & | & & | \\ & & | & & | & & \text{Sync Even} \\ & & | & & | & & \\ & & | & & | & & \text{Weak Clock} \\ & & | & & | & & \\ & & | & & | & & \text{ADC Overdriven} \end{array}$$

Error Vector Magnitude (EVM) Measurement Status Codes

Table 4-1 on page 79 defines the status codes for EVM measurements.

Table 4-1 EVM Measurement Status Codes

Decimal	Bit	Description
1	0	Sync Error. The sync word contained an error or was not found. A measurement was made and results were returned.
2	1	Sync Even. The sync word began on the second bit of the symbol. A measurement was made and results were returned.
4	2	Weak Clock. The Test Set had difficulty to finding the data clock's phase, for example, when all zeros are transmitted. A measurement was made and results were returned, however, performance may be degraded.
8	3	ADC Under-driven. The absolute value of the peak sample was less than 30 dB below full scale of the ADC. A measurement was made and results were returned.
16	4	ADC Overdriven. The absolute value of the peak sample was at ADC full scale. A measurement was made and results were returned.
32	5	No Trigger or Clock Present. Not implemented.
64	6	Memory Overflow. The memory of the RX DSP board was exceeded. The measurement was aborted and zeros were returned.
128	7	Sync Early. The sync word occurred too soon in the burst. The measurement is invalid and aborted, and zeros are returned.
256	8	Sync Late. The sync word occurred too late in the burst. The measurement is invalid and aborted, and zeros are returned.
512	9	Converge Error. The parameter estimator does not converge. The measurement is aborted and zeros are returned.
1024	10	Parameter Error. The user selected incompatible pass parameters in the analyzer fields. No hardware is set and all zeros are returned. Only EVM cases are coded at this time.
2147483648	31	Default. Specific error information is not available.

Bit Error Rate (BERT) Measurement Status Codes

Table 4-2 on page 80 defines the status codes for BERT measurements.

Table 4-2 BERT Measurement Status Codes

Decimal	Bit	Description
1	0	Sync Error. Synchronization of the slots received with the first expected slot did not occur. All other measurement fields except SyncLoc are invalid.
2	1	Sync Even. The sync word began on the second bit of the symbol. A measurement was made and results were returned.
4	2	Weak Clock. The Test Set had difficulty finding the data clock's phase, for example, when all zeros are transmitted. A measurement was made and results were returned, however, performance may be degraded.
64	6	Memory Overflow. The memory of the RX DSP board was exceeded. The measurement was aborted.
1024	10	Parameter Error. The user selected incompatible pass parameters in the analyzer fields. No hardware is set and all zeros are returned.
2048	11	FIFO abort. The measurement was aborted due to communication with the DSP board while a measurement was armed. If the measurement is aborted due to communication with the DSP, the host will swallow the measurement and automatically re-arm another measurement. This error is only seen by the host firmware and is not reported to the Status field for the user.
4096	12	SyncLoc bad. An error-free sync word was not found. The SyncLoc result is not valid.

Adjacent Channel Power (ACP) Measurement Status Codes

Table 4-3 on page 81 defines the status codes for ACP measurements.

Table 4-3 ACP Measurement Status Codes

Decimal	Bit	Description
8	3	ADC under-driven. The absolute value of the peak sample is less than 30 dB below full scale of the ADC. A measurement is made and results are returned. (30 dB applies only to EVM measurements.)
16	4	ADC Overdriven. The absolute value of the peak sample was at ADC full scale. A measurement was made and results were returned.
64	6	Memory Overflow. The memory of the RX DSP board was exceeded. The measurement was aborted.
1024	10	Parameter Error. The user selected incompatible pass parameters in the analyzer fields. No hardware is set and all zeros are returned.
2048	11	FIFO abort. The measurement was aborted due to communication with the DSP board while a measurement was armed. If the measurement is aborted due to communication with the DSP, the host will swallow the measurement and automatically re-arm another measurement. This error is only seen by the host firmware and is not reported to the <code>Status</code> field for the user.
2147483648	31	Default. Specific error information is not available.

Channel Power and Average Power

Table 4-4 Status Codes

Decimal	Bit	Description
1	1	ADC Overdriven. The absolute value of the peak sample was at ADC full scale. A measurement was made and results were returned.

Mobile Assisted Handoff (MAHO) Status Codes

Table 4-5 on page 82 defines the status codes for mobile assisted handoffs (MAHO).

Table 4-5 MAHO Measurement Status Codes

Decimal	Bit	Description
16384	14	No channel quality message type was received from the mobile.
32768	15	No stable BER measurement was made; the last measured BER value is reported. Two identical successive measurements must be returned for a valid measurement to be recognized (200 to 300 slots are typically needed).

TDMA Tests Using HP-IB

The following program example performs an EVM Base measurement on the Test Set's digital generator. The RF Generator's frequency, amplitude, and output port are set up, the RF Analyzer is tuned to the same frequency as the RF Generator, and the TDMA Analyzer and generator are setup and triggered to make the measurement. Other than a Type 'N'-to-Type 'N' cable, no external equipment is required.

After connecting the RF IN/OUT port to the DUPLEX OUT port and pressing 'Continue' on your controller, the program continues until all the measurements displayed on the TDMA TEST screen are read back into your controller.

The measurements on the TDMA TEST screen are returned as a single comma-separated string. This program reads the measurement string and associates the measurement labels to the returned string values.

This program was written to run using the Test Set's internal IBASIC controller. To run this program on an external controller, change the bus select code in line 10 to match you controller (usually 7).

```

10 Bus=8 !Define the Bus Select Code (8=Test Set's internal controller).
20 Dut=100*Bus+14 !Define the HP-IB address of the Test Set.
30 CLEAR SCREEN
40 Print "Connect the RF IN/OUT port to the DUPLEX OUT port."
50 Print "Press 'Continue' to perform the test."
60 PAUSE
70 CLEAR SCREEN
80 OUTPUT Dut;"*RST" !PRESET the Test System.
90 OUTPUT Dut;"DISP RFG" !Display the RG Generator screen.
100 OUTPUT Dut;"RFG:FREQ 850 MHZ" !Create an 850 MHz carrier.
110 OUTPUT Dut;"RFG:OUTP 'DUPL'" !Send carrier out the DUPLEX OUT port.
120 OUTPUT Dut;"RFG:AMPL 5 DBM" !Set the carrier amplitude.
130 OUTPUT Dut;"DISP RFAN" !Display the RF ANALYZER screen.
140 OUTPUT Dut;"RFAN:FREQ 850 MHZ" !Set Tune Frequency to 850 MHz.
150 OUTPUT Dut;"RFAN:INP 'RF IN'" !Set the Input Port to RF In.
160 OUTPUT Dut;"RFAN:ATT:MODE 'HOLD'" !Set Input Atten ranging to Hold.
170 OUTPUT Dut;"TRIG:MODE:RETR SING" !Set trigger to make one measurement.
180 OUTPUT Dut;"DISP TDMA" !Display the TDMA Dual Mode Test screen.
190 OUTPUT Dut;"DGCommon:SETup 'EVM Base'" !Select the EVM Base Std Setup.
200 OUTPUT Dut;"DGG:SEND" !Modulate carrier with Digital Gen's TDMA data.
210 OUTPUT Dut;"TRIG" !Trigger the measurement.
220 DIM Values(30),Label$(30)[20] ! Dimension measurement arrays
230 ON TIMEOUT Bus,10 GOTO Timeout ! Set a 10 second timeout in case a
240 ! valid measurement cannot be made and the bus gets'hung'.
250 OUTPUT Dut;"MEAS:DGAN:VAL?" ! Query measurement values.
260 Num_values=FNRead(Dut,Values(*)) ! Enter measurement values into the
270 ! Values array, and read the number of values returned.
280 FOR I=1 TO Num_values ! Define number of measurement labels.
290 OUTPUT Dut;"MEAS:DGAN:LAB? ";I-1 ! Query measurement labels.

```

TDMA Measurement Basics
TDMA Tests Using HP-IB

```
300 ENTER Dut;Label$(I) ! Enter returned labels in the 'Label' array.
310 NEXT I
320 OFF TIMEOUT Bus ! Disable timeout after measurement
330 !
340 FOR I=1 TO Num_values ! Echo the results sent to
350 PRINT Label$(I),Values(I) ! the screen on the controller.
360 NEXT I
370 PRINT
380 !
390 ! Print selected results. The FNSearch function is used to
400 ! return the index into the previously read Values array to
410 ! to find the values to be printed. The following example
420 ! shows that the entire label doesn't need to be passed in as a
430 ! search string, and that the searches allow the program to
440 ! print out the values in any order. If a label is not found
450 ! then the value MAXREAL is returned.
460 !
470 Values(0)=MAXREAL ! Error indicator, if string not found
480 PRINT "Error Vector Mag = ";Values(FNSearch(Num_values,Label$(*),"EVM"))
490 PRINT "Origin Offset = ";Values(FNSearch(Num_values,Label$(*),"Org Ofs"))
500 PRINT "Status = ";Values(FNSearch(Num_values,Label$(*),"Status"))
510 PRINT "Error Example= ";Values(FNSearch(Num_values,Label$(*),"No
String"))
520 !
530 STOP
540 !
550 Timeout: ! Specify what to do if a measurement timeout occurs.
560 PRINT
570 PRINT "Measurement timed out."
580 CLEAR Bus
590 STOP
600 !
610 END
620 !
630 ! Search elements 1 through Array_size (inclusive) of String_array$
640 ! for an element that includes Search_string$. Return the index
650 ! of the first element containing it, or 0 if not found. Array_size
660 ! must be >= 1.
670 !
680 DEF FNSearch(Array_size,String_array$(*),Search_string$)
690 N=1
700 WHILE N <=Array_size AND NOT POS(String_array$(N),Search_string$)
710 N=N+1
720 END WHILE
730 IF (N>Array_size) THEN N=0
740 RETURN N
750 FNEND
760 !
770 ! Read a comma-separated list of floating-point values from Addr
780 ! into Array, and return the number read. Array must be
790 ! dimensioned large enough to accept the maximum number of
800 ! returned values.
```

```
810      !
820      DEF FNRead(Addr,Array(*) )
830      I=1
840      ON ERROR GOTO End_loop
850      REPEAT
860      ENTER Addr USING "%,16D,B";Array(I),Separator
870      I=I+1
880      UNTIL Separator=10! New-line
990 End_loop:      !
900      OFF ERROR
910      N=I-1
920      RETURN N
930      FNEND
```

5

Overview of the Test Set's Built-In Tools

- [“Using the RF Tools Program” on page 89](#)
- [“Using the Spectrum Analyzer” on page 116](#)

- “Using the Voltmeter and Audio Frequency Counter” on page 123
- “Using the Oscilloscope (Scope)” on page 125
- “Securing a Test Procedure” on page 129
- “Clearing RAM” on page 130
- “Using the LISTOPTS (list options) Program” on page 131
- “Using the ST_PLT (store or plot) Program” on page 132

Using the RF Tools Program

The RF Tools program resides in the Test Set's ROM. This guide supports RF Tools version B.02.11.

- “Loading and Running RF Tools” on page 89
- “Test Results/BTS Utility Setup” on page 90
- “Swept Gain” on page 93
- “Discrete Frequency Insertion Loss” on page 96
- “Swept Insertion Loss” on page 99
- “Swept Return Loss” on page 102
- “Cable Fault” on page 106
- “Replot Data Files” on page 112
- “Transfer Stored Data” on page 112
- “SA (Spectrum Analyzer) Self Calibration ON/OFF” on page 113
- “Catalog PC (Memory) Card” on page 115

Loading and Running RF Tools

1. Press the MENU key to display the SOFTWARE MENU screen (shown below).

Figure 5-1 SOFTWARE MENU Screen

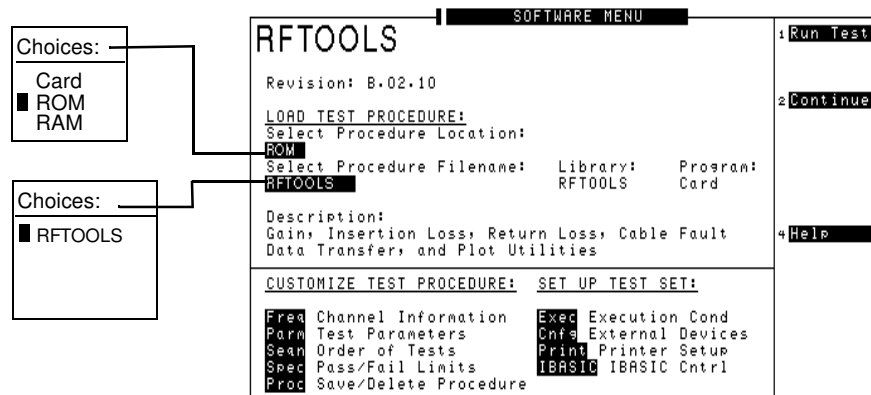

2. Position the cursor at the highlighted area under **Select Procedure Location** and push the knob to select it. A **Choices** menu appears.
3. Position the cursor at **ROM** and select it.
4. Position the cursor at the highlighted area under **Select Procedure Filename** and select it. A **Choices** menu appears.

5. Position the cursor at **RFTOOLS** and select it.
6. Press **k1 (Run Test)**. The software is now loading. Wait for the RF Tools Main Menu screen (Figure 5-2 on page 90).
7. Select an item from the menu.

Figure 5-2 RF Tools Main Menu Screen

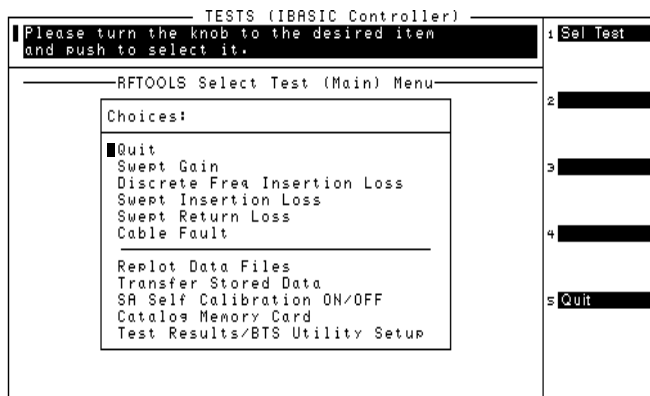

Test Results/BTS Utility Setup

Use this setup to configure a method for measurement data collection. Measurement results may be collected using a printer, a laptop, or a PC card.

Figure 5-3 Test Results/BTS Utility Setup Screens

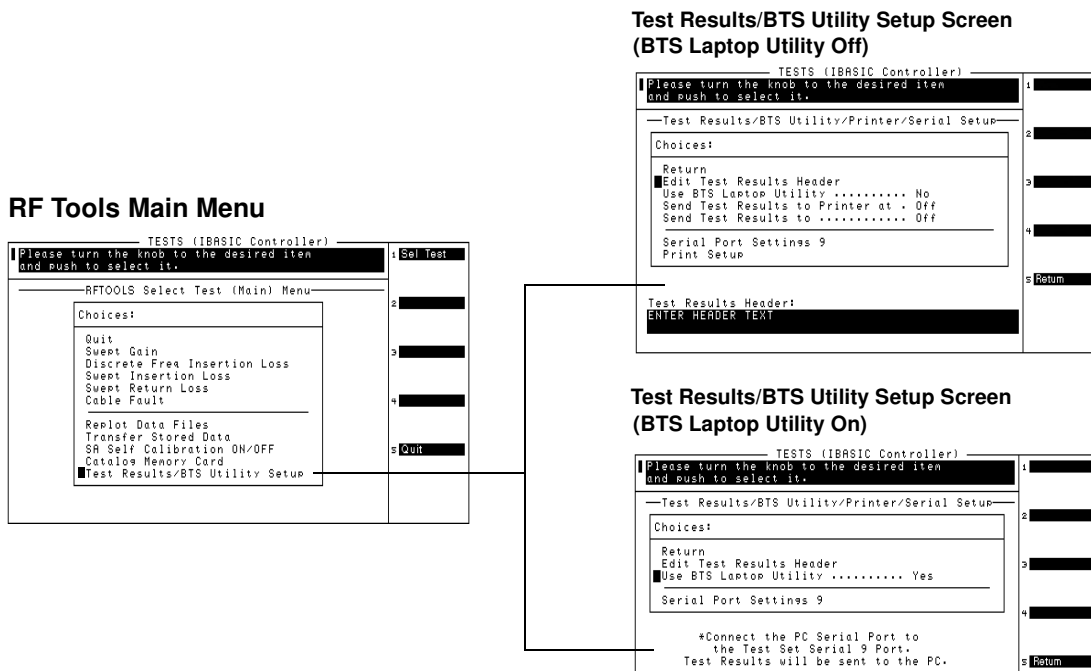

To use a laptop and the BTS Laptop Utility for data collection:

This function of RF Tools is used with the BTS Laptop Utility program. Test results can be stored as ASCII or plot data. For more information on this utility, refer to the on-line help accompanying the BTS Laptop Utility software.

1. Position the cursor at **Use BTS Laptop Utility** and select it (see [Figure 5-3 on page 90](#)). The screen changes to show only the appropriate options.
2. Position the cursor at **Serial Port Settings 9** and select it. The serial port settings appear. Serial baud, parity, data length, stop length, and flow control can be edited.
3. Confirm that these serial port settings match the BTS Laptop Utility settings on the laptop.
4. Press **k5 (Return)** to return to the Test Results/BTS Utility/Printer/Serial Setup.
5. Press **k5 (Return)** to exit the setup.

To use a printer for data collection:

1. If **Use BTS Laptop Utility** is set to **Yes**, change it to **No** by selecting the field.
2. Position the cursor at **Send Test Results to Printer at** and select it. A **Choices** menu appears.
3. Position the cursor at the correct port and select it.
4. Position the cursor at **Print Setup** and select it. Lines per page and form feed locations can be edited.
5. Press **k5 (Return)** to go back to the previous menu.

To use a laptop interface other than the BTS Laptop Utility

1. If **Use BTS Laptop Utility** is set to **Yes**, change it to **No** by selecting the field.
2. Position the cursor at **Send Test Results to** and select it. A **Choices** menu appears.
3. Position the cursor at **Serial 9** and select it.
4. Position the cursor at **Serial Port Settings 9** and select it. A list of serial port settings appears.
5. Confirm that these serial port settings and the settings on the laptop match.
6. Press **k5 (Return)** to return to the Test Results/BTS Utility/Printer/Serial Setup.
7. Press **k5 (Return)** to exit the setup.

Swept Gain

Measurement Description

This test measures the gain of a device by sweeping it over the specified frequency range. Gain is the ratio of the output power to the input power. For the swept gain test, gain is measured in dB. The gain is the output power in dBm minus the input power in dBm. For example, if the amplifier has an output of 22 dBm and an input of 4 dBm, it has a gain of 18 dB.

Making the Measurement

NOTE

This test radiates a test signal when testing antennas or cables with antennas attached to them. Verify that the level and frequency span used for the test cannot result in interference to other nearby antennas. To minimize interference when running the program, set the power level at the DUPLEX OUT port to the minimum value needed for good measurement resolution. Set the frequency range carefully.

1. Select **Swept Gain** from the Select Test (Main) Menu. The Swept Gain Measurement menu will appear.

Figure 5-4 Selecting the Swept Gain Measurement Test

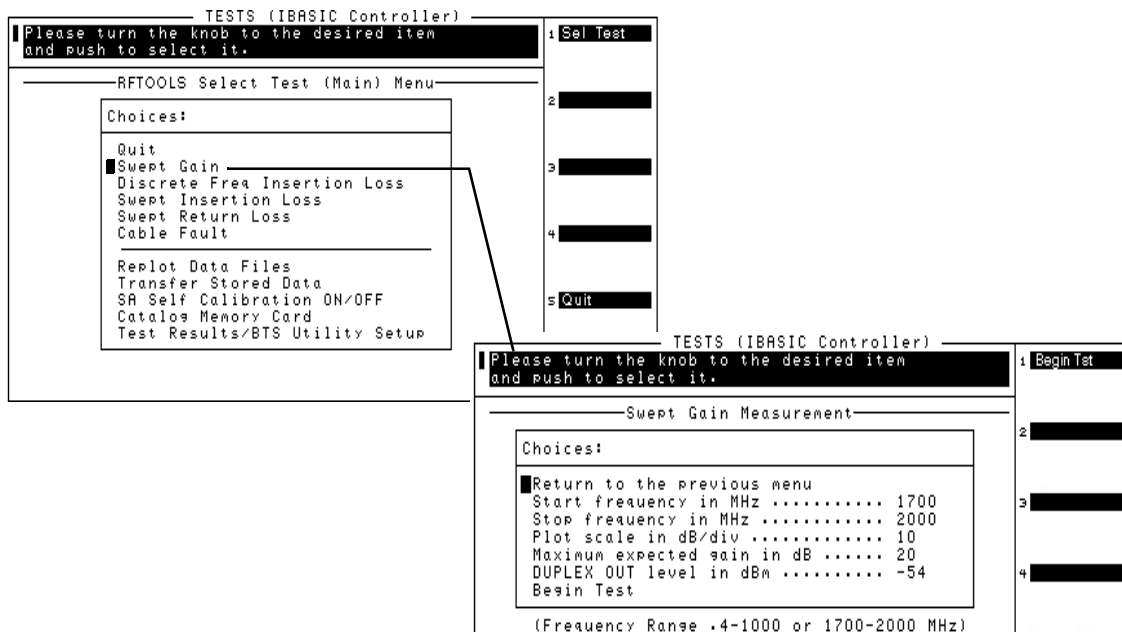

2. Position the cursor at **Start Frequency in MHz** and select it. Enter a value for the start of the frequency sweep from 0.4 MHz to 1000 MHz or 1700 MHz to 2000 MHz.

3. Position the cursor at **Stop frequency in MHZ** and select it. Enter a value from 0.4 MHz to 1000 MHz or 1700 MHz to 2000 MHz. This value should be larger than the start frequency and in the same frequency band.
4. Position the cursor at **Plot scale in dB/div** and select it. A **Choices** menu appears. The available choices are 1, 5 or 10.
5. Position the cursor at **Maximum Expected Gain in dB** and select it. Enter a value in the range of -50 to $+40$ dB. This parameter sets the expected worst case power for the ANT IN port. It is very important to overestimate the expected gain to avoid damage to the ANT IN port. This parameter also determines plot resolution by setting the upper limit.
6. Position the cursor at **DUPLEX OUT Level in dBm** and select it. Enter the power level, -54 to $+10$ dBm, at which the test should be conducted. If you are testing a power sensitive device, enter a low level value to avoid damage to that device.

CAUTION

Damage may result if the power input to the Test Set's ANT IN port exceeds 60 mW (which is equivalent to 18 dBm). Damage may also result to the unit-under-test if it is overdriven by the DUPLEX OUT power level. To avoid damage to the unit under test, enter a low power level for the **DUPLEX OUT level in dBm** parameter.

7. Press **k1 (Begin Tst)**.

Figure 5-5 Swept Gain Setups

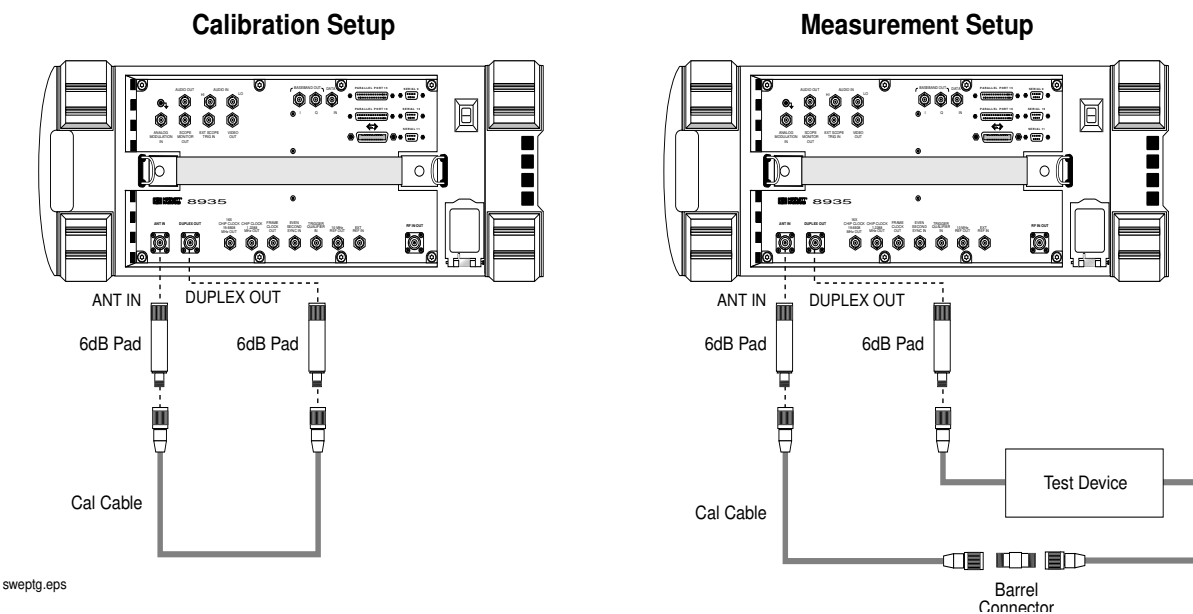

sweptg.eps

8. A setup screen appears with a diagram of the necessary connections, similar to the Calibration Setup of Figure 1-2. This test requires two 6-dB pads (attenuators). The pads are put on the Test Set's ANT IN and DUPLEX OUT ports to reduce impedance mismatch error at these ports. A reference level is obtained by connecting a short calibration cable between the pads on the DUPLEX OUT and ANT IN ports. Set up the hardware, then press **k1 (Proceed)** or the knob to continue.
9. Another setup screen appears similar to the Measurement Setup of Figure 5-5 on page 94. Attach the device to be tested between the calibration cable and one of the pads. In this step, a measurement is made of the additional gain from the reference level. Press **k1 (Proceed)** or the knob to continue.
10. The trace of the device gain over the frequency range swept is displayed. If the gain exceeds 40 dB, it will not appear on the trace. The maximum gain is also displayed as text on the screen. To save the plot to a PC card, press **k4 (Save Plot)** and use the knob to enter a filename. Press **k5 (Scr Dump)** to send the image to a printer or to the BTS Laptop Utility. Directions will appear at the top of the screen. Press **Print** and allow the image to print to the connected device. Then, press **Pause/Continue**. Press **k1(Proceed)** when you are ready to continue.

Figure 5-6 Example of a Swept Gain Plot Screen

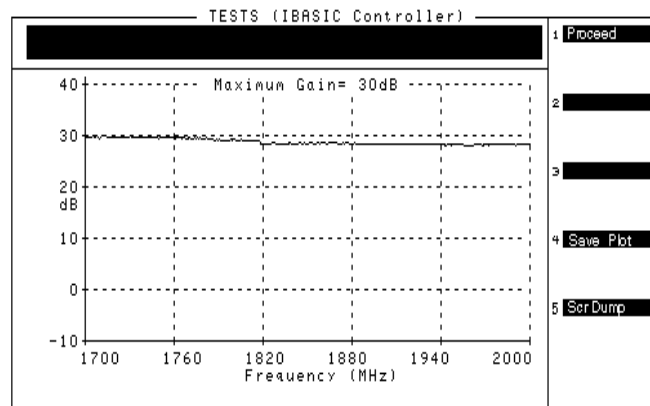

11. The swept gain results screen (see Figure 5-7) appears with the test results. If the BTS Laptop Utility is in use, this data is collected by the laptop. If you wish to repeat the test using the same calibrated devices and test parameters, press **k1 (Repeat)**. To re-display the plot screen, press **k3 (Disp Plot)**. To return to the **Select Test Menu**, press **k5 (Return)**.

Figure 5-7 Example of a Swept Gain Results Screen

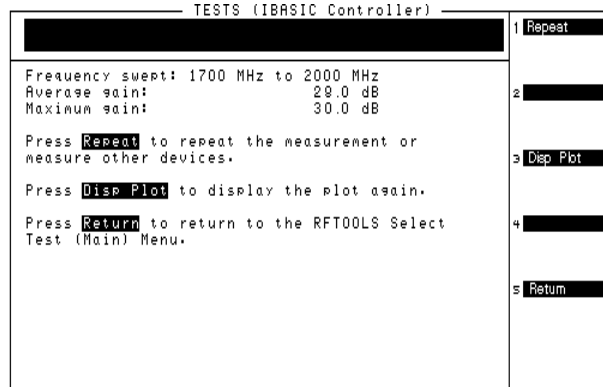

Specifications

- Frequency Range: 0.4-1000 MHz, 1.7-2.0 GHz
- Swept Signal Level: -54 dBm to +10 dBm

Discrete Frequency Insertion Loss

Measurement Description

The discrete frequency insertion loss test measures the loss of a cable or device at a specific frequency. DSP (Digital Signal Processing) is used to determine the results of this test, making it more accurate than the Swept Insertion Loss test.

Making the Measurement

1. Select **Discrete Freq Insertion Loss** from the **Select Test (Main)** Menu. The **Discrete Frequency Insertion Loss Test** menu will appear.

Figure 5-8 Selecting the Discrete Frequency Insertion Loss Test

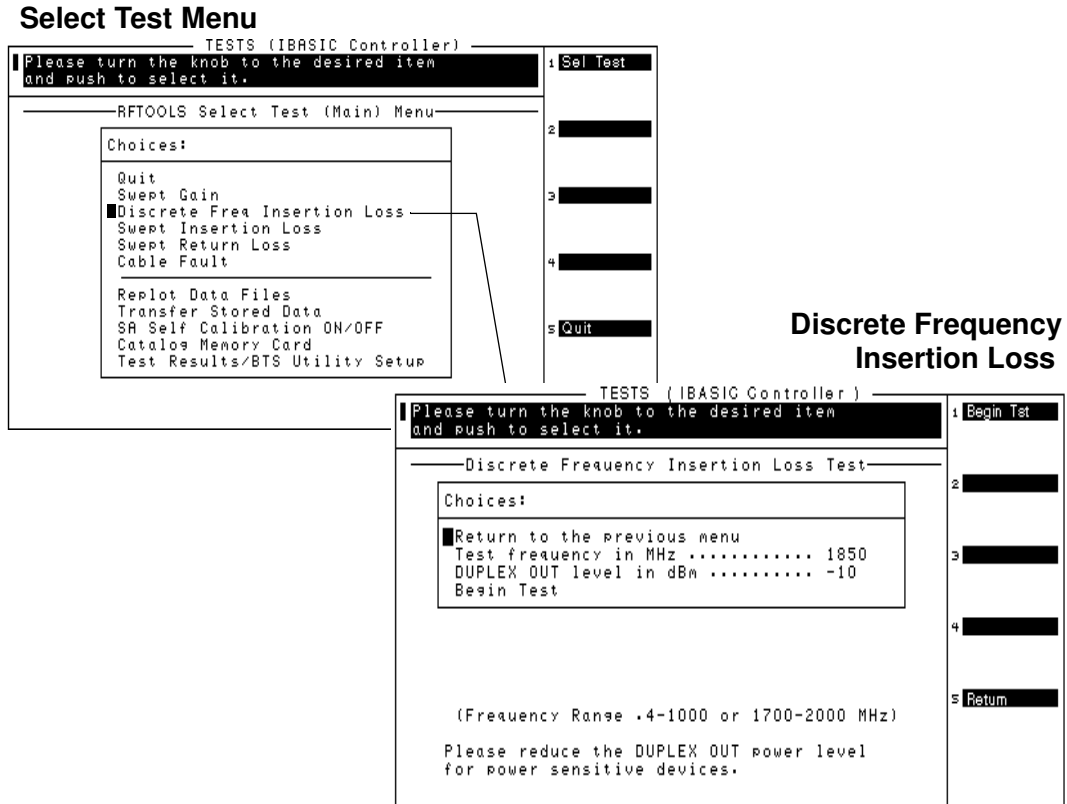

2. Position the cursor at **Test frequency in MHz** and enter the specific frequency to be tested.
3. Position the cursor at **DUPLEX OUT Level in dBm** and enter the power level at which the test should be conducted.
4. Press **k1 (Begin Test)** to begin the test.

Figure 5-9 Discrete Frequency Insertion Loss Setups

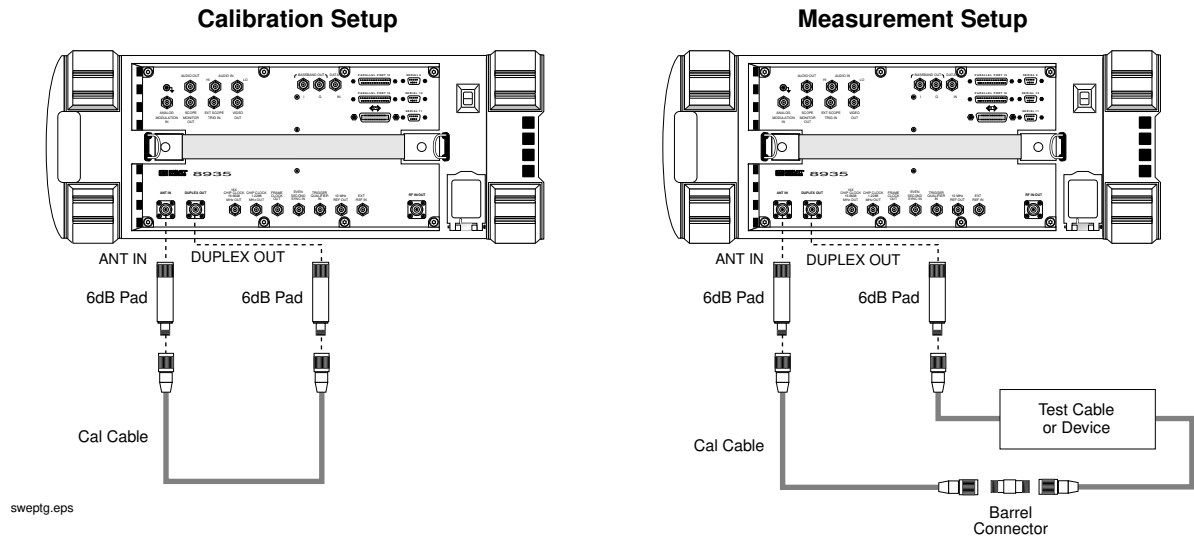

5. A screen appears with a setup diagram. (Figure 5-9) This test requires two 6-dB pads. The pads are put on the ANT IN and DUPLEX OUT ports on the Test Set to reduce impedance mismatch error at these ports. A reference level is obtained by connecting a short calibration cable between the pads on the DUPLEX OUT and ANT IN ports. Press **k1 (Proceed)**.
6. After the Test Set has finished calibrating, a second diagram appears on the screen. Connect the test cable or device to be tested between the calibration cable and one of the pads. Press **k1 (Proceed)**.
7. The discrete frequency insertion loss results screen appears with the results of the test. The loss is expressed as a negative number in this particular test.

NOTE

The insertion loss at the specified frequency is displayed twice. The second display is enlarged for easier reading.

8. Press **k1 (Proceed)** when you are finished with this screen. The Discrete Frequency Insertion Loss Test menu appears. If you would like to repeat the measurement press **k1 (Begin Tst)**. The calibration step will be skipped if none of the parameters were changed. To exit the test press **k5 (Return)**.

Swept Insertion Loss

Measurement Description

This test measures the loss of a cable or device by sweeping it over the specified frequency range. This test uses the Spectrum Analyzer to make measurements.

Making the Measurement

1. Select **Swept Insertion Loss** from the Select Test (Main) Menu. A Swept Insertion Loss Information menu will appear.

Figure 5-10 Selecting the Swept Insertion Loss Measurement

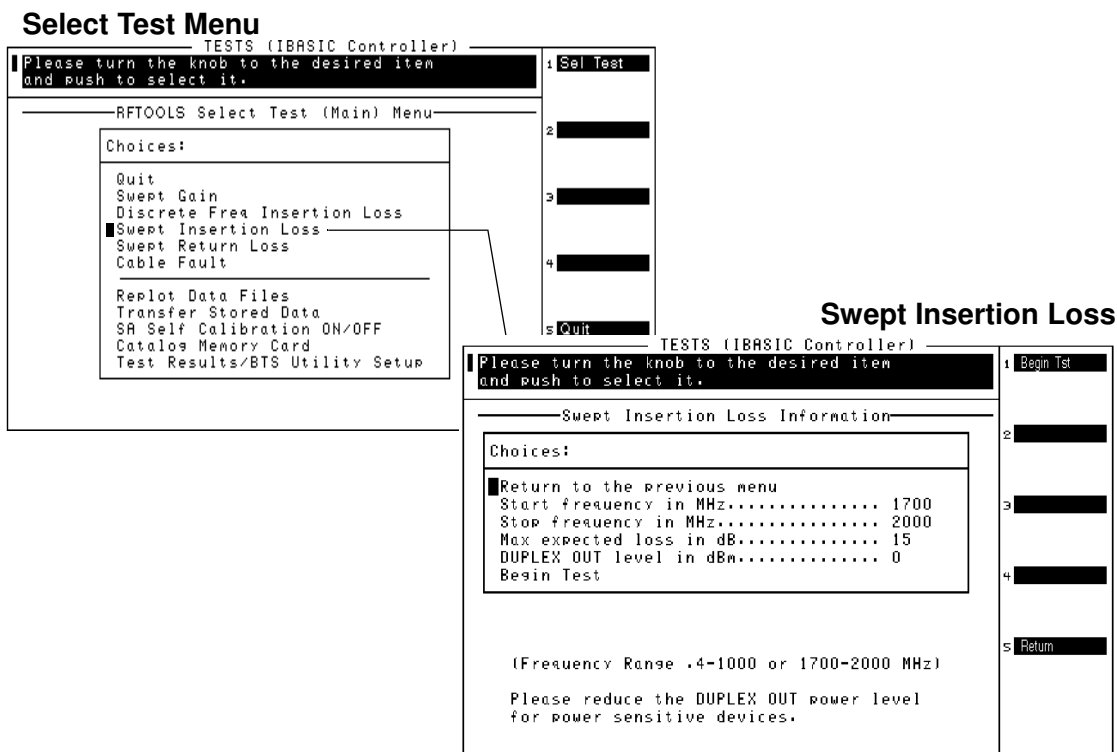

2. Position the cursor at **Start frequency in MHz** and select it. Enter a value for the start of the frequency sweep from 0.4 MHz to 1000 MHz or 1700 MHz to 2000 MHz.
3. Position the cursor at **Stop frequency in MHz** and select it. Enter a value from 0.4 MHz to 1000 MHz or 1700 MHz to 2000 MHz. This value should be larger than the start frequency.

4. Position the cursor at **Max expected loss in dB** and enter the greatest loss expected through your device. The insertion loss will be displayed from 0 dB to the value entered in this field. Therefore, if the **Max expected loss in dB** is set higher than the measured insertion loss, the plot will not display any test data. Enter the appropriate value.
5. Position the cursor at **DUPLEX OUT level in dBm** and enter the appropriate value. Unless you are measuring loss through a power sensitive device, the default level should work correctly.
6. Press **k1 (Begin Tst)** to begin the test.

Figure 5-11 Swept Insertion Loss Setups

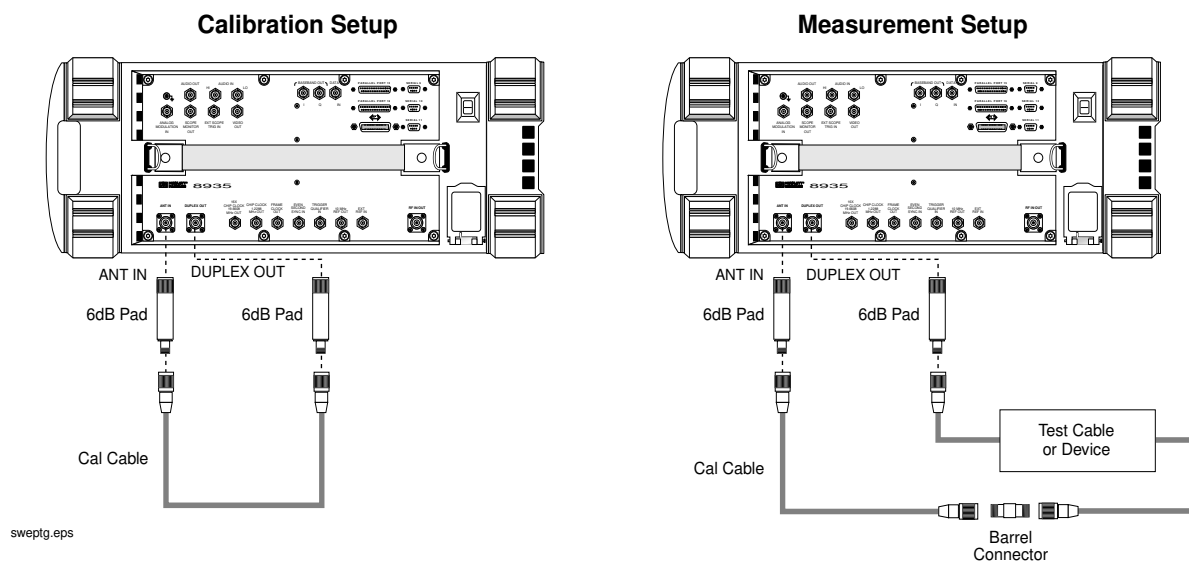

7. A calibration setup screen appears with a diagram of the necessary connections (Figure 5-11). This test requires two 6-dB pads. The pads are put on the ANT IN and DUPLEX OUT ports on the Test Set to reduce impedance mismatch error at these ports. A reference level is obtained by connecting a short calibration cable between the pads on the DUPLEX OUT and ANT IN ports. Setup the hardware, then press **k1 (Proceed)** or the knob to continue.
8. After the Test Set has finished calibrating, a second diagram similar to the Measurement Setup of Figure 5-11 appears on the screen. Connect the test cable or device to be tested between the calibration cable and one of the pads. Press **k1 (Proceed)** or the knob to continue.

9. The trace of the cable loss over the frequency range swept is displayed. The average loss is also displayed on the screen. To save the plot to a PC card, press **k4 (Save Plot)** and use the knob to enter a filename. Press **k5 (Scr Dump)** to send the image to a printer or to the BTS Laptop Utility. Directions will appear at the top of the screen. Press **Print** and allow the image to print to the connected device. Then, press **Pause/Continue**. Press **k1 (Proceed)** when you are ready to proceed
10. The swept insertion loss results screen appears with the test results. If the BTS Laptop Utility is in use, this data is collected by the laptop. If you wish to repeat the test using the same calibrated devices and test parameters, press **k1 (Repeat)**. To re-display the plot screen, press **k3 (Disp Plot)**. To return to the **Select Test (Main) Menu**, press **k5 (Return)**.

Estimating Swept Insertion Loss Using a Single Connection

Rather than directly measuring the transmitted signal (requiring connections at both ends), a known high-quality short can be put at the end of the cable. Knowing that this will reflect 100% of the signal, the Swept Return Loss test ([page 102](#)) can be used and the measured return loss in dB can simply be divided by 2 to get the system's estimated insertion loss. If the return loss is not in dB, the square root of the measurement would be the system's insertion loss. An open can also be used instead of a short, but the results will not be as precise.

Specifications

- Frequency Range: 0.4-1000 MHz, 1.7-2.0 GHz
- Swept Signal Level: -54 dBm to +10 dBm
- Insertion Loss Accuracy: +/- 0.75 dBm

Swept Return Loss

Measurement Description

Swept return loss is a measure of reflection characteristics. The purpose of the swept return loss test is to detect problems in the antenna feed line system and the antenna itself. A portion of the incident power will be reflected back to the source from each transmission line fault as well as the antenna. The ratio of the reflected voltages to the incident voltage is called the reflection coefficient. The reflection coefficient is a complex number, meaning it has both magnitude and phase information.

The return loss is defined as the magnitude part of the reflection coefficient and is expressed in decibels (dB). Therefore, the return loss is a measure of how large the reflected wave is to the original incident wave. Remember that this measurement is in terms of loss, therefore a large number means that very little signal was reflected back. A loss of 0 dB indicates that all of the incident wave is reflected, whereas a return loss of 40 dB, for example, would indicate that very little of the signal is reflected. When a device is frequency swept, a graph similar to [Figure 5-14 on page 105](#) is obtained. This is an example of a radio transmitting at a particular frequency. It can be seen that the return loss at that frequency is a very large number which tapers off to small return losses at all other frequencies.

Another way of looking at the same information is the SWR (also known as VSWR: Voltage Standing Wave Ratio). VSWR is stated as a ratio. For example: 1.2:1 or “one point two to one” VSWR. The first number in the ratio is a value between 1 and infinity. 1 indicates that none of the incident wave is reflected. Infinity implies that all of the incident wave is reflected. Therefore, the closer this number is to 1, the better the feed line system performance. The second number in the ratio is always one.

Making the Measurement

NOTE

When testing antennas or cables with antennas attached to them, a test signal is radiated. Verify that the level and frequency span used for the test cannot result in interference to other nearby systems. To minimize interference when running the program, set the power level at the DUPLEX OUT port to the minimum value needed for good measurement resolution. Set the frequency range carefully.

1. Select **Swept Return Loss** from the Select Test (Main) Menu. The Swept Return Loss Information menu will appear.

Figure 5-12 Selecting the Swept Return Loss Measurement

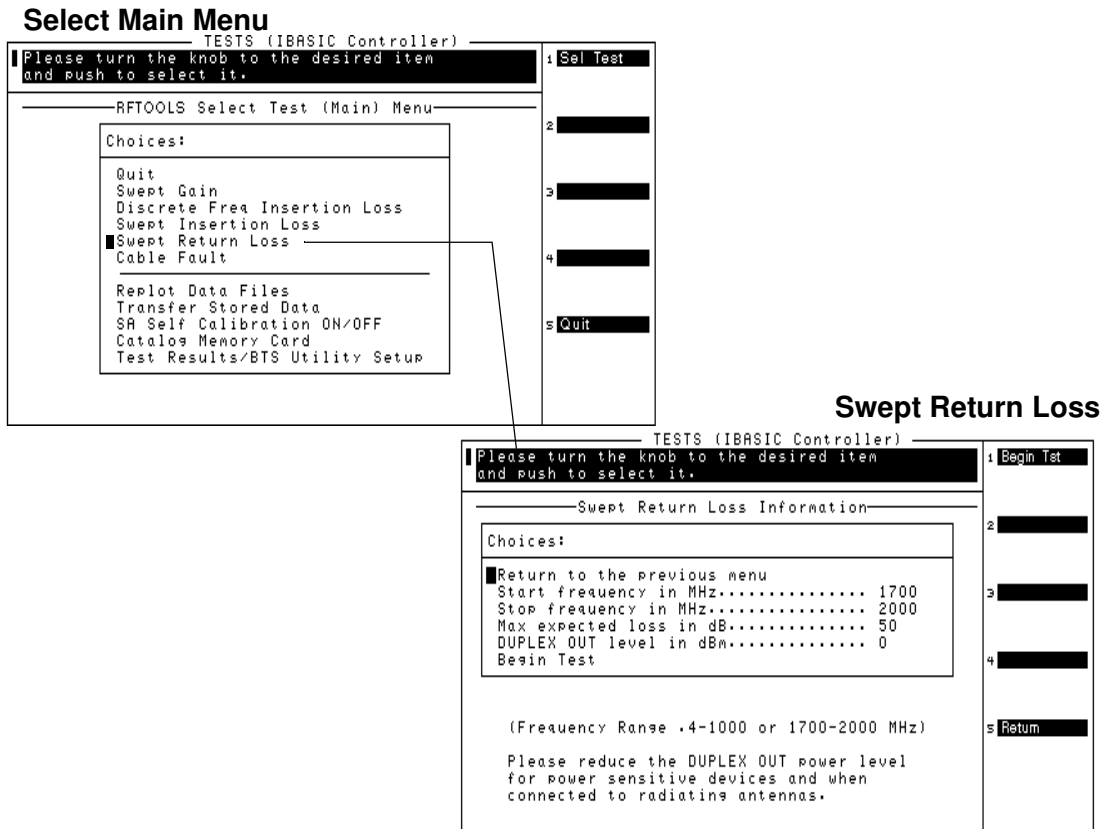

2. Position the cursor at **Start frequency in MHz** and select it. Enter a value for the start of the frequency sweep from 0.4 MHz to 1000 MHz or 1700 MHz to 2000 MHz.
3. Position the cursor at **Stop frequency in MHz** and select it. Enter a value from 0.4 MHz to 1000 MHz or 1700 MHz to 2000 MHz. This value should be larger than the start frequency and in the same frequency band.
4. Position the cursor at **Max expected loss in dB** and select it. The return loss will be displayed from 0 dB to the value entered in this field. Therefore, if the **Max expected loss in dB** is set higher than the measured return loss, the plot will not display any test data. Enter the appropriate value.
5. Position the cursor at **DUPLEX OUT Level in dBm** and select it. Enter the power level at which the test should be conducted.

CAUTION

Damage may result if the power input to the Test Set's ANT IN port exceeds 60 mW (which is equivalent to 18 dBm). Damage may also result to the unit-under-test if it is overdriven by the DUPLEX OUT power level. To avoid damage to the ANT IN port, enter an over-estimate gain value for the **Max expected gain in dB** parameter. To avoid damage to the unit under test, ensure a low power level for the **DUPLEX OUT level in dBm** parameter.

6. Press **k1 (Begin Tst)** or position the cursor at **Begin** and select it.

Figure 5-13 Swept Return Loss Setups

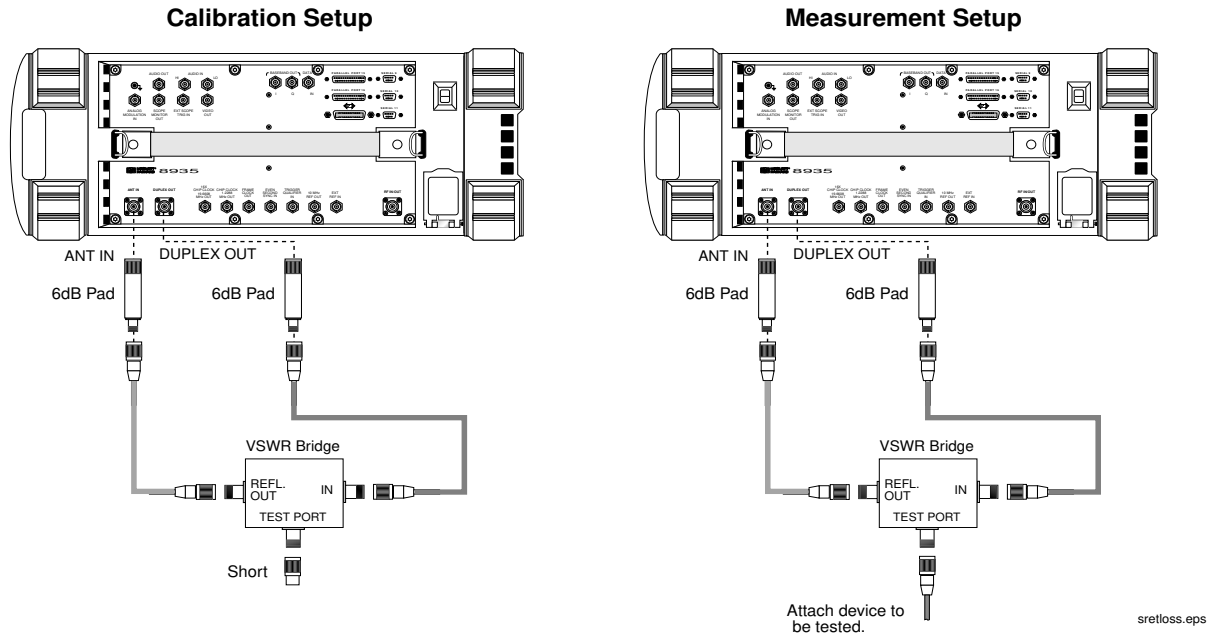

7. A setup screen appears with a diagram of the necessary connections, similar to [Figure 5-13](#). This is the calibration phase of the test to obtain a reference level for the device being tested. A VSWR bridge or a directional coupler and two 6 dB pads are connected to the Test Set. The pads are used to reduce impedance mismatch errors between the VSWR bridge and the DUPLEX OUT and ANT IN ports on the Test Set. A reference level is measured first with a short on the DUT (Device Under Test) port of the VSWR bridge. An open can be used as well, but the open must not be blocked in any way that might cause the signal to be reflected back. For example, using the open setup inside a van or other enclosed area may introduce inaccuracies in the measurement. Setup the hardware, then press **k1 (Proceed)** or the knob to continue.
8. Another setup screen appears. Attach the device being tested. Press **k1 (Proceed)** or the knob to continue.

- The plot screen appears. The trace showing return loss over the frequency band selected is displayed on the screen. Measured values for best and worst case return loss and VSWR are printed at the top of the screen. To save the plot to a PC card, press **k4 (Save Plot)** and use the knob to enter a filename. Press **k5 (Scr Dump)** to send the image to a printer or to the BTS Laptop Utility. Directions will appear at the top of the screen. Press **Print** and allow the image to print to the connected device. Then, press **Pause/Continue**. Press **k1 (Proceed)** when you are ready to proceed.

Figure 5-14 Example of a Swept Return Loss Plot Screen

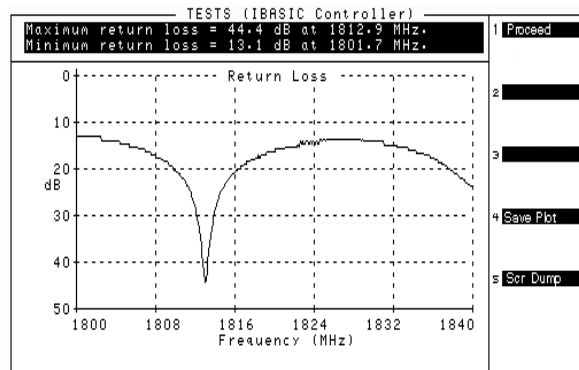

- The swept return loss results screen appears with the test results. If the BTS Laptop Utility is in use, this data is collected by the laptop. If you wish to repeat the test using the same calibrated devices and test parameters, press **k1 (Repeat)**. To re-display the plot screen, press **k3 (Disp Plot)**. To return to the **Select Test (Main)** menu, press **k5 (Return)**.

Figure 5-15 Example of an Swept Return Loss results screen

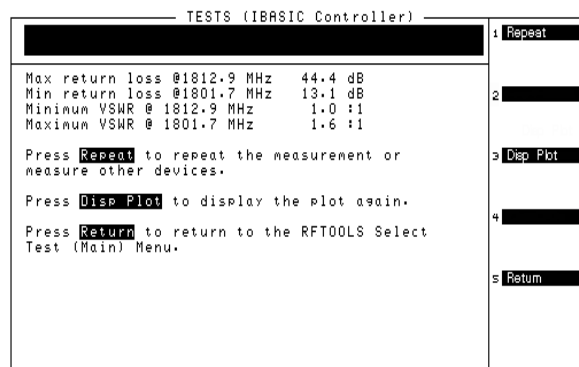

Estimating Antenna Return Loss

If you are measuring the return loss of an antenna connected to the end of a known good feed line, you can determine the approximate return loss of the antenna by subtracting twice the line loss. For example, if you measure a return loss of 24 dB and the line is known to have 2 dB loss, the estimated return loss of the antenna is 20 dB (since there is a total of 4 dB of loss from the feed line). For this estimate to be correct, the coaxial line and connectors must have a much smaller loss than the total return loss.

Specifications

- Frequency Range: 0.4-1000 MHz, 1.7-2.0 GHz
- Swept Signal Level: -54 dBm to +10 dBm
- Swept Return Loss Accuracy: +/- 2dB +/-10% of reading, for readings between 0 dB and 30 dB

Cable Fault

Measurement Description

A frequency-swept signal is transmitted from the DUPLEX OUT port of the Test Set through a resistive power divider to the cable-under-test. The signals reflected from faults in the cable are combined in the power divider with the transmitted signal and received at the ANT IN port.

The changing interference of the transmitted and reflected signals, over the swept frequency band, contains information about the distance to one or more faults. The software uses a Fast Fourier Transform (FFT) to convert the frequency domain into the time domain. The information in the time domain can be used to find the physical distances. The distance displayed on the Test Set's CRT is the physical distance to the fault with correction for the velocity factor of the cable. This test allows the operator to identify, characterize, and isolate potential problem locations by viewing it in units of distance.

NOTE**Test Signal Can Cause Interference**

When testing cables attached to antennas, test signals will be radiated. Verify that the signal used for the test cannot result in interference to another antenna.

Making the Measurement

1. Select **Cable Fault** from the Select Test (Main) Menu. The Cable Fault Information menu will appear.

Figure 5-16 Selecting the Cable Fault Measurement

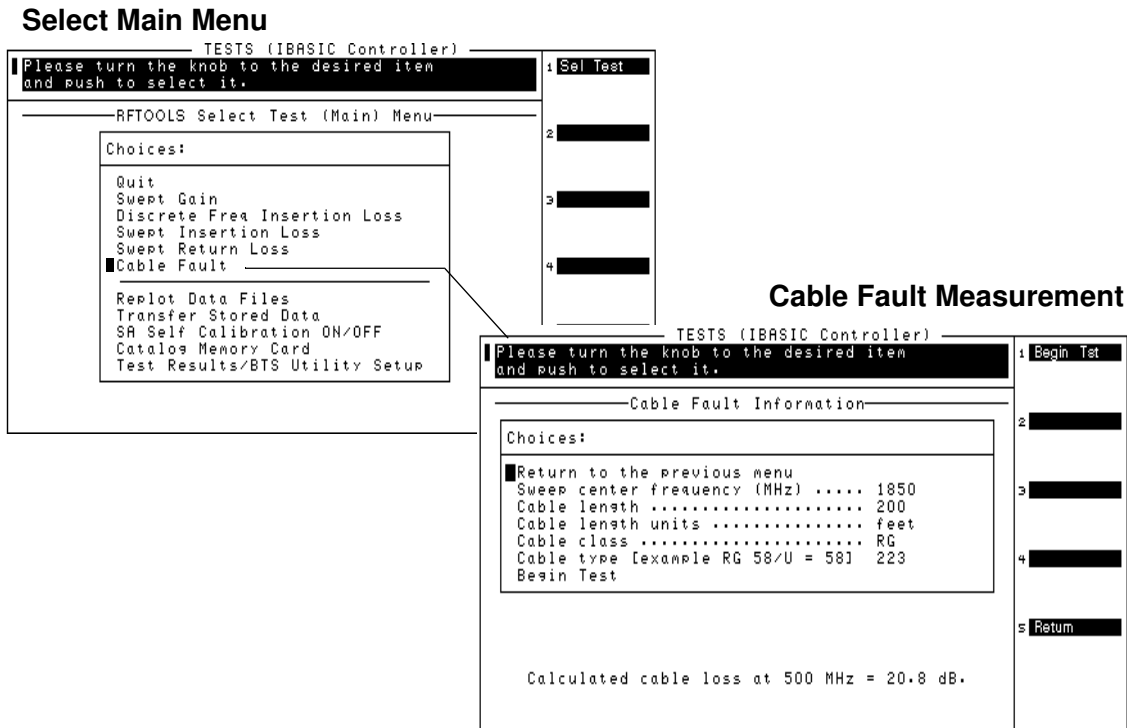

2. Position the cursor at **Sweep center frequency (MHz)** and select. A **Choices** menu appears.
 - **505 MHz** - Use this center frequency for high resolution, short range cable tests. The cable lengths can range from 10 to 1000 ft.
 - **850 MHz** - Use this center frequency for cable tests at cellular frequencies. This should be used for frequency sensitive devices, such as filters, and has a cable length range of 150 to 1000 ft.
 - **1850 MHz** - Use this center frequency for cable tests at PCS frequencies. This should also be used for frequency sensitive devices and has a cable length range of 150 to 1000 ft.
3. Position the cursor at **Cable length** and enter the appropriate value.

NOTE

The greatest accuracy is obtained when you enter a cable length slightly greater than the cable length being tested. If you are not sure of the cable length, enter a value 1.5 times the estimated length. Depending on the return loss of the antenna or device at the end of the cable, you may see a high relative mismatch displayed at the actual length of the cable. For example, a 50 foot cable was tested to generate the plot in [Figure 5-18 on page 110](#).

4. Position the cursor at **Cable length units**. Pressing the knob toggles the selection between feet and meters.
5. Position the cursor at **Cable class** and select it. A **Choices** menu appears allowing selection of Heliax, RG, and custom options. Select the appropriate cable class. (They can also be selected by pressing **k1 (HELIAX)**, **k3 (RG)**, or **k5 (Custom)**).
6. The next menu varies depending on Cable class:
 - If **Heliax** is selected: Position the cursor at **Cable type** and select. A **Choices** menu appears with foam, air, and flex of varying thickness. Use the knob to select the desired cable type.
 - If **RG** is selected: Position the cursor at **Cable type** with the example [RG 58/U = 58] and select.
 - If **Custom** is selected:
 - a. Position the cursor at **Cable velocity propagation const** and select it. Enter the appropriate value. Cables that use polyethylene dielectric typically have a propagation velocity of 0.66, cables that use a teflon dielectric typically have a propagation velocity of 0.70. The propagation velocity must be a value between 0 and 1.
 - b. Position the cursor at **Cable atten. dB/100 ft. (or meters) at 500 MHz** and select it.
 - c. If the cable attenuation is unknown, enter 0 dB per 100 feet (or meters). Entering 0 dB/100 will produce return loss values lower than actual, but fault distance can be accurately detected.
7. Press **k1 (Begin Tst)**.

Figure 5-17 Cable Fault Setups

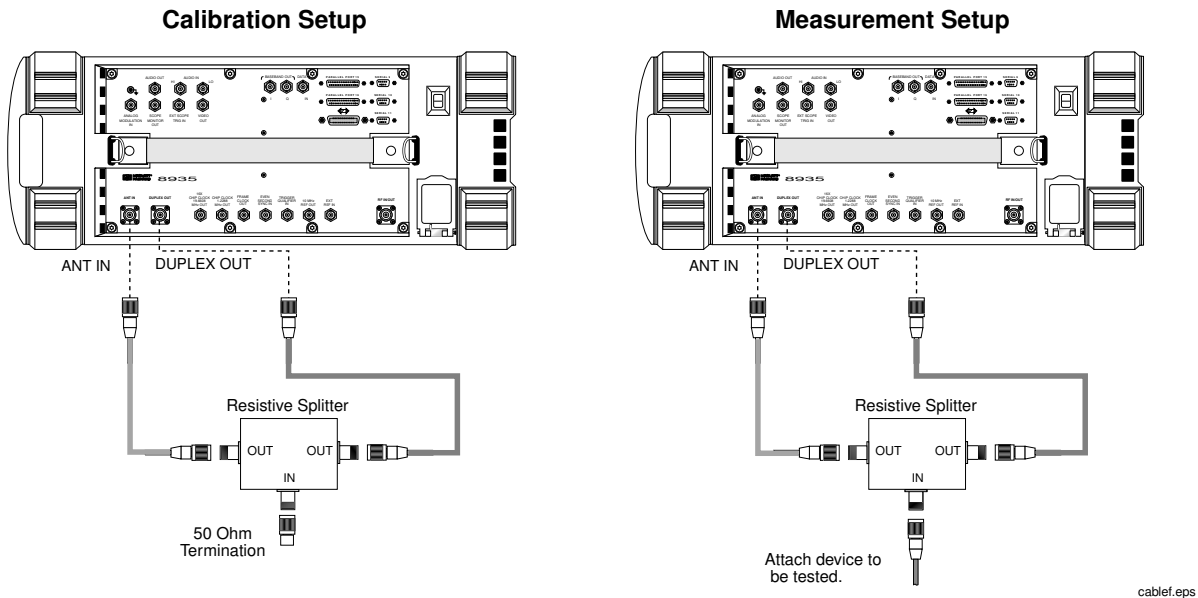

8. A setup screen appears with a diagram of the necessary connections (see Figure 5-17). It is very important that the power divider is a 2-way resistive device. Press **k1 (Proceed)** or the knob after the hardware is connected.
9. After the Test Set has finished calibrating, a second diagram appears on the screen. Connect the cable to be tested. Press **k1 (Proceed)** or the knob to continue.
10. The plot screen appears similar to Figure 5-18. To save the plot to a PC card, press **k4 (Save Plot)** and use the knob to enter a filename. Press **k5 (Scr Dump)** to send the image to a printer or to the BTS Laptop Utility. Directions will appear at the top of the screen. Press **Print** and allow the image to print to the connected device. Then, press **Pause/Continue**. Press **k1 (Proceed)** when you are ready to continue.

Figure 5-18 Example of a Cable Fault Plot Screen

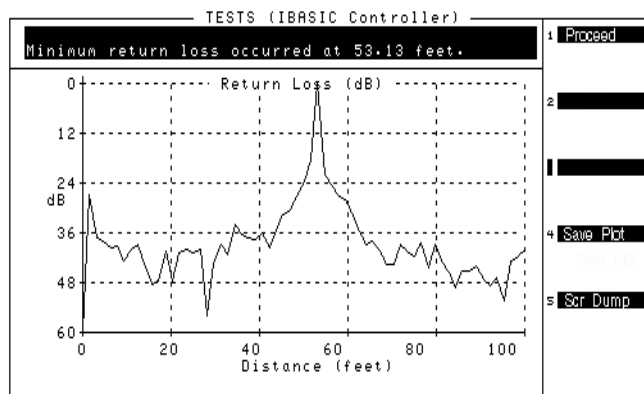

11. The cable fault result screen appears with the test results (see [Figure 5-19 on page 110](#) for an example). If the BTS Laptop Utility is in use, this data is collected by the laptop. If you wish to repeat the test using the same calibrated devices and test parameters, press **k1 (Repeat)**. To re-display the plot screen, press **k3 (Disp Plot)**. To return to the **Select Test (Main)** menu, press **k5 (Return)**.

Figure 5-19 Example of a Cable Fault Results Screen

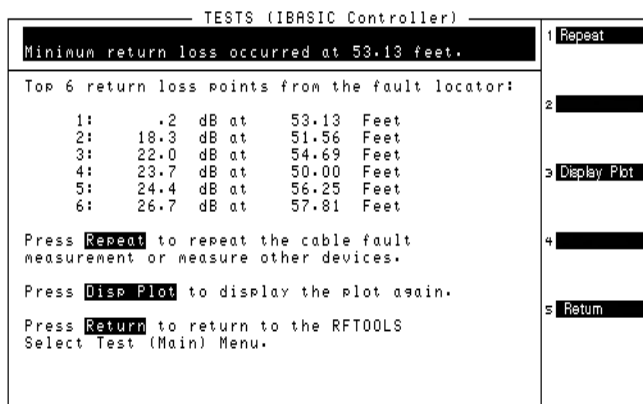

Typical cable fault return loss measurements

Return loss is a ratio of input power to reflected power. For example, if 100 Watts was applied to a cable and 10 Watts was returned, the return loss is 10 dB or

Equation 5-1 Return Loss

$$10\log\left(\frac{100}{10}\right)$$

Calculation

. In the same example, if 1 Watt was returned, the return loss is 20 dB

Equation 5-2

$$10\log\left(\frac{100}{1}\right)$$

Return Loss Calculation

. Typical return loss measurements for the cable loss test are listed below:

- Open-Circuit Cable = 0 dB (ignoring line loss)
- Short-Circuit Cable = 0 dB (ignoring line loss)
- 50-Ohm Terminated Cable = 40 to 60 dB
- Antenna = 10 to 20 dB (in the frequency band for which it was designed)

Return loss measurements greater than 20 dB should be considered good.

Cable Fault Performance

Measurements of the cable fault location can typically be made up to 500 feet on low-loss cables and 300 feet on higher-loss cables. Resolution of the fault location is approximately 0.4 feet for cable lengths up to 50 feet and then linearly increases to 4 feet for a 500 foot cable.

Specifications

- Cable Types Tested: Helix, RG, Custom
- Cable Length Range: 0 to 1000 feet, 0 to 300 meters
- Distance accuracy: +/-5% of the cable length value entered by the user

Replot Data Files

This utility allows you to easily retrieve and display plots which were previously stored on an SRAM PC card. One or two plots may be displayed at one time. No measurements are performed.

Figure 5-20 Replot Data Files

Select Main Menu

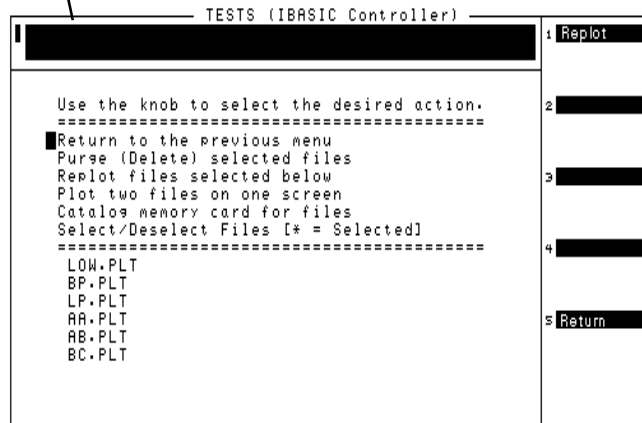
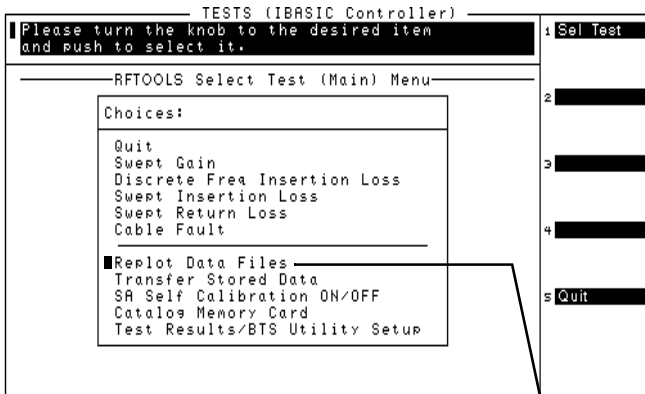

Transfer Stored Data

This utility may be used to easily transfer data collection files (test results) from an SRAM PC card over the serial, parallel, or HP-IB port. You do not need to write an IBASIC program. No measurements are performed.

Figure 5-21 Transfer Stored Data Screen

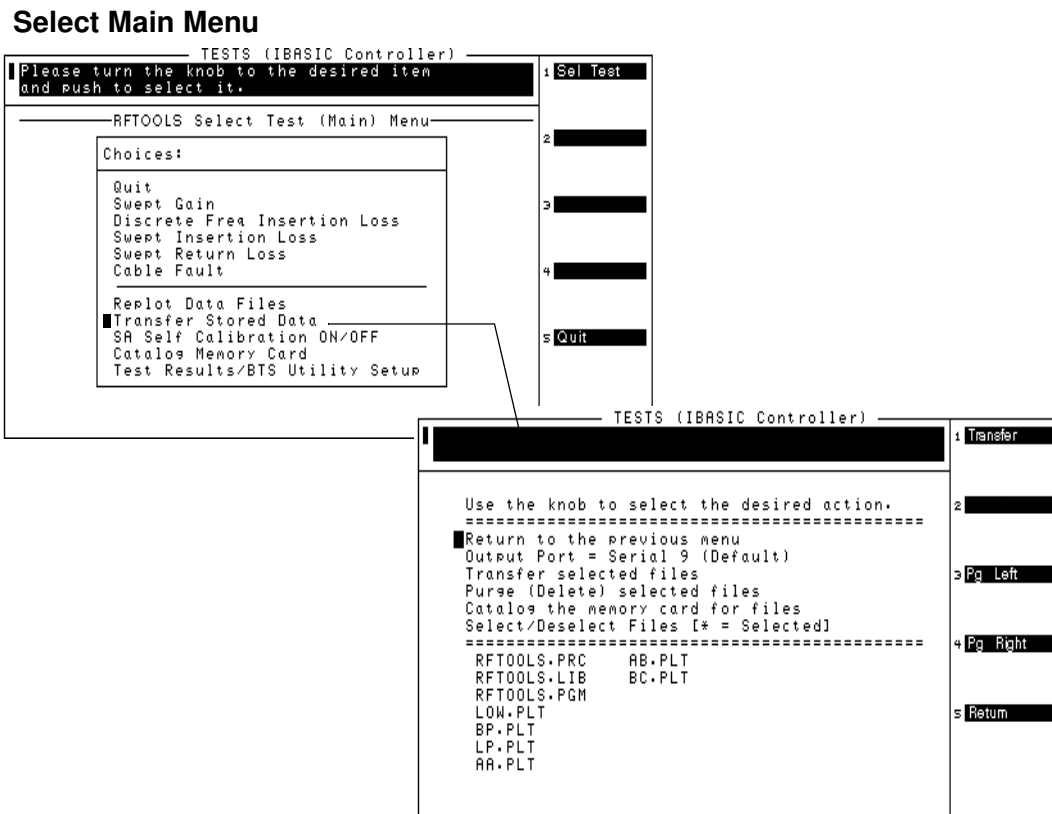

SA (Spectrum Analyzer) Self Calibration ON/OFF

This menu item allows you to check the calibration status of the Test Set's spectrum analyzer, and change the status if you desire.

Figure 5-22 SA Self Calibration OFF/ON Screen

Select Main Menu

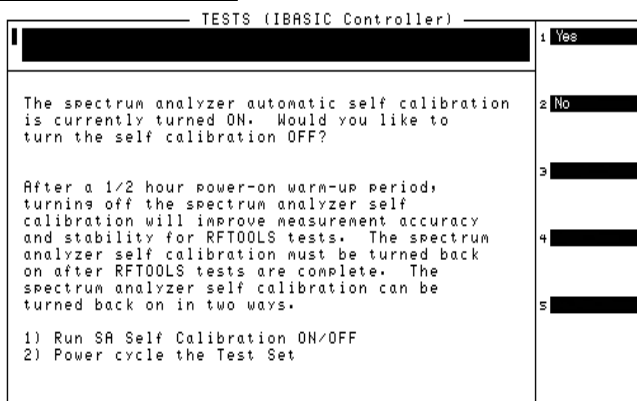
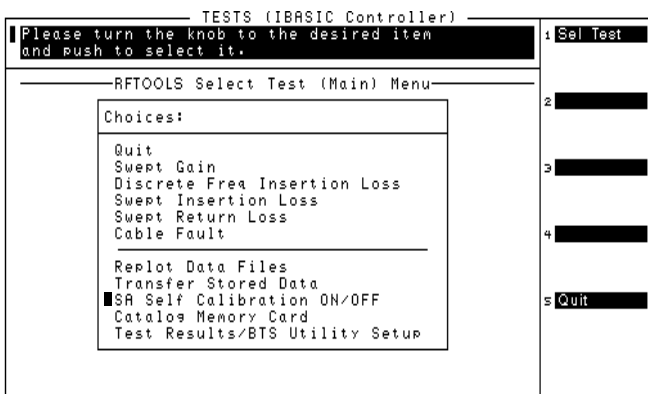

The RFTOOLS program uses the Test Set's internal spectrum analyzer for making swept network analyzer measurements. The internal spectrum analyzer performs an automatic self calibration every 5 minutes. This automatic self calibration ensures that the spectrum analyzer operates within specified limits regardless of the operating temperature. However, this self calibration can introduce inaccuracy in spectrum analyzer output after the Test Set is operating at a constant temperature (after approximately 30 minutes).

Each RFTOOLS test includes two parts: calibration and measurement. If the spectrum analyzer performs a self calibration between the calibration and measurement of the RFTOOLS test, the spectrum analyzer's automatic self calibration instability will increase RFTOOLS test measurement error. To avoid this problem, you may use this menu item to turn off the spectrum analyzer's self calibration. This self calibration should only be turned off after the unit has reached a constant powered-on operating temperature (approximately 30 minutes after power-on), therefore it is probably best to leave it on. After 30 minutes, turning the self calibration off will improve the measurement accuracy of RFTOOLS tests.

Catalog PC (Memory) Card

This utility lists all the files contained on the PC card. The PC card that you want to catalog must be inserted prior to selecting this test.

File types are denoted by the following suffixes:

- .PGM suffix denotes a program code file
- .LIB suffix denotes a library file
- .PRC suffix denotes a procedure file
- .DAT suffix denotes a data file
- .PLT suffix denotes a plot file

Figure 5-23 Catalog Memory Card Screen

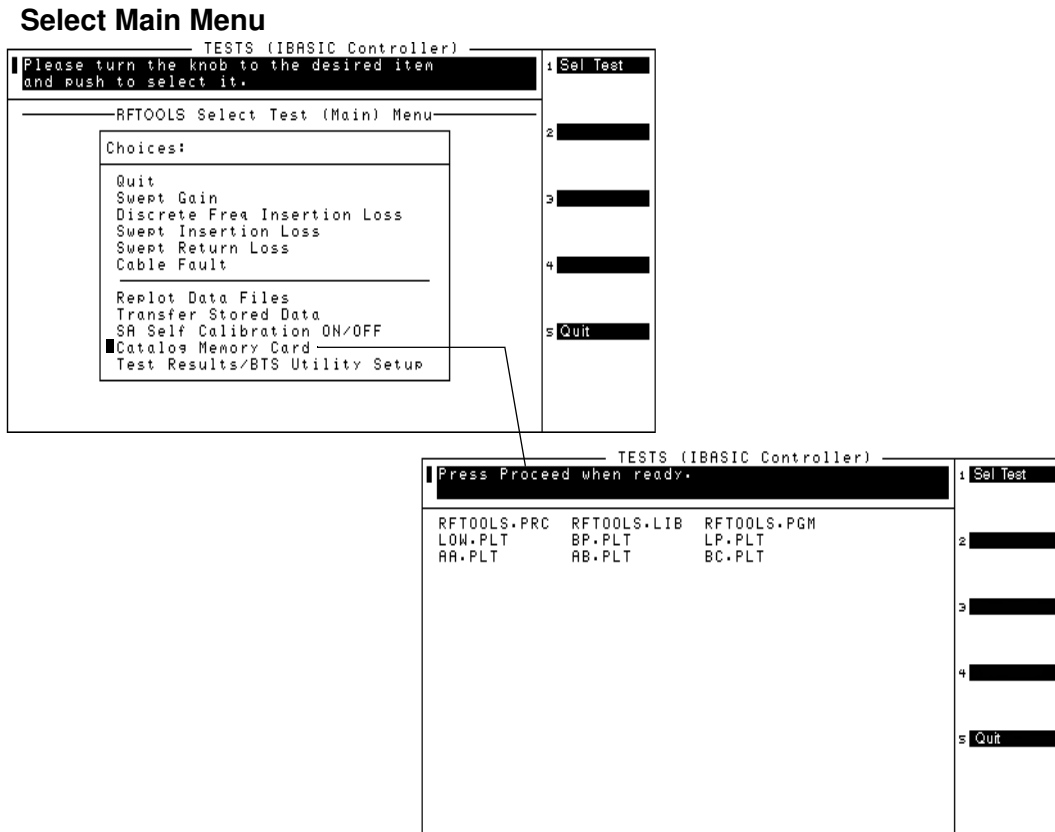

Using the Spectrum Analyzer

Automatic Calibration

During operation, the spectrum analyzer pauses for approximately 2 seconds every 5 minutes to recalibrate itself. This does not affect the accuracy of displayed measurements, but does cause a brief interruption of the displayed information during the process.

Setting Resolution Bandwidth and Sweep Rate

The resolution bandwidth and sweep rate are determined by the span setting, and cannot be set independently.

These settings are listed in the following table.

Table 5-1 Relationship Between Span, Resolution Bandwidth, and Sweep Rate

Span	Resolution BW (kHz)	Sweep Rate
<50 kHz	0.3	28.6 kHz/second
<200 kHz	1.0	329.0 kHz/second
<1.5 MHz	3.0	3.0 MHz/second
<3 MHz	30.0	21.4 MHz/second
<18 MHz	30.0	36.3 MHz/second
<200 MHz	300.0	257.0 MHz/second
1 GHz	300.0	1.0 GHz/second

Selecting the Spectrum Analyzer's Controls Menus

Several levels of menus are used to access the various controls associated with the spectrum analyzer (see [Figure 5-24](#)).

Figure 5-24 Spectrum Analyzer Controls Menus

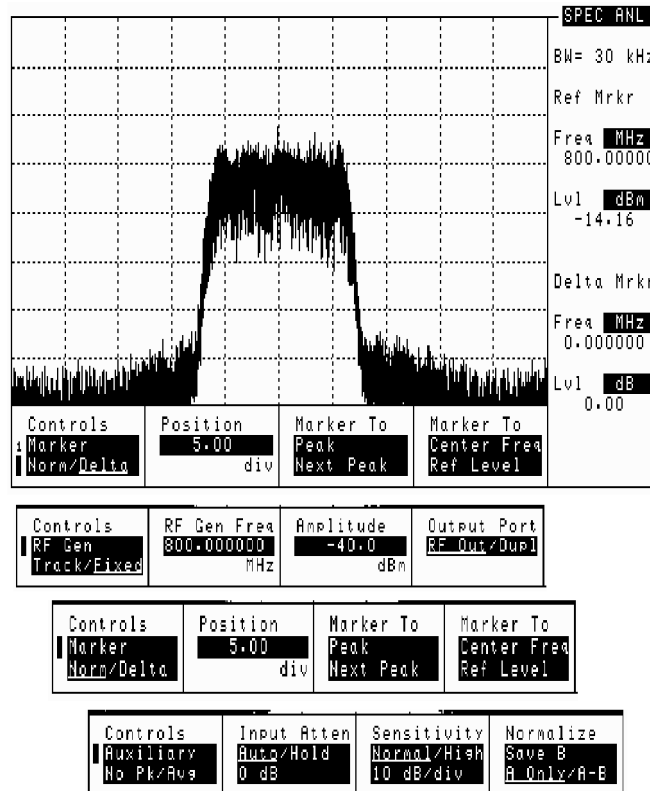

Using the Delta Markers

Delta markers are displayed when the **Norm/Delta** field on the spectrum analyzers **Marker** menu is set to **Delta**.

The delta markers are positioned in the same way as the normal markers using the **Marker** menu of the spectrum analyzer screen.

When the delta marker is activated, the **Marker To Peak**, **Next Peak**, **Center Freq**, and **Ref Level** fields control only the delta marker.

- **Peak** or **Next Peak** - The normal marker remains stationary. When a delta marker to center frequency measurement would move the reference marker off the screen, the measurement is aborted and the following message is displayed: **Attempt to move Reference Marker off the screen**.
- **Center Freq** or **Ref Level** - The normal marker moves as necessary to stay at the same signal frequency when the spectrum display changes.

Delta Frequency

The delta marker frequency measurement (**Delta Mrkr Freq**) is the frequency of the delta marker minus the frequency of the normal marker. If the delta marker is to the right of the normal marker, the delta frequency is positive. If the delta marker is to the left of the normal marker, the delta frequency is negative.

The units for this measurement are GHz, MHz, kHz, and Hz.

Delta Level

The delta marker level measurement (**Delta Mrkr Lvl**) is the level of the normal marker minus the level of the delta marker in dBm. If the delta marker is higher than normal marker, the delta level is positive. If the delta marker is lower than the normal marker, the delta level is negative.

The units for this measurement are dB. (There is a percent unit available; however, since the spectrum analyzer level is always displayed on a logarithmic scale, linear units are inappropriate.)

Reference Marker (Ref Mrkr) Level and Frequency

In the delta marker mode, a second (reference) marker is placed at the current location of the marker. The first marker becomes a moveable delta marker. When the delta marker is moved, the difference in frequency and level between the reference marker and the delta marker are shown as the **Delta Mrkr** measurements on the right-hand side of the screen. The reference marker can be set to either **Hold** or **Norm**.

When the **Ref Mrkr** field is set to **Hold**, the reference marker is frozen at its current position (frequency and level) regardless of changes in the signal level. This is useful for measuring multiple off-air carriers and looking at the difference in power levels. The reference marker can also be used when zeroing return loss.

When you switch from **Hold** to **Norm**, the reference marker will stay at its current horizontal setting (frequency), but will track the level of the incoming signal.

When switching from delta mode to normal mode, the delta marker becomes the normal marker.

Using the Spectrum Analyzer Mask

The spectrum analyzer mask consists of two adjustable limit lines. They show the upper and lower limits of spectral occupancy. You can choose to set and display either upper or lower limits for the mask, or both. When the mask is turned on, it continuously monitors the signal spectrum with respect to these limits and indicates a failure when the spectrum exceeds these limits. A “Fail” message, along with a beep (if activated), indicates a failure. “Pass” is displayed if the signal remains within the limits of the mask.

Displaying the Spectrum Analyzer Mask

1. On the SPEC ANL screen, set the **Controls** field to **MASK**. (See [“Selecting the Spectrum Analyzer’s Controls Menus” on page 117](#) for instructions.)
2. Set the **Display** field to show the mask on the screen, and to indicate which limits you want to measure against.
 - **Upper Only**
 - **Lower Only**
 - **Both**

Setting this field to **Off** turns off the mask and the pass/fail indicator.

3. Set the **Mask Type** field to the type of mask you want to measure against.
 - **Fix** sets the mask to absolute limits defined in the **#Pts**, **EditPoint**, **Lvl**, and **Freq** fields. When using fixed limits a change in the center frequency or level may cause the mask to move beyond the viewable area of the screen.
 - **Rel** sets the mask relative to the center frequency and reference level defined in the **Center Freq** and **Ref Lvl** fields on the spectrum analyzer’s **Main** controls menu.

You can define two masks, one fixed and one relative and switch between the two using this field.

Defining the Fixed Mask's Limits

1. Set the **Edit Mask** field to the limit you want to edit (**Upper** or **Lower**).

You might want to set the **Mask Beep** field to **Off** while you are defining the mask.

2. Set the **Mask Type** field to **Fix**.
3. Set the **#Pts** field to the number of points you want defined by the mask. You can define up to 15 points. The starting point is always the left graticule on the display, and the end point is always the right graticule on the display.

To define a straight-line mask, set the number of points to 1. The default mask is a straight line at the top of the display.

4. Set the **EditPt** field to the point you want to define.
5. Set the **Lvl** and **Freq** fields to the frequency and level you want for the point you chose in the **EditPoint** field.

In [Figure 5-25](#) the frequency and level settings for each point are as follows:

Table 5-2 Settings for Mask in [Figure 5-25](#)

Point	Level	Frequency
1	-50 dBm	1799.7000
2	1 dBm	1799.7000
3	1 dBm	1800.3000
4	-50 dBm	1800.3000 MHz

Figure 5-25 Setting the Spectrum Analyzer Mask

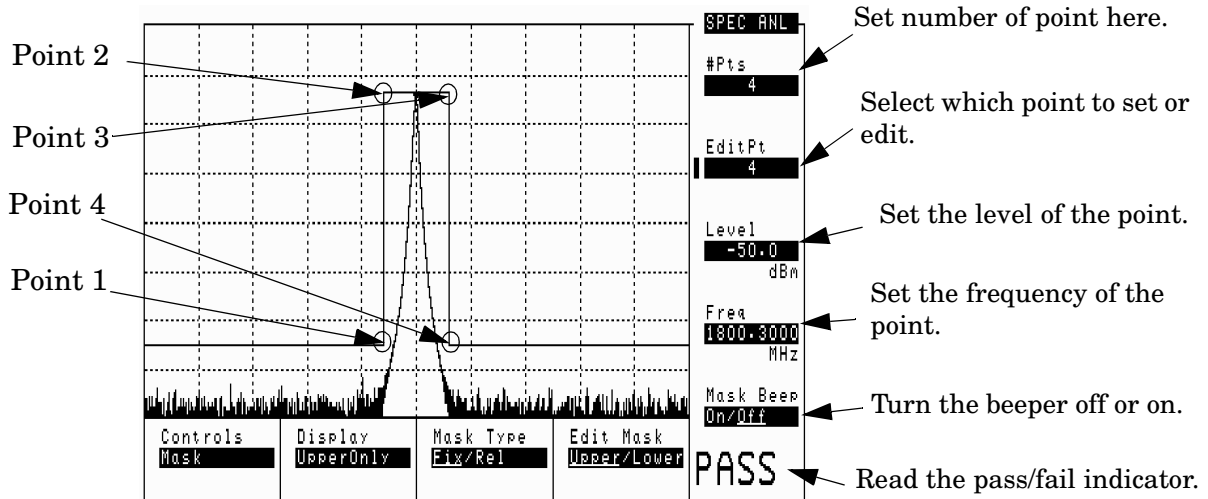

Defining the Relative Mask's Limits

1. Set the **Edit Mask** field to the limit you want to edit (**Upper** or **Lower**).
2. Set the **Mask Type** field to **Rel**.
3. Set the **#Pts** field to the number of points you want defined by the mask. The starting point is always the left graticule on the display, and the end point is always the right graticule on the display.

To define a straight-line mask, set the number of points to 1.

The default mask is a straight line at the top of the display.

4. Set the **EditPt** field to the point you want to define.
5. Set the **Level Ofs** and **Freq Ofs** fields to the frequency and level offsets you want for the point you chose in the **EditPt** field.

The offsets are relative to the frequency and level set in the **Center Freq** and **Ref Level** fields on the spectrum analyzer's **Main** controls menu.

Refer to [Figure 5-25](#). Instead of setting **Level** and **Freq**, set the **Level Ofs** and **Freq Ofs**.

Turning Off the Mask

1. Set the **Display** field to **Off** to turn off the spectrum analyzer mask.

Turning Off the Mask's Failure Beeper

1. Set the **Mask Beep** field to **Off** to turn off the beeping failure indicator.

Using the Voltmeter and Audio Frequency Counter

The voltmeter can be used to measure ac and dc voltages. The input to the voltmeter is determined by the **AF An1 In** field on the AF ANALYZER screen.

To measure external voltages:

1. Select the AF ANALYZER screen.
2. Set the AF An1 In field to Audio In.
3. Set the Audio In Lo field to match the source you are measuring (600 ohm impedance, floating output amplifier, ground referenced voltage).
4. Connect the signal to be measured to the AUDIO IN connector(s). The AUDIO IN HI connector can be used alone as long as the **Audio In Lo** field is set to **Gnd**. The AUDIO IN LO connector must also be used if the **Audio In Lo** field is set to **600 to Hi** or **Float**.

The ac level is displayed. See [Figure 5-27](#).

5. Select the lower-right measurement display field. See .

Figure 5-26

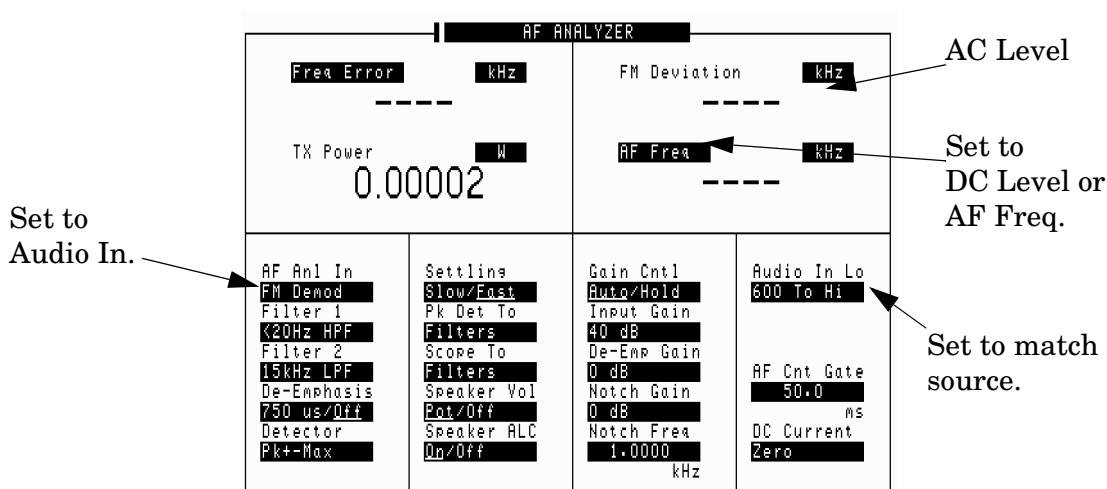

- Select DC Level to display the dc level.
- Select **AF Freq** to display the audio frequency.

Figure 5-27 Measuring AC and DC Voltages

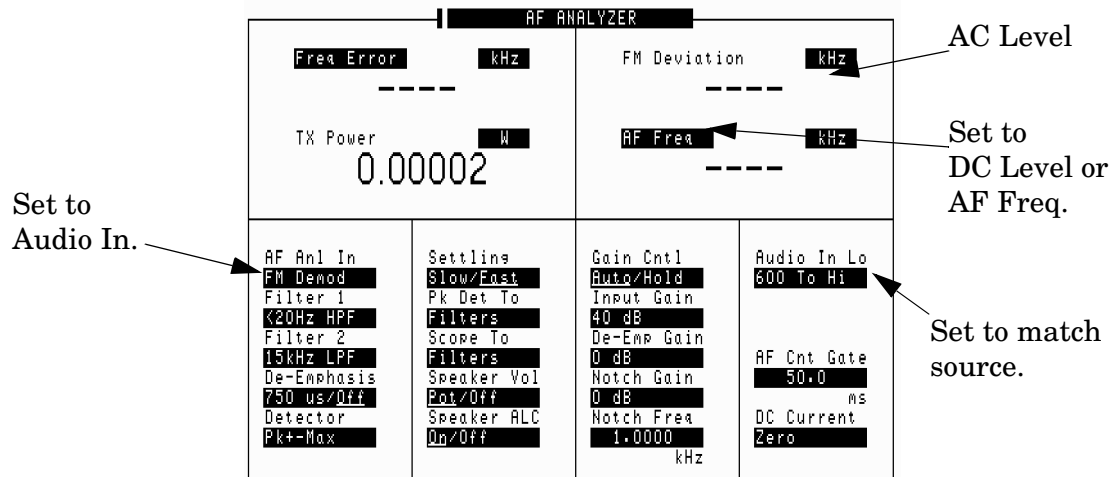

Using the Oscilloscope (Scope)

The built-in 50 kHz oscilloscope provides

- multiple triggering formats (internal and external)
- single-shot and pre-trigger viewing for single events
- full marker capability with automatic level and time readout

Time/division, volts/division and vertical offset are displayed and can be changed using the front-panel knob.

Input to the oscilloscope is provided from various sources including direct inputs to the AUDIO IN (HI and LO) and MODULATION INPUT connectors. Oscilloscope functions are accessed from the AF ANALYZER and SCOPE screens.

Figure 5-28 Inputs and Filters for the Oscilloscope

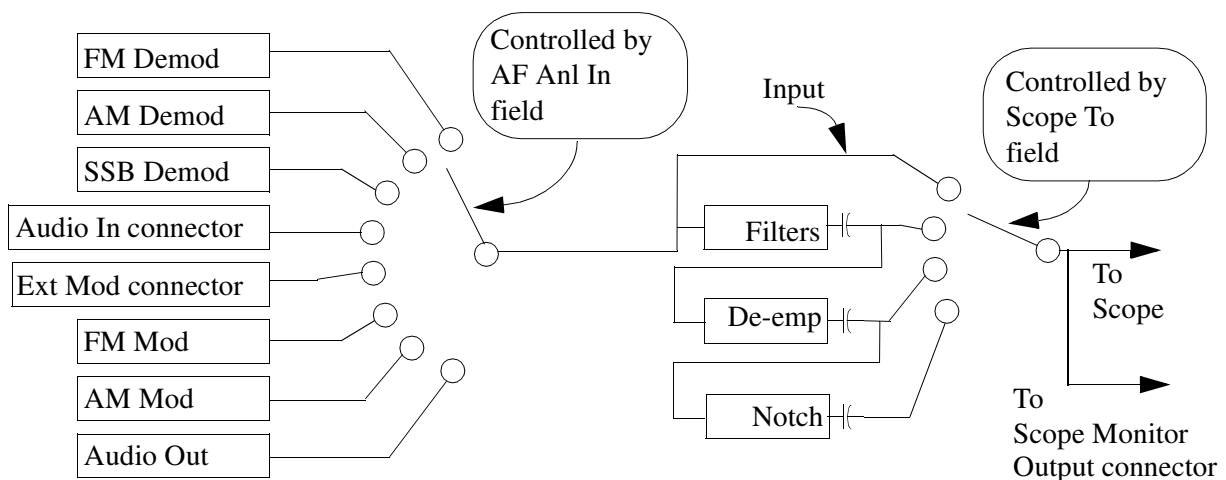

Selecting the Oscilloscope's Input

1. Press **Shift**, then **RF An1 (AF An1)** to select the AF ANALYZER screen.
2. Select the **AF An1 In** field. A list of choices appears.
3. Select the desired input to the scope:
 - **FM Demod** for FM demodulated audio from input signals connected to the RF IN/OUT or ANT IN connectors.
 - **AM Demod** for AM demodulated audio from input signals connected to the RF IN/OUT or ANT IN connectors.
 - **SSB Demod** for SSB demodulated audio from input signals connected to the RF IN/OUT or ANT IN connectors.
 - **Audio In** for a signal connected to the AUDIO IN connector.
 - **Ext Mod** for a signal connected to the MODULATION INPUT connector.
 - **FM Mod** for the FM modulated audio from the RF generator section.
 - **AM Mod** for the AM modulated audio from the RF generator section.
 - **Audio Out** for the signal present at the AUDIO MONITOR OUTPUT connector.

The input to the oscilloscope is displayed on the SCOPE screen.

Selecting the Oscilloscope's Filters

1. Press **Shift**, then **RF An1 (AF An1)** to select the AF ANALYZER screen.
2. Select the **Scope To** field. A list of choices should appear.
3. Select the desired filtering for the signal:
 - **Input** if you want no filtering (dc coupled)
 - **Filters** to route the audio to the oscilloscope after passing through Filters 1 and 2 (ac coupled).
 - **De-emp** to route the audio to the oscilloscope after passing through Filters 1 and 2, and the de-emphasis circuitry (ac coupled).
 - **Notch** to route the audio to the oscilloscope after passing through Filters #1 and #2, the de-emphasis circuitry, and notch circuitry (ac coupled).

Triggering the Oscilloscope

You can control following triggering features of the oscilloscope:

- Trigger external or internal
- Automated or normal triggering
- Continuous or single shot triggering
- Trigger level
- Trigger delay

The oscilloscope is triggered using the Trigger menu. Select this menu with the following procedure:

1. Press **Shift**, then **Spec Anl (Scope)** to go to the SCOPE screen.
2. Select the **Controls** field, then choose **Trigger** from the list of choices.

Using the Oscilloscope's Marker

The marker is used to help you make measurements with the oscilloscope. By repositioning the marker, you can measure the level and time.

The marker is controlled using the marker menu. Select this menu with the following procedure:

1. Press **Shift**, then **Spec Anl (Scope)** to go to the SCOPE screen.
2. Select the **Controls** field, the choose **Marker** from the list of choices.

Using IB_UTIL Programs

See “[Securing a Test Procedure](#)” on page 129 for information about the SECURE_IT program. See “[Clearing RAM](#)” on page 130 for information about the RAM_MANAGER program.

COPY_PL

The COPY_PL program allows you to copy procedures and libraries from one PC card to another. See the *Agilent Technologies 8935 Programmer's Guide* for more information about procedures and libraries.

FILE_XFER

The FILE_XFER (file transfer) program transfers files on a PC card to a device attached to either the HP-IB or to SERIAL PORT 9.

RAM_USAGE

The RAM_USAGE program lists the following information about the Test Set's RAM:

- Total RAM installed
- RAM disk allocations
- Save register allocations
- Approximate RAM available for IBASIC programs

Securing a Test Procedure

The password option for securing a test procedure is accessed by loading and running the **SECURE_IT** ROM program. This program is accessed by running the **IB_UTIL** program.

1. Select the **SOFTWARE MENU** screen.
2. Select the **Select Procedure Location:** field and choose **ROM**.
3. Select the **Select Procedure Filename:** field.
 - a. Select **IB_UTIL** from the list of programs. Press **Run Test** to display a list of procedures; select **SECURE_IT** and follow directions to secure the desired information.

Clearing RAM

RAM can be cleared using the **RAM_MANAGER** program in the Test Set's ROM. This program clears *all* RAM, including any SAVE/RECALL registers saved to **Internal** RAM.

This program is accessed by running the **IB_UTIL** program.

1. Select the SOFTWARE MENU screen.
2. Select the **Select Procedure Location:** field and choose **ROM**.
3. Select the **Select Procedure Filename:** field.
 - Select **IB_UTIL** from the list of programs. Press **Run Test** to display a list of procedures; select **RAM_MANAGER** and follow directions to clear RAM.

To preserve the SAVE/RECALL registers, do not use the **RAM_MANAGER** program. Instead, load any other test program from a card or from RAM to clear the previous test program, and then reload the desired test.

See [“Saving and Recalling Instrument Setups” on page 58](#) for more information about save/recall registers.

Using the LISTOPTS (list options) Program

You can list the options that are installed in your Test Set (if any) using the LISTOPTS program. LISTOPTS also displays the firmware version of your Test Set.

To run the LISTOPTS program

1. Select the SOFTWARE MENU screen.
2. Select the **Select Procedure Location:** field and choose **ROM**.
3. Select the **Select Procedure Filename:** field.
4. Select **LISTOPTS** from the list of programs.
5. Press **Run Test** to run the program and follow the directions on the screen.

Using the ST_PLT (store or plot) Program

This program allows you to store a spectrum analyzer, or oscilloscope trace on PC card or to plot a stored trace from a PC card.

To run the ST_PLT program

1. Select the SOFTWARE MENU screen.
2. Select the **Select Procedure Location:** field and choose **ROM**.
3. Select the **Select Procedure Filename:** field.
4. Select **ST_PLT** from the list of programs.
5. Press **k1 (Run Test)** to run the program and follow the directions on the screen.
6. Press **k2 (Show Info)** to display the trace's parameters (such as frequency, level, span, and so forth).

6 **Signaling Encoder and Decoder**

Signaling Encoder and Decoder Basics

The Decoder's Signal Source

The decoder *always* gets its signal immediately after the de-emphasis network of the AF analyzer. De-emphasis can be turned on or off on the AF ANALYZER screen, or can be controlled while using the decoder by assigning a global USER key to the De-Emphasis field.

Decoder Frequency Measurements

The decoder uses a different timebase for frequency counting than the AF Analyzer. Therefore, their measurements may be different when measuring the same signal (by a very small amount).

The Encoder

The encoder's uses AF Generator 2 to generate its signals. The available signaling formats are AMPS-TACS, NAMPS-NTACS, DTMF, and a function (waveform) generator.

AMPS-TACS, NAMPS-NTACS Encoder and Decoder

The following signaling formats are available for this decoder.

- AMPS = Advanced Mobile Phone Service.
- NAMPS = Narrowband Advanced Mobile Phone Service.
- TACS = Total Access Communications Systems.
- JTACS = Total Access Communications System for Japan.
- NTACS = Narrowband Total Access Communications Systems (NTACS is an extension of JTACS).

The theory and applications of cellular telephone systems are beyond the scope of this manual. If additional information is needed, refer to the many technical manuals available on the subject of cellular telephones.

Control and Voice Channel Identifiers

The AMPS/TACS and NAMPS/NTACS encoder modes use the same forward control channel (FOCC) settings and output format. However, the forward voice channel (FVC) information is different.

The control and voice channel fields are available in separate menus. The `Channel` field is used to select the `Cntl` (FOCC) or `Voice` (FVC) menu.

Fields available only in the forward control channel menu have (FOCC) printed in the field title.

Fields available only in the forward voice channel menu have (FVC) printed in the field title.

Encoder/Decoder Interaction

The AMPS-TACS/NAMPS-NTACS encoder acts like a base station transmitter, creating *forward* control and voice channel information (FOCC/FVC). The AMPS-NAMPS-TACS/NTACS decoder acts like a base station receiver, analyzing *reverse* control and voice channel signals (RECC/RVC).

The decoder uses the encoder's `Data Rate` setting to specify how fast the incoming message is being sent. Therefore, when using the decoder, you must first specify the data rate in the encoder.

AMPS-TACS, NAMPS-NTACS Decoder

The AMPS-TACS, NAMPS-NTACS decoder acts like a base station receiver by analyzing Reverse Control Channel (RECC) and Reverse Voice Channel (RVC) message streams for various cellular telephone formats.

The decoder can also be used to analyze Forward Control Channel (FOCC) and Forward Voice Channel (FVC) data from the base station.

Decoder Mode Differences

The AMPS-TACS and NAMPS-NTACS decoder modes are essentially the same for analyzing reverse control channel (RECC) information. However, the voice channel (RVC) information for NAMPS-NTACS is displayed differently than AMPS-TACS information. Fields and decoder measurements that are only used for either mode are noted in their descriptions.

Interpreting Decoded Data

RECC and AMPS-TACS RVC Measurements

See [“NAMPS-NTACS Reverse Voice Channel Measurements” on page 137](#) for information about NAMPS-NTACS RVC measurements.

After being armed, the measurement begins when the last bit of Word Sync has been received. The `Gate Time` field specifies the measurement period for all RECC measurements and the AMPS-TACS RVC measurement.

The received bits are displayed as hexadecimal (hex) characters. If the last bits received do not complete the last hex character, the received bits are used as the most significant bits in the character, and the remaining bit positions are filled with zeros.

For example; if the last bits received are “01”, two zeros are added to the right to produce the binary number 0100. The hexadecimal equivalent, 4, is displayed.

The first two hex characters of the RECC data displayed contain the 7-bit Digital Color Code of the Seizure Precursor. The characters are right-justified so the farthest bit to the left for the first hex character is always 0. The first word of the RECC message begins in the third hex character of the displayed data.

All bits of the RECC and RVC data streams received after the initial Word Sync are displayed, including Parity and additional Dotting and Word Sync sequences.

The decoder does not check for any errors in the received data stream.

Figure 6-1 Decoding the Reverse Control Channel (RECC) Data

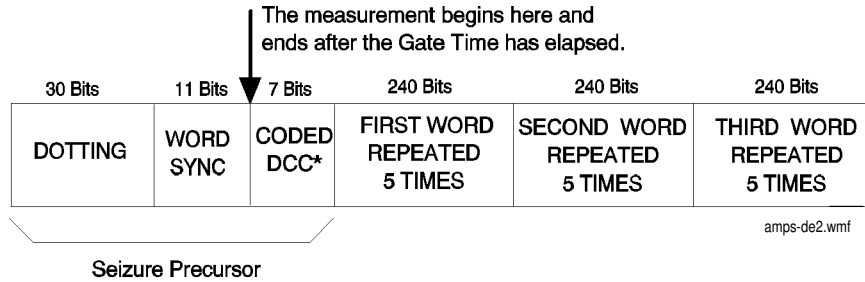

* Digital Color Code

Figure 6-2 Decoding the AMPS-TACS Reverse Voice Channel (RVC) Data

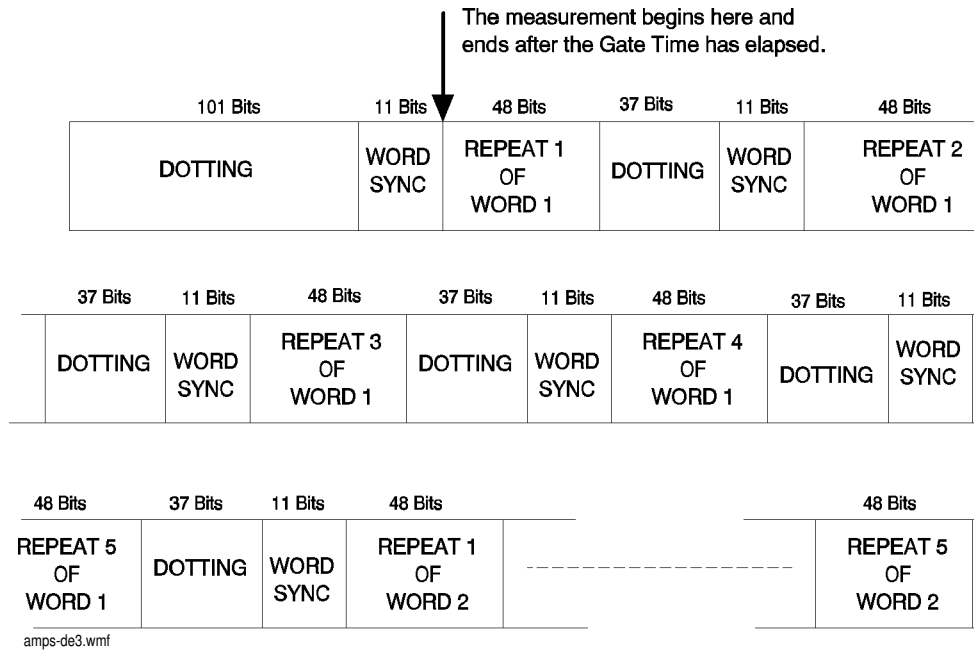

NAMPS-NTACS Reverse Voice Channel Measurements

Three types of RVC information can be decoded; selected using the Measure field. See [Figure 6-3](#).

Figure 6-3 Measure Field

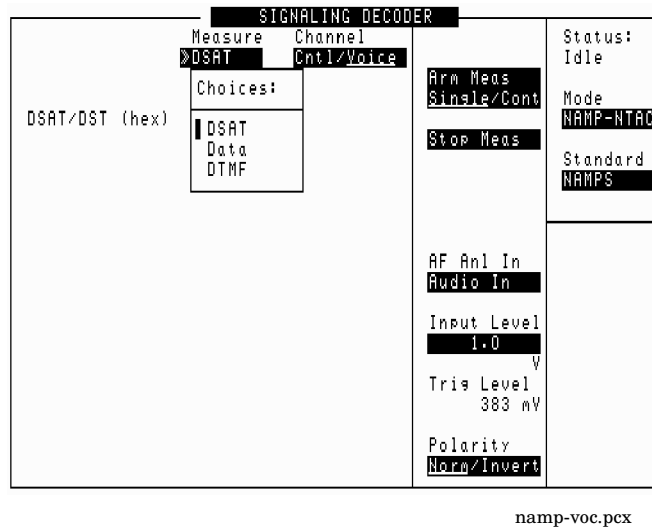

- DSAT displays the 6-digit DSAT (Digital Supervisory Audio Tone) or DST (Digital Signaling Tone) number, depending on the type of signal being received. If the received number is not one of the 14 standard combinations (7 DSAT or 7 DST), the decoder displays a constantly changing number until one of the standard values is detected. See [Figure 6-4 on page 139](#).

Data displays the 36 message bits and 12 parity bits of the RVC message. The measurement begins when the last sync word bit is received, and ends after the last parity bit is received. The measurement is re-triggered when the next sync word is received: there is no gate time function for this decoder mode. See [Figure 6-4 on page 139](#).

DTMF displays Dual-Tone Multi-Frequency tone pair frequencies and on/off times. These are tones that may be used to trigger connected equipment after a mobile-to-base station connection has been made (such as an answering machine or voice-mail system). See [Figure 6-4 on page 139](#).

Figure 6-4 Decoding NAMPS-NTACS Reverse Voice Channel (RVC) Data

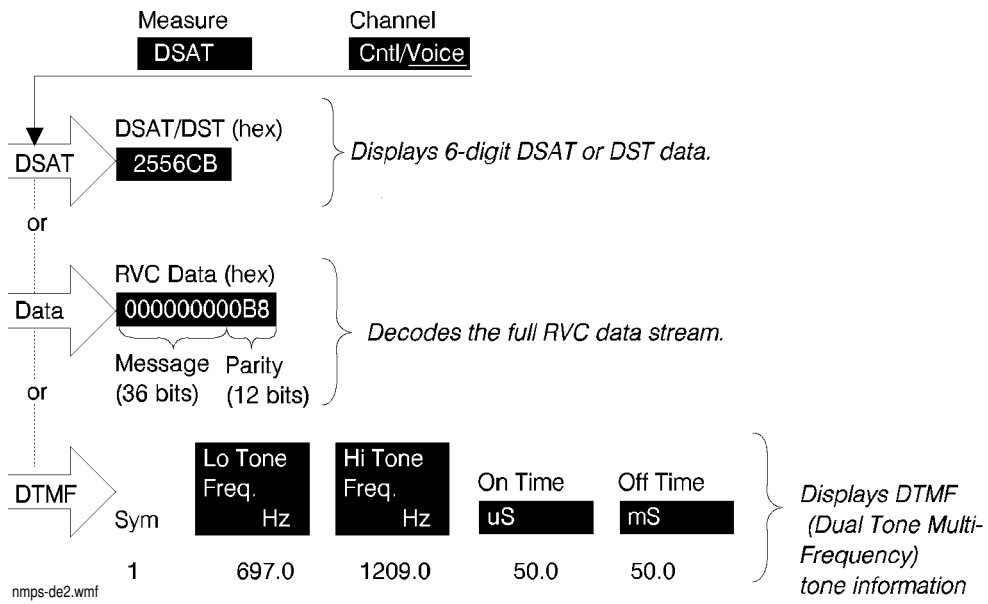

DTMF Sequence Encoder and Decoder

The DTMF sequence encoder creates dual-tone multi-frequency tone sequences of variable frequency, amplitude, and duration. Its signal can be used to modulate the RF generator, or it can be output through the AUDIO OUT connector.

The DTMF sequence decoder analyzes dual-tone multi-frequency tone sequences and displays the associated parameters.

Measurement Limits

Lo Tone: 680 - 960 Hz

Hi Tone: 1190 - 1660 Hz

Actual limits are typically slightly wider than this. However, the crossover point between Hi and Lo tone decoding is approximately 1.1 kHz. If incoming tones approach this point, unreliable measurements may be displayed (frequency measurement errors and spurious off times).

Function Generator Encoder and Decoder

The function generator provides single-tone audio frequency signals of various waveforms, amplitudes, and frequencies. Its signal can be used to modulate the RF generator, or it can be output through the AUDIO OUT connector.

Decoding Considerations

Frequency measurements are affected by the `Filter1`, `Filter2`, `Settling`, and `De-Emphasis` settings in the AF ANALYZER screen.

Four dashes (- - - -) are displayed if the incoming signal is out of range, or if the `Gate Time` is too long for the frequency being measured.

De-emphasis and Input Level

De-emphasis can greatly affect the input level required for proper decoding. When using de-emphasis, the `Input Level` setting may need to be reduced significantly to properly decode the incoming signal. De-Emphasis is enabled/disabled using the `De-Emphasis` field on the AF ANALYZER screen.

If de-emphasis is used (by setting the AF Analyzer's `De-Emphasis` field to 750 μ s), the `Input Level` should be set to about 1/5 of the measured signal's level. For example, a 1 kHz, 1 V peak sinewave into the AF Analyzer's input requires an `Input Level` of approximately 0.212 V to trigger correctly.

Twist and Pre-emphasis

Twist

Twist is the ratio of amplitudes (in dB) between the high frequency and low frequency tone in each DTMF pair. A positive value indicates a higher amplitude for the high frequency tones. A negative value indicates a higher amplitude for the low frequency tones.

The amplitude of the combined tones is set in the `AFGen2 To` field.

Twist and Pre-emphasis Interaction

Twist and Pre-emphasis affect the relative levels of the high and low tones within each symbol (tone pair). If pre-emphasis is off, twist sets the difference in deviation (in dB) between the high and low tones. If twist is off, pre-emphasis places a 6 dB per octave difference in deviation between the high and low tones. If both twist and pre-emphasis are on, the two effects are summed.

For most conditions, set `Twist` to 2.5 dB, `Pre-Emp` on, and 60% rated deviation (3 kHz for a typical 5 kHz deviation rated receiver).

Examples of Twist and Pre-emphasis Interaction

Example 6-1 Example 1:

3 kHz deviation, Twist 0 dB, Pre-emphasis off.

The level of each low tone and high tone individually generate 1.5 kHz deviation. The tones are summed to produce 3 kHz deviation.

Example 6-2 Example 2:

3 kHz deviation, Twist 2.5 dB, Pre-emphasis off.

The high tone has 2.5 dB (a factor of 1.334) more deviation than the low tone. The two tones are summed to produce 3 kHz peak deviation. Therefore, the low tone's deviation is 1286 Hz and the high tone's deviation is 1714 Hz.

Example 6-3

Example 3:

3 kHz deviation, Twist 0 dB, Pre-emphasis on.

There is a 6 dB per octave difference between the high and low tones. For example, if sending a 1, which has a low tone of 697 Hz and a high tone of 1209 Hz, the high tone has a deviation of $1209/697 = 1.735$ times the low tone's deviation. The high tone's deviation is then $20 \times \log(1209/697) = 4.78$ dB higher than the low tone. Since their sum must equal 3 kHz, the low tone's deviation is 1097 Hz, and the high tone's deviation is 1903 Hz.

Example 6-4

Example 4:

3 kHz deviation, Twist 2.5 dB, Pre-emphasis on.

If sending a 1 (697 Hz low tone and 1209 Hz high tone), the high tone's deviation is 1.334 (see example 2) \times 1.735 (see example 3) approximately 2.314 times the low tone's deviation. Since the peak deviation of their sum is 3 kHz, the low tone's deviation is 905.5 Hz and the high tone's deviation is 2094.5 Hz.

7 **Connectors**

Descriptions of Connectors

10 MHz REF OUT

This connector furnishes a 10 MHz reference for external instruments.

Operating Considerations

Waveform = sinewave

Output frequency = 10 MHz

Output level >0.5 V rms

Output impedance approximately 50 Ω

NOTE

The reference output frequency is always 10 MHz, independent of the selected input reference frequency.

ANT IN

The antenna input is used for analyzing low-power RF signals (≤ 60 mW), and is typically used for off-the-air measurements. This port can be selected in the RF ANALYZER, SPEC ANL, CDMA ANALYZER, or CODE DOM screens.

CAUTION

Connecting a signal of >60 mW (17.78 dBm) to the ANT IN port can cause instrument damage (although internal protection circuits can typically withstand a short-duration signal of several Watts).

If the overpower circuit is triggered (signified by a warning message at the top of the screen), remove the signal from the ANT IN port, and reset using **Meas Reset** (press and release the **Shift** key, then the **Hold** key) or turn the Test Set off and on to reset it.

Operating Considerations

Input impedance = 50 Ω

TX power cannot be measured using this port; use the RF IN/OUT port. However, low power levels can be measured using this port with the spectrum analyzer.

Additional sensitivity for this port is available using the *Sensitivity* field in the RF ANALYZER and SPEC ANL screens.

AUDIO IN

Two connectors are used to input audio signals to the AF analyzer:

- HI is the main audio signal input connection.
- LO is used for the audio signal reference. Three choices are available using the AF ANALYZER screen's `Audio In Lo` field:
 - `Gnd` connects the center pin through approximately 100 Ω to chassis ground.
 - `Float` is a floating input.
 - `600 To Hi` provides a 600 Ω internal load to match an audio source with an output impedance of 600 Ω .

The measured level is the potential between the HI and LO center pins. The shells of both connectors are at chassis ground.

Operating Considerations

Input impedance is switchable between 1 M Ω in parallel with 95 pF, or 600 Ω floating.

This port is selected as the AF analyzer's input using the `AF Anl In` field on the AF ANALYZER screen.

CAUTION

The maximum level between the HI and LO center pins is 42 V peak (approximately 30 V_{rms}). Exceeding this value can cause permanent instrument damage.

AUDIO MONITOR OUT

This connector provides an external output from the AF analyzer.

Operating Considerations

The `Scope To` field in the AF ANALYZER screen determines the source of this signal.

The `Scope To` field selects the signal source for the oscilloscope. This allows you to bypass certain sections of the AF analyzer's circuitry when viewing and measuring a signal. It also allows you to select measurement paths that include additional gain stages, improving the oscilloscope's resolution when measuring low-level signals.

- `Input` looks at the unfiltered signal directly from the input.
- `Filters` looks at the signal after filtering through Filter 1 and Filter 2.
- `De-Emp` looks at the signal after filtering through Filter 1 and Filter 2, and after 750 μ s de-emphasis (if the `De-emphasis` field is set to 750 μ s.)
- `Notch` looks at the signal after filtering through Filter 1 and Filter 2, after de-emphasis (if used), and after the notch filter.

The level is not affected by the front-panel VOLUME knob.

Output impedance <1 k Ω

AUDIO OUT

This port is used to output signals from audio frequency generators 1 and 2.

Operating Considerations

The output level is set by the AF generators and is not affected by the front-panel VOLUME control.

Output impedance $<1\Omega$

Maximum output current = 20 mA peak

Maximum reverse voltage = 12 V peak

AC/DC coupling is selected using the `Audio Out` field. This field is available on the `RF GENERATOR` screen.

Chassis Ground

The chassis ground terminal provides a general chassis connection.

DIGITAL MUX OUT

This connector is used for service diagnostics. Refer to the Assembly Level Repair manual for more information about using this connector.

DUPLEX OUT

This connector is an output for the RF generator and tracking generator.

Operating Considerations

Output impedance = 50Ω

The RF generator's output is selected in the `Output Port` field. This field is available on the `RF GENERATOR` and `SPEC ANL` (tracking generator) screens.

CAUTION

Connecting a signal of >60 mW (17.78 dBm) to the DUPLEX OUT port can cause instrument damage (although internal protection circuits can typically withstand a short-duration signal of several Watts).

If the overpower circuit is triggered (signified by a warning message at the top of the screen), remove the signal from the DUPLEX OUT port, and reset using **Meas Reset** (press and release the **Shift** key, then the **Hold** key) or turn the Test Set off and on to reset it.

EXT SCOPE TRIG IN

This connector provides an external oscilloscope's trigger input.

Operating Considerations

Input threshold approximately 2.5 V

Maximum Input level approximately 20 V peak

Input impedance is:

- 100 k Ω for signals ≤ 5.6 V peak
- 5 k Ω for signals > 5.6 V peak

When measured with no load on the input, a 5 Volt level is present on the connector due to the internal pull-up resistor design.

FRAME CLK OUT

This output provides an external connection to the 25 Hz TDMA frame clock.

GENERATOR DATA IN

This connector allows you to send external data to the pre-modulation filter/IQ modulator.

Modulation data consists of two-bit symbols (00, 01, 10, or 11) that are sent to a pre-modulation filter. The pre-modulation filter is just ahead of the IQ modulator to properly shape the modulating waveform.

External data is clocked in on the rising edge of the bit clock. The first bit of a symbol is clocked in on the rising edge of the symbol clock, and the second bit of the symbol is clocked in on the falling edge of the symbol clock. Care must be taken to properly align the baseband data being input with the symbol clock to correctly modulate the digital generator.

The nominal delay from the first data bit in a two-bit symbol to its peak RF response (decision point) after W/4 DQPSK modulation is 12 bits (6 symbols).

Operating Considerations

Input level range = TTL

Data rate = 48.6 kbps

Input impedance = 100 k Ω

HP-IB

This connector allows communication between the Test Set and other instruments or computers using the Hewlett-Packard Interface Bus (HP-IB).

PC Card Slot

This front-panel opening is where PC cards are inserted.

OPTIONAL CDPD MOD OUT

This connector is provided when the CDPD option is installed. When using CDPD, this connector is jumpered to the MODULATION INPUT connector.

MODULATION INPUT

This connector provides an external modulation connection to the RF generator.

Operating Considerations

The `Mod In To` field of the RF GENERATOR screen sets the type of modulation (AM or FM).

The `FM Coupling` field on the RF GENERATOR screen selects ac or dc coupling of this signal for FM operation.

PARALLEL 15

This port is used with printers requiring a parallel interface when printing screen images or test results. Set the `Printer Port :` field (on the `PRINTER CONFIGURE` screen or `TESTS (Printer Setup)` screen) to `Parallel` to print to this port. Use address `PARALLEL_15` when sending data to this port from IBASIC programs.

Pin numbers are embossed on the connector. Pin assignments are as follows:

Figure 7-1

Parallel Port Pin Assignments

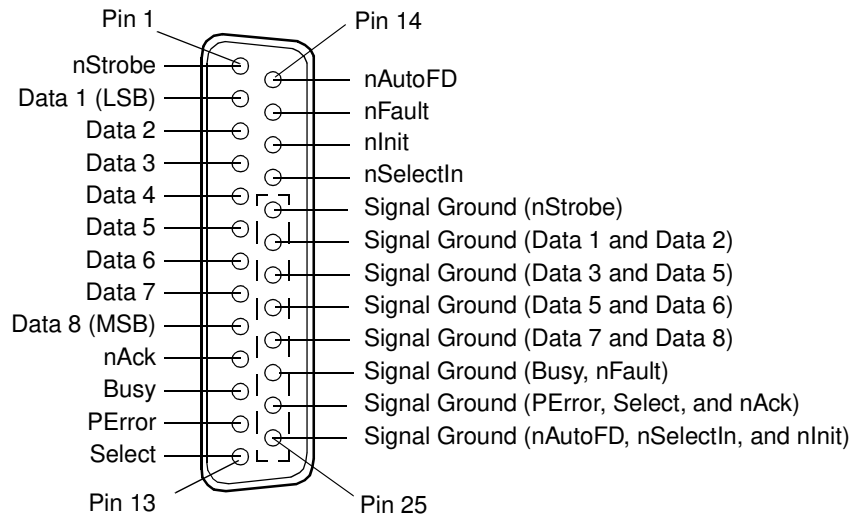

PARALLEL 16

PARALLEL PORT 16 is reserved for future enhancements.

RF IN/OUT

This Type-N connection is used to output signals from the RF generator and to input RF signals.

CAUTION

Overpower Damage — Refer to the Test Set's connector panel for maximum input power level. Exceeding this level can cause permanent instrument damage.

If the RF power at the RF IN/OUT port exceeds allowable limits, a loud warning signal sounds and a message appears at the top of the screen. If this occurs, disconnect the RF power, reset using **Meas Reset** (press and release the **Shift** key, then the **Hold** key), and allow the Test Set to cool off for approximately 2 minutes before making any other measurements on this port.

Operating Considerations

This port must be used when measuring TX (RF) power.

Signals ≤ 60 mW can be input to the ANT IN connector for all RF measurements except TX Power.

This port can be selected on the RF ANALYZER, RF GENERATOR, or SPEC ANL screens.

SERIAL 9, 10, and 11

The serial ports are used to input and output serial data for entering programs, printing test results and screen images, and sending test results to a connected controller or terminal.

Operating Considerations

The serial communications settings are defined on the I/O CONFIGURE screen.

SERIAL PORT 9 must be used for serial printing.

The IBASIC controller sends and receives data to the serial ports using address 9 for the primary port, and 10, 11 for the other ports. For example, to enter data from the primary serial port into a program variable named SDATA, you could use the following command:

```
ENTER SERIAL_9;SDATA
```

To send data from your program out of the primary serial port, you could use the following command:

```
OUTPUT SERIAL_9;SDATA
```

SERIAL 10 can only be configured through HP-IB.

SERIAL 11 is reserved for future use with special software that enables remote operation through a PC.

Figure 7-2

Serial Port Pin Assignments

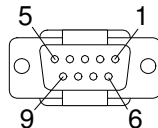

Table 7-1

Serial Port Pin Assignments

Pin	Description
1	CD - Carrier Detect
2	RD - Receive Data
3	TD - Transmit Data
4	DTR - Data Terminal Ready
5	Ground
6	DSR - Data Set Ready
7	RTS - Request to Send
8	CTS - Clear to Send
9	RI - Ring Indicator

SYNTH REF IN

This connector allows you to input an external reference for the Test Set's TDMA generator. It is used to synchronize the generator to an external reference source.

Operating Considerations

Input level = >0.15 V rms

Input impedance = approximately 50 ohms

Input frequency = 1, 2, 3, 4.8, 5, 10, or 15 MHz external; internal OCXO; TDMA reference; or internal Rubidium timebase.

TDMA ANALYZER INPUTS

TRIGGER

This connector is reserved for possible future enhancements.

DATA

This connector is reserved for possible future enhancements.

CLOCK

This connector is reserved for possible future enhancements.

TDMA OUTPUTS

This connector is used to supply signals to and from the TDMA analyzer and generator, and to supply the 8 kHz and 2.048 kHz clocks. These signals are provided for future testing capabilities.

Figure 7-3 TDMA OUTPUTS Port Pin Assignments

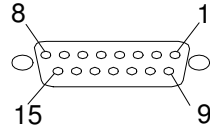

Table 7-2 Signal Pinout for the TDMA OUTPUTS Port

Pin Number	Signal
1	Bit Clock Out
2	Generator Baseband Data Out
3	Analyzer Trigger Out
4	Symbol Clock Out
5	8 kHz_2
6	8 kHz
7	2048 MHz_2
8	2048 MHz
9	GND
10	GND
11	GND
12	GND
13	GND
14	GND
15	GND

Operating Considerations

Input level = CMOS

TDMA REF IN

This connector supplies an external reference for the Test Set's TDMA analyzer. The signal is used to synchronize the analyzer to an external TDMA reference source.

Operating Considerations

Input level range = TTL

Input frequency = 20 Hz, 50 Hz, 24.3 kHz, 48.6 kHz, or 10 MHz external; 10 MHz internal.

VIDEO OUT

This connector provides a signal for using an external video monitor. The signal provides a duplicate of the Test Set's screen.

Operating Considerations

The video output drives a multisync monitor at 15.7 kHz (analog). Examples of this type of monitor include some multi-sync computer monitors on a PAL standard video monitor. When using a color PAL monitor, connect the signal to the green video input (with grounded shield) when possible.

8 **Error Messages**

General Information About Error Messages

Information concerning error messages displayed by the Test Set may be found in one of the following manuals:

- *Agilent Technologies 8935 Series, E6381A Base Station Test Set, Programmer's Guide*
- *Agilent Technologies 8935 Series, E6381A Base Station Test Set, Assembly Level Repair Manual*
- *Agilent Technologies Instrument BASIC User's Handbook:*
- *A Beginner's Guide to SCPI*

The format of the displayed message determines which manual contains information about the error message. There are four basic error message formats:

- Positive numbered error messages
- IBASIC error messages
- HP-IB error messages
- Text only error messages

The following paragraphs give a brief description of each message format and direct you to the manual to look in for information about error messages displayed in that format.

Positive Numbered Error Messages

Positive numbered error messages are generally associated with IBASIC. Refer to the *Agilent Technologies Instrument BASIC User's Handbook* for information on IBASIC error messages.

Example 8-1 **Positive numbered error messages take the form:**

ERROR XX

Example 8-2 **For example:**

Error 54 Duplicate file name

or

Error 80 in 632 Medium changed or not in drive

Negative Numbered Error Messages

Negative numbers preceding the error messages text correspond to the error conditions outlined in the Standard Commands for Programmable Instruments (SCPI). For more information on SCPI, order the following book,

A Beginner's Guide to SCPI Addison-Wesley Publishing Company ISBN 0-201-56350-9 Agilent Technologies part number 5010-7166

or contact,

Fred Bode, Executive Director SCPI Consortium
8380 Hercules Drive, Suite P3
La Mesa, CA 91942
Phone: (619) 697-8790, FAX: (619) 697-5955 CompuServe Number:
76516,254

Negative numbered error messages take the form: ERROR – XX <error message>

Example 8-3 For example

```
Error -128 Numeric data not allowed  
or  
Error -141 Invalid character data
```

IBASIC Error Messages

IBASIC Error Messages are associated with IBASIC operation. IBASIC error messages can have both positive and negative numbers. Refer to the *Agilent Technologies Instrument BASIC User's Handbook* for information on positive numbered error messages. Refer to the HP-IB Error Messages section of the *Programmer's Guide* for information on negative numbered error messages (the error message associated with a negative number is the same for HP-IB errors and IBASIC errors).

Example 8-4 IBASIC error messages take the form:

```
IBASIC Error: -XX  
For example:  
IBASIC Error: -286 Program runtime error
```

HP-IB Error Messages

HP-IB Error Messages are associated with HP-IB operation. Refer to the *Programmers Guide* for information on HP-IB error messages.

Example 8-5 **HP-IB error messages take the form:**

```
HP-IB Error: -XX  
  
or  
  
HP-IB Error  
For example:  
HP-IB Error: -410 Query INTERRUPTED.  
  
or  
  
HP-IB Error: Input value out of range.
```

Text Only Error Messages

Text only error messages are generally associated with manual operation of the Test Set. This manual contains information on text only error messages.

Text only error messages can also be displayed while running the Test Set's built-in diagnostic or calibration utility programs. Refer to the *Assembly Level Repair* manual for information on text only error messages displayed while running the Test Set's built-in diagnostic or calibration utility programs.

Example 8-6 **Text only error messages take the form:**

```
This is an error message.  
  
Input value out of range.
```

The Message Display

During instrument operation, various messages may appear on the Test Set's display. Prompt-type messages generally appear on the first line of the Test Set's display. General operating and error messages usually appear on the second line of the display. Some messages are persistent; they remain displayed until the error condition no longer exists, or until another persistent message with greater priority occurs. Other messages are only displayed when the error first occurs; they are removed when a key is pressed or the knob is turned, or when an HP-IB command is received. Many of the messages are displayed on the ERROR MESSAGE screen until the instrument is turned off.

Messages that are about error conditions may tell you what to do to correct the error (turn something off, reduce a field's value, press a certain key, and so forth). Messages and prompts are sometimes accompanied by a beep or warble.

NOTE

Warbles and Beeps

A warble sound indicates that an instrument-damaging event is occurring. Beeps often occur only with the first occurrence of the message. Prompts are generally silent.

Non-Recoverable Firmware Error

The non-recoverable firmware error is very important. It appears when an unanticipated event occurs that the Test Set's firmware cannot handle. The message appears in the center of the Test Set's display and (except for the two lines in the second paragraph) has the form:

```
Non-recoverable firmware error. Please record the 2 lines of
text below and contact Agilent Technologies through your
local service center or by calling (800) 827-3848 (USA,
collect) and asking to speak to the Service Engineer.
```

```
'Address error exception'
  at line number 0
```

To continue operation, turn POWER off and back on.

Follow the instructions in the message.

Unfortunately, you will not be able to recover from this condition. You must switch the Test Set off and back on. When you rerun the test where the Error Message occurred, it may not occur again. If it does reappear, it would be helpful to Agilent Technologies to record exactly what the configuration of the instrument was when the error appeared and contact Agilent Technologies.

Text Only Error Messages

Operation errors generally occur when you try to do something the Test Set was not designed to do. Most messages tell you what to do to correct the problem, (turn something off, reduce a field's value, press a certain key,...and so forth).

Some common messages are listed here:

- All self tests passed.
- The Test Set did not detect any hardware or firmware failures during its initial self-diagnostics.

This message should always be displayed immediately after instrument turn on.
- Input value out of range.

A number was entered that was too large or small for the selected field, for example, trying to set `AFG1 Freq` to 125 kHz.
- Invalid keystroke.

You used a key that has no function relating to the selected field, for example, pressing the **On/Off** key while the `Filter 1` field is selected.
- Option not installed.

You selected a function that requires optional hardware that is not present.
- Turn off either AM or FM settings.

You tried to create simultaneous AM and FM (using any combination of `AFGen1`, `AFGen2`, and the `Mod In To` field). The Test Set does not provide simultaneous AM and FM.
- Squelch interrupt overflow. Reset using **Meas Reset** (press and release the **Shift** key, then the **Hold** key).

The Test Set temporarily interrupts audio measurements when squelch is first broken to prevent internal switching transients from influencing measurements (except when using the `SCOPE`, `SPEC ANL`, `SERVICE` screens). If squelch is repetitively broken in a period of a few seconds, the duration of measurement interruption becomes too great, and the Test Set stops interrupting the signal. Following measurements may be influenced by transient signals.

Meas Reset clears the data buffer used to generate interrupts, resetting the normal squelch operation to eliminate transients.

This condition may occur when monitoring low-level off-the-air signals.

- Cal file checksum incorrect - initializing file.

This error usually occurs after changing the Test Set's firmware ROM. It is not a problem in that instance, but should not re-appear during subsequent operation of the Test Set.

- One or more self tests failed. Error code: XXXX

An instrument failure was detected when the Test Set was turned on. (For example, having a stuck front-panel key during turn on.) The numbered error message corresponds to a binary-weighted group of errors listed in the *TST Common Command description in the Programmer's Guide.

- Change Ref Level, Input Port or Attenuator (if using Hold).

The RF signal level is either too great or too small for the current input port, attenuator setting, or both. This error often occurs when trying to make a low-level measurement using the RF IN/OUT port with the spectrum analyzer. Make the indicated changes until this message is no longer displayed.

- Change RF Gen Amplitude, Output Port or Atten Hold (if on).

This message appears when the RF Generator's `Amplitude` field is set too high when using the RF IN/OUT port or when adjusting the amplitude with the `Atten Hold` field set to `On`.

- The RF IN/OUT port has a lower maximum output level than the DUPLEX OUT port. Use the DUPLEX OUT port, or reduce the RF generator's level.

If `Atten Hold` is `On`, you may be adjusting the amplitude outside of the allowed range. Change the amplitude

- Direct latch write occurred. Cycle power when done servicing.

— The SERVICE screen was accessed and one or more internal latch settings were changed. Turn the instrument off and back on to reset the latches. (This condition can occur during periodic calibration.)

- meaning of, TX power measurement, 46
- Symbols**
% delta key, 35
% key, 35
+/- key, 38
- Numerics**
10 MHz REF OUTPUT connector, 146
- A**
ac level
 measurements, 48
ACP status codes, 81
ACP. *See also* adjacent channel power
adjacent channel power
 See also ACP.
adjacent channel power measurements, 69
AF Anl Input
 field, 126
AF Anl key, 34
AF frequency measurements, 49
Agilent sales offices, 19
Agilent service centers, 19
AM Demod
 AF Anl In, 48
 oscilloscope input, 126
AM depth
 measurements, 48
AM depth measurements, 48
AM Mod
 oscilloscope input, 126
Amplitude
 twist, 143
AMPS-TACS signaling decoder, 135
AMPS-TACS signaling encoder, 135
analog meter, 50
analyzer
 calibration, 116
ANT IN connector
 avoiding damage, 47
 connecting to, 32
 description, 146
arrow down
 key, 52
arrow up
 key, 52
ASSIGN, 62
Assign key, 26
- audio frequency measurements, 48
Audio In
 AF Anl In, 48
 oscilloscope input, 126
AUDIO IN connector
 avoiding damage to, 147
 description, 147
 for ac level measurements, 48
AUDIO IN HI connector, 147
AUDIO IN LO connector
 600 ohm impedance, 147
 floating, 147
 grounded, 147
AUDIO MONITOR OUTPUT
 connector, 148
Audio Out
 oscilloscope input, 126
AUDIO OUT connector
 description, 149
automated test, 83
average power measurements, 69
averaging
 measurement results, 56
 restart averaging, 56
Avg key, 56
- B**
base settings
 changing, 60
 default, 60
basic operation, 43
battery, replacing, 63
BERT status codes, 80
bit error rate
 See also BERT.
BTS Laptop Utility, 91
- C**
cable fault measurements, 106
calibration
 spectrum analyzer, 116
catalog memory card, 115
CDMA Gen key, 34
channel numbers
 for analyzer/generator frequencies, 51
channel power measurements, 69
channel tuning, 51
chassis ground, 149
clear
 global user key assignment, 62
 RAM, 130
 register contents, 59, 130
Code Dom key, 34
connectors
 10 MHz REF OUTPUT, 146
- ANT IN, 146
AUDIO IN, 147
AUDIO MONITOR OUTPUT, 148
AUDIO OUT, 149
DIGITAL MUX OUT, 149
DUPLEX OUT, 149
EXT SCOPE TRIG IN, 150
FRAME CLK OUT, 150
GENERATOR DATA IN, 150
ground, 149
HP-IB, 151
MODULATION INPUT, 151
OPTIONAL CDPD MOD OUT, 151
PARALLEL 15, 152
PARALLEL 16, 152
RF IN/OUT, 153
SERIAL PORT 10, 154
SERIAL PORT 11, 154
SERIAL PORT 9, 154
SYNTH REF IN, 155
TDMA ANALYZER INPUTS
 CLOCK, 155
 DATA, 155
 TRIGGER, 155
TDMA OUTPUTS, 156
TDMA REF IN, 157
VIDEO OUT, 157
COPY_PL, IB_UTIL ROM
 program, 128
coupling, notch frequency, 49
cursor control knob
 increment setting of, 52
- D**
dashes
 meaning of, TX power measurements, 46
Data field, 138
data files, replotting, 112
data files, transferring, 112
data rate
 signaling encoder, 135
dB key, 35
dBm key, 35
dBuV key, 35
dc level measurements, 49
decimal numbers, 38
decoder. *See Also* Signaling Decoder screen
decrement
 changing setting, 52
De-emp
 oscilloscope filters, 126
de-emphasis
 input level, 142

- default settings
 - base, 60
 - changing, 59, 60
 - power-on, 59
- delete
 - global user key assignment, 62
 - RAM contents, 130
 - register contents, 59, 130
- delta markers, 117
- demodulation
 - AM, 48, 126
 - FM, 48, 126
 - SSB, 48, 126
- depth, AM, 48
- deviation
 - FM, 48
- digital analyzer status, 68
- digital generator status, 68
- DIGITAL MUX OUT connector, 149
- distortion
 - measurements, 49
- DSAT field
 - Signaling Decoder screen, NAMP-NTAC mode, 138
- DTMF field, 138
- DTMF pair, 138
- DTMF Sequence encoder mode
 - Twist, 143
- DTMF signaling decoder, 140
 - See Also* Signaling Decoder screen, DTMF mode
- DTMF signaling encoder, 140
 - See Also* Signaling Encoder screen, DTMF mode
- dual-tone multi-frequency. *See* DTMF
- DUPLEX OUT connector
 - description, 149
- E**
- EEX key, 38
- encoder/decoder
 - interactions, 135
 - See Also* Signaling Encoder screen, Signaling Decoder screen
- Error Message key, 34
- error messages, 160
 - operation, 164
- error vector magnitude
 - See also* EVM.
- EVM measurements, 69
- EVM status codes, 79
- exponents
 - entering numbers, 38
- Ext Mod
 - AF Anl In, 48
 - oscilloscope input, 126
- EXT SCOPE TRIG IN connector, 150
- F**
- fields
 - changing settings, 33
 - types of, 33
- FILE_XFER, IB_UTIL ROM program, 128
- files
 - securing, 129
- Filters
 - oscilloscope filters, 126
- FM
 - deviation, 48
- FM Demod
 - AF Anl In, 48
 - oscilloscope input, 126
- FM deviation measurements, 48, 49
- FM Mod
 - AF Anl In, 48
 - oscilloscope input, 126
- FOCC, 135
- format PC card, 64
- forward control channel. *See* FOCC
- forward voice channel. *See* FVC
- four dashes
 - meaning of, TX power measurement, 46
- FRAME CLK OUT connector, 150
- frequency
 - delta markers, 118
 - frequency offset, 57
 - frequency tuning, 51
- Function Generator signaling decoder, 141
 - See Also* Signaling Decoder screen, Func Gen mode
- Function Generator signaling encoder, 141
 - See Also* Signaling Encoder screen, Func Gen mode
- functional test
 - for verifying operation, 39
- FVC, 135
- G**
- gain measurement, swept, 93
- GENERATOR DATA IN connector, 150
- GHz key, 35
- grounding, 149
- H**
- Help key, 34
- hexadecimal format, 38
- HI indicator, 53
- Hi Limit key, 53
- high limit
 - removing, 54
 - setting, 53
- HP-IB connector, 151
- Hz key, 35
- I**
- I/O Config key, 34
- IB_UTIL
 - COPY_PL, 128
 - FILE_XFER, 128
 - RAM_MANAGER, 130
 - RAM_USAGE, 128
 - ROM program, 128
 - SECURE_IT, 129
- impedance
 - input, 147
- Incr (divide-by)10 key, 52
- Incr Set key, 52
- Incr x10 key, 52
- increment
 - changing setting, 52
- initialize PC card, 64
- Input
 - oscilloscope filters, 126
- input impedance
 - selecting, 147
- Input Level, 142
- input ports, attenuator level at, 77
- insertion loss measurements
 - discrete frequency, 96
 - swept, 99
- Inst Config key, 34
- interactions
 - encoder/decoder, 135
 - twist and pre-emphasis, 143
- J**
- JTACS signaling encoder/decoder, 135
- K**
- k1 through k5 keys, 61
- k1' through k3' keys, 61
- keys
 - %, 35
 - % delta, 35
 - +/-, 38
 - AF Anl, 34
 - Assign, 62

- Avg, 56
- CDMA Gen, 34
- Code Dom, 34
- dB, 35
- dBm, 35
- dBuV, 35
- down-arrow, 52
- EEX, 38
- Error Message, 34
- GHz, 35
- Help, 34
- Hi Limit, 53
- Hz, 35
- I/O Config, 34
- Incr (divide-by)10, 52
- Incr Set, 52
- Incr x10, 52
- Inst Config, 34
- k1 through k5, 61
- k1' through k3', 61
- kHz, 35
- Lo Limit, 53
- Meter, 50
- MHz, 35
- ms, 35
- mV, 35
- mW, 35
- On/Off, 50, 54, 55, 56, 59
- ppm, 35
- Printer Config, 34
- Recall, 58
- Ref Set, 55
- Release, 62
- RF Anl, 34
- RF Gen, 34
- s, 35
- Save, 58
- Scope, 34
- Spec Anl, 34
- up-arrow, 52
- uV, 35
- V, 35
- W, 35
- kHz key, 35
- knob
 - increment setting, 52
- L**
- level
 - ac, 48
 - AF analyzer, 142
 - attenuator, at input ports, 77
 - dc, 49
 - delta marker, 118
- limits
 - indicators, 53
 - pass/fail, 53
- removing, 54
- setting, 53
- LISTOPTS, 131
- LO indicator, 53
- Lo Limit key, 53
- low limit
 - removing, 54
 - setting, 53
- M**
- MAHO status codes, 82
- manuals, 13
- markers
 - delta, 117
 - oscilloscope, 127
 - reference, spectrum analyzer, 118
- mask, spectrum analyzer, 119
- measurement averaging, 56
- measurement limits
 - indicators, 53
 - removing, 54
 - setting, 53
- measurement reference, setting, 55
- measurement setups
 - saving and recalling, 58
- measurements
 - ac level, 48
 - AF frequency, 49
 - AM depth, 48
 - audio frequency, 48
 - cable fault, 106
 - dc level, 49
 - distortion, 49
 - FM demodulation, 48, 49
 - FM deviation, 48
 - insertion loss, discrete frequency, 96
 - insertion loss, swept, 99
 - return loss, swept, 102
 - RF, 46
 - SINAD, 49
 - SNR, 49
 - swept gain, 93
 - TDMA
 - adjacent channel power, 69
 - average power, 69
 - channel power, 69
 - displaying, 68
 - EVM, 69
 - transmitter power, 46
 - memory
 - considerations, 60
 - memory card catalog, 115
 - memory overflow error, 60
 - message
 - error, 160
 - operation, 164
 - types of, 160
 - meter
 - end points, 50
 - on/off, 50
 - scale interval, 50
 - Meter key, 50
 - MHz key, 35
 - uV (microvolts) key, 35
 - mobile assisted handoff
 - See also* MAHO.
 - MODULATION INPUT connector
 - description, 151
 - ms key, 35
 - mV key, 35
 - mW key, 35
 - N**
 - names
 - registers, 59
 - NAMPS-NTACS signaling
 - decoder, 135
 - NAMPS-NTACS signaling
 - encoder, 135
 - Notch
 - oscilloscope filters, 126
 - notch frequency, coupling, 49
 - numbers
 - decimal format, 38
 - hexadecimal format, 38
 - negative, 38
 - scientific notation, 38
 - O**
 - offset
 - setting, frequency, 57
 - off-the-air measurements, 146
 - On/Off key, 50, 54, 55, 56, 59
 - operating basics, 43
 - operation messages, 164
 - OPTIONAL CDPD MOD OUT
 - connector, 151
 - options, Test Set, 131
 - oscilloscope
 - description of, 125
 - features, 125
 - filters, block diagram of, 125
 - filters, selection of, 126
 - inputs, block diagram of, 125
 - inputs, selection of, 126
 - markers, 127
 - triggering, 127
 - overpower
 - damage, at ANT IN, 47
 - overpower damage, 32
 - overview of operation, 43

P

PARALLEL 15 connector, 152
PARALLEL 16 connector, 152
parallel port pin assignments, 152
pass/fail limits, 53
password, 129
PC card
 initialize, 64
PC card catalog, 115
% delta key, 35
% key, 35
phase locking references, 75
power
 transmitter, 46
power-on settings
 changing, 59
ppm key, 35
preset state
 changing, 60
 default, 60
Printer Config key, 34
program example for TDMA test, 83

R

radio standard
 AMPS, 135
 JTACS, 135
 NAMPS, 135
 NTACS, 135
 TACS, 135
RAM
 back-up batteries, 63
 clearing, 130
 disk allocations, 128
 loss of data, 63
 total installed, 128
RAM_MANAGER, IB_UTIL ROM
 program, 130
RAM_USAGE, IB_UTIL ROM
 program, 128
recall
 instrument setups, 58
 saved register with hardware
 change, 60
 settings, 58
Recall key, 58
RECC, 135
Ref Set key, 55
reference
 external, 75
 external output, 146
 internal, 75
 phase locking, 75
 setting, 55
reference connections, 75
REFERENCE indicators, 75

Reference indicators, 55
reference markers, spectrum
 analyzer, 118
registers
 clearing, 59
 naming, 59
release
 global user key assignment, 62
Release key, 62
remove high/low limits, 54
remove pass/fail limits, 54
remove register contents, 59
replot data files, 112
resolution
 bandwidth, spectrum analyzer,
 116
return loss measurements, swept,
 102
reverse control channel. *See*
 RECC
reverse voice channel. *See* RVC
RF Anl key, 34
RF Gen key, 34
RF IN/OUT connector
 connecting to, 32
 description, 153
RF measurements, 46
RF offset
 setting, 57
RFTOOLS
 cable fault measurements, 106
 catalog memory card, 115
 discrete frequency insertion loss
 measurements, 96
 replot data files, 112
 SA Self Calibration ON/OFF,
 113
 swept gain measurements, 93
 swept insertion loss
 measurements, 99
 swept return loss
 measurements, 102
 transfer stored data, 112
ROM program
 SERVICE4. *See* the Agilent
 8935 Assembly Level Repair
 Manual.
ROM programs
 COPY_PL, 128
 FILE_XFER, 128
 IB_UTIL, 128
 LISTOPTS, 131
 RAM_MANAGER, 130
 RAM_USAGE, 128
 RFTOOLS, 89
 SECURE_IT, 129
 ST_PLT, 132

RVC, 135

S

s key, 35
safety warnings and cautions, 10
save
 instrument setups, 58
 settings, 58
Save key, 58
save register memory allocations,
 128
saving instrument setups, 58
saving settings, 58
scientific notation
 entering numbers, 38
Scope key, 34
scope. *See* oscilloscope.
SECURE_IT, IB_UTIL ROM
 program, 129
securing files, 129
SERIAL PORT 10 connector, 154
SERIAL PORT 11 connector, 154
SERIAL PORT 9 connector, 154
serial port pin assignments, 154
SERVICE4. *See* the Agilent 8935
 Assembly Level Repair
 Manual.
settings
 base, 60
 changing, field, 33
 default, 59, 60
 power-on, 59
 recalling, 58
 saving, 58
setups
 recalling, 58
 saving, 58
signal to noise ratio, 48
Signaling Decoder screen,
 NAMP-NTAC mode
 DSAT field, 138
Signaling Encoder screen, DTMF
 mode
 Twist, 143
signaling format
 AMPS, 135
 JTACS, 135
 NAMPS, 135
 NTACS, 135
 TACS, 135
SINAD measurements, 49
SNR measurements, 49
span
 spectrum analyzer, 116
Spec Anl key, 34
spectrum analyzer
 calibration, 116

- calibration, self, 113
- resolution bandwidth, 116
- span, 116
- sweep rate, 116
- spectrum analyzer mask, 119
- SSB Demod
 - AF Anl In, 48
 - oscilloscope input, 126
- ST_PLT, 132
- Status, 78
- status codes
 - adjacent channel power, 81
 - BERT, 80
 - EVM, 79
 - how to decode, 78
 - MAHO, 82
- sweep
 - rate, spectrum analyzer, 116
- swept gain measurements, 93
- swept return loss measurements, 102
- SYNTH REF IN connector, 155

- T**
- TDMA ANALZYER INPUTS
 - CLOCK connector, 155
 - DATA connector, 155
 - TRIGGER connector, 155
- TDMA OUTPUTS connector, 156
- TDMA REF IN connector, 157
- TDMA TEST screen
 - accessing, 67
 - digital analyzer, 67
 - digital generator, 67
- timebase
 - decoder, 134
 - external output, 146
- timebase connections, 75
- transmitter power, 46
- triggering
 - external, oscilloscope connector, 150
 - oscilloscope, 127
- tuning
 - channel versus frequency, 51
- Twist
 - Signaling Encoder screen, DTMF mode, 143
- twist
 - recommended settings, 143
- twist and pre-emphasis
 - interactions, 143

- U**
- user keys
 - assigning global, 62
 - assigning, local, 62

- clearing, global assignment, 62
- deleting, global assignment, 62
- explanation, 61
- global, assignment, 62
- global, defined, 61
- local, defined, 61
- preassigned, 61
- releasing, global assignment, 62
- releasing, local assignment, 62
- setting, global, 62

- utilities
 - catalog memory card, 115
 - data collection, transferring
 - data, 112
 - replot data files, 112
 - spectrum analyzer self
 - calibration, 113
- uV key, 35

- V**
- V key, 35
- VIDEO OUT connector, 157

- W**
- W key, 35
- waveform generator, 141