

Agilent 87104/87106A, B, C Multiport Coaxial Switches dc to 4 GHz, dc to 20 GHz, dc to 26.5 GHz

Technical Overview

High performance multiport switches for microwave and RF instrumentation and systems

- SP4T and SP6T configuration
- Magnetic latching
- Operating life of 10 million cycles, typical
- Guaranteed repeatability of 0.03 dB up to 5 million cycles ensures accurate system measurements and reduces calibration intervals
- Excellent isolation, typically >90 dB at 26.5 GHz
- Opto-electronic indicators and interrupts
- Terminated ports
- TTL/5 V CMOS compatible (optional)

Modern automated test systems demand higher accuracy and performance than ever before. The Agilent Technologies 87104A/B/C and 87106A/B/C multiport switches offer improvements in insertion loss repeatability and isolation necessary to achieve higher test system performance. Long life, repeatability, and reliability lowers the cost of ownership by reducing calibration cycles and increasing test system uptime and are vital to ATS measurement system integrity over time.



Description

The 87104A/B/C SP4T and 87106A/B/C SP6T terminated multiport switches provide the life and reliability required for automated test and measurement, signal monitoring, and routing applications. Innovative design and careful process control creates switches that meet the requirements for highly repeatable switching elements in test instruments and switching interfaces. The switches are designed to operate for more than 10,000,000 cycles. The

exceptional 0.03-dB insertion loss repeatability is warranted for 5 million cycles at 25 °C.

This reduces sources of random errors in the measurement path and improves measurement uncertainty. Switch life is a critical consideration in production test systems, satellite and antenna monitoring systems, and test instrumentation. The longevity of these switches increases system uptime, and lowers the cost of ownership by reducing calibration cycles and switch maintenance.

Anticipate — Accelerate — Achieve



Agilent Technologies

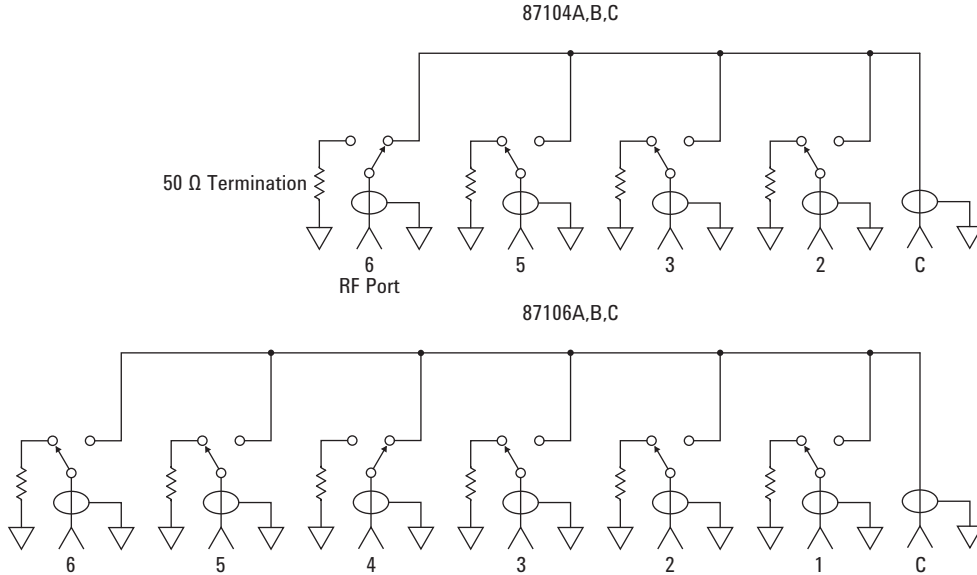

Figure 1. Agilent 87104A/B/C and 87106A/B/C simplified schematics

Operating to 4 GHz (A models), 20 GHz (B models), and 26.5 GHz (C models), these switches exhibit exceptional isolation performance required to maintain measurement integrity. Isolation between ports is typically >100 dB to 12 GHz and >90 dB to 26.5 GHz. This reduces the influence of signals from other channels, sustains the integrity of the measured signal, and reduces system measurement uncertainties. These switches also minimize measurement uncertainty with low insertion loss and reflection, which make them ideal elements in large multi-tiered switching systems.

Both the 87104A/B/C and 87106A/B/C are designed to fall within most popular industry footprints. The 2¼ inch square flange provides mounting holes, while the rest of the 2½ inch long by 2¼ inch diameter body will easily fit into most systems. Ribbon cable or optional solder terminal connections accommodate the need for secure and efficient control cable attachment.

Option 100 provides solder terminal connections in place of the 16-pin ribbon drive cable. Option 100 does not incorporate the “open all paths” feature.

Opto-electronic interrupts and indicators improve reliability and extend the life of the switch by eliminating DC circuit contact failures characteristic of conventional electromechanical switches. These switches have an interrupt circuit that provides logic to open all but the selected paths, and then closes the selected paths. All other paths are terminated with 50 ohm loads, and the current to all the solenoids is then cut off. These versions also offer independent indicators that are controlled by optical interrupts in the switch. The indicators provide a closed path between the indicator common pin and the corresponding sense pin of the selected path.

Applications

Multiport switches find use in a large number of applications, increasing system flexibility and simplifying system design.

Simple signal routing

The simplest signal routing scheme takes the form of single input to multiple outputs. These matrixes are often used on the front of an analyzer in order to test several two-port devices sequentially or for testing multiport devices. In surveillance applications, a multiport switch can be used for selecting the optimum antenna in order to intercept a signal.

Two methods can be used to accomplish the single input to multiple output arrangement. Traditionally where isolation greater than 60 dB was required, a tree matrix composed of SPDT switches was used. While this gave great isolation, it was at the cost of more switches (Figure 2). The 87104 and 87106 switches have port-to-port isolations typically greater than 90 dB at 26.5 GHz, eliminating the need to use a tree matrix in order to achieve high isolation (Figure 3). In addition to the reduced part count, the path lengths are shorter, so insertion loss is less, and paths are of equal length, so phase shift is constant.

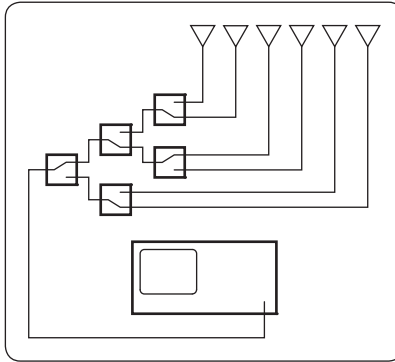

Figure 2. Tree matrix

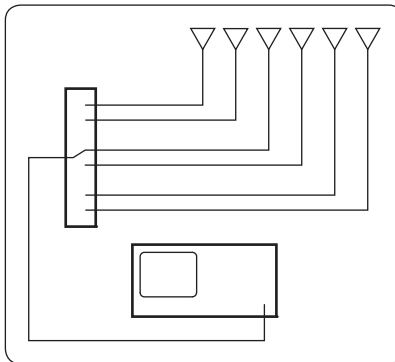

Figure 3. Multiport matrix

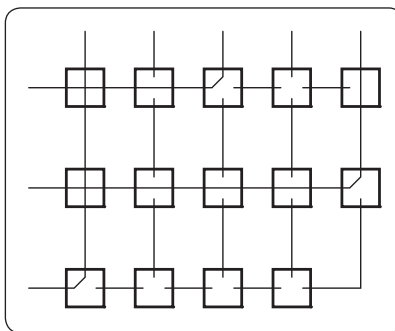

Figure 4. Cross-point matrix

Full access switching

Full access switching systems give the flexibility to route multiple input signals to multiple outputs simultaneously. Full access switching matrixes find use in generic test systems in order to provide flexible routing of signals to and from many different devices under test and stimulus and analysis instrumentation. Cross-point matrixes, using single pole double throw and cross-point switches, have traditionally been used in order to maintain high channel-to-channel isolation (Figure 4). As with the tree matrixes, this is at the cost of hardware and performance. Full access switching can also be achieved using multiport switches (Figure 5).

The advantage of the multiport matrix over the cross-point matrix is lower insertion loss and improved SWR performance due to consistent path length and fewer switches and connecting cables.

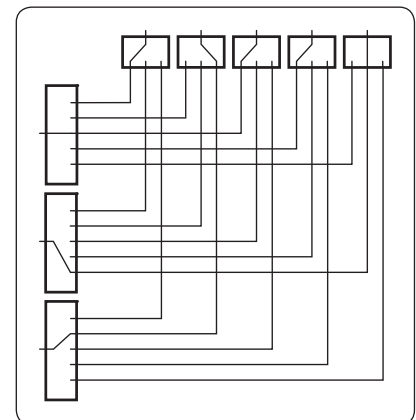

Figure 5. Full access matrix

Dedicated switching

There are a number of applications where switching will be used, not for flexibility, but to accomplish a particular function within an instrument. For example, switched filter banks for reducing harmonics in the output of sources or to the input of analyzers can use multipoint switches in series to select the right filter for the band of interest. For larger switching systems, where many switches will be used to provide complex signal routing, a switch driver such as the Agilent 11713B/C with 87204/6 switches is recommended.

Driving the switch

Each RF path can be closed by applying ground (TTL “High” for Option T24) to the corresponding “drive” pin. In general, all other RF paths are simultaneously opened by internal logic.

Standard drive (Option 024)

See Figures 10 and 11 for drive connection diagrams.

- Connect pin 1 to supply (+20 VDC to +32 VDC).
- Connect pin 15 to ground (see Note 1).
- Select (close) desired RF path by applying ground to the corresponding “drive” pin; for example ground pin 3 to close RF path 1 (see Note 2).
- To select another RF path, ensure that all unwanted RF path “drive” pins are disconnected from ground (to prevent multiple RF path engagement). Ground the “drive” pin which corresponds to the desired RF path (see Note 3).
- To open all RF paths, ensure that all RF path “drive” pins are disconnected from ground. Then, connect pin 16 to ground. Note: This feature is not available with Option 100.

TTL drive (Option T24)

See Figure 10 for drive connection diagrams.

- Connect pin 1 to supply (+20 VDC to +32 VDC).
- Connect pin 15 to ground (see Notes 1, 4).
- Select (close) desired RF path by applying TTL “High” to the corresponding “drive” pin; for example apply TTL “High” to pin 3 to close RF path 1 (see Note 2).
- To select another path, ensure that all unwanted RF path “drive” pins are at TTL “Low” (to prevent multiple RF path engagement). Apply TTL “High” to the “drive” pin which corresponds to the desired RF path (see Note 3).
- To open all RF paths, ensure that all RF path “drive” pins are at TTL “Low.” Then, apply TTL “High” to pin 16. Note: This feature is not available with Option 100.

Notes:

1. Pin 15 must always be connected to ground to enable the electronic position-indicating circuitry and drive logic circuitry.
CAUTION: IF PIN 15 IS NOT CONNECTED TO POWER SUPPLY GROUND, CATASTROPHIC FAILURE WILL OCCUR.
2. After the RF path is switched and latched, the drive current is interrupted by the electronic position-sensing circuitry. Pulsed control is not necessary, but if implemented, the pulse width must be 15 ms minimum to ensure that the switch is fully latched.
3. The default operation of the switch is break-before-make. Make-before-break switching can be accomplished by simultaneously selecting the old RF path “drive” pin and the new RF path “drive” pin. This will simultaneously close the old RF path and the new RF path. Once the new RF path is closed (15 ms), de-select the old RF path “drive” pin while leaving the new RF path “drive” pin selected. The switch circuitry will automatically open the old RF path while leaving the new RF path engaged.
4. In addition to the quiescent current supplying the electronic position-sensing circuitry, the drive current flows out of pin 15 (during switching) on TTL drive switches (Option T24).

Electronic position indicators

The electronic position indicators consist of optically isolated, solid state relays which are driven by photo-electric sensors coupled to the mechanical position of the RF path's moving elements (Figure 6). The circuitry consists of a common which can be connected to an output corresponding to each RF path. If multiple RF paths are engaged, the position indicator corresponding to each closed RF path will be connected to common. The solid state relays are configured for AC and/or DC operation. (See indicator specifications.) The electronic position indicators require that the supply (20 to 32 VDC) be connected to pin 1 and ground connected to pin 15.

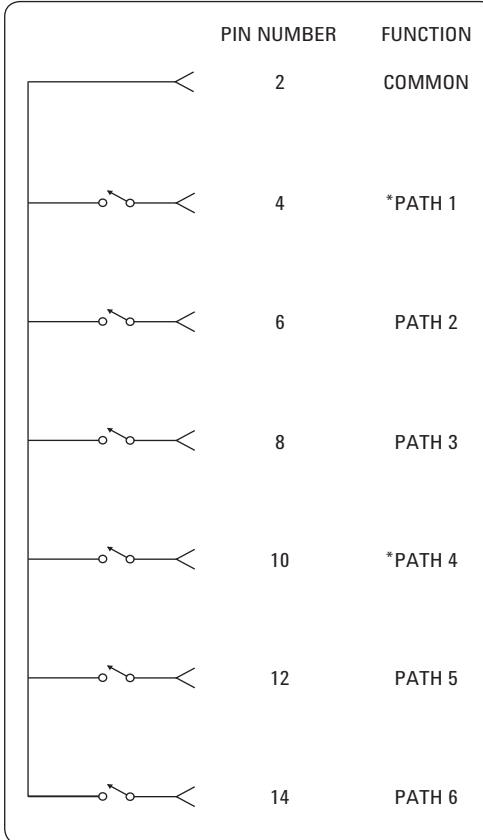

* Paths 1 and 4 are not connected for the 87104A/B/C

Figure 6. Pin function diagram

Specifications

Specifications describe the instrument's warranted performance.

Supplemental and typical characteristics are intended to provide information useful in applying the instrument by giving typical, but not warranted performance parameters.

Life: 5,000,000 cycles minimum

Switching speed: 15 ms maximum

Indicator specifications

Maximum withstand voltage: 60 V

Maximum current capacity: 150 mA

Maximum "ON" resistance: 2.5 Ω

Maximum "OFF" resistance: 10 G Ω

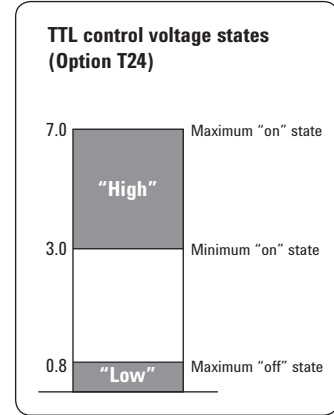

Switch drive specifications

Parameter test	Conditions	Min	Nom	Max	Units
Supply voltage, Vcc					
Option 024 and T24		20	24	32	V
Supply current, Icc					
	Switching: Pulse width \geq 15 ms: Vcc = 24 VDC ¹				
Option 024 and T24			200 ¹		mA
Supply current (quiescent)					
Option 024 and T24		25		50	mA
Option T24					
High level input		3		7	V
Low level input				0.8	V
Max high input current	Vcc = Max Vinput = 3.85 VDC		1	1.4	mA

1. Closing one RF path requires 200 mA. Add 200 mA for each additional RF path closed or opened. Using all RF paths open (selecting pin 16) requires 200 mA per RF path reset with Vcc=24 VDC.

Specifications (continued)

	87104A 87106A	87104B 87106B	87104C 87106C
Frequency range	dc to 4 GHz	dc to 20 GHz	dc to 26.5 GHz
Insertion loss (see Figure 7)	0.3 dB + 0.015 x frequency (GHz)	0.3 dB + 0.015 x frequency (GHz)	0.3 dB + 0.015 x frequency (GHz)
Isolation (see Figure 8)	100 dB minimum	100 dB minimum to 12 GHz 80 dB minimum to 12 to 15 GHz 70 dB minimum to 15 to 20 GHz	100 dB minimum to 12 GHz 80 dB minimum to 12 to 15 GHz 70 dB minimum to 15 to 20 GHz 65 dB minimum to 20 to 26.5 GHz
SWR	1.2 maximum	1.2 maximum dc to 4 GHz 1.35 maximum 4 to 12.4 GHz 1.45 maximum 12.4 to 18 GHz 1.7 maximum 18 to 20 GHz	1.2 maximum dc to 4 GHz 1.35 maximum 4 to 12.4 GHz 1.45 maximum 12.4 to 18 GHz 1.7 maximum 18 to 26.5 GHz
Repeatability (Up to 5 million cycles measured at 25 degrees C)	0.03 dB maximum	0.03 dB maximum	0.03 dB maximum
Connectors	SMA (f)	SMA (f)	SMA (f)

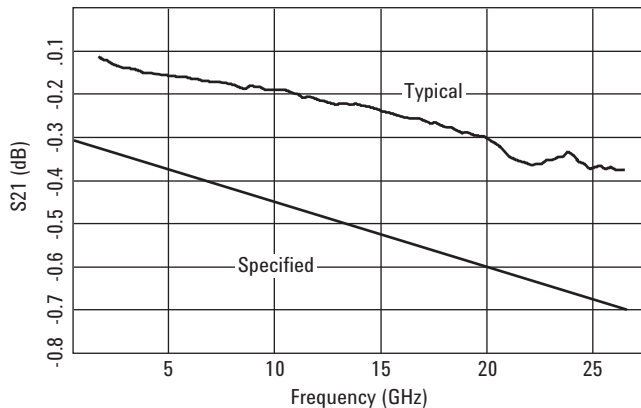

Figure 7. Insertion loss

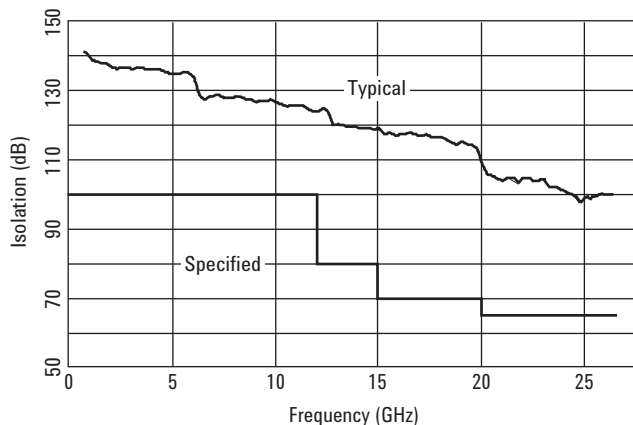
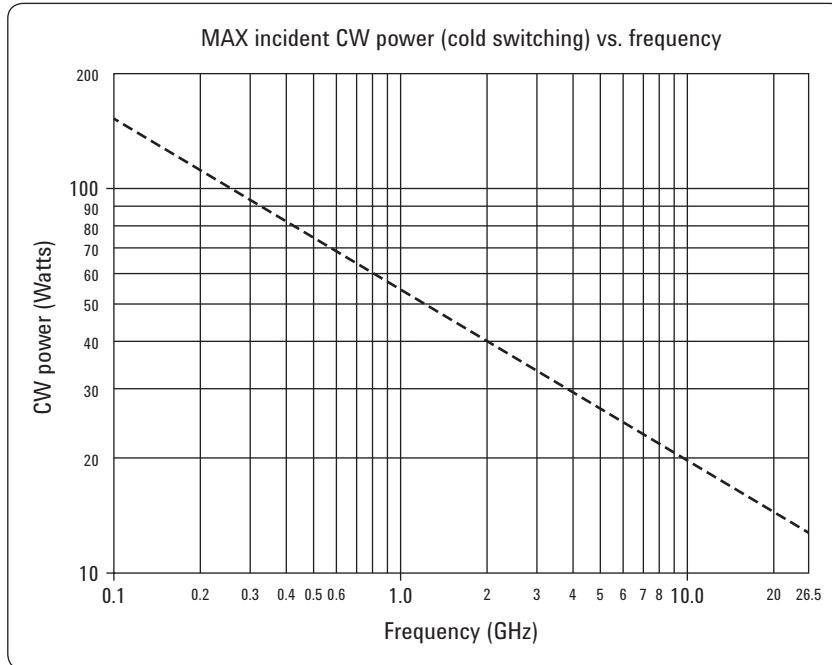

Figure 8. Isolation

Supplemental specifications (cold switching)



Reference conditions:

- Cold switching only (NO Hot switching)
- Ambient temperature of 75 °C or less
- Sea level (0.88 derating @ 15,000 ft.)
- Load VSWR < 1.2 (see graph for derating above 1.2 VSWR)

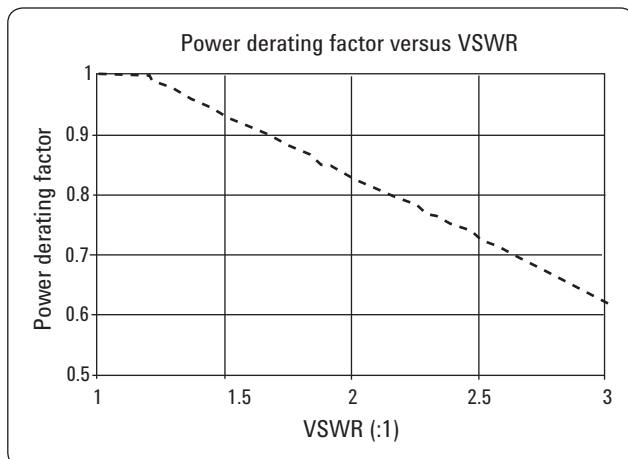

Specifications (continued)

Maximum power rating	
Into internal termination	1W CW 50 W peak, 10 μs max pulse width, not to exceed 1 W average
Into thru path	2 W CW
Hot switching	100 W peak, 10 μs max pulse width, not to exceed 2 W average
Cold switching	150 W CW at 3 GHz, 25 °C 120 W CW at 4.2 GHz, 25 °C

Environmental specifications

Operating temperature	-25 to 75 °C
Storage temperature	-55 to 85 °C
Temperature cycling	-55 to 85 °C, 10 cycles per MIL-STD-202F, Method 107D, Condition A (modified)
Vibration	
Operating	7 g: 5 to 2000 Hz at 0.25 in p-p
Survival	20 g: 20 to 2000 Hz at 0.06 in p-p, 4 min/cycle, 4 cycles/axis
Random	2.41 g (rms) 10 min/axis
Shock	Half-sine: 500 g at 0.5 ms, 3 drops/direction, 18 total
Operating	50 g at 6 ms, 6 directions
Moisture resistance	65 °C, 95% RH, 10 days per MIL-STD-202F, Method 106E
Altitude storage	50,000 feet (15,240 meters per MIL-STD-202F, Method 105C, Condition B)
RFI	Per MIL-STD-461C, RE02, Part 4
Magnetic field	<5 gauss ¼ inch from surface

Physical specifications

Dimensions	Per Figure 9
Weight	229 gm (0.50 lb)

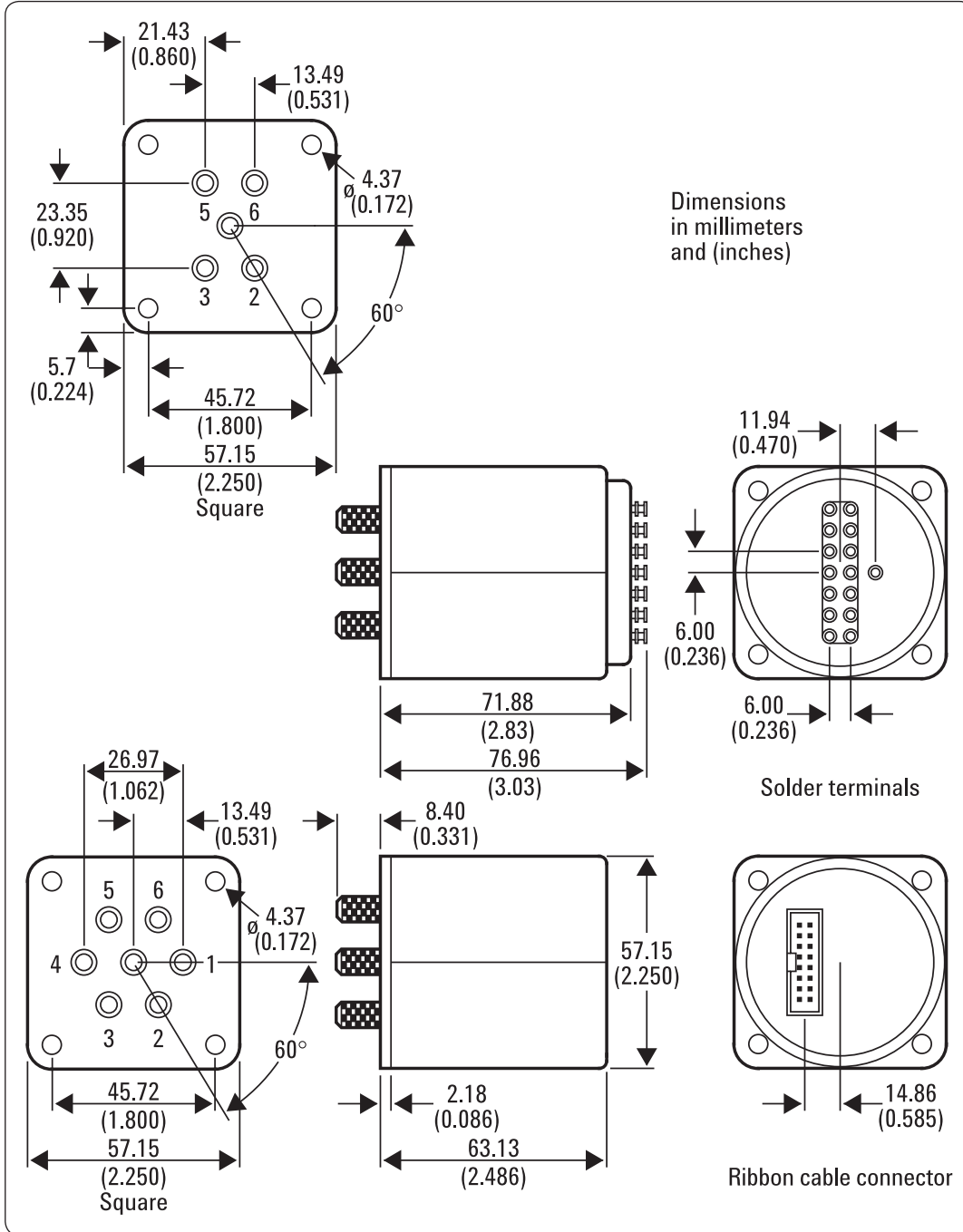
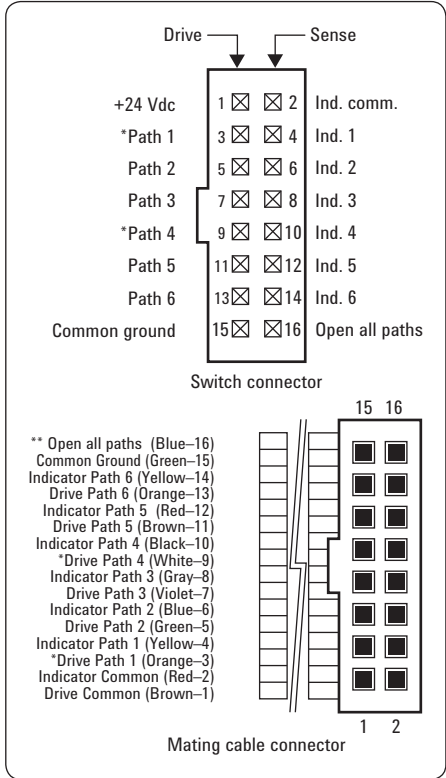

Figure 9. Product outlines



* Paths 1 and 4 not connected for the 87104A/B/C.

** "Open all paths" pin is not available.

Figure 10. Drive connection diagrams with Option 161

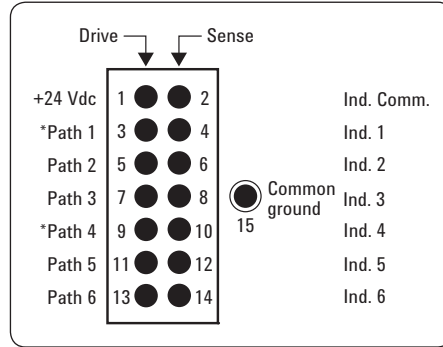

* Paths 1 and 4 not connected for the 87104A/B/C.

Figure 11. Drive connection diagrams with Option 100

Troubleshooting

Symptom	Probable cause
1. Will not switch	<ul style="list-style-type: none"> Not connected to supply Supply < 20 V Supply current too low Not connected to ground Select line not at ground (std) TTL "Low" voltage too high (Option 72) All-path-open line selected
2. Position indicators don't work	<ul style="list-style-type: none"> Supply not connected Supply < 20 VDC Pin 15 not connected to ground

Ordering information

Switches	
87104A	dc to 4 GHz, SP4T Terminated
87104B	dc to 20 GHz, SP4T Terminated
87104C	dc to 26.5 GHz, SP4T Terminated
87106A	dc to 4 GHz, SP6T Terminated
87106B	dc to 20 GHz, SP6T Terminated
87106C	dc to 26.5 GHz, SP6T Terminated
Option 100	Solder terminals to replace ribbon cable
Option 161	16 PIN DIP socket and connector with 24 inch ribbon cable
Option UK6	Commercial calibration test data with certificate
Option T24	TTL/5 V CMOS compatible option
Option 024	24 V DC without TTL Logic

Note: Options 024 and 161 are default options for dc drive and connector.

Drivers	
11713B/C Attenuator switch driver	Drives up to 10 or more sections of switches or attenuators.
Option 201 Accessory cable	Viking connector to bare tinned wires (60 inches long). Use to connect 11713B/C to 87104/106 with Option 100. One required with 87104A/B/C Option 100; two required with 87106A/B/C Option 100.
Option 401 Accessory cable	Dual-viking connector to 16-pin DIP connector. Use to connect 11713B/C to 87106 default Option 161.
Option 601 Accessory cable	Viking connector to 16-pin DIP connector. Use to connect 11713B/C to 87104 default Option 161.

Related literature

Publication title	Pub number
<i>Agilent RF and Microwave Switch Selection Guide</i>	5989-6031EN
<i>Power Handling Capability of Electromechanical Switches Application Note</i>	5989-6032EN
<i>Coaxial Electromechanical Switches: How Operating Life and Repeatability of Agilent's Electromechanical Switches Minimize System Uncertainty Application Note</i>	5989-6085EN
<i>Agilent RF & Microwave Switches Performance you can count on Brochure</i>	5989-6947EN
<i>Agilent 11713B/C Attenuator/Switch Drivers Configuration Guide</i>	5989-7277EN
<i>Multiport Solutions for E5071C ENA RF Network Analyzers Using External Switches Application Note</i>	5989-7916EN
<i>Agilent Technologies Bench and System Switching Products Brochure</i>	5989-9872EN



myAgilent

www.agilent.com/find/myagilent

A personalized view into the information most relevant to you.

Agilent Channel Partners

www.agilent.com/find/channelpartners

Get the best of both worlds: Agilent's measurement expertise and product breadth, combined with channel partner convenience.



Agilent Advantage Services

www.agilent.com/find/AdvantageServices

Accurate measurements throughout the life of your instruments.



www.agilent.com/quality

www.agilent.com
www.agilent.com/find/mta

For more information on Agilent Technologies' products, applications or services, please contact your local Agilent office. The complete list is available at: www.agilent.com/find/contactus

Americas

Canada	(877) 894 4414
Brazil	(11) 4197 3600
Mexico	01800 5064 800
United States	(800) 829 4444

Asia Pacific

Australia	1 800 629 485
China	800 810 0189
Hong Kong	800 938 693
India	1 800 112 929
Japan	0120 (421) 345
Korea	080 769 0800
Malaysia	1 800 888 848
Singapore	1 800 375 8100
Taiwan	0800 047 866
Other AP Countries	(65) 375 8100

Europe & Middle East

Belgium	32 (0) 2 404 93 40
Denmark	45 45 80 12 15
Finland	358 (0) 10 855 2100
France	0825 010 700*
	*0.125 €/minute
Germany	49 (0) 7031 464 6333
Ireland	1890 924 204
Israel	972-3-9288-504/544
Italy	39 02 92 60 8484
Netherlands	31 (0) 20 547 2111
Spain	34 (91) 631 3300
Sweden	0200-88 22 55
United Kingdom	44 (0) 118 927 6201

For other unlisted countries:

www.agilent.com/find/contactus

(BP-3-1-13)

Product specifications and descriptions in this document subject to change without notice.

© Agilent Technologies, Inc. 2013
Published in USA, May 14, 2013
5091-3366E



Agilent Technologies