

User's and Service Guide

Agilent Technologies 85057B 2.4 mm Verification Kit

This manual applies to 85057B verification kits with serial number prefix 3105A.



Agilent Part Number: 85057-90015

Printed in USA

Print Date: November 2005

Supersedes: January 2002

© Copyright 1995, 2002, 2005 Agilent Technologies, Inc. All rights reserved.

Documentation Warranty

THE MATERIAL CONTAINED IN THIS DOCUMENT IS PROVIDED "AS IS," AND IS SUBJECT TO BEING CHANGED, WITHOUT NOTICE, IN FUTURE EDITIONS. FURTHER, TO THE MAXIMUM EXTENT PERMITTED BY APPLICABLE LAW, AGILENT DISCLAIMS ALL WARRANTIES, EITHER EXPRESS OR IMPLIED WITH REGARD TO THIS MANUAL AND ANY INFORMATION CONTAINED HEREIN, INCLUDING BUT NOT LIMITED TO THE IMPLIED WARRANTIES OF MERCHANTABILITY AND FITNESS FOR A PARTICULAR PURPOSE. AGILENT SHALL NOT BE LIABLE FOR ERRORS OR FOR INCIDENTAL OR CONSEQUENTIAL DAMAGES IN CONNECTION WITH THE FURNISHING, USE, OR PERFORMANCE OF THIS DOCUMENT OR ANY INFORMATION CONTAINED HEREIN. SHOULD AGILENT AND THE USER HAVE A SEPARATE WRITTEN AGREEMENT WITH WARRANTY TERMS COVERING THE MATERIAL IN THIS DOCUMENT THAT CONFLICT WITH THESE TERMS, THE WARRANTY TERMS IN THE SEPARATE AGREEMENT WILL CONTROL.

DFARS/Restricted Rights Notice

If software is for use in the performance of a U.S. Government prime contract or subcontract, Software is delivered and licensed as "Commercial computer software" as defined in DFAR 252.227-7014 (June 1995), or as a "commercial item" as defined in FAR 2.101(a) or as "Restricted computer software" as defined in FAR 52.227-19 (June 1987) or any equivalent agency regulation or contract clause. Use, duplication or disclosure of Software is subject to Agilent Technologies' standard commercial license terms, and non-DOD Departments and Agencies of the U.S. Government will receive no greater than Restricted Rights as defined in FAR 52.227-19(c)(1-2) (June 1987). U.S. Government users will receive no greater than Limited Rights as defined in FAR 52.227-14 (June 1987) or DFAR 252.227-7015 (b)(2) (November 1995), as applicable in any technical data.

Assistance

Product maintenance agreements and other customer assistance agreements are available for Agilent products.

For any assistance, contact Agilent Technologies. Refer to [page 5-5](#) for a list of Agilent contacts.

Printing Copies of This Document

To print copies of this document, download the PDF file from the Agilent Web site:

- Go to <http://www.agilent.com>.
- Enter the document's part number (located on the title page) in the **Quick Search** box.
- Click **GO**.

1. General Information	
Verification Kit Overview	1-2
Kit Contents	1-2
Compatible Network Analyzers	1-2
Equipment Required but Not Supplied	1-3
Incoming Inspection	1-3
Recording the Device Serial Numbers	1-3
Clarifying the Terminology of a Connector	1-4
Preventive Maintenance	1-4
2. Specifications	
Environmental Requirements	2-2
Temperature—What To Watch Out For	2-2
Mechanical Characteristics	2-3
Pin Depth	2-3
Supplemental Characteristics	2-4
Airline Characteristics	2-5
Electrical Specifications	2-7
3. Use, Maintenance, and Care of the Devices	
Electrostatic Discharge	3-2
Visual Inspection	3-3
Look for Obvious Defects and Damage First	3-3
What Causes Connector Wear?	3-3
Inspect the Mating Plane Surfaces	3-3
Inspect Female Connectors	3-4
Cleaning Connectors	3-5
Gaging Connectors	3-7
Connector Gage Accuracy	3-7
When to Gage Connectors	3-7
Gaging Procedures	3-8
Gaging 2.4 mm Connectors	3-8
Gaging the Airline	3-10
Connections	3-14
How to Make a Connection	3-14
Preliminary Connection	3-14
Final Connection Using a Torque Wrench	3-14
Connecting the Airline	3-16
How to Separate a Connection	3-18
Handling and Storage	3-18
4. Performance Verification	
Introduction	4-2
How Agilent Verifies the Devices in Your Kit	4-2
Recertification	4-3
How Often to Recertify	4-3
Where to Send a Kit for Recertification	4-3

5. Troubleshooting
 Troubleshooting Process 5-2
 Returning a Kit or Device to Agilent Technologies 5-4
 Contacting Agilent..... 5-5

6. Replaceable Parts
 Introduction 6-2

1 General Information

Verification Kit Overview

The Agilent 85057B 2.4 mm verification kit provides a set of standards with known characteristics, traceable to a reference (golden) standard in Agilent Technologies calibration lab. This set of standards is used to verify your measurement calibration and also to verify that your network analyzer system is operating within its specifications. The frequency range covered by the 85057B is from 45 MHz to 50 GHz.

Kit Contents

The 85057B verification kit includes the following items:

- 20 dB attenuator
- 40 dB attenuator
- 25Ω mismatch airline
- 50Ω airline
- data disks that contain factory-measured verification data.

Refer to [Chapter 6, “Replaceable Parts,”](#) for a complete list of contents and their associated part numbers.

NOTE A file containing the verification data for your kit is maintained for one year from the time of measurement. If you lose this data, see [“Contacting Agilent” on page 5-5](#) for a list of telephone numbers.

Compatible Network Analyzers

The 85057B verification kit is intended to be used with the 85056A 2.4 mm calibration kits and any of the following Agilent network analyzers:

- 8510
- 872x Series
- PNA Series

The verification data disk provided for use with each of the network analyzers listed above contains the factory-measured S-parameter data for the devices in this kit. It also contains the uncertainty limits used in the system verification procedure. This data is unique to each kit.

NOTE A backup copy of each verification data disk and printout should be made immediately upon receipt of this kit. Refer to your analyzers user’s guide for instructions on duplicating a disk.

Equipment Required but Not Supplied

Certain items are required or recommended for successful operation of the verification kit but are *not* included in the kit. Refer to [Table on page 6-2](#) for ordering information.

Incoming Inspection

Verify that the shipment is complete by referring to [Table 6-1 on page 6-2](#).

Check for damage. The foam-lined storage case provides protection during shipping. Verify that this case and its contents are not damaged.

If the case or any device appears damaged, or if the shipment is incomplete, refer to [“Contacting Agilent” on page 5-5](#). Agilent will arrange for repair or replacement of incomplete or damaged shipments without waiting for a settlement from the transportation company. Refer to [“Returning a Kit or Device to Agilent Technologies” on page 5-4](#) for instructions.

Recording the Device Serial Numbers

In addition to the kit serial number, the devices in this kit are individually serialized (serial numbers are labeled into the body of each device). Record these serial numbers in [Table 1-1](#). Recording the serial numbers will prevent confusing the devices in this kit with similar devices from other kits.

Table 1-1 Serial Number Record for the 85057B

Device	Serial Number
Verification kit	_____
20 dB attenuator	_____
40 dB attenuator	_____
50Ω airline	_____
25Ω mismatch airline	_____

Clarifying the Terminology of a Connector Interface

In this document and in the prompts of the PNA calibration wizard, the sex of connectors and adapters is referred to in terms of the center conductor. For example, a connector or device designated as 1.85 mm –f– has a 1.85 mm female center conductor.

8510-series, 872x, and 875x ONLY: In contrast, during a measurement calibration, the network analyzer softkey menus label a 1.85 mm calibration device with reference to the sex of the analyzer's test port connector—not the calibration device connector. For example, the label SHORT (F) refers to the short that is to be connected to the female test port. This will be a male short from the calibration kit.

Table 1-2 Clarifying the Sex of Connectors: Examples

Terminology	Meaning
Short –f–	Female short (female center conductor)
Short (f)	Male short (male center conductor) to be connected to female port

A connector gage is referred to in terms of the connector that it measures. For instance, a male connector gage has a female connector on the gage so that it can measure male devices.

Preventive Maintenance

The best techniques for maintaining the integrity of the devices in this kit include:

- routine visual inspection
- cleaning
- proper gaging
- proper connection techniques

All of these are described in [Chapter 3](#). Failure to detect and remove dirt or metallic particles on a mating plane surface can degrade repeatability and accuracy and can damage any connector mated to it. Improper connections, resulting from pin depth values being out of specification (see [Table 2-2 on page 2-4](#)), or from bad connection techniques, can also damage these devices.

2 Specifications

Environmental Requirements

Table 2-1 Environmental Requirements

Parameter	Required Values/Ranges
Temperature	
Operating ^a	+20 °C to +26 °C (+68 °F to +79 °F)
Storage	-40 °C to +75 °C (-40 °F to +167 °F)
Error-corrected range ^b	±1 °C (1.8 °F) of measurement calibration temperature
Altitude	
Operating	< 4,500 meters (≈15,000 feet)
Storage	< 15,000 meters (≈50,000 feet)
Relative humidity	Always non-condensing
Operating	0 to 80% (26 °C maximum dry bulb)
Storage	0 to 90%

- a. The temperature range over which the calibration standards maintain conformance to their specifications.
- b. The allowable network analyzer ambient temperature drift during measurement calibration and during measurements when the network analyzer error correction is turned on. Also, the range over which the network analyzer maintains its specified performance while correction is turned on.

Temperature—What To Watch Out For

Due to the small dimensions of the devices, electrical characteristics will change with temperature. Therefore, the operating temperature is a critical factor in their performance, and must be stable before use.

IMPORTANT Avoid unnecessary handling of the devices during use because your fingers are a heat source.

Mechanical Characteristics

Mechanical characteristics such as center conductor protrusion and pin depth are *not warranted* performance specifications. They are, however, important supplemental characteristics related to electrical performance. Agilent Technologies verifies the mechanical characteristics of the devices in this kit with special gaging processes and electrical testing. This ensures that the device connectors do not exhibit any improper pin depth when the kit leaves the factory.

“Gaging Connectors” on page 3-7 explains how to use gages to determine if the kit devices have maintained their mechanical integrity. Refer to Table 2-2, “Connector Pin Depths,” for allowable recession.

Pin Depth

Pin depth is the distance the center conductor mating plane differs from being flush with the outer conductor mating plane. See Figure 2-1. The pin depth of a connector can be in one of two conditions:

- **Protrusion** is the condition in which the center conductor extends beyond the outer conductor mating plane. This condition will indicate a positive value on the connector gage.
- **Recession** is the condition in which the center conductor is set back from the outer conductor mating plane. This condition will indicate a negative value on the connector gage.

Figure 2-1 Connector Pin Depth

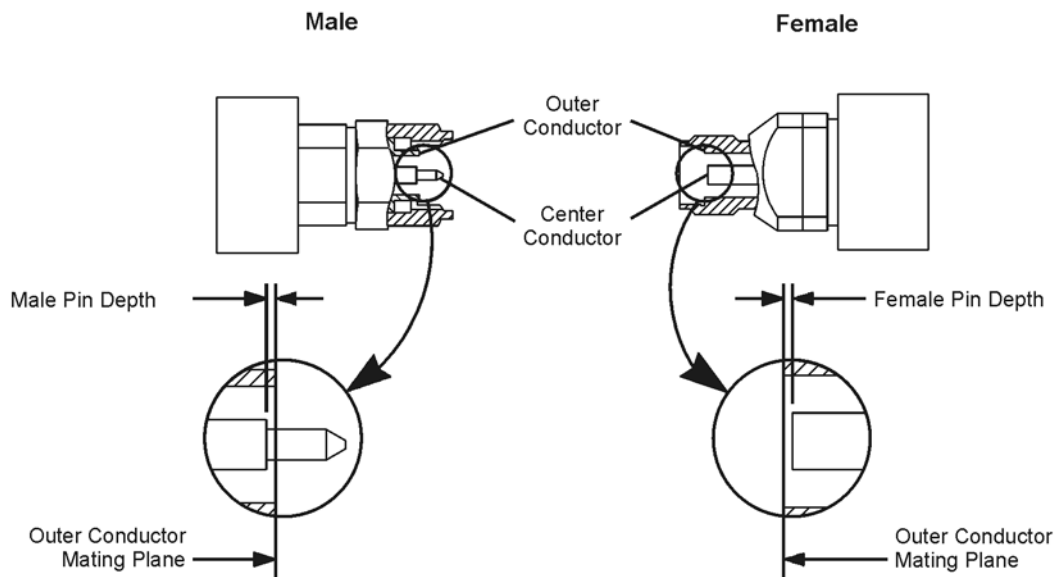

ph51b

Supplemental Characteristics

The following tables list the dimensions of the 50Ω airline and the 25Ω mismatch airline. These are supplemental mechanical characteristics, and from these characteristics you can calculate expected electrical performance.

Table 2-2 Connector Pin Depths

Connectors	Allowable Recession	
	millimeters	inches
Attenuators	0.000 to -0.025	0.0000 to -0.001
Airlines ^a	0.0000 to -0.013	0.0000 to -0.0005

- a. The relationship between the length of the inner conductor and the length of the outer conductor determines the airline center conductor recession. Refer to [“Gaging the Airline” on page 3-10](#).

Using these mechanical dimensions, you can calculate the expected electrical performance with the equations in the following publications:

- Nelson, Robert E., and Marlene R. Coryell, "Electrical Parameters of Precision, Coaxial, Air-Dielectric Transmission Lines", U.S. National Bureau of Standards Monograph No. 96.
- Somlo, P.I., "The Computation of Coaxial Line Step Capacitances", IEEE Transactions on Microwave Theory and Techniques, Volume MTT-15, No. 1, January, 1967.

The measurement method in these publications provides a general idea of the expected device characteristic impedance. Variations in connector interfaces can have a large effect on your actual electrical measurements.

Airline Characteristics

The dimensions of the airline outer conductor are shown in [Figure 2-2](#). There are two similar outer conductors in each kit. They are specifically matched to each center conductor.

The dimensions of the 50Ω airline and the 25Ω mismatch airline are shown in [Figure 2-3](#) and [Figure 2-4](#).

CAUTION The center and outer conductors of the airlines in this kit have been mechanically measured and matched. Do *not* use the center or outer conductors provided in this kit with a center or outer conductor from any other airline. Damage to the airline or attaching connector may result.

Figure 2-2 Airline Outer Conductor

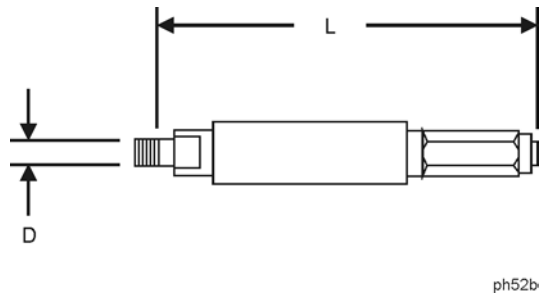

Dimension	millimeters	inches
D –Diameter	2.400 ±0.0025	0.0945 ±0.0001
L –Length	49.991 ±0.025	1.968 ±0.001

Figure 2-3 50Ω Airline Center Conductor

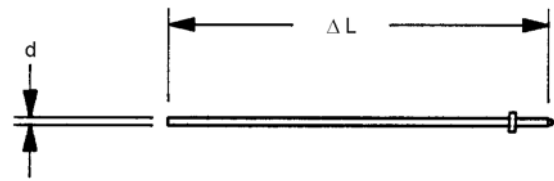

ph53b

Dimension	millimeters	inches
d	1.0423 ± 0.003	0.04104 ± 0.00012
ΔL	$+0.0025/-0.013$	$+0.0001/-0.0005$

Figure 2-4 25Ω Mismatch Airline Center Conductor

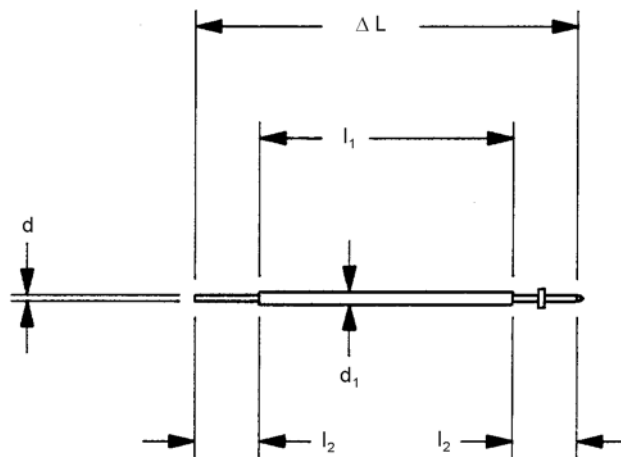

ph54b

Dimension	millimeters	inches
d	1.0423 ± 0.008	0.04104 ± 0.0003
d_1	1.58 ± 0.005	0.0622 ± 0.0002
l_1	37.46 ± 0.019	1.4748 ± 0.0007
l_2	6.22 ± 0.050	0.2449 ± 0.002
ΔL	$+0.0025/-0.013$	$+0.0001/-0.0005$

Electrical Specifications

At the factory, each verification device is electrically characterized on a network analyzer measurement system. These factory measurements are traceable to the National Institute of Standards and Technology (NIST) through mechanical and electrical paths (for more information on traceability, contact Agilent Technologies. Refer to [“Contacting Agilent” on page 5-5](#)).

The factory-measured data for each device is supplied in print and on disk with your kit.

3 Use, Maintenance, and Care of the Devices

Electrostatic Discharge

Protection against ESD (electrostatic discharge) is essential while connecting, inspecting, or cleaning connectors attached to a static-sensitive circuit (such as those found in test sets).

Static electricity can build up on your body and can easily damage sensitive internal circuit elements when discharged. Static discharges too small to be felt can cause permanent damage. Devices such as calibration components and devices under test (DUTs), can also carry an electrostatic charge. To prevent damage to the test set, components, and devices:

- *always* wear a grounded wrist strap having a 1 M Ω resistor in series with it when handling components and devices or when making connections to the test set.
- *always* use a grounded, conductive table mat while making connections.
- *always* wear a heel strap when working in an area with a conductive floor. If you are uncertain about the conductivity of your floor, wear a heel strap.
- *always* ground yourself before you clean, inspect, or make a connection to a static-sensitive device or test port. You can, for example, grasp the grounded outer shell of the test port or cable connector briefly.
- *always* ground the center conductor of a test cable before making a connection to the analyzer test port or other static-sensitive device. This can be done as follows:
 1. Connect a short (from your calibration kit) to one end of the cable to short the center conductor to the outer conductor.
 2. While wearing a grounded wrist strap, grasp the outer shell of the cable connector.
 3. Connect the other end of the cable to the test port.
 4. Remove the short from the cable.

Figure 3-1 shows a typical ESD protection setup using a grounded mat and wrist strap. For parts numbers of ESD protection supplies, refer to Table 6-2

Figure 3-1 ESD Protection Setup

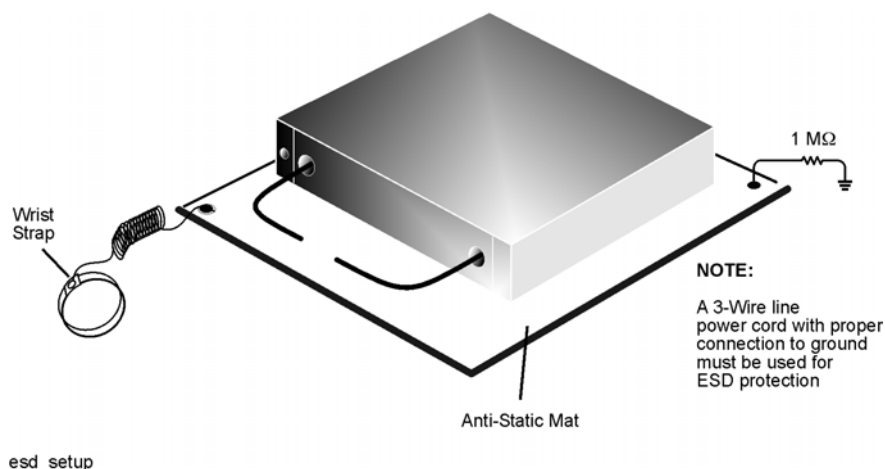

Visual Inspection

Visual inspection and, if necessary, cleaning should be done every time a connection is made. Metal particles from the connector threads may fall into the connector when it is disconnected.

CAUTION Devices with damaged connectors should be immediately discarded or clearly marked and set aside for repair. A damaged device will in turn damage any good connector to which it is attached. Determine the cause of the damage before connecting a new, undamaged connector in the same configuration.

In some cases, magnification is necessary to see damage to a connector; a magnifying device with a magnification of $\geq 10\times$ is recommended. However, not all defects that are visible only under magnification will affect the electrical performance of the connector. Use the following guidelines when evaluating the integrity of a connector.

Look for Obvious Defects and Damage First

Examine the connectors first for obvious defects or damage: badly worn plating on the connector interface, deformed threads or bent, broken, or misaligned center conductors. Connector nuts should move smoothly and be free of burrs, loose metal particles, and rough spots.

What Causes Connector Wear?

Connector wear is caused by connecting and disconnecting the devices. The more use a connector gets, the faster it wears and degrades. The wear is greatly accelerated when connectors are not kept clean, or are not connected properly.

Connector wear eventually degrades performance of the device. Calibration devices should have a long life if their use is on the order of a few times per week. Replace devices with worn connectors.

The test port connectors on the network analyzer test set may have many connections each day, and are, therefore, more subject to wear. It is recommended that an adapter be used as a test port saver to minimize the wear on the test set's test port connectors.

Inspect the Mating Plane Surfaces

Flat contact between the connectors at all points on their mating plane surfaces is required for a good connection. See [Figure 2-1 on page 2-3](#). Look especially for deep scratches or dents, and for dirt and metal particles on the connector mating plane surfaces. Also look for signs of damage due to excessive or uneven wear or misalignment.

Light burnishing of the mating plane surfaces is normal, and is evident as light scratches or shallow circular marks distributed more or less uniformly over the mating plane surface. Other small defects and cosmetic imperfections are also normal. None of these affect electrical or mechanical performance. If a connector shows deep scratches or dents, particles clinging to the mating plane surfaces, or uneven wear, clean and inspect it again.

Inspect Female Connectors

Inspect the contact fingers in the female center conductor carefully. These can be bent or broken, and damage to them is not always easy to see. A connector with damaged contact fingers will not make good electrical contact and must be replaced.

NOTE This is particularly important when mating nonprecision to precision devices.

The female connectors in this calibration kit are metrology-grade, precision slotless connectors (PSC). Precision slotless female connectors are used to improve accuracy. With PSCs on test ports and standards, the accuracy achieved when measuring at 50 dB return loss levels is comparable to using conventional slotted connectors measuring devices having only 30 dB return loss. This represents an accuracy improvement of approximately 10 times.

Conventional female center conductors are slotted and, when mated, are flared by the male pin. Because physical dimensions determine connector impedance, this change in physical dimension affects electrical performance, making it very difficult to perform precision measurements with conventional slotted female connectors.

The precision slotless connector was developed to eliminate this problem. The PSC has a center conductor with a solid cylindrical shell, the outside diameter of which does not change when mated. Instead, this center conductor has an internal contact that flexes to accept the male pin.

Cleaning Connectors

1. Use Compressed Air or Nitrogen

Clean connectors are essential for ensuring the integrity of RF and microwave coaxial connections.

WARNING **Always use protective eyewear when using compressed air or nitrogen.**

Use compressed air (or nitrogen) to loosen particles on the connector mating plane surfaces.

You can use any source of clean, dry, low-pressure compressed air or nitrogen that has an effective oil-vapor filter and liquid condensation trap placed just before the outlet hose.

Ground the hose nozzle to prevent electrostatic discharge, and set the air pressure to less than 414 kPa (60 psi) to control the velocity of the air stream. High-velocity streams of compressed air can cause electrostatic effects when directed into a connector. These electrostatic effects can damage the device. Refer to [“Electrostatic Discharge” on page 3-2](#) for additional information.

2. Clean the Connector Threads

WARNING **Keep isopropyl alcohol away from heat, sparks, and flame. Store in a tightly closed container. It is extremely flammable. In case of fire, use alcohol foam, dry chemical, or carbon dioxide; water may be ineffective.**

Use isopropyl alcohol with adequate ventilation and avoid contact with eyes, skin, and clothing. It causes skin irritation, may cause eye damage, and is harmful if swallowed or inhaled. It may be harmful if absorbed through the skin. Wash thoroughly after handling.

In case of spill, soak up with sand or earth. Flush spill area with water.

Dispose of isopropyl alcohol in accordance with all applicable federal, state, and local environmental regulations.

Use a lint-free swab or cleaning cloth moistened with isopropyl alcohol to remove any dirt or stubborn contaminants on a connector that cannot be removed with compressed air or nitrogen. Refer to [Table 6-2 on page 6-4](#) for part numbers for isopropyl alcohol and cleaning swabs.

- a. Apply a small amount of isopropyl alcohol to a lint-free cleaning swab.
- b. Clean the connector threads.

Cleaning Connectors

- c. Let the alcohol evaporate, then blow the threads dry with a gentle stream of clean, low-pressure compressed air or nitrogen. Always completely dry a connector before you reassemble or use it.

3. Clean the Mating Plane Surfaces

- a. Apply a small amount of isopropyl alcohol to a lint-free cleaning swab.
- b. Clean the center and outer conductor mating plane surfaces. Refer to [Figure 2-1 on page 2-3](#). When cleaning a female connector, avoid snagging the swab on the center conductor contact fingers by using short strokes.
- c. Let the alcohol evaporate, then blow the connector dry with a gentle stream of clean, low-pressure compressed air or nitrogen. Always completely dry a connector before you reassemble or use it.

4. Inspect the Connector

Inspect the connector to make sure that no particles or residue remain. Refer to [“Visual Inspection” on page 3-3](#).

Gaging Connectors

The gages available from Agilent Technologies are intended for preventive maintenance and troubleshooting purposes only. They are effective in detecting excessive center conductor protrusion or recession, and conductor damage on DUTs, test accessories, and the calibration kit devices. *Do not use the gages for precise pin depth measurements.*

Connector Gage Accuracy

The connector gages are only capable of performing coarse measurements. They do not provide the degree of accuracy necessary to precisely measure the pin depth of the kit devices. This is partially due to the repeatability uncertainties that are associated with the measurement. Only the factory—through special gaging processes and electrical testing—can accurately verify the mechanical characteristics of the devices.

With proper technique, the gages are useful in detecting gross pin depth errors on device connectors. To achieve maximum accuracy, random errors must be reduced by taking the average of at least three measurements having different gage orientations on the connector. Even then, the resultant average can be in error by as much as ± 0.0001 inch due to systematic (biasing) errors usually resulting from worn gages and gage masters. As the gages undergo more use, the systematic errors can become more significant in the accuracy of the measurement.

NOTE When measuring pin depth, the measured value (resultant average of three or more measurements) contains measurement uncertainty and is not necessarily the true value. Always compare the measured value with the observed pin depth limits (which account for measurement uncertainties) in [Table 2-2 on page 2-4](#) to evaluate the condition of device connectors.

When to Gage Connectors

Gage a connector at the following times:

- Prior to using a device for the first time, record the pin depth measurement so that it can be compared with future readings. This serves as a good troubleshooting tool when you suspect damage may have occurred to the device.
- If either visual inspection or electrical performance suggests that the connector interface may be out of typical range (due to wear or damage, for example).
- If a verification device is used by someone else or on another system or piece of equipment.
- Initially, after every 100 connections, and after that, as often as experience indicates.

Gaging Procedures

Gaging 2.4 mm Connectors

NOTE Always hold a connector gage by the gage barrel, below the dial indicator. This gives the best stability, and improves measurement accuracy. (Cradling the gage in your hand or holding it by the dial applies stress to the gage plunger mechanism through the dial indicator housing.)

1. Select the proper gage for your connector. The gages are intended for performing 2.4 mm pin depth measurements. Refer to [Table 6-2 on page 6-4](#) for gage part numbers.
2. Inspect and clean the gage, gage master, and device to be gaged. Refer to [“Visual Inspection”](#) and [“Cleaning Connectors”](#) earlier in this chapter.
3. Zero the connector gage (refer to [Figure 3-2](#)):
 - a. While holding the gage by the barrel, and without turning the gage or the device, connect the gage to the gage master by interconnecting the male and female connectors. Connect the nut finger tight. Do not overtighten.
 - b. Using an open-end wrench to keep the device body from rotating, use the torque wrench included in the kit to tighten the connecting nut to the specified torque. Refer to [“Final Connection Using a Torque Wrench” on page 3-14](#) for additional information.
 - c. As you watch the gage pointer, gently tap the barrel of the gage to settle the reading. The gage pointer should line up exactly with the zero mark on the gage. If not, adjust the zero set knob until the gage pointer lines up exactly with the zero mark.
 - d. Remove the gage master.
4. Gage the device connector (refer to [Figure 3-2](#)):
 - a. While holding the gage by the barrel, and without turning the gage or the device, connect the gage to the device by interconnecting the male and female connectors. Connect the nut finger-tight. Do not overtighten.
 - b. Using an open-end wrench to keep the device body from rotating, use the torque wrench included in the kit to tighten the connecting nut to the specified torque. Refer to [“Final Connection Using a Torque Wrench” on page 3-14](#) for additional information.
 - c. Gently tap the barrel of the gage with your finger to settle the gage reading.
 - d. Read the gage indicator dial. Read *only* the black \pm signs, *not* the red \pm signs.

For maximum accuracy, measure the connector a minimum of three times and take an average of the readings. After each measurement, rotate the gage a quarter-turn to reduce measurement variations that result from the gage or the connector face not being exactly perpendicular to the center axis.
 - e. Compare the average reading with the specifications listed in [Table 2-2 on page 2-4](#).
 - f. Without turning the gage or the device, remove the device from the gage.

Figure 3-2 Gaging 2.4 mm Connectors

Note:

Although male devices are shown in this illustration, the procedure is essentially the same for female devices.

Zero the Connector Gage

- Connect the gage to the gage master.
- Torque the connecting nut.
- Gently tap the gage barrel to settle the reading.
- Using the zero set knob, adjust the gage pointer to line up exactly with the zero mark.
- Remove the gage master.

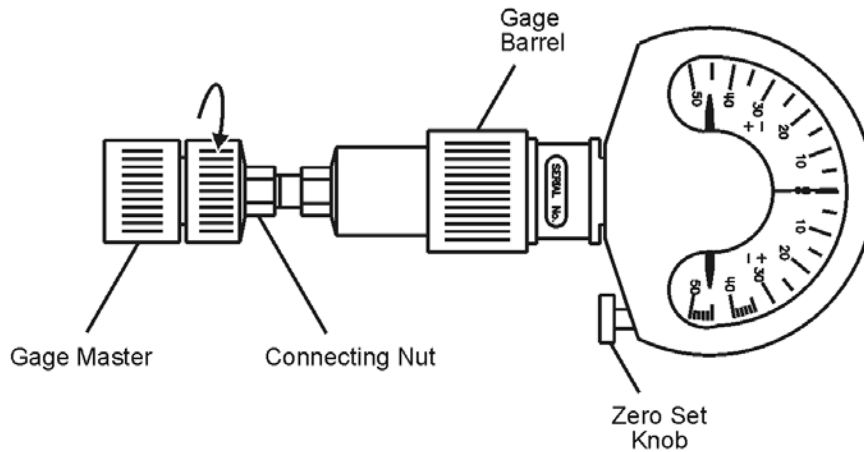

Gage the Device Connector

- Connect the gage to the device being measured.
- Torque the connecting nut.
- Gently tap the gage barrel to settle the reading.
- Read recession or protrusion from the gage.
- Remove the device.
- Repeat two additional times and average the three readings.

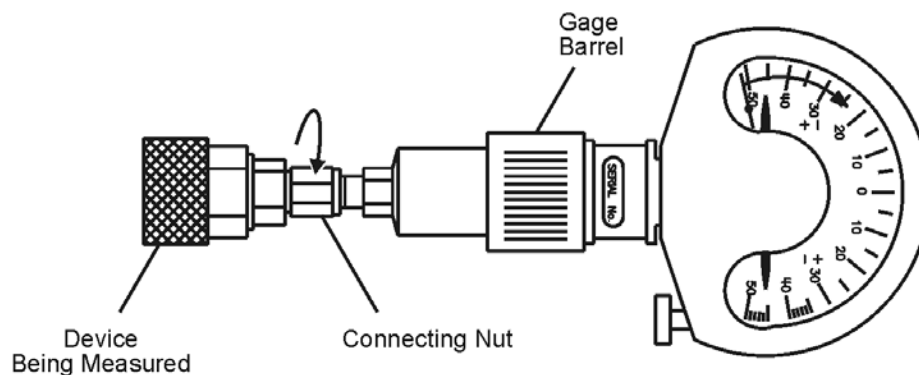

ph71e

Gaging the Airline

The airlines in this kit are measured and matched for length at the factory using special fixtures and gages. Because the gages supplied in the calibration kits do not have the accuracy of the factory gages, use the following procedure for very general results only. Perform this procedure whenever you suspect that a center conductor has been switched with another airline or that a device has been damaged.

NOTE Always hold a connector gage by the gage barrel, below the dial indicator. This gives the best stability, and improves measurement accuracy.

1. Select a male connector gage and male short for this procedure. Refer to [Table 6-2 on page 6-4](#) for part numbers.
2. Inspect and clean the mating surfaces and connector threads of the short, airline, and gage. Refer to [“Visual Inspection”](#) and [“Cleaning Connectors”](#) earlier in this chapter.
3. Zero the connector gage (refer to [Figure 3-3](#)):
 - a. While holding the gage by the barrel and without turning the gage or the short, connect the gage to the short by interconnecting the male and female connectors. Connect the nut finger tight. Do not overtighten.
 - b. Using an open-end wrench to keep the device body from rotating, use the torque wrench recommended for use with this kit to tighten the connecting nut to the specified torque. Refer to [“Final Connection Using a Torque Wrench”](#) on [page 3-14](#) for additional information.
 - c. As you watch the gage pointer, gently tap the barrel of the gage to settle the reading.
 - d. The gage pointer should line up exactly with the zero mark on the gage. If not, loosen the dial lock screw on the gage and rotate the gage dial so that the pointer is aligned with the zero mark. Tighten the dial lock screw.
 - e. Without turning the short or the gage, remove the short from the gage. Refer to [“How to Separate a Connection”](#) on [page 3-18](#).

Figure 3-3 Zeroing the Connector Gage Using the Short

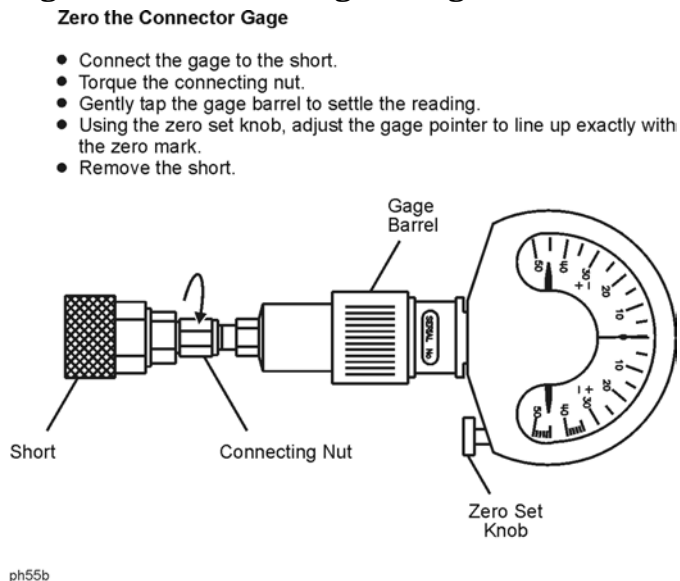

4. Assemble the airline and center conductor (refer to [Figure 3-4](#)):

CAUTION Wear gloves while performing the following steps. You will be touching the exposed center conductor of the airline. Do not transfer oil or dirt from your fingers to the center conductor. See [“Handling and Storage”](#) on page 3-18.

- a. Remove the center conductor from its plastic case. Make sure you select the correct center conductor for the airline you are connecting. Refer to [Figure 2-3](#) and [Figure 2-4](#) on page 2-6 for illustrations of both center conductors.
- b. Remove the protective end cap from the female end (the end without the connecting nut) of the outer conductor.
- c. Leave the protective end cap on the male end of the airline to prevent the center conductor from falling out of the outer conductor.
- d. Insert the center conductor into the outer conductor so that the female end of the center conductor is toward the female end of the outer conductor (the end without the connector nut). Refer to [Figure 3-4](#).

Figure 3-4 Assembling the Airline and Center Conductor

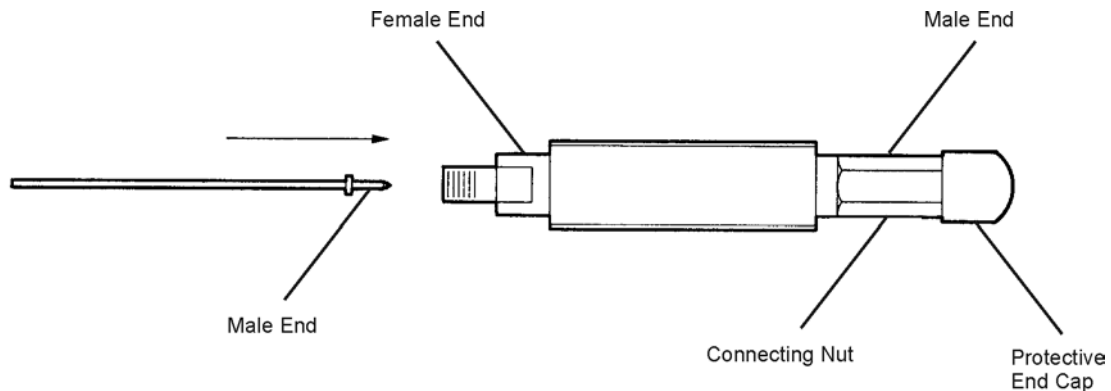

ph56b

5. Attach the short:

- a. Without turning the airline or the short, connect the airline to the short by interconnecting the male and female connectors. Connect the nut finger tight. Do not overtighten.
- b. Using an open-end wrench to keep the device body from rotating, use the torque wrench recommended for use with this kit to tighten the connecting nut to the specified torque. Refer to [“Final Connection Using a Torque Wrench”](#) on page 3-14 for additional information.
- c. Remove the protective end cap from the male end of the airline.

NOTE Do not allow either the center or outer conductor of the airline to come in contact with a metal or harder surface. The soft gold plating can be displaced, changing the pin depth and thus the performance of the airline.

- d. Carefully press the male end of the center conductor lightly against a firm flat object to seat the center conductor into the short.
6. Gage the airline (refer to [Figure 3-5](#)):
- a. While holding the gage by the barrel, and without turning the gage or the airline, connect the gage to the airline by interconnecting the male and female connectors. Connect the nut finger tight. Do not overtighten.
 - b. Using an open-end wrench to keep the device body from rotating, use the torque wrench recommended for use with this kit to tighten the connecting nut to the specified torque. Refer to [“Final Connection Using a Torque Wrench”](#) on page 3-14 for additional information.
 - c. Gently tap the barrel of the gage with your finger to settle the gage reading.

Figure 3-5 Gaging the Airline

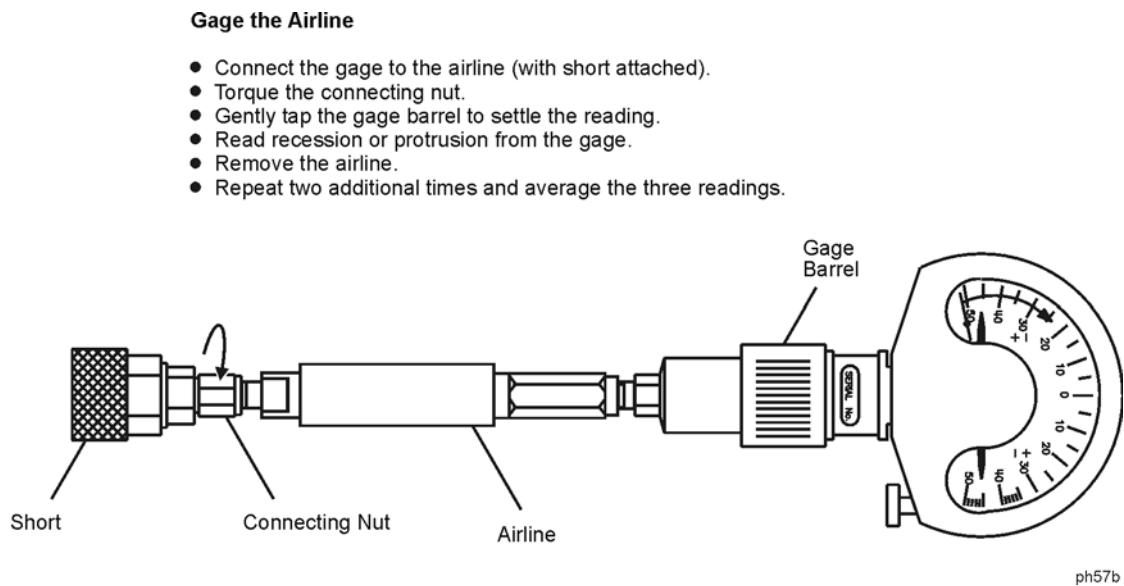

- d. Wait approximately 5 minutes for the temperature to stabilize. Do not touch the airline, short, or gage during this time as your body temperature will affect the temperature of the devices.

The gage reading should be within the pin depth specifications listed in [Table 2-2](#) on [page 2-4](#). Remember, the gage is intended for coarse measurements only and has an accuracy of ± 0.0001 in.

7. Disconnect the short and gage from the airline:

NOTE If the airline center conductor does not disengage from the device center conductor, gently pull the center conductors apart and then push the airline center conductor back inside the outer conductor of the airline.

- a. Without turning the airline or the gage, remove the gage from the airline. Refer to [“How to Separate a Connection” on page 3-18](#).
- b. Replace the protective end cap on the airline to prevent the center conductor from sliding out of the outer conductor.
- c. Without turning the airline or the short, remove the short from the airline. Refer to [“How to Separate a Connection” on page 3-18](#).
- d. If you will not be using the airline again immediately, slide the center conductor out of the outer conductor and store the center conductor in the plastic case provided.
- e. Replace the other protective end cap on the outer conductor and store the center and outer conductors in the foam lined storage case.

Connections

Good connections require a skilled operator. *The most common cause of measurement error is bad connections.* The following procedures illustrate how to make good connections.

How to Make a Connection

Preliminary Connection

1. Ground yourself and all devices. Wear a grounded wrist strap and work on a grounded, conductive table mat. Refer to “[Electrostatic Discharge](#)” on page 3-2 for ESD precautions.
2. Visually inspect the connectors. Refer to “[Visual Inspection](#)” on page 3-3.
3. If necessary, clean the connectors. Refer to “[Cleaning Connectors](#)” on page 3-5.
4. Use a connector gage to verify that all center conductors are within the pin depth values listed in [Table 2-2 on page 2-4](#). Refer to “[Gaging Connectors](#)” on page 3-7.
5. Carefully align the connectors. The male connector center pin must slip concentrically into the contact finger of the female connector.
6. Push the connectors straight together and tighten the connector nut finger tight.

CAUTION Do not turn the device body. Turn only the connector nut. Damage to the center conductor can occur if the device body is rotated.

Do not twist or screw the connectors together. As the center conductors mate, there is usually a slight resistance.

7. The preliminary connection is tight enough when the mating plane surfaces make uniform, light contact. Do not overtighten this connection.

A connection in which the outer conductors make gentle contact at all points on both mating surfaces is sufficient. Very light finger pressure is enough to accomplish this.

8. Make sure the connectors are properly supported. Relieve any side pressure on the connection from long or heavy devices or cables.

Final Connection Using a Torque Wrench

Use a torque wrench to make a final connection. [Table 3-1](#) provides information about the torque wrench recommended for use with the calibration kit. A torque wrench is not included in the calibration kit. Refer to [Table 6-2 on page 6-4](#) for part number and ordering information.

Table 3-1 Torque Wrench Information

Connector Type	Torque Setting	Torque Tolerance
2.4 mm	90 N-cm (8 in-lb)	±9.0 N-cm (±0.8 in-lb)

Using a torque wrench guarantees that the connection is not too tight, preventing possible connector damage. It also guarantees that all connections are equally tight each time.

Prevent the rotation of anything other than the connector nut that you are tightening. It may be possible to do this by hand if one of the connectors is fixed (as on a test port). However, it is recommended that you use an open-end wrench to keep the body of the device from turning.

1. Position both wrenches within 90 degrees of each other before applying force. See [Figure 3-6](#). Wrenches opposing each other (greater than 90 degrees apart) will cause a lifting action which can misalign and stress the connections of the devices involved. This is especially true when several devices are connected together.

Figure 3-6 Wrench Positions

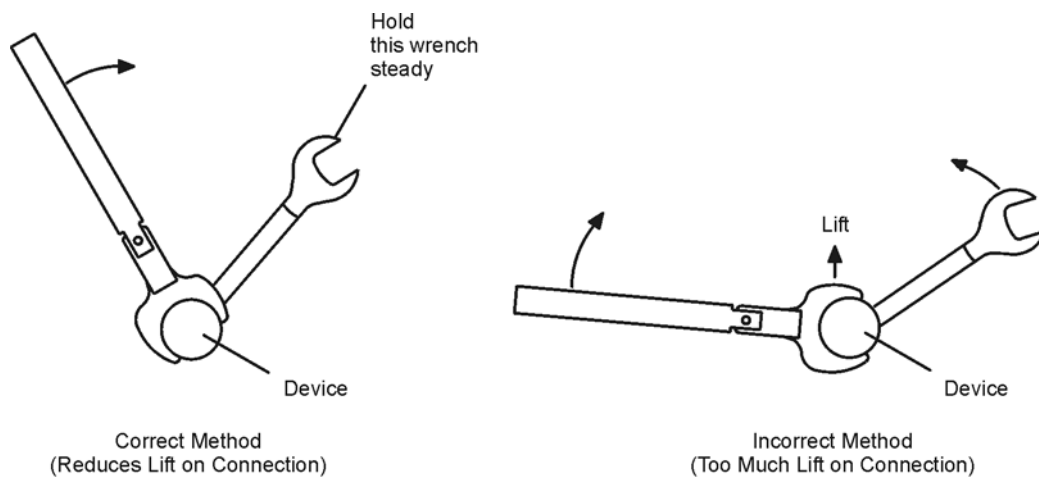

ph711a

2. Hold the torque wrench lightly, at the end of the handle only (beyond the groove). See [Figure 3-7](#).

Figure 3-7 Using the Torque Wrench

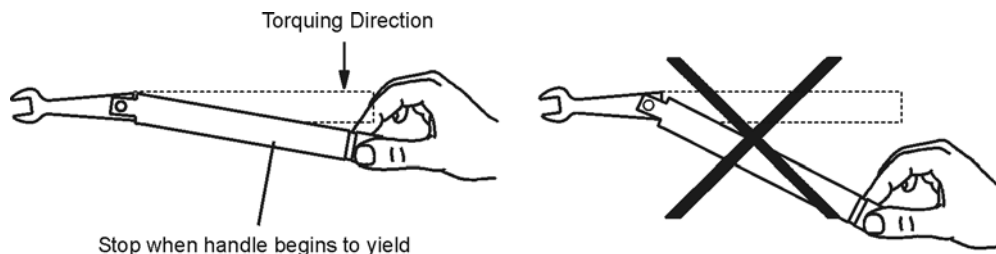

ph712a

3. Apply downward force perpendicular to the wrench handle. This applies torque to the connection through the wrench.

Do not hold the wrench so tightly that you push the handle straight down along its length rather than pivoting it, otherwise, you apply an unknown amount of torque.

CAUTION You don't have to fully break the handle of the torque wrench to reach the specified torque; doing so can cause the handle to kick back and loosen the connection. Any give at all in the handle is sufficient torque.

4. Tighten the connection just to the torque wrench break point. The wrench handle gives way at its internal pivot point. See [Figure 3-7](#). Do not tighten the connection further.

Connecting the Airline

CAUTION Before making any connections to the test set, be sure that bias power to the test set is off, and take care to avoid electrostatic discharge. Refer to [“Electrostatic Discharge”](#) on page 3-2.

CAUTION Wear gloves while performing the following procedure. You will be touching the exposed center conductor of the airline. It is important that you do not transfer oil and dirt from your fingers to this center conductors. Refer to [“Handling and Storage”](#) on page 3-18.

Before making the connection, refer to [“Preliminary Connection”](#) on page 3-14.

Cables with the appropriate adapters on the ends should be connected to PORT 1 and PORT 2 of the network analyzer.

1. Remove the center conductor from its plastic case. Make sure you select the correct center conductor for the airline you are connecting. Refer to [Figure 2-3](#) and [Figure 2-4](#) on page 2-6 for illustrations of both center conductors.
2. Remove the protective end cap from the female end (the end without the connecting nut) of the airline. Leave the protective end cap on the male end of the airline to prevent the center conductor from falling out of the outer conductor.
3. Insert the female end of the center conductor into the outer conductor so that the female end of the center conductor is toward the female end of the outer conductor (the end without the connector nut).

Figure 3-8 Airline Center Conductor Placement

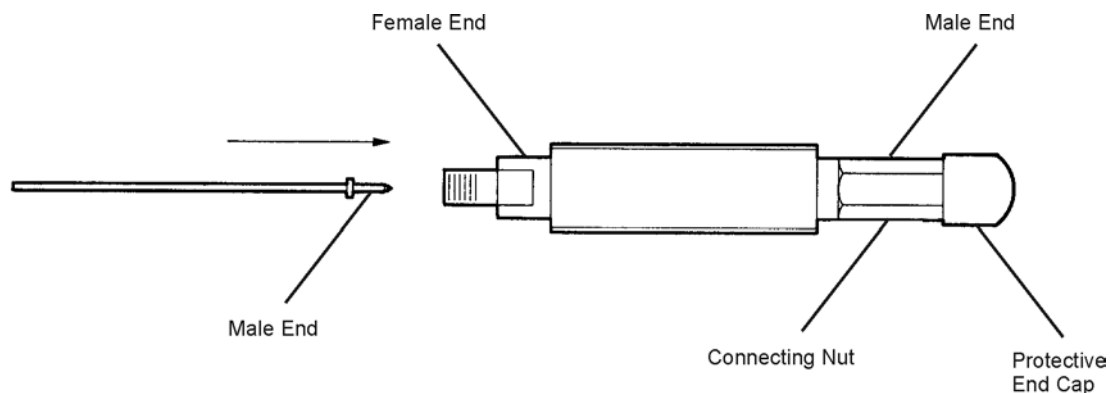

ph56b

NOTE To avoid damaging the airline center conductor, always keep it in direct line with the center conductor of the device to which it is being connected.

4. Bring the airline—with center conductor installed—toward the cable connector and mate the female end of the airline center conductor with the center conductor of the cable connector. Refer to [Figure 3-9](#).

Figure 3-9 Connecting the Airline

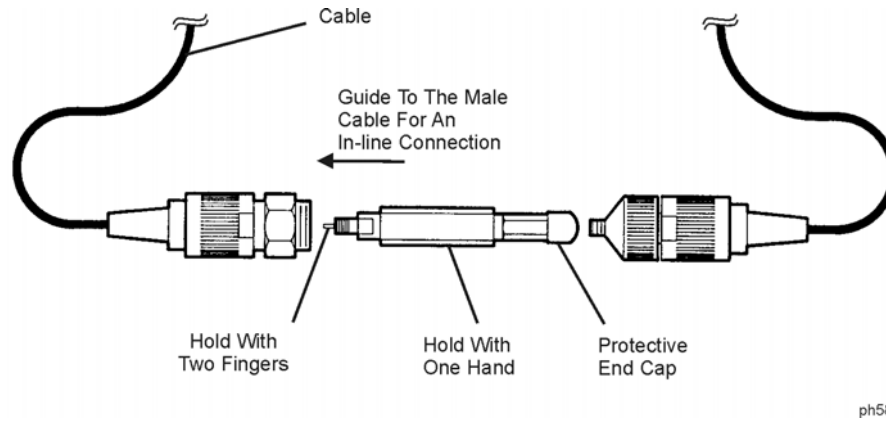

5. Push the airline's female coupling sleeve forward and turn the connecting nut (of the adapter attached to the cable) to mate the outer conductor of the airline with the adapter. Connect the nut finger tight. Do not overtighten.
6. Remove the protective end cap from the male end of the airline. Align and insert the male end of the airline center conductor into the female end of the cable adapter and mate the outer conductors. Connect the nut finger tight. Do not overtighten.
7. Using an open-end wrench, hold the sliding female coupling sleeve on the female end of the outer conductor to keep it from rotating. Refer to [Figure 3-10](#) Use the torque wrench recommended for use with this kit to tighten the adapter connecting nut to the specified torque. Refer to [“Final Connection Using a Torque Wrench”](#) on page 3-14.
8. Using an open-end wrench to keep the cable adapter from rotating, use the torque wrench recommended for use with this kit to tighten the airline male-end connecting nut to the specified torque.

Figure 3-10 Torquing the Connections

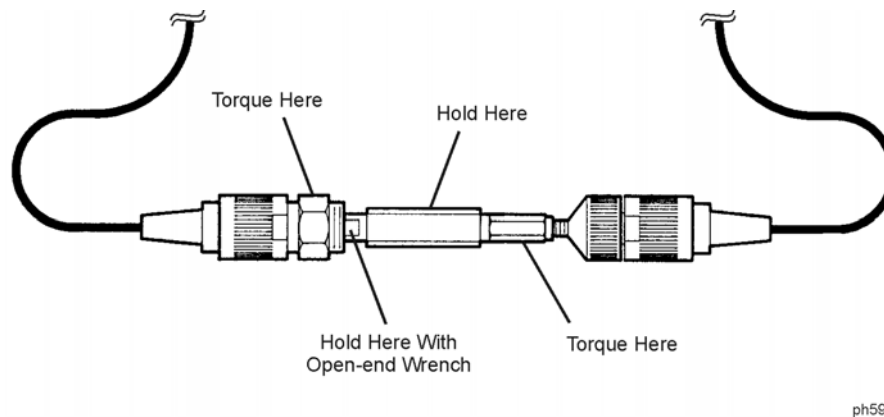

How to Separate a Connection

NOTE Do *not* turn the device body. Only turn the connector nut. Damage to the center conductor can occur if the device body is rotated.

1. Use an open-end wrench to prevent the device body from turning.
2. Use another open-end wrench to loosen the connector nut.
3. Complete the disconnection by hand, turning only the connector nut.
4. Pull the connectors straight apart without twisting, rocking, or bending either of the connectors.

NOTE If disconnecting an airline and the airline center conductor does not disengage from the device center conductor, gently pull the center conductors apart and then push the airline center conductor back inside the outer conductor of the airline.

Handling and Storage

- Do install the protective end caps and store the devices in the foam-lined storage case when not in use.
- Do keep connectors and airlines clean.
- Do *not* store connectors and airlines loose in a box, or in a desk or bench drawer. This is the most common cause of connector damage during storage.
- Do *not* touch mating plane surfaces. Natural skin oils and microscopic particles of dirt are easily transferred to a connector interface and are very difficult to remove.
- Do *not* set connectors contact-end down on a hard surface. The plating and the mating plane surfaces can be damaged if the interface comes in contact with any hard surface.

4 Performance Verification

Introduction

The performance of your verification kit can only be verified by returning the kit to Agilent Technologies for recertification. The equipment required to verify the specifications of the devices in the kit has been specially manufactured and is not commercially available.

How Agilent Verifies the Devices in Your Kit

Agilent verifies the specifications of these devices as follows:

1. The residual microwave error terms of the test system are verified with precision airlines and shorts that are directly traced to the National Institute of Standards and Technology (NIST). The airline and short characteristics are developed from mechanical measurements. The mechanical measurements and material properties are carefully modeled to give very accurate electrical representation. The mechanical measurements are then traced to NIST through various plug and ring gages and other mechanical measurements.
2. Each device is electrically tested on this system. For the initial (before sale) testing of the devices, Agilent includes the test measurement uncertainty as a guardband to guarantee each device meets the published specification. For recertifications (after sale), no guardband is used and the measured data is compared directly with the specification to determine the pass or fail status. The measurement uncertainty for each device is, however, recorded in the calibration report that accompanies recertified kits.

These two steps establish a traceable link to NIST for Agilent to the extent allowed by the institute's calibration facility. The specifications data provided for the devices in the kit is traceable to NIST through Agilent Technologies.

Recertification

The following will be provided with a recertified kit:

- a new calibration sticker affixed to the case
- a certificate of calibration
- a calibration report for each device in the kit listing measured values, specifications, and uncertainties

NOTE A list of NIST traceable numbers may be purchased upon request to be included in the calibration report.

Agilent Technologies offers a *Standard* calibration for the recertification of the kit. For more information, contact Agilent Technologies. Refer to [“Contacting Agilent” on page 5-5](#).

How Often to Recertify

The suggested initial interval for recertification is 12 months or sooner. The actual need for recertification depends on the use of the kit. After reviewing the results of the initial recertification, you may establish a different recertification interval that reflects the usage and wear of the kit.

NOTE The recertification interval should begin on the date the kit is *first used* after the recertification date.

Where to Send a Kit for Recertification

Contact Agilent Technologies for information on where to send your kit for recertification. Refer to [“Contacting Agilent” on page 5-5](#). Refer to [“Returning a Kit or Device to Agilent Technologies” on page 5-4](#) for details on sending your kit.

5 Troubleshooting

Troubleshooting Process

If your network analyzer does not pass performance verification, follow the steps in [Figure 5-1](#) to determine the cause of the failure and the correct action to take to correct the failure.

Figure 5-1 Troubleshooting Flowchart

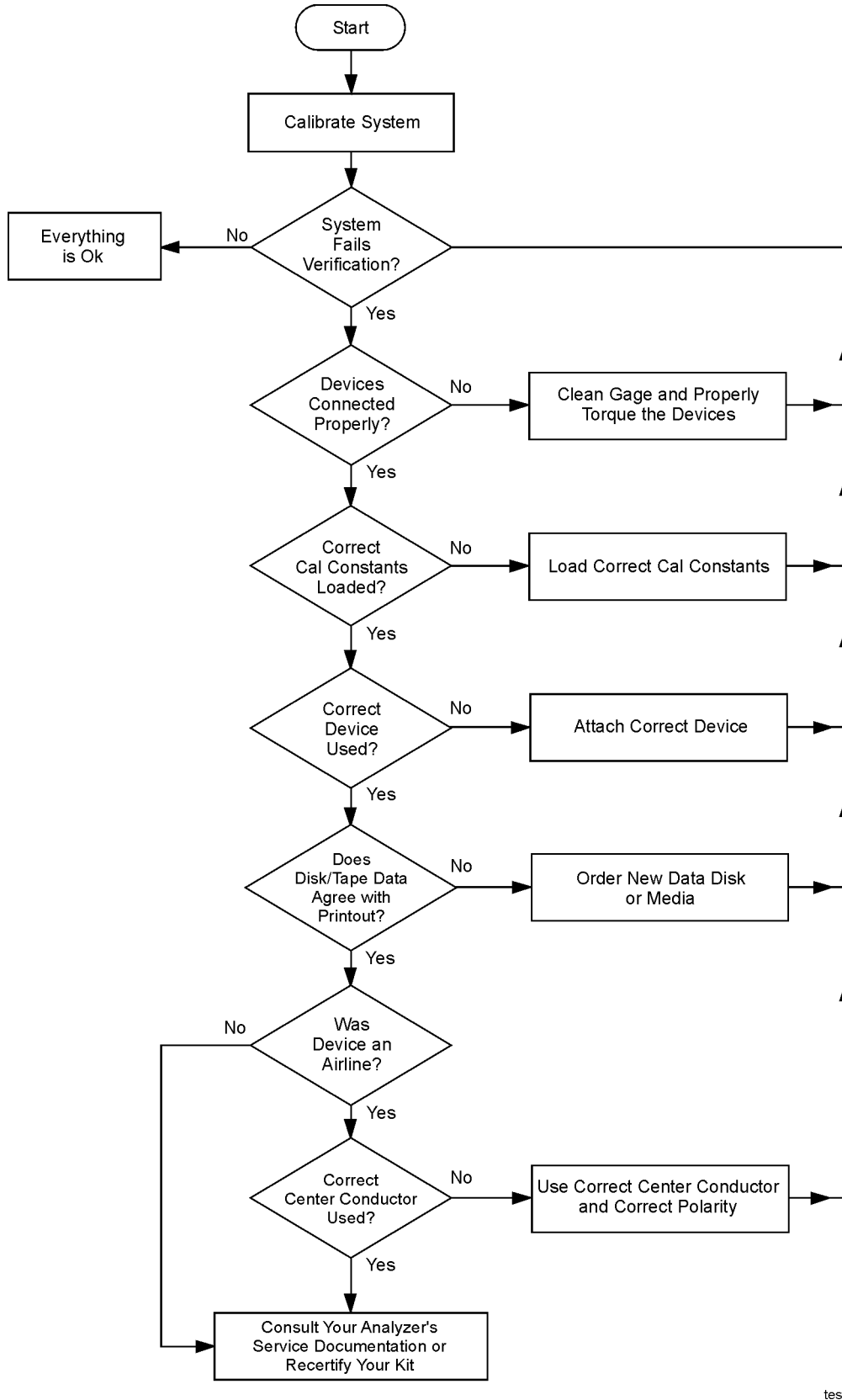

Returning a Kit or Device to Agilent Technologies

If your kit or device requires service, contact Agilent Technologies for information on where to send it. See “[Contacting Agilent](#)” on page 5-5 for information. Include a service tag (located at the back of this manual) on which you provide the following information:

- your company name and address
- a technical contact person within your company, and the person's complete telephone number including country code and area code
- the model number and serial number of the kit (if returning a complete kit)
- the part number and serial number of each device being returned
- the type of service required
- a *detailed* description of the problem (if applicable) and how the device was being used when the problem occurred

Contacting Agilent

Online assistance: www.agilent.com/find/assist			
Americas			
Brazil (tel) (+55) 11 3351 7012 (fax) (+55) 11 3351 7024	Canada (tel) +1 877 894 4414 (alt) +1 303 662 3369 (fax) +1 800 746 4866	Mexico (tel) 1800 254 2440 Ext 2703 (alt) from USA 18008374039 (fax) 1 800 254 422	United States (tel) 800 829 4444 (alt) (+1) 303 662 3998 (fax) 800 829 4433
Asia Pacific and Japan			
Australia (tel) 1 800 225 574 (fax) 1 800 681 776 (fax) 1 800 225 539	China (tel) 800 810 0189 (fax) 800 820 2816	Hong Kong (tel) 800 933 229 (fax) 800 900 701	India (tel) 1600 112 626 (alt) +65 6275 0800 (fax) 1600 113 040
Japan (Bench) (tel) 0120 421 345 (alt) (+81) 426 56 7832 (fax) 0120 01 2144	Japan (On-Site) (tel) 0120 421 345 (alt) (+81) 426 56 7832 (fax) 0120 012 114	Malaysia (tel) 1800 880 399 (fax) 1800 801 054	New Zealand (tel) +64 4 939 0635 (alt) 0800 738 378 (fax) +64 4 972 5364
Singapore (tel) 1 800 275 0880 (fax) (+65) 6755 1214	South Korea (tel) 080 778 0011 (fax) 080 778 0013	Taiwan (tel) 0800 047 669 (fax) 0800 047 667 (fax) +886 3492 0779	Thailand (tel) +66 2 267 5913 (tel) 1 800 2758 5822 (fax) 1 800 653 336
Europe			
Austria (tel) 0820 87 44 11* (fax) 0820 87 44 22	Belgium (tel) (+32) (0)2 404 9340 (fax) (+32) (0)2 404 9395	Denmark (tel) (+45) 7013 1515 (fax) (+45) 7013 1555	Finland (tel) (+358) (0) 10 855 2100 (fax) (+358) (0) 10 855 2923
France (tel) 0825 010 700* (fax) 0825 010 701*	Germany (tel) 01805 24 6333* (fax) 01805 24 6336*	Ireland (tel) (+353) 1 890 924 204 (fax) 1 890 924 024	Israel (tel) (+972) 3 9288 504 (alt) (+972) 3 9288 544 (fax) (+972) 3 9288 520
Italy (tel) (+39) (0)2 9260 8484 (fax) (+39) (0)2 9544 1175	Luxemburg (tel) (+32) (0)2 404 9340 (fax) (+32) (0)2 404 9395	Netherlands (tel) (+31) (0)20 547 2111 (fax) (+31) (0)20 547 2190	Russia (tel) (+7) 095 797 3963 (alt) (+7) 095 797 3900 (fax) (+7) 095 797 3901
Spain (tel) (+34) 91 631 3300 (fax) (+34) 91 631 3301	Sweden (tel) 0200 88 22 55* (alt) (+46) (0)8 5064 8686 (fax) 020 120 2266*	Switzerland (French) (tel) 0800 80 5353 opt. 2* (fax) (0) 22 567 5313	Switzerland (German) (tel) 0800 80 5353 opt. 1* (fax) 0 44 272 7373
Switzerland (Italian) (tel) 0800 80 5353 opt. 3* (fax) (0) 22 567 5314	United Kingdom (tel) (+44) (0)7004 666666 (fax) (+44) (0)7004 444555		
(tel) = primary telephone number; (alt) = alternate telephone number; (fax) = FAX number; * = in country number 8/10/05			

6 Replaceable Parts

Introduction

Table 6-1 lists the replacement part numbers for items included in the 85057B verification kit and Figure 6-1 illustrates the attenuators and airlines.

Table 6-2 lists the replacement part numbers for items not included in the verification kit that are either required or recommended for successful operation of the kit.

To order a listed part, note the description, the part number, and the quantity desired. Telephone or send your order to Agilent Technologies. See “Contacting Agilent” on page 5-5.

Table 6-1 Replaceable Parts for the 85057B 2.4 mm Verification Kit

Description	Qty Per Kit	Agilent Part Number
Attenuators		
20 dB attenuator with data	1	85057-60010
40 dB attenuator with data	1	85057-60011
Airlines		
50Ω airline with data	1	85057-60008
25Ω mismatch airline with data	1	85057-60009
Miscellaneous Items		
Storage box assembly	1	85057-60003
User's and service guide ^a	1	85057-90015
Verification data disk (8510)	1	85057-60012
Verification data disk (8719, 8720, and 8722 Series)	1	85057-60014
Verification data disk (PNA Series)	1	85057-10005

a. Refer to See “Printing Copies of This Document” on page iii.

Figure 6-1 Component Identification Sheet for the 85057B



50 Ω Airline

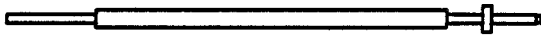

25 Ω Mismatch Airline

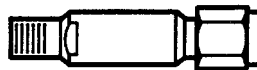

20 dB Attenuator

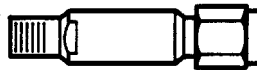

40 dB Attenuator

Not Shown:

- Verification data disks
- User's and service guide
- Storage case

ph510b

Table 6-2 Items Not Included in the Verification Kit

Description	Qty	Agilent Part Number
Connector Gages (2.4 mm)		
Male connector gage set ^a	1	11752-60108
Female connector gage set ^a	1	11752-60107
Short (for gaging airlines) ^a	1	85056-60020
Wrenches		
20 mm, 90N-cm (8 in-lb) torque	1	8710-1764
5/16 in, 90N-cm (8 in-lb) torque ^a	1	8710-1765
5/16 in, open-end wrench	1	8720-0015
Spanner wrench	1	08513-20014
ESD Protection Devices		
Grounding wrist strap	1	9300-1367
5 ft grounding cord for wrist strap	1	9300-0980
2 x 4 ft conductive table mat and 15 ft ground wire	1	9300-0797
ESD heel strap (for conductive floors)	1	9300-1308
Connector Cleaning Supplies		
Isopropyl alcohol	30 ml	8500-5344
Cleaning swabs	100	9301-1243

a. Included in the 85056A 2.4 mm Calibration Kit.

A

Agilent Technologies
 contacting, 5-5
 warranty, ii
agreements
 customer assistance, ii
 warranty, ii
airline, 2-6
 assembling, 3-11, 3-16
 attaching the short, 3-11
 characteristics, 2-5
 connecting, 3-16
 dimensions, 2-5
 center conductor, 2-6
 outer conductor, 2-5
 disconnecting, 3-18
 gaging, 3-10, 3-12
 mechanical characteristics, 2-5
 mismatch, 2-6
 part numbers, 6-2
alcohol, isopropyl
 as cleaning solvent, 3-5
 precautions for use of, 3-5
altitude, specifications, 2-2
assistance
 contacting agilent, 5-4
 who to contact, ii
attenuator, part numbers, 6-2

B

box, part number, 6-2

C

calibration
 bad, 5-2
 certificate of, 4-3
 kits, intended to be used, 1-2
 report, 4-3
 standard, 4-3
 temperature, 2-2
case
 storage, part number, 6-2
center conductor, 2-6
certificate of calibration, 4-3
characteristics
 mechanical, 2-3
 supplemental, 2-3, 2-4
cleaning connectors, 3-5
compatible analyzers, 1-2
compressed air or nitrogen, 3-5
conductive table mat
 for ESD protection, 3-2
 part number, 6-4
conductor, mating plane, 2-3
connections, 3-2, 3-14
 airline, 3-16

ESD protection, 3-14
 final, 3-14
 preliminary, 3-14
 separating, 3-18
 using torque wrench, 3-14
connector
 cleaning, 3-5
 conventional, 3-4
 damage, 3-3
 defects, 3-3
 female, 3-4
 gage
 accuracy, 3-7
 handling, 3-7, 3-8, 3-10
 part numbers, 6-4
 use of, 3-7
 zeroing, 3-7, 3-8, 3-10
 gaging, 3-7, 3-8
 procedure, 3-8
 to determine pin depth, 3-7
 when to do, 3-7
 mating plane surfaces, 2-3, 3-6
 cleaning, 3-6
 pin depth, 2-3
 sex, clarifying, 1-5
 slotless, accuracy, 3-4
 slotted, accuracy, 3-4
 threads
 cleaning, 3-5
 inspecting, 3-3
 visual inspection, 3-3
 wear
 affect on electrical
 performance, 3-3
contacting Agilent Technologies,
 5-5
contents
 drawing of, 6-3
 verification kit, 6-3
cord
 grounding, part number, 6-4

D

damage
 device, 3-3
 electrostatic discharge, 3-2
 inspecting for, 1-3, 3-3
 to connectors, 3-3
 what to do, 1-3
damaged connectors, 3-3
data, recertification, 4-3
defective connectors, 3-3
defects, connector, 3-3
device
 compatible analyzers, 1-2
 conductor, mating plane, 2-3
 connecting, 3-14

damage, 3-3
disconnecting, 3-18
handling, 3-18
maintenance, 1-5
performance, verifying, 4-2
pin depth, 2-3
specifications, 2-7
 traceability, 4-2, 4-3
storage, 3-18
temperature, 2-2
visual inspection, 3-3
dimensions
 airline, 2-3, 2-5
 center conductor, 2-6
 outer conductor, 2-5
disconnections, 3-18
documentation, part number, 6-2,
 6-4

E

electrical specifications, 2-7
electrostatic discharge, *See* ESD
environmental
 regulations, 3-5
 requirements, 2-2
 specifications, 2-2
equipment required, 1-3
ESD, 3-2
 precautions, 3-2, 3-5
 protection setup, 3-2
 supplies, part numbers, 6-4
exclusive remedies, ii

F

female connectors
 inspection of, 3-4
flowchart, troubleshooting, 5-3
frequency range, 1-2

G

gage
 connector
 handling, 3-8, 3-10
 part numbers, 6-4
 zeroing using short, 3-10
 zeroing, 3-8
gaging
 airline, 3-10, 3-12
 connectors, 3-7, 3-8
 when to do, 3-7
 to determine pin depth, 3-7
 grounding cord, part number, 6-4

H

handling, 3-18
heel strap

for ESD protection, 3-2
part number, 6-4
humidity, specifications, 2-2

I

incoming inspection, 1-3
inspection
 damage, 3-3
 defects, 3-3
 female connectors, 3-4
 incoming, 1-3
 mating plane surfaces, 3-3
 visual, 3-3
isopropyl alcohol
 as cleaning solvent, 3-5
 part number, 6-4
 precautions for use of, 3-5

K

kit
 calibration
 intended to be used, 1-2
 contents, 1-2, 6-3
 drawing of, 6-3
 frequency range, 1-2
 misuse of, ii
 overview, 1-2
 performance
 how Agilent verifies, 4-2
 warranty, ii

L

liability, ii

M

maintenance, 3-2
 of devices, 1-4
 preventive, 1-4
making connections, 3-14
 ESD protection, 3-14
 precautions, 3-14
mat
 conductive, part number, 6-4
 for ESD protection, 3-2
mating plane
 conductor, 2-3
 surfaces
 cleaning, 3-6
 connector, 3-6
 inspection of, 3-3
mechanical characteristics, 2-3
 verifying, 3-7
mechanical integrity, 2-3
mismatch airline, 2-6
misuse of product, ii
modification, unauthorized, ii

N

National Institute of Standards
and Technology (NIST), 2-7,
4-2
nitrogen, for cleaning, 3-5
numbers
 replaceable parts, 6-2
 serial, recording, 1-3

O

open-end wrench, 3-18
 part number, 6-4
 using, 3-17
ordering parts, 6-2

P

parts
 included in kit, 6-2
 not included in kit, 6-4
performance verification, failure,
5-2
pin depth, 2-3
 definition of, 2-3
 gaging to determine, 3-7
 observed limits, 3-7
 protrusion, 2-3
 recession, 2-3
precision slotless connector (PSC),
3-4
preventive maintenance, 1-4
protrusion, pin depth, 2-3

R

recertification
 how to order, 4-3
 interval, 4-3
 location, 4-3
 services included, 4-3
recession, pin depth, 2-3
regulations, environmental, 3-5
remedies, exclusive, ii
replaceable parts, 6-2, 6-3
 drawing of, 6-3
report, calibration, 4-3
requirements, environmental, 2-2
return
 kit or device to Agilent, 5-4

S

separating connections, 3-18
serial numbers
 devices, 1-3
 recording, 1-3
service tag, 5-4
servicing, 5-4

shipment, verifying complete, 1-3
short
 attaching to airline, 3-11
 using to zero gage, 3-10
slotless connector, 3-4
slotted connector, 3-4
specifications, 2-2
 airline, 2-5
 device, 2-7
 electrical, 2-7
 environmental, 2-2
 mechanical, 2-3
 temperature, 2-2
 torque wrench, 3-14
 traceability, 4-2, 4-3
standard calibration, 4-3
standards
 National Institute of Standards
 and Technology (NIST), 4-2
static discharge, *See* ESD
storage, 3-18
storage case, part number, 6-2
strap
 heel and wrist, part number, 6-4
supplemental characteristics, 2-3,
2-4

T

table mat
 for ESD protection, 3-2
tag, service, 5-4
temperature
 affect on electrical performance,
2-2
 environmental requirements,
2-2
 specifications, 2-2
 what to watch out for, 2-2
test data, 4-3
threads, connector
 cleaning, 3-5
 inspecting, 3-3
torque wrench
 part number, 6-4
 specifications, 3-14
traceability
 of device specifications, 4-2, 4-3
troubleshooting, 5-2
 flowchart, 5-3

V

verification kit
 contents, 1-2, 6-3
 drawing of, 6-3
 frequency range, 1-2
 overview, 1-2
 performance

Index

how Agilent verifies, [4-2](#)
warranty, [ii](#)
visual inspection, [3-3](#)

W

warranty, [ii](#)
wear, connector, [3-3](#)
 affect on electrical performance,
 [3-3](#)
wrench
 open-end, [3-15](#), [3-18](#)
 part number, [6-4](#)
 proper positioning of, [3-15](#)
 torque, [3-14](#), [3-15](#)
 part number, [6-4](#)
 precautions for use of, [3-15](#)
 proper use of, [3-15](#)
wrist strap
 for ESD protection, [3-2](#)
 part number, [6-4](#)

Z

zeroing
 connector gage, [3-8](#)
 using short, [3-10](#)