



Agilent 81133A/81134A Pulse Generator

## **User's Guide**



**Agilent Technologies**

## Important Notice

© Agilent Technologies, Inc. 2008

### Manual Part Number

5988-7401EN

### Revision

September 2008

Printed in Germany

Agilent Technologies  
Herrenberger Straße 130  
D-71034 Böblingen  
Germany

### Warranty

The material contained in this document is provided "as is," and is subject to being changed, without notice, in future editions. Further, to the maximum extent permitted by applicable law, Agilent disclaims all warranties, either express or implied, with regard to this manual and any information contained herein, including but not limited to the implied warranties of merchantability and fitness for a particular purpose. Agilent shall not be liable for errors or for incidental or consequential damages in connection with the furnishing, use, or performance of this document or of any information contained herein. Should Agilent and the user have a separate written agreement with warranty terms covering the material in this document that conflict with these terms, the warranty terms in the separate agreement shall control.

### Technology Licenses

The hardware and/or software described in this document are furnished under a license and may be used or copied only in accordance with the terms of such license.

### Restricted Rights Legend

If software is for use in the performance of a U.S. Government prime contract or subcontract, Software is delivered and licensed as "Commercial computer software" as defined in DFAR 252.227-7014 (June 1995), or as a "commercial item" as defined in FAR 2.101(a) or as "Restricted computer software" as defined in FAR 52.227-19 (June 1987) or any equivalent agency regulation or contract clause. Use, duplication or disclosure of Software is subject to Agilent Technologies' standard commercial license terms, and non-DOD Departments and Agencies of the U.S. Government will receive no greater than Restricted Rights as defined in FAR 52.227-19(c)(1-2) (June 1987). U.S. Government users will receive no greater than Limited Rights as defined in FAR 52.227-14 (June 1987) or DFAR 252.227-7015 (b)(2) (November 1995), as applicable in any technical data.

### Safety Notices

#### CAUTION

A CAUTION notice denotes a hazard. It calls attention to an operating procedure, practice, or the like that, if not correctly performed or adhered to, could result in damage to the product or loss of important data. Do not proceed beyond a CAUTION notice until the indicated conditions are fully understood and met.

#### WARNING

A WARNING notice denotes a hazard. It calls attention to an operating procedure, practice, or the like that, if not correctly performed or adhered to, could result in personal injury or death. Do not proceed beyond a WARNING notice until the indicated conditions are fully understood and met.

# Contents

<b>Safety Requirements</b>	<b>7</b>
<hr/>	
Safety Summary	7
Environmental Conditions	7
Before Applying Power	8
Ground the Instrument	8
Do not Operate in an Explosive Atmosphere	8
Do not Remove the Instrument Cover	8
Initial Inspection	9
Power Requirements	10
Performance Requirements	10
Ventilation Requirements	10
Cleaning Recommendation	11
Declaration of Conformity	12
<b>Introduction to the Agilent 81133A/81134A Pulse Generator</b>	<b>13</b>
<hr/>	
Benefits and Key Features	14
Front Panel Overview	15
Input and Outputs	16
Rear Panel Overview	18
<b>Operating the Agilent 81133A/81134A Pulse Generator</b>	<b>19</b>
<hr/>	
Navigation through the Pages	20
How to Navigate through the Parameters at one Page	21
How to Select a Parameter from a Selection List	21
How to Change a Number Field	23
<b>Setting Up Generic and Advanced Signals</b>	<b>27</b>
<hr/>	
Setting Up a Clock Signal	28
Using the Graphical User Interface	29
Using the Remote Programming Interfaces	35
Setting Up a Pulse Signal	36

Using the Graphical User Interface	36
Using the Remote Programming Interfaces	39
<b>Setting Up a Data Pattern</b>	<b>40</b>
Using the Graphical User Interface	40
Using the Remote Programming Interfaces	45
<b>Setting Up a Burst Signal</b>	<b>46</b>
Using the Graphical User Interface	46
Using the Remote Programming Interfaces	51
<b>Setting Up a Repetitive Burst Signal</b>	<b>52</b>
Using the Graphical User Interface	52
Using the Remote Programming Interfaces	57
<b>Setting Up Signals for a Stressed Eye Diagram Measurement</b>	<b>58</b>
Connecting the Instruments	59
Setting Up the 81134A by Using the Graphical User Interface	60
Setting Up the 33250A Waveform Generator	63
Viewing the Eye Diagram on the 86100 DCA	63
Play with the Settings	64
<b>Using the Agilent 81133A/81134A Pulse Generator</b>	<b>65</b>
<hr/>	
<b>Pages of the User Interface</b>	<b>66</b>
<b>Combining Parameters for Signal Generation</b>	<b>68</b>
Instrument Modes	68
Pattern Modes	70
Signal Modes	71
Variable Crossover	72
Clock Sources	73
Start Mode	75
Trigger Out	75
<b>Timing of Generated Signals</b>	<b>76</b>
Clock	77
Pulses	78
Data Pattern	79
PRBS	80
Started Burst	81
Repetitive Burst	82
<b>Jitter Modulation</b>	<b>83</b>

Saving and Recalling Settings	83
Updating the Firmware	85
<hr/>	
Troubleshooting	87
<hr/>	
Index	89
<hr/>	



# Safety Requirements

The following general safety precautions must be observed during all phases of operation of this instrument. Failure to comply with these precautions or with specific warnings elsewhere in this manual violates safety standards of design, manufacture, and intended use of the instrument.

Agilent Technologies Inc. assumes no liability for the customer's failure to comply with these requirements.

Before operation, review the instrument and manual for safety markings and instructions. You must follow these to ensure safe operation and to maintain the instrument in safe condition.

## Safety Summary

This product is a Safety Class 1 instrument (provided with a protective earth terminal). The protective features of this product may be impaired if it is used in a manner not specified in the operation instructions.

All Light Emitting Diodes (LEDs) used in this product are Class 1 LEDs as per IEC 60825-1.

## Environmental Conditions

This instrument is intended for indoor use in an installation category II, pollution degree 2 environment. It is designed to operate within an operating temperature range of 0 – 55 °C (32 – 130 °F) at a maximum relative humidity of 95% and at altitudes of up to 2000 meters.

Refer to the specifications tables for the ac mains voltage requirements and ambient operating temperature range.

## Before Applying Power

Verify that all safety precautions are taken.

The power cable inlet of the instrument is used to disconnect the instrument from the mains in case of hazard. The instrument must be positioned so that the operator can easily access the power cable inlet.

When the instrument is mounted in a rack, the rack must be provided with an easily accessible mains switch.

## Ground the Instrument

To minimize shock hazard, the instrument chassis and cover must be connected to an electrical protective earth ground. The instrument must be connected to the ac power mains through a grounded power cable, with the ground wire firmly connected to an electrical ground (safety ground) at the power outlet. Any interruption of the protective (grounding) conductor or disconnection of the protective earth terminal will cause a potential shock hazard that could result in personal injury.

## Do not Operate in an Explosive Atmosphere

Do not operate the instrument in the presence of flammable gases or fumes.

## Do not Remove the Instrument Cover

Operating personnel must not remove instrument covers. Component replacement and internal adjustments must be made only by qualified personnel.

Instruments that appear damaged or defective should be made inoperative and secured against unintended operation until they can be repaired by qualified service personnel.



# Initial Inspection

Inspect the shipping container for damage. If the container or cushioning material is damaged, keep it until the contents of the shipment have been checked for completeness and the instrument has been verified both mechanically and electrically.

**WARNING**

To avoid hazardous electric shock, do not perform electrical tests when there are signs of shipping damage to any part of the instrument's outer covers or panels.

Check if the Agilent 81133A or 81134A shipping container contains the following standard deliverables:

- The Agilent 81133A or 81134A Pulse Generator
- The Getting Started Brochure and the Product CD
- The Agilent IO Libraries Suite on CD with Quick Start Sheet, which shows how to connect the instrument to a PC running the Agilent IO Libraries Suite
- A power cable
- A USB cable

If the contents are incomplete, if there is mechanical damage, or if the instrument does not work within its specifications, notify the nearest Agilent office. The Agilent office will arrange for repair or replacement without awaiting settlement.

# Power Requirements

**NOTE** When the front panel switch is off, the instrument is in “standby” mode. The instrument is disconnected from the AC line power only by disconnecting the power cord.

The instrument can operate from any single-phase AC power source supplying 100 – 240 V in the frequency range from 47 – 63 Hz. The maximum power consumption is 200 VA with all options installed. When the instrument is switched on the power supply adapts automatically to the applied AC power (Auto Selection) and monitors the AC power range during operation.

# Performance Requirements

For best performance of data transfer and for EMC compliance use an Agilent 82357-61601 Mini-USB cable only.

# Ventilation Requirements

Make sure that there is adequate clearance of 50 mm (2 in) at the top and right side to ensure adequate air flow. If the air flow is restricted, the internal operating temperature will be higher, reducing the instrument's reliability.

**NOTE** Do not cover the ventilation holes.

# Cleaning Recommendation

Use a dry cloth or one slightly dampened with water to clean external case parts. Do not attempt to clean internally.

**WARNING**

To prevent electrical shock, disconnect the instrument from mains before cleaning.

# Declaration of Conformity

## DECLARATION OF CONFORMITY

According to ISO/IEC Guide 22 and CEN/CENELEC EN 45014



**Manufacturer's Name:** Agilent Technologies Deutschland GmbH  
**Manufacturer's Address:** Boeblingen Verifications Solutions (BVS)  
 Herrenberger Str. 130  
 D-71034 Boeblingen

### Declares, that the product

**Product Name:** 3.35 GHz Pulse Generator  
**Model Numbers:** 81133A Single Channel Pulse Generator  
 81134A Dual Channel Pulse Generator  
**Product Options:** This declaration covers all options of the above products.

### Conforms with the following European Directives:

The product herewith complies with the requirements of the Low Voltage Directive 73/23/EEC and the EMC Directive 89/336/EEC (including 93/68/EEC) and carries the CE Marking accordingly.

### Conforms with the following product standards:

	Standard	Limit
<b>EMC</b>	IEC 61326-1:1997+A1:1998 / EN 61326-1:1997+A1:1998	
	CISPR 11:1997 / EN 55011:1998	Group 1 Class A
	IEC 61000-4-2:1995 / EN 61000-4-2:1995	4 kV CD, 8 kV AD
	IEC 61000-4-3:1995 / EN 61000-4-3:1995+A1:1998	3 V/m, 80-1000 MHz
	IEC 61000-4-4:1995 / EN 61000-4-4:1995	0.5 kV signal lines, 1 kV power lines
	IEC 61000-4-5:1995 / EN 61000-4-5:1995	0.5 kV line-line, 1 kV line-ground
	IEC 61000-4-6:1996 / EN 61000-4-6:1996	3 V, 0.15-80 MHz
	IEC 61000-4-8:1993 / EN 61000-4-8:1993	30 A/m
	IEC 61000-4-11:1994 / EN 61000-4-11:1994	1 cycle/100%
		Canada: ICES-001:1998
	Australia/New Zealand: AS/NZS 2064.1	
<b>Safety</b>	IEC 61010-1:2001 / EN 61010-1:2001	
	Canada: CSA C22.2 No. 1010.1:1992	
	USA: UL 3111-1:1994	

### Supplemental Information:

The products were tested in a typical configuration with Agilent Technologies test systems.

2002-August-01

Date

  
 Hans-Martin Fischer  
 Name

Product Regulations Engineer

Title

For further information, please contact your local Agilent Technologies sales office, agent or distributor.  
 Authorized EU-representative: Agilent Technologies Deutschland GmbH, Herrenberger Strasse 130, D-71034 Boeblingen, Germany



# Introduction to the Agilent 81133A/81134A Pulse Generator

The Agilent 81133A and 81134A Pulse/Pattern Generators are high-end, easy-to-use tools for generating pulses, patterns and data at speeds up to 3.35 GHz. They are ideal instruments for testing logic devices (for example, ECL, LVDS, LVPECL) and other digital devices with clock rates from 15 MHz to 3.35 GHz.

You can use the Pulse Generators for applications where timing and performance are critical and full control over signal jitter is required. The instruments are ideal data and pattern sources for eye diagram measurements.

# Benefits and Key Features

Your advantages are:

- **Fast rise times, low jitter and full parameter flexibility**

When timing is critical, the 81133A/81134A's fast rise times, the low jitter and full parameter flexibility make it an ideal pulse, clock and data source.

- **PRBS from  $2^5-1$  ...  $2^{31}-1$**

You can evaluate the performance of a device in eye diagram measurements with PRBS from  $2^5-1$  ...  $2^{31}-1$ .

- **Full signal manipulation**

You can add jitter to clock or data signals with the *Delay Control Input* and deform the eye with the *Variable Crossover* feature.

- **Predefined levels**

You can use the predefined levels to easily set up channels for commonly used logic families. These are: ECL, LVPECL, LVDS.

- **Data can be 8 kB of pattern memory**

You can create large data patterns with 8 kB of pattern memory.

## Key Features Overview

The key features are:

Frequency Range	15 MHz – 3.35 GHz
Clock Jitter	< 2 ps RMS
Voltage Amplitude	50 mV ... 2.00 V
PRBS	$2^5-1$ ... $2^{31}-1$
Transition Times 20% - 80%	< 50 ps
(10% - 90%)	(< 80 ps)
Delay Modulation Range (Jitter)	$\pm 250$ ps, $\pm 25$ ps selectable
Data	8 kBit memory, RZ, NRZ, Burst Capability
Delay Range	-5 ns ... 230 ns
Frequency Divider	1, 2, 4, ... 128

**Frequency Divider** The frequency of the output signals must always be  $> 15$  MHz. This limits the available range for the frequency divider (for example, for a 32 MHz signal, for the frequency divider, 2 (= 16 MHz) is available, but not 4 (= 8 MHz)).

## Front Panel Overview

The following figure shows the main elements of the front panel.

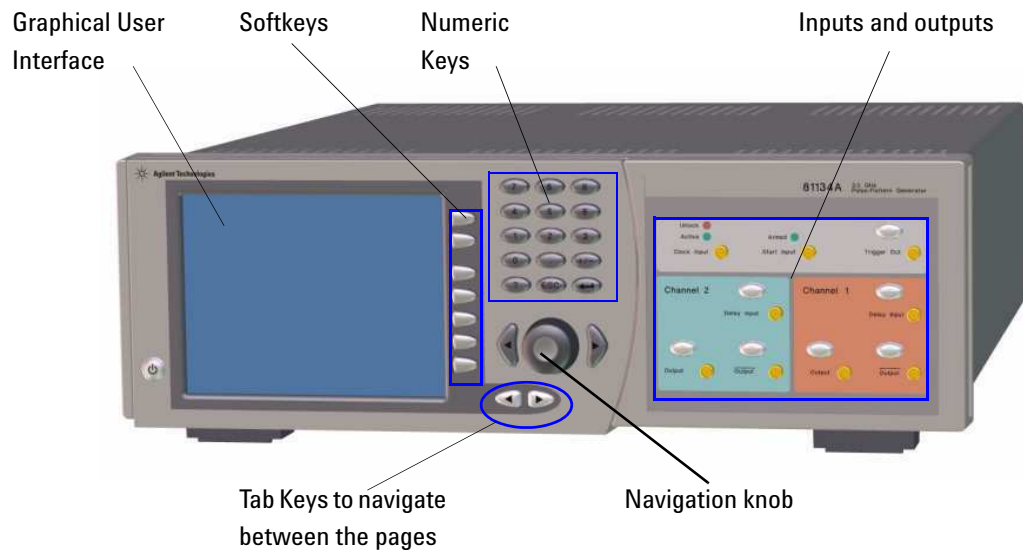

The front panel has the following elements:

- **Graphical User Interface**  
The graphical user interface is used for monitoring (and changing) the instrument's settings
- **Softkeys**  
The softkeys provide context-sensitive functions (functionality changes according to requirements)
- **Numeric keys**  
Used to set parameter values.
- **Tab keys**  
Used to scroll through the pages of the graphical user interface.

- Navigation knob

Used to navigate through and to change parameter values in an easy way, and also for navigating through the online help.

For more information, see “*Operating the Agilent 81133A/81134A Pulse Generator*” on page 19.

- Inputs and Outputs

The instrument provides global and channel-specific inputs and outputs as described in the following section.

## Input and Outputs

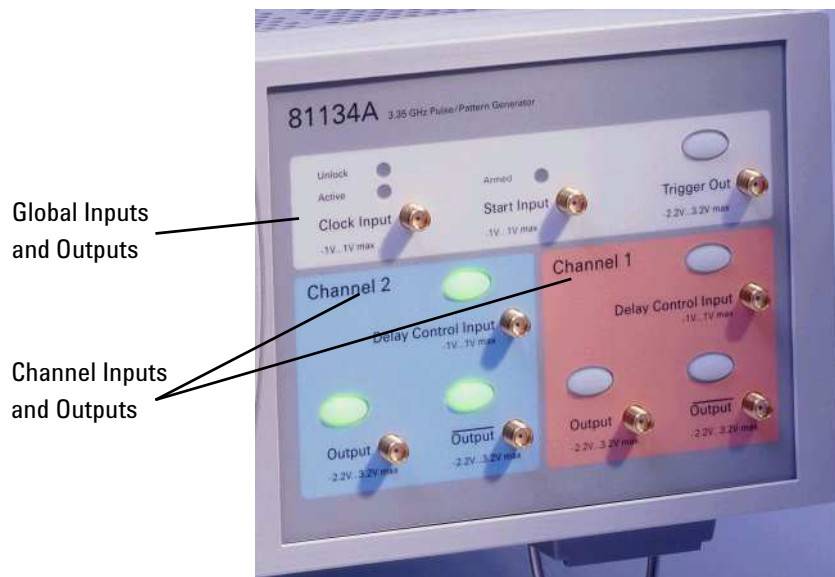

The Agilent 81133A/81134A pulse generator provides the following inputs and outputs:

### Channel Specific Inputs and Outputs

For each channel:

- One *Delay Control Input* to apply an external signal for jitter modulation.  
For more information, see “*Jitter Modulation*” on page 83.
- One normal and one inverted *Output* for the generated signal

### Global Inputs and Outputs

For the instrument:



- Clock Input

The clock input is used to apply an external clock signal or a reference signal for the internal PLL if a higher frequency accuracy than 50ppm is required.

This input can be AC or DC terminated. If it is DC terminated, the termination voltage can be set.

For more information, see *“Clock Sources” on page 73*.

- Start Input

The start input is used to start the instrument on an external signal.

For more information, see *“Start Mode” on page 75*.

- Trigger Output

The trigger output can be used to trigger another instrument.

For more information, see *“Trigger Out” on page 75*.

**LEDs** The front panel of the 81133A/81134A pulse generator contains the following LEDs:

LED	Description
Unlock	<p>When this LED is lit, the frequency entered for the external clock does not match the actual input from the external clock. In this state, the internal PLL is not locked and the instrument's outputs may not be within specification.</p> <p>You have to either reenter the frequency of the external clock, or execute the <i>Measure</i> function. See <i>“Clock Sources” on page 73</i> for details.</p>
Active	<p>When lit, indicates that the instrument is either in external or direct external clock mode. A valid external clock signal has to be applied to the clock input.</p> <p>If not lit, the internal clock source is used.</p>
Armed	<p>Indicates that the instrument is waiting for a signal at the Start Input.</p> <p>When the specified signal arrives, the instrument starts generating signals.</p>
Port LEDs	<p>Indicate the status of the port. When the LED is lit, the port is active.</p>

# Rear Panel Overview

At the rear panel, you can find the connectors for the remote programming interfaces GPIB, USB and LAN, and the power connector.

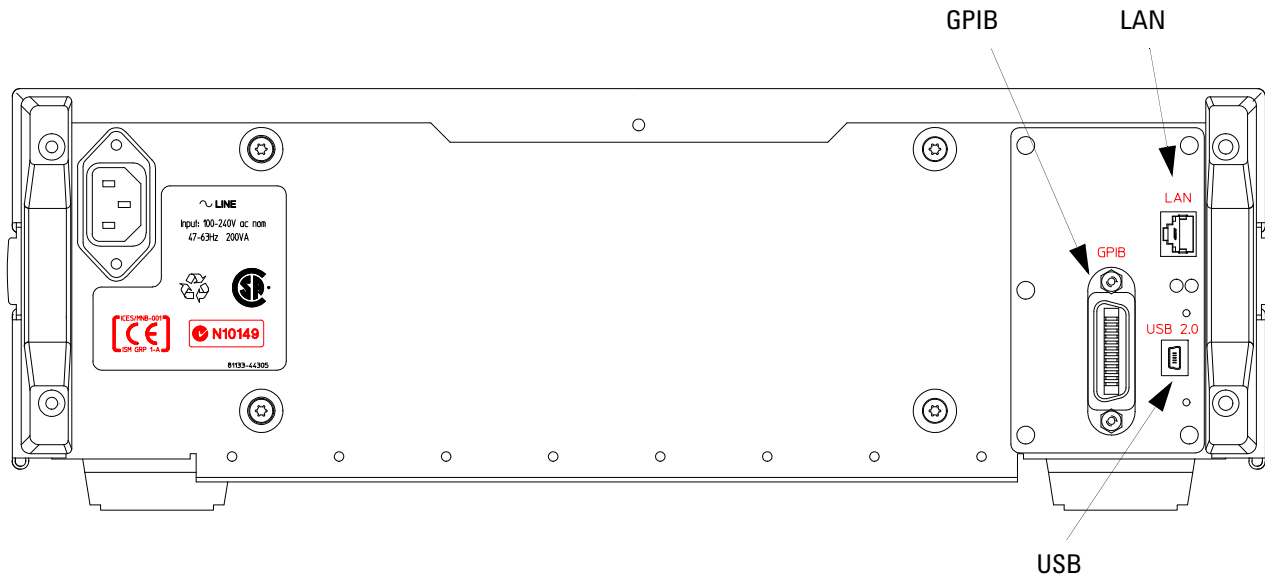

# Operating the Agilent 81133A/81134A Pulse Generator

The instrument provides several navigation buttons that make it easy to scroll through the different pages of the graphical user interface and to change parameter values.

## Scrolling through the Pages



To scroll through the different pages, use the instrument's tab keys (located below the navigation knob).

See *“Navigation through the Pages” on page 20.*

## Changing Parameter Values



To change parameter values, use the navigation knob.

The following sections shows:

- *“How to Navigate through the Parameters at one Page” on page 21*
- *“How to Select a Parameter from a Selection List” on page 21*
- *“How to Change a Number Field” on page 23*

# Navigation through the Pages

The key tabs at the lower left corner of the display allows you to scroll through the different pages (Main, Channel, Data, Aux, and Config) of the graphical user interface.

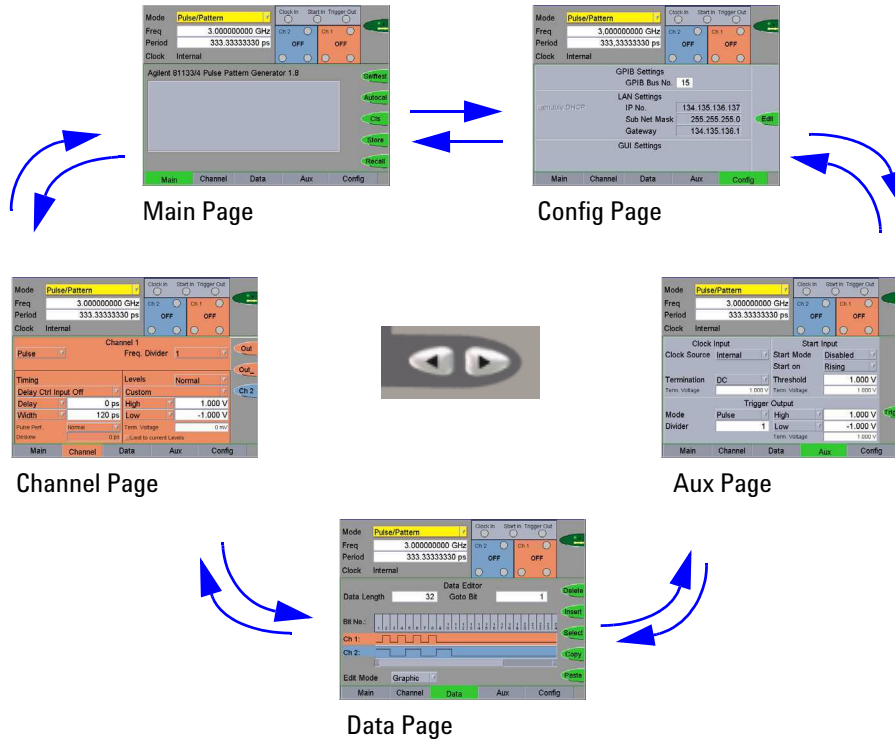

## How to Navigate through the Parameters at one Page

The navigation knob makes it easy to move through and set the parameters:

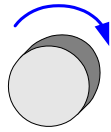

- © Rotate the navigation knob to move from one parameter to the next.

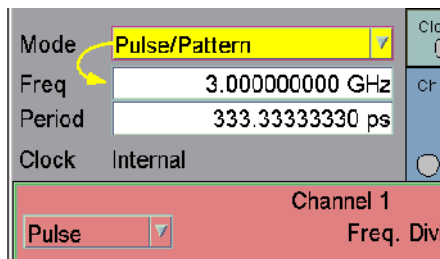

## How to Select a Parameter from a Selection List

To select a parameter from a selection list:

- 1 Move the selection to the corresponding list by rotating the navigation knob.

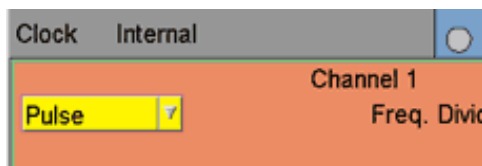

2 Press the navigation knob to open the selection list.

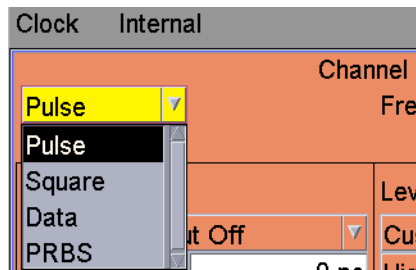

3 Rotate the navigation knob to scroll through the list.

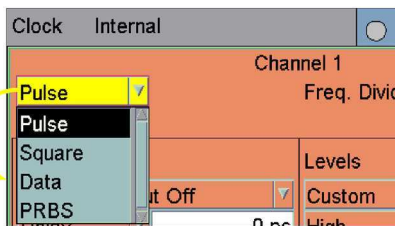
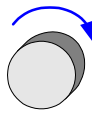

4 Select an item by pressing the navigation knob (like clicking with the mouse).

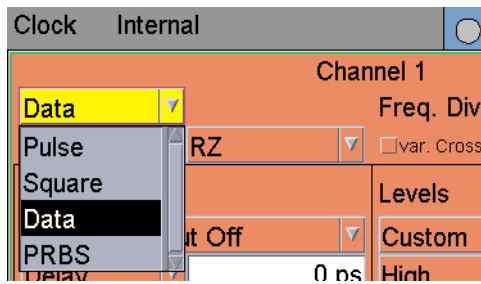

# How to Change a Number Field

You have three possibilities for changing a number field:

- By entering new values with the keypad
- By using the navigation knob to modify the values for fine-tuning
- By changing single digits

## Entering New Values

To enter a new value:

- 1 Focus at the number field by rotating the navigation knob to the desired position.

Mode	Burst	1
Freq	3.000000000 GHz	
Period	333.33333330 ps	

- 2 Enter the value using the keypad.

You can tell if the value in a field is active by the color of the field:

- Yellow: Value is active (affects output).
- Orange: Value is inactive.

Freq	750 GHz
Period	333.33333 ps

**3** Modify the unit:

- By pressing the respective softkey function (in this case, you can immediately see the changes at the output).

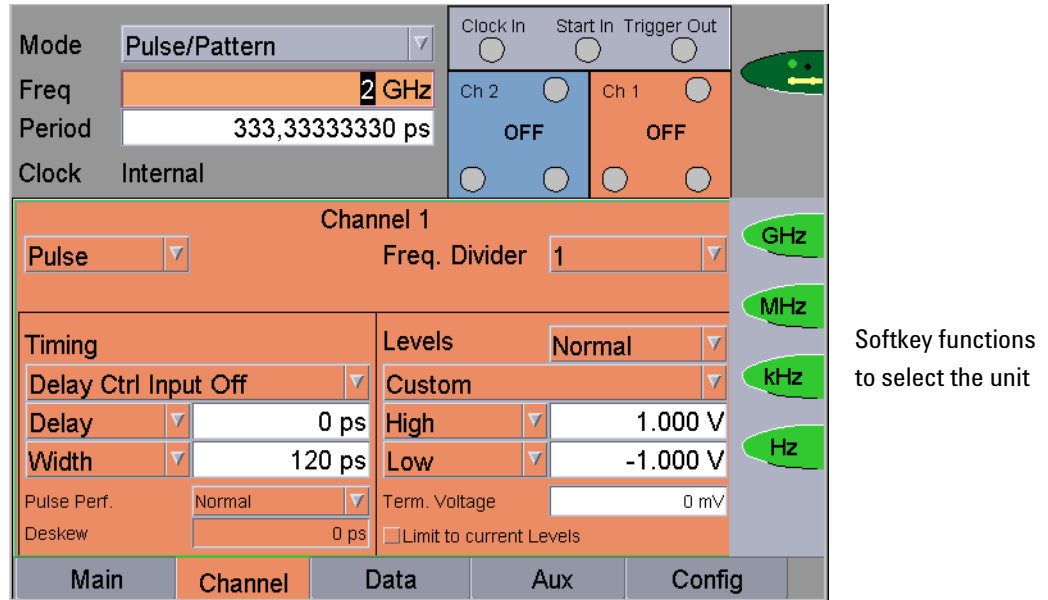

- OR -

By rotating the navigation knob.



In this case, you have to press *Enter* or the navigation knob to see the changes at the output.

**Modify Values (Fine-Tuning)**

To modify the value by using the navigation knob:

- 1 Focus at the number field by rotating the navigation knob to the desired position.
- 2 Press *Enter* or the navigation knob once to set the focus.

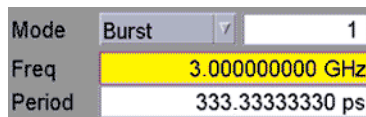





- 3 Press and rotate the navigation knob to set the least significant digit to change.

Freq 3.300000000 GHz Ch

**NOTE** This method is useful for fine-tuning. It also changes the values in real-time, so that you can immediately see the changes at the output.

- 4 Rotate the navigation knob to change the value.
- 5 Press the navigation knob once when you are done.

### Changing Single Digits

**NOTE** This procedure can also be used to change the unit of the parameter.

- 1 Focus at the number field by rotating the navigation knob to the desired position.

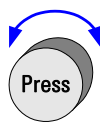

- 2 Press and rotate the navigation knob to select the digit (number or unit).

Freq 3.000000000 GHz

**NOTE** You can also press the arrows next to navigation knob.

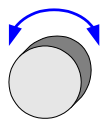

- 3 Release the navigation knob.  
Now when you rotate it, the number (or the unit) changes.

Freq 3.050000000 GHz



- 4 Press the navigation knob to set the number (or the unit).  
You can now see the changes at the output.



# Setting Up Generic and Advanced Signals

The intention of this chapter is to give the necessary steps to set up generic and advanced signals for first-time users of the Agilent 81133A/81134A Pulse Generator.

Examples are given for the following types of signals:

- *“Setting Up a Clock Signal” on page 28*
- *“Setting Up a Pulse Signal” on page 36*
- *“Setting Up a Data Pattern” on page 40*
- *“Setting Up a Burst Signal” on page 46*
- *“Setting Up a Repetitive Burst Signal” on page 52*
- *“Setting Up Signals for a Stressed Eye Diagram Measurement” on page 58*

All these signals can be set up either by using the user interface, or by sending SCPI commands. In the following examples, both are described.

It is intended that you work through the example in the order in which they appear. The first example therefore provides the most detailed instructions, while the other examples are described in less detail.

**NOTE** For all examples, the Agilent 81134A Pulse Generator (with two channels) is used.

# Setting Up a Clock Signal

**Task** Set up two clock signals with 100 MHz and 200 MHz frequencies, a duty cycle of 50%, a high level of 1.0 V and a low level of 0 V.

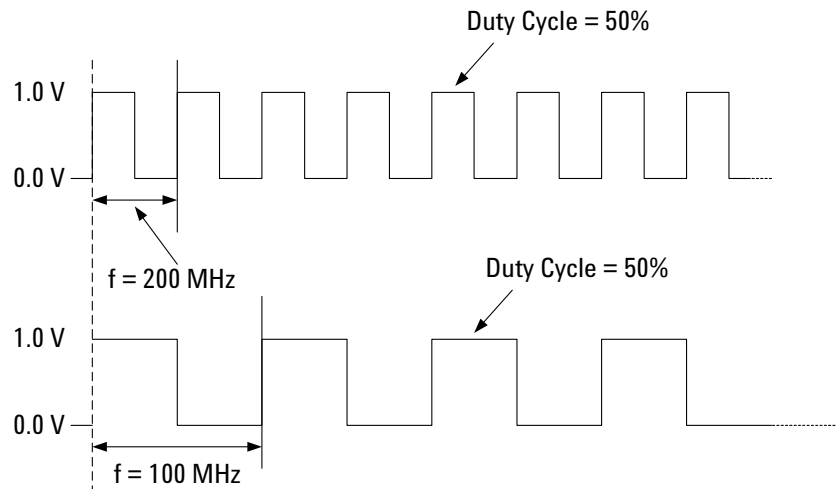

**Use Cases** Generating clock signals can be used for:

- Boards evaluation
- Microprocessors
- A/D Converters
- PCI/PCI-X validation
- Digital ASIC design for high-speed HDD

## Using the Graphical User Interface

**First Steps** Before you start:

- 1 Put the instrument into operation.
- 2 Protect the DUT by disconnecting the channel outputs first.  
Do this by pressing the softkey next to the following function:

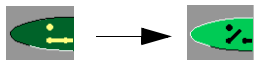

The open contactor shows you that your DUT is now disconnected.

**Instrument Settings** To set the instrument parameters:

- 1 In the instrument panel, choose the *Pulse/Pattern* mode.
- 2 Switch to *Freq* and then with the numeric keypad enter **200** as the magnitude of the frequency.
- 3 Select the desired unit *MHz* by pressing the corresponding softkey.

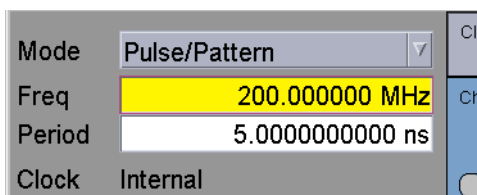

**Channel 1 Settings** To set the channel parameters for channel 1:

- 1 Switch to the *Channel* page.  
Per default, channel 1 is selected.
- 2 Select the pattern mode *Square*.  
In the *Timing* panel, the following parameter are set as default:
  - The *Delay* is set to 0 ps.
  - The *DCycle* is set to 50%.
  - The *Deskew* is disabled.
- 3 In the *Levels* panel:
  - Switch *Ampl* to *High* and set *High* to 1.0 V.
  - Set *Low* to 0 V.

**4 Enable the Channel 1 normal Output:**

By pressing the respective softkey in the user interface:

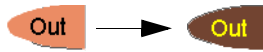

- OR -

By pressing the normal Out softkey for channel 1 next to the Output port.

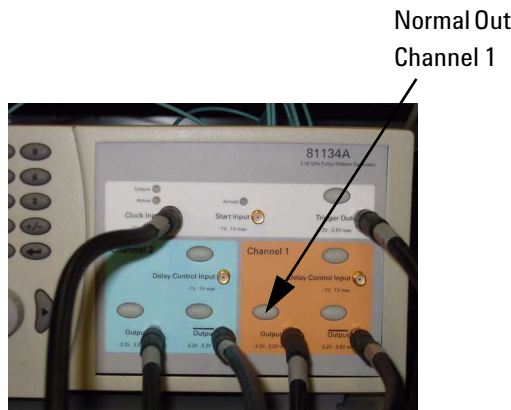

The Channel 1 page now looks as follows:

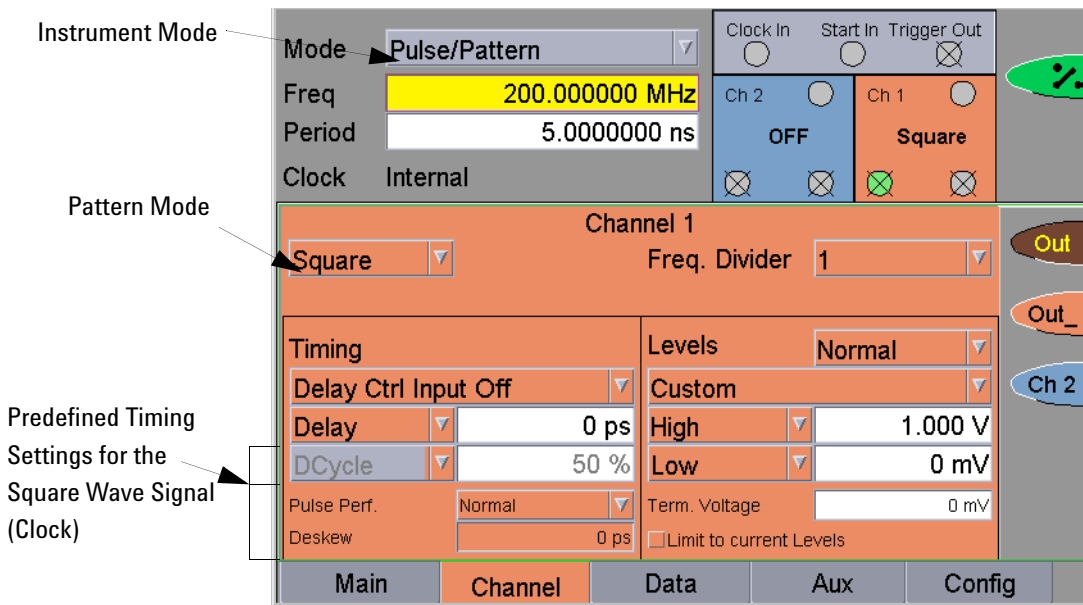

**Channel 2 Settings** To set the channel parameters for channel 2:

- 1 Switch to channel 2 by pressing the *Ch2* softkey .
- 2 Select the pattern mode *Square*.
- 3 Set the *Freq. Divider* to **2**.
- 4 In the *Levels* panel:
  - Switch *Ampl* to *High* and set *High* to 1.0 V.
  - Set *Low* to 0 V.
- 5 Enable the Channel 2 normal Output either:  
By pressing the respective softkey in the user interface.



– OR –

By pressing the normal Out softkey for channel 2 next to the Output port.

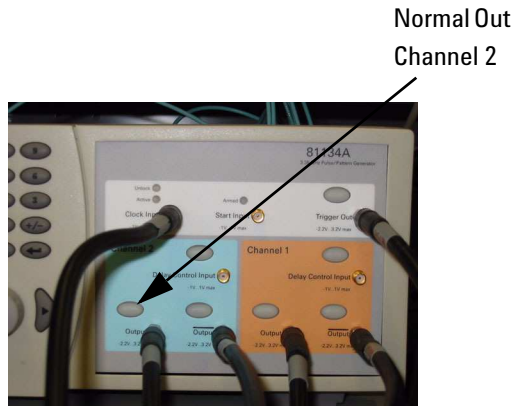

The *Channel 2* page now looks as follows:

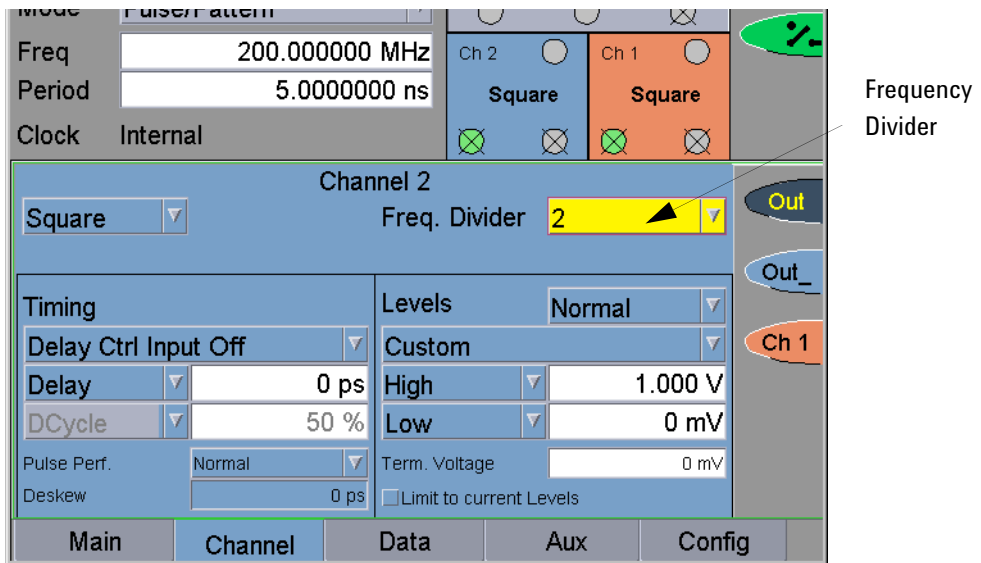

**Reconnect the DUT** Reconnect the DUT by clicking the following softkey function:





**Generated Signal** If you attach a scope (as DUT), you can immediately see the signal.

Use the Pulse Generator's TRIGGER OUT to trigger the scope.

To enable the trigger output:

- 1 At the *Aux* page, press the *TrigOut* softkey function.

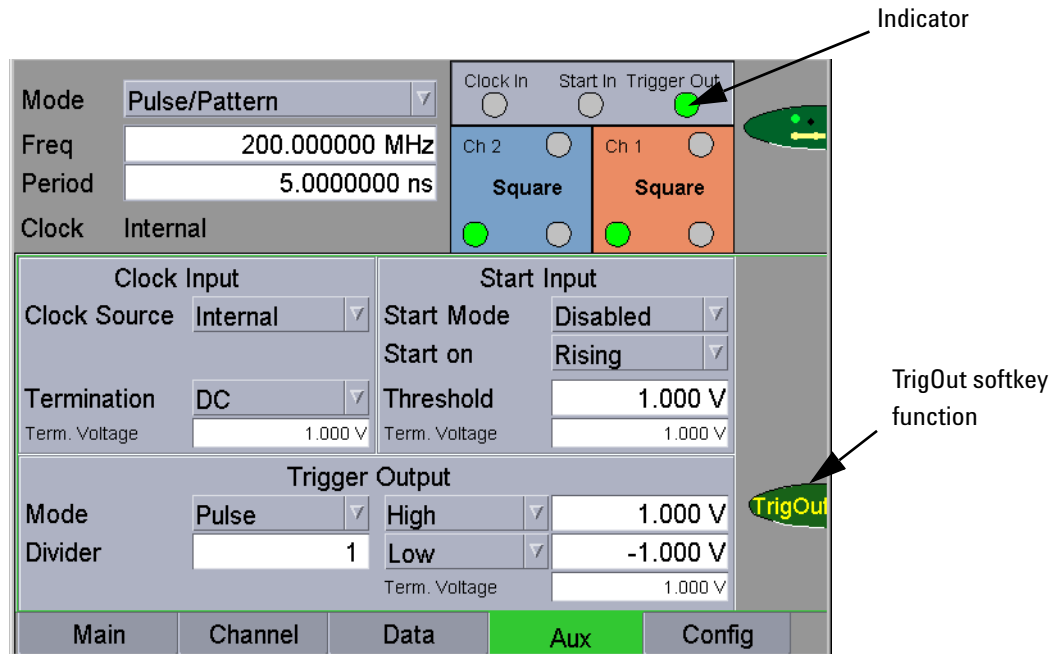

The green LED indicates that *Trigger Out* is enabled.

– OR –

Press the Trigger Out softkey next to the Trigger Out port.

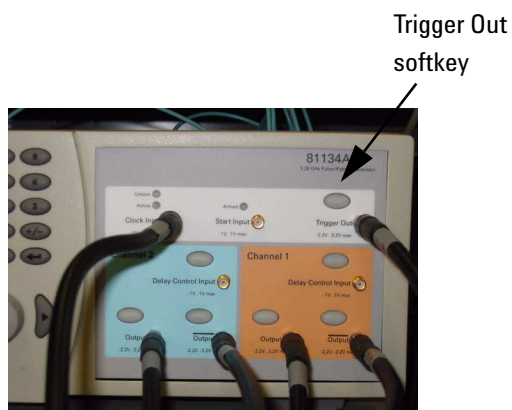

The signals as displayed on a standard oscilloscope are depicted below.



## Using the Remote Programming Interfaces

The following code performs the same task.

```
Protect the DUT //disconnect channels
:OUTP:CENT OFF

Set up the Instrument //set mode to Pulse/Pattern
:FUNC PATT

//set freq to 200 MHz
:FREQ 200 MHz

Set up Channel 1 //set pattern mode to Square
:FUNC:MODE1 SQU

//set high-Level to 1 V
:VOLT1:HIGH 1.000 V

//set low-level to 0 V
:VOLT1:LOW 0 V

//enable output channel 1
:OUTP1:POS ON

Set up Channel 2 //set pattern mode to Square
:FUNC:MODE2 SQU

// set freq div to 2
:OUTP2:DIV 2

//set the high-Level to 1 V
:VOLT2:HIGH 1.000 V

//set low-level to 0 V
:VOLT2:LOW 0 V

//enable output channel 2
:OUTP2:POS ON

Generate the Signals //reconnect the channels
:OUTP:CENT ON

//enable trigger output
:OUTP0 ON
```

# Setting Up a Pulse Signal

**Task** Set up a continuous pulse signal with 20 ns period, a pulse width of 5 ns, an amplitude of 2.0 V and an offset of 1.5 V (high level 2.5 V, low level 500 mV).

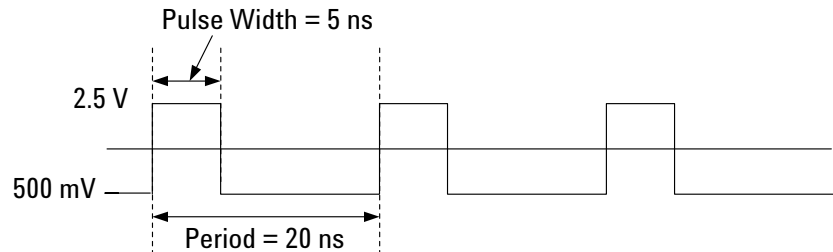

## Using the Graphical User Interface

**Instrument Settings** To set the instrument parameters:

- 1 Disable the outputs.
- 2 In the instrument panel, choose the *Pulse/Pattern* mode.
- 3 Set the *Period* to **20 ns**.

**Channel Settings** To set the channel parameters:

- 1 Switch to the *Channel* page.
- 2 Select the pattern mode *Pulse*.
- 3 In the *Timing* panel:
  - Switch from *DCycle* to *Width* and set the *Width* to **5 ns**.
- 4 In the *Levels* panel, set:
  - The level format to *Custom*.
  - Switch from High/Low to Amplitude/Offset.
  - *Amplitude* to **2.0 v**.
  - *Offset* to **1.5 v**.

**5 Enable the Channel 1 normal Output:**

By pressing the respective softkey in the user interface:



- OR -

By pressing the normal Out softkey for channel 1 next to the Output port.

The Channel page now looks as follows:

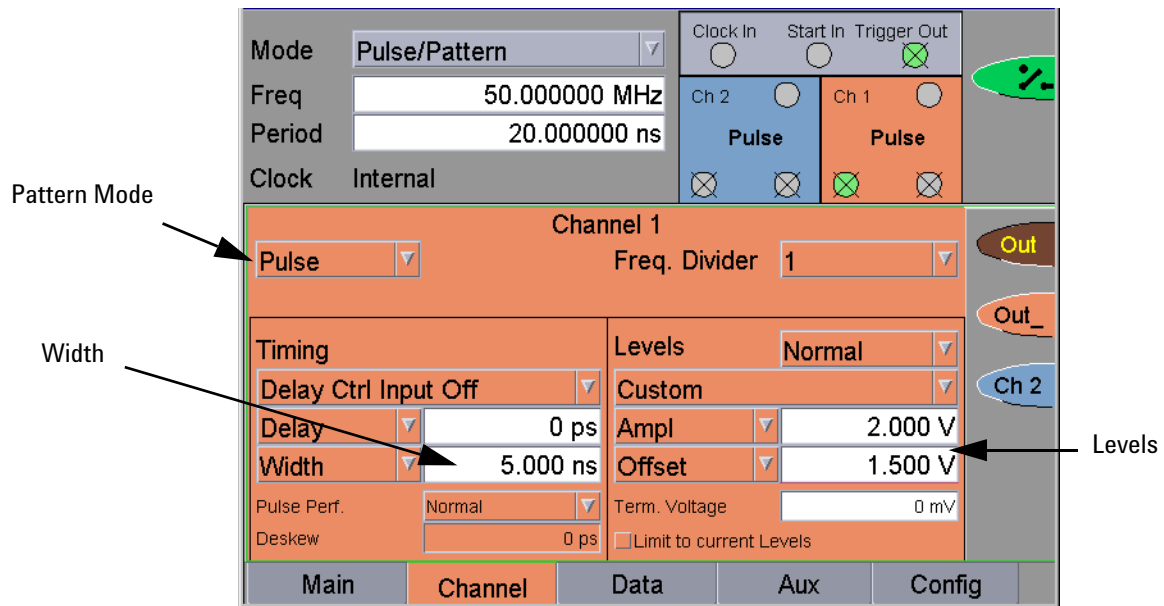

**Reconnect the DUT Enable the outputs:**

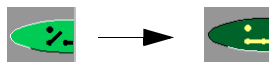

**Generated Signal** Use the pulse generator's TRIGGER OUT to trigger the scope.

To set up the trigger output:

- 1 On the *Aux* page, select the trigger mode *Pulse*.

The frequency of the trigger output equals the system frequency.

- 2 Enable the trigger output.

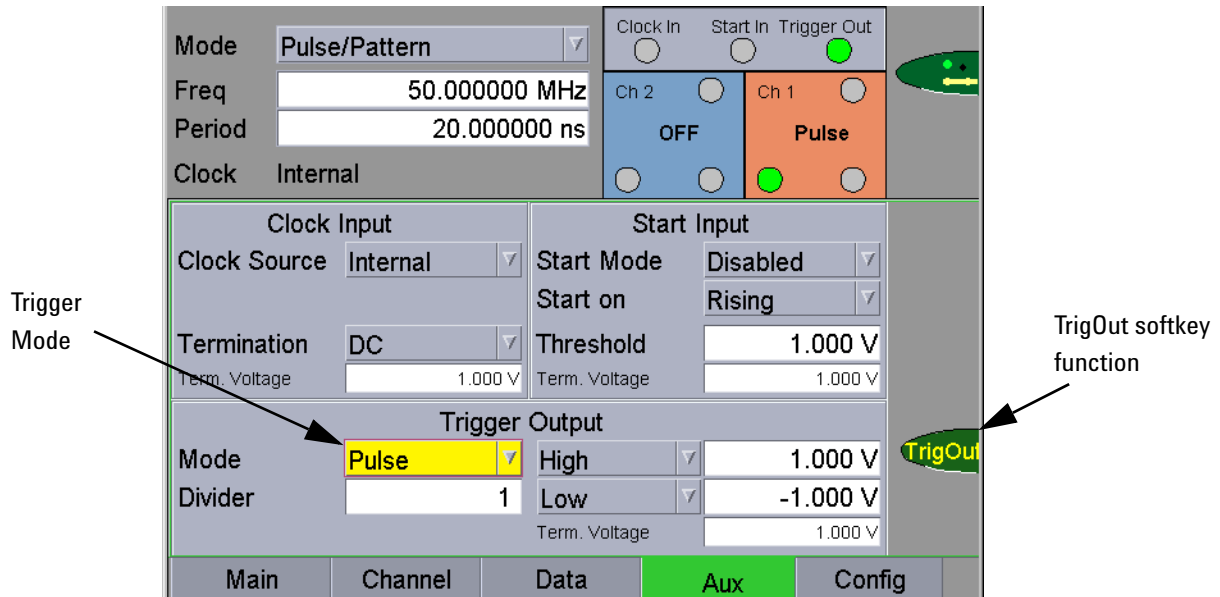

The signal as displayed on a standard oscilloscope is depicted below.

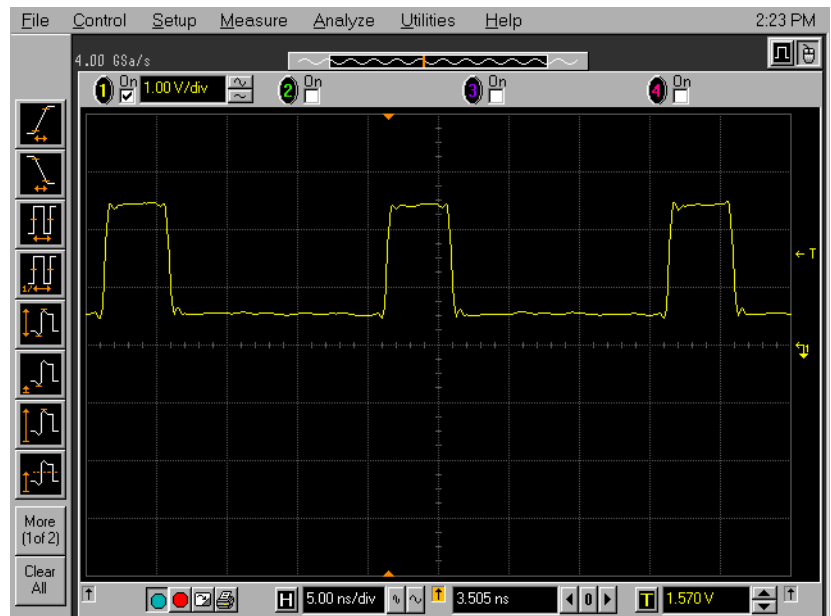

## Using the Remote Programming Interfaces

The following code performs the same task.

```
Protect the DUT //disconnect channels
:OUTP:CENT OFF

Set up the Instrument //set mode to Pulse/Pattern
:FUNC PATT

//set period to 20 ns
:PER 20 ns

Set up Channel 1 //set pattern mode to Pulse
:FUNC:MODE1 PULSE

//set width to 5 ns
:WIDT1 5 ns

//set ampl to 2 V
:VOLT1:AMPL 2.000 V

//set offset to 1.5 V
:VOLT1:OFFSET 1.5 V

//enable output channel 1
:OUTP1:POS ON

Generate the Signals //reconnect channels
:OUTP:CENT ON

//use trigger mode Pulse
:OUTP0:SOUR PER

//enable trigger output
:OUTP0 ON
```

# Setting Up a Data Pattern

**Task** Set up two signals:

- A PRBS signal to test a digital transmitter.
- A 32-bit pattern signal with NRZ data output format at 500 MHz to check a digital circuit with ECL logic.

The pattern is:

**11110011100110010010100100000000**

**NOTE** This example is demonstrated with the 81134A instrument.

With the 81134A instrument, you can set up both signals simultaneously.

## Using the Graphical User Interface

**Instrument Settings** To set the instrument parameters:

- 1 Disable the outputs.
- 2 In the instrument panel, choose the *Pulse/Pattern* mode.
- 3 Set the frequency to **500 MHz**.

**Channel Settings for the PRBS Signal** To set the channel parameters for channel 1:

- 1 Switch to the *Channel* page.
- 2 Select the pattern mode *PRBS*.
- 3 Select the PRBS polynome  $2^{12}-1$ .
- 4 Select the signal mode *NRZ*.
- 5 In the *Levels* panel, select the predefined level format *ECL*.

This automatically sets:

- the *Amplitude* to 800 mV
- the *Offset* to -1.350 V
- the *Term. Voltage* to -2.0 V



**6 Enable the Channel 1 normal Output:**

By pressing the respective softkey in the user interface:

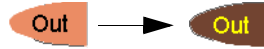

- OR -

By pressing the normal Out softkey for channel 1 next to the Output port.

The *Channel* page now looks as follows:

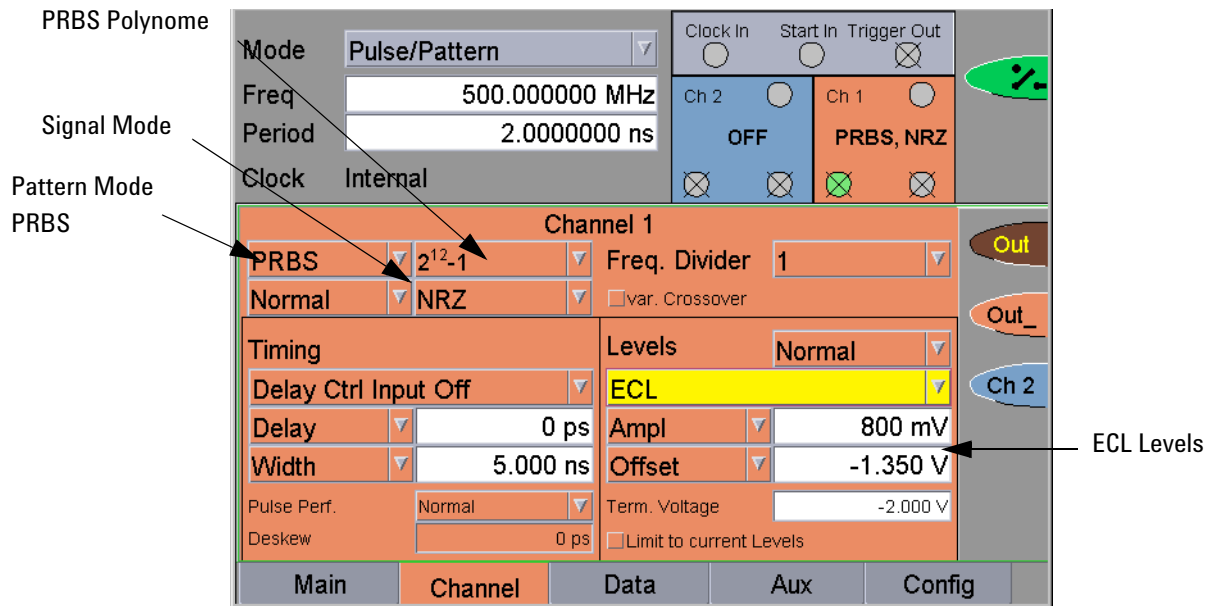

**Channel Settings for the Pattern Signal** To set the channel parameters for channel 2:

- 1 Switch to Channel 2 by pressing the *Ch2* softkey .
- 2 Switch to the *Channel* page.
- 3 Select the pattern mode *Data*.
- 4 Select the signal mode *NRZ*.
- 5 In the *Levels* panel, select the predefined level format *ECL*.  
This automatically sets:
  - the *Amplitude* to 800 mV
  - the *Offset* to -1.350 V
  - the *Term. Voltage* to -2.0 V

- 6** Enable the Channel 2 normal Output either:  
By pressing the respective softkey in the user interface.



- OR -

By pressing the normal Out softkey for channel 2 next to the Output port.

The *Channel* page now looks as follows:

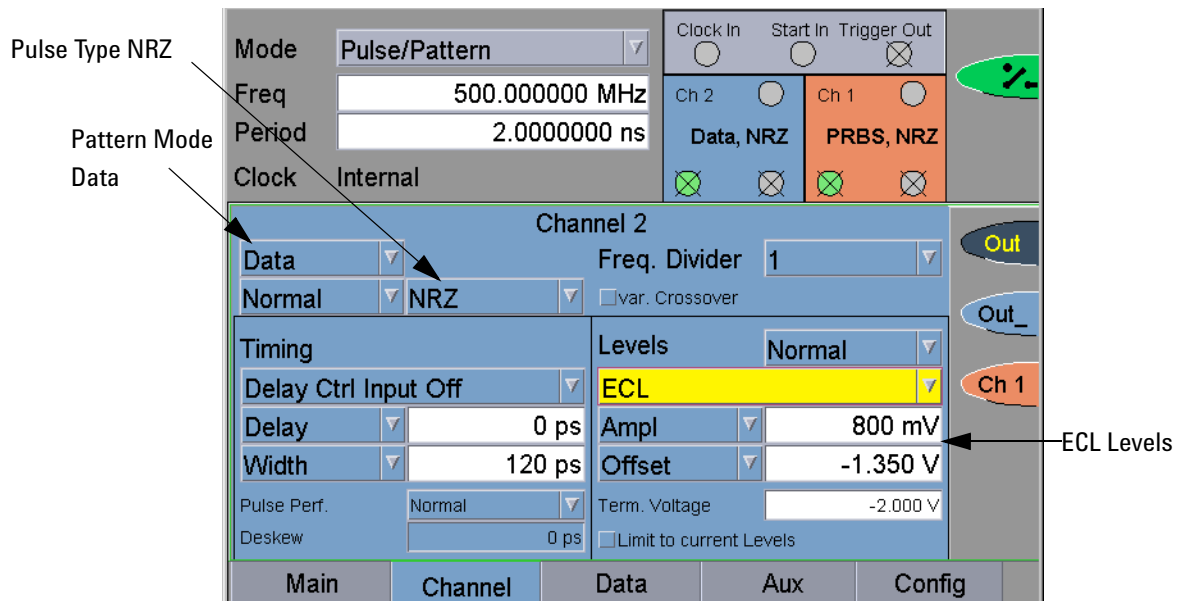

**Data Settings for the Pattern Signal** To set the data pattern:

- 1** Switch to the *Data* page.
- 2** Enter a *Data Length* of **32** bits.
- 3** Switch to the *Numeric Edit Mode*.
- 4** Enter the data pattern via the keypad for channel 2.

The *Data* page now looks as follows:

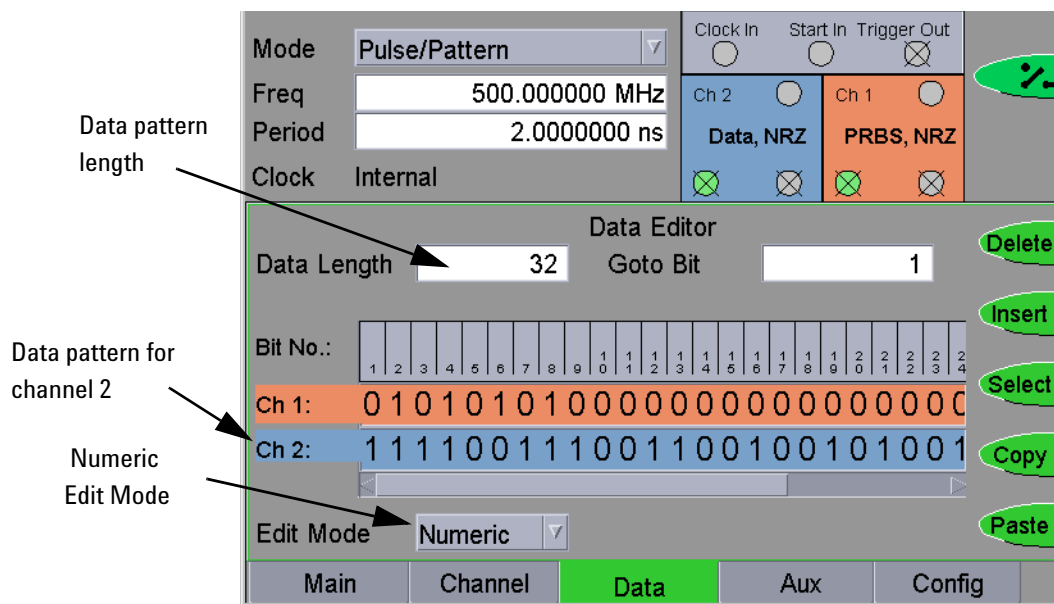

**Reconnect the DUT** Enable the outputs:

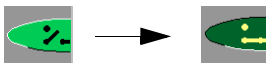

**Generated Signals** Use the pulse generator's TRIGGER OUT to trigger the scope on the data pattern.

To set up the trigger output:

**1** On the *Aux* page, in the *Trigger Output* panel:

- Select the trigger mode *Data*.  
One trigger pulse occurs at the start of the repetitive data pattern.
- Set the *Ampl* to 2 V.
- Set the *Offset* to 1 V.

2 Enable the trigger output.

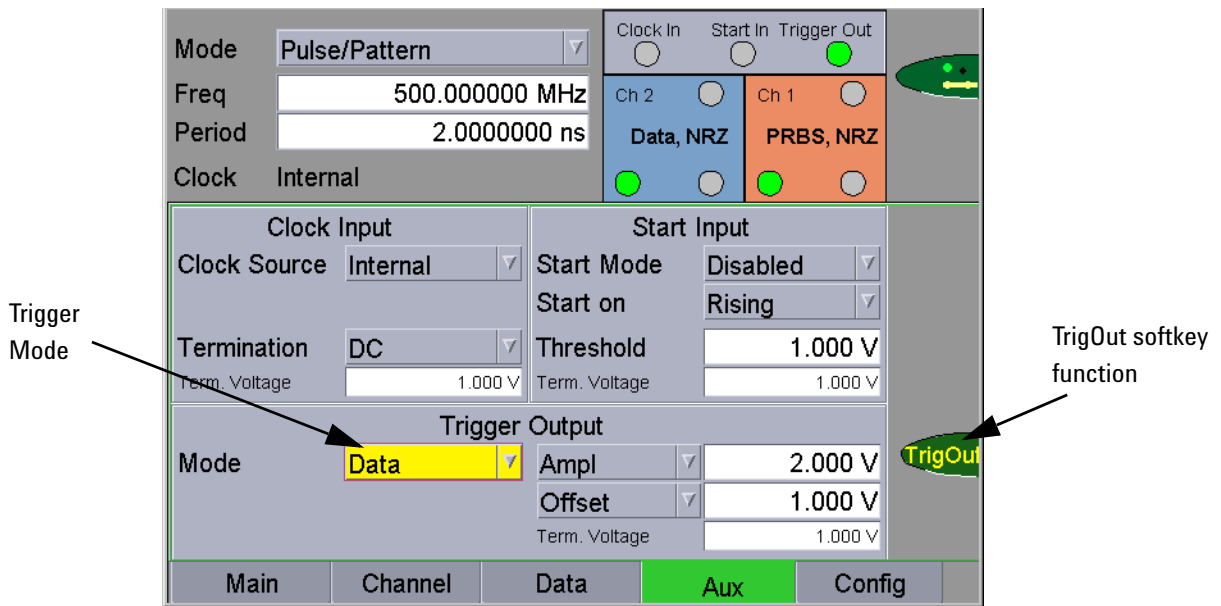

The signals as displayed on a standard oscilloscope are depicted below.



## Using the Remote Programming Interfaces

The following code performs the same task:

```

Protect the DUT //disconnect channels
:OUTP:CENT OFF

Set Up the Instrument //set mode to Pulse/Pattern
:FUNC PATT

//set freq to 500 MHz
:FREQ 500 MHz

Set up Channel 1 //set pattern mode to PRBS
:FUNC:MODE1 PRBS

//set polynome to 2^12-1
:FUNC:MODE1 PRBS, 12

//set datamode to NRZ
:DIG1:SIGN:FORM NRZ

//set predefined levels to ECL values
:VOLT1:AMPL 800 mV; :VOLT1:OFFS -1.350 V; :VOLT1:TERM -2.000 V

//enable output channel 1
:OUTP1:POS ON

Set up Channel 2 //set pattern mode to Data
:FUNC:MODE2 DATA

//set datamode to NRZ
:DIG2:SIGN:FORM NRZ

//set predefined levels to ECL values
:VOLT2:AMPL 800 mV; :VOLT2:OFFS -1.350 V; :VOLT2:TERM -2.000 V

//enable output channel 2
:OUTP2:POS ON

//set datalength to 32
:DIG2:PATT:LENG 32

//set pattern in channel 2
:DIG2:PATT #23211110011100110010010100100000000, DUAL

Generate the Signals //reconnect channels
:OUTP:CENT ON

// Set up the trigger

//set trigger mode to data
:OUTP0:SOUR BITS

//set ampl to 2 V
:VOLT0:AMPL 2 V

//set offset to 1 V
:VOLT0:OFFSET 1 V

//enable trigger output
:OUTP0 ON

```

## Setting Up a Burst Signal

**Task** Set up a burst signal consisting of a 32-bit data pattern repeated twice at a period of 500 ps with 50 ps delay and 100 ps pulse width.

The data pattern is: **10100000000000000000000000000000**

The amplitude is 2.0 V and the offset is 0 V.

Start the output at the rising edge of an external signal with 1 V threshold applied at the start input.

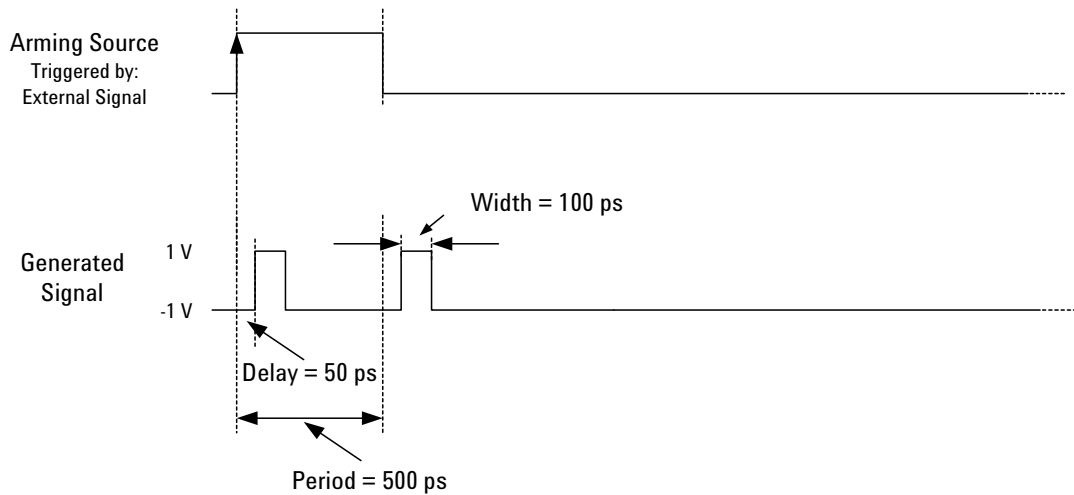

## Using the Graphical User Interface

**Instrument Settings** To set the instrument parameters:

- 1 Disable the outputs.
- 2 In the instrument panel, choose the *Burst* mode.
- 3 Set the burst repetition to **2**.
- 4 Set the *Period* to **500 ps**.

The instrument panel now looks as follows:

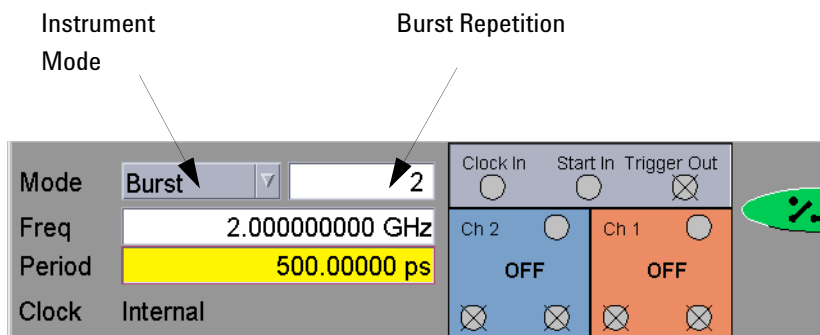

### Channel Settings for the PRBS Signal

To set the channel parameters:

- 1 Switch to the *Channel* page.
- 2 Set the signal mode to RZ.
- 3 In the *Timing* panel:
  - Switch from *Dcycle* to *Width* and set the *Width* to **100 ps**.
  - Set the *Delay* to **50 ps**.
- 4 In the *Levels* panel, set:
  - The level format to *Custom*.
  - *Amplitude* to **2.0 v**.
  - *Offset* to **0.0 v**.
- 5 Enable the Channel 1 normal Output:



- OR -

By pressing the normal Out softkey for channel 1 next to the Output port.

The *Channel* page now looks as follows:

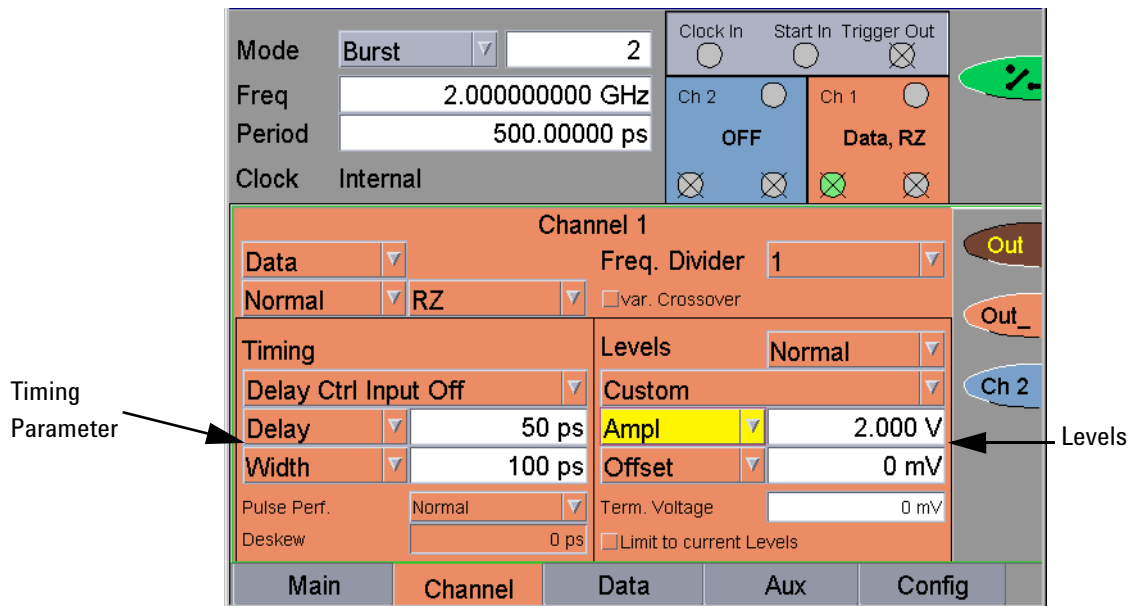

**Data Settings for the Pattern Signal** To set the data pattern:

- 1 Switch to the *Data* page.
- 2 Enter a *Data Length* of **32** bits.
- 3 Enter the data pattern via the keypad for channel 1.

The *Data* page now looks as follows:

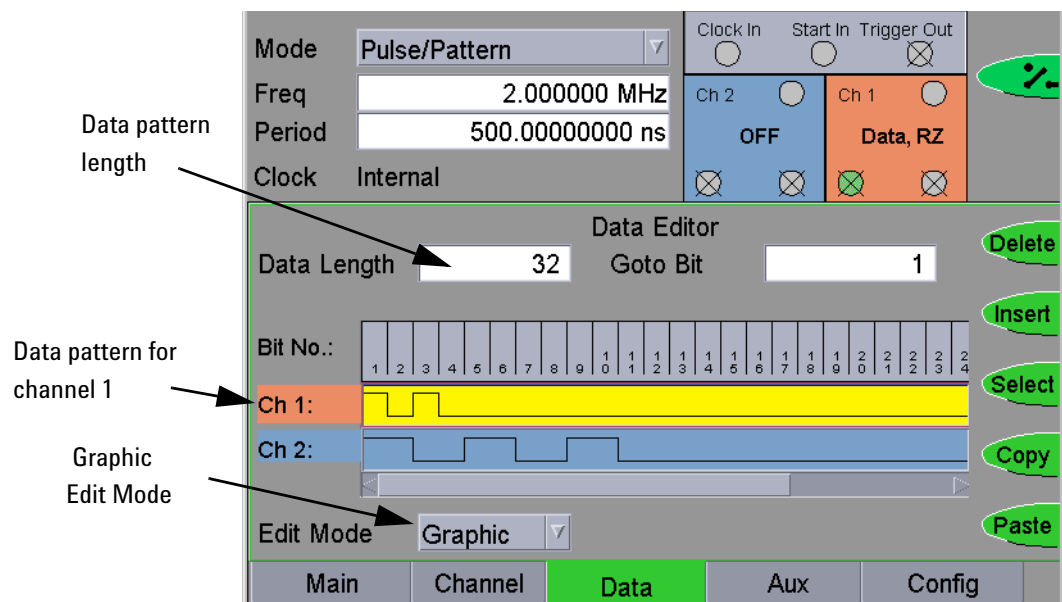



**Reconnect the DUT** Enable the outputs:

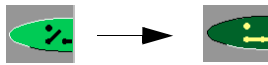

**Auxiliary Settings for Start Input and Trigger Output**

To set the start input and trigger output parameters:

- 1 Switch to the *Aux* page.
- 2 In the *Start Input* panel, set:
  - The start mode to *Ext. Input*.

This automatically puts the instrument in “armed” mode. This is indicated by the activated *Armed* softkey function.

“Armed” mode means that the signal is output as soon as the specified external signal occurs at the start input.

**NOTE**

In burst mode, the “armed” mode is deactivated as soon as the specified burst has been output.

To put the instrument in “armed” mode again, press the *Armed* softkey function.

- *Start on* the *Rising* edge.
- The threshold to **500 mV**.

- 3 In the *Trigger Output* panel:

- Select the trigger mode *Pulse*.

The frequency of the trigger output equals the frequency as specified in the instrument panel.

- Set *Ampl* to 2 V.
- Set *Offset* to 0 V.
- Enable the trigger output.

The *Aux* page now looks as follows:

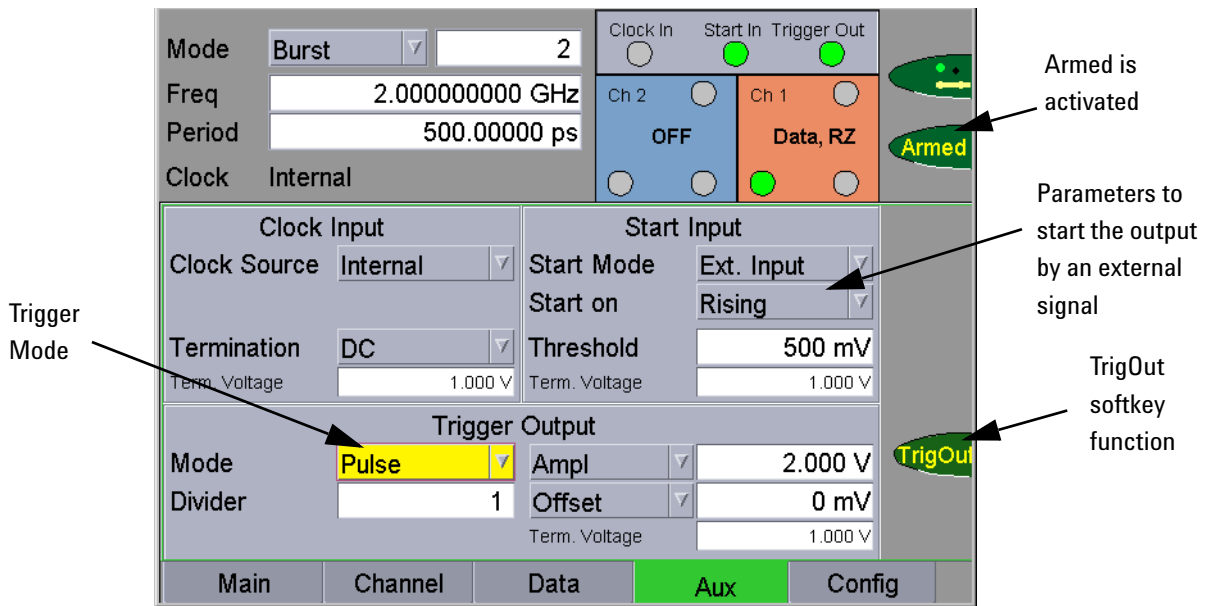

**Generated Signal** Use the generator's TRIGGER OUT to trigger a scope.

The signal as displayed on a standard oscilloscope is depicted below.



## Using the Remote Programming Interfaces

The following code performs the same tasks:

```

Protect the DUT //disconnect channels
                  :OUTP:CENT OFF

Set Up the Instrument //set mode to Burst, 2
                       :FUNC BURST, 2

                       //set period to 500 ps
                       :PER 500 ps

Set up Channel 1 //set signalmode to RZ
                   :DIG1:SIGN:FORM RZ

                   //set width to 100 ps
                   :WIDT1 100 ps

                   //set delay to 50 ps
                   :DEL1 50 ps

                   //set predefined levels to Custom values (Ampl=2V; Offset=0mV)
                   :VOLT1:AMPL 2 V; :VOLT1:OFFS 0 mV

                   //enable output channel 1
                   :OUTP1:POS ON

                   //set datalength to 32
                   :DIG:PATT:LENG 32

                   //set pattern in channel 1
                   :DIG1:PATT #23210100000000000000000000000000, DUAL

Generate the Signals //reconnect channels
                       :OUTP:CENT ON

                       // Set up the trigger

                       //set startmode to Ext. Input
                       :ARM:SOUR EXT

                       //set starton to Rising
                       :ARM:SLOP POS

                       //set threshold to 500 mV
                       :ARM:LEV 500 mV

                       //set trigger mode to Pulse
                       :OUTP0:SOUR PER

                       //set ampl to 2 V
                       :VOLT0:AMPL 2 V

                       //set offset to 0 V
                       :VOLT0:OFFSET 0 V

                       //enable trigger output
                       :OUTP0 ON

```

# Setting Up a Repetitive Burst Signal

**Task** Set up a signal with 4 repeated bursts.

Each burst consists of a 32-bit pattern signal with NRZ data output format at 100 MHz to check a digital circuit with LVPECL logic.

The data pattern is:

**11100000000000000000000000000000**

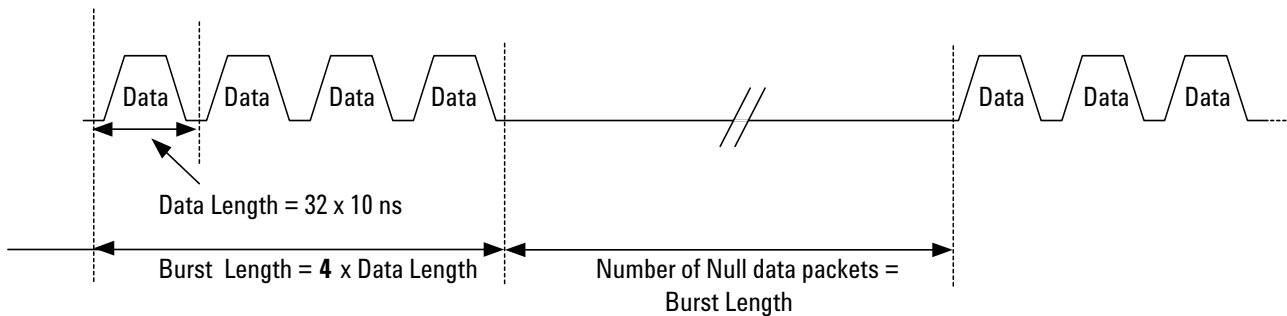

## Using the Graphical User Interface

**Instrument Settings** To set the instrument parameters:

- 1 Disable the outputs.
- 2 In the instrument panel, choose the *RBurst* mode.
- 3 Enter **4** for the number of null data packets.
- 4 Define that the number of zeros that follows the repeated bursts is as large as the burst length.
- 5 Set the frequency to **100 MHz**.

The instrument panel now looks as follows:

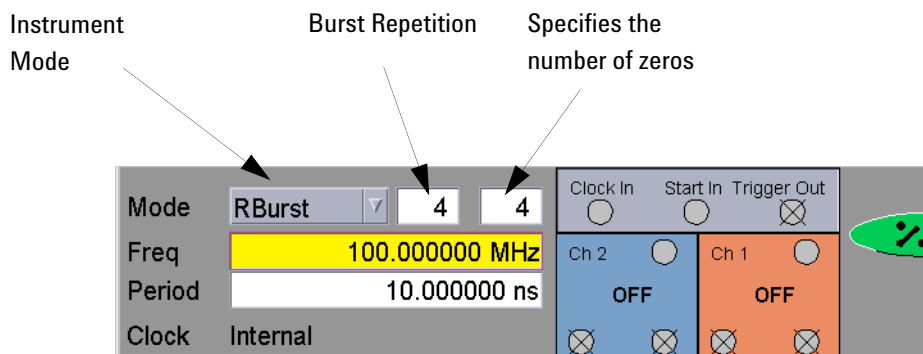

**Channel Settings for the PRBS Signal** To set the channel parameters:

- 1 Switch to the *Channel* page.
- 2 In the *Timing* panel:
  - Set the signal mode to *NRZ*.
  - Set the *Delay* to **50 ps**.
- 3 In the *Levels* panel, set:
  - The level format to *Custom*.
  - *Amplitude* to **2.0 v**.
  - *Offset* to **0.0 v**.

- 4 Enable the Channel 1 normal Output:

By pressing the respective softkey in the user interface:

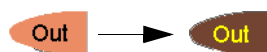

– OR –

By pressing the normal Out softkey for channel 1 next to the Output port.

The *Channel* page now looks as follows:

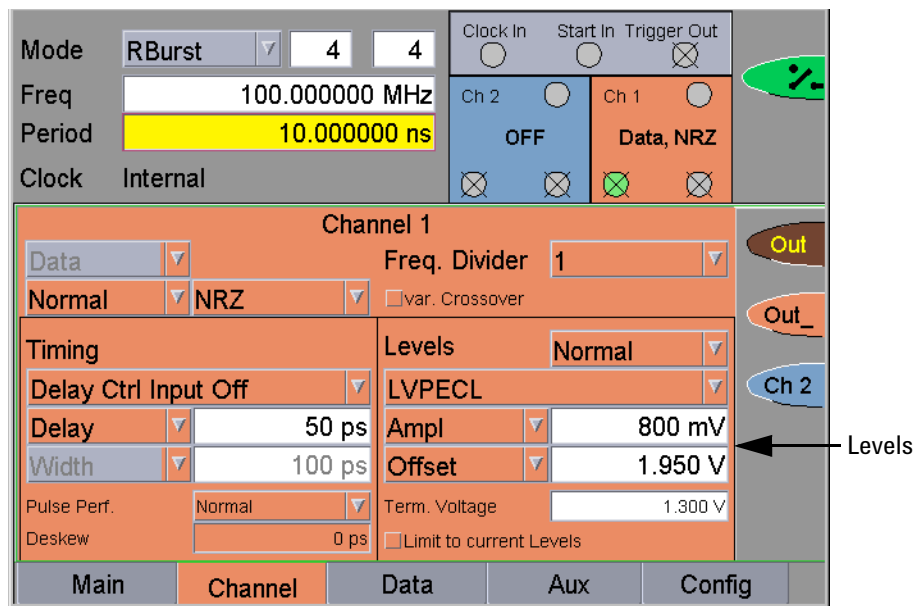

**Data Settings for the Pattern Signal** To set the data pattern:

- 1 Switch to the *Data* page.
- 2 Enter a *Data Length* of 32 bits.
- 3 Enter the data pattern via the keypad for channel 1.

The *Data* page now looks as follows:

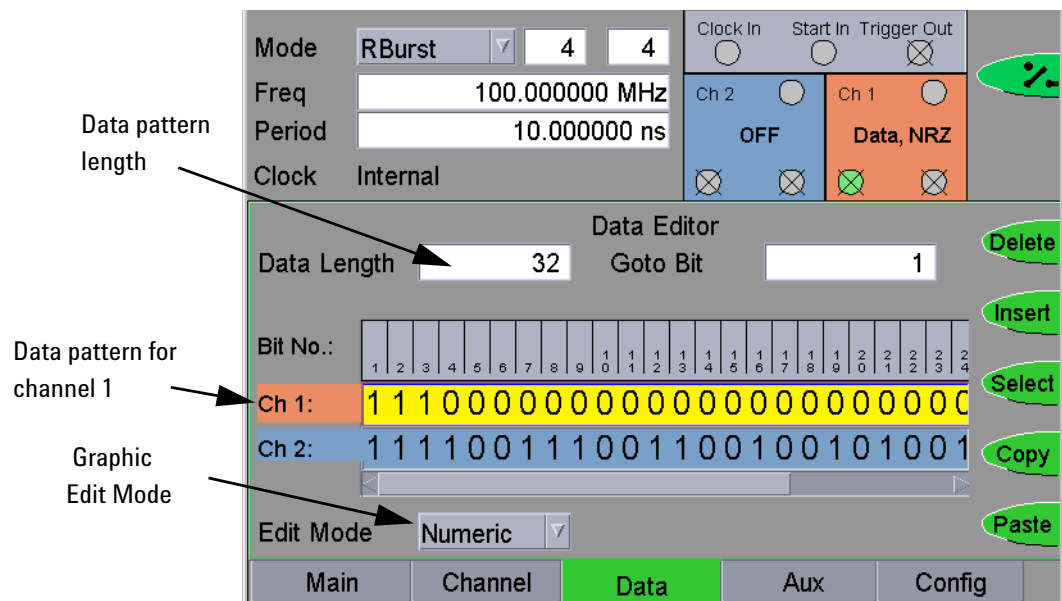

**Reconnect the DUT** Enable the outputs:

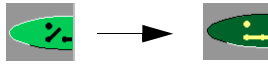

**Generated Signal** Use the pulse generator's TRIGGER OUT to trigger a scope.

To set up the trigger output:

**1** On the *Aux* page, in the *Trigger Output* panel:

- Select the trigger mode *Pulse*.

One trigger pulse occurs at the start of the repetitive data pattern.

- Set the *Ampl* to 1 V.
- Set the *Offset* to 0 V.
- Set the *Divider* to 256.

**2** Enable the trigger output.

The Aux page looks now as follows:

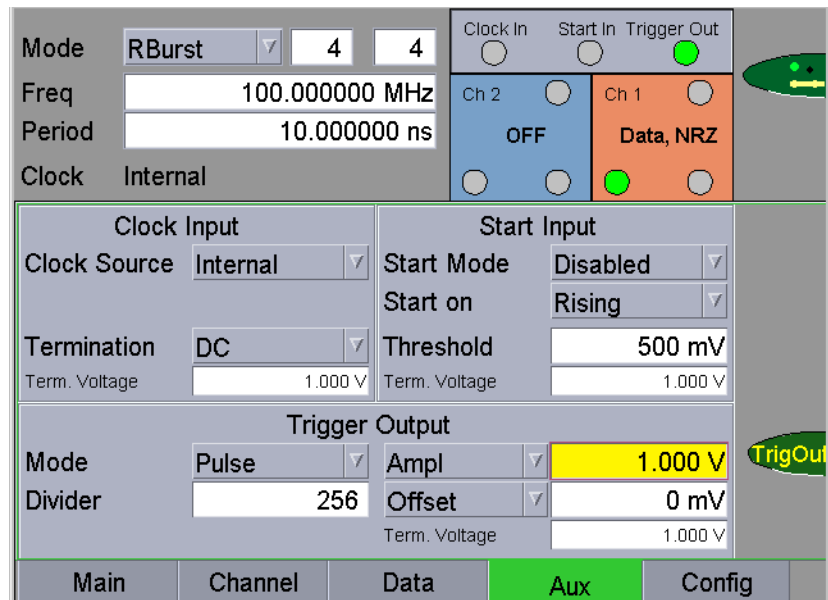

The signal as displayed on a standard oscilloscope is depicted below.

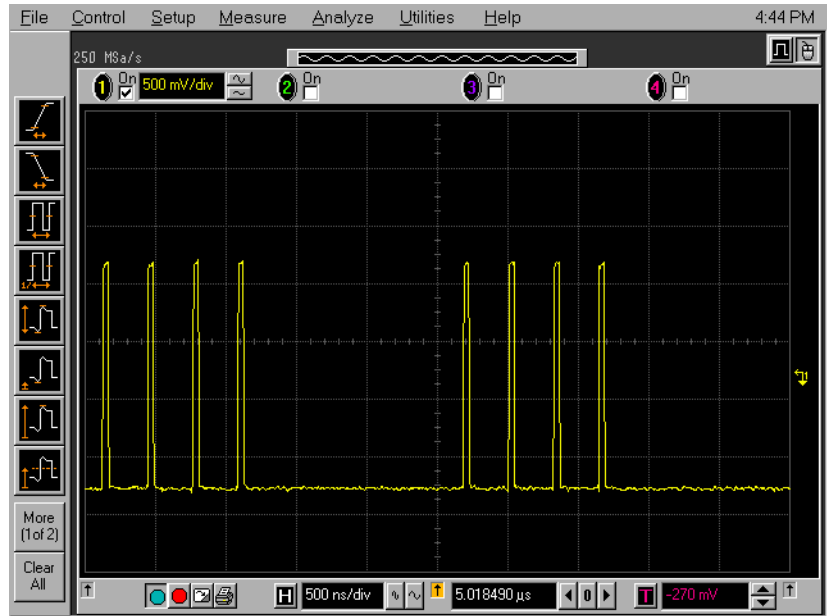



## Using the Remote Programming Interfaces

The following code performs the same tasks:

```
Protect the DUT //disconnect channels
:OUTP:CENT OFF

Set Up the Instrument //set mode to rBurst, 4, 4
:FUNC RBURST, 4, 4

//set freq to 100 MHz
:FREQ 100 MHz

Set up Channel 1 //set signalmode to NRZ
:DIG1:SIGN:FORM NRZ

//set delay to 50 ps
:DEL1 50 ps

//set predefined levels to Custom values (Ampl=2V; Offset=0mV)
:VOLT1:AMPL 2 V; :VOLT1:OFFS 0 mV

//enable output channel 1
:OUTP1:POS ON

//set datalength to 32
:DIG:PATT:LENG 32

//set pattern in channel 1
:DIG1:PATT #23211100000000000000000000000000, DUAL

Generate the Signals //reconnect channels
:OUTP:CENT ON

// Prepare the trigger

//set trigger mode to Data
:OUTP0:SOUR BITS

//set ampl to 1 V
:VOLT0:AMPL 1 V

//set offset to 0 V
:VOLT0:OFFSET 0 V

//enable trigger output
:OUTP0 ON
```

# Setting Up Signals for a Stressed Eye Diagram Measurement

**Task** Set up signals for a stressed eye measurement by:

- Intentionally adding jitter to your signals
- Changing the crossover of the eye pattern

**One-Channel Setup** For a one-channel setup, you need:

- An 81133A or 81134A instrument
- An arbitrary waveform generator to generate additional jitter, for example, the 33250A
- A scope for displaying the signals, for example, the 86100 DCA

**Two-Channel Setup** For a two-channel setup, you need:

- An 81134A instrument
- An arbitrary waveform generator to generate additional jitter, for example, the 33250A (you might need two of them for two “independently jittering” output signals)
- A scope for displaying the signals, e.g. the 86100 DCA

**NOTE** This example is demonstrated with the 81134A instrument. The two-channel instrument allows you to generate the distorted eye and a clean “reference eye” at the same time.

**Use Cases** Stressed eye measurements can be used:

- In board design: For testing the RF behavior of different board materials and transmission line geometries.
- For testing cables and connectors.
- For testing A/D converters.

## Connecting the Instruments

Connect the Pulse Generator, the Arbitrary Waveform Generator and the DCA as follows:

### CAUTION

Before disconnecting/connecting any cables make sure that the 81134A output channels are turned off!

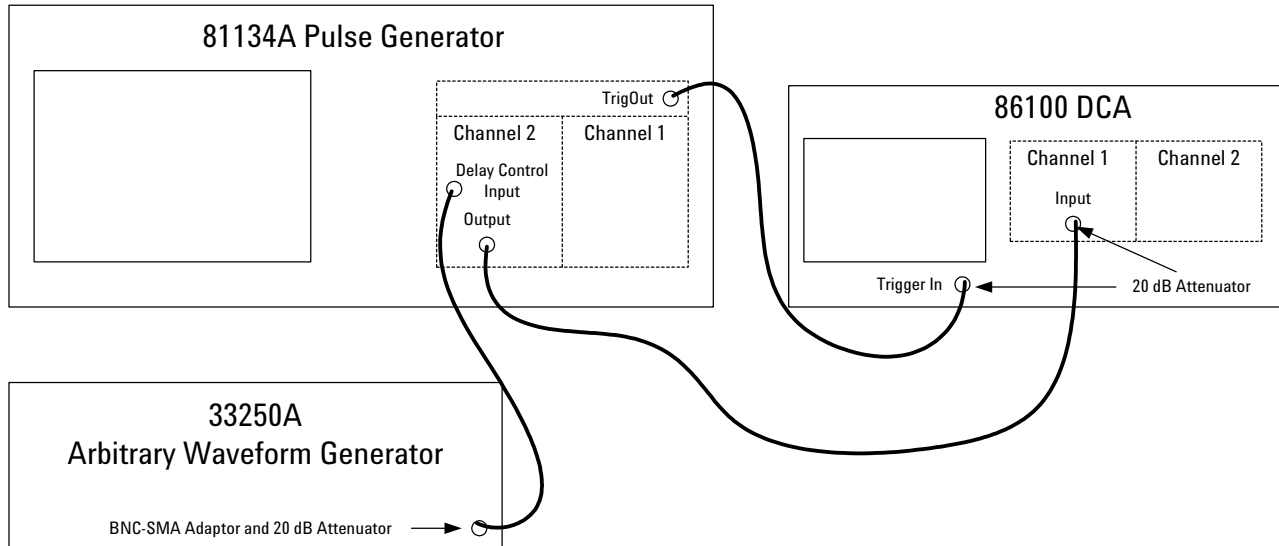

In detail:

- 1 Connect the 33250A output to the channel 2 delay control input of the 81134A (use the BNC-SMA adaptor and a 20 dB attenuator).
- 2 Connect a 20 dB attenuator each to the channel 1 and the trigger input of the DCA.
- 3 Connect the 81134A channel 2 output to the DCA's channel 1 input.
- 4 Connect the 81134A trigger output to the DCA's trigger input.
- 5 Power on the three units after you have made all connections.

## Setting Up the 81134A by Using the Graphical User Interface

**Instrument Settings** To set the instrument parameters:

- 1 Disable the outputs.
- 2 In the instrument panel, choose the *Pulse/Pattern* mode.
- 3 Set the *Period* to **1 GHz**.

**Channel Settings** To set the channel parameters for channel 2:

- 1 Switch to the *Channel* page.
- 2 Switch to Channel 2 by pressing the *Ch2* softkey .
- 3 Select the pattern mode *PRBS*.
- 4 Select the PRBS polynome  $2^5-1$ .
- 5 Select the signal mode *NRZ*.
- 6 Enable the variable crossover and set the crossover point at first to **50 %**.
- 7 In the *Timing* panel:
  - Select *Delay Ctrl Input 250 ps*.
  - Set the *Delay* to **0 s**.
  - Set the DCycle to **50 %**.
- 8 In the *Levels* panel, set:
  - The level format to *Custom*.
  - *High* to **1.0 v**.
  - *Low* to **-1.0 v**.

The *Channel* page now looks as follows:

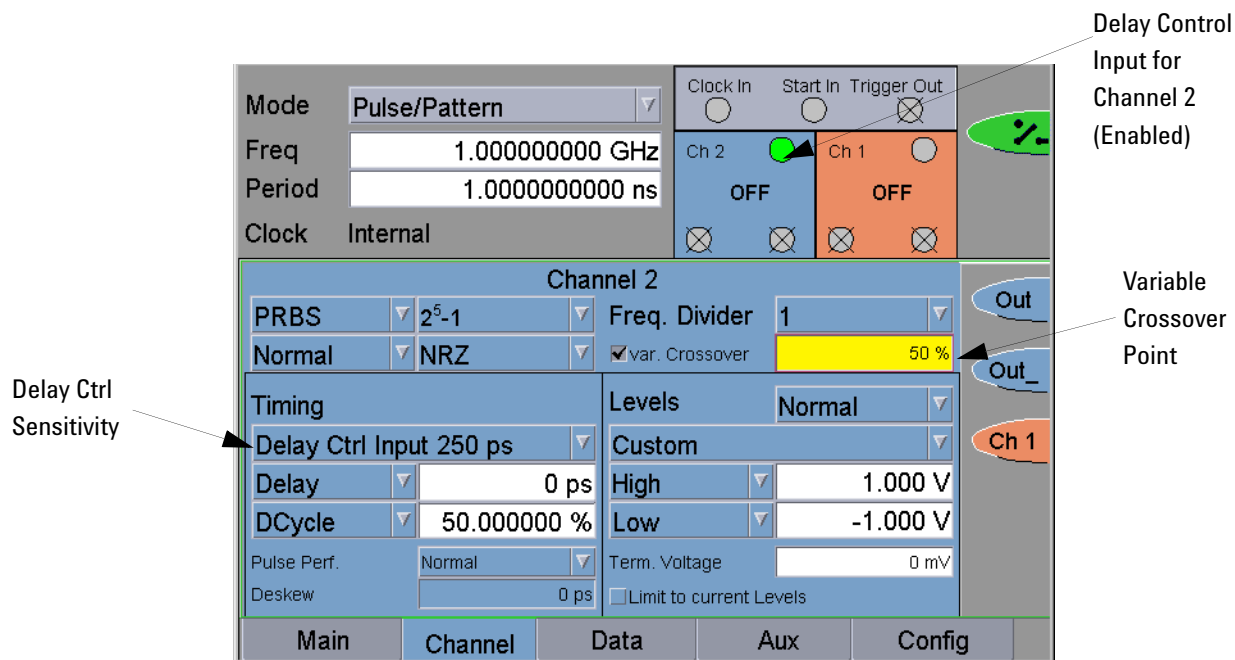

**Reconnect the DUT** Enable the outputs:



**Generated Signal** Use the pulse generator's TRIGGER OUT to trigger the scope.

To set up the trigger output:

- 1 On the *Aux* page, select the trigger mode *Pulse*.

The frequency of the trigger output equals the system frequency.

2 Enable the trigger output.

The screenshot displays the configuration interface for a pulse generator. The 'Trigger Output' section is highlighted, showing the following settings:

- Mode:** Pulse/Pattern
- Freq:** 1.000000000 GHz
- Period:** 1.000000000 ns
- Clock:** Internal
- Clock Input:** Clock Source: Internal, Termination: DC, Term. Voltage: 1.000 V
- Start Input:** Start Mode: Disabled, Start on: Rising, Threshold: 1.000 V, Term. Voltage: 1.000 V
- Trigger Output:** Mode: Pulse, Divider: 1, High: 1.000 V, Low: -1.000 V, Term. Voltage: 1.000 V

Annotations on the right side of the interface:

- Trigger Output (Enabled):** Points to the 'Trigger Out' indicator light, which is illuminated green.
- Delay Control Input (Enabled):** Points to the 'Ch 1' indicator light, which is illuminated green.
- TrigOut softkey function:** Points to the 'TrigOut' softkey button, which is highlighted in yellow.

The bottom navigation bar shows 'Main', 'Channel', 'Data', 'Aux' (highlighted in green), and 'Config'.

## Setting Up the 33250A Waveform Generator

Program a 50 MHz sine wave with an amplitude of 2 V<sub>pp</sub>:

- 1 Press the *Freq* softkey.
- 2 With the numeric keypad enter **50** as the frequency.
- 3 Select the desired unit *MHz* by pressing the corresponding softkey.
- 4 Press the *Ampl* softkey.
- 5 Enter the value **2** with the numeric keypad.
- 6 Press the *Vpp* softkey to select the desired unit.

## Viewing the Eye Diagram on the 86100 DCA

To view the eye diagram on the scope:

- 1 Ensure that the channel outputs and the trigger output at the 81134A instrument are enabled.
- 2 On the scope, switch to channel 1.
- 3 Press the *Source* button near the trigger input until *front panel* is selected.
- 4 Press the *Eye/Mask Mode* button.
- 5 Press *AutoScale*.
- 6 Switch on the 33250A output with the *output* key.

The signal as displayed on a standard oscilloscope is depicted below.

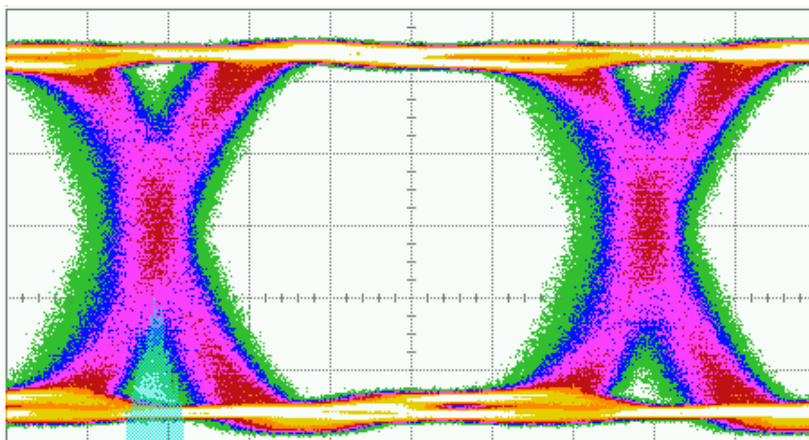

Delay modulated with sine wave

## Play with the Settings

The delay control input adds additional delay to the signal depending on the voltage that is fed to the input.

- On the 33250A, you can change the amplitude and frequency of the signal to show the influence of the delay control input.
- Change from sine wave to rectangular wave by pressing the corresponding button.

You can also change the variable crossover point on the 81134A *Channel* panel.

The following signals show a clear eye, a signal modulated with sine wave and a signal modulated with rectangular wave.

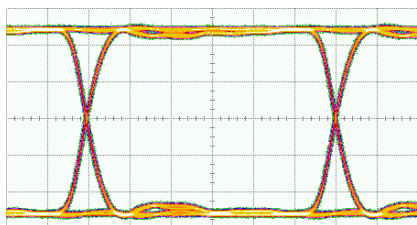

Clear Eye

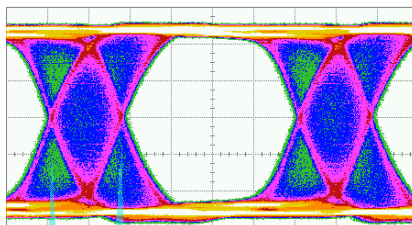

Delay modulated with sine wave

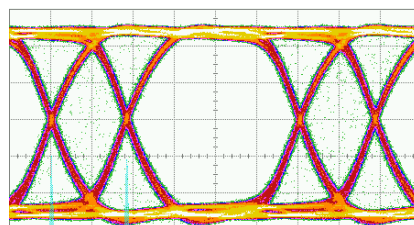

Delay modulated with rectangle wave

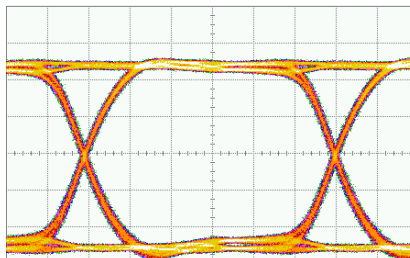

50 % Variable Crossover

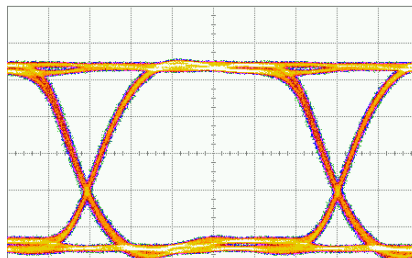

30 % Variable Crossover

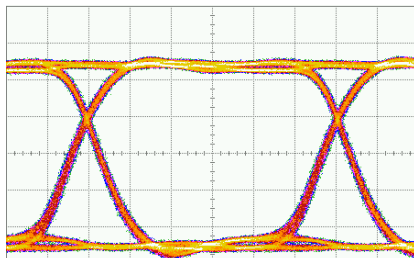

70 % Variable Crossover



# Using the Agilent 81133A/81134A Pulse Generator

## CAUTION

When using the Agilent 81133A/81134A Pulse Generator, make sure you do not set parameters to values outside of the specified ranges. If any parameters are out of range, the generated signals may not be valid. The instrument does not check if values are within range.

For valid ranges, see the Online Help (available by pressing the "?" button on the instrument).

This chapter:

- Describes different pages of the graphical user interface.
- Describes how to combine parameters for generating specific signals.
- Shows typical timings. See *"Timing of Generated Signals"* on page 76.
- Provided information of saving and recalling of parameter settings. See *"Saving and Recalling Settings"* on page 83.

## Pages of the User Interface

The instrument has a user interface to simplify entering and monitoring of the signal settings. The user interface is divided into different pages and panels.

The following figure shows the instrument panel and the Channel page.

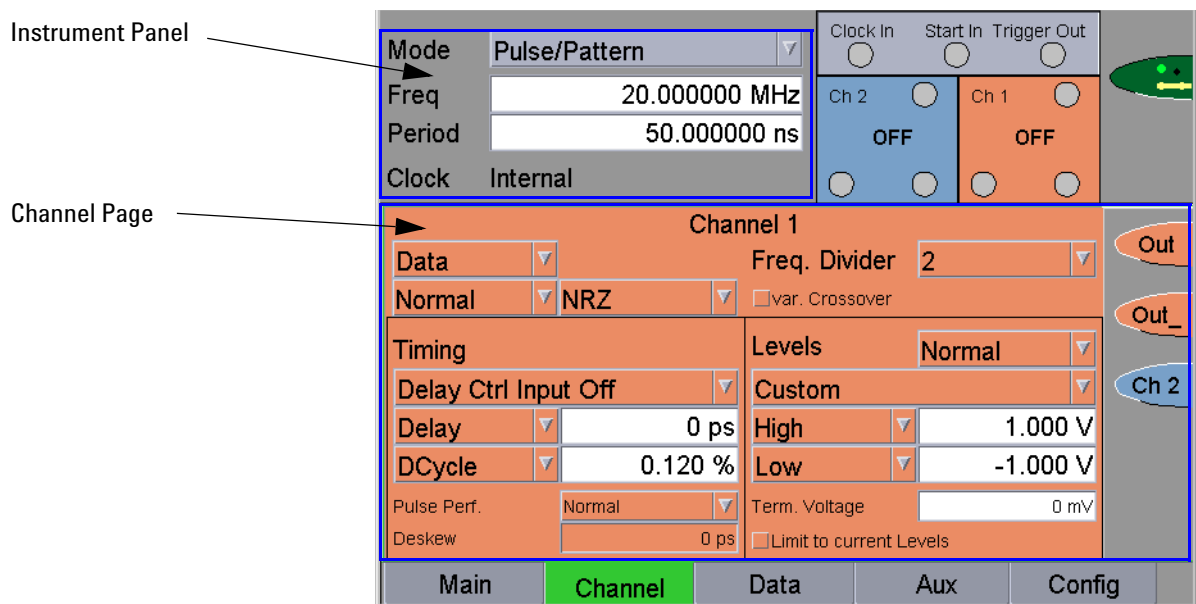

The parameters are available at the following panels and pages in the 81133A/81134A graphical user interface:

- Instrument Panel

The instrument panel is part of each page and provides controls that define the basic setup of the instrument, such as base frequency and instrument mode.

These controls affect all channels.

- Main Page

The Main page is used to display the results of the selftest and to store and recall your parameter settings.

- Channel Page

At the Channel page, you can specify the signal to be generated for each channel individually regarding pattern mode, timing, and levels.

- Data Page

At the Data page, you can set up an arbitrary data pattern up to the maximal available memory (8 kBit) per channel.

- Aux Page

The Aux page provides controls to specify:

- The Clock Source
- The Start Input
- The Trigger Output

- Config Page

If you want to program the instrument remotely, the Config page is used to set up all necessary parameters to establish the connection between the instrument and your control PC.

To access the individual pages, use the instrument's tab keys (located below the navigation knob).

**NOTE** For a detailed description of the pages and their parameters, please refer to the Online Help.

# Combining Parameters for Signal Generation

The following table shows you how the various modes and parameters can be combined. Empty cells indicate that the combination is not applicable:

Instrument Mode	Pulse/Pattern					Burst			RBurst		
Pattern Mode	Square	Pulse	Data/PRBS			Data			Data		
Signal Mode			R1	RZ	NRZ	R1	RZ	NRZ	R1	RZ	NRZ
Variable Crossover					30% ... 70%			30% ... 70%			30% ... 70%
Burst Length						1 ... 16384			4 ... 16384 (in increments of 4)		
Factor p (For calculating the length of the pause that follows the repeated data)									4 ... 16384 (in increments of 4)		

**NOTE** For the clock source, the Internal YIG Oscillator, External Clock Input and 10 MHz Reference can be used as the clock source for all combinations. The Internal Direct and External Direct can only be used as the clock source for Square pattern mode and NRZ signal mode.

## Instrument Modes

The instrument provides the following modes:

- Pulse/Pattern Mode

In this mode, each channel can be set independently to generate a continuous stream of:

- Square waves (clocks) of fixed width
- Pulses with selectable width or duty cycle

- Data in either RZ, R1 or NRZ format
- Pseudo random bit stream (PRBS) polynomials

For details on these signals, see *“Pattern Modes” on page 70*.

- Burst Mode

This mode enables you to generate a burst consisting of data repeated n times followed by continuous zero data.



In Burst mode, exactly one burst of data is output after either:

- Applying a external signal at the start input.
- Asserting a manual trigger on one of the remote interfaces.
- Pressing the start button on the user interface.

A burst consists of data packets repeated a selectable number of times (in data pattern mode).

- Repetitive Burst Mode

This mode enables you to generate a repetitive burst consisting of data repeated n times. A pause of zeros is inserted between two successive bursts.

The repetitive burst is specified by two numbers. The first number (n) defines how often the specified data is repeated. The second number (p) defines the length of the pause that follows the repeated data.

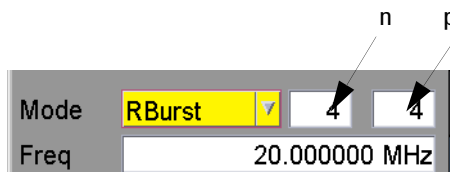

The length of the pause is calculated by:

$$p \times \text{Length of Data Packets}$$

## Pattern Modes

You can select the following pattern modes:

- Square  
Generates a square wave (clock) of fixed width (50% duty cycle).
- Pulse  
Generates pulses with selectable width or duty cycle.
- Data  
Generates data in either RZ, R1 or NRZ format. In RZ and R1 mode, the pulse width can be selected as either width or duty cycle.
- PRBS  
Generates a PRBS polynomial of selectable type in either RZ, R1 or NRZ format. In RZ and R1 mode, the pulse width can be selected as either width or duty cycle.

You can also select a frequency divider for all pattern modes.

## Signal Modes

In *Data* and *PRBS* pattern modes, the pulse output format can be selected from *RZ*, *R1*, and *NRZ*. The timing of the different format is shown in the following diagram:

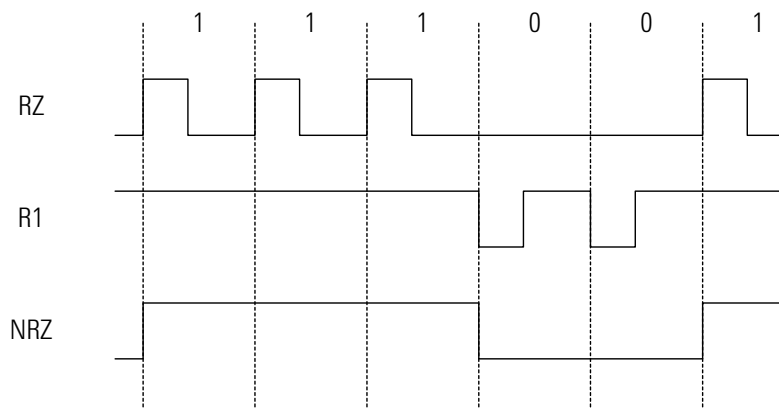

- **RZ**  
Return to 0 pulse format.  
On every 0 bit of the pattern, the signal remains low. On every 1 bit of the pattern, the signal goes to high and then back to low after the time specified by the pulse width or duty cycle parameter.
- **R1**  
Return to 1 pulse format.  
On every 1 bit of the pattern, the signal remains high. On every 0 bit of the pattern, the signal goes to low and then back to high after the time specified by the pulse width or duty cycle parameter.
- **NRZ**  
Non-return to zero pulse format.  
A leading edge is generated for a 0 -> 1 data transition, a trailing edge is generated for a 1 -> 0 data transition.

## Variable Crossover

You can change the crossover point in range 30% ... 70% of the NRZ signal separately for each channel. The variable crossover is used to artificially close the eye pattern, which simulates distortion.

The crossover adjustment is not calibrated except for the 50% point.

**Example** The figure below shows the normal and complement output with the crossover point set to 50% and 70% respectively.

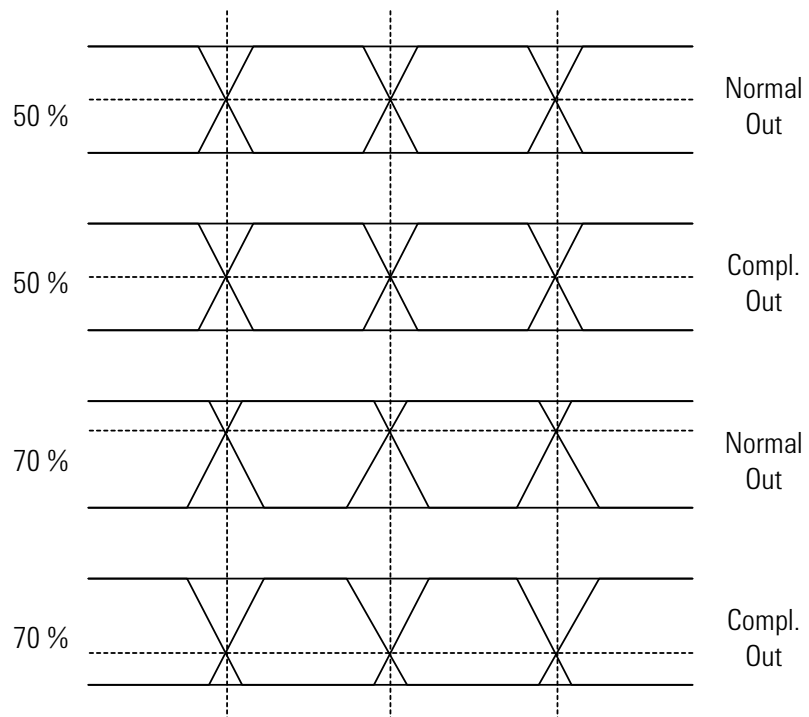



## Clock Sources

The selected clock source defines the time base from which all other timing parameters are derived. You can select between:

- Internal

The clock is derived from the internal YIG oscillator.

- External

Enables the external clock input (*Clock In*) to accept an external clock signal that forms the time base. The frequency is measured once by selecting the *Measure* function from the user interface or as a remote SCPI command (:MEASure:FREQuency?).

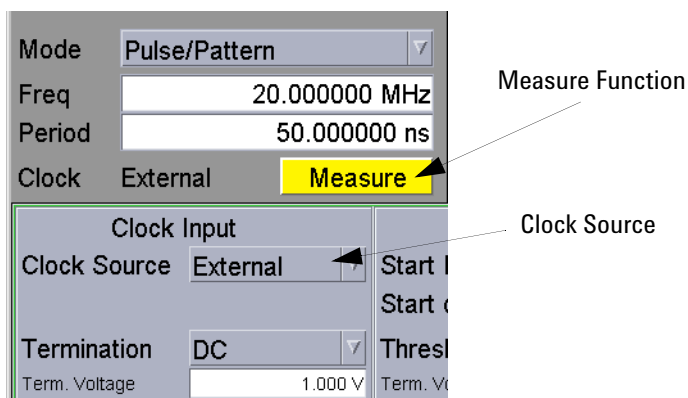

This value is then used to calculate frequency-dependent values, like the pulse width or the phase (available at the Channel page).

For more information about the *Measure* function, please refer to the Online Help.

- External 10 MHz Reference

Enables the external clock input (*Clock In*) to apply a 10 MHz reference clock. This clock is used as a reference for all timing parameters.

- Int. Direct/Ext. Direct

The direct modes allow changes of frequency without dropouts in the range of 1:2. They are used for applications (precise clock source) where dropouts would make a measurement impossible, for example, PLL frequency sweeps and microprocessor clock sweeps.

- Int. Direct

Allows you to vary the clock derived from the internal YIG oscillator in the range of one octave.

- Ext. Direct

Allows you to vary the frequency of the external clock signal in the range of one octave.

In external direct mode, the internal PLL is bypassed. This ensures that the instrument frequency exactly follows the external clock.

For both, Int. Direct and Ext. Direct, range switching occurs at the following frequencies:

- 1680 MHz
- 840 MHz
- 420 MHz
- 210 MHz
- 105 MHz
- 52.5 MHz
- 26.25 MHz

**NOTE** The range-switching frequencies are based on 1680 MHz divided by the frequency divider.

## Start Mode

When the *Ext. Input* start mode is selected, the instrument sends the generated signal to the outputs according to the signal applied at the *Start In* connector.

You can define the following parameters that the external signal must meet:

- Threshold (voltage)
- Termination voltage
- Edge (rising/falling)

If you select the *Ext. Input* mode, the instrument automatically switches in armed mode. This means, the instrument waits for the selected edge to appear.

The further behavior of the instrument depends on the selected instrument mode:

- In Burst Mode:  
As soon as the selected signal appears at the input, the armed mode is deactivated (the instrument sends one burst and then stops).
- In Pulse/Pattern and Repetitive Burst Mode:  
The instrument stays in armed mode (it sends the pattern/burst every time the selected signal appears). The trigger output frequency is calculated by dividing the instrument frequency by the length of the data pattern.

## Trigger Out

The trigger output can be set to one of the following modes:

- Trigger on pulse  
The trigger output is generated according to the instrument frequency. It can optionally be divided by 1 up to  $2^{31} - 1$  optionally.
- Trigger on data  
One trigger pulse is generated on every start of the repetitive data pattern. The trigger output frequency is calculated by dividing the instrument frequency by the length of the data pattern.

**NOTE** The trigger divider does not take the frequency divider of the channels into account. For a frequency divider of  $n$ ,  $n$  trigger pulses are generated for each data packet, starting with the first edge of bit 0 of the data packet.

To get one trigger pulse per data packet when the channel divider factor is not equal to 1, the trigger mode must set to *Trigger on pulse* and the divider to  $n \times X$ , where  $n$  is the frequency divider and  $X$  is the data length. For example, if the data length = 32 bits and the frequency divider of channel 1 = 2, the frequency divider of the trigger output has to be 64.

The trigger output can be enabled/disabled. The levels of the trigger output can be set as:

- Low Level – High Level
- Amplitude – Offset

## Timing of Generated Signals

The following sections provide information about the signals that can be generated and shows the typical timings.

The instrument allows you to generate the following signals:

- Clock signals
- Pulses
- Data patterns
- PRBS
- Started bursts
- Repetitive bursts

**NOTE** You can also set the frequency divider for all channels. The minimum frequency must remain above 15 MHz.

## Clock

The following figure shows the typical timing for the clock signal.

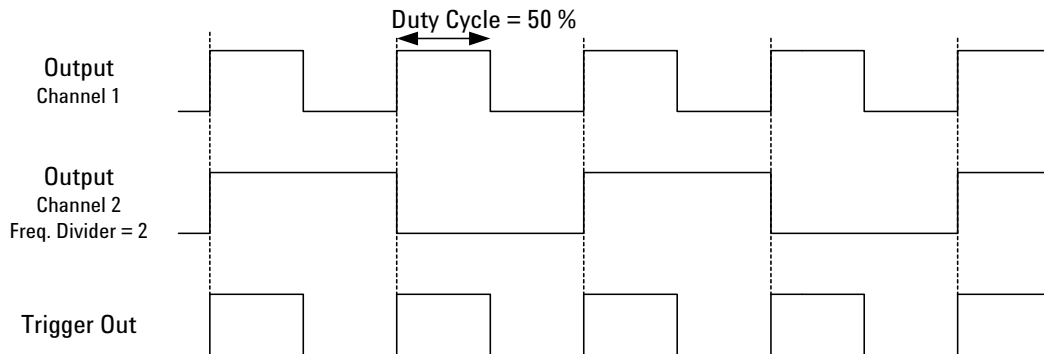

### Characteristics

- Pulse periods are generated continuously where:
  - Delay and deskew of all channels is zero.
  - The duty cycle is fixed at 50%.
- The instrument mode is *Pulse/Pattern*.
- The pattern mode is *Square*.
- For the clock source, you can select from:
  - *Internal* (YIG Oscillator)
  - *External* signal at Clock Input
  - *External 10 MHz Reference* at Clock Input
  - *Direct Internal*
  - *Direct External* at Clock Input

For more information about the clock sources, see “*Clock Sources*” on page 73.

- The Trigger Out is generated with every clock pulse, but can be optionally divided by any number in the range  $1 \dots 2^{31} - 1$ . See also “*Trigger Out*” on page 75.

## Pulses

The following figure shows the typical timing for continuous pulses.

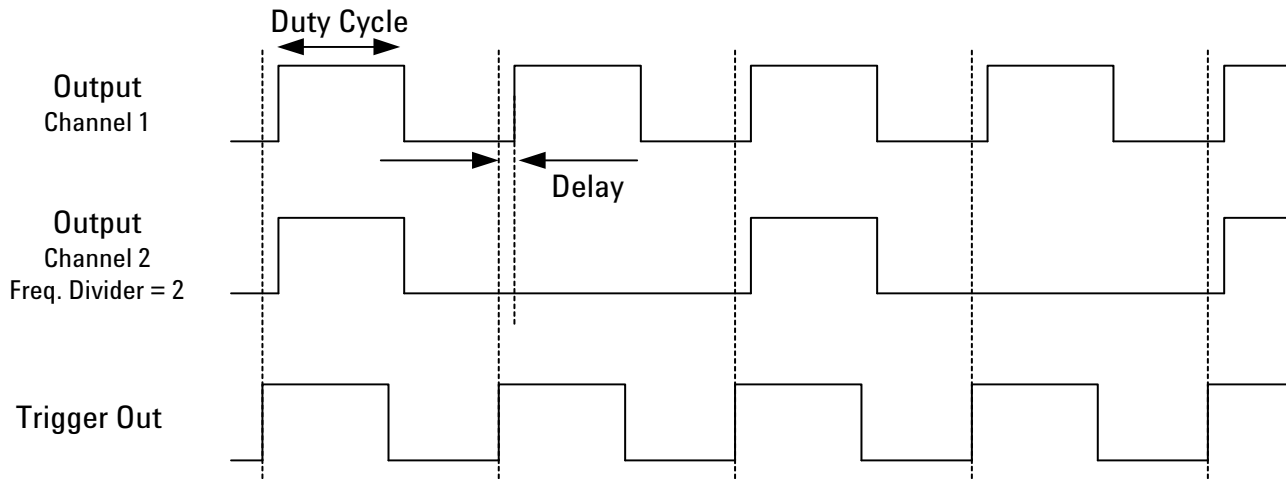

### Characteristics

- Pulse periods can be either generated continuously or can be started manually or by the arming source.
- Delay, pulse width (or duty cycle) and deskew can be set for each channel.
- The instrument mode is *Pulse/Pattern*.
- The pattern mode is *Pulse*.
- For the clock source, you can select from:
  - *Internal* (YIG Oscillator)
  - *External* signal at Clock Input
  - *External 10 MHz Reference* at Clock Input
 For more information about the clock sources, see “*Clock Sources*” on page 73.
- The Trigger Out is generated with every clock pulse, but can be optionally divided by any number in the range  $1 \dots 2^{31} - 1$ .  
See also “*Trigger Out*” on page 75.

## Data Pattern

The following figure shows the typical timing for a data pattern.

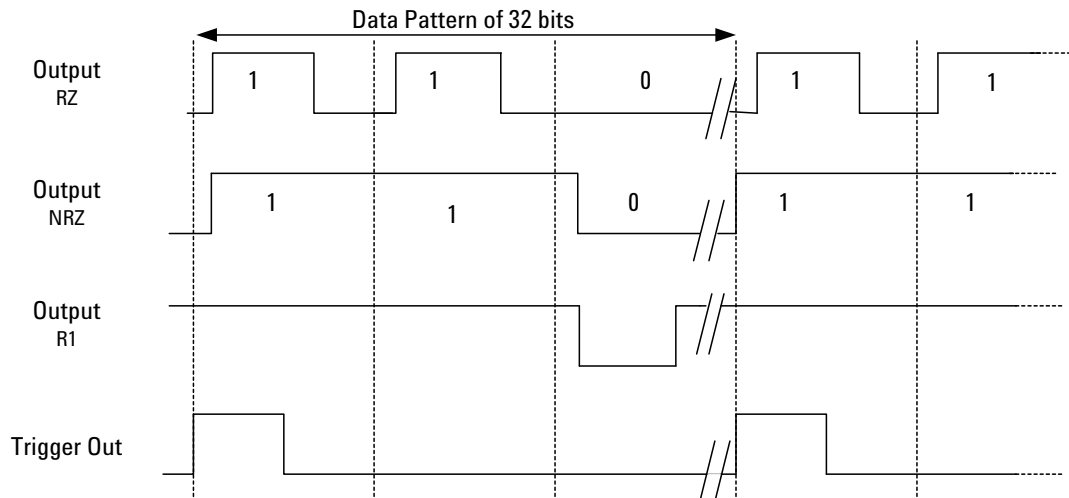

- Characteristics**
- A data pattern can be either generated continuously or can be started manually or by the arming source.
    - The data length is selectable in the range 32 ... 8192 bits (in steps of 32).
  - The instrument mode is *Pulse/Pattern*.
  - The pattern mode is *Data*.
  - You can select between RZ, NRZ and R1 signal modes for each output.
    - In R1 and RZ modes, the pulse width can be selected as either width or duty cycle.
  - You can select between normal and inverted signals for each output.
  - For the clock source, you can select from:
    - *Internal* (YIG Oscillator)
    - *External* signal at Clock Input
    - *External 10 MHz Reference* at Clock Input
 For more information about the clock sources, see “*Clock Sources*” on page 73.
  - The Trigger Out marks every start of the repetitive data pattern, as long as no frequency divider has been applied.
    - See also “*Trigger Out*” on page 75.

## PRBS

See “*Data Pattern*” on page 79 for for the timing diagram.

- Characteristics**
- A PRBS signal can be either generated continuously or can be started manually or by the arming source.  
The PRBS polynome is selectable from  $2^5 - 1 \dots 2^{31} - 1$ .
  - The instrument mode is *Pulse/Pattern*.
  - The pattern mode is *PRBS*.
  - You can select between RZ, NRZ and R1 signal modes for each output.  
In R1 and RZ modes, the pulse width can be selected as either width or duty cycle.
  - You can select between normal and inverted signals for each output.
  - For the clock source, you can select from:
    - *Internal* (YIG Oscillator)
    - *External* signal at Clock Input
    - *External 10 MHz Reference* at Clock InputFor more information about the clock sources, see “*Clock Sources*” on page 73.
  - The Trigger Out marks every start of the repetitive PRBS, as long as no frequency divider has been applied.  
See “*Trigger Out*” on page 75.



## Started Burst

The following figure shows the typical timing for the started burst. The bursts are started by the rising edge of the arming source.

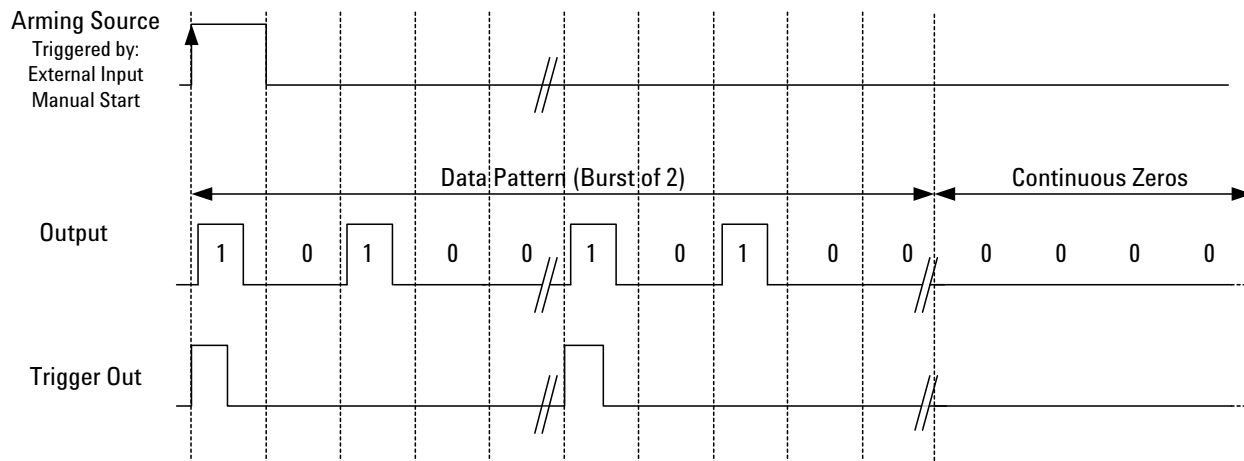

- Characteristics**
- A burst of repeated data is started manually or by the arming source.
  - You can select the number of repeated bursts in the range 1 ... 16384.
  - The instrument mode is *Burst*.
  - The pattern mode is *Data*.
  - You can select between RZ, NRZ and R1 signal modes for each output.  
In R1 and RZ modes, the pulse width can be selected as either width or duty cycle.
  - You can select between normal and inverted signals for each output.
  - For the clock source, you can select from:
    - *Internal* (YIG Oscillator)
    - *External* signal at Clock Input
    - *External 10 MHz Reference* at Clock Input
 For more information about the clock sources, see “*Clock Sources*” on page 73.
  - The Trigger Out marks every start of the repetitive data pattern, as long as no frequency divider has been applied.  
See also “*Trigger Out*” on page 75.

## Repetitive Burst

The following figure shows the typical timing for the repetitive burst.

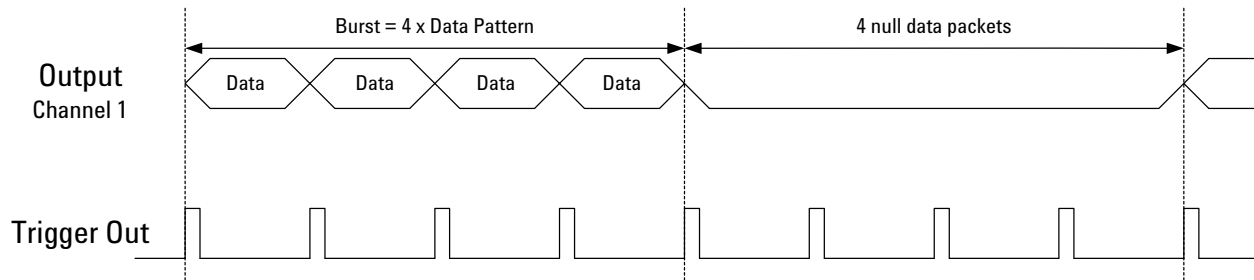

- Characteristics**
- A burst of repeated data can be either generated continuously or can be started manually or by the arming source.
  - You can select the number of repeated data in the range 4 ... 16384 (in increments of 4).
  - You can specify the factor  $p$  for calculating the length of the pause that follows the repeated data in the range 4 ... 16384 (in increments of 4):  

$$\text{null data length} = \text{Data pattern length} \times p$$
  - The instrument mode is *RBurst*.
  - The pattern mode is *Data*.
  - You can select between RZ, NRZ and R1 signal mode for each output.  
 In R1 and RZ mode, the pulse width can be selected as either width or duty cycle.
  - You can select between normal and inverted signals for each output.
  - For the clock source, you can select from:
    - *Internal* (YIG Oscillator)
    - *External* signal at Clock Input
    - *External 10 MHz Reference* at Clock Input
 For more information about the clock sources, see “*Clock Sources*” on page 73.
  - The Trigger Out marks every start of the repetitive data pattern, as long as no frequency divider has been applied.  
 See also “*Trigger Out*” on page 75.

## Jitter Modulation

The external source for jitter modulation is applied to the delay control input. Jitter modulation can be turned on and off individually for each channel. Either one of two fixed sensitivities can be selected.

The source for the jitter modulation input is assumed to be either a function generator or an arbitrary waveform generator. Both have the capability of setting the output levels. Therefore, the instrument has no capabilities of adjusting the jitter modulation input.

## Saving and Recalling Settings

For permanently saving the instrument setting, nine save/recall registers are provided.

All parameters are saved, including the data. User interface specifics, such as the current visible page, are not saved.

When the instrument is turned on, the last used setting is restored.





# Updating the Firmware

Firmware updates of the instrument can be done by using one of the supported programming interfaces.

Updates and patches are available on the Agilent Web at:

[http://www.agilent.com/find/pulse\\_generator](http://www.agilent.com/find/pulse_generator)

They are applied by downloading the update/patch from the web (single executable) and running it.

The connection path to the instrument is queried for the time the executable is run. A warning is issued if a new firmware revision would be overwritten by an older one. Nevertheless, this *down-grade* can be forced.

## Prerequisites

The instrument must be connected to a PC through one of the supported remote programming interfaces. The operating system running on the PC must be either Windows NT, Windows 2000, or Windows XP.

An upgrade/patch always includes all parts of the software (that is firmware and BIOS).



# Troubleshooting

This chapter provides basic troubleshooting tips that you can use if the instrument is not performing as expected.

## Instrument out of Specs

The specification is valid within +/- 10 degree Celsius after running Selfcalibration. If the operating temperature changes, you can run the SelfCal function. SelfCal is started by pressing the SelfCal softkey on the Main page.

## Outputs Disabled

The outputs are automatically turned off to protect the instrument when they are not terminated correctly.

In the user interface, check the termination mode and voltage for the output line in question, and make sure that the actual termination matches this.

## Unlock LED Lit

The Unlock LED lights up when an external clock source is used, and the set frequency/period of the clock source does not match the actual signal.

In this case, you can either enter the frequency of the clock source manually, or press *Measure* to cause the instrument to measure the frequency of the clock source.

## Display is Black

If the display is black, but you are sure the instrument is running, it is possible that the display was shut off remotely.

To reactivate the display, press any key. As a last resort, you can power the instrument down and back up. Before you do this, though, make sure that no one is carrying out remote tests using the instrument.

### **Instrument does not Respond**

If the instrument does not respond when you press a button, it is possible that it is being used remotely.

To reactivate the instrument, press the *Local* key (if this is available). As a last resort, you can power the instrument down and back up. Before you do this, though, make sure that no one is carrying out remote tests using the instrument.

### **Instrument not Operable via LAN**

If the instrument cannot be programmed via LAN, make sure that you have installed the latest Agilent I/O library on your computer.

Visit the Agilent web site for the newest version.



# Index

## A

---

advanced signals  
  setup 27  
Aux page 67

## B

---

benefits 14  
Burst (instrument mode) 69  
burst signal  
  example 46

## C

---

channel page  
  pages  
    channel 66  
cleaning recommendations 11  
clock  
  timing 77  
Clock Input 17  
clock jitter 14  
clock signal  
  example 28  
clock sources 73  
  ext. direct 73  
  external 10 MHz reference 73  
  int. direct 73  
  internal 73  
Config page  
  pages  
    Config 67

## D

---

data 14  
Data (pattern mode) 70  
Data page 67  
data pattern  
  example 40  
  timing 79  
declaration of conformity 12  
Delay Control Input 16  
delay modulation range 14  
delay range 14

## E

---

entering new values 23

environmental conditions  
  requirements 7  
error messages 87  
example  
  burst signal 46  
  clock signal 28  
  data pattern 40  
  pulse signal 36  
  repetitive burst signal 52  
  signals for stressed eye diagram  
  measurement 58  
example for jitter modulation 60  
example for setting the variable crossover 60  
ext. direct (clock source) 73  
external (clock source) 73  
external 10 MHz reference (clock source) 73

## F

---

frequency range 14  
front panel 15  
front panel inputs 16  
front panel outputs 16

## G

---

generated signals  
  timings 76  
generic signal  
  setup 27  
GPIB connector 18  
graphical user interface 15  
  pages 66  
ground the instrument 8

## I

---

initial inspection 9  
inputs 16  
  Clock Input 17  
  Delay Control Input 16  
  Start Input 17  
instrument cover removing 8  
instrument mode  
  Pulse/Pattern 68  
instrument modes 68  
  Burst 69  
  Repetitive Burst 69  
instrument panel 66  
int. direct (clock source) 73  
internal (clock sources) 73

internal PLL 74

## J

---

jitter modulation 83  
  example 60

## K

---

key features 14  
  clock jitter 14  
  data 14  
  delay modulation range 14  
  delay range 14  
  frequency range 14  
  PRBS 14  
  transition times 14  
  voltage amplitude 14

## L

---

LAN connector 18

## M

---

Main page 66  
modes  
  instrument 68  
  pattern 70  
  signal 71  
  trigger output 75  
modifying of units 24  
modifying of values 24

## N

---

navigation  
  through pages 20  
  through parameters 21  
navigation knob 16  
NRZ 71  
number field  
  changing 23  
numeric keys 15

## O

---

outputs 16  
  inverted Output 16  
  normal Output 16  
  Trigger Output 17

## P

- 
- pages
    - Aux 67
    - Data 67
    - graphical user interface 66
    - Main 66
    - scrolling 19
  - pages overview 20
  - parameter
    - selecting 21
  - parameter values
    - changing 19
  - pattern modes 70
    - Data 70
    - PRBS 70
    - Pulse 70
    - Square 70
  - PRBS 14
    - timing 80
  - PRBS (pattern mode) 70
  - Pulse (pattern mode) 70
  - pulse signal
    - example 36
  - Pulse/Pattern (instrument mode) 68
  - pulses
    - timing 78

## R

- 
- R1 71
  - rear panel 18
  - recalling settings 83
  - repetitive burst
    - timing 82
  - Repetitive Burst (instrument mode) 69
  - repetitive burst signal
    - example 52
  - requirements
    - cleaning 11
    - environmental conditions 7
    - power supply 8
    - safety 7
    - ventilation 10
  - RZ 71

## S

- 
- safety requirements 7
  - saving settings 83
  - scope
    - setup 63
  - setting up
    - advanced signals 27
    - generic signals 27
  - signal generation
    - combining parameters 68

- signal mode
  - NRZ 71
  - R1 71
  - RZ 71
- signal modes 71
- signals for stressed eye diagram measurement
  - example 58
- single digits
  - changing 25
- softkeys 15
- Square (pattern mode) 70
- Start Input 17
- start mode 75

## T

- 
- tab keys 15
  - timing
    - clock 77
    - data pattern 79
    - PRBS 80
    - pulses 78
    - repetitive burst 82
    - triggered burst 81
  - transition times 14
  - Trigger Out
    - modes 75
  - Trigger Output 17
  - trigger output
    - levels 76
  - trigger output levels 76
  - triggered burst
    - timing 81
  - troubleshooting 87

## U

- 
- units
    - modifying 24
  - USB connector 18

## V

- 
- values
    - entering 23
    - modifying 24
  - variable crossover 72
  - variable crossover setup
    - example 60
  - ventilation requirements 10
  - voltage amplitude 14

## W

- 
- waveform generator
    - setup 63



Copyright Agilent Technologies 2008  
Printed in Germany September 2008



5988-7401EN



**Agilent Technologies**