

Agilent 81130A 400/660MHz Pulse/Data Generator

## **Reference Guide**



**Agilent Technologies**

[www.valuetronics.com](http://www.valuetronics.com)

# Front Panel Display and Softkeys

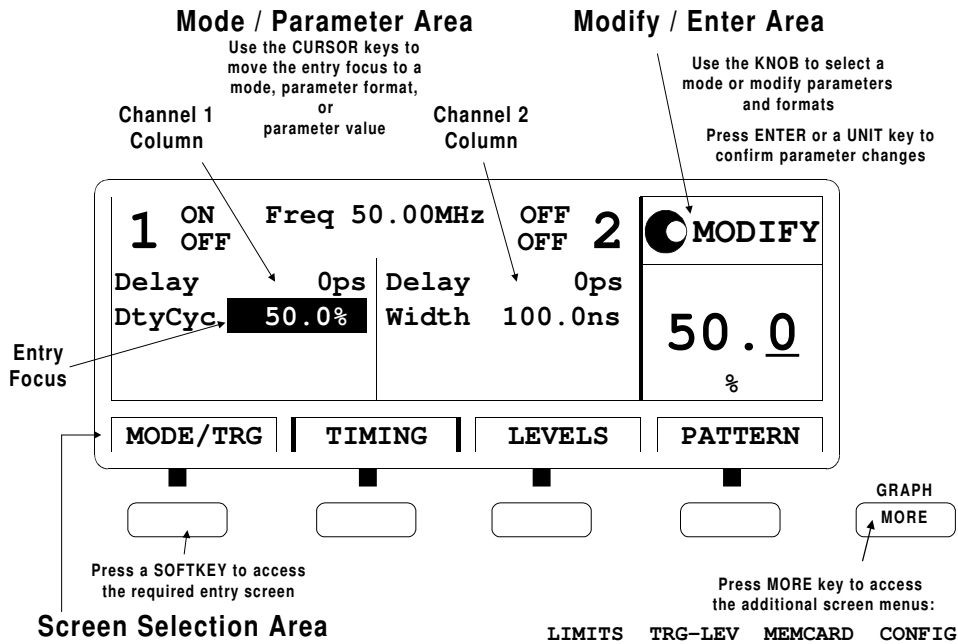

**Reference Guide**

**Agilent 81130A 400/660 MHz  
Pulse/Data Generator**

**Part No. 81130-91021**  
**Printed in Germany March 2000**  
**Edition 1.0, E0300**

## Notice

### Copyright

© 1998 Agilent Technologies 1998, 2000. All rights reserved.

No part of this manual may be reproduced in any form or by any means (including electronic storage and retrieval or translation into a foreign language) without prior agreement and written consent from Agilent Technologies Inc. as governed by United States and international copyright laws.

### Notice

The material contained in this document is subject to change without notice. Agilent Technologies makes no warranty of any kind with regard to this material, including, but not limited to, the implied warranties of merchantability and fitness for a particular purpose. Agilent Technologies shall not be liable for errors contained herein or for incidental or consequential damages in connection with the furnishing, performance, or use of this material.

### Warranty

This Agilent Technologies product has a warranty against defects in material and workmanship for a period of three years from date of shipment. During the warranty period, Agilent Technologies will, at its option, either repair or replace products that prove to be defective. For warranty service or repair, this product must be returned to a service facility designated by Agilent Technologies. The Buyer shall pay Agilent Technologies round-trip travel expenses. For products returned to Agilent Technologies for warranty service, the Buyer shall prepay shipping charges to Agilent Technologies and Agilent Technologies shall pay shipping charges to return the product to the Buyer. However, the Buyer shall pay all shipping charges, duties and taxes for products returned to Agilent Technologies from another country.

Agilent Technologies warrants that its software and firmware designated by Agilent Technologies for use with an instrument will execute its programming instructions when properly installed on that instrument. Agilent Technologies does not warrant that the operation of the instrument software, or firmware, will be uninterrupted or error free.

### **Limitation of Warranty**

The foregoing warranty shall not apply to defects resulting from improper or inadequate maintenance by the Buyer, Buyer-supplied software or interfacing, unauthorized modification or misuse, operation outside of the environmental specifications for the product, or improper site preparation or maintenance. No other warranty is expressed or implied. Agilent Technologies specifically disclaims the implied warranties of merchantability and fitness for a particular purpose.

### **Exclusive Remedies**

The remedies supplied are the Buyer's sole and exclusive remedies. Agilent Technologies shall not be liable for any direct, indirect, special, incidental, or consequential damages, whether based on contract, tort or any other legal theory.

### **Certification**

Agilent Technologies certifies that this product met its published specifications at the time of shipment. Agilent Technologies further certifies that its calibration measurements are traceable to the United States Institute of Standards and Technology, to the extent allowed by the Institute's calibrating facility, and to the calibration facilities of other International Standards Organization members.

### **Services and Support**

Any adjustment, maintenance, or repair of this product must be performed by qualified personnel. Contact your customer engineer through your local Agilent Technologies Service Center. You can find a list of local service representatives on the Web at:

<http://www.agilent.com/Service/English/index.html>

# Safety Summary

The following general safety precautions must be observed during all phases of operation of this instrument. Failure to comply with these precautions or with specific warnings elsewhere in this manual violates safety standards of design, manufacture, and intended use of the instrument. Agilent Technologies Inc. assumes no liability for the customer's failure to comply with these requirements.

## General

This product is a Safety Class 1 instrument (provided with a protective earth terminal). The protective features of this product may be impaired if it is used in a manner not specified in the operation instructions.

All Light Emitting Diodes (LEDs) used in this product are Class 1 LEDs as per IEC 60825-1.

## Environmental Conditions

This instrument is intended for indoor use in an installation category II, pollution degree 2 environment. It is designed to operate at a maximum relative humidity of 95% and at altitudes of up to 2000 meters. Refer to the specifications tables for the ac mains voltage requirements and ambient operating temperature range.

## Before Applying Power

Verify that the product is set to match the available line voltage, the correct fuse is installed, and all safety precautions are taken. Note the instrument's external markings described under *"Safety Symbols" on page 8*.

## **Ground the Instrument**

To minimize shock hazard, the instrument chassis and cover must be connected to an electrical protective earth ground. The instrument must be connected to the ac power mains through a grounded power cable, with the ground wire firmly connected to an electrical ground (safety ground) at the power outlet. Any interruption of the protective (grounding) conductor or disconnection of the protective earth terminal will cause a potential shock hazard that could result in personal injury.

## **Fuses**

Only fuses with the required rated current, voltage, and specified type (normal blow, time delay, etc.) should be used. Do not use repaired fuses or short-circuited fuse holders. To do so could cause a shock or fire hazard.

## **Do Not Operate in an Explosive Atmosphere**

Do not operate the instrument in the presence of flammable gases or fumes.

## **Do Not Remove the Instrument Cover**

Operating personnel must not remove instrument covers. Component replacement and internal adjustments must be made only by qualified service personnel.

Instruments that appear damaged or defective should be made inoperative and secured against unintended operation until they can be repaired by qualified service personnel.

## Safety Summary

### Safety Symbols



Caution (refer to accompanying documents)



Protective earth (ground) terminal

In the manuals:

---

#### **WARNING**

**The WARNING sign denotes a hazard. It calls attention to a procedure, practice, or the like, which, if not correctly performed or adhered to, could result in personal injury. Do not proceed beyond a WARNING sign until the indicated conditions are fully understood and met.**

---

---

#### **CAUTION**

The CAUTION sign denotes a hazard. It calls attention to an operating procedure, or the like, which, if not correctly performed or adhered to, could result in damage to or destruction of part or all of the product. Do not proceed beyond a CAUTION sign until the indicated conditions are fully understood and met.

---



## About this Book

This guide provides reference information primarily for programming the Agilent 81130A via remote control.

*Chapter 1 “General Programming Aspects” on page 13* gives general hints for programming instruments like the Agilent 81130A using SCPI commands.

*Chapter 2 “Programming Reference” on page 25* provides detailed information on the SCPI commands supported by the instrument.

*Chapter 3 “Specifications” on page 95* lists the instrument’s technical specifications and provides exact definitions for the instrument’s parameters.

For an introduction and information on the Agilent 81130A’s user interface, please refer to the *Quick Start Guide*, p/n 81130-91020.

## Conventions Used in this Book

This book uses certain conventions to indicate elements of the Agilent 81130A's user interface. The following table shows some examples:

---

Softkeys	Press the MODE/TRG softkey to access the Mode/Trigger screen.
Hardkeys	Press the MORE key to switch to the alternative softkey layout.
Alternate Keys	Press SHIFT + 0 (ON/OFF1) to switch on output1. The alternate key label—which is selected by pressing the SHIFT key—is given in parentheses.
Screen Quotes	Move the entry focus down to PULSE-PERIOD and turn the knob to select INTERNAL PLL.
Entry Focus	The highlight field, that can be moved with the cursor keys, to change modes, parameters, or parameter formats.
:VOLTage:HIGH 3V	Full command for programming a 3 V high level. The upper case letters represent the short form of the command, which results in faster programming times.
*RST	Common IEEE 488 command, to reset instrument to default status.

---

# Contents

	<b>Notice .....</b>	<b>4</b>
	<b>Safety Summary .....</b>	<b>6</b>
	<b>About this Book .....</b>	<b>9</b>
<b>Chapter 1</b>	<b>General Programming Aspects</b>	
	<b>The GP-IB Interface Bus .....</b>	<b>14</b>
	<b>Agilent 81130A Remote Control .....</b>	<b>15</b>
	<b>Programming Recommendations .....</b>	<b>16</b>
	<b>Common Command Summary .....</b>	<b>18</b>
	<b>Status Model .....</b>	<b>19</b>
<b>Chapter 2</b>	<b>Programming Reference</b>	
	<b>Agilent 81130A SCPI Command Summary .....</b>	<b>26</b>
	<b>Default Values, Standard Settings .....</b>	<b>34</b>
	<b>Programming the Instrument Trigger Modes .....</b>	<b>38</b>
	<b>SCPI Instrument Command List .....</b>	<b>42</b>
<b>Chapter 3</b>	<b>Specifications</b>	
	<b>Declaration of Conformity .....</b>	<b>96</b>

# Contents

<b>Agilent 81130A Specifications .....</b>	<b>97</b>
General .....	97
Timing Specifications .....	99
Main Output Level Specifications .....	102
External Input, External Clock/PLL Reference Input .....	103
Trigger Modes .....	105
Output Modes .....	106
Human Interface .....	108
Memory .....	109
Remote Control .....	109
<b>Pulse Parameter Definitions .....</b>	<b>111</b>

---

# 1

---

## General Programming Aspects

This chapter provides general information on writing GP-IB/SCPI programs for instruments like the Agilent 81130A.

Detailed information on programming the Agilent 81130A can be found in *Chapter 2 “Programming Reference” on page 25*.

## The GP-IB Interface Bus

The GP Interface Bus is the interface used for communication between a controller and an external device, such as the Agilent 81130A. The GP-IB conforms to IEEE standard 488-1987, ANSI standard MC 1.1, and IEC recommendation 625-1.

If you are not familiar with the GP-IB, please refer to the following books:

- The Institute of Electrical and Electronic Engineers: IEEE Standard 488.1-1987, *IEEE Standard Digital Interface for Programmable Instrumentation*.
- The Institute of Electrical and Electronic Engineers: IEEE Standard 488.2-1987, *IEEE Standard Codes, Formats, and Common Commands for Use with IEEE Standard 488.1-1987*.

## Agilent 81130A Remote Control

**GP-IB Address** You can only set the GP-IB address from the front panel of the instrument (refer to the *Quick Start Guide*).

The default GP-IB address is 10.

**Modes of  
Operation**

The Agilent 81130A has two modes of operation:

- Local  
The instrument is operated using the front panel keys.
- Remote  
After receiving the first command or query via the GP-IB, the instrument is put into remote state. The front panel is locked. To return to local operating mode, press SHIFT (LOCAL).

## Programming Recommendations

Here are some recommendations for programming the instrument:

- Start programming from the default setting. The common command for setting the default setting is:

```
*RST
```

- Switch off the automatic update of the display to increase the programming speed. The device command for switching off the display is:

```
:DISPlay OFF
```

- The SCPI standard defines a long and a short form of the commands. For fast programming speed it is recommended to use the short forms. The short forms of the commands are represented by upper case letters. For example the short form of the command to set 100 ns delay is:

```
:PULS:DEL 100NS
```

- To improve programming speed it is also allowed to skip optional subsystem command parts. Optional subsystem command parts are depicted in square brackets, e.g.: set amplitude voltage of output 1: [SOURce]:VOLTage[1][:LEVel][:IMMediate][:AMPLitude]. Sufficient to use: :VOLT 1.2V

- For the commands to set the timing and level parameters, except of period/frequency, you can explicitly specify the output to be programmed (for compatibility reasons). If there is no output specified, the commands will set the default output 1.

So, for setting a high level of 3 Volts for output 1 the commands are:

```
:VOLT:HIGH 3V      # sets high level of 3 V at out 1  
:VOLT1:HIGH 3V    # sets high level of 3 V at out 1
```



- It is recommended to test a new setting that will be programmed on the instrument by setting it up manually.  
Enable the outputs so that the instrument's error check system is on and possible parameter conflicts are immediately displayed.  
When you have found the correct setting, then use this to create the program. In the program it is recommended to send the command for enabling outputs (for example, :OUTPut ON) as the last command.
- Selftest of the instrument can be invoked by the common command  
\*TST
- If it is important to know whether the last command is completed, then send the common command  
\*OPC?

---

## Common Command Summary

This table summarizes the IEEE 488.2 common commands supported by the Agilent 81130A:

---

Command	Parameter	Description
*CLS	–	Clear the status structure
*ESE	<0–255>	Set the Standard Event Status register mask
*ESE?	–	Read the state of the Standard Event Status enable register
*ESR?	–	Read the state of the Standard Event Status event register
*IDN?	–	Read the Instrument's Identification string
*LRN?	–	Read the complete Instrument Setting
*OPC	–	Set the Operation Complete bit when all pending actions are complete
*OPC?	–	Read the status of the Operation Complete bit
*OPT?	–	Read the installed options
*RCL	<0–4>	Recall a complete Instrument Setting from memory
*RST	–	Reset the instrument to standard settings
*SAV	<1–4>	Save the complete Instrument Setting to memory
*SRE	<0–255>	Set the Service Request Enable Mask
*SRE?	–	Read the Service Request Enable Mask
*STB?	–	Read the Status Byte
*TRG	–	Trigger
*TST?	–	Execute instrument's selftest
*WAI	–	Wait until all pending actions are complete

---

# Status Model

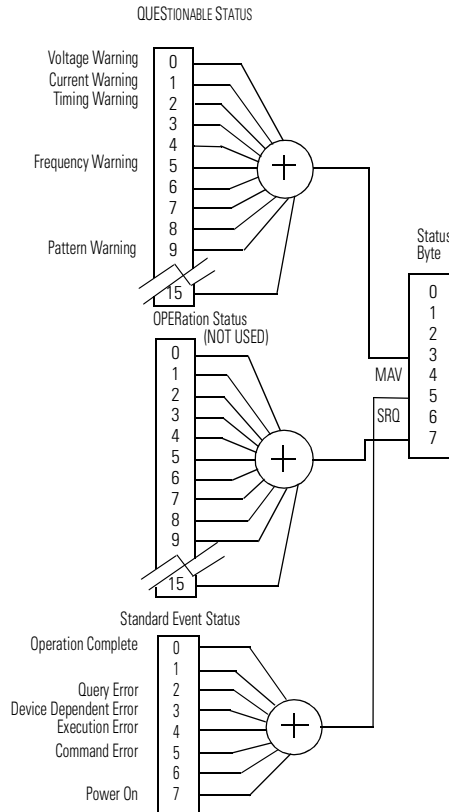

The instrument has a status reporting system conforming to IEEE 488.2 and SCPI. The above figure shows the status groups available in the instrument.

Each status group is made up of component registers, as shown in the following figure.

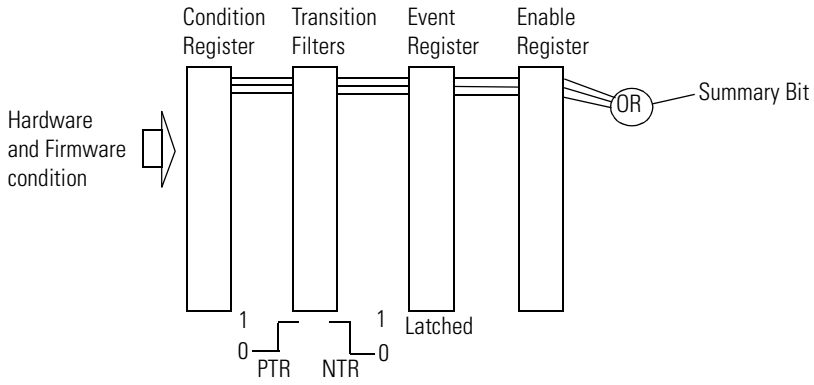

## Condition Register

A condition register contains the current status of the hardware and firmware. It is continuously updated and is not latched or buffered. You can only read condition registers. If there is no command to read the condition register of a particular status group, then it is simply invisible to you.

## Transition Filters

Transition filters are used to detect changes of state in the condition register and set the corresponding bit in the event register. You can set transition filter bits to detect positive transitions (PTR), negative transitions (NTR) or both. Transition filters are therefore read/write registers. They are unaffected by \*CLS.

## Event Register

An event register latches transition events from the condition register as specified by the transition filters or records status events. Querying (reading) the event register clears it, as does the \*CLS command. There is no buffering, so while a bit is set, subsequent transition events are not recorded. Event registers are read only.

## Enable Register

The enable register defines which bits in an event register are included in the logical OR into the summary bit. The enable register is logically ANDed with the event register and the resulting bits ORed into the summary bit. Enable registers are read/write, and are not affected by \*CLS or querying.

Although all status groups have all of these registers, not all status groups actually use all of the registers. The following table summarizes the registers used in the instrument status groups.

Status Group	Registers in Group				
	CONDition	NTR	PTR	EVENTt	ENABLE
QUEStionable	√	√	√	√	√
OPERation <sup>1</sup>	<b>x</b>	<b>x</b>	<b>x</b>	<b>x</b>	<b>x</b>
Standard Event Status	<b>x</b>	<b>x</b>	<b>x</b>	√ <sup>2</sup>	√ <sup>3</sup>
Status Byte	<b>x</b>	<b>x</b>	<b>x</b>	√ <sup>4</sup>	√ <sup>5</sup>

1 Present, but not used. COND and EVEN always 0.

2 Use \*ESR? to query.

3 Use \*ESE to set, \*ESE? to query

4 Use \*STB? to query

5 Use \*SRE to set, \*SRE? to query

## Status Byte

The status byte summarizes the information from all other status groups. The summary bit for the status byte actually appears in bit 6 (RQS) of the status byte. When RQS is set it generates an SRQ interrupt to the controller indicating that at least one instrument on the bus requires attention. You can read the status byte using a serial poll or \*STB?

---

Bit	Description
0	Unused, always 0
1	Unused, always 0
2	Unused, always 0
3	QUESTionable Status Summary Bit
4	MAV—Message Available in output buffer
5	Standard Event Status summary bit
6	RQS; ReQuest Service
7	OPERation Status summary Bit, unused

---

## Standard Event Status Group

---

Bit	Description
0	Operation Complete, set by *OPC
1	Unused, always 0
2	Query Error
3	Device Dependent Error
4	Execution Error
5	Command Error
6	Unused, always 0
7	Power On

---

## OPERation Status Group

This Status Group is not used in the instrument.

---

<b>Bit</b>	<b>Description</b>
0	Unused, always 0
1	Unused, always 0
2	Unused, always 0
3	Unused, always 0
4	Unused, always 0
5	Unused, always 0
6	Unused, always 0
7	Unused, always 0
8	Unused, always 0
9	Unused, always 0
10	Unused, always 0
11	Unused, always 0
12	Unused, always 0
13	Unused, always 0
14	Unused, always 0
15	Always 0

---

### QUEStionable Status Group

---

Bit	QUEStionable
0	Voltage warning
1	Current warning
2	Time warning
3	Unused, always 0
4	Unused, always 0
5	Frequency warning
6	Unused, always 0
7	Unused, always 0
8	Unused, always 0
9	Pattern warning
10	Unused, always 0
11	Unused, always 0
12	Unused, always 0
13	Unused, always 0
14	Unused, always 0
15	Always 0

---

The QUEStionable Status group is used to report warning conditions amongst the voltage, current, pulse timing, frequency and pattern parameters. Warnings occur when a parameter, although not outside its maximum limits, could be causing an invalid signal at the output because of the actual settings and uncertainties of related parameters.



---

# 2

---

## Programming Reference

This chapter provides reference information on the following topics:

- *“Agilent 81130A SCPI Command Summary” on page 26*
- *“Default Values, Standard Settings” on page 34*
- *“Programming the Instrument Trigger Modes” on page 38*
- *“SCPI Instrument Command List” on page 42*

For general programming information, please refer to *Chapter 1 “General Programming Aspects” on page 13*.

# Agilent 81130A SCPI Command Summary

Command	Parameter	Description	see page
:ARM		(Trigger mode and source)	
[:SEQuence[1]   :START]			
[:LAYer[1]]			
:LEVel			
[:THReshold]	<value>	Set/read threshold level at EXT INPUT	<a href="#">43</a>
:TERMination	<value>	Set/read the termination voltage at EXT INPUT	<a href="#">43</a>
:MODE	GATed   STARTed	Set/read the trigger mode, if the source is <b>not</b> IMMEDIATE	<a href="#">43</a>
:SENSe	POSitive   NEGative	Set/read trigger on edge or gate on level	<a href="#">44</a>
:SOURce	EXT1   IMM   MAN	Set/read trigger source (EXT INPUT   IMMEDIATE   MAN key)	<a href="#">44</a>
:INITiate			
:CONTinuous	ON   OFF   1   0	Starts or stops the instrument, if the arming source is <b>not</b> IMMEDIATE	<a href="#">45</a>
:CHANnel			
:MATH	OFF   DIGital	Set/read addition of channels of channels 1 & 2 at output 1	<a href="#">45</a>

Command	Parameter	Description	see page
:DIGital			
[:STIMulus]			
:PATTERn			<a href="#">48</a>
:LOOP			<a href="#">45</a>
:INFinite			<a href="#">46</a>
[:STATe]	ON   OFF   1   0	Enables/Disables the infinite loop	
:START	SEGM1   SEGM2   SEGM3   SEGM4	Set/read the start of the infinite loop (the segment to restart the output after the last bit of the last used segment)	<a href="#">47</a>
[:LEVEl [1]]			
[:COUNT]	<value>	Set/read the segment loop count	
:START	SEGM1   SEGM2   SEGM3   SEGM4	Set/read the start segment for the counted segment loop	<a href="#">47</a>
:LENGTh	1   2   3   4	Set/read the number of segments within the segment loop	<a href="#">48</a>
:PRBS	<base>	Set/read the PRBS base (the same for all PRBS segments!)	<a href="#">48</a>
:SEGMENT [1   2   3   4]			
:DATA [1   2]	<data>	Set/read pattern data	<a href="#">49</a>
:LENGTh	<segment-length>	Set/read the length of the segment (if the length is increased, '0' bits are appended)	<a href="#">52</a>
:PRESet [1   2]	[<n>],<length>	Set preset pattern with frequency CLOCK + n	<a href="#">53</a>
:TYPE [1   2]	DATA   PRBSHIGH   LOW	Set/read the type of the segment	<a href="#">53</a>
[:STATe]	OFF   ON   0   1	Switch PATTERN pulse-mode on or off	
:UPDate	OFF   ON   ONCE	Update the hardware with pattern data	<a href="#">54</a>
:SIGNAl [1   2]			
:FORMAt	RZ   R1   NRZ	Set/read data format of output channel	<a href="#">54</a>

Programming Reference  
**Agilent 81130A SCPI Command Summary**

<b>Command</b>	<b>Parameter</b>	<b>Description</b>	<b>see page</b>
:DISPlay			<a href="#">55</a>
[:WINDow]			
[:STATe]	ON OFF 1 0	Set/read frontpanel display state	
:MMEMory			
:CATalog?	[A:]	Read directory of memory card	<a href="#">56</a>
:CDIRectory	<name>	Change directory on memory card	<a href="#">56</a>
:COPIY	<source>[,A:],<dest> [,A:]	Copy a file on memory card	<a href="#">57</a>
:DELete	<name>[,A:]	Delete a file from memory card	<a href="#">57</a>
:INITialize	[A:[DOS]]	Initialize memory card to DOS format	<a href="#">58</a>
:LOAD			
:STATe	<n>,<name>	Load file from memory card to memory n	<a href="#">58</a>
:STORe			
:STATe	<n>,<name>	Store memory n to memory card	<a href="#">58</a>
:OUTPut [1 2]			<a href="#">59</a>
[:NORMal]			
[:STATe]	OFF ON 1 0	Set/read normal output state	
:COMPliment			<a href="#">59</a>
[:STATe]	OFF ON 1 0	Set/read complement output state	

Command	Parameter	Description	see page
[:SOURce]			
:CORRection[1 2]			
	:EDELay		<a href="#">60</a>
	[:TIme]	<value>	Set/read channel delay deskew
:CURRent[1 2]		The CURRent and VOLTage subsystem cannot be used at the same time. Use the :HOLD command to select between them.	<a href="#">60</a>
[:LEVel]			
[:IMMediate]			
	[:AMPLitude]	<value>	Set/read channel amplitude current
	:OFFSet	<value>	Set/read channel offset current <a href="#">61</a>
	:HIGH	<value>	Set/read channel high-level current <a href="#">62</a>
	:LOW	<value>	Set/read channel low-level current <a href="#">63</a>
:LIMit			
	:HIGH	<value>	Set/read maximum current limits <a href="#">63</a>
	:LOW	<value>	Set/read minimum current limits <a href="#">64</a>
	:STATe	ON OFF 1 0	Enable/Disable the current limits <a href="#">64</a>
:FREQuency		<value>	Set/read frequency of pulses <a href="#">65</a>
[:CW]			
[:FIXed]			
	:AUTO	ONCE	Do a frequency measurement at CLK IN <a href="#">66</a>
:HOLD[1 2]	VOLT CURR		Switch between VOLTage and CURRent command subtrees <a href="#">66</a>

## Programming Reference

### Agilent 81130A SCPI Command Summary

Command	Parameter	Description	see page
[:SOURce]			
:PHASe[1 2]	<value>		67
[:ADJust]	<value>	Set/read channel phase	
:PULSe			
:DCYClE[1 2]	<value>	Set/read channel dutycycle	67
:DELay[1 2]	<value>	Set/read channel delay (to leading edge)	68
:HOLD	TIME PRATio	Hold absolute delay delay as period fixed with varying frequency	69
:UNIT	S SEC PCT DEG  RAD	Set/read delay units	70
:HOLD[1 2]	WIDTh DCYClE  TDELay	Hold Width DutyCycle Trailing edge delay fixed with varying frequency	70
:PERiod	<value>	Set/read pulse period	70
:AUTO	ONCE	Measure pulse period at CLK IN	71
:TDElay[1 2]	<value>	Set/read trailing edge delay	72
:TRANSition[1 2]			
:UNIT	S SEC PCT	Set/read transition-time units	72
[:LEADing]	<value>	Set/read leading-edge transition	
:TRAILing	<value>	Set/read trailing-edge transition	73
:TRIGger[1]			
:MODE	CONTInuous STARt	Set/read the mode of the trigger output signal generation (ignored if not in pattern mode)	74
:POSition	1 2 3 4	Set/read the trigger output signal position	74
:VOLTage			
[:LEVel]			74
[:IMMediate]	TTL PECL SYM  ECLGND ECLN2V	Set/read TRIGGER OUTput levels	
:WIDTh[1 2]	<value>	Set/read channel pulse-width	75

Command	Parameter	Description	see page
[:SOURce]			
:ROSCillator			
:SOURce	INTernal EXTernal	Set/read PLL reference source	<a href="#">76</a>
:EXTernal			
:FREQuency	<value>	Set/read frequency of external PLL reference. Value will be rounded to 1 MHz, 2 MHz, 5 MHz or 10 MHz.	<a href="#">76</a>
:VOLTage[1 2]			<a href="#">77</a>
[:LEVel]			
[:IMMediate]			
[:AMPLitude]	<value>	Set/read channel amplitude voltage	
:OFFSet	<value>	Set/read channel offset voltage	<a href="#">77</a>
:HIGH	<value>	Set/read channel high-level voltage	<a href="#">78</a>
:LOW	<value>	Set/read channel low-level voltage	<a href="#">79</a>
:LIMit			
[:HIGH]	<value>	Set/read maximum voltage limit	<a href="#">80</a>
:LOW	<value>	Set/read minimum voltage limit	<a href="#">80</a>
:STATe	ON OFF 1 0	Enable Disable the voltage limits	<a href="#">81</a>

Programming Reference  
**Agilent 81130A SCPI Command Summary**

<b>Command</b>	<b>Parameter</b>	<b>Description</b>	<b>see page</b>
:STATus			
:OPERation			<a href="#">81</a>
[:EVENT]?		Read Operation event register	<a href="#">81</a>
:CONDition		Read Operation condition register	<a href="#">81</a>
:ENABle	Numeric	Set/Read Operation enable register	<a href="#">81</a>
:NTRansition	Numeric	Set/Read Operation negative-transition register	<a href="#">81</a>
:PTRansition	Numeric	Set/Read positive-transition register	<a href="#">81</a>
:PRESet		Clear and preset status groups	<a href="#">82</a>
:QUEStionable			<a href="#">82</a>
[:EVENT]?		Read Questionable event register	<a href="#">82</a>
:CONDition?		Read Questionable condition register	<a href="#">82</a>
:ENABle	Numeric	Set/Read Questionable enable register	<a href="#">82</a>
:NTRansition	Numeric	Set/Read Questionable negative-transition register	<a href="#">82</a>
:PTRansition	Numeric	Set/Read Questionable positive-transition register	



Command	Parameter	Description	see page
:SYSTem			
:ERRor?		Read error queue	84
:KEY	Numeric	Simulate key press or read last key pressed	84
:PRESet		no function	87
:SECurity			87
[:STATe]	ON/OFF	Switch security on and off	
:SET	Block data	Set/read complete instrument setting	88
:VERSion?		Read SCPI compliance setting	88
:WARNing			88
[:COUNT]?		Read number of active warnings	
:STRing?		Read active warnings as concatenated string	89
:BUFFer?		Read maximum possible length of concatenated string	89
:TRIGger			
		(Pulse mode and period source)	
[:SEQuence [1]]   :STARt]			
:COUNT	<value>	Set/read number of triggered periods to be generated per ARM event (BURST period)	89
:PULSes[1 2]	<value>	Set/red the number of pulses within the triggered periods at OUTput 1 or OUTput 2	92
:LEVel			
:TERMination	<value>	Set/read termination voltage level at CLK IN	92
:SOURce	IMM   INT[1]   EXT2	Set/read trigger source (Immediate   PLL   CLK IN)	93

## Default Values, Standard Settings

Parameter		*RST, Default Values	
:ARM	:LEVel	[:THReshold] +1.0 V	
		:TERM +0.0 V	
	:MODE	STARted	
	:SENSe	POS	
	:SOURce	IMM	
	:INITiate	:CONTinuous ON	
	:CHANnel	:MATH OFF	
	:DIGital	:PATtern:	OFF
			:LOOP:INFinite ON
			:LOOP:INFinite:STARt SEGM1
		:LOOP 1	
		:LOOP:STARt SEGM1	
		:LOOP:LENGth 1	
		:PRBS 7	
		:SEGMENT:DATA see <a href="#">page 49</a>	
		:SEGMENT:LENGth 32, 0, 0, 0	
		:SEGMENT:PRESet not applicable	
	:SEGMENT:TYPE DATA		
	:UPDate ON		
:DISPlay	:SIGNAL	:FORMat RZ	
		ON	
:MMEMory	:CATalog?	not applicable	
	:CDIRectory	not applicable	
	:COPY	not applicable	
	:DELeTe	not applicable	

Parameter			*RST, Default Values
	:INITialize		not applicable
	:LOAD	:STATe	not applicable
	:STORE	:STATe	not applicable
:OUTPut			OFF
	:COMPLement		OFF
:CORRection	:EDELay		0.0 s
:CURRent			20 mA (50 $\Omega$ into 50 $\Omega$ )
	:OFFSet		0.0 $\mu$ A (50 $\Omega$ into 50 $\Omega$ )
	:HIGH		+10 mA (50 $\Omega$ into 50 $\Omega$ )
	:LOW		-10 mA (50 $\Omega$ into 50 $\Omega$ )
	:LIMit	[:HIGH]	+10.0 mA
		:LOW	-10 mA
		:STATe	OFF
:FREQuency			1.00 MHz
	:AUTO		not applicable
:HOLD			VOLT
:PHAS			0.0
:PULSe	:DCYCLE		10.0% (derived from Width and Period)
	:DELay		0.00
		:HOLD	TIME
		:UNIT	SEC
	:HOLD		WIDTh
	:PERiod		1 $\mu$ s
		:AUTO	not applicable
	:TDELay		100 ns
	:TRANsition	:HOLD	TIME
		:UNIT	SEC

Programming Reference  
**Default Values, Standard Settings**

<b>Parameter</b>		<b>*RST, Default Values</b>
	[:LEADING]	0.8 ns (Agilent 81131A) or not applicable
	:TRailing	0.8 ns (Agilent 81131A) or not applicable
	:TRailing:AUTO	ON
:TRIGger:	:MODE	START
	:POSition	1
	:VOLTage	TTL
	:WIDTH	100 ns
:ROSCillator	:SOURce	INT
	:EXTernal	:FREQuency
		5 MHz
:VOLTage		1.00 V
	:OFFSet	0.0 mV
	:HIGH	500 mV
	:LOW	-500 mV
	:LIMit	[HIGH]
		+500 mV
		:LOW
		-500 mV
		:STATe
		OFF
:STATus	:OPERation	not applicable
	:PRESet	not applicable
	:QUESTionable	ON
:SYSTem	:ERRor?	not applicable
	:KEY	not applicable
	:PRESet	not applicable
	:SECurity	OFF
	:SET	not applicable
	:VERSion?	"1992.0"
	:WARN?	[:COUNt]
		not applicable
	:STRing?	not applicable
	:BUFFer?	not applicable

---

<b>Parameter</b>		<b>*RST, Default Values</b>
:TRIGger	:COUNT	1
	:PULSes	2
	:LEVel	:TERMination
	:SOURce	0.0 V
		INT

---

# Programming the Instrument Trigger Modes

The following figure shows the instrument's arming/triggering model:

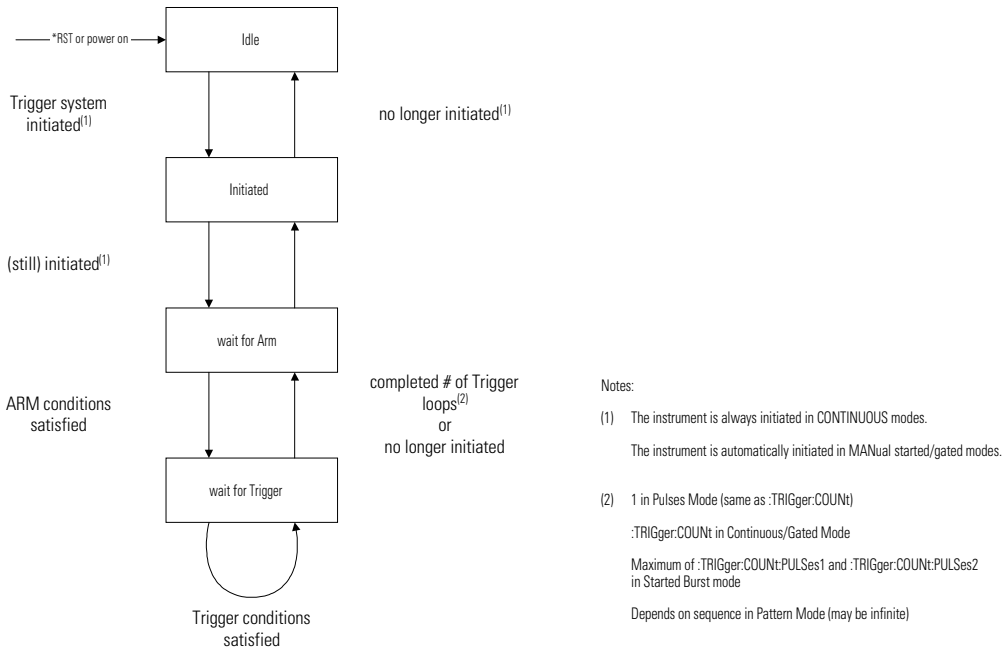

For details of the trigger count command, refer to “:TRIG:COUN” on page 89.

You program the comprehensive triggering capabilities of the instrument using the SCPI :ARM and :TRIGger subsystems. Using these two command subsystems you can program the operating modes of the instrument which are set up using the MODE/TRG screen on the frontpanel.

Use the :ARM subsystem to select the overall triggering mode of the instrument (CONTINUOUS, STARTED, GATED), and the :TRIGger subsystem to select the pulse period source, triggering and number of pulse periods per :ARM event (BURST length). In pattern mode the pattern length is the sum of each used segment’s length.

## Continuous

Set Continuous mode by arming the instrument from its internal PLL:

```
:ARM:SOURce IMMEDIATE      Arm from internal PLL
```

## Started

Set Started mode by arming the instrument on low to high level transition from the EXT INPUT:

```
:ARM:SOURce EXTERNAL1      Arm from EXT INPUT
:ARM:MODE STARTed          Start on the arm event
:ARM:SENSe POSitive        Arm on positive (high) level
:ARM:LEVel:THReshold 1V    Set EXT INPUT threshold
```

## Gated

Set Gated mode by arming the instrument on levels from the EXT INPUT:

```
:ARM:SOURce EXTERNAL1      Arm from EXT INPUT
:ARM:MODE GATED            Select gated mode
:ARM:SENSe POSitive        Arm on positive level
```

## Pulses

Set Pulses mode by setting the :TRIGGER:COUNT to 1 so that a single triggered pulse period is generated for every :ARM event. The trigger source sets the pulse period:

```
:TRIGGER:COUNT 1          Single pulse period per arm event
:TRIGGER:SOURce INTERNAL 1 Pulse period from internal PLL
:DIGital:PATtern OFF       Disable pattern data.
```

---

<b>Pulse period source</b>	<b>:TRIGGER SOURCE</b>
internal PLL	INTERNAL[1] or IMMEDIATE
CLK-IN	EXTERNAL2

---

## Burst

Set Burst mode by setting the `:TRIGger:COUNT` to the burst count required. The trigger source sets the pulse period for the pulses within the burst (See table in *“Pulses” on page 39*).

<code>:TRIGger:COUNT 16</code>	Burst of 16 pulse periods
<code>:TRIGger:SOURce INTernall</code>	Pulse period from internal PLL.
<code>:DIGital:PATtern OFF</code>	Disable pattern data

## Pattern

Set Pattern mode by setting the

`:DIGital[STIMulus]:PATtern:SEGment[1|2|3|4]:LENGth` to the required pattern length, and switching on digital pattern data. The trigger source sets the pulse period for the data pulses (See table in *“Pulses” on page 39*):

```
#Pattern length 512
:DIGital[:STIMulus]:PATtern:SEGment1:LENGth 512
:DIGital[:STIMulus]:PATtern:SEGment2:LENGth 0
:DIGital[:STIMulus]:PATtern:SEGment3:LENGth 0
:DIGital[:STIMulus]:PATtern:SEGment4:LENGth 0

#Disable counted segment loop
:DIGital[:STIMulus]:PATtern:LOOP:COUNT 1

#Jump back to start of segment 1 after the last bit of the last
segment (here: segment 1)
:DIGital[:STIMulus]:PATtern:LOOP:INFinite[:STATE] ON
:DIGital[:STIMulus]:PATtern:LOOP:INFinite:START SEGm1

:TRIGger:SOURce INTernall      Pulse period from internal PLL
:DIGital:PATtern ON            Enable pattern data
:DIGital:SIGNal1:FORMat NRZ    Set OUTPUT 1 data to NRZ
:ARM:MODE STARTed
:ARM:SOURce EXT1              Switch to started by EXT1
```



## Manually Starting and Gating

When starting and gating with the MAN key use the following commands:

---

STARTED	*TRG or :INITiate:CONTInuous ON to start the instrument
	:INITiate:CONTInuous OFF to stop the instrument
GATED	:INITiate:CONTInuous ON to 'open the gate'
	:INITiate:CONTInuous OFF to 'close the gate'
	*TRG to gate for approx. 10ms

---

## SCPI Instrument Command List

The following reference sections list the instrument commands in alphabetical order. In addition to a command description, the attributes of each command are described under the following headings. Not all of these attributes are applicable to all commands. The commands are conform to the IEEE 488.2 SCPI standard.

<b>Command</b>	Shows the short form of the command.						
<b>Long</b>	Shows the long form of the command.						
<b>Form</b>	Most commands can be used in different forms: <table><tr><td>Set</td><td>The command can be used to program the instrument</td></tr><tr><td>Query</td><td>The command can be used to interrogate the instrument. Add a ? to the command if necessary.</td></tr><tr><td>Event</td><td>The command performs a one-off action.</td></tr></table>	Set	The command can be used to program the instrument	Query	The command can be used to interrogate the instrument. Add a ? to the command if necessary.	Event	The command performs a one-off action.
Set	The command can be used to program the instrument						
Query	The command can be used to interrogate the instrument. Add a ? to the command if necessary.						
Event	The command performs a one-off action.						
<b>Parameter</b>	The type of parameter, if any, accepted by the command. The minimum and maximum value of numeric parameters can be accessed by the option MINimum or MAXimum.						
<b>Parameter Suffix</b>	The suffixes that may follow the parameter.						
<b>Functional Coupling</b>	Any other commands that are implicitly executed by the command.						
<b>Value Coupling</b>	Any other parameter that is also changed by the command.						
<b>Range Coupling</b>	Any other parameters whose valid ranges may be changed by the command.						
<b>*RST value</b>	The value/state following a *RST command.						
<b>Specified Limits</b>	The specified limits of a parameter.						
<b>Absolute Limits</b>	Some parameters can be programmed beyond their specified limits.						
<b>Example</b>	Example programming statements.						

**Command** :**ARM:LEV[:THR]**  
**Long** :ARM[:SEquence[1] | :START] [:LAYer]:LEVel[:THReshold]  
**Form** Set & Query  
**Parameter** Numeric  
**Parameter Suffix** V with engineering prefixes.  
**\*RST value** +1.0 V  
**Specified Limits** -1.4 V to +3.7 V  
**Description** Use this command to program the triggering threshold of the EXT INPUT connector.  
**Example** :ARM:LEV 2.5V Set EXT INPUT threshold to 2.5 V

**Command** :**ARM:LEV:TERM**  
**Long** :ARM[:SEquence[1] | :START] [:LAYer]:LEVel:TERMination  
**Form** Set & Query  
**Parameter** Numeric  
**Parameter Suffix** V with engineering prefixes.  
**\*RST value** +0.0 V  
**Specified Limits** -2.1 V to +3.3 V  
**Description** Use this command to program the termination voltage compensation of the EXT INPUT connector.  
**Example** :ARM:LEV:TERM 1.0V Set EXT INPUT termination voltage to 1.0 V

**Command** :**ARM:MODE**  
**Long** :ARM[:SEquence[1] | :START] [:LAYer]:MODE  
**Form** Set & Query  
**Parameter** STARTed | GATed  
**\*RST value** STARTed

Programming Reference  
**SCPI Instrument Command List**

**Description** Use this command to select **STARTED** or **GATED** mode.

In the **gated mode**, the instrument triggers as long as the arming signal is above (:ARM:SENS POS), or below (:ARM:SENS NEG) the selected threshold level (:ARM:LEV).

In **started mode**, the instrument triggers on positive edge (:ARM:SENS POS) or negative edge (:ARM:SENS NEG).

**Command** :ARM:SENS

**Long** :ARM[:SEQuence[1] | :START][:LAYer]:SENSe

**Form** Set & Query

**Parameter** POSitive | NEGative

**\*RST value** POS

**Description** Use this command to select the edge or trigger level for the arming signal.

The instrument triggers at the positive or negative cycle of the arming signal.

**Command** :ARM:SOUR

**Long** :ARM[:SEQuence[1] | :START][:LAYer]:SOURce

**Form** Set & Query

**Parameter** IMMEDIATE | EXTERNAL1 | MANUAL

**\*RST value** IMM

**Description** Use this command to select the triggering mode of the instrument by selecting the source of the arming signal:

Triggering Source	:ARM:SOURce	Mode
Internal PLL	IMMEDIATE	Continuous
EXT INPUT	EXTERNAL1	Triggered   Gated by: EXT IN
MAN key	MANUAL	Triggered   Gated by: MANKey

Use :ARM:MODE STARTed|GATed to select the mode.

**Command**            :**INIT:CONT**  
**Long**                 :INITiate:CONTinuous  
**Form**                 Set & Query  
**Parameter**           ON | OFF | 1 | 0  
**\*RST value**           ON  
**Description**         Use this command to enable/disable automatic restart of the instrument (equal to start and stop the instrument). If :ARM:SOURce is set to IMMEDIATE, the value of :INITiate:CONTinuous is ignored.

**Command**            :**CHAN:MATH**  
**Long**                 :CHANnel:MATH  
**Form**                 Set & Query  
**Parameter**           OFF | DIGital  
**\*RST value**           OFF  
**Description**         Use this command to enable or disable digital channel addition in an instrument with two Output channels installed.  
  
With :CHAN:MATH DIGital the digital signals from both channels are "xor'ed" (before the slopes are applied) at OUTPUT 1. The signal of OUTPUT 2 can be used in parallel.  
  
This allows you to for example to simulate single or repeated glitches.

**Command**            :**DIG:PATT:LOOP**  
**Long**                 :DIGital[:STIMulus]:PATTern:LOOP[:LEVel[1]][:COUNT]  
**Form**                 Set & Query  
**Parameter**           Numeric  
**\*RST value**           1  
**Specified Limits**   1 to 2<sup>20</sup>

Programming Reference  
**SCPI Instrument Command List**

**Description** Use this command to set up a counted loop across one or more segments.  
 If nested loops are used, the counted loop must be embedded into the infinite loop completely.

**Example** To set up an infinite loop over segment 2 to segment 4 and a counted loop across segment 2 and segment 3:

```
:ARM:SOUR EXT1           Set arming source to EXT-IN
:ARM:MODE STAR           Set arming mode to started
:ARM:SENS POS            Arm on positive level
:DIG:PATT:LOOP:INF:STAR SEGM2 Set jump destination to segment 2
:DIG:PATT:LOOP 100       Set number of repetitions of
                          segment2 and segment 3
:DIG:PATT:LOOP:STAR SEGM2 Set start of counted loop
:DIG:PATT:LOOP:LENG 2    Set length of counted loop
:DIG:PATT ON              Switch on PATTERN mode
```

**Command** **:DIG:PATT:LOOP:INF**

**Long** :DIGital[:STIMulus]:PATTern:LOOP:INFinite[:STATe]

**Form** Set & Query

**Parameter** ON | OFF | 1 | 0

**\*RST value** ON

**Description** Use this command to set up an infinite loop from the last used segment to the destination segment.

The infinite loop is ignored, if :ARM:SOURce is IMMEDIATE (CONTINUOUS mode), since in continuous mode there has to be a jump back to the start of the pattern (always from segment 4 to segment 1).

**Example** To setup an infinite loop over segment 2 to segment 4:

```
:ARM:SOUR EXT1           Set arming source to EXT-IN
:ARM:MODE STAR           Set arming mode to started
:ARM:SENS POS            Arm on positive level
:DIG:PATT:LOOP:INF ON    Enable infinite loop
:DIG:PATT:LOOP:INF:STAR SEGM2 Set jump destination to segment 2
:DIG:PATT:LOOP 1         Disable counted loop
:DIG:PATT ON              Switch on PATTERN mode
```

**Command** **:DIG:PATT:LOOP:INF:STAR**

**Long** :DIGital[:STIMulus]:PATTern:LOOP:INFinite:STARt

**Form** Set & Query

**Parameter** SEGM1 | SEGM2 | SEGM3 | SEGM4 | 1 | 2 | 3 | 4

**\*RST value** SEGM1

**Description** Use this command to set up the destination segment.  
 The infinite loop is ignored, if :ARM:SOURce is IMMEDIATE (CONTINUOUS mode), since in continuous mode there has to be a jump back to the start of the pattern (always from segment 4 to segment 1).

**Example** See previous example ([page 46](#)).

**Command** **:DIG:PATT:LOOP:STAR**

**Long** :DIGital[:STIMulus]:PATTern:LOOP[:LEVel[1]]:STARt

**Form** Set & Query

**Parameter** SEGM1 | SEGM2 | SEGM3 | SEGM4 | 1 | 2 | 3 | 4

**\*RST value** SEGM1

**Description** Use this command to set the first segment within a counted loop. The start of the counted loop must be within the infinite loop (if used).

**Example** To set up an infinite loop over segment 2 to segment 4 and a counted loop across segment 2 and segment 3:

:ARM:SOUR EXT1	Set arming source to EXT-IN
:ARM:MODE STAR	Set arming mode to started
:ARM:SENS POS	Arm on positive level
:DIG:PATT:LOOP:INF ON	Switch on infinite loop
:DIG:PATT:LOOP:INF:STAR SEGM2	Set jump destination to segment 2
:DIG:PATT:LOOP 100	Set number of repetitions of segment2 and segment 3
:DIG:PATT:LOOP:STAR SEGM2	Set start of counted loop
:DIG:PATT:LOOP:LENG 2	Set length of counted loop
:DIG:PATT ON	Switch on PATTERN mode

Programming Reference  
SCPI Instrument Command List

**Command**            :**DIG:PATT:LOOP:LENG**  
**Long**                :**DIGital[:STIMulus]:PATTern:LOOP[:LEVel[1]]:LENGth**  
**Form**                Set & Query  
**Parameter**         1 | 2 | 3 | 4  
**\*RST value**         1  
**Description**        Use this command to set the number of segments to be repeated within the counted loop.  
**Example**            See previous example ([page 47](#)).

**Command**            :**DIG:PATT**  
**Long**                :**DIGital[:STIMulus]:PATTern[:STATe]**  
**Form**                Set & query  
**Parameter**         ON | OFF | 1 | 0  
**\*RST value**         OFF  
**Description**        Use this command to enable and disable PATTERN mode.

**Command**            :**DIG:PATT:PRBS**  
**Long**                :**DIGital[:STIMulus]:PATTern:PRBS**  
**Form**                Set & Query  
**Parameter**         Numeric  
**\*RST value**         7  
**Specified Limits**   7 to 15 (integer)  
**Description**        Use this command to set up PRBS polynomial for all PRBS segments on all channels.



**Example**

To set up a repeating  $2^{10}-1$  PRBS on OUTPUT 1:

```
:ARM:SOUR IMM           Set continuous mode
:DIG:PATT:SEGM1:LENG 1023 Set segment 1 pattern length (last
                           bit) to 1023
:DIG:PATT:SEGM2:LENG 0   Set segment 2 to be ignored
:DIG:PATT:SEGM3:LENG 0   Set segment 3 to be ignored
:DIG:PATT:SEGM4:LENG 0   Set segment 4 to be ignored
:DIG:PATT:SEGM1:TYPE1 PRBS Set type of segment 1 on channel 1
                           to PRBS
:DIG:PATT:LOOP 1         Disable segment looping
:DIG:PATT:PRBS 10        Set PRBS base to 10
:DIG:PATT ON             Switch on PATTERN mode
```

**Command**

**:DIG:PATT:SEGM[1|2|3|4]:DATA[1|2]**

**Long**

:DIGital[:STIMulus]:PATTern:SEGment[1|2|3|4]:DATA[1|2]

**Form**

Set & Query

**Parameter**

<data>

**\*RST value**

Segment 1

---

<b>Channel</b>			
<b>[1 2]</b>	<b>Description</b>	<b>Bit 1</b>	<b>Bit 2</b>
1	CH1 (OUTPUT 1)	1	0
2	CH2 (OUTPUT 2)	0	1

---

Segment 2 to Segment 4 set to all bits set to zero.

**Description** Use this command to set or read a segment's data of one or all channels starting from Bit 1. The <data> is an arbitrary block of program data as defined in IEEE 488.2 7.7.6.2, for example:

#1511213

# Start of block  
1 Length of the length of the data  
5 Length of the data

**11213** 5 bytes of data

#2161000100010001000

# Start of block  
2 Length of the length of the data  
16 Length of the data  
10...00 16 bytes of data

#011213

# Start of block  
0 Replaces the data block length specification. Length is calculated automatically.

**11213** 5 bytes of data

**NOTE** The data length meets the same restrictions, than the segment length (see page 52).

**Example** :DIG:PATT:SEGM1:DATA #1511213

The instrument uses each byte of data set one Bit in the pattern memory. If you don't specify a particular channel, the lowest two bits of each byte are used to set all three channels, and the top six bits are ignored. Note that you can therefore use the ASCII characters '0','1','2' and '3', to program Outputs 1 and 2 in binary:

DATA			CH2 OUTPUT2	CH1 OUTPUT1
ASCII	<i>ignored</i>	<i>used</i>		
	D7 D6 D5 D4 D3 D2	D1 D0		
0	0 0 1 1 0 0	0 0	0	0
1	0 0 1 1 0 0	0 1	0	1
2	0 0 1 1 0 0	1 0	1	0
3	0 0 1 1 0 0	1 1	1	1

:DIG:PATT:SEGM1:DATA2 #1501011

If you specify a particular channel, the least significant bit of each byte is used to set the selected channel, and the top seven bits are ignored. Note that you can therefore use the ASCII characters '1' and '0' to set individual bits to 1 and 0:

DATA			CH2 OUTPUT2	CH1 OUTPUT1
ASCII	<i>ignored</i>	LSB		
	D7 D6 D5 D4 D3 D2 D1	D0		
0	0 0 1 1 0 0 0	0	0	remains unchanged
1	0 0 1 1 0 0 0	1	1	remains unchanged

**Example**

```
:ARM:SOUR IMM           Set continuous mode
:DIG:PATT:SEGM1:DATA1 #1501011 Set up pattern data for channel 1
:DIG:PATT:SEGM1:LENG 5   Set pattern length (last bit) to 5
:DIG:PATT ON             Switch on PATTERN mode
```

**Command**            :**DIG:PATT:SEGM[1|2|3|4]:LENG**  
**Long**                 :DIGital[:STIMulus]:PATTern:SEGment[1|2|3|4]:LENGth  
**Form**                 Set & Query  
**Parameter**           Numeric  
**\*RST value**           32, 0, 0, 0 (segment 1 = 32, segments 2, 3, and 4 = 0)  
**Specified Limits**    0 to 65504  
**Description**         Use this command to set up the number of bits within a segment. If a segment is set to a length of 0, the segment will be skipped.

Restrictions:

- At least one segment's length has to be > 0.
- The overall length of the pattern has to be <= 65504 and >= two times segment length resolution.
- If at least one segment is used to generate a PRBS, the overall pattern length has to be <= 32768.
- The segment length has a resolution that depends on the current set frequency/period.
- The segment at the start of a counted loop has a minimum length of 2 times the resolution.

---

Pulse Period	Segment Length Resolution (length must be multiple of ...)
< 3ns	16
3ns ... < 6ns	8
6ns ... < 12ns	4
12ns ... < 24ns	2
>= 24ns	1

---

**NOTE**                 Every change of a segment length will cause the unused pattern data to be overwritten (no undo!).

<b>Command</b>	<b>:DIG:PATT:SEGM[1 2 3 4]:PRES[1 2]</b>
<b>Long</b>	:DIGital[:STIMulus]:PATTern:SEGMent[1 2 3 4]:PRESet[1 2]
<b>Form</b>	Set
<b>Parameter</b>	<n>,<length>
<b>*RST value</b>	Not applicable
<b>Specified Limits</b>	<n> 0 to 32768 (integer) <length> 1 to 65504 (integer)
<b>Description</b>	<p>Use this command to set up clock data starting from bit 1 with value 1.</p> <p>The parameter &lt;n&gt; is used as the divider to generate a CLOCK÷n sequence (squarewave if NRZ data is selected). The parameter &lt;length&gt; determines the length of the segment.</p> <p>n=0 Fill with 0</p> <p>n=1 Fill with 1</p> <p>n=2 Sequence = 101010101010101....</p> <p>n=4 Sequence = 110011001100110....</p> <p>n=6 Sequence = 111000111000111....</p> <p>n=8 Sequence = 111100001111000....</p> <p>and so on.</p>
<b>NOTE</b>	The data length meets the same restrictions, than the segment length (see page 52).

<b>Command</b>	<b>:DIG:PATT:SEGM[1 2 3 4]:TYPE[1 2]</b>
<b>Long</b>	:DIGital[:STIMulus]:PATTern:SEGMent[1 2 3 4]:TYPE[1 2]
<b>Form</b>	Set & Query
<b>Parameter</b>	DATA   PRBS   HIGH   LOW
<b>*RST value</b>	DATA

Programming Reference  
**SCPI Instrument Command List**

**Description** Use this command to set the type of the segment for one channel.  
If the segment type of one channel is set to PRBS the other channel may not be set to DATA.  
If at least one channel uses PRBS, then the segment type combination used in this segment has to be used in every segment that shall generate a PRBS.

**Command** **:DIG:PATT:UPD**  
**Long** :DIGital[:STIMulus]:PATTern:UPDate  
**Form** Set & query  
**Parameter** ON | OFF | ONCE  
**\*RST value** ON  
**Description** Use this command to enable and disable the automatic updating of the pattern generating hardware following a :DIG:PATT:SEGM[1|2|3|4]:DATA command. Disable the automatic updating if you want to set up new pattern data in the instrument without affecting the pattern which is currently being generated. You can then update the hardware with the new pattern data by sending a :DIG:PATT:UPD ONCE command.

**Command** **:DIG:SIGN[1|2]:FORM**  
**Long** :DIGital[:STIMulus]:SIGNal[1|2]:FORMat  
**Format** Set & Query  
**Parameter** RZ | NRZ | R1  
**Range Coupling** Period, Frequency  
**\*RST value** RZ

**Description** Use this command to set and read the data format of channels 1 and 2 when using PATTERN mode. If you don't specify a channel number in the command, channel 1 is assumed.

**RZ** Return to Zero. An RZ pulse is generated for each '1' in the data. You can vary the width, edges and levels of the pulse.

**R1** Return to One. An R1 pulse is generated for each '0' in the data. You can vary the width, edges and levels of the pulse.

**NRZ** Non Return to Zero. A pulse of 100% dutycycle is generated for each '1' in the data. You can vary the edges and levels of the pulse.

**Example** `:DIG:SIGN:FORM NRZ` Set channel 1 data format to NRZ

**Command** **:DISP**

**Long** `:DISPlay[:WINDow][:STATe]`

**Form** Set & Query

**Parameter** ON | OFF | 1 | 0

**\*RST value** ON

**Description** This command is used to turn the frontpanel display on and off. Switching off the display improves the programming speed of the instrument.

**NOTE** \*RST switches the display back on.

**Example** `DISP OFF` Switch off the frontpanel display

Programming Reference  
SCPI Instrument Command List

<b>Command</b>	<b>:MMEM:CAT?</b>
<b>Long</b>	:MMEMory:CATalog?
<b>Form</b>	Query
<b>Parameter</b>	["A:"]
<b>*RST value</b>	Not applicable
<b>Description</b>	<p>Use this command to get a listing of the contents of the currently selected directory on the memory card. As there is only one memory card slot, the parameter A: is optional. The information returned is:</p> <pre>&lt;BYTES_USED&gt;,&lt;BYTES_FREE&gt;{,&lt;FILE_ENTRY&gt;}</pre> <p>&lt;bytes_used&gt; The total number of bytes used on the memory card.</p> <p>&lt;bytes_free&gt; The total number of bytes still available on the memory card.</p> <p>&lt;file_entry&gt; String containing the name, type and size of one file: " &lt;FILE_NAME&gt;,&lt;FILE_TYPE&gt;,&lt;FILE_SIZE&gt;"</p>
<b>NOTE</b>	The <file_type> is always blank. A directory name has <file_size> = 0

<b>Command</b>	<b>:MMEM:CDIR</b>
<b>Long</b>	:MMEMory:CDIRectory
<b>Form</b>	Event
<b>Parameter</b>	["directory_name"]
<b>*RST value</b>	Not applicable
<b>Description</b>	<p>Use this command to change the current directory on the memory card. If you don't specify a directory name parameter, the root directory is selected.</p>



**NOTE** Note that you cannot use DOS pathnames as directory names, you can only select a directory name within the current directory.

Use the directory name ".." to move back to the parent directory of the current directory, unless you are already in the root directory "\".

**Examples**

:MMEM:CDIR	Select root directory
:MMEM:CDIR "PERFORM"	Select directory "PERFORM"
:MMEM:CDIR ".."	Select parent directory

**Command** :MMEM:COPY

**Long** :MMEMory:COpy

**Form** Event

**Parameter** "filename"[,"A:"],"copynome"[,"A:"]

**\*RST value** Not applicable

**Description** Use this command to copy an existing file *filename* in the current directory to a new file *copynome*. If *copynome* is the name of a sub-directory in the current directory, a copy of the file *filename* is made in the sub-directory. Use ".." as *copynome* to copy a file into the parent directory of the current directory.

**Examples**

:MMEM:COpy "test1","test2"	Copy test1 to test2
:MMEM:COpy "test1",".."	Copy test1 into parent directory

**Command** :MMEM:DEL

**Long** :MMEMory:DELeTe

**Form** Event

**Parameter** "filename"

**\*RST value** Not applicable

**Description** Use this command to delete file *filename* from the currently selected directory.

Programming Reference  
SCPI Instrument Command List

<b>Command</b>	<b>:MMEM:INIT</b>
<b>Long</b>	:MMEMory:INITialize
<b>Form</b>	Event
<b>Parameter</b>	["A:", "DOS"]
<b>*RST value</b>	Not applicable
<b>Description</b>	Use this command to initialize a memory card to DOS format.

---

**CAUTION** Initializing a memory card destroys any existing data on the card.

---

<b>Command</b>	<b>:MMEM:LOAD:STAT</b>
<b>Long</b>	:MMEMory:LOAD:STATe
<b>Form</b>	Event
<b>Parameter</b>	<n>, "filename", "A:"]
<b>*RST value</b>	Not applicable
<b>Specified Limits</b>	<n> = 0 to 4 (integer)
<b>Description</b>	Use this command to load a complete instrument setting from file <i>filename</i> in the current directory into memory <n> in the instrument. Memories 1 to 4 are the internal memories. Use memory 0 to load a setting as the current instrument setting.
<b>Examples</b>	See next command

<b>Command</b>	<b>:MMEM:STOR:STAT</b>
<b>Long</b>	:MMEMory:STORe:STATe
<b>Form</b>	Event
<b>Parameter</b>	<n>, "filename", "A:"]
<b>*RST value</b>	Not applicable

**Specified Limits** <n> = 0 to 4 (integer)

**Description** Use this command to store a complete instrument setting from memory <n> to file *filename* in the current directory on the memory card.

Memories 1 to 4 are the internal memories. Use memory 0 to store the current instrument setting to a file.

**Examples**

```
:MMEM:LOAD:STAT 1, "FREQPERF" Load FREQPERF into memory 1
:MMEM:LOAD:STAT 0, "AMPTTEST" Load AMPTTEST as current setting
:*SAV 2 Save current setting in memory 2
:MMEM:STOR:STAT 2, "SETTING2" Store memory 2 to file "SETTING2"
:*RCL 3 Recall memory 3 as current setting
```

**Command** **:OUTP[1|2]**

**Long** :OUTPut [1|2] [:NORMal] [:STATe]

**Form** Set & Query

**Parameter** ON | OFF | 1 | 0

**\*RST value** OFF

**Description** Use this command to switch the normal OUTPUTs on or off.

**Example**

```
:OUTP1 ON Switch on OUTPUT 1
:OUTP2 OFF Switch off OUTPUT 2
```

**Command** **:OUTP[1|2]:COMP**

**Long** :OUTPut [1|2] :COMPliment [:STATe]

**Form** Set & Query

**Parameter** ON | OFF | 1 | 0

**\*RST value** OFF

**Description** Use this command to switch the complement OUTPUTs on or off.

**Example**

```
:OUTP1:COMP ON Switch on complement OUTPUT 1
:OUTP2:COMP OFF Switch off complement OUTPUT 2
```

Programming Reference  
SCPI Instrument Command List

<b>Command</b>	<b>:CORR[1 2]:EDELay</b>	
<b>Long</b>	[:SOURce]:CORRection[1 2]:EDELay[:TIME]	
<b>Form</b>	Set & Query	
<b>Parameter</b>	Numeric	
<b>Parameter suffix</b>	S with engineering prefixes.	
<b>*RST value</b>	0.0 s	
<b>Specified Limits</b>	-25.0 ns to +25.0 ns	
<b>Description</b>	Use this command to program the OUTPUT Deskew delay. This allows you to deskew the OUTPUTS so that the zero-delay points of both OUTPUT signals are the same at the device-under-test.	
<b>Example</b>	:CORR1:EDEL 0NS :CORR2:EDEL 5.18NS	Set OUTPUT 1 DESKEW to 0 Set OUTPUT 2 DESKEW to 5.18 ns

<b>Command</b>	<b>:CURR[1 2]</b>	
<b>Long</b>	[:SOURce]:CURRent[1 2][:LEVel][:IMMediate][:AMPLitude]	
<b>Form</b>	Set & Query	
<b>Parameter</b>	Numeric	
<b>Parameter suffix</b>	A with engineering prefixes.	
<b>*RST value</b>	20 mA (50 Ω into 50 Ω)	
<b>Specified Limits</b>	3.8 V Outputs (50 Ω into short): max. 152 mA typical 3.0 V Outputs (50 Ω into short): max. 120 mA typical	
<b>Value coupling</b>	$Amplitude = High - Low$ $Offset = \frac{High - Low}{2}$	
<b>Range coupling</b>	Offset	

**Description** This command programs the amplitude current of the OUTPUT signal. Note that to set the OUTPUT levels in terms of current, you first have to execute the [:SOURce]:HOLD CURRent command to enable the [:SOURce]:CURRent subsystem.

The available current range is limited by the specified voltage limits.

**Example**                   :HOLD CURR                                   Enable CURRENT subsystem  
                               :CURR1 75MA                               Set OUTPUT 1 amplitude to 75 mA

**Command**                :**CURR[1|2]:OFFSet**

**Long**                    [:SOURce]:CURRent [1|2] [:LEVel] [:IMMediate]:OFFSet

**Form**                    Set & Query

**Parameter**            Numeric

**Parameter suffix**    A with engineering prefixes.

**\*RST value**            0.0  $\mu$ A (50  $\Omega$  into 50  $\Omega$ )

**Specified Limits**    3.8 V Outputs (50  $\Omega$  into short): max. 152 mA typical  
                               3.0 V Outputs (50  $\Omega$  into short): max. 120 mA typical

**Value coupling**

$$\text{Amplitude} = \text{High} - \text{Low}$$

$$\text{Offset} = \frac{\text{High} - \text{Low}}{2}$$

**Range coupling**        Amplitude

**Description** This command programs the offset current of the OUTPUT signal. Note that to set the OUTPUT levels in terms of current, you first have to execute the [:SOURce]:HOLD CURRent command to enable the [:SOURce]:CURRent subsystem.

The available current range is limited by the specified voltage limits.

**Example**                   :HOLD CURR                                   Enable CURRENT subsystem  
                               :CURR1:OFF 50MA                           Set OUTPUT 1 offset to 50 mA

Programming Reference  
SCPI Instrument Command List

<b>Command</b>	<b>:CURR[1 2]:HIGH</b>
<b>Long</b>	[ :SOURce ] :CURRent [ 1   2 ] [ :LEVel ] [ :IMMediate ] :HIGH
<b>Form</b>	Set & Query
<b>Parameter</b>	Numeric
<b>Parameter suffix</b>	A with engineering prefixes.
<b>*RST value</b>	+10 mA (50 Ω into 50 Ω)
<b>Specified Limits</b>	3.8 V Outputs (50 Ω into short): max. 152 mA typical 3.0 V Outputs (50 Ω into short): max. 120 mA typical

**Value coupling**

$$\text{Amplitude} = \text{High} - \text{Low}$$
$$\text{Offset} = \frac{\text{High} - \text{Low}}{2}$$

**Range coupling** Low-level

**Description** This command programs the High-level current of the OUTPUT signal. Note that to set the OUTPUT levels in terms of current, you first have to execute [ :SOURCE ] :HOLD CURRent command to enable the [ :SOURCE ] :CURRent subsystem.

The available current range is limited by the specified voltage limits.

<b>Example</b>	:HOLD CURR :CURR1:HIGH 150MA	Enable CURRENT subsystem Set OUTPUT 1 High-level to 150 mA
----------------	---------------------------------	---

**Command**            :**CURR[1|2]:LOW**  
**Long**                 [:SOURce]:CURRent [1|2] [:LEVel] [:IMMediate]:LOW  
**Form**                 Set & Query  
**Parameter**           Numeric  
**Parameter suffix**    A with engineering prefixes.  
**\*RST value**           -10 mA (50 Ω into 50 Ω)  
**Specified Limits**    3.8V Outputs (50 Ω into short): max. 152 mA typical  
                           3.0V Outputs (50 Ω into short): max. 120 mA typical

**Value coupling**

$$Amplitude = High - Low$$

$$Offset = \frac{High - Low}{2}$$

**Range coupling**    High-level

**Description**       This command programs the Low-level current of the OUTPUT signal. Note that to set the OUTPUT levels in terms of current, you first have to execute the [:SOURce]:HOLD CURRent command to enable the [:SOURce]:CURRent subsystem.

The available current range is limited by the specified voltage limits.

**Example**            :~HOLD CURR                                    Enable CURRENT subsystem  
                           :CURR1:LOW 50 MA                        Set OUTPUT 1 Low-level to 50 mA

**Command**            :**CURR[1|2]:LIM**  
**Long**                 [:SOURce]:CURRent [1|2]:LIMit [:HIGH]  
**Form**                 Set & Query  
**Parameter**           Numeric  
**Parameter suffix**    A with engineering prefixes.  
**\*RST value**           +10.0 mA

Programming Reference  
SCPI Instrument Command List

**Description** Use this command to set/read the High-level current limit. If you switch on current limiting, the High-level current cannot be set above the programmed limit.

**NOTE** The current is *NOT* limited by the OUTPUT hardware, this is a software limit.

**Example**           : HOLD CURR                           Enable CURRENT subsystem  
                  : CURR1: LIM 50 MA           Set OUTPUT 1 High-level current limit to 50 mA  
                  : CURR1: LIM: STAT ON       Switch on OUTPUT 1 limits

**Command**       : CURR[1|2]: LIM: LOW

**Long**           [ : SOURce ] : CURRent [ 1 | 2 ] : LIMit : LOW

**Form**           Set & Query

**Parameter**     Numeric

**Parameter suffix** A with engineering prefixes.

**\*RST value**     -10.0 mA

**Description** Use this command to set/read the Low-level current limit. If you switch on current limiting, the Low-level current cannot be set below the programmed limit.

**NOTE** The current is *NOT* limited by the OUTPUT hardware, this is a software limit.

**Example**           : HOLD CURR                           Enable CURRENT subsystem  
                  : CURR1: LIM: LOW -50MA       Set OUTPUT 1 Low-level current limit to - 50mA  
                  : CURR1: LIM: STAT ON       Switch on OUTPUT 1 limits

**Command**       : CURR[1|2]: LIM: STAT

**Long**           [ : SOURce ] : CURRent [ 1 | 2 ] : LIMit : STATe

**Form**           Set & Query

**Parameter**     ON | OFF | 1 | 0



**\*RST value**           OFF

**Description**        This command switches the output limits on or off. When you switch on the output limits cannot program the output-levels beyond the programmed limits, until you switch off the output-limits. The limits apply whether you program High/Low levels or Amplitude/Offset levels.

**NOTE**                You can switch the limits on and off in both the  
 [:SOURce]:CURRent and the [:SOURce]:VOLTagE subsystems *but the current and voltage limits are not enabled/ disabled independently.* The voltage and current limits are always enabled/ disabled together.

**Example**            : HOLD CURR                                    Enable CURRENT subsystem  
                       : CURR1:LIM 50MA                            Set OUTPUT 1 High-level current limit to 50 m  
                       : CURR1:LIM:LOW -50MA                    Set OUTPUT 1 LOW-level current limit to -50mA  
                       : CURR1:LIM:STAT ON                        Switch on OUTPUT 1 limits

**Command**           **:FREQ**

**Long**                [:SOURce]:FREQuency[:CW][:FIXed]

**Form**                Set & Query

**Parameter**         Numeric

**Parameter Suffix** Hz with engineering prefixes, or MHZ for Megahertz.

**\*RST value**         1.00 MHz

**Specified limits**   Agilent 81131A: 1 kHz to 400 MHz  
                       Agilent 81132A: 1 kHz to 660 MHz

**Value coupling**

$$Period = \frac{1}{Frequency}$$

Programming Reference  
SCPI Instrument Command List

**Description** Use this command to set/read the pulse frequency. Select the frequency source for the pulse frequency using `:TRIGger:SOURce`. The currently selected source is programmed by this command. Note that the specified limits and available resolution depend on the selected source.

You cannot set the pulse frequency if you have selected the CLK IN connector as the frequency source (`:TRIG:SOUR EXT`).

**Example** `:TRIG:SOUR INT` Select internal PLL as pulse trigger  
`:FREQ 75MHz` Set pulse frequency to 75 MHz

**Command** `:FREQ:AUTO`

**Long** `[ :SOURce ] :FREQuency [ :CW ] [ :FIXed ] :AUTO`

**Form** Event

**Parameter** ONCE

**\*RST value** Not applicable

**Description** Use this command to measure the frequency at the CLK IN connector. If the CLK IN connector is the selected pulse frequency source, you can then read the measured value with `:FREQ?`

**Example** `:TRIG:SOUR EXT2` Select ext CLK IN as pulse trigger  
`:FREQ:AUTO ONCE` Measure frequency at CLK IN  
`:FREQ?` Query pulse frequency

**Command** `:HOLD`

**Long** `[ :SOURce ] :HOLD`

**Form** Set & Query

**Parameter** VOLTage | CURRent

**\*RST value** VOLT

**Description** Use this command to enable either of the `[ :SOURce ] :VOLTage` or `[ :SOURce ] :CURRent` subsystems.

You can control the signal levels of the instrument OUTPUTS in terms of voltage or current.

**Command**           **:PHAS[1|2]**  
**Long**                [:SOURce]:PHASe[1|2][:ADJust]  
**Form**                Set & Query  
**Parameter**         Numeric  
**Parameter suffix**   DEG or RAD. A parameter without a suffix is interpreted as RAD.  
**\*RST value**         0.0  
**Specified limits**   0 to 360° constrained by delay and period limits.  
**Value coupling**

$$Delay = \frac{Phase}{360} \times Period$$

**Functional coupling**   Programming the pulse phase also executes [:SOURce]:PULSe:HOLD PHASe so that the pulse phase is held constant when the signal frequency is changed.

**Description**         Use this command to set/read the relative phase-delay of the output signal. This is equivalent to setting an absolute or percentage pulse-delay with [:SOURce]:PULSe:DELAy.

If you want the phase delay to remain constant when the pulse period is varied (rather than the absolute pulse delay) use  
[:SOURce]:PULSe:DELAy[1|2]:HOLD PRATio.

<b>Example</b>	:PULS:DEL1 500NS	Set OUTPUT 1 delay to 500ns
	:PHAS2 180 DEG	Set OUTPUT 2 phase to 180°
	:PULS:DEL1:HOLD TIM	Hold OUTPUT 1 delay constant with varying period
	:PULS:DEL2:HOLD PRAT	Hold OUTPUT 2 phase constant with varying period

**Command**           **:PULS:DCYC[1|2]**  
**Long**                [:SOURce]:PULSe:DCYClE[1|2]  
**Form**                Set & Query  
**Parameter**         Numeric  
**Parameter suffix**   PCT  
**\*RST value**         10.0% (derived from Width and Period)

**Specified limits** 0.1 – 99.9%, depends on Width & Period.

**Value coupling**

$$Width = \frac{Duty\ Cycle}{100} \times Period$$

**Description** Use this command to program the dutycycle of the pulse signal. If you want to set an absolute pulse-width use

[ :SOURce ] :PULSe:WIDTh [1|2].

If you want the pulse dutycycle to remain constant when the pulse period is varied (rather than the absolute pulse width use)

[ :SOURce ] :PULSe:HOLD [1|2] DCYCl e

**Example**

:PULS:DCYCl 25PCT

Set OUTPUT 1 dutycycle to 25%

:PULS:HOLD1 DCYC

Hold dutycycle constant with varying period

**Command** :PULS:DEL[1|2]

**Long** [ :SOURce ] :PULSe:DELay [1|2]

**Form** Set & Query

**Parameter** Numeric

**Parameter suffix** S with engineering prefixes. You can change the default unit using

[ :SOURce ] :PULSe:DELay [1|2] :UNIT.

**\*RST value** 0.0

**Specified limits** 0 to 3.00 μs

**Value coupling**

$$Phase = \frac{Delay}{Period} \times 360$$

$$Delay\% = \frac{Delay}{Period} \times 100$$

**Description** Use this command to set/read the pulse-delay. Delay is the time between the start of the pulse period and the start of the leading-edge of the pulse. If you want the pulse-delay to remain constant when the pulse period is varied (rather than the phase-delay) use  
`[ :SOURce ] :PULSe:DELAy [ 1 | 2 ] :HOLD TIME.`

**Example**

<code>:PULS:DEL1 500NS</code>	Set OUTPUT1 delay to 500 ns
<code>:PHAS2 180 DEG</code>	Set OUTPUT 2 phase to 180°
<code>:PULS:DEL1:HOLD TIME</code>	Hold OUTPUT 1 delay constant with varying period
<code>:PULS:DEL2:HOLD PRAT</code>	Hold OUTPUT 2 phase constant with varying period

**Command** **:PULS:DEL[1|2]:HOLD**

**Long** `[ :SOURce ] :PULSe:DELAy [ 1 | 2 ] :HOLD`

**Form** Set & Query

**Parameter** TIME | PRATio

**\*RST value** TIME

**Description** Use this command to set/read the coupling between the pulse period and the pulse-delay:

TIME The absolute pulse-delay is held fixed when the pulse period is varied (Pulse phase varies).

PRATio The pulse phase-delay (delay as ratio of period) is held fixed when the pulse period is varied. (Pulse-delay varies).

**Example**

<code>:PULS:DEL1 500ns</code>	Set OUTPUT 1 delay to 500ns
<code>:PHAS2 180DEG</code>	Set OUTPUT 2 phase to 180°
<code>:PULS:DEL1:HOLD TIME</code>	Hold OUTPUT 1 delay constant with varying period
<code>:PULS:DEL2:HOLD PRAT</code>	Hold OUTPUT 2 phase constant with varying period

Programming Reference  
SCPI Instrument Command List

**Command**            :**PULS:DEL[1|2]:UNIT**  
**Long**                [:SOURce]:PULSe:DElay[1|2]:UNIT  
**Form**                Set & Query  
**Parameter**         S | SEC | PCT | DEG | RAD  
**\*RST value**         SEC  
**Description**        Use this command to set/read the default units for the pulse-delay parameter. The default unit of a parameter is the unit used when the parameter is programmed to a value without a unit suffix.  
**Example**             :PULS:DEL1:UNIT PCT                    Set OUTPUT 1 delay unit to %  
                      :PULS:DEL1 50                    Set OUTPUT 1 delay to 50% of period

**Command**            :**PULS:HOLD[1|2]**  
**Long**                [:SOURce]:PULSe:HOLD[1|2]  
**Form**                Set & Query  
**Parameter**         WIDTh | DCYClE | TDElay  
**\*RST value**         WIDTh  
**Description**        Use this command to set whether the pulse-width, the pulse-duty-cycle or the pulse trailing-edge delay is held constant when the pulse period is changed.  
**Example**             :PULS:DEL:HOLD1 TIME                Hold OUTPUT 1 delay fixed when frequency varies  
                      :PULS:DEL 20NS                    Set OUTPUT 1 delay to 20ns  
                      :PULS:HOLD1 DCYC                    Hold OUTPUT 1 Duty-cycle fixed when frequency varies  
                      :PULS:DCYC 25PCT                    Set OUTPUT 1 Duty-cycle to 25%

**Command**            :**PULS:PER**  
**Long**                [:SOURce]:PULSe:PERiod  
**Form**                Set & Query  
**Parameter**         Numeric

**Parameter Suffix** S with engineering prefixes.  
**\*RST value** 1  $\mu$ s  
**Specified limits** Agilent 81131A: 2.5 ns to 1 ms  
 Agilent 81132A: 1.5 ns to 1 ms  
**Value coupling**

$$Frequency = \frac{1}{Period}$$

**Description** Use this command to set/read the pulse period. Select the pulse period source using :TRIGger:SOURce. The currently selected source is programmed by this command. Note that the specified limits and available resolution depend on the selected source.

You cannot set the pulse period if you have selected the CLK IN connector as the frequency source (:TRIG:SOUR EXT2).

**Example**                   :TRIG:SOUR INT                   Select internal PLL as pulse trigger  
                               :PULS:PER 25NS                   Set pulse frequency to 25 ns

**Command**                :**PULS:PER:AUTO**

**Long**                    [:SOURce]:PULSe:PERiod:AUTO

**Form**                    Event

**Parameter**             ONCE

**\*RST value**             Not applicable

**Description** Use this command to measure the period at the CLK IN connector. If the CLK IN connector is the selected pulse period source, you can then read the measured value with :PULS:PER?

**Example**                :TRIG:SOUR EXT2                   Select ext CLK IN as pulse trigger  
                               :PULS:PER:AUTO ONCE                Measure period at CLK IN  
                               :PULS:PER?                    Query pulse period

Programming Reference  
SCPI Instrument Command List

<b>Command</b>	<b>:PULS:TDEL[1 2]</b>	
<b>Long</b>	[:SOURce]:PULSe:TDElay[1 2]	
<b>Form</b>	Set & Query	
<b>Parameter</b>	Numeric	
<b>Parameter Suffix</b>	S with engineering prefixes.	
<b>*RST value</b>	100 ns	
<b>Specified Limits</b>	Agilent 81131A: 1.25 ns to 999.9 µs Agilent 81132A: 0.75 ns to 999.9 µs	
<b>Description</b>	Use this command to program the delay of the trailing-edge of the pulse relative to the start of the pulse period. This is an alternative method of programming the pulse-width.	
<b>Example</b>	<pre>:PULS:DEL1 500NS :PULS:DEL1:HOLD TIME :PULS:TDEL1 750NS</pre>	<pre>Set OUTPUT 1 delay to 500 ns Hold OUTPUT 1 delay constant with varying period Set OUTPUT 1 trailing delay to 750 ns</pre>

<b>Command</b>	<b>:PULS:TRAN[1 2]:UNIT</b>	
<b>Long</b>	[:SOURce]:PULSe:TRANsition[1 2]:UNIT	
<b>Form</b>	Set & Query	
<b>Parameter</b>	S   SEC   PCT	
<b>*RST value</b>	SEC	
<b>Description</b>	Use this command to set the default units for the pulse transition-times. The default unit is used when the parameter is programmed to a value without a unit suffix.	

<b>Command</b>	<b>:PULS:TRAN[1 2]</b>	
<b>Long</b>	[:SOURce]:PULSe:TRANsition[1 2][:LEADing]	
<b>Form</b>	Set & Query	
<b>Parameter</b>	Numeric	





Programming Reference  
SCPI Instrument Command List

**Command**            :**PULS:TRIG[1]:MODE**  
**Long**                [:SOURce]:PULSe:TRIGger[1]:MODE  
**Form**                Set & Query  
**Parameter**         CONTInuous | START  
**\*RST value**         START  
**Description**        Use this command to set/read the TRIGGER OUT generation mode in pattern mode.

**Command**            :**PULS:TRIG[1]:POS**  
**Long**                [:SOURce]:PULSe:TRIGger[1]:POSition  
**Form**                Set & Query  
**Parameter**         1 | 2 | 3 | 4  
**\*RST value**         1  
**Description**        Use this command to set/read the TRIGGER OUT position in pattern mode. The specified value selects a segment number for the Agilent 81130A.

**Command**            :**PULS:TRIG[1]:VOLT**  
**Long**                [:SOURce]:PULSe:TRIGger[1]:VOLTage[:LEVel][:IMMediate]  
**Form**                Set & Query  
**Parameter**         TTL | PECL | SYM | ECLGND | ECLN2V  
**\*RST value**         TTL

**Description** Use this command to set/read the output levels at the TRIGGER OUT connector.

Value	High Level	Low Level	Termination Voltage	Termination Resistor
TTL	2,5V	0V	0V	50Ω
PECL	4,2V	3,3V	3,0V	50Ω
SYM	0,5V	-0.5V	0V	50Ω
ECLGND	-0,8V	-1,7V	0V	50Ω
ECLN2V	-0,8V	-1,7V	-2,0V	50Ω

**Command** :PULS:WIDT[1|2]

**Long** [:SOURce]:PULSe:WIDTh[1|2]

**Form** Set & Query

**Parameter** Numeric

**Parameter suffix** S with engineering prefixes

**\*RST value** 100 ns

**Specified Limits** Agilent 81131A: 1.25 ns to 999.9 μs

Agilent 81132A: 0.75 ns to 999.9 μs

**Description** Use this command to program the width of the pulse signal. If you want to set width as dutycycle use [:SOURce]:PULSe:DCYClE[1|2].

If you want the pulse-width to remain constant when the pulse period is varied (rather than the dutycycle) use [:SOURce]:PULSe:HOLD[1|2] WIDTh.

**Example** :PULS:WIDT1 50NS  
:PULS:HOLD1 WIDTH

Set OUTPUT 1 pulse width to 50 ns  
Hold pulse-width constant with varying period





Programming Reference  
**SCPI Instrument Command List**

**Specified Limits** Agilent 81131A: -1.95 V to 3.75 V  
 Agilent 81132A: -1.95 V to 2.95 V

**Value coupling**

$$High = Offset + \frac{Amplitude}{2}$$

$$Low = Offset - \frac{Amplitude}{2}$$

**Range coupling** Amplitude

**Description** This command programs the offset voltage of the OUTPUT signal. Note that to set the OUTPUT levels in terms of voltage, you first have to execute the [:SOURce]:HOLD VOLTage command to enable the [:SOURce]:VOLTage subsystem.

The available voltage range is limited by the specified current limits.

**Example**                   : HOLD VOLT                                   Enable VOLTAGE subsystem  
                               : VOLT1:OFF -800MV                   Set OUTPUT 1 offset to -800mV

**Command**               **:VOLT[1|2]:HIGH**

**Long**                   [:SOURce]:VOLTage[1|2][:LEVel][:IMMediate]:HIGH

**Form**                   Set & Query

**Parameter**            Numeric

**Parameter suffix**    V with engineering prefixes.

**\*RST value**           500 mV

**Specified Limits**    Agilent 81131A: -1.90 V to 3.80 V  
 Agilent 81132A: -1.90 V to 2.50 V

**Value coupling**

$$Amplitude = High - Low$$

$$Offset = \frac{High - Low}{2}$$



Programming Reference  
SCPI Instrument Command List

**Command**            :**VOLT[1|2]:LIM**

**Long**                [:SOURce]:VOLTage[1|2]:LIMit[:HIGH]

**Form**                Set & Query

**Parameter**         Numeric

**Parameter suffix**  V with engineering prefixes.

**\*RST value**         +500 mV

**Description**       Use this command to set/read the High-level voltage limit. If you switch on voltage limiting, the High-level voltage cannot be set above the programmed limit. Note that the voltage is *NOT* limited by the OUTPUT hardware, this is a software limit.

**Example**            :**HOLD VOLT**                            Enable VOLTAGE subsystem  
                      :**VOLT1:LIM 2V**                        Set OUTPUT 1 High-level limit to 2 V  
                      :**VOLT1:LIM:STAT ON**                    Switch on OUTPUT 1 limits

**Command**            :**VOLT[1|2]:LIM:LOW**

**Long**                [:SOURce]:VOLTage[1|2]:LIMit:LOW

**Form**                Set & Query

**Parameter**         Numeric

**Parameter suffix**  V with engineering prefixes.

**\*RST value**         -500 mV

**Description**       Use this command to set/read the Low-level voltage limit. If you switch on voltage limiting, the Low-level voltage cannot be set below the programmed limit. Note that the voltage is *NOT* limited by the OUTPUT hardware, this is a software limit.

**Example**            :**HOLD VOLT**                            Enable VOLTAGE subsystem  
                      :**VOLT1:LIM:LOW 0V**                    Set OUTPUT 1 Low-level voltage  
                      :**VOLT1:LIM:STAT ON**                    Switch on OUTPUT 1 limits



**Command** :VOLT[1|2]:LIM:STAT

**Long** [:SOURce]:VOLTage[1|2]:LIMit:STATe

**Form** Set & Query

**Parameter** ON | OFF | 1 | 0

**\*RST value** OFF

**Description** This command switches the output limits on or off. When you switch on the output limits cannot program the output-levels beyond the programmed limits, until you switch off the voltage-limits. The limits apply whether you program High/Low levels or Amplitude/Offset levels.

**NOTE** You can switch the limits on and off in both the [:SOURce]:CURRent and the [:SOURce]:VOLTage subsystems but the current and voltage limits are not enabled/ disabled independently. The voltage and current limits are always enabled/disabled together.

**Example**

:HOLD VOLT	Enable VOLTAGE subsystem
:VOLT1:LIM 2V	Set OUTPUT 1 High level voltage limit to 2 V
:VOLT1:LIM:LOW 0V	Set OUTPUT 1 Low-level voltage limit to 0
:VOLT1:LIM:STAT ON	Switch on OUTPUT 1 limits

**Command** :STATus:OPERation

This command tree accesses the OPERation status group. *The OPERation status group is not used by the instrument therefore this command tree is redundant.*

:STATus:OPERation[:EVENT]?  
 :STATus:OPERation:CONDition?  
 :STATus:OPERation:ENABle  
 :STATus:OPERation:NTRansition  
 :STATus:OPERation:PTRansition

**Command**        :**STATus:PRESet**  
**Long**             :STATus:PRESet  
**Form**             Event  
**\*RST value**       Not Applicable  
**Description**     This command

- Clears all status group event-registers
- Clears the error queue
- Presets the status group enable-, PTR-, and NTR-registers as follows:

Status Group	Register	Preset value
OPERation	ENABLE	0000000000000000
	PTR	0111111111111111
	NTR	0000000000000000
QUESTionable	ENABLE	0000000000000000
	PTR	0111111111111111
	NTR	0000000000000000

**Command**        :**STATus:QUESTionable**

This command tree accesses the QUESTionable status group. The QUESTionable status group contains warning bits for voltage, current, time and frequency parameters. A warning occurs when the output signal *could* be out of specification due to the combined specification uncertainties of many parameters, although all parameters are set within their individually specified limits. If a parameter is set outside its specified limits an error is generated.

The following commands are used to access the registers within the status group:

1. **:STATus:QUESTIONable[:EVENT]?**

Form	Query
*RST value	Not Applicable
Description	This command reads the event register in the QUESTIONable status group.

2. **:STATus:QUESTIONable:CONDition?**

Form	Query
*RST value	Not Applicable
Description	This command reads the condition register in the QUESTIONable status group.

3. **:STATus:QUESTIONable:ENABLE**

Form	Set & Query
Parameter	Numeric
*RST value	Not affected by *RST
Specified limits	0 – 32767
Description	This command sets or queries the enable register in the QUESTIONable status group.

4. **:STATus:QUESTIONable:NTRansition**

Form	Set & Query
Parameter	Numeric
*RST value	Not applicable
Specified limits	0 – 32767
Description	This command sets or queries the negative transition register in the QUESTIONable status group.

5. **:STATus:QUESTIONable:PTRansition**

Form	Set & Query
Parameter	Numeric
*RST value	Not applicable
Specified limits	0 – 32767
Description	This command sets or queries the positive transition register in the QUESTIONable status group.

## Programming Reference

### SCPI Instrument Command List

<b>Command</b>	<b>:SYST:ERR?</b>
<b>Long</b>	:SYSTem:ERRor?
<b>Form</b>	Query
<b>*RST value</b>	Not Applicable
<b>Description</b>	<p>Use this command to read the instrument error queue. The instrument error queue can store up to 30 error codes on a first-in-first-out basis. When you read the error queue, the error number and associated message are put into the instrument's output buffer.</p> <p>If the queue is empty, the value 0 is returned, meaning <code>No Error</code>. If the queue overflows at any time, the last error code is discarded and replaced with <code>-350</code> meaning <code>Queue overflow</code>.</p>
<b>Example</b>	<pre>:SYST:ERR?                               Query for errors</pre>

#### Output example:

```
-222 "Data out of range" overlap at output 1: Width>Period
```

The above message is an example of a customized description. Generic descriptions are available in the SCPI 1995 Command Reference, items 21.8.4 to 21.8.11.

Send "`:SYST:WARN:STR?`". Alternatively, the `HELP` key shows the current errors and warnings and their description on the instruments display.

<b>Command</b>	<b>:SYST:KEY</b>
<b>Long</b>	:SYSTem:KEY
<b>Form</b>	Set & Query
<b>Parameter</b>	Numeric
<b>Parameter suffix</b>	No suffix allowed
<b>*RST value</b>	Not Applicable

**Specified limits**

<b>No.</b>	<b>Key Description</b>
255	No key pressed (Query only)
0	DATA ENTRY 0
1	DATA ENTRY 1
2	DATA ENTRY 2
3	DATA ENTRY 3
4	DATA ENTRY 4
5	DATA ENTRY 5
6	DATA ENTRY 6
7	DATA ENTRY 7
8	DATA ENTRY 8
9	DATA ENTRY 9
10	DATA ENTRY .
11	DATA ENTRY +/-
12	Cursor Up
13	Cursor Down
14	Cursor Left
15	Cursor Right
16	MAN
17	STORE
18	HELP
19	SHIFT
20	MORE
21	Softkey 1
22	Softkey 2
23	Softkey 3
24	Softkey 4
25	NANO

---

No.	Key Description
26	MICRO/MEGA
27	MILLI/KILO
28	ENTER
29	Modify Knob Left (counter-clockwise)
30	Modify Knob Right (clockwise)

---

**Description**

In query form, this command reads the last key pressed. The buffer is emptied by \*RST and returns the value -1 when empty.

In set form, the command simulates pressing a key on the frontpanel. Simulated key-press are also recorded as the last key pressed.

**NOTE**

:SYST:KEY 19 sets the instrument to LOCAL mode.

1. In remote mode *only* the softkeys under the display and the SHIFT (LOCAL) key are active. Since the instrument normally switches to remote mode when any command is received, including :SYSTEM:KEY, simulating one of the other disabled keys has no effect.
2. If you want to simulate full frontpanel operation, you must prevent the instrument from entering remote mode by using the REN line of the GP-IB to maintain local mode (LOCAL 7 in BASIC).

If you do this, the :SYSTEM:KEY command is the only command which works. Any other commands will be buffered in the instrument blocking any further :SYSTEM:KEY commands, until remote mode is enable.

**Command**            :**SYST:PRES**  
**Long**                 :SYSTem:PRESet  
**Form**                 Same as \*RST

**Command**            :**SYST:SEC**  
**Long**                 :SYSTem:SECurity[:STATe]  
**Form**                 Set & Query  
**Parameter**           ON|OFF  
**\*RST value**           OFF  
**Description**

---

**CAUTION**

Do not switch on system security unless you are willing to erase the instrument settings stored in the instrument. All instrument memories, including the current setting, will be overwritten with the default settings if you

- Switch off system security
- Switch the instrument off and on again
- If you accidentally switch on system security, and want to rescue the settings stored in the instrument, store the settings on a memory card. You can then recall them from the memory card later.

---

Use this command to switch on system security mode. Switch on system security if you need to make sure that all instrument settings stored in the instrument are erased automatically when the instrument is switched off, or when security mode is switched off.

The instrument settings are erased by overwriting them with the default settings.

System security mode is not available via the frontpanel. If you want to erase all settings by hand:

- 1** SHIFT STORE 0 to RECALL the default settings from memory 0.
- 2** STORE 1, STORE 2 ,...,STORE 4 to store the defaults in memories 1 to 4.

Programming Reference  
SCPI Instrument Command List

**Command**            :**SYST:SET**  
**Long**                 :SYSTem:SET  
**Form**                 Set & Query  
**Parameter**           Block data  
**\*RST value**           Not applicable  
**Description**           In query form, the command reads a block of data containing the instrument's complete set-up. The set-up information includes all parameter and mode settings, but does not include the contents of the instrument setting memories, the status group registers or the :DISPlay[:WINDow][:STATe] The data is in a binary format, not ASCII, and cannot be edited.  
  
In set form, the block data must be a complete instrument set-up read using the query form of the command.

**Command**            :**SYST:VERS?**  
**Long**                 :SYSTem:VERSion?  
**Form**                 Query  
**\*RST value**           "1992.0"  
**Description**           This command reads the SCPI revision to which the instrument complies.

**Command**            :**SYST:WARN?**  
**Long**                 :SYSTem:WARNing[:COUNT]?  
**Form**                 Query  
**\*RST value**           Not applicable  
**Description**           Use this command to read the number of warnings which are currently active. Note that the warning status of voltage, current, time and frequency are also summarized by bits in the QUESTionable Status register.



**Command**            :**SYST:WARN:STR?**  
**Long**                 :SYSTem:WARNing:STRing?  
**Form**                 Query  
**\*RST value**           Not applicable  
**Description**         Use this command to read all the currently active warning messages. The warning messages are concatenated to form a single string with a ; as separator between the messages.

**Command**            :**SYST:WARN:BUFF?**  
**Long**                 :SYSTem:WARNing:BUFFer?  
**Form**                 Query  
**\*RST value**           Not applicable  
**Description**         Use this command to read the maximum possible number of characters which could be returned by :SYST:WARN:STR? if all warnings were active.

**Command**            :**TRIG:COUN**  
**Long**                 :TRIGger[:SEQuence[1] | :START]:COUNT  
**Form**                 Set & Query  
**Parameter**           Numeric  
**\*RST value**           1  
**Specified limits**    1 to 65504

**Description** Use this command to set/read the number of trigger events (pulse periods) to be generated for each arming event in pulse and burst mode (in pattern mode the number of trigger events depends on the used sequence). This corresponds to selecting the event mode on the MODE/TRG screen:

**PULSES** Set a trigger count of 1 so that a single pulse period is generated for each arming event.

**BURST of** Set a trigger count of 2 to 65504 so that a burst of 2 to 65504 pulse periods is generated for each arming event. Switch off pattern mode so that a pulse is generated in each pulse period. (:DIG:PATT OFF)

**NOTE** For a started burst this command will reduce the number of pulses on channel 1 and channel 2 (:TRIGger:COUNT:PULSes[1|2]) to the value set by :TRIGger:COUNT. Changes of the number of pulses on the channels will increase the value to of :TRIGger:COUNT to reflect the changes on the channels.

**Examples** To set STARTED BURST of 16 pulse periods and 6 Pulses at Out1, the burst are started by a positive level at the EXT INPUT:

:ARM:SOUR EXT1	Set arming from EXT INPUT
:ARM:MODE STAR	Set started mode
:ARM:SENS POS	Set arming on positive level
:TRIG:COUN 16	Burst length 16
:TRIG:COUN:PULS1 6	Number of pulses at OUTPUT 1
:TRIG:SOUR INT1	Pulse period trigger from internal PLL.
:DIG:PATT OFF	Disable pattern operating mode

To set GATED PULSES Pulses at Out1, gated by a positive level at the EXT INPUT:

:ARM:SOUR EXT1	Set arming from EXT INPUT
:ARM:MODE GAT	Set arming on levels
:ARM:SENS POS	Set arming on positive level 1 pulse period
:TRIG:COUN 1	Single pulse output mode
:TRIG:SOUR INT1	Pulse period trigger from internal PLL.
:DIG:PATT OFF	Disable pattern data

**Influence of :TRIGger:COUNT and :TRIGger:COUNT:PULSes [1|2] in started burst mode:**

:ARM:SOUR IMM	Set continuous mode
TRIG:COUN 1	Set Pulse mode
:ARM:MODE STAR	Prepare started mode
:TRIG:COUN:PULS1 20	Set number of pulses on channel 1 to 20
:TRIG:COUN 5	Set Burst mode with a length of 5 clocks, the number of pulses on both channels will be reduced to 5 if necessary.
:TRIG:COUN:PULS1? ⇒ 5	Request number of pulses on channel 1
:TRIG:COUN? ⇒ 5	Request number of clock within the started burst
:TRIG:COUN:PULS1 10	Set number of pulses on channel 1 to 10
:TRIG:COUN? ⇒ 10	Request number of clocks within the started burst
:TRIG:COUN 20	Set number of clocks within the started burst to 20
:TRIG:COUN? ⇒ 10	Request the number of clocks with in the started burst. The return value is 10, because none of the channels will generate more than 10 pulses.
:TRIG:COUN 8	Set the number of clocks within the started burst to 8.
:TRIG:COUN:PULS1? ⇒ 8	Request the number of pulses on channel 1. The return value is 8, because the number of clocks has been decreased to a value less than the currently used number of pulses on channel 1.
:TRIG:COUN 1	Set Pulse mode
:TRIG:COUN:PULS1? ⇒ 8	Request the number of pulses on channel 1. The value stays unchanged, since the instrument is no longer in started burst mode.

Programming Reference  
SCPI Instrument Command List

**Command** :TRIG:COUN:PULS[1|2]  
**Long** :TRIGger[:SEquence[1] | :STARt]:COUNT:PULSes[1|2]  
**Form** Set & Query  
**Parameter** Numeric  
**\*RST value** 2  
**Specified limits** 2 to 65504  
**Description** Use this command to set/read the number of pulses within a burst at OUTPUT 1 or OUTPUT 2.  
**Examples** To set STARTED BURST of 16 pulse periods and 6 Pulses at Out1, the burst is started by a positive level at the EXT INPUT:  
:ARM:SOUR EXT1 Set arming from EXT INPUT  
:ARM:MODE STAR Set started mode  
:ARM:SENS POS Set arming on positive level  
:TRIG:COUN 16 Burst length 16  
:TRIG:COUN:PULS1 6 Set 6 pulses at OUTPUT 1  
:TRIG:SOUR INT1 Pulse period trigger from internal PLL.  
:DIG:PATT OFF Disable pattern operating mode

**Command** :TRIG:LEV:TERM  
**Long** :TRIGger[:SEquence[1] | :STARt]:LEVel:TERMination  
**Form** Set & Query  
**Parameter** Numeric  
**Parameter Suffix** V with engineering prefixes.  
**\*RST value** 0.0 V  
**Specified Limits** -2.1V to +3.3V  
**Description** Use this command to program the termination voltage compensation of the CLK IN connector.  
**Example** :TRIG:LEV:TERM 2.5V Set CLK IN termination voltage to 2.5 V

**Command**            :**TRIG:SOUR**

**Long**                 :TRIGger[:SEQuence[1] | :STARt]:SOURce

**Form**                Set & Query

**Parameter**         IMMediate | INTernal[1] | EXTernal2

**\*RST value**         INT

**Description**        Use this command to select the pulse period source of the Agilent 81130A by selecting the source of the pulse period trigger signal:  
Pulse period sources set by :TRIG:SOUR

---

<b>Pulse period source</b>	<b>:TRIG:SOURce</b>
internal PLL	IMMediate   INTernal[1]
CLK IN	EXTernal2

---



---

# 3 Specifications

---

In this chapter you will find the specifications of the Agilent 81130A Pulse Generator and its output modules Agilent 81131A and Agilent 81132A.

At the end of this chapter, *“Pulse Parameter Definitions” on page 111* provides detailed information on the definition of the pulse parameters used by the instrument.

## **NOTE**

### **Warranted Performance**

Specifications describe the instrument’s warranted performance. Non-warranted values are described as typical. All specifications apply after a 30 minute warm-up phase with 50 Ohm source, a 50 Ohm load resistance and separate channels. They are valid from 0 °C to 55 °C ambient temperature.

---

# Declaration of Conformity

**Manufacturer** Agilent Technologies  
Boeblingen Verification Solutions  
Herrenberger Str.130  
D-71034 Boeblingen/Germany

We declare that the system:

<b>Agilent 81100</b>	<b>Family of Pulse-/Data Generators</b>
<b>Agilent 81110 A</b>	<b>330/165 MHz Pulse/Pattern Generator</b>
<b>Agilent 81104 A</b>	<b>80 MHz Pulse Pattern Generator</b>
<b>Agilent 81101 A</b>	<b>50 MHz Pulse Pattern Generator</b>
<b>Agilent 81112 A</b>	<b>330 MHz , 3.5V Output Module</b>
<b>Agilent 81130 A *</b>	<b>400/660 MHz Puls-/Pattern Generator</b>
<b>Agilent 81131 A *</b>	<b>400 MHz , 3.5V Output Module</b>
<b>Agilent 81132 A *</b>	<b>660 MHz , 2.5V Output Module</b>
<b>Agilent E 8305 A *</b>	<b>VXI Plugin 250 MHz Pulse Generator</b>
<b>Agilent E 8306 A *</b>	<b>VXI Plugin 100 MHz Clock Generator</b>

conforms to the following standards:

<b>Safety</b>	IEC 1010-1:1990 +A1:1992 +A2:1995	EN61010-1:1993
<b>EMC</b>	EN 55011:1991 / CISPR 11 Group 1, Class B	
*	EN 55011:1991 / CISPR 11 Group 1, Class A	
	EN 61000-4-2:1995	ESD: 4kVcd; 8 kVad;4kV c.p.
	EN 61000-4-3:1995	Radiated Immunity: 3V/m 80%AM
	ENV 50204: 1995	Radiated Immunity: 3V/m; 50%Dty
	EN 61000-4-4:1995	Fast Transients/Bursts: 0.5kV, 1kV
	EN 61000-4-5:1995	Surges: 1kVdiff; 2kV com.mode
	EN 61000-4-6:1995	Conducted Immunity
	EN 61000-4-8:1993	Power freq. magn. field 3A/m; 50Hz
	IEC1000-4-11:1994	Voltage Dips and Interruptions

**Supplementary Information** The product herewith complies with the requirements of the

- Low Voltage Directive (73/23/EEC) and the
- EMC Directive (89/336/EEC).

During the measurements against EN55011, the I/O ports were terminated with their nominal impedance, the GP-IB connection was terminated with the cable Agilent 10833B. When the product is connected to other devices, the user must ensure that the connecting cables and the other devices are adequately shielded to prevent radiation.

Boeblingen, June 09th 1998  
Update, Oct. 13<sup>th</sup> 1998

Wolfgang Fenske  
Regulation Consultant



---

# Agilent 81130A Specifications

## General

### Environmental Conditions

---

<b>Operating temperature:</b>	<b>0 °C to +55 °C</b>
Storage temperature:	-40 °C to +70 °C
Humidity:	95% r.h. up to 40 °C ambient temperature
Altitude:	up to 2000 m
Installation:	Category II
Pollution:	Degree 2
EMC:	conforms to EN50082-1, EN55011, Class A
Battery:	Lithium, type CR2477-N (Agilent part number 1420-0557)

---

### Safety

IEC1010, CSA1010

### Power requirements

100–240 Vac,  $\pm 10\%$ , 50–60 Hz;

100–120 Vac,  $\pm 10\%$ , 400 Hz

Power consumption: 300 VA max.

### Maximum Dimensions (H x W x D)

89 mm x 426 mm x 521 mm

## **Weight**

### **Net**

8.5 kg Single Channel

9.2 kg Dual Channel

### **Shipping**

13.8 kg Dual Channel

## **Recalibration period**

1 year recommended

## **Warranty**

3 years standard

## **Acoustic Noise Emission**

For ambient temperature up to 30°C,  
under normal operation and at the typical operator position:

LpA = 52 dB (5.9 bel) typical {47 dB (5.3 bel) at 23°C) typical}

Measured in accordance with ISO 7779/EN 27779.

## Timing Specifications

The timing characteristics are measured at 50% amplitude at fastest transitions in continuous mode and 50  $\Omega$  load impedance.

### NOTE

The Agilent 81130A is designed and recommended for an operation in the frequency range of 170 kHz to 400/660 MHz. However it can be operated in the extended range down to 1 kHz. Changes in specifications below 170 kHz are set in brackets [].

### Period & Frequency

Period can also be entered as frequency.

Period & Frequency	Agilent 81130A with Agilent 81131A	Agilent 81130A with Agilent 81132A
Period range:	2.5 ns to 1 ms	1.5 ns to 1 ms
Frequency range:	1 kHz to 400.0 MHz	1 kHz to 660.0 MHz
Period/frequency resolution:	4 digits, 2 ps best case	
Period accuracy <sup>a</sup> :	$\pm 100$ ppm [0.01%]	
RMS-jitter: (internal reference, internal clock)	0.001% + 15 ps	

<sup>a</sup> In burst mode the first period may be decreased by 150 ps.

Repeatability is typically four times better than accuracy.

## Width

The width can be entered as absolute width, duty cycle, or trailing edge delay.

Width	Agilent 81130A with Agilent 81131A	Agilent 81130A with Agilent 81132A
Width range:	1.25 ns to (period – 1.25 ns)	750 ps to (period – 750 ps)
Resolution:	4 digits, 2 ps best case [0.05% of period]	
Accuracy:	± 100 ppm ± 200 ps [± 0.06% of period]	
Jitter:	0.001% + 15 ps	

## Delay

Measured between trigger output and main output. Can be entered as absolute delay, phase ° or % of period.

Delay	Agilent 81130A with Agilent 81131A	Agilent 81130A with Agilent 81132A
Variable delay range:	0 to 3.00 µs: independent of period > 3.00 µs: 0 ns to 1 period	
Resolution:	4 digits, 2 ps best case [0.05% of period]	
Accuracy:	± (0.01% + 100 ps) relative to the zero-delay [±0.035% of period]	
Jitter:	0.001% + 15 ps	
Fixed Delay:	32 ns typ.	

## Deskew

Compensation for different cable delays.

Deskew	Agilent 81130A with Agilent 81131A	Agilent 81130A with Agilent 81132A
Range:		± 25 ns
Resolution:		4 digits, 2 ps best case

For frequencies >170 kHz only.

## Transition Times

Measured between 10% and 90% of amplitude, except for ECL levels (20% and 80% of amplitude).

Transition Times	Agilent 81130A with Agilent 81131A	Agilent 81130A with Agilent 81132A
Range:	800 ps or 1600 ps (selectable)	fixed
Minimum transition:	≤ 600 ps for $V_{pp} \leq 1\text{ V}$ ≤ 900 ps for $V_{pp} > 1\text{ V}$	500 ps typ.
At ECL levels:	<450 ps	< 350 ps (200 ps typ.)

## Digital Channel Add

In this mode, channel 1 and channel 2 are added and fed to channel 1 output. Channel 2 is still available.

## Main Output Level Specifications

Level parameters can be entered as high/low level in terms of voltage or current or offset/amplitude.

<b>Level Specifications</b>	<b>Agilent 81130A with Agilent 81131A</b>	<b>Agilent 81130A with Agilent 81132A</b>
Output impedance:	50 $\Omega$ $\pm$ 1% typ.	50 $\Omega$ $\pm$ 5% typ.
Max. external voltage:	-2.2 V to +5.5 V	-2.0 V to +4.0 V
Amplitude:	0.10 Vpp to 3.80 Vpp	0.10 Vpp to 2.50 Vpp
Level window:	-2.00 V to +3.80 V	-2.00 V to +3.00 V
Accuracy:	$\pm$ (2% + 50 mV)	$\pm$ (5% + 50 mV)
Limits:	high and low level can be limited to protect the DUT	
Resolution:	3 digits (10 mV best case)	
Short circuit current:	-80 mA to +152 mA	-80 mA to +120 mA
Baseline noise:	4 mV RMS typ.	8 mV RMS typ.
Connectors:	SMA(f) 3.5 mm	
Overshoot/preshoot/ ringing:	$\pm$ (5% + 50 mV) of amplitude typ.	
Normal/inverted:	differential outputs	
ON/OFF:	relays connect/disconnect output (HiZ)	

## External Input, External Clock/PLL Reference Input

### External Input

The external input EXT INPUT is used as trigger/gate input in started and gated mode. It is sampled once per period.

### External Clock/PLL Reference Input

The CLK-IN/REF input can either be used for external clock input or Phase Locked Loop (PLL) reference.

- External Clock
  - The output period is determined by the signal at clock input. Frequency accuracy can be increased by using a precise external clock.
- PLL Reference
  - PLL locks either to an external frequency reference at the PLL Reference Input or to an instrument's internal reference.
  - PLL is a high accuracy period (frequency) source. When locked to the internal reference, period accuracy, resolution, and jitter are improved. When locked to an external frequency reference, the external frequency affects these accuracies.

## Specifications of EXT INPUT/CLK-IN REF Input

Input Parameters	External Input (EXT IN)	External clock/PLL reference (CLK-IN/REF)
Connectors:		SMA(f) 3.5 mm
Termination voltage:		-2.10 V to +3.30 V
Termination voltage resolution:		50 mV
Input Transitions:		< 20 ns
Maximum input voltage:		-3 V to +6 V
Threshold:	-1.4 V to +3.7 V	ac coupled
Threshold resolution:	50 mV	not applicable
Input impedance/coupling:	50 $\Omega$ typ. / dc	50 $\Omega$ typ. / ac
Input frequency:	0 to 330 MHz	External Clock: 170 kHz to 660 MHz
		PLL Reference: 1, 2, 5, 10 MHz
Duty cycle:	DC-coupled	50% $\pm$ 10% duty cycle
Typical delay to trigger out:	22 ns + 0 ... 1 period <sup>a</sup>	21 ns
Typical delay to output:	54 ns + 0 ... 1 period <sup>a</sup>	53 ns
Sensitivity:		< 400 mVpp

<sup>a</sup> The uncertainty of 1 period can be eliminated if an external clock is used and the following setup and hold times are observed:  
 setup time: 0.3 ns to 4.3 ns, hold time: -2.8 ns to 4.0 ns.



## Trigger Modes

### Continuous

Generate continuous pulses, bursts, or patterns.

### Externally Started

Each active input transition (rising or falling) generates pulses, a burst, or a pattern.

The trigger source can be selected from:

- External Input
- MAN key

### Externally Gated

The active input level (high or low) enables pulses, bursts, or patterns. The output is stopped *immediately* on an external gate signal, therefore the last cycle may be incomplete.

The gate source can be selected from:

- External Input
- MAN key

## Specification of Trigger Output

This output provides one pulse per period with 50% duty cycle typically. In pattern mode, the trigger pulse can be set to mark the start of any segment.

---

Trigger Output Specification	Agilent 81130A
Level (into 50 $\Omega$ ):	selectable: TTL into GND PECL into +3 V ECL into -2 V ECL into GND
Output impedance:	50 $\Omega$ typ.
Trigger pulse width:	50% of period typ.
Maximum external voltage:	-2 V to +3 V
Transition times:	600 ps typ.
Delay from trigger to output:	32 ns typ.

---

## Output Modes

The output mode determines whether the output signal consists of

- pulses
- bursts of pulses
- patterns of pulses

The output signal is controlled by the Trigger mode.

## Burst Mode

<b>Burst</b>	<b>Agilent 81130A</b>
Burst count:	2 to 65504
Burst period <sup>a</sup> :	2 to 65504 clocks

<sup>a</sup> Minimum number of clocks is twice the segment length resolution (see table “Patterns and Sequences”).

## Patterns and Sequences

<b>Patterns/Sequences Specifications</b>	<b>Agilent 81130A</b>
Number of segments:	4
Number of infinite loops:	1
Number of counted loops:	1
Loop count:	1 to 2 <sup>20</sup>
Memory depth per channel:	65504 (– PRBS repetition length)
Segment length:	1 to 65504 (Frequency dependent resolution, see table below)
Data types:	Data (editable) High Low PRBS (2 <sup>n</sup> -1 with n = 7, 8, ... 15)
Data formats:	RZ, R1, NRZ

The following rules apply for pattern sequences:

- The resolution of the segment length value depends on the frequency:

Resolution	Frequency in MHz	Period in ns
16	333.4 ... 666.7	1.500 ... 2.999
8	166.7 ... 333.3	3.000 ... 5.999
4	83.4 ... 166.6	6.000 ... 11.99
2	41.7 ... 83.3	12.00 ... 23.99
1	min. freq. ... 41.6	24.00 ... max. period

- If the counted loop is used, the minimum length of the first segment is twice the resolution.
- An infinite loop over a single segment requires a minimum segment length of twice the resolution.
- Within a segment, PRBS is allowed to be combined with data type PRBS, High or Low only.
- PRBS must be combined with always the same data type in all segments.

## Human Interface

### Overprogramming

Parameter values can be entered exceeding the specified range.

### Warnings and Errors

Warning messages indicate potentially conflicting parameters due to accuracy tolerances.

Error messages indicate conflicting parameters.

## **Help Key**

Displays a context-sensitive message about the selected parameter. Concept help for getting started is also available. If warnings or errors occur, the HELP key displays the warning/error list accordingly.

## **Memory**

### **Non-Volatile Memory**

Actual setting is saved on power down. 4 user settings and 1 default setting are also stored in instrument.

### **Memory Card**

99 settings can be stored per 1 MB (MS-DOS, PCMCIA) memory card. Also used for convenient firmware updates.

## **Remote Control**

Operates according to IEEE standard 488.2, 1987 and SCPI 1992.0.

### **Function Code**

SH1, AH1, T6, L4, SR1, RL1, PP0, DC1, DT1,C0.

## Programming Times

(all checks and display off)

Command	Typical execution time
Width, delay, transition times:	40 ms to 70 ms
Period within one range <sup>a</sup> :	100 ms to 260 ms
Period between different ranges <sup>a</sup> ...	
... in pulse/burst mode:	140 ms to 300 ms
... in pattern mode:	100 ms to 5.05 s
Levels:	43 ms
Trigger modes:	< 75 ms
Input parameters:	28 ms
Save setting:	200 ms
Recall setting ...	
... in pulse/burst mode:	515 ms to 800 ms
... in pattern mode with data and PRBS <sup>b</sup> :	1.15 s to 5.5 s
Complete pattern memory transfer:	1.25 ms
Pattern and Sequencing <sup>b</sup> :	190 ms to 5.1 s

<sup>a</sup> Range depends on segment length resolution.

<sup>b</sup> Depends on PRBS polynom setting.

## Pulse Parameter Definitions

Here you find the pulse parameter definitions of terms used in the instrument specifications. In the following figure a graphical overview of the pulse parameters is provided:

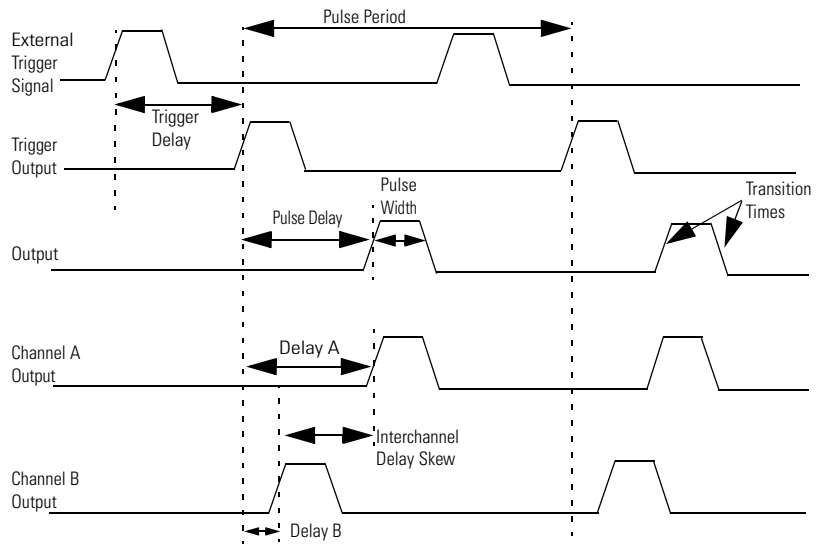

## Time Reference Point

The time reference point is at the median of the amplitude (50% amplitude point on pulse edge):

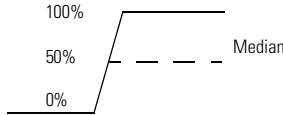

## Pulse Period

The time interval between the leading edge medians of consecutive output pulses:

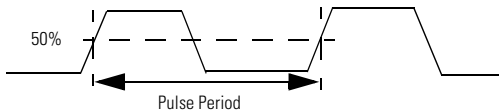

## Trigger Delay

Interval between trigger point of the external trigger input signal and the trigger output pulse's leading edge median.

## Pulse Width

Interval between leading and trailing edge medians:

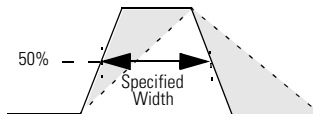

The specified and displayed value is that obtained with fastest edges, essentially equal to the interval from the start of the leading edge to the start of the trailing edge. By designing so that the pulse edges turn about their start points, the interval from leading edge start stays unchanged (in



practice, start points may shift with changes in transition time) when transition times are varied. This is more convenient for programming and the width display is easy to interpret.

## Pulse Delay

Interval between leading edge medians of trigger output pulse and output pulse:

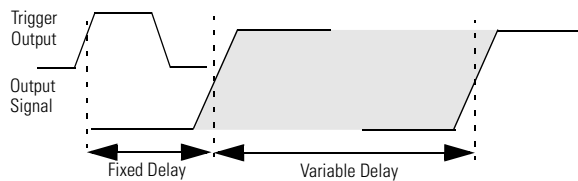

The specified and displayed value is that obtained with the fastest leading edge. Pulse delay has two components, a fixed delay from trigger output to output signal and a variable delay with respect to the trigger output.

## Interchannel Delay (Skew)

Interval between corresponding leading edge medians of the output signals.

## Transition Time

Interval between the 10% and 90% amplitude points on the leading/trailing edge:

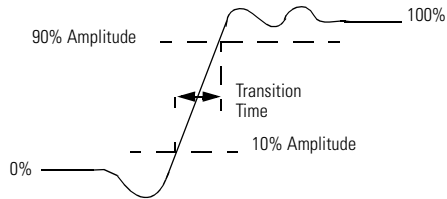

## Linearity

Peak deviation of an edge from a straight line through the 10% and 90% amplitude points, expressed as percentage of pulse amplitude:

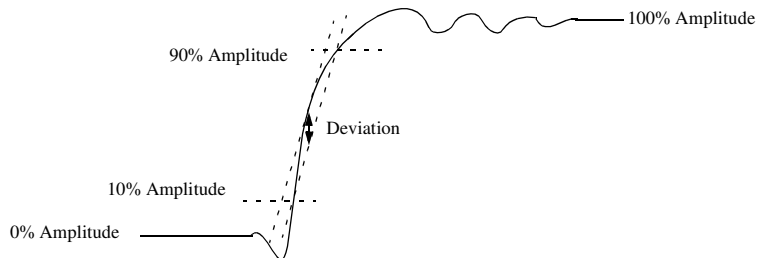

## Jitter

Short-term instability of one edge relative to a reference edge. Usually specified as rms value, which is one standard deviation or “sigma”. If distribution is assumed Gaussian, six sigma represents 99.74% of the peak-peak jitter.

The reference edge for period jitter is the previous leading edge. That for delay jitter is the leading edge of the trigger output. Width jitter is the stability of the trailing edge with regard to the leading edge.

## Stability

Long-term average instability over a specific time, for example, hour, year. Jitter is excluded.

## Pulse Levels

Pulse output is specified as pulse top and pulse base (usually referred to as high level and low level), or as peak to peak amplitude and median offset. A “window” specification shows the limits within which the pulse can be positioned.

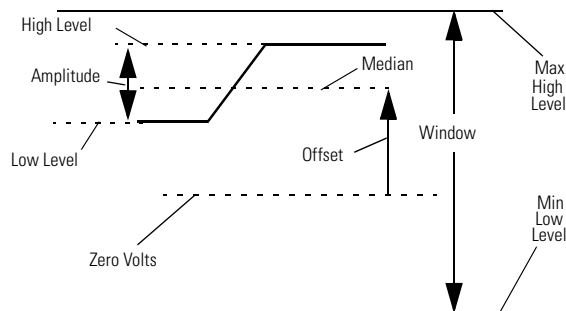

## Preshoot, Overshoot, Ringing

Preshoot and overshoot are peak distortions preceding/following an edge. Ringing is the positive-peak and negative-peak distortion, excluding overshoot, on pulse top or base. For example, a combined preshoot, overshoot, and ringing specification of 5% implies:

- Overshoot/undershoot < 5%
- Largest pulse-top oscillation <  $\pm 5\%$ , of pulse amplitude.

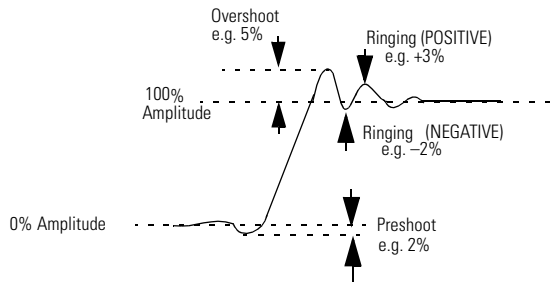

## Settling Time

Time taken for pulse levels to settle within level specifications, measured from 90% point on leading edge.

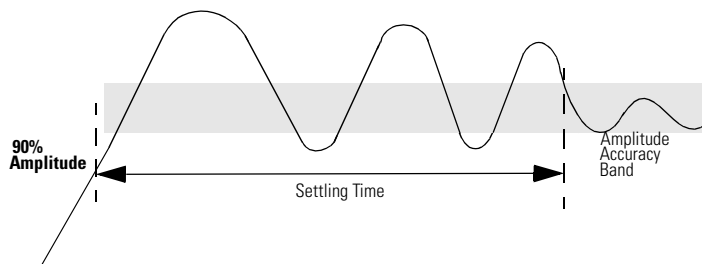

## Repeatability

When an instrument operates under the same environmental conditions and with the same settings, the value of a parameter will lie within a band inside the accuracy window. Repeatability defines the width of this band.

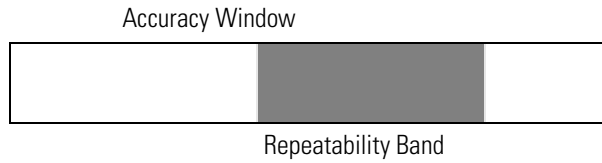

Specifications  
**Pulse Parameter Definitions**

# Index

- A**
  - Acoustic Noise Emission 98
  - Added at Output 1 45
  - Amplitude
    - definition 115
  - Amplitude current 60
  - Amplitude voltage 77
  - Automatic restart the instrument 45
- B**
  - BURST
    - length 89, 92
    - mode 89, 92
    - number of pulses 92
    - period 89, 92
  - Burst Mode
    - specification 107
- C**
  - Certification
    - met specifications 5
  - Channel addition 45
  - Clear Error Queue 82
  - Clear Status 82
  - CLK-IN Termination 92
  - Common Commands 18
  - Condition Register 20
  - CONTINUOUS mode 44, 46, 47
  - Counted Loop 45, 47, 48, 108
  - Current Limits 64
- D**
  - DATA 53
  - Declaration
    - of Conformity 96
  - Default Units 70
  - Definition
    - interchannel delay 113
    - jitter 115
    - Linearity 114
      - pulse delay 113
      - pulse levels 115
      - pulse parameters 111
      - pulse performance 116
      - pulse period 112
      - pulse width 112
      - repeatability 117
      - settling time 116
      - stability 115
      - time reference point 112
    - transition time 114
    - trigger delay 112
  - Delay 69, 70
    - specification 100
  - Delay% 68, 69, 70
  - Deskew
    - specification 101
  - Digital Channel Add 45, 101
  - Dimensions 97
  - DIR 56
  - DISPLAY
    - ON/OFF 55
  - Duty Cycle 67
- E**
  - Enable Register 21
  - Environmental Conditions 97
  - Error Queue 84
  - Errors 108
  - Event Register 20
  - EXT INPUT
    - Termination Voltage 43
    - Threshold 43
  - External Clock 103
  - External Input 103
- F**
  - Frequency
    - specification 99
  - Functional Coupling 42
- G**
  - GATED
    - level 44
    - mode 43, 44
  - Gated by 44
  - General
    - Specifications 97
  - GP-IB
    - information 14
- H**
  - HELP Key 109
  - HIGH 53
  - High-level
    - current 62
    - current limit 63
    - definition 115
    - voltage 78
    - voltage limit 80

# Index

Human Interface 108

## I

Infinite Loop 46, 47, 108

Instrument Setting 88

Interchannel Delay  
definition 113

## J

Jitter

definition 115

## K

Key-code Reference 86

## L

Last Key Pressed 84

Leading Edge 72  
definition 114

Level  
specification 102

Linearity  
definition 114

Load  
file into memory 58

Loop Length 48

Loop Start 47

LOW 53

Low-level

current 63

current limit 64

definition 115

voltage 79

voltage limit 80

## M

Main Output Level Specification 102

Measure CLK-IN

frequency 66

period 71

Memory Card

catalog/DIR 56

change directory 56

copy file 57

delete file 57

format 58

initialize 58

load from Form 58

store to 59

## N

Non-Volatile Memory 109

NRZ/RZ 54

## O

Offset

current 61

definition 115

voltage 77

Operation Status 23

Output modes

specification 106

OUTPUT ON/OFF 59

Overprogramming 108

Overshoot

definition 116

## P

PATTERN

Data 49

LENGTH 52

LOOP 45, 46, 47, 48

mode 48

PRBS 48

Update 54

Pattern

Clock/n 53

Patterns

specification 107

Period

specification 99

Phase 67

PLL Reference 76

frequency 76

Input 103

Power requirements 97

PRBS 53, 108

Preshoot

definition 116

Programming

BURST mode 40

CONTINUOUS mode 39

GATED mode 39

PATTERN mode 40

PULSES mode 39

STARTED mode 39

Programming Times

specification 110

Pulse Delay

definition 113



# Index

- Pulse Frequency 65
- Pulse Levels
  - definition 115
- Pulse Parameter
  - definitions 111
- Pulse Performance
  - definition 116
- Pulse Period 70
  - definition 112
  - source 93
- Pulse Width 75
  - definition 112
  
- Q**
- Questionable Status 24
  - Group 82
  
- R**
- Range Coupling 42
- Reading
  - Error Queue 84
  - Keyboard 84
- Recalibration period 98
- Repeatability
  - definition 117
- Reset 87
- Ringing
  - definition 116
- RZ/NRZ 54
  
- S**
- Safety 97
  - symbols 8
- SCPI
  - command dictionary 42
  - version 88
- Segment
  - data 49
  - length 49, 52, 53
  - type 53
- Separate Channels 45
- Sequences
  - specification 107
- Setting
  - load into memory 58
- Settling Time
  - definition 116
- Simulating Key-presses 84
- Skew
  - definition 113
  
- Specifications 95
  - burst mode 107
  - delay 100
  - deskew 101
  - frequency 99
  - general 97
  - level 102
  - memory card 109
  - output modes 106
  - patterns 107
  - period 99
  - PLL 103
  - programming times 110
  - pulse width 100
  - remote control 109
  - sequences 107
  - timing 99
  - timing (PLL) 103
  - transition times 101
  - trigger modes 105
  - width 100
- Stability
  - definition 115
- Standard Event Status 22
- Start instrument 45
- STARTED
  - level 44
  - mode 43, 44
- Started by 44
- Status Byte 22
- Status Group
  - definition 19
  - questionable 82
- Status Model 19
  - Preset 82
- Stop instrument 45
- Store
  - from memory to file 58
- System
  - Preset 87
  - Security 87
  
- T**
- Time Reference Point
  - definition 112
- Timing
  - specifications 99
- Trailing Edge
  - definition 114
  - delay 72
- Transition Filters 20

# Index

Transition Times 72  
  definition 114  
  specification 101  
Transition Units 72  
Trigger Delay  
  definition 112  
Trigger Modes  
  specification 105  
TRIGGER OUT  
  level 74  
  mode 74  
  position 74

## V

Value Coupling 42  
Voltage Limits 81

## W

Warnings 88, 108  
Warranted Performance 95  
Warranty 98  
Weight 98  
Width  
  specification 100

## Front Panel Controls

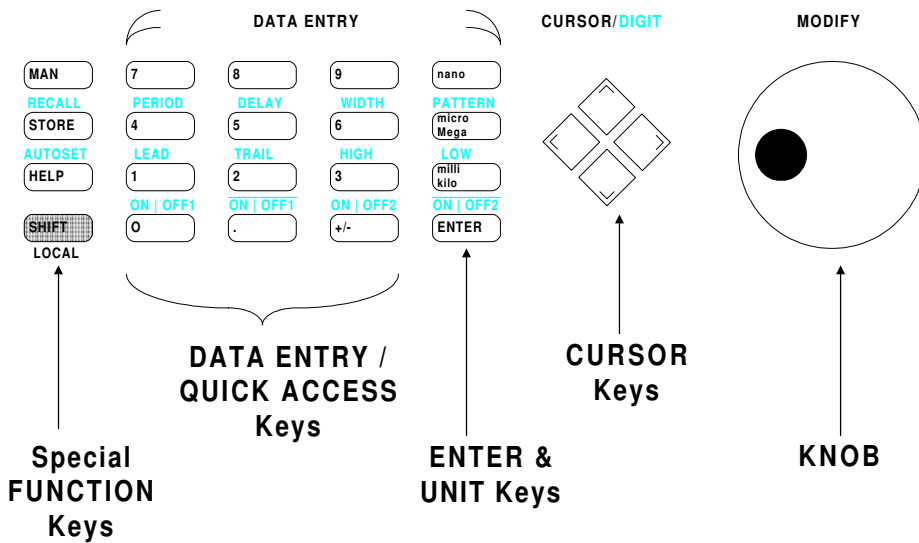

Copyright Agilent Technologies 1998, 2000  
Edition E0300  
Printed in Germany

81130-91021