

Agilent 81130A 400/660MHz Pulse/Data Generator

Quick Start Guide



Agilent Technologies

www.valuetronics.com

Front Panel Display and Softkeys

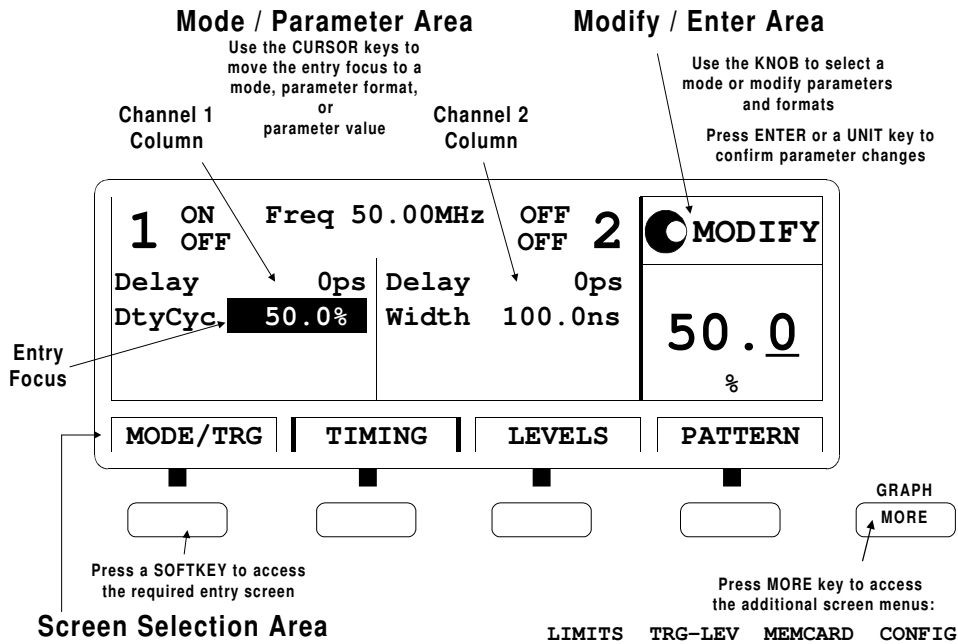

Quick Start Guide

**Agilent 81130A 400/660 MHz
Pulse/Data Generator**

Part No. 81130-91020
Printed in Germany March 2000
Edition 1.0, E0300

Notice

Copyright

© 1998 Agilent Technologies 1998, 2000. All rights reserved.

No part of this manual may be reproduced in any form or by any means (including electronic storage and retrieval or translation into a foreign language) without prior agreement and written consent from Agilent Technologies Inc. as governed by United States and international copyright laws.

Notice

The material contained in this document is subject to change without notice. Agilent Technologies makes no warranty of any kind with regard to this material, including, but not limited to, the implied warranties of merchantability and fitness for a particular purpose. Agilent Technologies shall not be liable for errors contained herein or for incidental or consequential damages in connection with the furnishing, performance, or use of this material.

Warranty

This Agilent Technologies product has a warranty against defects in material and workmanship for a period of three years from date of shipment. During the warranty period, Agilent Technologies will, at its option, either repair or replace products that prove to be defective. For warranty service or repair, this product must be returned to a service facility designated by Agilent Technologies. The Buyer shall pay Agilent Technologies round-trip travel expenses. For products returned to Agilent Technologies for warranty service, the Buyer shall prepay shipping charges to Agilent Technologies and Agilent Technologies shall pay shipping charges to return the product to the Buyer. However, the Buyer shall pay all shipping charges, duties and taxes for products returned to Agilent Technologies from another country.

Agilent Technologies warrants that its software and firmware designated by Agilent Technologies for use with an instrument will execute its programming instructions when properly installed on that instrument. Agilent Technologies does not warrant that the operation of the instrument software, or firmware, will be uninterrupted or error free.

Limitation of Warranty

The foregoing warranty shall not apply to defects resulting from improper or inadequate maintenance by the Buyer, Buyer-supplied software or interfacing, unauthorized modification or misuse, operation outside of the environmental specifications for the product, or improper site preparation or maintenance. No other warranty is expressed or implied. Agilent Technologies specifically disclaims the implied warranties of merchantability and fitness for a particular purpose.

Exclusive Remedies

The remedies supplied are the Buyer's sole and exclusive remedies. Agilent Technologies shall not be liable for any direct, indirect, special, incidental, or consequential damages, whether based on contract, tort or any other legal theory.

Certification

Agilent Technologies certifies that this product met its published specifications at the time of shipment. Agilent Technologies further certifies that its calibration measurements are traceable to the United States Institute of Standards and Technology, to the extent allowed by the Institute's calibrating facility, and to the calibration facilities of other International Standards Organization members.

Services and Support

Any adjustment, maintenance, or repair of this product must be performed by qualified personnel. Contact your customer engineer through your local Agilent Technologies Service Center. You can find a list of local service representatives on the Web at:

<http://www.agilent.com/Service/English/index.html>

Safety Summary

The following general safety precautions must be observed during all phases of operation of this instrument. Failure to comply with these precautions or with specific warnings elsewhere in this manual violates safety standards of design, manufacture, and intended use of the instrument. Agilent Technologies Inc. assumes no liability for the customer's failure to comply with these requirements.

General

This product is a Safety Class 1 instrument (provided with a protective earth terminal). The protective features of this product may be impaired if it is used in a manner not specified in the operation instructions.

All Light Emitting Diodes (LEDs) used in this product are Class 1 LEDs as per IEC 60825-1.

Environmental Conditions

This instrument is intended for indoor use in an installation category II, pollution degree 2 environment. It is designed to operate at a maximum relative humidity of 95% and at altitudes of up to 2000 meters. Refer to the specifications tables for the ac mains voltage requirements and ambient operating temperature range.

Before Applying Power

Verify that the product is set to match the available line voltage, the correct fuse is installed, and all safety precautions are taken. Note the instrument's external markings described under *“Safety Symbols” on page 8*.

Ground the Instrument

To minimize shock hazard, the instrument chassis and cover must be connected to an electrical protective earth ground. The instrument must be connected to the ac power mains through a grounded power cable, with the ground wire firmly connected to an electrical ground (safety ground) at the power outlet. Any interruption of the protective (grounding) conductor or disconnection of the protective earth terminal will cause a potential shock hazard that could result in personal injury.

Fuses

Only fuses with the required rated current, voltage, and specified type (normal blow, time delay, etc.) should be used. Do not use repaired fuses or short-circuited fuse holders. To do so could cause a shock or fire hazard.

Do Not Operate in an Explosive Atmosphere

Do not operate the instrument in the presence of flammable gases or fumes.

Do Not Remove the Instrument Cover

Operating personnel must not remove instrument covers. Component replacement and internal adjustments must be made only by qualified service personnel.

Instruments that appear damaged or defective should be made inoperative and secured against unintended operation until they can be repaired by qualified service personnel.

Safety Summary

Safety Symbols



Caution (refer to accompanying documents)



Protective earth (ground) terminal

In the manuals:

WARNING

The WARNING sign denotes a hazard. It calls attention to a procedure, practice, or the like, which, if not correctly performed or adhered to, could result in personal injury. Do not proceed beyond a WARNING sign until the indicated conditions are fully understood and met.

CAUTION

The CAUTION sign denotes a hazard. It calls attention to an operating procedure, or the like, which, if not correctly performed or adhered to, could result in damage to or destruction of part or all of the product. Do not proceed beyond a CAUTION sign until the indicated conditions are fully understood and met.

About this Book

This quick start guide helps you to quickly get familiar with the features and the user interface of the Agilent 81130A Pulse Generator.

Chapter 1 “Introducing the Agilent 81130A Pulse and Data Generator” on page 15 gives a general overview of the Agilent 81130A, its features, the user interface, and the steps required for operating the instrument.

Chapter 2 “Getting Started” on page 31 gives the setup information for some real-world signal examples, which can easily be used by varying only some parameter values.

Chapter 3 “Using the Agilent 81130A” on page 59 provides complete information on the user interface screens.

Installation and maintenance are described in *Appendix A “Installation & Maintenance” on page 99*.

For specifications and information on operating the instrument by means of remote control, please refer to the *Reference Guide*, p/n 81130-91021.

Conventions Used in this Book

This book uses certain conventions to indicate elements of the Agilent 81130A's user interface. The following table shows some examples:

Softkeys	Press the MODE/TRG softkey to access the Mode/Trigger screen.
Hardkeys	Press the MORE key to switch to the alternative softkey layout.
Alternate Keys	Press SHIFT + 0 (ON/OFF1) to switch on output 1. The alternate key label—which is selected by pressing the SHIFT key—is given in parentheses.
Screen Quotes	Move the entry focus down to PULSE-PERIOD and turn the knob to select INTERNAL PLL.
Entry Focus	The highlight field, that can be moved with the cursor keys, to change modes, parameters, or parameter formats.

Contents

	Notice	4
	Safety Summary	6
	About this Book	9
Chapter 1	Introducing the Agilent 81130A Pulse and Data Generator	
	What you can do with the Agilent 81130A	16
	The Front Panel	18
	Operating the Agilent 81130A	20
	Switching On the Instrument	20
	The Basic Screens	21
	Adjusting Parameters	24
	Switching the Outputs On and Off	27
	Using the Special Function Keys	27
	Help is Available	29
	The Rear Panel	30
Chapter 2	Getting Started	
	Setting Up a Clock Signal	32
	Setting Up a Burst Signal	37
	Setting Up a Serial Data Stream	41
	Setting Up an Edge-Displacement Signal	46
	Setting Up a Serial Data Sequence	51

Contents

Chapter 3 Using the Agilent 81130A

The Mode/Trigger Screen	60
Overview	60
Continuous Pulses Mode	63
Continuous Burst Mode	64
Continuous Pattern Mode	65
Started Pulses Mode	66
Started Burst Mode	67
Started Pattern Mode	68
Gated Pulses Mode	69
Gated Burst Mode	70
Gated Pattern Mode	71
The Timing Screen	72
The Levels Screen	76
The Pattern Screen	79
The Segment Editor	83
Block Editing Functions	85
The Limits Screen	86
The Trigger-Level Screen	87
The Memory Card Screen	89
The Configuration Screen	92
The Output Screens	95
Warnings and Errors	96

Contents

Appendix A **Installation & Maintenance**

Initial Inspection	100
Standard Deliverables	101
Options and Accessories:	102
Power Requirements	104
Power Cable	106
Ventilation Requirements	107
Thermal Protection	107
Battery	108
Battery Replacement	109
Operating Environment	110
Cleaning Recommendation	111
Acoustic Noise Emission	112

Contents

1

Introducing the Agilent 81130A Pulse and Data Generator

The purpose of the introduction chapter is to give a general overview of the Agilent 81130A.

The main features and use models are described in *“What you can do with the Agilent 81130A” on page 16.*

Operating the instrument via the front panel user interface is described in *“The Front Panel” on page 18* and *“Operating the Agilent 81130A” on page 20.*

“Help is Available” on page 29 shortly introduces the Agilent 81130A’s on-line help system.

Finally, *“The Rear Panel” on page 30* takes a look at the back of the Agilent 81130A.

What you can do with the Agilent 81130A

This section introduces the basic features and use models of the Agilent 81130A Pulse Generator.

Basic Features

The Agilent 81130A is a pulse and data generator with one or two output channels. It is capable of generating all standard pulses, bursts, and patterns of pulses needed to test current logic technologies (for example, TTL, CMOS, ECL, PECL) and other digital designs up to 400 MHz/3.8V or 660 MHz/2.5V, depending on the installed output module(s).

The instrument features **precision timing**, providing highest edge placement accuracy and accurate delay and deskew even at maximum output frequency. This contributes to reliable measurements and more accurate and confident characterizations of the device under test (DUT).

The instrument uses an accurate and stable **internal PLL oscillator**. For even more accuracy, it can be connected to an **external frequency reference**.

For programming complex **data patterns**, such as communication packages, 64 kbit memory are available to store individual patterns. Each pattern can consist of up to four segments. Loops can be programmed over single segments or groups of consecutive segments. The segments can include **pseudo-randomly generated data**.

If the Agilent 81130A is equipped with two output modules, the output channels can be used separately or be **added** digitally to form complex signals.

Complete signal setups can be stored locally (5 internal non-volatile registers available) or on a **memory card**.

Benchmark Testing

The Agilent 81130A features a graphic display showing all pulse parameters at a glance. The cursor keys and the modify knob allow fast and simple operation.

The user interface is designed to minimize the time invested in getting familiar with the instrument. After familiarization, the instrument supports quick setups of signals. This leaves you free to concentrate on the measurement task and testing of the DUT.

Automated Testing

The Agilent 81130A features an GP-IB/SCPI-conform command structure for all features. Using this programming interface, the instrument can be easily integrated into all phases of test system development such as planning rack integration and test program generation.

Programs designed for the Agilent 81130A are compatible with all other models of the Agilent 81100 family.

NOTE

For a command reference list, please refer to the *Reference Guide*, part number 81130-91021.

Upgrade Capability

It is possible to upgrade the instrument with a second channel if only one channel has been ordered originally. There are two types of output modules available for the Agilent 81130A. You can only use one type of output module within one instrument.

Output Module	Description
Agilent 81131A	400 MHz, 3.8 V
Agilent 81132A	660 MHz, 2.5 V

The Front Panel

When used for benchtop testing, the instrument is mainly operated from the front panel.

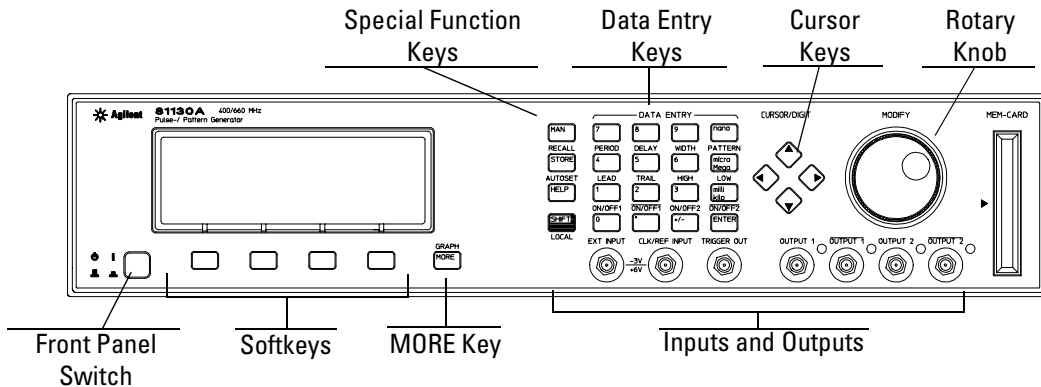

The **front panel switch** is used to switch on and off the instrument.

NOTE

When the front panel switch is off, the instrument is in “standby” mode. The instrument is disconnected from the AC line power *only* by disconnecting the power cord.

The four keys below the display are the **softkeys** (software-controlled keys). The current function of each softkey is indicated in the corresponding box on the display.

Pressing the MORE key changes the softkey layout.

The other keys (**special function keys**, **data entry keys**, **cursor keys**) and the **rotary knob** are used to select and modify parameters when operating the instrument (see [“Operating the Agilent 81130A” on page 20](#)).

The major inputs and outputs of the instrument are available at the front panel:

- The external input (EXT INPUT) can be used to connect an external arming source (started or gated modes). For details, please refer to *“The Mode/Trigger Screen” on page 60*.
- The clock reference input (CLK/REF INPUT) can be used to connect either an external clock signal or a reference signal for the internal PLL (see *“Pulse Period Source” on page 94* and *“PLL Reference” on page 94*).
- The trigger signal (TRIGGER OUT) marks the start of the pulse period or of parts of a pattern (see *“The Mode/Trigger Screen” on page 60*). You can set the output levels according to the used technology (TTL, ECL, PECL) or enter test-specific values (see *“The Trigger-Level Screen” on page 87*).
- The OUTPUT connectors provide the signal output (normal and inverted), the indicators show the current state of the output (on or off).

NOTE

For information on the use of the memory card slot, refer to *“The Memory Card Screen” on page 89*.

Operating the Agilent 81130A

This section guides you through the first steps when operating the Agilent 81130A via the user interface.

NOTE

For information on operating the Agilent 81130A via remote control, please refer to the *Reference Guide*, part number 81130-91021.

Switching On the Instrument



After switching on the instrument the display indicates that the instrument selftest is running. This can take several seconds to complete.

If the selftest fails, you see a flashing E at the bottom of the screen. Press the HELP key to see a list of the selftest error messages. Use the knob or the cursor keys to scroll through the list if necessary.

To return to normal operation press HELP again. Note that the selftest error messages are removed from the error queue after this.

The Basic Screens

The major parameters for pulse generation can be set up in 3 screens. For setting up patterns there are two more basic screens.

The **Mode/Trigger screen** allows you to set the fundamental operating and trigger modes with respect to the signal required.

The screenshot shows a control interface for the Mode/Trigger screen. At the top, there are two tabs: 'CONTINUOUS' (which is highlighted in black) and 'PULSES'. To the right of these tabs is a 'MODIFY' button with a circular icon. Below the tabs is a large empty rectangular area. To the right of this area is a vertical menu with three options: '*Continuous', 'Started', and 'Gated'. At the bottom of the screen, there are four buttons: 'MODE/TRG' (which is highlighted with a thick border), 'TIMING', 'LEVELS', and 'PATTERN'.

*Press the MODE/
TRG softkey to
access this screen.*

In this screen, you can set up the signal to be gated, started or continuous, and to be a pulse stream, a burst (several pulses followed by a pause) or a pattern.

In the lower section you can specify the trigger source and control the trigger output (in started and in gated mode).

Introducing the Agilent 81130A Pulse and Data Generator
Operating the Agilent 81130A

The **Timing screen** and the **Levels screen** allow you to specify timing and level parameters for the signals to be generated.

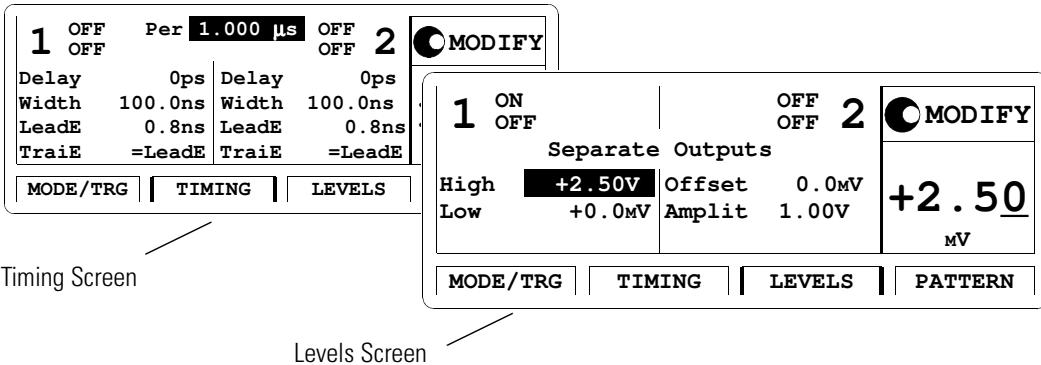

Timing Screen

Levels Screen

Press the **TIMING** OR **LEVELS** softkey to access these screens.

In the Timing screen you can set up the clock frequency and, for output 1 and 2, the timing for the signals (delay, pulse width, duty cycle, ...).

The Levels screen allows you to specify the level parameters for the signals to be generated. You can select between preset values of different technologies and/or adjust values according to individual requirements. Set the values in terms of high/low level or offset/amplitude. If the Agilent 81130A is equipped with two output modules, the channels can be set as separate outputs or to be digitally added.

Pressing **SHIFT + MORE (GRAPH)** when the Timing or the Levels screen is displayed, toggles between the textual display and a graphical representation of the parameters.

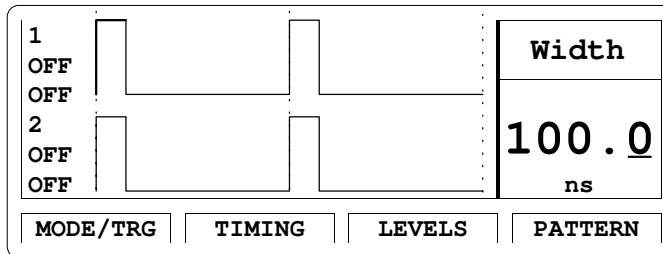

In both screens, you can switch on and off the outputs. Their status (ON or OFF) is indicated on screen and by an LED next to the output connector.

The **Pattern screen** allows you to compose a pattern sequence consisting of up to 4 segments. You can specify the length of each individual segment and then compose the sequence by specifying a re-entrance point (where the instrument resumes after the end of the sequence) and/or a loop over consecutive segments.

Segment Select

Loop Indicator

Resume Indicator (in gated/started mode only)

Segment	Length	Loopcnt	Update
1	32	1	
2	0		
3	0		
4	0		

ENTER
*Edit Segm

MODE/TRG | TIMING | LEVELS | PATTERN

To set up the data of a segment, you call the **segment editor** by selecting the segment to be edited and pressing the ENTER key.

Segment 1	UPDATE
Address	1 Length 32
CH1 Data	1 0 0 0 0 0 0
CH2 Data	0 0 0 0 0 0 0
Both	1 0 0 0 0 0 0

= ADDR
0 to Reset
1 to Set
± Toggle

MODE/TRG | TIMING | LEVELS | PATTERN

Per channel you can select from different predefined data formats (such as high, or low, or pseudo-random data segment), you can enter data by using block editing functions, and you can enter the data bit by bit.

Adjusting Parameters

Adjusting parameters within a screen, requires two steps:

- selecting the parameter
- adjusting its value

Some parameters allow different formats of their values. For example, the pulse width can be displayed and entered as an absolute value, as duty cycle (percentage of the period), or as the delay of the trailing edge.

The following sections show the standard procedure for adjusting parameters, and list some features useful for the advanced user.

Standard Procedure

To experience the standard procedure for adjusting parameters, consider the following example where the duty cycle is set to 50%.

- 1 Press the TIMING softkey to access the Timing screen.
- 2 Use the cursor keys to select the WIDTH parameter.

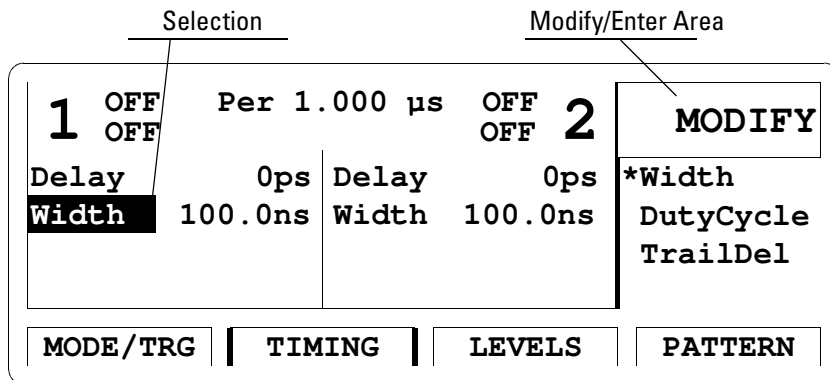

The available formats for the pulse width parameter are displayed in the Modify/Enter area.

When changing the parameter format, the instrument automatically recalculates the value.

- 3 Turn the knob to select DUTYCYCLE.
The selected setting is indicated by an “*”.
- 4 Move the cursor to the right to select the duty cycle value.
- 5 Use the data entry keys or the knob to enter the required value: 50.
- 6 Press the ENTER key to confirm your selection.

1 ON OFF	Per 1.000µs	OFF OFF	2	 MODIFY	
Delay	Ops	Delay	Ops	50.0 %	
DtyCyc	50.0%	Width	100.0ns		
MODE/TRG		TIMING		LEVELS	PATTERN

If you need to specify a unit for a parameter, simply press the appropriate unit key (NANO, MICRO/MEGA, MILLI/KILO) instead of the ENTER key.

With this small example, you have learned the basic steps required for adjusting parameters. For a complete reference of parameters and formats available in the individual screens, refer to [Chapter 3 “Using the Agilent 81130A” on page 59](#).

Advanced Procedures

The following features can be used to make operation more comfortable.

- **Selecting parameters**



Most keys of the front panel have an additional function. The SHIFT key provides fast access to the additional functions of the data entry keys and the special function keys.

For example, it is possible to quickly access the pulse width parameter by pressing SHIFT + 6 (WIDTH). The entry focus will be positioned on the corresponding editing field.

- **Changing the step size**



When modifying a value in the Modify/Enter area, pressing the SHIFT key followed by cursor left/right moves the cursor to a different digit in the displayed number.

Thus, you can change the step size for parameter change before you vary the value either with the up/down cursor keys or the knob.

- **Overprogramming**



Pressing the SHIFT key while turning the knob, it is possible to exceed specified parameter ranges to utilize the instrument to its limits.

NOTE

Proper operation of the instrument outside of the specified ranges is not guaranteed. It is recommended to have the output switched on when overprogramming to have the internal error check system activated. This error check system warns you about impossible settings.

Switching the Outputs On and Off

When you switch the instrument on, the outputs and inverted outputs are switched off to protect the device under test. The LED indicator next to the connector indicates the output state.

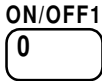

For example, to switch output 1 on or off

- either press SHIFT + 0 (ON/OFF1),
- or move the cursor to the ON/OFF parameter in the Timing or Levels screen and select the appropriate value by turning the knob.

To switch on or off output 2 and/or the inverted outputs, proceed in the same way. You can use the following short cuts:

Short Cut	Output
SHIFT + 0 (ON/OFF1)	Normal Out 1
SHIFT + . (decimal point) ($\overline{\text{ON/OFF1}}$)	Inverted Out 1
SHIFT + +/- (ON/OFF2)	Normal Out 2
SHIFT + ENTER ($\overline{\text{ON/OFF2}}$)	Inverted Out 2

Using the Special Function Keys

The instrument provides the following special function keys:



- The MAN key can be used to run and to stop the instrument, and, in triggered or gated mode, to manually arm and/or trigger the instrument if there is no other source available (see *"The Mode/Trigger Screen" on page 60*).



- The STORE key can be used to store/recall to/from 1 to 4 individual settings in the instrument memory.
 In the internal memory location 0 there is a default setting stored. Pressing SHIFT + STORE (RECALL) and selecting 0 resets the instrument to the default setting.

Introducing the Agilent 81130A Pulse and Data Generator
Operating the Agilent 81130A

SHIFT
LOCAL

- The SHIFT key provides fast access to additional functions. When the front panel controls are locked in remote control, pressing the SHIFT key unlocks the front panel controls.

HELP

- The HELP key provides access to the instrument's on-line help or in warning or error state, access to Warning/Error Report screen. Pressing SHIFT + HELP (AUTOSSET) sets the instrument to a valid setting based on the current period setting.

Help is Available

Whenever you are in doubt or the instrument signals warnings or errors, press the HELP key.

Help

If there are *no warnings or errors* pending, pressing the HELP key displays information on the currently selected parameter, the parameter help. More information is available within the help system:

- **Parameter Help**

The help information gives a short description of the parameter or setting options and the corresponding SCPI command(s) syntax for programming the parameter or setting.

If there is more than one screen available (indicated by small arrows), use the knob or the cursor keys to scroll through the help information.

To access parameter help from other screens of the help system, press the ON FIELD softkey.

- **Concept Help**

Pressing the CONCEPT softkey within the help system displays a short description of the instrument.

- **Serial Numbers and Software Revision**

Pressing the SERIAL # softkey within the help system displays information on serial numbers and software revision codes of the instrument.

Warnings and Errors

If there are *warnings or errors* pending (indicated by a flushing W or E), pressing the HELP key displays a list of the current messages. Using the ERROR QU and WARNING softkeys, you can toggle between both lists. For more information on warnings and errors, see [“Warnings and Errors” on page 96](#).

Exit Help

To exit from the help system, press the HELP key again, or press the EXIT HELP softkey.

The Rear Panel

The rear panel always provides two connectors:

- The external input (EXT INPUT) can be used to connect an external arming source (started or gated modes).
- The input connector for external clock or PLL reference (CLOCK/REF INPUT) can be used if a higher frequency accuracy is required.
- The GP-IB connector providing the interface for remote control.

The following figure shows the rear panel view with the option UN2.

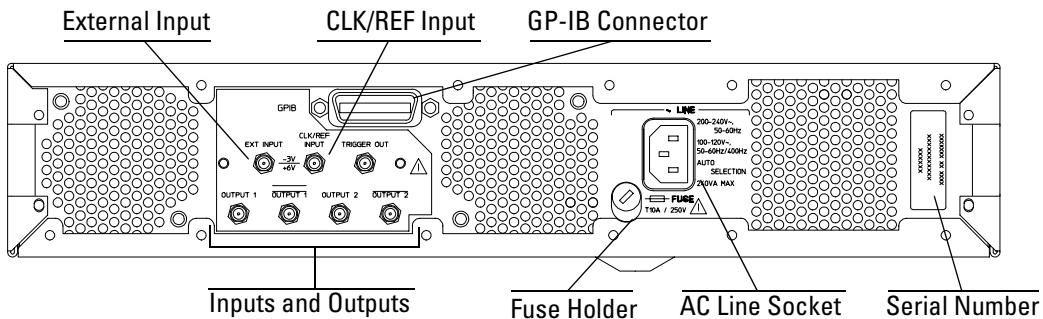

With option UN2 the major inputs and outputs of the instrument (as described in *“The Front Panel” on page 18*) are available at the rear panel:

- external input (EXT INPUT)
- clock/reference input (CLK/REF INPUT)
- trigger signal (TRIGGER OUT)
- signal output (OUTPUT)

2 Getting Started

The intention of this chapter is to give the necessary steps to set up generic signals for first-time users of the Agilent 81130A.

This chapter provides examples for the following types of signals:

- *“Setting Up a Clock Signal” on page 32*
- *“Setting Up a Burst Signal” on page 37*
- *“Setting Up a Serial Data Stream” on page 41*
- *“Setting Up an Edge-Displacement Signal” on page 46*
- *“Setting Up a Serial Data Sequence” on page 51*

At the end of each example, the required set of device commands is listed to provide programming examples. For further information on the commands and a complete command reference please refer to the *Reference Guide*, p/n 81130-91021.

The examples are intended to be performed one after the other. Therefore, the first example provides the most detailed instructions, while the other examples are described on a higher level.

Setting Up a Clock Signal

Task Set up a continuous clock signal with 50 MHz frequency, a duty cycle of 50 %, a high level of 2.5 V and a low level of 0 V.

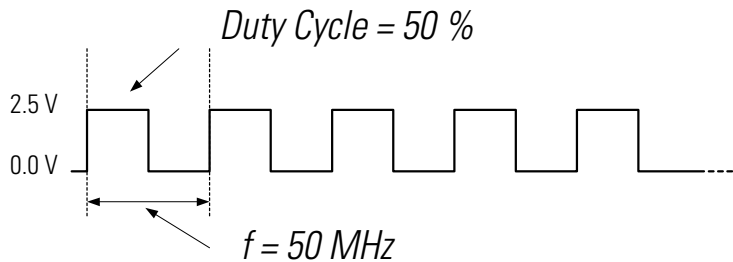

Instructions To set the **operating mode and trigger mode** as required:

- 1 Reset all parameters and modes by pressing SHIFT + STORE (RECALL) + 0.
- 2 Press the MODE/TRG softkey to enter the Mode/Trigger screen. Trigger mode CONTINUOUS and operating mode PULSES are selected by default.

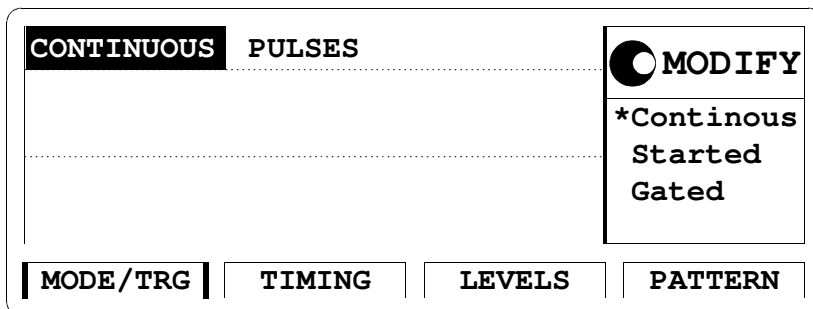

To set the **timing parameters** as required:

- 1 Press the TIMING softkey to enter the Timing screen.
- 2 Press SHIFT + 0 (ON/OFF1).
This turns on the Output 1 and activates the internal error check to detect parameter conflicts.
- 3 Move the entry focus to PER and turn the knob to select FREQUENCY.
- 4 Move the entry focus to the right (to the frequency entry field) and enter a value of 50 MHz by pressing 5 + 0 + MICRO/MEGA.
A warning is displayed, indicating a potential conflict in your settings. The conflict will be solved in the next steps.
- 5 If you want to view the warning message, press the HELP key. Return by pressing the HELP key again.
- 6 Move the entry focus down left to WIDTH of output 1 and select DUTYCYC.
- 7 Move the entry focus to the right and enter 50 % by typing 5 + 0 + ENTER.

1	ON OFF	Freq 50.00MHz	OFF OFF	2	MODIFY
Delay	Ops	Delay	Ops	50.0	
DtyCyc	50.0%	Width	100.0ns	%	
MODE/TRG		TIMING		LEVELS	
				PATTERN	

Getting Started
Setting Up a Clock Signal

- 8 Press SHIFT + MORE (GRAPH) or the TIMING softkey to see a preview of your signal.

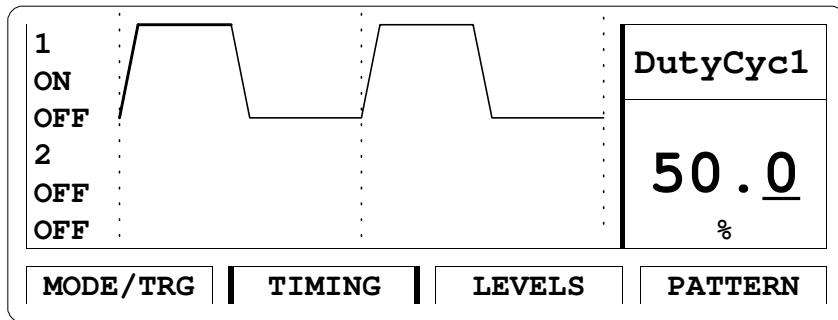

You can modify the parameter displayed in the Modify/Enter area, and immediately check how your changes affect the signal. Use the cursor keys to switch to another parameter.

- 9 Press SHIFT + MORE (GRAPH) or the TIMING softkey to return to the textual screen.

To set the **level parameters** as required:

- 1 Press the LEVELS softkey to enter the Levels screen.
- 2 Move the entry focus to OFFSET/AMPLIT in the output 1 column and turn the knob to select HIGH-LOW.
- 3 Move the entry focus to the Low entry field, enter 0 and press the ENTER key. In the same way, enter 2.5 V for the high level.

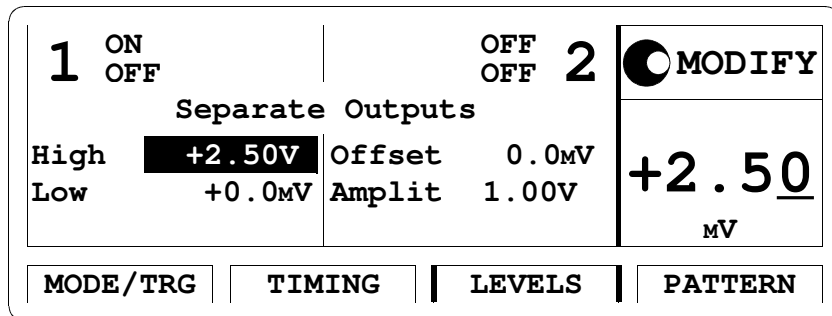

NOTE

There is also a graphical screen available for the level parameters.

Here is the signal as displayed on an Agilent 54810A Infinium oscilloscope. Use the generator's TRIGGER OUT to trigger the scope.

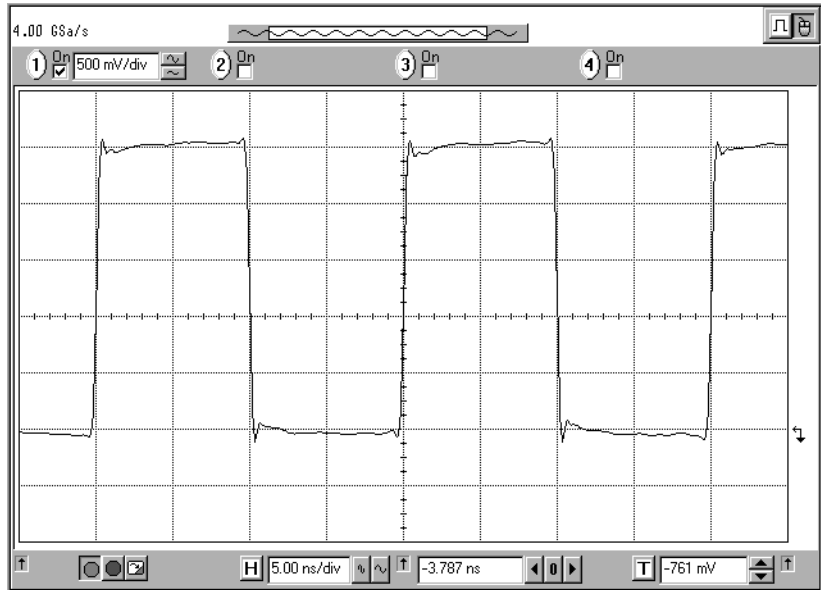

Getting Started

Setting Up a Clock Signal

Programming Example

If you want to include this clock signal in your GP-IB program, use the following command lines. The comment lines starting with a # are not required.

```
# Reset the instrument to start from a defined, default status.
*RST

# Switch off the automatic display update to increase programming
# speed.
:DISPlay OFF

# Internal PLL has to be set as period source.

# Set the frequency to 50 MHz and the duty cycle to 50 %
:FREQuency 50 MHZ
:PULSe:DCYCLE 50

# Set the high level to 2.5 Volts, the low level to 0.0 Volts.
:VOLTage:HIGH 2.5V
:VOLTage:LOW 0V

# Enable the output.
:OUTPut ON
```

Setting Up a Burst Signal

Task

Set up a burst signal with a burst repetition of 4 clocks. Each burst consists of two pulses at a period of 100 ns. The pulse width is 25 ns. The levels are 2 Vpp amplitude and 0 V offset. On the second channel the clock reference is generated. The signals are issued while the MAN key is pressed.

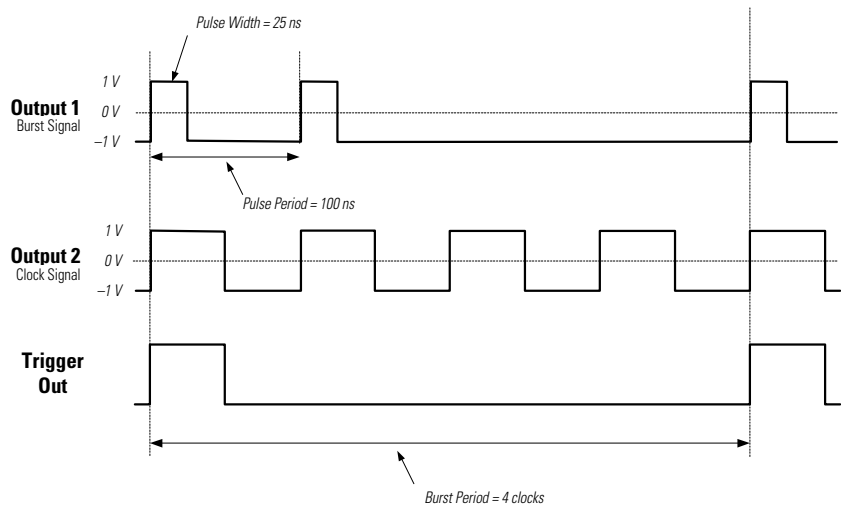

Instructions

To set the **operating mode and trigger mode** as required:

- 1 Reset all parameters and modes by pressing SHIFT + STORE + 0.
- 2 Press the MODE/TRG softkey to enter the Mode/Trigger screen.
- 3 Move the entry focus to CONTINUOUS and turn the knob to select GATED.
- 4 Move to PULSES and select BURST OF.
- 5 Move to PULSES OUT 1 and select 2.
- 6 Move to OUT 2 and select 4.

Getting Started
Setting Up a Burst Signal

- 7 Move to BURST PERIOD and select 4 clocks.
- 8 Move to GATED BY and select MAN KEY.
- 9 Move right and select HIGHLEVEL.

GATED BURST of		RUN	<input checked="" type="radio"/> MODIFY
Pulses Out 1:	2	Out2:	4
Burst Period:	4 Clk		*HighLevel
Gated by:	MAN Key		LowLevel
MODE/TRG	TIMING	LEVELS	PATTERN

To set the **timing parameters** as required:

- 1 Press the TIMING softkey to enter the Timing menu.
- 2 Switch on both outputs.
- 3 Enter a pulse period of 100 NS.
 A warning is shown, which you may ignore because the parameter conflict will be solved in the next steps.
- 4 In the output 1 column, enter a WIDTH of 25 NS.
- 5 In the output 2 column, move to WIDTH, select DUTYCYCLE, and enter a value of 50 %.

1	ON	Per 100.0ns	OFF	2	<input checked="" type="radio"/> MODIFY
	OFF		OFF		
Delay	Ops	Delay	Ops		
Width	25.00ns	DtyCyc	50.0 %	50.0	
				%	
MODE/TRG	TIMING	LEVELS	PATTERN		

To set the **level parameters** as required:

- 1 Press the LEVELS softkey to enter the Levels menu.
- 2 Enter an amplitude of 2.00 V for both outputs.

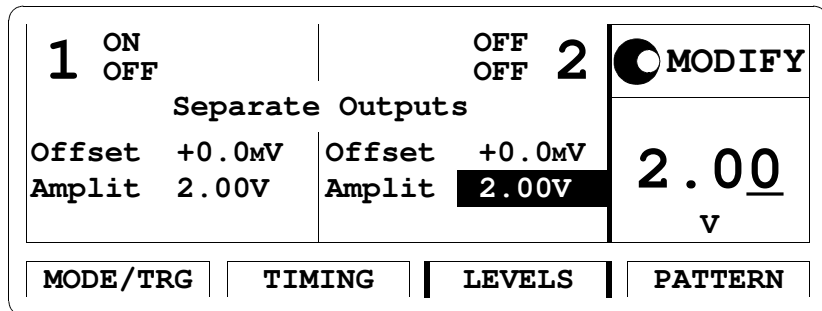

The following figure shows the signals as displayed on the Agilent 54810A Infinium Oscilloscope if the MAN key is pressed. Use the generator's TRIGGER OUT to trigger the scope.

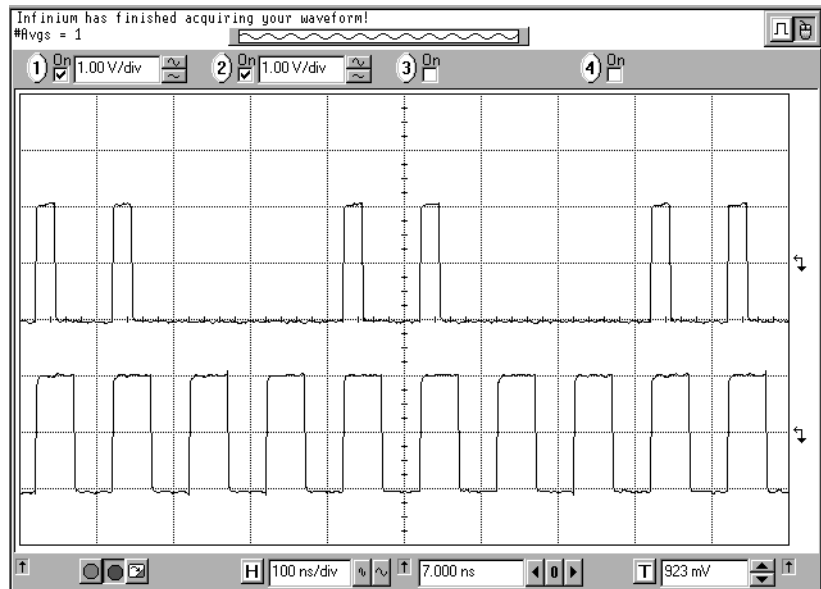

Getting Started

Setting Up a Burst Signal

Programming example

If you want to include this burst signal in your GP-IB program use the following command lines. The comment lines starting with a # are not required.

```
# Reset the instrument to start from a defined, default status.
*RST

# Switch off the automatic display update to increase programming
# speed.
:DISPlay OFF

# Set the instrument to gated and set burst mode by selecting a
# burst count of 4.
:ARM:SOURce MAN
:ARM:MODE:GATed
:TRIGger:COUNT 4

# Set 2 pulses per burst for channel 1 and 4 pulses per burst for
# channel 2.
:TRIGger:COUNT:PULSes1 2
:TRIGger:COUNT:PULSes2 4

# Set the pulse period 100 ns, the width of channel 1 to 25 ns
# and the duty cycle of channel 2 to 50%.
:PULSe:PERiod 100NS
:PULSe:WIDTh1 25NS
:PULSe:HOLD2 DCYCLe
:PULSe:DCYCLe2 50

# Set the output amplitudes to 2 Volts and the offsets to
# 0 Volts.
:VOLTage1 2V
:VOLTage2 2V
:VOLTage1:OFFSet 0V
:VOLTage2:OFFSet 0V

# Enable the outputs.
:OUTPut1 ON
:OUTPut2 ON
```

Setting Up a Serial Data Stream

Task Set up a 24 bit long pattern with NRZ data output format, 80 MBit/s, and ECL output level.

Instructions To set the **operating mode and trigger mode** as required:

- 1 Reset all parameters and modes by pressing SHIFT + STORE + 0.
- 2 Press the MODE/TRG softkey to enter the Mode/Trigger screen.
- 3 Move to PULSES and select PATTERN.
- 4 Move to the PULSES OUT 1 entry field and select NRZ.
- 5 Set TRIGGER OUTPUT AT: to SEG1 START.

CONTINUOUS PATTERN of		● MODIFY	
Pulses Out 1: NRZ	Out 2: RZ		
PRBS Polynom: 2^7-1		Clock	
Trigger Output at: Segm1 Start		*Segment1	
		Segment2	
		Segment3	
MODE/TRG	TIMING	LEVELS	PATTERN

Getting Started
Setting Up a Serial Data Stream

To set the **timing parameters** as required:

- 1 Press the TIMING softkey to enter the Timing menu.
- 2 Switch on the Output 1.
- 3 Enter a frequency of 80 MHz.

1	ON	Freq	80.00MHz	OFF	2	<input type="radio"/> MODIFY
	OFF			OFF		
Delay		Ops	Delay		Ops	
Width		-----	Width		100.0ns	80.00
						MHz
MODE/TRG		TIMING		LEVELS		PATTERN

NOTE

You cannot enter a pulse width because of the NRZ setting. This is indicated by the dashes in the WIDTH entry field.

To set the **level parameters** as required:

- 1 Press the LEVELS softkey to enter the Level menu.
- 2 In the output 1 column, move the entry focus to OFFSET/AMPLIT and select SET ECL.

To set up the **data pattern** as required:

- 1 Press the PATTERN softkey to enter the Pattern menu.
- 2 Move the entry focus to the length entry of segment 1 and enter 24.
- 3 To start editing the data for the pattern, select 1 in the Segment column and press the ENTER key.
- 4 Move to the first data of channel 1, as shown in the figure:

Segment 1	UPDATE						<input checked="" type="radio"/> = ADDR 0 to Reset 1 to Set ± Toggle
Address	1	Length	24				
CH1 Data	1	0	0	0	0	0	0
CH2 Data	0	1	0	0	0	0	0
Both	1	2	0	0	0	0	0

MODE/TRG
TIMING
LEVELS
PATTERN

- 5 Enter the following pattern using the 0 and 1 keys:
111001110011001001010010.

NOTE

You can use the knob to scroll through the data of the segment.

Getting Started Setting Up a Serial Data Stream

The following figure shows the signals as displayed on the Agilent 54810A Infinium Oscilloscope. Use the generator's TRIGGER OUT to trigger the scope.

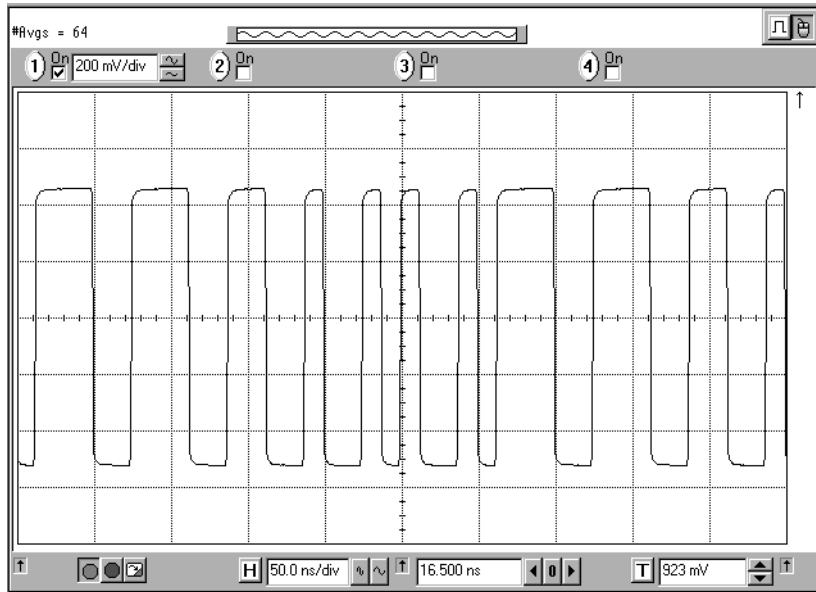

**Programming
example**

If you want to include this data stream signal in your GP-IB program use the following command lines. The comment lines starting with a # are not required.

```
# Reset the instrument to start from a defined, default status.
*RST

# Switch off the automatic display update to increase programming
# speed.
:DISPlay OFF

# Enable pattern mode and set data format of channel 1 to NRZ
:DIGital:PATtern:STATe ON
:DIGital:SIGNal:FORMat NRZ

# Set data pattern of segment 1, channel 1. The leading two
# digits "#0" are control information. The data pattern
# starts at the third digit.
:DIGital:PATtern:SEGMENT1:DATA1 #0111001110011001001010010

# Set frequency to 80 MHz and levels to ECL levels.
:FREQency 80MHz
:VOLTage1:HIGH -0.8V
:VOLTage1:LOW -2V

# Enable the output.
:OUTPut ON
```

Setting Up an Edge-Displacement Signal

Task Set up a continuous signal with one distorted pulse. The two channels are added with NRZ at both outputs. The high level is 1 V, low level is 0 V. The delay of output 2 is 30 ns and the bit frequency is 30 MHz.

NOTE For this example, both outputs and the channel addition feature are required. Therefore, this type of signal can only be performed with a Agilent 81130A with two output modules (Agilent 81131A or Agilent 81132A).

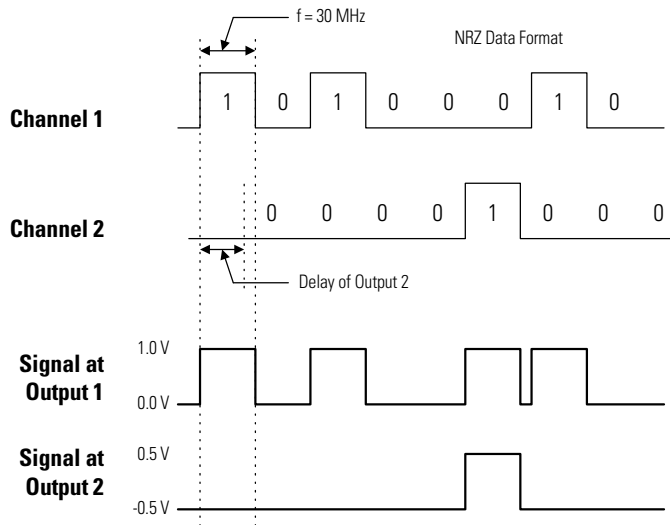

Instructions

To set the **operating mode and trigger mode** as required:

- 1 Reset all parameters and modes by pressing SHIFT + STORE + 0.
- 2 Press the MODE/TRG softkey to enter the Mode/Trigger screen.
- 3 Move the entry focus to PULSES and select PATTERN.
- 4 Set PULSES OUT 1 and OUT 2 to NRZ.

CONTINUOUS PATTERN of		<input checked="" type="radio"/> MODIFY RZ R1 *NRZ
Pulses Out 1: NRZ	Out 2: NRZ	
PRBS Polynom: 2 ⁷ -1		
Trigger Output at: Segm1 Start		
MODE/TRG	TIMING	LEVELS
PATTERN		

To set the **timing parameters** as required:

- 1 Press the TIMING softkey to enter the Timing menu.
- 2 Enter a frequency of 30 MHz.
- 3 Enter a DELAY of 30 NS for Output 2.

1	OFF	Freq 30.00MHz	OFF	2	<input checked="" type="radio"/> MODIFY 10.00 ns
	OFF		OFF		
Delay	Ops	Delay	30.00ns		
Width	-----	Width	-----		
MODE/TRG	TIMING	LEVELS	PATTERN		

NOTE

You cannot enter a pulse width because of the NRZ setting. This is indicated by the dashes in the WIDTH entry field.

Getting Started
Setting Up an Edge-Displacement Signal

To set the **data pattern** as required:

- 1 Press the PATTERN softkey to enter the Pattern menu.
- 2 Enter a LENGTH of 8 for Segment 1.
- 3 Move the entry focus to left and press the ENTER key to edit Segment 1.
- 4 Enter the pattern 10100010 for Channel 1.
- 5 Enter the pattern 00001000 for Channel 2.

Segment 1	UPDATE					<input type="radio"/> = ADDR 0 to Reset 1 to Set ± Toggle
Address	8 Length	8				
CH1 Data	0 0 1	<input type="text" value="0"/>				
CH2 Data	1 0 0	<input type="text" value="0"/>				
Both	2 0 1	<input type="text" value="0"/>				
MODE/TRG		TIMING		LEVELS		PATTERN

To set the **level parameters** as required:

- 1 Press the LEVELS softkey to enter the Level menu.
- 2 Switch on both outputs.
- 3 Change SEPARATE OUTPUTS to DIG. ADD AT OUT 1.
- 4 Set HIGHLEVEL to 1 V and LOWLEVEL to 0 V for output 1.
- 5 Set HIGHLEVEL to 0.5 V and LOWLEVEL to -0.5 V for output 2.

1	ON OFF		ON OFF	2	<input type="radio"/> MODIFY	
Dig. add at Out 1						
High	+1.00V	High	+500mV		-500	
Low	+0.0mV	Low	<input type="text" value="-500mV"/>		mV	
MODE/TRG		TIMING		LEVELS		PATTERN

The following figure shows the signal as displayed on the Agilent 54810A Infinium Oscilloscope. Use the generator's channel 2 to trigger the scope.

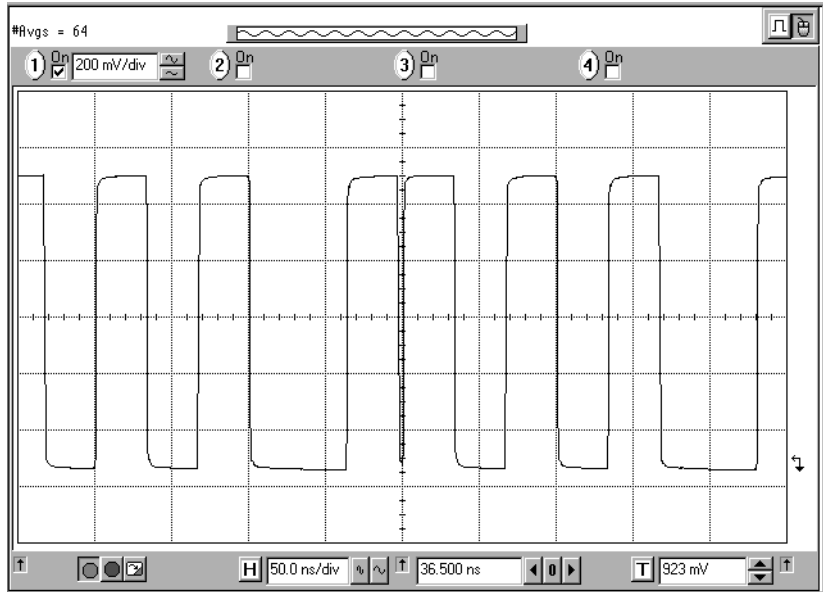

Getting Started

Setting Up an Edge-Displacement Signal

Programming example

If you want to include this edge-displacement signal in your GP-IB program, use the following command lines. The comment lines starting with a # are not required.

```
# Reset the instrument to start from a defined, default status.
*RST

# Switch off the automatic display update to increase programming
# speed.
:DISPlay OFF

# Set the data format to NRZ for both channels, enter the
# patterns, and enable pattern mode.
:DIGital:SIGNAL:FORMat1: NRZ
:DIGital:SIGNAL:FORMat2: NRZ
:DIGital:PATTern:SEGMENT1:DATA1 #1810100010
:DIGital:PATTern:SEGMENT1:DATA2 #1800001000
:DIGital:PATTern:STATe ON

# Set the frequency and the delay for channel 2.
:FREQency 30MHz
:PULSe:DELAy2 30ns

# Set the levels of outputs 1 and 2 and enable digital channel
# addition.
:VOLTage1:HIGH 1V
:VOLTage1:LOW 0V
:VOLTage2:HIGH 0.5V
:VOLTage2:LOW -0.5V
:CHANnel:MATH DIGital

# Enable the output.
:OUTPut1 ON
:OUTPut2 ON
```

Setting Up a Serial Data Sequence

Task

Set up a serial data sequence at 166.7 MHz, consisting of a header, simulated payload data accompanied by a clock on output 2, and a trailing pause.

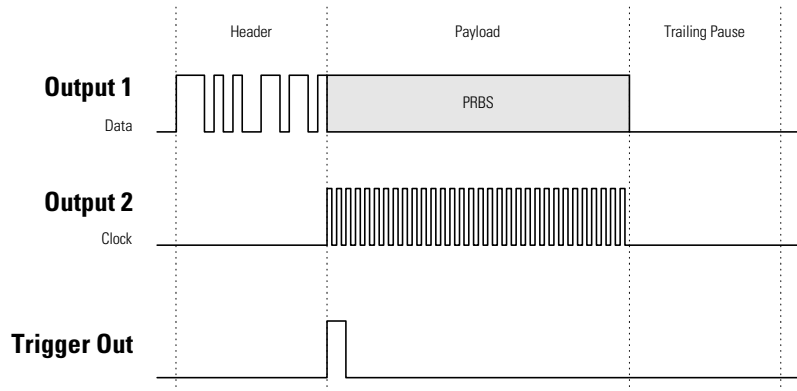

NOTE

For this example, both outputs are required. Therefore, this type of signal can only be performed with a Agilent 81130A with two output modules (Agilent 81131A or Agilent 81132A).

Getting Started
Setting Up a Serial Data Sequence

Instructions

To set the **operating mode and trigger mode** as required:

- 1 Reset all parameters and modes by pressing SHIFT + STORE + 0.
- 2 Press the MODE/TRG softkey to enter the Mode/Trigger screen.
- 3 Move the entry focus to PULSES and select PATTERN.
- 4 Move to PULSES OUT 1 and select NRZ.
- 5 Move to OUT 2 and select RZ.
- 6 Set the PRBS POLYNOM to $2^{15} - 1$.
- 7 Set TRIGGER OUTPUT AT: to SEGM2 START.

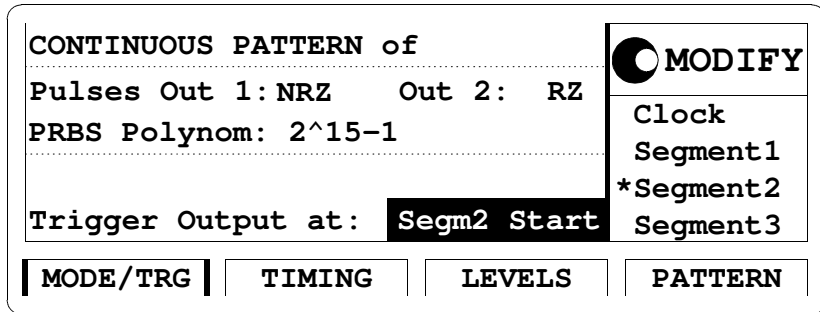

To set the **timing parameters** as required:

- 1 Press the TIMING softkey to enter the Timing menu.
- 2 Switch on both outputs.
- 3 Enter a period of 6 NS.
- 4 Enter a WIDTH of 3 NS for output 2.

1	ON OFF	Per 6.000ns	ON OFF	2	<input checked="" type="radio"/> MODIFY
Delay		Ops	Delay	0.00ns	
Width	-----	Width	3.000ns	3.000	
				ns	
MODE/TRG		TIMING		LEVELS	
				PATTERN	

NOTE

You cannot enter a pulse width for output 1 because of the NRZ setting. This is indicated by the dashes in the WIDTH entry field.

To set the **level parameters** as required:

- 1 Press the LEVELS softkey to enter the Level menu.
- 2 Select SET TTL for both outputs.

Getting Started
Setting Up a Serial Data Sequence

To set the **data pattern** as required:

- 1 Press the PATTERN softkey to enter the Pattern menu.
- 2 Move to UPDATE and select NO UPDATE.
This speeds up data setting.
- 3 Set the length of Segment 1 to 16 (header).
- 4 Set the length of Segment 2 to 32 (payload data).
- 5 Set the length of Segment 3 to 16 (trailing pause).

NOTE

The frequency of 166.7 MHz requires a segment length resolution of 8. See “*Segment/Length/Loop Control Table*” on page 81. Therefore, the lengths of the segments must be set to be multiples of 8.

Segment	Length	Loopcnt	No Upd	MODIFY
1	16		1	16
2	32			
3	16			
4	0			
MODE/TRG				TIMING
LEVELS				PATTERN

- 6 Move the entry focus to “1” in the SEGMENT column and press the ENTER key to edit the segment.
- 7 Enter 1110101001101101 as channel 1 data.
- 8 Select LOW SEG for channel 2.

Segment 1	NO UPD				<input checked="" type="radio"/> MODIFY
Address	16	Length	16		
CH1 Data	1	1	0	1	Data Seg
CH2 Low	0	0	0	0	High Seg
Both	1	1	0	1	*Low Seg
					PRBS Seg
MODE/TRG		TIMING		LEVELS	
				PATTERN	

- 9 Move to the SEGMENT entry field and select segment 2.
- 10 Select PRBS for channel 1 to generate pseudo-random payload data.
- 11 Select HIGH SEG for channel 2 to generate the clock pulse.

Segment 2	NO UPD				<input checked="" type="radio"/> MODIFY
Address		Length	32		
CH1 PRBS	15				Data Seg
CH2 High		1	1	1	*High Seg
					Low Seg
					PRBS Seg
MODE/TRG		TIMING		LEVELS	
				PATTERN	

Getting Started
Setting Up a Serial Data Sequence

12 Move to the Segment entry and select segment 3.

13 Select Low for both channels.

Segment 3	NO UPD		
Address	1 Length	16	
CH1 Low	0	0	0
CH2 Low	0	0	0
Both	0	0	0
		<input checked="" type="radio"/> MODIFY Data Seg High Seg *Low Seg PRBS Seg	
MODE/TRG	TIMING	LEVELS	PATTERN

14 Move to NO UPD and press the ENTER key.

The following figure shows the signals as displayed on the Agilent 54810A Infinium Oscilloscope. Use the generator's TRIGGER OUT to trigger the scope.

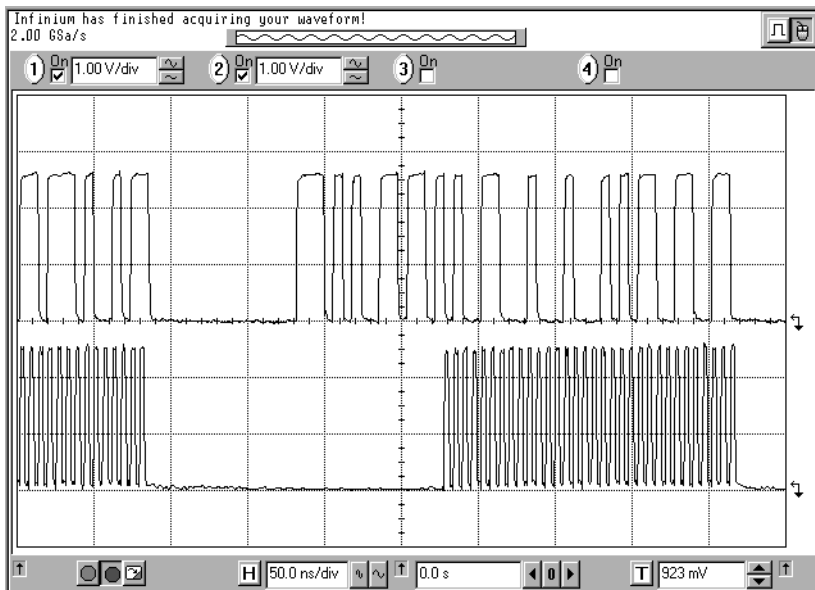

**Programming
example**

If you want to include this data sequence in your GP-IB program, use the following command lines. The comment lines starting with a # are not required.

```
# Reset the instrument to start from a defined, default status.
*RST

# Set the trigger output to start of segment 1
:SOUR:PULS:TRIG:MODE START
:SOUR:PULS:TRIG:POS 1

# Program segment 1
:DIG:PATT:SEGM1:DATA1 #01110101001101101
:DIG:PATT:SEGM1:TYPE2 LOW

# Set the length of segments 2 and 3
:DIG:PATT:SEGM2:LENG 32
:DIG:PATT:SEGM3:LENG 16

# Program segment 2
:DIG:PATT:SEGM2:TYPE1 PRBS
:DIG:PATT:SEGM2:TYPE2 HIGH

# Program segment 3
:DIG:PATT:SEGM3:TYPE1 LOW
:DIG:PATT:SEGM3:TYPE2 LOW

# Set the pulses format at output 1 to NRZ, the format at
# output 2 to RZ
:DIG:SIGN1:FORM NRZ
:DIG:SIGN2:FORM RZ

# Set the levels of outputs 1 and 2 to TTL levels.
:VOLTage1:HIGH 2.5V
:VOLTage1:LOW 0V
:VOLTage2:HIGH 2.5V
:VOLTage2:LOW 0V

# Program a period of 6 ns
:SOUR:PULS:HOLD2 DCYC
:SOUR:PULS:PER 6ns
```

Getting Started

Setting Up a Serial Data Sequence

```
# Enable pattern mode
:DIG:PATT ON

# Enable the outputs
:OUTP1 ON
:OUTP2 ON
```

3

Using the Agilent 81130A

This chapter provides complete reference information for using the Agilent 81130A by means of the user interface screens.

Each screen is described in detail. To access the individual screens, use the softkeys below the screen. There are two softkey layouts:

- the default layout



- the alternative layout displayed after pressing the MORE key



At the end of this chapter, *“Warnings and Errors” on page 96* provides details on the instrument’s warning and error messaging system.

NOTE For general information on using the Agilent 81130A and information on the instrument’s hardkeys, please refer to *Chapter 1 “Introducing the Agilent 81130A Pulse and Data Generator” on page 15*.

NOTE For information on using the Agilent 81130A via remote control, please refer to the *Reference Guide*, part number 81130-91021.

The Mode/Trigger Screen

This section describes the Mode/Trigger screen, starting with an overview of the available parameter combinations, followed by detailed descriptions of each combination.

Overview

To access the Mode/Trigger screen, press the MODE/TRG softkey.

The following figure shows a typical Mode/Trigger screen, where the individual parameters are indicated. The parameter combinations are listed in the table on the next page.

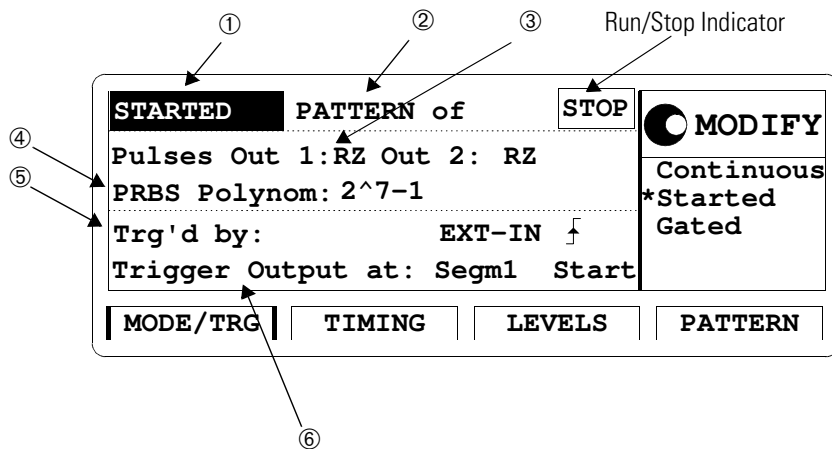

In this screen, you can start and stop the instrument and set up the signal to be continuous, started or gated and to be a pulse stream, a burst (several pulses followed by a pause) or a pattern.

Furthermore, you can specify the trigger input and the trigger output behavior.

The following table provides a list of possible parameter combinations. The rows refer to the numbers in the figure.

① Trigger Mode	Continuous			Started			Gated		
② Pulse Mode	Pulses	Burst	Pattern	Pulses	Burst	Pattern	Pulses	Burst	Pattern
③ Pulse		2-65504	RZ R1 NRZ		2-65504	RZ R1 NRZ		2-65504	RZ R1 NRZ
④ PRBS Polynom/ Burst Period		2-65504 clocks	2^7-1 to $2^{15}-1$		2-65504 clocks	2^7-1 to $2^{15}-1$		2-65504 clocks	2^7-1 to $2^{15}-1$
⑤ Arming Source/ Triggered by				MAN key Ext. Input			MAN key Ext. Input		
⑥ Trigger Out	marks each pulse period	marks start of burst	marks each pulse period or start of segment 1-4	marks each pulse period	marks start of burst	marks each pulse period or start of segment 1-4	marks each pulse period	marks start of burst	marks each pulse period or start of segment 1-4

Run/Stop Indicator

In started and gated mode, the Run/Stop indicator shows the current function of the MAN key:

- if the indicator shows RUN, pressing the MAN key starts the instrument, that is: trigger/gate is armed
- if the indicator shows STOP, pressing the MAN key stops the instrument, that is: generating of the current signal is aborted and the trigger/gate is not armed

Pattern Formats

In pattern mode, the **pulse output format** of a pattern can be selected from RZ, R1, and NRZ. The timing of the different formats is shown in the diagram:

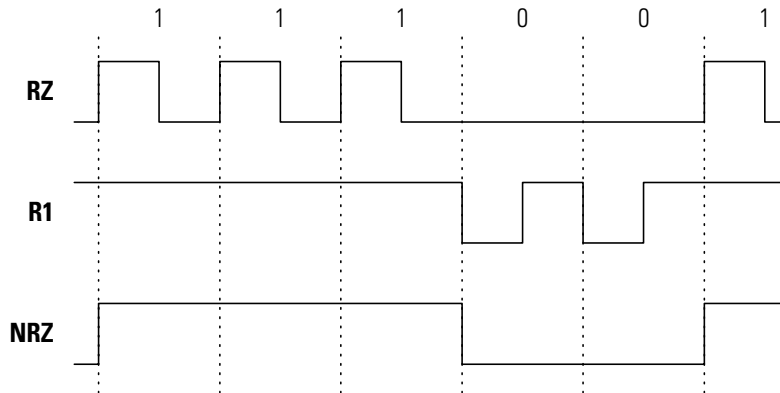

NOTE

To generate DNRZ (Delayed NRZ) signals, program NRZ pulses with a delay. See *“Pulse Delay Parameter” on page 74*.

Random Pattern

To generate **random data**, **PRBS** (Pseudo Random Binary Sequence) can be selected as a pulse type. To determine the repetition length of the PRBS sequence, specify the parameter n of the PRBS Polynom $2^n - 1$. The value range is 7 to 15. This allows to specify repetition lengths between $2^7 - 1 = 127$ and $2^{15} - 1 = 32767$.

The sequence is stored in the memory. This reduces the available memory for data patterns.

NOTE

The instrument always cycles completely through the PRBS sequence. When used multiple times or by different segments, the sequence is not restarted at the beginning of another segment's execution.

Continuous Pulses Mode

The following figure shows typical timings for trigger mode CONTINUOUS and pulse mode PULSES.

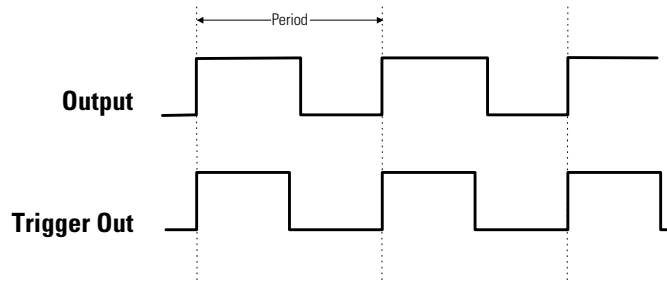

Characteristics

- Pulse periods are generated continuously.
- TRIGGER OUT marks each pulse period.

Continuous Burst Mode

The following figure shows typical timings for trigger mode CONTINUOUS and pulse mode BURST.

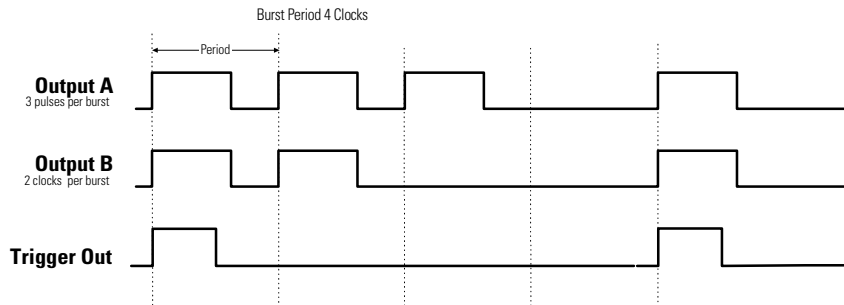

Characteristics

- A burst of pulse periods is repeated continuously.
- You can select the burst periods (total of pulse periods per burst) in the range of 2–65504.
- You can select the number of pulses per burst in the range of 2–65504 up to the burst period.
- TRIGGER OUT marks each start of a burst.

Continuous Pattern Mode

The following figure shows typical timings for trigger mode CONTINUOUS and pulse mode PATTERN.

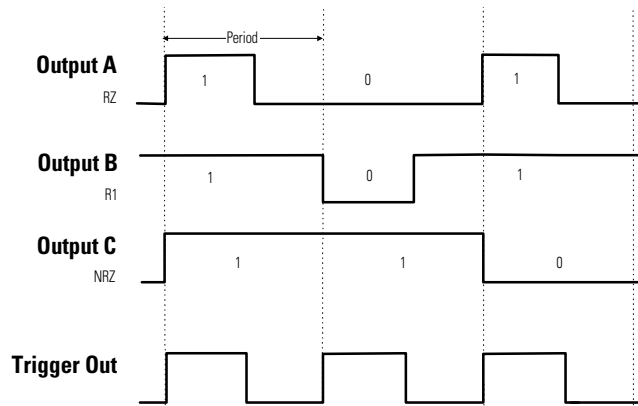

Characteristics

- A pattern of pulses is repeated continuously.
- You can select between RZ, R1 and NRZ data pulses for each output.
- In the pattern screen (see *"The Pattern Screen" on page 79*) you can
 - select the pattern length and the data values for each output
 - divide your pattern into individual, repeatable segments.
- You can select TRIGGER OUT to mark each pulse period, or the start of a selected segment.

Started Pulses Mode

The following figure shows typical timings for trigger mode STARTED and pulse mode PULSES. The pulses are triggered by the rising edge of the arming source.

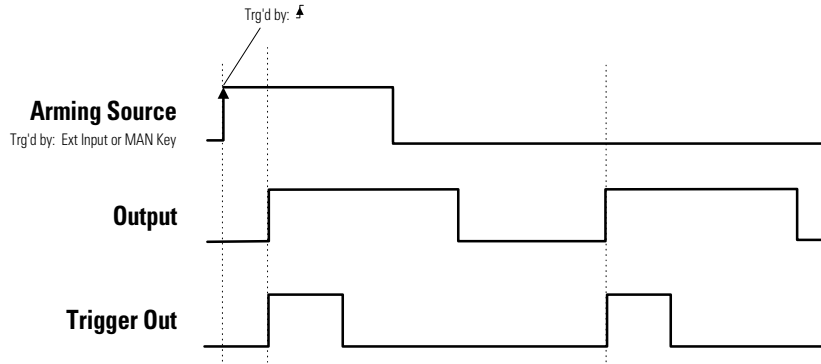

Characteristics

- Pulse periods are triggered by (TRG'D BY) an active edge at the selected arming source:
 - MAN key on front panel, triggered by pressing or releasing.
 - EXT INPUT triggered by rising or falling edges.
- TRIGGER OUT marks each pulse period.

NOTE

For the delay between trigger in to output refer to *Agilent 81130A Reference Guide, Chapter 3 "Specifications"*.

Started Burst Mode

The following figure shows a typical timing for trigger mode STARTED and pulse mode BURST. The bursts are triggered by the rising edge of the arming source.

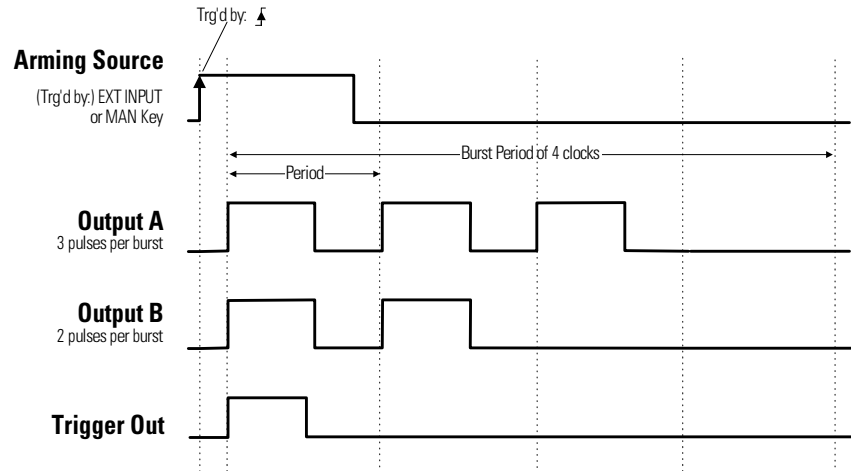

Characteristics

- A burst of pulse periods is triggered by an active edge at the selected arming source
 - MAN key on front panel, triggered by pressing or releasing.
 - EXT INPUT triggered by rising or falling edges.
- You can select the burst periods (total of pulse periods per burst) in the range of 2–65504.
- You can select the number of pulses per burst in the range of 2–65504 up to the burst period.
- TRIGGER OUT marks each start of a burst.

Started Pattern Mode

The following figure shows typical timings for trigger mode STARTED and pulse mode PATTERN. The patterns are triggered by the rising edge of the arming source.

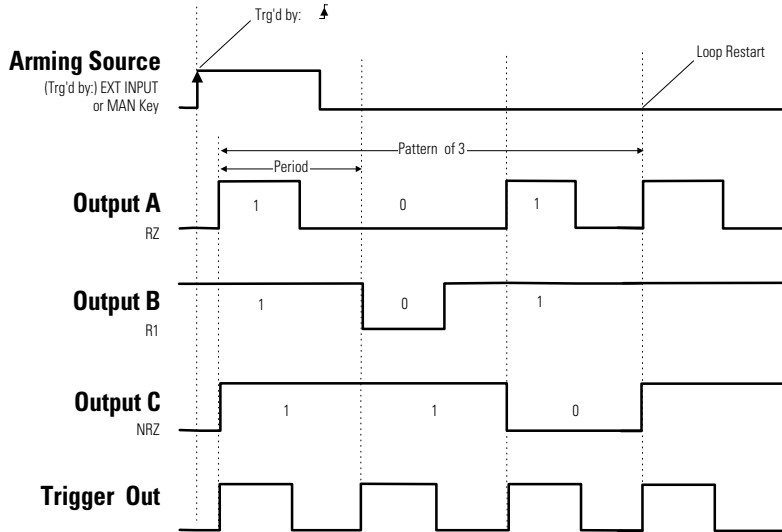

The pattern is repeated only if it is embedded in a loop.

Characteristics

- A pattern of pulses is triggered by an active edge at the selected arming source
 - MAN key on front panel, triggered by pressing or releasing.
 - EXT INPUT triggered by rising or falling edges.
- You can select between RZ, R1 and NRZ data pulses for each output.
- In the pattern screen (see *"The Pattern Screen" on page 79*) you can
 - select the pattern length and the data values for each output
 - divide your pattern into individual, repeatable segments.
- You can select TRIGGER OUT to mark each pulse period or the start of a selected segment.

Gated Pulses Mode

The following figures show typical timings for trigger mode GATED and pulse mode PULSES.

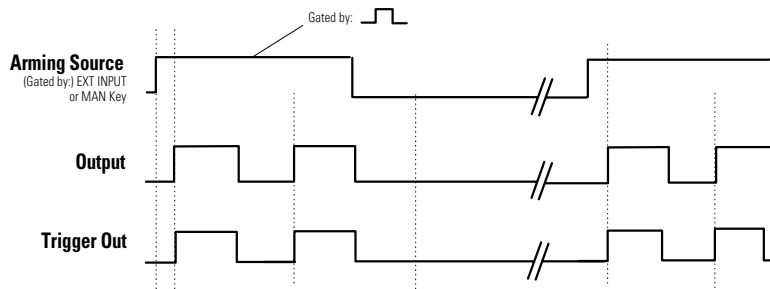

Characteristics

- Pulse periods are gated by (enabled by) an active level at the selected arming source:
 - MAN key on the front panel, gated while pressed.
 - EXT INPUT (external signal) gated by high or low.
- TRIGGER OUT marks each pulse period.

Gated Burst Mode

The following figure shows typical timings for trigger mode GATED and pulse mode BURST.

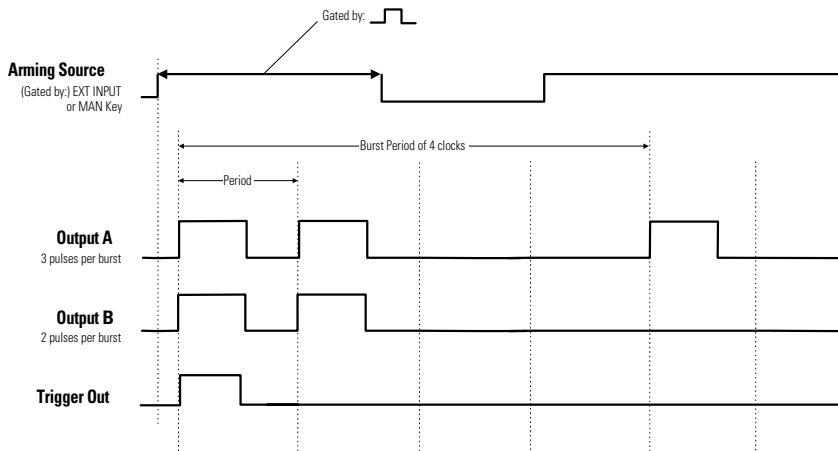

Characteristics

- Bursts of pulse periods are gated by (enabled by) an active level at the selected arming source:
 - MAN key on the front panel, gated while pressed or released.
 - EXT INPUT (external signal) gated by high or low.
- You can select the burst periods (total of pulse periods per burst) in the range of 2–65504.
- You can select the number of pulses per burst in the range of 2–65504 up to the burst period.
- TRIGGER OUT marks each start of a burst.

NOTE

When the gate signal is deasserted, the burst generation will be interrupted immediately and resume with the next phase after the gate signal is asserted again.

Gated Pattern Mode

The following figure shows typical timings for trigger mode GATED and pulse mode PATTERN.

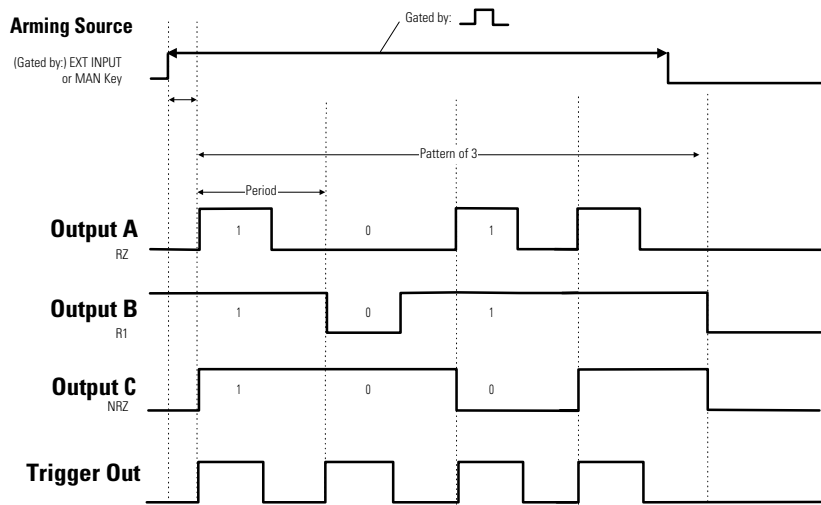

Characteristics

- A pattern of pulses is gated by an active level at the selected arming source
 - MAN key on front panel, gated while pressed or released
 - EXT INPUT (external signal) gated by high or low.
- You can select between RZ, R1 and NRZ data pulses for each output.
- In the pattern screen (see *"The Pattern Screen" on page 79*) you can
 - select the pattern length and the data values for each output
 - divide your pattern into individual, repeatable segments.
- You can select Trigger out to mark each pulse period or the start of a segment.

NOTE

When the external gate signal is deasserted, the pattern generation will be interrupted immediately and resume with the next phase after the gate signal is asserted again (with the MAN key, pattern generation will always start from the beginning).

The Timing Screen

To access the Timing screen press the TIMING softkey.

You can use the left part of the Timing screen to view and control the pulse timing parameters of channel 1, the right part for those of channel 2.

1	OFF OFF	Per	1.000 μ s	OFF OFF	2	<input type="radio"/> MODIFY
Delay	Ops	Delay	Ops	1.000 μ s		
Width	100.0ns	Width	100.0ns			
LeadE	0.8ns	LeadE	0.8ns			
TraiE	=LeadE	TraiE	=LeadE			
MODE/TRG		TIMING		LEVELS		PATTERN

The individual timing parameters are described in more detail in the following. Parameters can be entered in different formats. The LEAD E and TRAI E parameters are available with the AGILENT 81131A output module only.

If you prefer to set the timing parameters per output together with the level parameters of that output, switch the type of parameter grouping. See *“Parameter Grouping” on page 93*.

NOTE

If only one channel is installed, Timing and Levels screens are grouped in an Output screen automatically.

When you press SHIFT + MORE (GRAPH) or the TIMING softkey again, you will see a graphical representation of the timing parameters of both channels. The currently selected parameter is displayed in the Modify/Enter area and is indicated by dashed or bold lines in the graphical display.

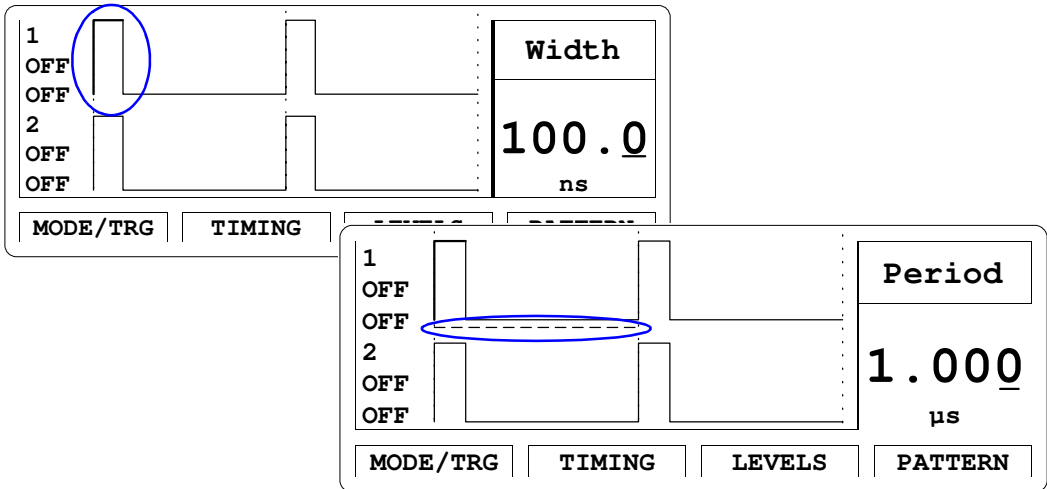

Use the left/right cursor keys to move to an individual timing parameter.

NOTE

Note that in graphics mode you can only adjust the *values* of each parameter, not the parameter format. If you want to change the format of a parameter, for example WIDTH to DTYCYC, you must be in text mode to select the parameter name with the cursor.

Press SHIFT + MORE (GRAPH) or the TIMING softkey again to toggle between textual and graphical display.

Output ON/OFF Parameter

Switch on and off the normal output and the inverted output of each channel.

NOTE

If a channel is switched on, this also activates the internal error check to detect parameter conflicts.

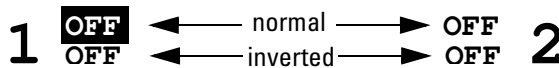

You can use short cuts as described in [“Switching the Outputs On and Off” on page 27](#).

Pulse Period Parameter

Set the pulse period as either PERIOD or FREQUENCY.

Pulse Delay Parameter

Set the delay of the leading edge within the pulse period. There are three delay formats available:

- DELAY (select ABSOLUTE)
DELAY is the absolute delay from the start of a pulse period to the start of the leading edge of the pulse.
- DELAY% (select % OF PERIOD)
The delay from the start of the pulse period to the start of the leading edge expressed as a percentage of the pulse period.
- PHASE (select PHASE)
The phase delay in degrees from the start of the pulse period to the start of the leading edge ($360^\circ = 1$ pulse period).

Pulse Width Parameter

Set the width of the output pulse. There are three width formats available:

- **WIDTH** (select WIDTH)
The absolute pulse width measured from the start of the leading edge to the start of the trailing edge. In this format, the pulse width is independent of changes in pulse period and delay.
- **DTYCYC** (select DUTYCYCLE)
The duty cycle is the pulse width measured from the start of the leading edge to the start of the trailing edge expressed as a percentage of the period. In this format, if you adjust the period, the absolute width is adjusted to maintain the duty cycle.
- **TRADEL** (select TRAILDEL)
The trailing delay is the absolute delay from the start of the pulse-period to the start of the trailing edge. In this format the trailing edge remains fixed relative to the start of the pulse period if you adjust the pulse delay (leading edge delay) or the pulse period.

Leading Edge/Trailing Edge Parameter

This parameter is available only with the AGILENT 81131A output module.

Select between two different values of the transition time of the pulse.

- **LEADE**
Set the transition time to 0.8 or 1.60 ns.
- **TRAIE**
The trailing edge is always the same as the leading edge.

The Levels Screen

To access the Levels screen press the LEVELS softkey.

You can use the left part of the Levels screen to view and control the level parameters of channel 1, the right part for those of channel 2, and you can select to add the channels.

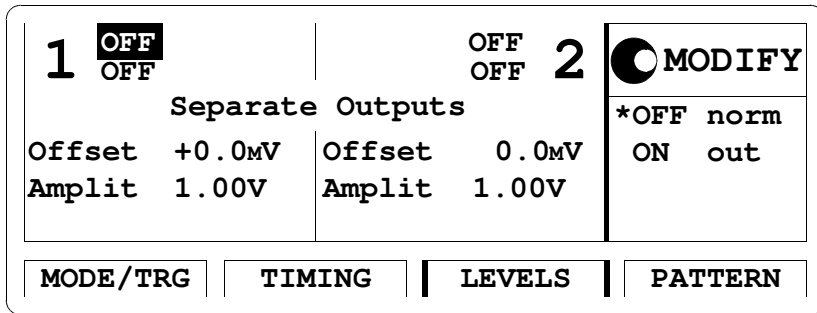

When you press SHIFT + MORE (GRAPH) or the LEVELS softkey, you will see a graphical representation of the level parameters. The currently selected parameter is displayed in the Modify/Enter area and is indicated in the graphical display.

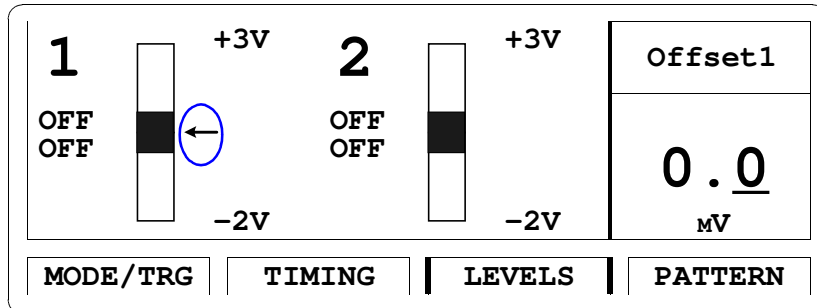

When output limits are on, the limits are indicated on the Levels screen in graphics mode (see *"The Limits Screen" on page 86*).

If you prefer to set the level parameters per output together with the timing parameters of that output, switch the type of parameter grouping. See “*Parameter Grouping*” on page 93.

NOTE If only one channel is installed, Timing and Levels screens are grouped in an Output screen automatically.

NOTE Note that in graphics mode you can only adjust the *values* of each parameter, not the parameter format. If you want to change the format of a parameter, for example OFFS-AMPL to HIGH-LOW, you must be in text mode to select the parameter name with the cursor.

NOTE When the output is switched on, the instrument monitors the actual voltage and current levels at the output. The output is automatically switched off if voltage levels or power dissipation reach levels that could damage the output circuits.

Separate Outputs/Digital Add Parameter

Select the outputs of channel 1 and 2 to be separate or digitally added (available only in text mode):

- SEPARATE OUTPUTS (select SEPARATE)
Output 1 and 2 operate as entirely separate outputs.
- DIGITAL ADD AT OUT1 (select DIG. ADD)
Channel 1 and 2 are added (XOR-combined). The resulting signal is available at the output 1 connector. Use this to build complex pulse waveforms. Channel 2 is still available.

NOTE The channel add option is available if the AGILENT 81130A is equipped with an additional output module AGILENT 81131A or AGILENT 81132A.

Offset/Amplitude, High/Low Level Parameters

Set and display the pulse levels in terms of either offset and amplitude, or high and low level. You can quickly set TTL or ECL output levels using the SET TTL and SET ECL formats.

- SET TTL

Set the levels to the default TTL levels automatically:

TTL-HI: +2.50 V
TTL-LOW: +0.0 mV

The default levels are set once and can be adjusted afterwards by moving the entry focus to the values as normal.

- HIGH-LOW

Select high and low level format for the pulse levels.

- OFFS-AMPL

Select offset and amplitude format for the pulse levels. Offset is measured from 0V to the middle of the pulse amplitude. Pulse amplitude is the difference between the high and low levels of the pulse.

- SET ECL

Set the levels to the default ECL levels automatically:

ECL-HI: -850 mV
ECL-LOW: -1.80 V

These default levels are set once and can be adjusted afterwards by moving the entry focus to the value as normal.

Voltage/Current Mode (mV/V/mA/A)

Move the entry focus onto the level units to select between setting the pulse levels IN VOLTS or IN AMPERES.

NOTE

This parameter is only available in text mode.

The Pattern Screen

Use the Pattern screen to set up a pattern sequence to be generated by the instrument.

To access the Pattern screen, press the PATTERN softkey.

The screenshot shows the Pattern Screen interface. It features a table with the following data:

Segment	Length	Loopcnt	Update
1	32	1	
2	0		
3	0		
4	0		

Annotations in the image point to the following elements:

- Segment Select:** Points to the '1' in the first row of the table.
- Loop Indicator:** Points to the '32' in the second column of the first row.
- Resume Indicator (in gated/started mode only):** Points to the upward-pointing arrow in the first column of the table.

Other visible elements include an **ENTER** button, a ***Edit Segm** option, and four softkey buttons at the bottom: **MODE/TRG**, **TIMING**, **LEVELS**, and **PATTERN**.

The pattern sequence can consist of up to 4 individual segments of a specific length. Each segment contains the data for channel 1 and 2.

In gated and in started mode you can select to execute the sequence only once or to jump back to a segment of your choice at the end of the sequence (resume indicator).

You can build loops by specifying:

- the loop start segment (loop indicator)
- the length of the loop, that is the total of segments in the loop (loop indicator)
- the loop count, that is how often the loop is executed.

Update Parameter

Select to update the hardware after each of your changes in the screen or only on demand.

- **UPDATE** (select UPDATE)
The hardware is updated automatically after each change. Changes will affect the output signal immediately.
- **NO UPD** (select NO UPDATE)
The hardware is not updated automatically. For faster editing, complete your programming before you update the hardware, then move the entry focus to NO UPD and press the ENTER key.

Resume Indicator

This indicator is only available in gated and started mode. Specify how the sequence is to be executed.

- **RUN ONCE**
The sequence is executed only once.
- **JUMP TO SEGMENT 1 ... 4** (select JMPTO SEG1 ... JMPTO SEG4)
Select a segment with which the instrument should resume after the last segment of the sequence has been executed.

Segment/Length/Loop Control Table

The parameters in this table control the segment and loop parameters. You can move the entry focus to any cell of the table.

- **SEGMENT** column
Select a segment to edit. Press ENTER to invoke the segment editor. See *"The Segment Editor" on page 83*.
- **LENGTH** column
Adjust the length of the segment.
The maximum length of all segments is 65504 per channel. If PRBS data is used, this value is reduced by the repetition length as given by the PRBS Polynom parameter.

NOTE

Reducing the length of a programmed segment results in the loss of as many bits as the segment length is reduced, even if the length is raised again later.

The **segment length resolution**, that is the steps in which you can set the segment length, depends on the required data rate:

Resolution	Maximum Data Rate in MBit/s	Period in ns
1	41.67	24.00 ... max. period
2	83.33	12.00 ... 23.99
4	166.7	6.000 ... 11.99
8	333.3	3.000 ... 5.999
16	666.7	1.500 ... 2.999

Example:

If a data rate of 300 MBit/s is required, each segment length must be a multiple of 8 (8, 16, 24, 32, ...).

- Loop indicator
Use the loop indicator to specify the start segment and the length of the loop. Move the entry focus to the indicator, select
 - LOOPSTART to specify the start segment of the loop and press the ENTER key.
Choose from SEGMENT 1 ... SEGMENT 4 and press the ENTER key again.
 - LOOPLENGT to specify the length of the loop and press the ENTER key.
Choose from 1 SEGMENT ... 4 SEGMENT and press the ENTER key again.
- LOOPCNT column
In the Loopcount column, specify how often the loop is to be executed (maximum loopcount is 2^{20}).

NOTE

If *counted loops* (loop counter, loop indicator) are used, the minimum length for the first segment is required to be twice the segment length resolution.

If only an *infinite loop* (resume indicator, continuous mode) is used, the sum of all used segment lengths is required to be twice the segment length resolution.

The Segment Editor

Use the segment editor to set up a data segment for the pattern sequence.

To edit a segment, select the segment in the Segment column of the Pattern screen and press the ENTER key.

Bit-editing window

Segment 1	UPDATE					32	● = ADDR
Address	1	Length					
CH1 Data	1	0	0	0	0	0	0
CH2 Data	0	0	0	0	0	0	0
Both	1	0	0	0	0	0	0

MODE/TRG	TIMING	LEVELS	PATTERN
----------	--------	--------	---------

The right-hand side of the window shows a legend for the ADDR parameter:

- 0 to Reset
- 1 to Set
- ± Toggle

The parameters Segment, Update, and Length refer to the corresponding entries in the Pattern screen.

The CH1 and CH2 rows contain the bits of the data patterns for channel 1 and channel 2. The BOTH row allows to edit both channels together by entering the decimal equivalent:

CH1	0	1	0	1
CH2	0	0	1	1
BOTH	0	1	2	3

When you press SHIFT + MORE (GRAPH), you will see a graphical representation of the data. This is especially helpful when viewing and editing NRZ data.

Address Parameter

The current bit address in the segment is displayed. Use the knob to scroll through the data or enter a value to move to a particular address.

Data Type Parameter

Select a data type per channel. It is displayed next to the CH1 and CH2 column.

- DATA
This allows you to enter the bits of your sequence manually or by using block editing functions. See *“Block Editing Functions” on page 85*.
- HIGH, LOW
Set all bits to high or low.
- PRBS
Set all bits to be generated pseudo-randomly.
The following rules apply when PRBS data is used:
 - in the same segment, the data type of the other channel must be high, low, or PRBS
 - over all segments, PRBS must only be used in combination with the same data type

Example:

The following table shows an example of how the PRBS data type may be combined in a pattern sequence of 4 segments:

	Segment 1	Segment 2	Segment 3	Segment 4
Channel 1	Data	PRBS	Data	PRBS
Channel 2	Low	High	Data	High

NOTE

Specify the repetition length of the pseudo-random data sequence in the Mode/Trigger screen. See *“The Mode/Trigger Screen” on page 60*.

Block Editing Functions

The block editing functions can help when entering bit patterns.

Move the entry focus onto the CH1, CH2, or BOTH at the left hand side of the screen. Select from the following options and press ENTER.

- **FILL 0, FILL 1**
Set all bits from the current position to the end of the sequence to 0 or 1.
- **INVERT**
Invert all bits from the current position to the end of the sequence.
- **FIRST BIT**
Set the first bit to 1, and all following bits to 0.
- **LAST BIT**
Set the last bit to 1, and all preceding bits to 0.
- **INS BIT**
Insert a bit at the current position. The bit value is copied from the current bit, all subsequent bits are shifted right. The last bit is lost.
- **DEL BIT**
Delete the bit at the current position. All subsequent bits are shifted left. The new last bit of the sequence is copied from the old last bit.
- **CLOCK÷N**
Fill the bits from the current position to the last with a divided clock pattern. After pressing ENTER you can adjust the dividing factor n from 2 to 32768 and press ENTER again.

The bit sequence will be set up as follows:

n	Sequence	n	Sequence
2	101010101010101...	6	111000111000111...
3	100100100100100...	7	111000011100001...
4	110011001100110...	8	111100001111000...
5	110001100011000...	9	1111000001111000...

The Limits Screen

Use the Limits screen to set up voltage and current limits for the pulse level parameters to prevent accidental damage of the device under test.

To access the Limit screen press the LIMITS softkey. If the softkey is not displayed, press MORE.

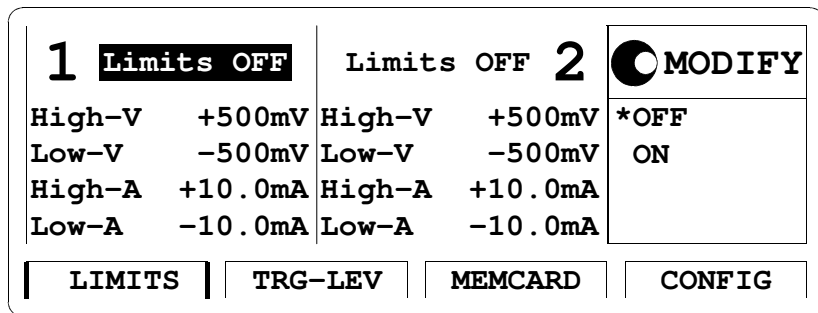

After you switch on the limits, the pulse level parameters on the Levels screen cannot be adjusted outside the ranges specified on the Limits screen if the output is switched on.

The limits are displayed in the Level screen in graphics mode.

The Trigger-Level Screen

Use the Trigger-Level screen to

- set the termination voltage and the triggering threshold for the EXT INPUT connector
- set the termination voltage for the CLK/REF INPUT connector
- set the output termination and levels for the TRIGGER OUT connector.

To access the Trigger-Level screen, press the TRG-LEV softkey. If the softkey is not displayed, press MORE.

EXT-IN: Term +0.00V Tres +1.00V	● +ENTER *Variable Set TTL Set ECL Set PECL		
CLK-IN: Term +0.00V			
TR-OUT: TTL into 0V/50Ω term			
LIMITS	TRG-LEV	MEMCARD	CONFIG

External Input Connector

Select a termination voltage and a threshold for the external input connector (EXT-IN). Press the ENTER key to complete.

- VARIABLE
Move the entry focus to the voltage fields and enter the termination voltage and the threshold in the range of -2.1 V to $+3.3\text{ V}$.
- SET TTL, SET ECL, SET PECL
The termination voltage and termination are adjusted according to the selected technology.
These default values are set once and can be adjusted afterwards by moving the entry focus to the value as usual.

Clock Input Connector

Select a termination voltage clock input connector (CLK-IN). Press the ENTER key to complete.

- VARIABLE
Move the entry focus to the voltage field and enter the termination voltage in the range of -2.1 V to $+3.3\text{ V}$.
- SET TTL, SET ECL, SET PECL
The termination voltage is adjusted according to the selected technology.
These default values are set once and can be adjusted afterwards by moving the entry focus to the value as usual.

Trigger Out Connector

Select an output level and termination according to the technology used at the trigger output (TR-OUT).

The Memory Card Screen

Use the Memory Card screen to

- store instrument settings to the memory card,
- recall instrument settings from the memory card,
- delete files from the memory card,
- format a memory card.

To access the Memory Card screen, press the MEMCARD softkey. If the softkey is not displayed, press MORE.

The screenshot shows the Memory Card screen interface. It features a dark header bar with the text "Dir Path \". Below this, the "Filename" field contains "TESTVI.TXT". A dotted line separates the filename from the "Perform Operation" field. To the right of the main text area is a "MODIFY" button with a circular knob icon. Below the "Perform Operation" field, there is a list of directory entries, with "* ." visible. At the bottom of the screen, there are four softkey buttons: "LIMITS", "TRG-LEV", "MEMCARD", and "CONFIG".

Directory Path Parameter

Move the entry focus to DIR PATH to change the directory on the memory card, or to view the sub-directories of the current directory (the name of the current directory is displayed next to DIR PATH).

All sub-directories of the current directory are listed in the Modify/Enter area.

To change the directory, turn the knob to select the directory name and press the ENTER key.

Note that when you are in a sub-directory you can return to the parent-directory by selecting ".." from the directory list.

Filename Parameter

Move the entry focus to the FILENAME parameter to select a file from the current directory. Use the knob to scroll through the filenames listed in the Modify/Enter area.

Memory Card Operations

Move the entry focus to PERFORM OPERATION and use the knob to select the required operation. Press the ENTER key to perform the operation.

- READCARD
Read the DOS file system information from the memory card after inserting a new card.
- RECALL
Recall the selected file as the current instrument setting.
- STORE
Store the current instrument setting to the memory card.
Press ENTER once to start editing the filename for the setting in the Modify/Enter area. The currently selected filename is used as default.

CAUTION

If you do not modify the filename, the existing file will be overwritten when you press ENTER.

To modify the filename, move the character cursor with the cursor keys. Modify a character using the knob. When you have finished, press ENTER to store the setting.

The filename can be up to 8 characters long.

Press the cursor up or cursor down keys to cancel the store operation at any time.

Note that the DOS filename suffix “.ST0” is added automatically to the filename when you store the current settings.

- **STORE ALL**

Store the current instrument setting and the instrument setting memories 1 to 4 to the memory card. Each setting is stored in a separate file with the same name but different suffixes (“.ST0” for the current setting, “.ST1” to “.ST4” for setting memories 1 to 4).

Press ENTER once to start editing the filename for the setting in the Modify/Enter area. The currently selected filename is used as default.

CAUTION

If you do not modify the filename, the existing file will be overwritten when you press ENTER.

To modify the filename, move the character cursor with the cursor keys. Modify a character using the knob. When you have finished, press ENTER to store the setting.

The filename can be up to 8 characters long.

Press the cursor up or cursor down keys to cancel the store operation at any time.

- **DELETE**

Delete the selected file from the memory card.

- **FORMAT**

Format the memory card.

CAUTION

Formatting a memory card destroys any existing files on the card.

The Configuration Screen

Use the Configuration screen to:

- set the GP-IB address of the Agilent 81130A
- initiate instrument selftests
- group parameters by timing/levels or by output 1/2
- select the pulse period source
- select the frequency reference source for the PLL
- compensate for delays between channel 1 and 2 by deskewing

To access the Configuration screen, press the CONFIG softkey. If the softkey is not displayed, press MORE.

GP-IB Address: 10	 MODIFY		
Perform Selftest: μ P and Signal	10		
Group Params by: TIMING/LEVELS			
Pulse-Period: internal PLL			
PLL-Ref: Internal			
Deskew 1: +0ps 2: +0ps			
LIMITS	TRG-LEV	MEMCARD	CONFIG

GP-IB Address

Set the GP-IB address for the instrument in the range of 0 to 30. The default address is 10.

Perform Operation Selftest

Move the entry focus to **PERFORM: SELFTEST**, select the test type, and press the **ENTER** key.

- **μP BOARD**
Perform a selftest on the microprocessor board of the Agilent 81130A.
- **SIGNAL**
Perform a selftest on the timing and output modules of the Agilent 81130A.
- **μPROCESSOR AND SIGNAL (select BOTH)**
Perform both selftests.

If the selftests fail, a flashing **E** is displayed. Press **HELP** to see the list of error messages.

Parameter Grouping

The timing and level parameters of both outputs 1 and 2 can be displayed in separate screens either grouped by parameter types (timing/level), or by output.

Move the entry focus to **GROUP PARAMS BY:** and select between

- **TIMING/LEVELS**
- **OUTPUT1/2**

For descriptions of the screens, refer to *“The Timing Screen” on page 72*, *“The Levels Screen” on page 76* or *“The Output Screens” on page 95*.

NOTE

If only one channel is installed, Timing and Levels screens are grouped in an Output screen automatically.

Pulse Period Source

The instrument provides an internal PLL to generate the pulse period. However, you can use an external clock source applied to the CLK/REF INPUT connector instead.

- INTERNAL PLL
Internal PLL is used for pulse period generation.
- CLK-IN
External clock source is used for pulse period generation.

NOTE

The externally applied clock signal is measured once when CLK-IN is selected. During the measurement, the instrument cannot generate pulses.

If the external frequency is changed without re-measuring, all timing parameters become invalid. To update the measurement, select MEASURE ONCE in the Period/Frequency entry field of the Timing screen and press the ENTER key.

PLL Reference

Set the frequency reference source for the PLL:

- INTERNAL
An internal signal is used as reference.
- CLK-IN
An external reference signal at the CLOCK/REF INPUT connector is used. The frequency must be 1, 2, 5, or 10 MHz.

NOTE

The PLL reference parameter is available only if INTERNAL PLL is selected as PULSE-PERIOD parameter.

Deskew Parameter

Set the deskew of output 1 and 2 in the range of ± 25.05 ns to compensate for different cable delays.

The Output Screens

If two channels are installed, the Output screens show both, timing and level parameters combined on one screen for output 1 and one screen for output 2. To make the Output screens available, the parameter GROUP PARAMS BY: must be set to OUT 1/2 in the Configuration screen (see *“The Configuration Screen” on page 92*).

To access an Output screen, press the OUTPUT1 or OUTPUT2 softkey.

NOTE

If only one channel is installed, Timing and Levels screens are grouped in an Output screen automatically.

Warnings and Errors

The Agilent 81130A has two levels of error reporting called “warnings” and “errors”. Checking for errors and warnings is always enabled, unless you switch it off via the GP-IB using the `:SYSTEM:CHECK` command or by switching off the output(s).

- A **warning** is generated when the output signal *could* be invalid due to a combination of worst case uncertainties at the current settings of all relevant parameters.

For example, when adjusting the pulse width, all other timing parameters and their uncertainties have to be considered in order to check if the width setting will fit within the pulse period.

Note that the warning limits are therefore not fixed for a particular parameter, but vary with the settings of the related parameters. It is also possible that the error and warning limits are the same, that is, a warning does not occur before the error limit is reached.

If a warning occurs, the settings are still implemented in the hardware because the worst-case conditions used to evaluate the warning limits are very unlikely to occur in practice.

A blinking W indicates that one or more warnings have occurred. Press HELP to view the warning list.

- An **error** is generated when an invalid mode is chosen, or the required parameter settings cannot be implemented in the output hardware. Multiple errors can occur, but only the first error detected is displayed.

An error is indicated by a blinking error message at the bottom of the screen.

NOTE

If the output(s) are switched off and you are using the knob to adjust parameters, it is usually not possible to generate warnings or errors. All parameters are automatically limited to settings that guarantee specified operation.

However, if you press the SHIFT key while turning the knob, you can adjust a parameter beyond its warning limits. This requires the output(s) to be switched on.

NOTE

You can press SHIFT + HELP (AUTOSET) to carry out an autoset. The instrument resets all parameters, based on the current period setting, to remove all warning and error conditions.

An Example of Warning and Error Reporting

- 1** Switch on the instrument and recall the standard settings by pressing SHIFT + STORE (RECALL) + 0.
The period is now set to 1 μ s.
- 2** Switch on the output by pressing SHIFT + 0 (ON/OFF).
- 3** On the Timing screen, move the parameter cursor to the value of the WIDTH parameter (100NS).
- 4** Use the knob to make the pulse width as large as possible (998.5 NS).
This limit is intended to guarantee that the actual output pulse is within specifications, for the actual period.
- 5** Press SHIFT and adjust the pulse width above its warning limit. A flashing W appears to indicate that a warning condition has occurred.

NOTE

Note that as long as no errors occur, the output hardware is set up and attempts to generate the required output.

- 6** Press HELP to see the warning message:
WIDTH 1 TOO CLOSE TO PERIOD
- 7** Press HELP again to return to the WIDTH parameter.
- 8** Increase the pulse width further until a flashing error message appears (approximately 999.5 ns):
OUTPUT 1: WIDTH > PERIOD
You have reached the current upper error-limit of the WIDTH parameter.
The setting is not possible with the hardware.
- 9** Press SHIFT + HELP to perform an AUTOSET.

Using the Agilent 81130A
Warnings and Errors

A

Installation & Maintenance

Initial Inspection

Inspect the shipping container for damage. If the container or cushioning material is damaged, keep it until the contents of the shipment have been checked for completeness and the instrument has been verified both mechanically and electrically.

WARNING

To avoid hazardous electric shock, do not perform electrical tests when there are signs of shipping damage to any part of the instrument's outer covers or panels.

If the contents are incomplete, or there is mechanical damage, or if the instrument does not work as expected within its specifications, notify the nearest Agilent office. (Please request the latest performance tests from Agilent Technologies.) Keep the shipping materials for inspection by the carrier. The Agilent office will arrange for repair or replacement without awaiting settlement.

Standard Deliverables

The Agilent 81130A shipping container contains the following standard deliverables:

1. The Agilent 81130A Pulse Generator.
2. The english Quick Start Guide and a Reference Guide.
3. A power cord.

1. Agilent 81130A Pulse/Pattern Generator



2. This Quick Start Guide and the Reference Guide



3. A Power Cord

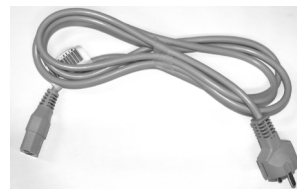

Options and Accessories:

Options

Agilent 81131A	400 MHz, 3.8 V Output module
Agilent 81132A	660 MHz, 2.4 V Output module
Agilent 15104A	Pulse Adder/Splitter
Rear Panel Connectors	Option UN2 All inputs and outputs are at the rear panel
1 MB SRAM Memory Card	Option UFJ (Agilent part number 0950-3380)

NOTE

You can only use one type of output module (Agilent 81131A or Agilent 81132A) per instrument.

The following figure shows the instruments rear panel with Option UN2 installed.

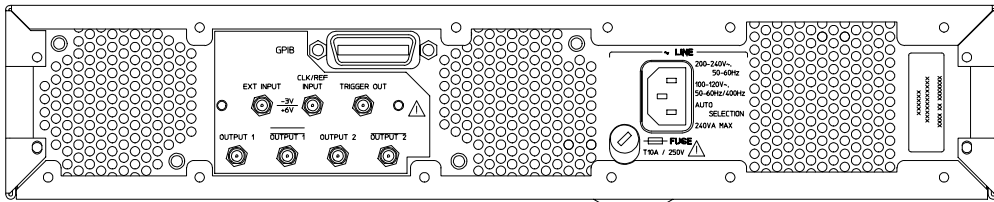

Handle Accessory

Front Handle Kit	Agilent part number 5063-9226
------------------	-------------------------------

Rack Mounting Accessories

Rack Mount Kit	Agilent part number 5063-9212
Rack Mount and Front Handle Kit	Agilent part number 5063-9219
Rack Slide Kit	Agilent part number 1494-0059

Quick Start Guide Language Options

French Guide	Option ABF (Agilent part number 81130-91220)
Japanese Guide	Option ABJ (Agilent part number 81130-91520)
Taiwan Chinese Guide	Option AB0 (Agilent part number 81130-91620)
Korean Guide	Option AB1 (Agilent part number 81130-91720)
Chinese Guide	Option AB2 (Agilent part number 81130-91820)

Additional Documentation Options

Service Manual	Option 0BW (Agilent part number 81130-91021)
----------------	---

Power Requirements

CAUTION

Before applying AC line power to the instrument, ensure that the correct line fuse is installed in the fuse holder and the correct power cable is fitted.

NOTE

When the front panel switch is off, the instrument is in “standby” mode. The instrument is disconnected from the AC line power *only* by disconnecting the power cord. Please make sure that the power cord is easily identifiable and can quickly be reached by the operator.

The following symbol is close to the ‘Standby’ switch on the front panel of the instrument.



The instrument can operate from any single-phase AC power source supplying 100–240 V in the frequency range from 50 to 60 Hz, or 100–120 V at 400 Hz. The maximum power consumption is 300 VA with all options installed. When the instrument is switched on the power supply adapts automatically to the applied AC power (Auto Selection) and monitors the AC power range during operation.

Replacing the Fuse



- 1 Remove the power cord.
- 2 Unscrew the fuse cap at the rear of the instrument beside the power-inlet socket.

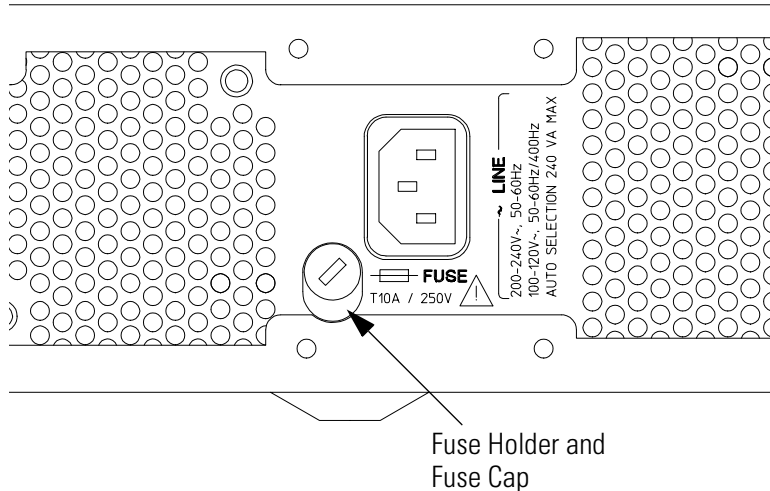

- 3 Replace the fuse with the equivalent part:

Line Voltage	Fuse Type	Agilent Part Number
100–240 V~	T 10A, 250 V	2110-0720

- 4 Refit the fuse cap.

Power Cable

In accordance with international safety standards, this instrument is equipped with a three-wire power cable. The figure below shows the part numbers of the power cables available. When connected to an appropriate AC power receptacle, this cable grounds the instrument cabinet.

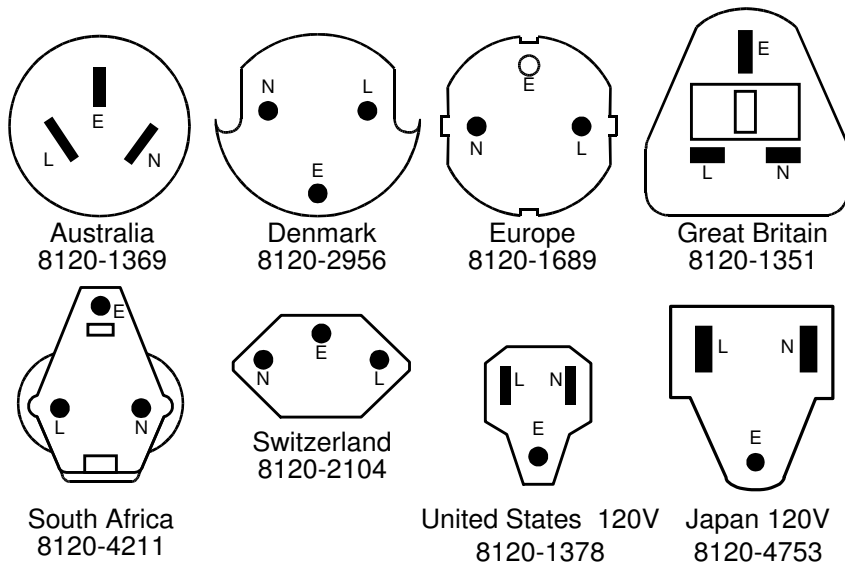

Ventilation Requirements

The instrument is fitted with three cooling fans. Make sure that there is adequate clearance of 80 mm at the rear and 25 mm at the top and bottom to ensure adequate air flow. If the air flow is restricted, the internal operating temperature will be higher, reducing the instrument's reliability or causing the instrument's thermal-protection circuits to automatically switch off the instrument.

NOTE

Do not cover the ventilation holes.

Thermal Protection

Overheating Detection

The instrument monitors its internal temperature. If the temperature exceeds approximately 80°C, the power supply is switched off. The instrument will switch on again if the temperature falls below approximately 77°C.

Fan Failure

If a fan is broken or prevented from operating by a blockage, the temperature will increase. When the temperature exceeds approximately 80°C the overheating detection switches off the instrument for safety reasons. For reliability it is recommended to send instruments with broken or defective fans immediately to Agilent Service for repair.

Battery



This instrument contains a lithium battery. Typical life time of the battery is about 5 years.

NOTE

Recycle or dispose used batteries according to local regulations. Or contact your Agilent representative for information on battery recycling.

The battery is replaceable. Replacement should only be carried out by *qualified service personnel*.

NOTE

There is a danger of explosion if the battery is incorrectly replaced.

The battery must be replaced with the same or equivalent battery type:

A **Lithium CR2477-N** type battery.

The Agilent replacement part number is: **1420-0557**.

The battery is protected against charging.

CAUTION

Do *not* crush, puncture, or incinerate the battery. Do *not* short the battery's external contacts.



Battery Replacement

NOTE

Disconnect the power cord from AC line voltage to avoid electrical shock.

- 1 Remove the bumper which is fitted to the front panel.**
- 2 Remove the strips on the left and right side of the front panel.**
- 3 Remove the front panel which is secured with two screws at each side.**
- 4 Disconnect the flat cable which connects the front panel to the chassis.**
- 5 On the right side of the chassis there is a cover secured with one screw. Remove this cover.**
- 6 Now the battery can be removed from the battery holder. It is recommended to push the battery on the top, and to pull the battery on the bottom with one finger for easier removal.**
- 7 Fit the new battery in the holder, take care to not short current the battery on the chassis.**
- 8 Fit the cover again and secure it with the screw to the chassis.**
- 9 Re-connect the flat cable of the front panel again to the chassis connector. Make sure that the pin one (red wire) is pointing to the mid of the chassis.**
- 10 Re-assemble the front cover.**
- 11 Fit the strips to the sides of the front panel, again.**
- 12 Fit the bumper to the front panel.**

Operating Environment

Storage Temperature	-40 °C to +70 °C
Operating Temperature	0 °C to 55 °C
Humidity	95% R.H. (at 40 °C)
Altitude	Up to 2000m
Installation	Category II
Pollution	Degree 2

WARNING

The instrument is not designed for outdoor use. Do not expose the instrument to rain or other excessive moisture. Protect the instrument from humidity and temperature changes which could cause condensation within the instrument.

Do not operate the instrument in the presence of flammable gases, fumes or powders. Operation of any electrical instrument in such an environment constitutes a definite safety hazard.

Cleaning Recommendation

WARNING

To prevent electrical shock, disconnect the instrument from mains before cleaning. Use a dry cloth or one slightly dampened with water to clean external case parts. Do not attempt to clean internally.

Acoustic Noise Emission

Acoustic Noise Emission

For ambient temperatures up to 30°C, under normal operation and at the typical operator position:

LpA = 52 dBA

Measured in accordance with ISO 7779 / EN 27779.

Geräuschemissionswerte

Bei einer Umgebungstemperatur bis 30°C

LpA = 52 dBA

am Arbeitsplatz, normaler Betrieb.

Angabe ist das Ergebnis einer Typprüfung nach ISO 7779 / EN 27779.

Index

A

- Accessories 102
- Acoustic Noise Emission 112
- Additional Documentation 103
- Address Parameter 83
- Amplitude Parameter 78
- Automated Testing 17
- Autoset 28, 97

B

- Battery
 - disposal 108
 - for memory back-up 108
 - replacement 109
 - type 108
- Benchtop Testing 17
- Benefits 16
- Block Editing Functions 85
- Building loops 79
- Burst Mode
 - continuous 64
 - gated 70
 - triggered 67
- Burst Signal
 - command list 40
 - example 37

C

- Capabilities
 - signal generation 16
- Certification
 - met specifications 5
- Cleaning Recommendation 111
- CLK/REF INPUT
 - connector 30
 - front panel 19
 - rear panel 30
 - termination voltage 87
- Clock Input Connector 88
- Clock Signal
 - command list 36
 - example 32
- Combining PRBS data types 84
- Command Language 17
- Command List
 - burst signal 40
 - clock signal 36
 - edge-displacement signal 50
 - serial data sequence 57
 - serial data stream 45

- Conditions, environmental 110
- CONFIG Softkey 92
- Configuration Screen 92
- Connectors
 - front panel 18
 - rear panel 30
- Continuous Mode
 - burst 64
 - pattern 65
 - pulses 63
- Current limits 86

D

- Data Type Parameter 84
- Deskew Parameter 94
- Digital Add Parameter 77
- Digits 26
- Directory 89
- Display 17
- divided clock pattern 85
- DNRZ 62
- Documentation, additional 103

E

- Edge-Displacement Signal
 - command list 50
 - example 46
- Editing
 - blocks 85
 - segments 83
- Emission
 - acoustic noise 112
- Environmental Conditions 110
- Error checking 96
- Errors 28, 96
- Examples
 - burst signal 37
 - clock signal 32
 - edge-displacement signal 46
 - serial data sequence 51
 - serial data stream 41
- Exceed
 - Specified Values 26
- EXT INPUT
 - front panel 19
 - rear panel 30
 - termination voltage/triggering threshold 87
- EXT INPUT connector 30
- External Input Connector 88

Index

External PLL Reference 92

F

Fan Failure 107
Features 16
Filename Parameter 90
Front Panel 18

G

Gating
 gated burst mode 70
 gated pattern mode 71
 gated pulses mode 69
 manual 27
GP-IB
 address 92
 automated testing 17
 connector 30
GP-IB Address 92
Graphical Display 22
Grouping Parameters 93

H

Handle accessory 102
Help Information 28
HELP key 28
High Level Parameter 78

I

IC Technologies 16
Initial Inspection 100

K

Knob 18

L

Language Options 103
Leading Edge Parameter 75
Length Parameter 81
Level Parameters 76
Levels Screen 76
LEVELS Softkey 76
Limits
 overprogramming 26
 screen 86
Limits Screen 86
LIMITS Softkey 86
Line Fuse 104
LOCAL key 28
Logic Technologies 16

Loop Indicator 81
Low Level Parameter 78

M

MAN Key 27, 61
MEMCARD Softkey 89
Memory Card Screen 89
MODE/TRG Softkey 60
Mode/Trigger Screen 60
Modify
 resolution 26
Modify Knob 18
MORE key 18

O

Offset Parameter 78
On-line Help 28
Operating Environment 108, 110
Options 102
OUTPUT 19
 rear panel 30
Output
 On/Off Parameter 74
 Screen 95
 Switching on/off 27
OUTPUT1/2 Softkey 95
Overheating Detection 107
Overprogramming 26

P

Parameter
 step size 26
Parameter Grouping 93
Parameters
 levels 76
 timing 72
Path 89
Pattern Formats 62
Pattern Mode
 continuous 65
 gated 71
 started 68
Pattern Screen 79
PATTERN Softkey 79
Perform Operation Selftest 93
PLL
 reference source 94
PLL Reference 92, 94
Power Cable 106

Index

- Power Consumption 104
- Power Cord 101, 106
- Power Requirements 104
- Power Source 104
- PRBS 62, 84
- Product Features 16
- Pseudo Random Binary Sequence 62
- Pulse Capabilities 16
- Pulse Delay Parameter 74
- Pulse Period
 - parameter 74
 - source 94
- Pulse Width Parameter 75
- Pulses Mode
 - continuous 63
 - gated 69
 - started 66
- R**
- Rack Mounting 103
- Rear Panel 30
- Recalling Settings
 - internal memory 27
 - memory card 89
- Remote
 - control 17
 - programming 17
 - unlock 28
- Resolution 26
- Resume Indicator 80
- Rotary Knob 18
- Run/Stop Indicator 61
- S**
- Safety
 - symbols 8
- SCPI 17
- Screens
 - Configuration 92
 - Levels 76
 - Limits 86
 - Memory Card 89
 - Mode/Trigger 60
 - Output 95
 - Pattern 79
 - Timing 72
 - Trigger-Level 87
- Second Channel 17
- Segment Editor 83
- Segment Length Resolution 81
- Segment/Length/Loop Control Table 81
- Selftest 92, 93
- Separate Outputs Parameter 77
- Serial Data Sequence
 - command list 57
 - example 51
- Serial Data Stream
 - command list 45
 - example 41
- Service Documentation 103
- Setting Up Data Segments 83
- Shift Key 26, 28
- Signal Generation Capabilities 16
- Special Function Keys 27
- Standard Deliverables 101
- Standby Switch 104
- Storing Settings
 - internal memory 27
 - memory card 89
- Switch, standby 104
- T**
- Thermal Protection 107
- Timing Parameters 72
- Timing Screen 72
- TIMING Softkey 72
- Trailing Edge Parameter 75
- TRG-LEV Softkey 87
- TRIGGER OUT
 - connector 19, 88
 - rear panel 30
 - termination/levels 87
- Triggering
 - manual 27
 - started pattern mode 68
 - started pulses mode 66
 - triggered burst mode 67
- Trigger-Level Screen 87
- U**
- Unlock Front Panel 28
- Update Parameter 80
- Upgrade 17
- Use Models 16
- V**
- Ventilation Requirements 107
- Voltage limits 86
- Voltage/Current Mode Parameter 78

Index

W
Warnings 28, 96

Front Panel Controls

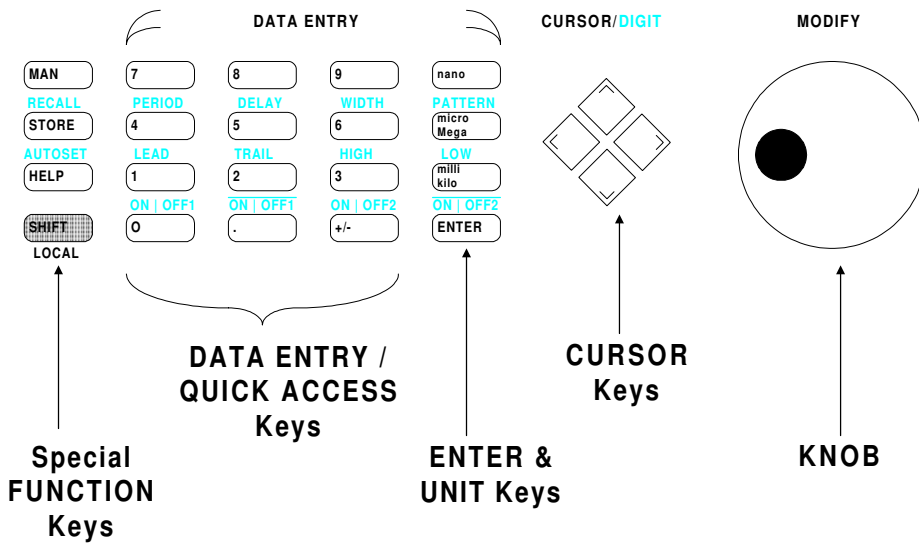

Copyright Agilent Technologies 1998, 2000
Edition E0300
Printed in Germany

81130-91020