Agilent 81110A/'12A Performance Test

Introduction

Use the tests in this chapter if you want to check that the Agilent 81110A Pulse Generator Frame with the Agilent 81112A 330 MHz Output Channel(s) is working correctly. Before starting any testing allow all test equipment to warm up for at least 30 minutes.

Conventions Used

When referring to actions that you perform during the tests, the following conventions are used:

FUNCTION This indicates that a labelled button must be pressed

[[MODE/TRG] This shows that a soft-key must be pressed. A soft-key is an unlabelled button whose label is shown on the display, and which can vary according to the job that the button is doing

CONTINUOUS PULSES This is an option shown on the display, and is selected by use of the vernier keys. It is shown in upper or lower case to match the case displayed.

Test Results Tables

Tables for entering the results of the tests are included at the end of this chapter. The tests are numbered and reference numbers for each Test Result (TR) are given in a small table at the end of each test. The reference number shows you where the actual results should be entered in the Test Results Tables.

The Test Results tables at the end of the chapter should be photocopied, and the Test Results entered on the copies. Then, if the tests need to be repeated, the tables can be copied again.

If Channel 2 has been fitted to your instrument, make an extra copy of the Test Results tables for entry of the results of tests on that channel. In this case, however, it is not necessary to repeat the Period tests, as these are common to both channels.

Recommended Test Equipment and Accessories

The following tables list the recommended test equipment you need to perform all the tests in this chapter. You can use alternative instruments if they meet the critical specifications given. The test set-ups and procedures assume you are using the recommended equipment.

Test Equipment	Model	Critical Specifications
Oscilloscope or	Agilent 54121T	20 GHz, 10 bit vertical resolution, Histogram
Oscilloscope	Agilent 54750A + Agilent 54751A	20 GHz, 15 bit vertical resolution, Histogram
Counter or	Agilent 5334B #010, 030	Period and Time Interval measurements Oven Osci, 1.3 GHz C-Channel
Counter	Agilent 53132A #001/010, 030	Frequency measurements > 150 MHz High-Stability Timebase, 3 GHz Channel
Digital Voltmeter	Agilent 3458A	DCV up to 20 V
Pulse Generator	Agilent 8110A	up to 150 MHz
Delay line	Agilent 54008A	22 ns

Accessories	Model	Critical Specifications
Digitizing Oscilloscopes Accessories		
Attenuators	33340C#020 33340C#006	20 dB 6 dB
Power Splitter	11667B	
SMA/SMA (m-m) adaptor	1250-1159	
SMA/BNC Adaptor	1250-1700	
SMA Cable	8120-4948	

Accessories	Model	Critical Specifications
50 Ω Feedthrough Termination	10100C See Figure	2 W,1% 10 W,0.1%
Adapter	1251-2277	BNC to Banana
Cable Assemblies, BNC	8120-1839	
Torque Wrench	8710-1582	5/16 in, 5 lb-in (56 Ncm)

NOTE:

When you connect the test equipment for the first time, and whenever you change the setup during the course of these tests, use the 8710 - 1582 torque wrench to tighten and loosen SMA connectors. This will ensure that the connectors are at the correct tightness and give the best signal transfer.

50 Ohm, 0.1%, 10 W Feedthrough Termination

The following figure provides a schematic and a parts list except for the case. The case must provide shielding and maintain grounding integrity.

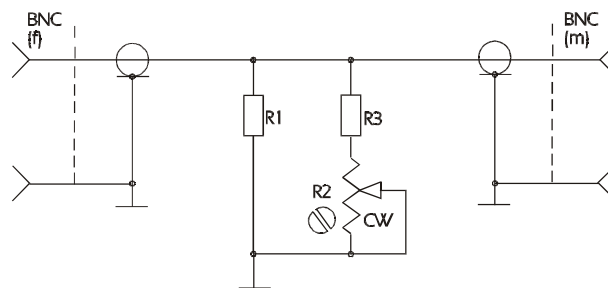

50 Ohm, 0.1%, 10 W Feedthrough Termination

The following parts are required:

1. R1 = 53.6 Ω , 1%, 10 W; Part Number: 0699-0146.
2. R2 = 200 Ω , 10%, 0.5 W, Variable trimmer; Part Number: 2100-3350.
3. R3 = 681 Ω ;, 1%, 0.5 W; Part Number: 0757-0816.
4. BNC (M): Part Number: 1250-0045.
5. BNC (F): Part Number: 1250-0083.

Getting Started

The Agilent 81110A is controlled by selecting options in a series of **pages** that are displayed on the instrument's screen. These options vary with the boards that are fitted in the instrument. When the Agilent 81110A is being tested, therefore, different situations can arise, depending on whether you have a standard instrument or one that has had additional boards fitted. The following examples illustrate this

Typical Examples of Displayed Screens

Per 1.000µs Normal			<input type="checkbox"/> OFF	1	<input checked="" type="radio"/> MODIFY
			<input type="checkbox"/> OFF		
Delay	Ops	Offset	+0.0mV	*OFF	norm
Width	100.0ns	Amplit	1.00V	ON	out
LeadE	0.80ns				
TraiE	=LeadE				
MODE/TRG		OUTPUT		LIMITS	
PATTERN					

The OUTPUT Screen in a Standard Agilent 81110A

1	OFF	Per 1.000µs	OFF	2	<input checked="" type="radio"/> MODIFY
	OFF				
Delay		Ops	Delay		*Period
Width	100.0ns		Width	100.0ns	Frequency
LeadE	0.80ns		LeadE	0.80ns	
TraIE	=LeadE		TraIE	=LeadE	
MODE/TRG		TIMING		LEVELS	
PATTERN					

The TIMING Screen in an Agilent 81110A with qty 2 of Agilent 81112A

1	ON	Normal	Normal	ON	2	<input checked="" type="radio"/> MODIFY
	OFF			OFF		
High	+2.50V	Offset	+0.0mV	Set TTL		
Low	+0.0mV	Amplit	1.00V	*High-Low		
				Offs-Ampl		
				Set ECL		
MODE/TRG		TIMING		LEVELS		PATTERN

The LEVELS Screen in an Agilent 81110A with qty 2 of Agilent 81112A

Instrument Serial Numbers

You will need to write the serial numbers of the instrument at the top of the Test Reports. These can be found as follows:

Press HELP, [SERIAL #]

The Agilent 81110A display lists the instrument's products and serial number.

The display on your instrument should look similar to this:

FRAME : **81110A** **330 MHz**
Serial No : **DE38700136**

OUTPUTS

Ch1-Bd. : **81112A**
Ch2-Bd. : **81112A**

The serial number given for the **FRAME** applies to the Mainframe, the Power Supply, the Microprocessor Board, and the Timing Board. The number(s) available of the Output Channel(s) applies to the installed numbers of outputs and Model Number.

Initial Setup of the Agilent 81110A

In the majority of these tests the initial setting up of the instrument is identical. Therefore, it is described once here, and then referred-to where appropriate. In cases where the initial setup differs, an illustration of the settings is shown.

Set up the Agilent 81110A as follows:

1. Select [MODE/TRG]
 - CONTINUOUS PULSES
 - Single-Pulses at Out 1 (plus Single-Pulses at Out 2, if second channel is installed)
 - Pulse-Period:internal Osc
2. If a second output channel is installed, select MORE [CONFIG] screen and set up as follows:

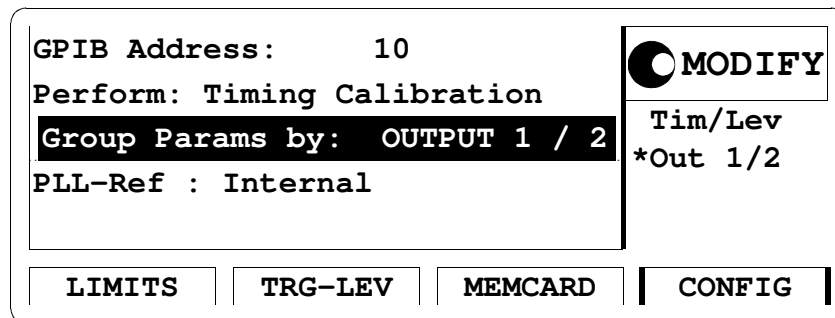

CONFIG Screen, Parameters grouped by OUTPUT

NOTE:

Set-ups are given in all the tests for [OUTPUT 1] and [OUTPUT 2]. If you are testing a single channel instrument set up the [OUTPUT] screen with the settings given for [OUTPUT 1].

Test 1: Period (PLL not active)

Test Specifications

Range	3.03 ns to 999.5 s
Resolution	3.5 digits, best case 5 ps
Accuracy	$\pm 3\%$ typical $\pm 0.5\%$ after selfcal

Equipment Needed

Counter
Cable, 50 Ω , coaxial, BNC

Procedure

1. Connect the Agilent 81110A to the Counter as shown:

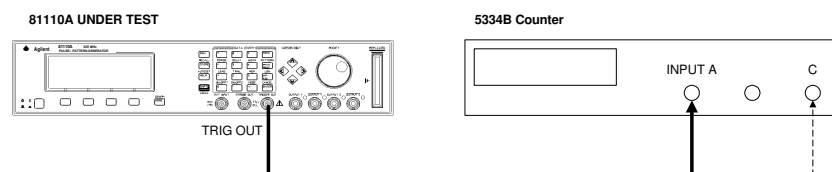

Connecting the Agilent 81110A to the Counter

2. Set up the Agilent 81110A as described in "Initial Setup of the Agilent 81110A"

On the Agilent 81110A press MORE and set up [OUTPUT 1] and [OUTPUT 2] pages as shown in the following illustrations:

Per	3.030ns	Normal	ON	1	<input checked="" type="radio"/> MODIFY
			OFF		
Delay	0ps	Offset	+0.0mV	3.030	ns
DtyCyc	50.00%	Amplit	1.00V		
LeadE	0.80ns				
TraIE	=LeadE				
MODE/TRG		OUTPUT 1	OUTPUT 2	PATTERN	

Configuring Output 1

Per	3.030ns	Normal	OFF	2	<input checked="" type="radio"/> MODIFY
			OFF		
Delay	0ps	Offset	+0.0mV	3.030	ns
DtyCyc	50.00%	Amplit	1.00V		
LeadE	0.80ns				
TraIE	=LeadE				
MODE/TRG		OUTPUT 1	OUTPUT 2	PATTERN	

Configuring Output 2

NOTE:

When you are testing instruments with 2 output channels it is necessary to:

- a. Configure *both* channels.
- b. For Period Test you can switch OFF the channels that are not being tested.

3. Set the Counter to:

FUNCTION	Period A / Freq C
INPUT A	50 Ω
SENSE	On

4. Check the Agilent 81110A period at the following settings:

Period	Acceptable Range	TR entry
3.030 ns	<i>without selfcal!</i> 2.9391 ns to 3.1209 ns	1 - 1
6.060 n	5.878 ns to 6.242 n	1 - 2
10.00 ns	9.7 ns to 10.3 ns	1 - 3
50.00 ns	48.5 ns to 51.5 ns	1 - 4
99.90 ns	96.903 ns to 102.897 ns	1 - 5
100 ns	97 ns to 103 ns	1 - 6
500 ns	485 ns to 515 ns	1 - 7
1 μ s	970 ns to 1030 ns	1 - 8
500 μ s	485 μ s to 515 μ s	1 - 9
500 ms	485 ms to 515 ms	1 - 10

Test 2: PLL Period

NOTE: This test is only performed if PLL is switched on.

Test Specifications

Range 3.03 ns to 999.5 s
Resolution 4 digits, best case 1 ps
Accuracy $\pm 0.01\%$

Equipment Needed

Counter Agilent 53132A
Cable, 50 Ω , coaxial, BNC

NOTE: The Agilent 53132A counter is used in frequency mode to meet the MIL CAL A uncertainty requirements for TAR (Test Accuracy Ratio) > 4:1.

Procedure

Connect the Agilent 81110A to the counter as follows:

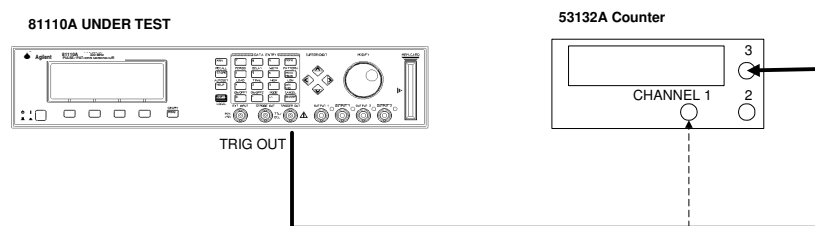

Connecting Agilent 81110A to the Counter

5. Set up the Agilent 81110A as described in "Initial Setup of the Agilent 81110A"
6. Select the [MODE/TRG] screen on the Agilent 81110A and set up as follows:

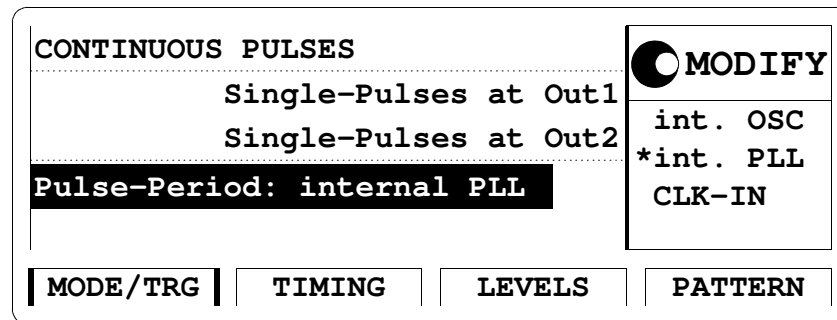

The MODE/TRG Screen Setup

7. On the Agilent 81110A set up [OUTPUT 1] and [OUTPUT 2] pages as shown in the test before!

NOTE:

When you are testing instruments with 2 output channels it is necessary to:

- a. Configure *both* channels.
- b. For Period Test you can switch OFF the channels that are not being tested.

8. Set the Counter to measure the frequency at the chosen input
1 / 3

9. Check the Agilent 81110A PLL pulse period at the following settings:

Period	Frequency	Acceptable Range	TR Entry
3.030 ns	330.000MHz	329.9670 MHz to 330.0330 MHz	2 - 1
10.00 ns	100 MHz	99.990 MHz to 100.010 MHz	2 - 2
50.00 ns	20 MHz	19.9980 MHz to 20.0020 MHz	2 - 3
100 ns	10 MHz	9.9990 MHz to 10.0010 MHz	2 - 4
500 ns	2 MHz	1.9998 MHz to 2.0002 MHz	2 - 5
1 µs	1 MHz	999.9 kHz to 1.0001 MHz	2 - 6
50 µs	20 kHz	9.998 kHz to 20.002 kHz	2 - 7
5 ms	200 Hz	199.980 Hz to 200.020 Hz	2 - 8
500 ms	2 Hz	1.9998 Hz to 2.0002 Hz	2 - 9
5 s	0.2 Hz	0.19998 Hz to 0.20002 Hz	2 - 10

Test 3: Width

Test Specifications

Range	1.515 ns to (period - 1.515 ns)
Resolution	3.5 digits, best case 5 ps
Accuracy	$\pm 3\% \pm 250$ ps
	typical $\pm 0.5\% \pm 250$ ps after selfcal

Equipment Needed

Digitizing Oscilloscope with Accessories
Counter
Cable, 50 Ω , coaxial, BNC

Procedure

1. Connect Agilent 81110A to the Scope as shown:

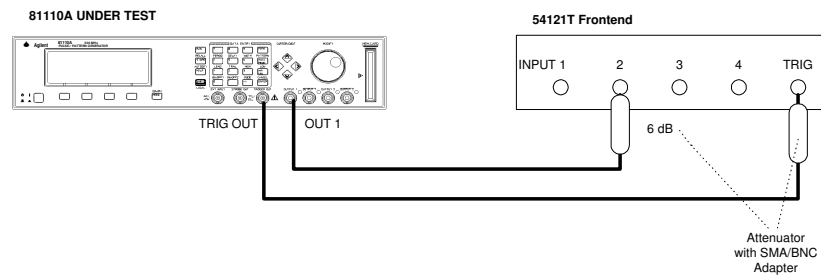

Connecting Agilent 81110A to the Scope

2. Set up the Agilent 81110A as described in "Initial Setup of the Agilent 81110A"

- On the Agilent 81110A press MORE and set up [OUTPUT 1] and [OUTPUT 2] pages as shown in the following illustrations:

Per	200 ns	Normal	ON	1	<input checked="" type="radio"/> MODIFY 100.0 ns
			OFF		
Delay	0ps	Offset	+0.0mV		
Width	100.0ns	Amplit	1.00V		
LeadE	0.80ns				
Traie	=LeadE				
MODE/TRG		OUTPUT 1	OUTPUT 2	PATTERN	

Configuring Output Screen 1

Per	200 ns	Normal	OFF	2	<input checked="" type="radio"/> MODIFY 1.515 ns
			OFF		
Delay	0ps	Offset	+0.0mV		
Width	1.515ns	Amplit	1.00V		
LeadE	0.80ns				
Traie	=LeadE				
MODE/TRG		OUTPUT 1	OUTPUT 2	PATTERN	

Configuring Output Screen 2

NOTE:

When you are testing instruments with 2 output channels it is necessary to:

- a. Configure *both* channels.
- b. Switch OFF the channel that is not being tested

If you then test the other channel:

- c. Switch ON the channel you are testing, and switch OFF the other channel.
-

4. Set the Digitizing Oscilloscope Agilent 54121T:
 - Press AUTOSCALE
 - Select the Display menu and set the Number of Averages to 32
 - Select the delta V menu and turn the voltage markers On
 - Set the preset levels to 50% -50% and press AUTO LEVEL SET
 - Select the delta t menu and turn the time markers ON
 - Set START ON EDGE = POS 1 and STOP ON EDGE = NEG1
5. Change the oscilloscope timebase to 1 ns/div
6. Change the Agilent 81110A Ch-1 Width to 1.515 ns
7. Center the pulse in the Scope display
8. Press the PRECISE EDGE FIND key for each new Width setting
9. Check the Agilent 81110A pulse width at the following settings:

Oscilloscope Timebase	Period	Width	Acceptable Range	TR Entry
1 ns/div	200 ns	<i>without selfcal!</i> 1.515 ns	1.22455 ns to 1.80545 ns	3 - 1
1 ns/div	200 ns	6.060 ns	5.528 ns to 6.492 ns	3 - 2
2 ns/div	200 ns	10.00 ns	9.450 ns to 10.55 ns	3 - 3
10 ns/div	200 ns	50.00 ns	48.25 ns to 51.75 ns	3 - 4
20 ns/ 100 ns	1 μ s	100.0 ns	96.75 ns to 103.25 ns	3 - 5
	1 μ s	500.0 ns	484.75 ns to 515.25 ns	3 - 6

10. Connect the Agilent 81110A to the Counter as shown:

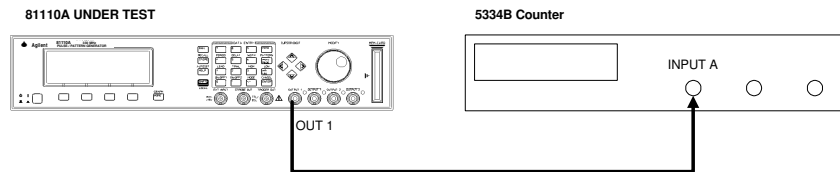

Connecting Agilent 81110A to the Counter

11. Set the Counter to:

FUNCTION	TI A \rightarrow B
SENSE	On
INPUT A	50 Ω
COM A	On
INPUT B	50 Ω , negative slope

12. Check the Agilent 81110A width at the following settings:

Period	Width	Acceptable Range	TR Entry
100 μ s	50 μ s	48.5 μ s to 51.5 μ s	3 - 7
10 ms	5 ms	4.85 ms to 515 ms	3 - 8
999 ms	500ms	485 ms to 515 ms	3 - 9

NOTE:

Repeat the entire test for the second channel, if it is installed

Test 4: Delay

Test Specifications

Range	Fixed typical Delay of EXT INPUT to TRIGGER OUT 12 ns TRIGGER OUT to OUTPUT 1/2 10 ns Variable Delay: 0 ns to (period - 3.03 ns)
Resolution	3.5 digits, best case 5 ps
Accuracy	$\pm 3\%$ ± 0.5 ns typical $\pm 0.5\%$ ± 0.5 ns after selfcal

Equipment Needed

Digitizing Oscilloscope with Accessories
Pulse Generator
Counter
Cable, 50 Ω , coaxial, BNC

Procedure

Connect Agilent 81110A to the Scope as shown:

Agilent 81110A/'12A Performance Test

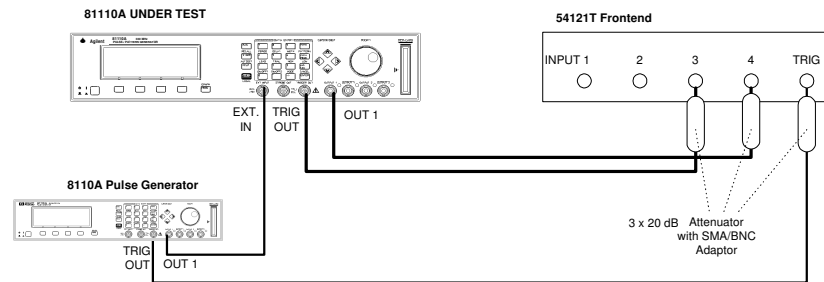

Connecting Agilent 81110A to the Scope

13. Set up the Agilent 81110A as described in "Initial Setup of the Agilent 81110A"

14. Set the Pulse Generator to:

Period	1 μ s
Width	100 ns
Amplitude	1 V
Offset	+1.0 V
Output	Enable

15. Select the [MODE/TRG] screen on the Agilent 81110A and set up as follows:

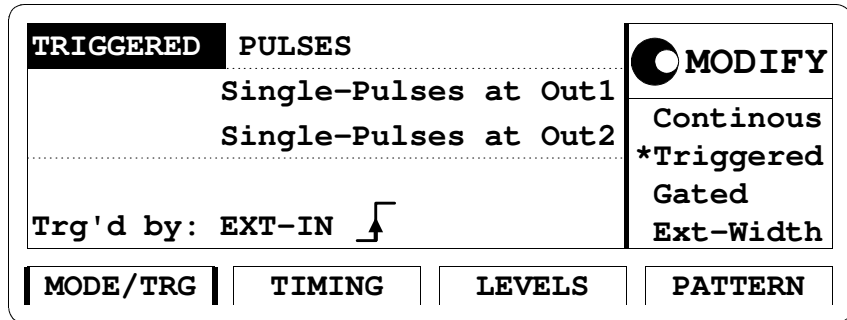

The TRG MODE Screen Setup

16. On the Agilent 81110A press MORE and set up [TRIG-LEV] page as shown:

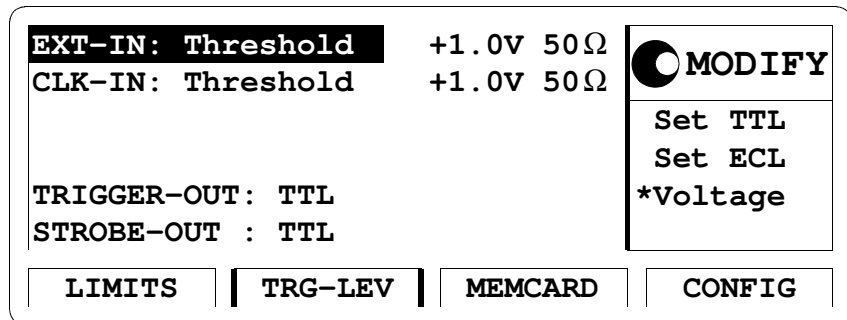

The TRG-LEV Screen Setup

17. On the Agilent 81110A set up [OUTPUT 1] and [OUTPUT 2] pages as shown in the following illustrations:

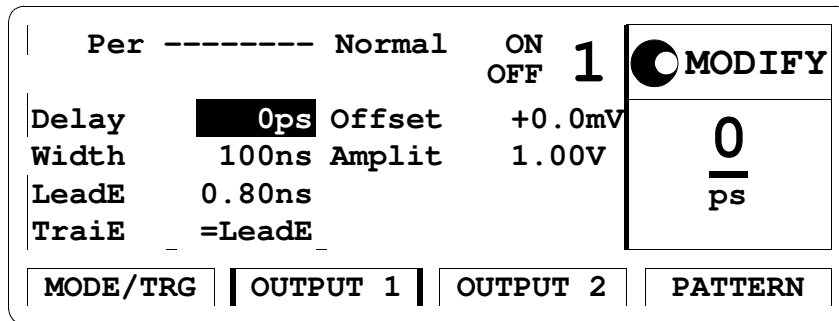

Configuring Output Screen 1

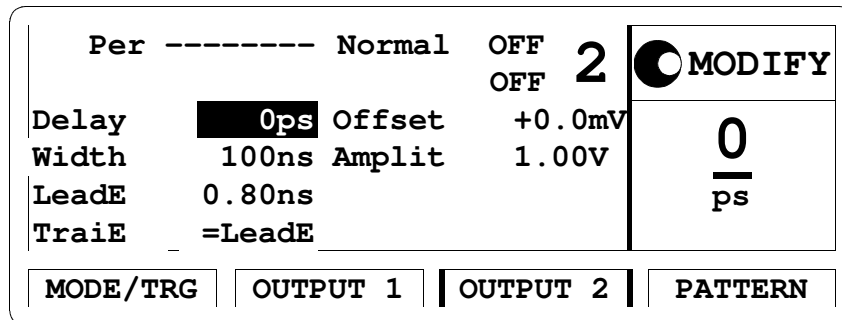

Configuring Output Screen 2

NOTE:

When you are testing instruments with 2 output channels it is necessary to:

- a. Configure *both* channels.
- b. Switch OFF the channel that is not being tested

If you then test the other channel:

- c. Switch ON the channel you are testing, and switch OFF the other channel.
-

18. Set the Digitizing Oscilloscope Agilent 54121T:

- Press AUTOSCALE
- Set timebase to TIME/DIV = 10 ns/div
- Center the positive-going edges of the two signals
- Select the Display menu and set the screen function to single; set the number of averages to 32
- Select the Delta V menu and turn the voltage markers ON and assign marker 1 to channel 3 and marker 2 to channel 4
- Set Preset levels to 50% - 50% and press AUTO LEVEL SET
- Select the Delta t menu and turn the time markers ON
- Set START ON EDGE= POS1 and STOP ON EDGE= POS 1
- Press the PRECISE EDGE FIND key

19. Check the Agilent 81110A delay at the following settings:

Agilent 81110A/'12A Performance Test

NOTE: Record the value of the fixed delay and subtract it from the other readings.

Oscilloscope Timebase	Delay	Acceptable Range	TR Entry
10 ns/div	0 ps	fixed Delay of TRIG OUT to OUT 1/2: 10 ns typ.	4 - 1
10 ns/div	5.000 ns	4.35 ns to 5.65 ns	4 - 2
20 ns/div	10.00 ns	9.200 ns to 10.80 ns	4 - 3
20 ns/div	50.00 ns	48.00 ns to 52.00 ns	4 - 4
50 ns/div	100.0 ns	96.50 ns to 103.50 ns	4 - 5
200 ns/div	500.0 ns	484.50 ns to 515.50 ns	4 - 6

20. Connect the Agilent 81110A to the Counter as follows:

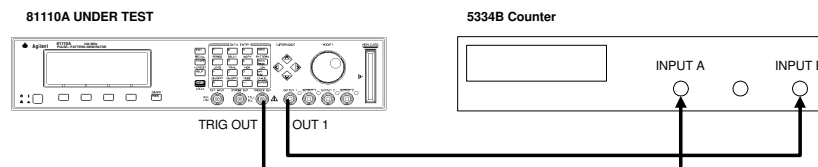

Connecting Agilent 81110A to the Counter

21. Set Agilent 81110A to **Continuous-Pulses** on the MODE/TRG screen

22. Set the Counter to:

FUNCTION TI A → B
 SENSE On
 INPUT A 50 Ω
 INPUT B 50 Ω

23. Check the Agilent 81110A delay at the following settings:

NOTE:

Subtract the fixed delay from the other readings

Period	Delay	Acceptable Range	TR Entry
100 μs	50 μs	48.5 μs to 51.5 μs	4 - 7
10 ms	5 ms	4.85 ms to 5.15ms	4 - 8
999 ms	500ms	485 ms to 515 ms	4 - 9

NOTE:

Repeat the entire test for the second channel, if it is installed.

Test 5: Double Pulse Delay

Test Specifications

Range	3.030 ns to (period - width - 1.5 ns)
Resolution	3.5 digits, best case 5 ps
Accuracy	$\pm 3\% \pm 150$ ps typical $\pm 0.5\% \pm 150$ ps after selfcal

Equipment Needed

Digitizing Oscilloscope with Accessories
Counter
Cable, 50 Ω , coaxial, BNC

Procedure

1. Connect Agilent 81110A to the Scope as shown:

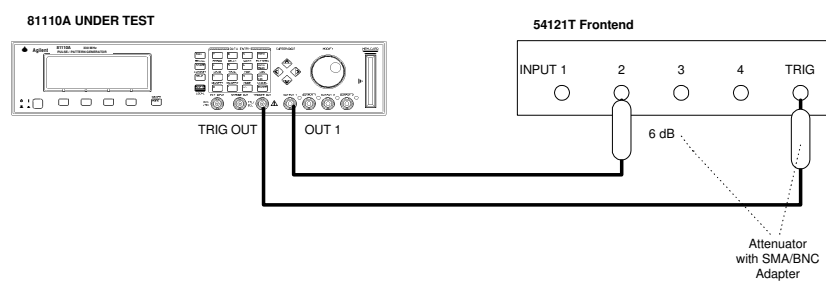

Connecting Agilent 81110A to the Scope

2. Set up the Agilent 81110A as described in "Initial Setup of the Agilent 81110A"
3. Select the [MODE/TRG] screen on the Agilent 81110A and set up Output 1 and Output 2 as follows:

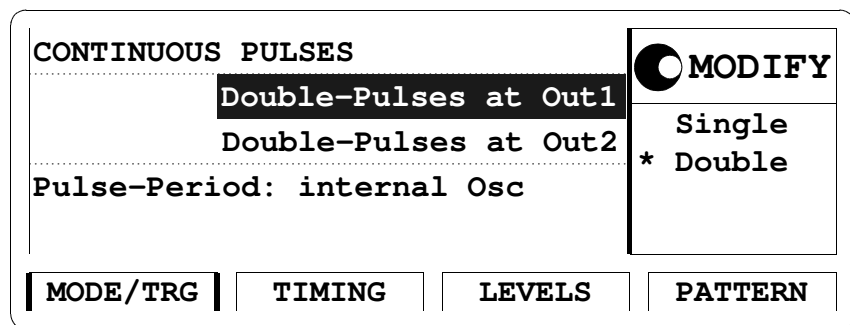

The MODE/TRG Screen Setup

4. On the Agilent 81110A set up [OUTPUT 1] and [OUTPUT 2] pages as shown in the following illustrations:

Per	200.0ns	Normal	ON	1	<input checked="" type="radio"/> MODIFY
			OFF		
Db1Del	3.030ns	Offset	+0.0mV		3.030
Width	1.515ns	Amplit	1.00V		ns
LeadE	0.80ns				
TraIE	=LeadE				
MODE/TRG		OUTPUT 1		OUTPUT 2	
				PATTERN	

Configuring Output Screen 1

Per	200.0ns	Normal	OFF	2	<input checked="" type="radio"/> MODIFY
			OFF		
Db1Del	3.030ns	Offset	+0.0mV		3.030
Width	1.515ns	Amplit	1.00V		ns
LeadE	0.80ns				
TraIE	=LeadE				
MODE/TRG		OUTPUT 1		OUTPUT 2	
				PATTERN	

Configuring Output Screen 2

NOTE:

When you are testing instruments with 2 output channels it is necessary to:

- a. Configure *both* channels.
- b. Switch OFF the channel that is not being tested

If you then test the other channel:

- c. Switch ON the channel you are testing, and switch OFF the other channel.
-

5. Set the Digitizing Oscilloscope Agilent 54121T:
 - Press AUTOSCALE
 - Center the double pulse signal
 - Select the Display menu and set the Number of Averages to 32
 - Select the Delta V menu and turn the Voltage markers On
 - Set Preset Levels = 50% -50% and press AUTO LEVEL SET
 - Select the Delta t menu and turn the Time markers On
 - Set START ON EDGE = POS1 and STOP ON EDGE = POS2
6. Press the PRECISE EDGE FIND key for each new Double Delay setting
7. Check the Agilent 81110A double delay at the following settings:

Agilent 81110A/'12A Performance Test

Oscilloscope Timebase	Double Delay	Acceptable Range	TR Entry
2 ns/div	<i>without selfcal!</i> 3.030 ns	2.7891 ns to 3.2709 ns	5 - 1
2 ns/div	10.00 ns	9.550 ns to 10.45 ns	5 - 2
10 ns/div	50.00 ns	48.35 ns to 51.65 ns	5 - 3
20 ns/div	100.0 ns	96.85 ns to 103.15 ns	5 - 4

8. Connect the Agilent 81110A to the Counter as shown:

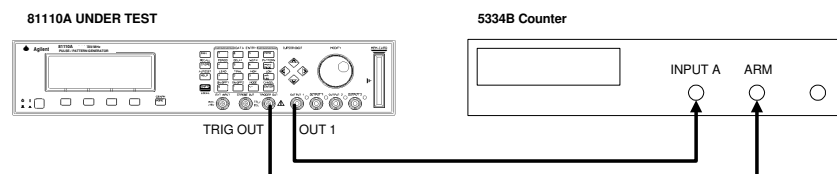

Connecting Agilent 81110A to the Counter

9. Set the Counter to:

- FUNCTION Period A
- INPUT A 50 Ω
- SENSE On
- (EXT ARM
- SELECT a. Start (ST): leading edge
- b. Stop (SP): trailing edge)

10. Set up the Agilent 81110A as described in "Initial Setup of the Agilent 81110A"

11. Select the [MODE/TRG] screen on the Agilent 81110A and set up as follows;

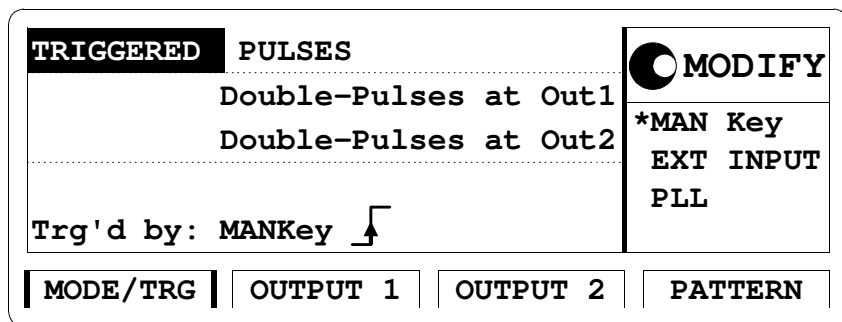

The MODE/TRG Screen Setup

12. On the Agilent 81110A set up [OUTPUT 1] and [OUTPUT 2] pages as shown in the following illustrations:

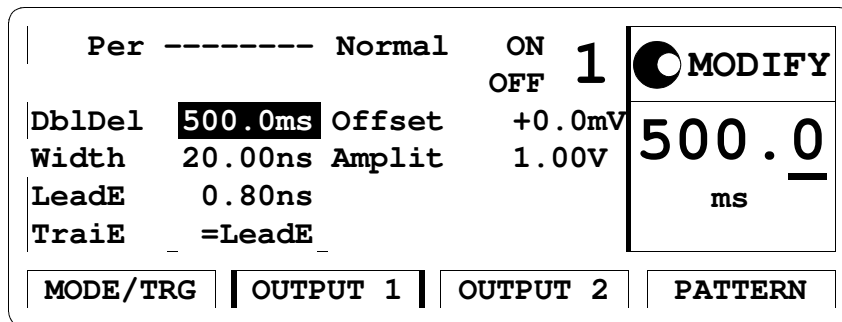

Configuring Output Screen 1

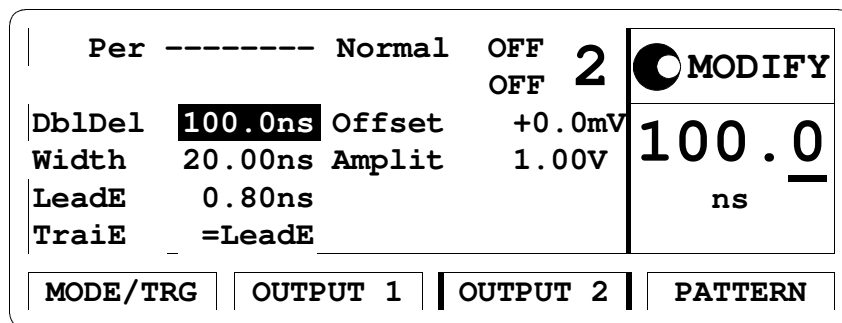

Configuring Output Screen 2

NOTE:

When you are testing instruments with 2 output channels it is necessary to:

- a. Configure *both* channels.
- b. Switch OFF the channel that is not being tested

If you then test the other channel:

- c. Switch ON the channel you are testing, and switch OFF the other channel.

13. Check the Agilent 81110A double pulse delay at the following settings:

Press MAN to check each new setting!

Agilent 81110A/'12A Performance Test

Double Delay	Acceptable Range	TR Entry
<i>after selfcal!</i> 500 ms	485 ms to 515 ms	5 -5
1 s	970.00 ms to 1030.00 ms	5 - 6

NOTE:

Repeat the entire test for the second channel, if it is installed.

Test 6: Jitter

The following tests are required:

1. Period Jitter
 - a. Internal Oscillator
 - b. Internal PLL
2. Width Jitter
3. Delay Jitter

Test 6.1a: Period Jitter, Internal Oscillator

Test Specifications

RMS-Jitter 0.01% + 15 ps

Equipment Needed

Digitizing Oscilloscope with Accessories
Delay Line (22 ns)
Power Splitter
Cable, 50 Ω , coaxial, BNC
Cable, SMA

Procedure

1. Connect Agilent 81110A to the Scope as shown:

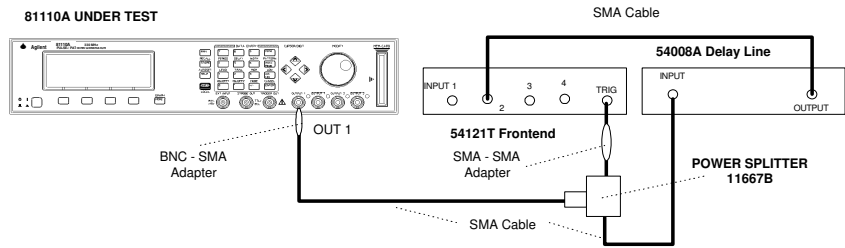

Equipment Set-up for Jitter Test

2. Set up the Agilent 81110A as described in "Initial Setup of the Agilent 81110A"
3. On the Agilent 81110A set up [OUTPUT 1] and [OUTPUT 2] pages as shown in the following illustrations:

Per 50.00ns	Normal	ON	1	<input checked="" type="radio"/> MODIFY
		OFF		
Delay	Ops Offset	+500mV	50.00 ns	
Width	25.00ns Amplit	1.00V		
LeadE	0.80ns			
Traie	=LeadE			
MODE/TRG		OUTPUT 1		OUTPUT 2
PATTERN				

Configuring Output Screen 1

Per	50.00ns	Normal	OFF	2	MODIFY
Delay	0ps	Offset	+500mV	OFF	50.00 ns
Width	25.00ns	Amplit	1.00V		
LeadE	0.80ns				
TraIE	=LeadE				
MODE/TRG		OUTPUT 1		OUTPUT 2	
		PATTERN			

Configuring Output Screen 2

NOTE:

When you are testing instruments with 2 output channels it is necessary to:

- a. Configure *both* channels.
- b. Switch OFF the channel that is not being tested

If you then test the other channel:

- c. Switch ON the channel you are testing, and switch OFF the other channel.

4. Set the Digitizing Oscilloscope Agilent 54121T:
 - Press AUTOSCALE
 - Select the Display menu and set the Number of Averages to 64
 - Select the Channel menu and set the Attenuation factor of channel 2 to 2

- Set the VOLTS/DIV of channel 2 to 10 mV/div
 - Set OFFSET to 500 mV
 - Select the Timebase menu and set the TIME/DIV to 100 ps/div
 - Center the first positive-going edge of the signal (approximate Delay = 29 ns)
 - Select the Delta V menu and turn the V markers On
 - Set the Marker 1 Position to 490 mV and the Marker 2 Position to 500 mV
 - Select the Delta t menu and turn the T Markers On
 - Set START ON EDGE = POS1 and STOP ON EDGE = POS1
 - Press the PRECISE EDGE FIND key
5. RECORD the delta t reading. This is the rise time of the reference signal within a 1% amplitude window of the signal connected to Input 2. This value is needed later to calculate the correct jitter.(delta.t.up)
6. Select the Timebase menu and center the second positive-going edge of the signal (approximate Delay = 79 ns)
7. Press MORE and HISTOGRAM
- Select the Window submenu and set:
 - Source is channel 2
 - Choose the Time Histogram
 - Press WINDOW MARKER 1 and set it to 490 mV
 - Press WINDOW MARKER 2 and set it to 500 mV

8. Select the Acquire submenu, set the Number of Samples to 1000 and press START ACQUIRING
9. After the data for the time histogram has been acquired (# Samples = 100%), select the Result submenu.
10. Press MEAN and SIGMA. RECORD the values of sigma
11. The RMS-jitter is calculated as follows:

$$RMS - jitter = \frac{6sigma - delta.t.up}{6}$$

12. The RMS-jitter for period of 50 ns is 20 ps. Enter the result in the Test Report as TR entry 6.1a - 1
13. Set the Agilent 81110A period to 500 ns
14. Repeat steps 6 to 11

NOTE:

TIME/DIV = 200 ps/div; approximate Delay = 529 ns

15. The RMS-jitter for period of 500 ns is 65 ps. Enter the result in the Test Report as TR entry 6.1a - 2

Test 6.1b: Period Jitter, Internal PLL

Test Specifications

RMS-Jitter 0.001% + 15 ps

Equipment Needed

Digitizing Oscilloscope with Accessories
Delay Line (22 ns)
Power Splitter
Cable, 50 Ω , coaxial, BNC
Cable, SMA

Procedure

1. Connect Agilent 81110A to the Scope as shown.

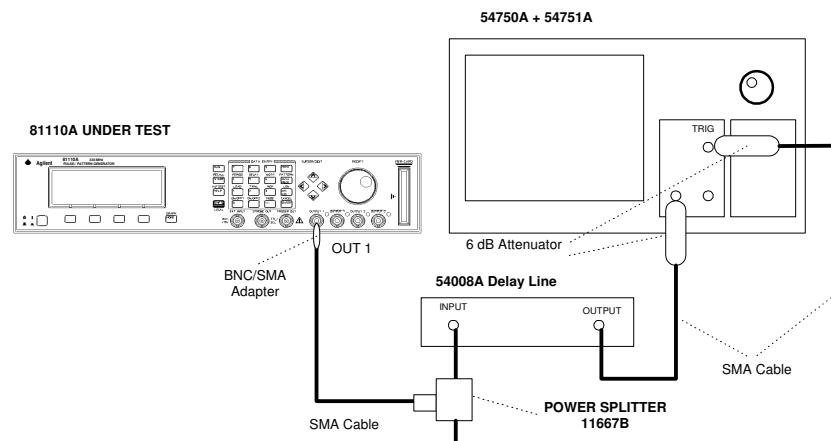

Equipment Set-up for Jitter Test using the Agilent 54750A + 54751A

Using the Agilent 54121T the Set-up is the same as before.

2. Set up the Agilent 81110A as described in "Initial Setup of the Agilent 81110A"
3. Select the [MODE/TRG] screen on the Agilent 81110A and set up as follows:

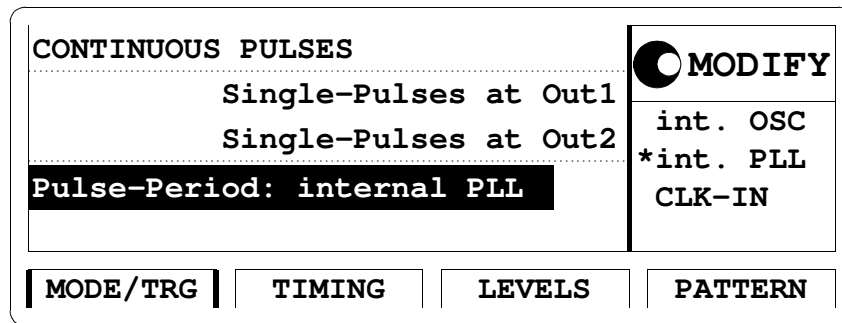

The TRG MODE Screen Setup

4. On the Agilent 81110A set up [OUTPUT 1] and [OUTPUT 2] pages as shown in the following illustrations:

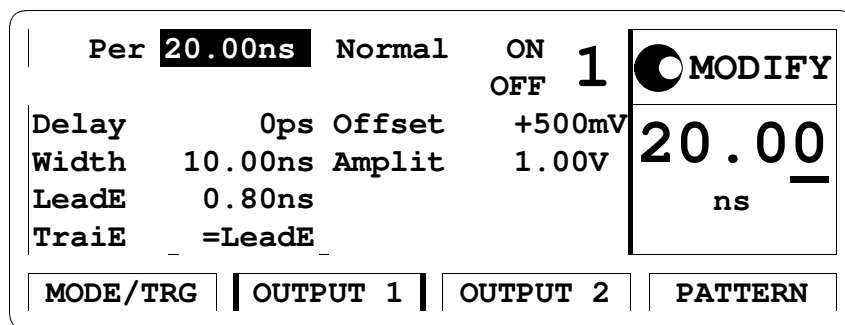

Configuring Output Screen 1

Per	20.00ns	Normal	OFF	2	<input type="radio"/> MODIFY
			OFF		
Delay	0ps	Offset	+500mV		20.00
Width	10.00ns	Amplit	1.00V		ns
LeadE	0.80ns				
TraIE	=LeadE				
MODE/TRG		OUTPUT 1		OUTPUT 2	
				PATTERN	

Configuring Output Screen 2

NOTE:

When you are testing instruments with 2 output channels it is necessary to:

- a. Configure *both* channels.
- b. Switch OFF the channel that is not being tested

If you then test the other channel:

- c. Switch ON the channel you are testing, and switch OFF the other channel.

5. Set the Digitizing Oscilloscope Agilent 54121T:

- Press AUTOSCALE
- Select the Display menu and set the Number of Averages to 64

- Select the Channel menu and set the Attenuation factor of channel 2 to 2
 - Set the VOLTS/DIV of channel 2 to 10 mV/div
 - Set OFFSET to 500 mV
 - Select the Timebase menu and set the TIME/DIV to 100 ps/div
 - Center the first positive-going edge of the signal (approximate Delay = 29 ns)
 - Select the Delta V menu and turn the V markers On
 - Set the Marker 1 Position to 490 mV and the Marker 2 Position to 500mV
 - Select the Delta t menu and turn the T Markers On
 - Set START ON EDGE = POS1 and STOP ON EDGE = POS1
 - Press the PRECISE EDGE FIND key
6. RECORD the delta t reading. This is the rise time of the reference signal within a 1% amplitude window of the signal connected to Input 2. This value is needed later to calculate the correct jitter. (delta.t.up)
7. Select the Timebase menu and center the second positive-going edge of the signal (approximate Delay = 49 ns)
8. Press MORE and HISTOGRAM
- Select the Window submenu and set:
 - Source is channel 2
 - Choose the Time Histogram
 - Press WINDOW MARKER 1 and set it to 490 mV

- Press WINDOW MARKER 2 and set it to 500 mV
- 9. Select the Acquire submenu, set the Number of Samples to 1000 and press START ACQUIRING
- 10. After the data for the time histogram has been acquired (# Samples = 100%), select the Result submenu.
- 11. Press MEAN and SIGMA. RECORD the values of sigma
- 12. The RMS-jitter is calculated as follows:

$$RMS - jitter = \frac{6\sigma_{\Delta t}}{6}$$

- 13. The RMS-jitter for period of 20 ns is 15.2 ps. Enter the result in the Test Report as TR entry 6.1b - 1

NOTE:

See the Agilent54750A User's Guide / Service Guide to get the info needed to do the Jitter Test using this scope.

Test 6.2: Width Jitter (PLL not active)

Test Specifications

RMS-Jitter 0.01% + 15 ps

Equipment Needed

Digitizing Oscilloscope with Accessories
Delay Line (22 ns)
Power Splitter
Cable, 50 Ω , coaxial, BNC
Cable, SMA

Procedure

1. Connect Agilent 81110A to the Scope as shown:

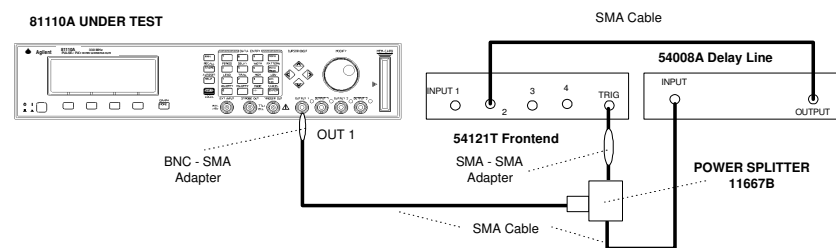

Equipment Set-up for Jitter Test

2. Set up the Agilent 81110A as described in "Initial Setup of the Agilent 81110A"

- On the Agilent 81110A set up [OUTPUT 1] and [OUTPUT 2] pages as shown in the following illustrations:

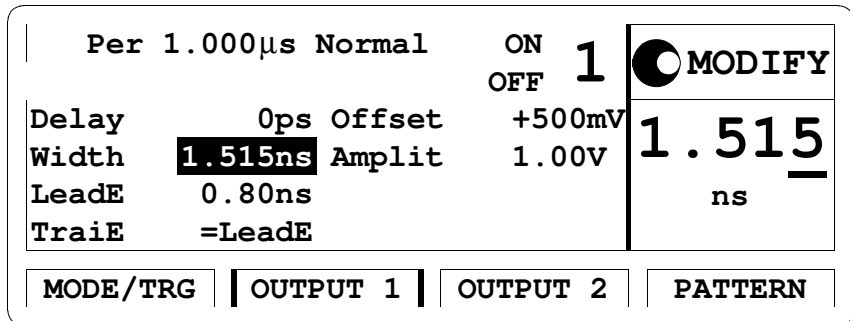

Configuring Output Screen 1

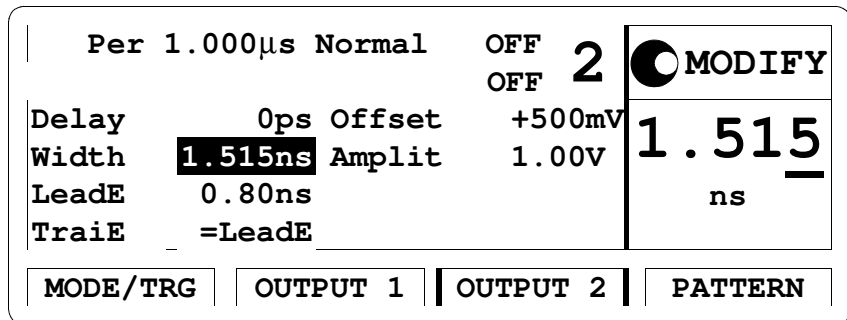

Configuring Output Screen 2

NOTE:

When you are testing instruments with 2 output channels it is necessary to:

- a. Configure *both* channels.
- b. Switch OFF the channel that is not being tested

If you then test the other channel:

- c. Switch ON the channel you are testing, and switch OFF the other channel.
-

4. Set the Digitizing Oscilloscope Agilent 54121T:

- Press AUTOSCALE
- Select the Display menu and set the Number of Averages to 128
- Select the Channel menu and set the Attenuation factor of channel 2 to 2
- Set the VOLTS/DIV of channel 2 to 10 mV/div
- Set OFFSET to 500 mV
- Select the Timebase menu and set the TIME/DIV to 10 ps/div
- Center the first negative-going edge of the signal (approximate Delay = 33.8 ns)
- Select the Delta V menu and turn the V markers On
- Set the Marker 1 Position to 500 mV and the Marker 2 Position to 490 mV
- Select the Delta t menu and turn the T Markers On
- Set START ON EDGE = NEG1 and STOP ON EDGE = NEG1
- Press the PRECISE EDGE FIND key

5. RECORD the delta t reading. This is the fall time of the reference signal within a 1% amplitude window of the signal connected to Input 2. This value is needed later to calculate the correct jitter. (Δt_{dn})
6. Set the Agilent 81110A Pulse Width to 50 ns
7. Select the Timebase menu and center the first negative-going edge of the signal (approximate Delay = 80.5 ns)
8. Press MORE and HISTOGRAM
9. Select the Window submenu and set:
 - Source is channel 2
 - Choose the Time Histogram
 - Press WINDOW MARKER 1 and set it to 500 mV
 - Press WINDOW MARKER 2 and set it to 490 mV
10. Select the Acquire submenu, set the Number of Samples to 1000 and press START ACQUIRING
11. After the data for the time histogram has been acquired (# Samples = 100%), select the Result submenu.
12. Press MEAN and SIGMA. RECORD the value of sigma
13. The RMS-jitter is calculated as follows:

$$\text{RMS - jitter} = \frac{6 \text{ sigma} - \text{delta.t.dn}}{6}$$

14. The RMS-jitter for pulse width of 50 ns is 20 ps. Enter the result in the Test Report as TR entry 6.2 - 1
15. Set the Agilent 81110A for pulse width of 500ns
16. Repeat steps 7 to 13

NOTE:

TIME/DIV = 100ps/div. Approximate delay = 530 ns

17. The RMS-jitter for pulse width of 500 ns is 65 ps. Enter the result in the Test Report as TR entry 6.2 - 2

NOTE:

Repeat the entire test for the second channel, if it is installed.

Test 6.3: Delay Jitter (PLL not active)

Test Specifications

RMS-Jitter 0.01% + 15 ps

Equipment Needed

Digitizing Oscilloscope with Accessories

Procedure

1. Connect Agilent 81110A to the Scope as shown:

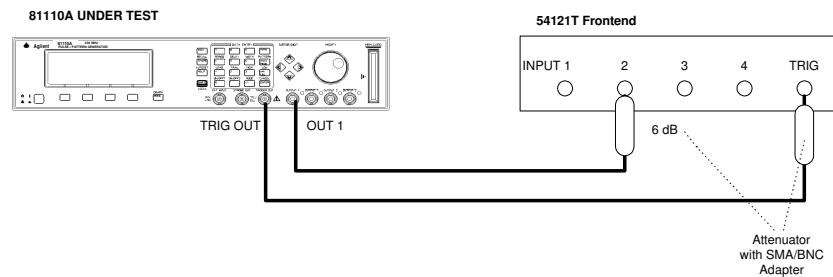

Equipment Set-up for Delay Jitter Test

2. For calculating the RMS-jitter, the rise time of the reference signal within a 1% amplitude window is required. If this value

is not already measured in the Period Jitter test, then perform the first 6 steps of the Period Jitter test.

3. Set up the Agilent 81110A as described in "Initial Setup of the Agilent 81110A"
4. On the Agilent 81110A press MORE and set up [OUTPUT 1] and [OUTPUT 2] pages as shown in the following illustrations:

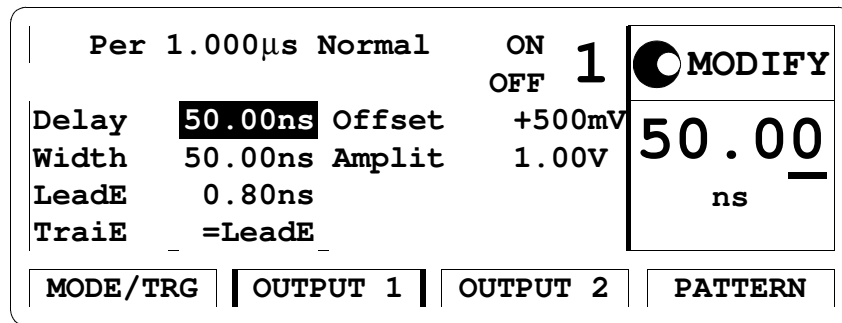

Configuring Output Screen 1

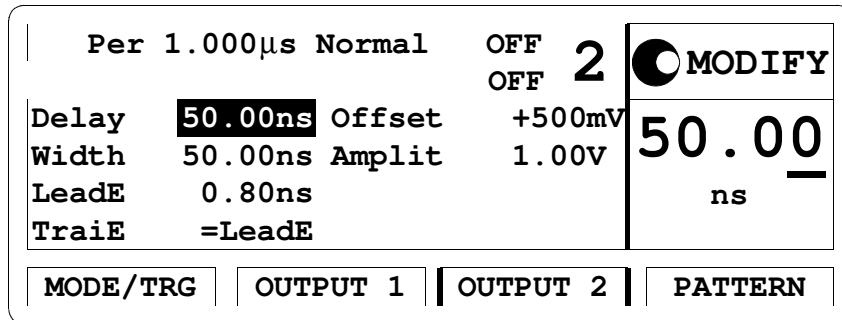

Configuring Output Screen 2

NOTE:

When you are testing instruments with 2 output channels it is necessary to:

- a. Configure *both* channels.
- b. Switch OFF the channel that is not being tested

If you then test the other channel:

- c. Switch ON the channel you are testing, and switch OFF the other channel.

-
5. Set the Digitizing Oscilloscope Agilent 54121T:
 - Press AUTOSCALE
 - Select the Display menu and set the Number of Averages to 64
 - Set the VOLTS/DIV = 10 mV/div
 - Set OFFSET to 500 mV
 - Select the Timebase menu and set the TIME/DIV to 100 ps/div
 - Center the first positive-going edge of the signal (approximate Delay = 64 ns)
 6. Press MORE and HISTOGRAM
 7. Select the Window submenu and press WINDOW MARKER 1 and set it to 490 mV
 8. Press WINDOW MARKER 2 and set it to 500 mV
 9. Select the Acquire submenu, set the Number of Samples to 1000 and press START ACQUIRING
 10. After the delta for the time histogram has been acquired (# Samples = 100%), select the Result submenu.
 11. Press MEAN and SIGMA. RECORD the values of sigma!

12. The RMS-jitter is calculated as follows:

$$\text{RMS - jitter} = \frac{6\sigma - \Delta t_{\text{up}}}{6}$$

13. The RMS-jitter for delay of 50 ns is 20 ps. Enter the result in the Test Report as TR entry 6.3 - 1
14. Set Agilent 81110A for delay of 500 ns
15. Repeat steps 9 to 12

NOTE:

TIME/DIV = 100 ps/div. Approximate delay = 510 ns

16. The RMS jitter for delay of 500 ns is 65 ps. Enter the result in the Test Report as TR entry 6.3 - 2

NOTE:

Repeat the entire test for the second channel, if it is installed.

Test 7: High and Low Levels

The following tests are required:

1. High level from 50 Ω into 50 Ω
2. Low level from 50 Ω into 50 Ω

Test Specifications

	Load Impedance 50 Ω	
Source Impedance	50 Ω	
High Level	-1.900 V to +3.8 V	
Low Level	-2.0 V to +3.7 V	
Amplitude	0.100 V _{pp} to 3.8 V _{pp}	
Level Resolution	10 mV	
Level Accuracy	$\pm 2\%$ of ampl ± 50 mV	

Equipment Needed

1. Digitizing Voltmeter (DVM)
2. 50 Ω Feedthrough Termination, 0.1%, 10 W Adapter.
3. BNC to dual banana plug (Agilent 1251-2277)
4. Cable, 50 Ω , coaxial, BNC

Procedure

Connect Agilent 81110A to the DVM as shown:

Agilent 81110A/'12A Performance Test

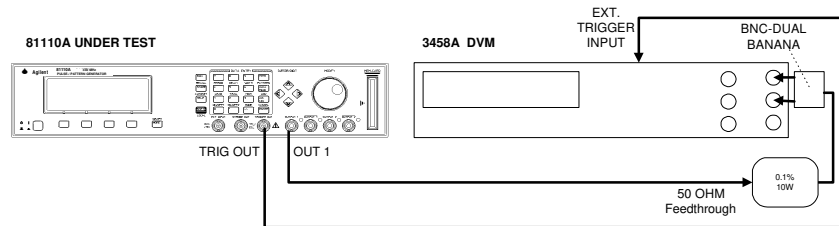

Connecting the DVM for High and Low Levels Tests

Test 7.1: High Level, 50 Ohms into 50 Ohms

1. Set up the Agilent 81110A as described in "Initial Setup of the Agilent 81110A"
2. On the Agilent 81110A press MORE and set up [OUTPUT 1] and [OUTPUT 2] pages as shown in the following illustrations:

Per 100.0ms Normal		ON	1	MODIFY	
		OFF			
Delay	25.00ms High	+3.80V		+3.80	
Width	50.00ms Low	+0.0mV			
LeadE	0.80ns				
TraIE	=LeadE			V	
MODE/TRG		OUTPUT 1		OUTPUT 2	
				PATTERN	

Configuring Output Screen 1

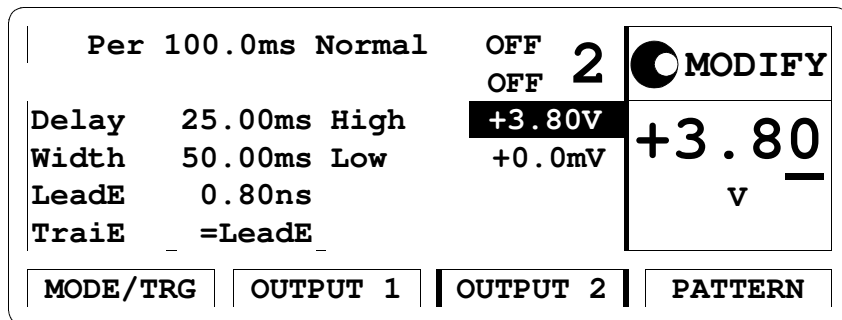

Configuring Output Screen 2

NOTE:

When you are testing instruments with 2 output channels it is necessary to:

- a. Configure *both* channels.
- b. Switch OFF the channel that is not being tested

If you then test the other channel:

- c. Switch ON the channel you are testing, and switch OFF the other channel.

3. Set the DVM Agilent 3458A to:

Function: DCV
 Trigger: TRIG EXT
 AD-Converter integration time NPLC: 0.1
 (Number of Power Line Cycles)

4. Check the Agilent 81110A high level at the following high level settings with the low level set to 0.0 V.

High Level	Acceptable Range	TR Entry
3.80 V	3.674 V to 3.926 V	7.1 - 1
1.0 V	0.93 V to 1.07 V	7.1 - 2
0.5 V	440 mV to 560 mV	7.1 - 3
0.1 V	48 mV to 152 mV	7.1 - 4

The low level may vary within $\pm 2\%$ of amplitude ± 50 mV

Test 7.2: Low Level, 50 Ohms into 50 Ohms

1. Set up the Agilent 81110A as described in "Initial Setup of the Agilent 81110A"
2. On the Agilent 81110A press MORE and set up [OUTPUT 1] and [OUTPUT 2] pages as shown in the following illustrations:

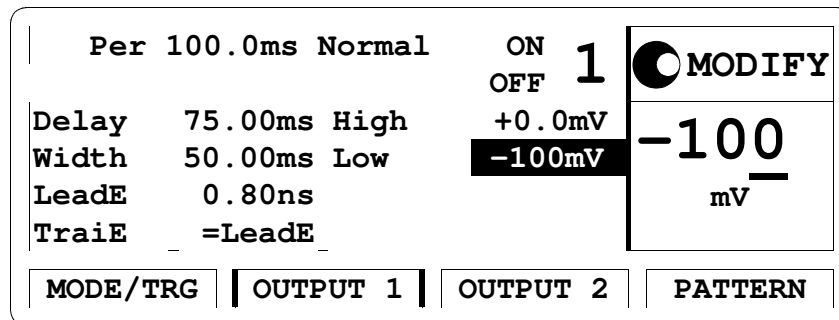

Configuring Output Screen 1

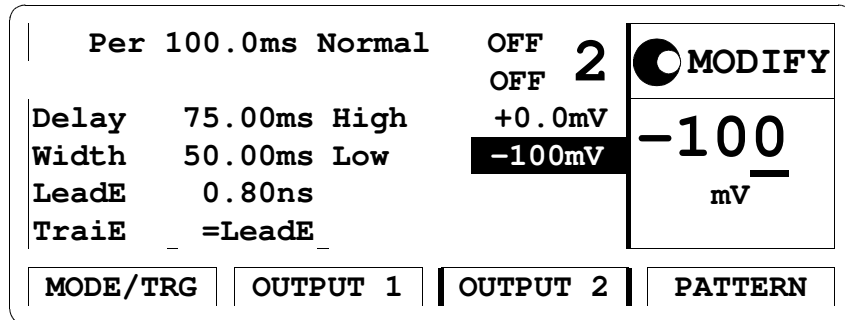

Configuring Output Screen 2

NOTE:

When you are testing instruments with 2 output channels it is necessary to:

- a. Configure *both* channels.
- b. Switch OFF the channel that is not being tested

If you then test the other channel:

- c. Switch ON the channel you are testing, and switch OFF the other channel.

3. Check the Agilent 81110A low level at the following low level settings with the high level set to 0.0 V

Low Level	Acceptable Range	TR Entry
-0.1 V	-48 mV to -152 mV	7.2 - 1
-0.5 V	-440 mV to -560 mV	7.2 - 2
-1.0 V	-0.93 V to -1.07 V	7.2 - 3
-2.00 V	-1.910 V to -2.090 V	7.2 - 4

The high level 0.0 V may vary $\pm 2\%$ of amplitude ± 50 mV.

NOTE:

Repeat the High and Low Level tests for the second channel, if it is installed.

Test 8: Transition Time

Test Specifications

Range	0.8 ns OR 1.6 ns (measured between 10% and 90% of amplitude)
Minimum Transitions	≤ 600 ps for $V_{pp} < 1$ V ≤ 900 ps for $V_{pp} > 1$ V (typical 450 ps for ECL levels measured between 20% and 80% of amplitude)
Accuracy	$\pm 10\%$ ± 200 ps

Equipment Needed

Digitizing Oscilloscope with Accessories
Cable, SMA

Procedure

Perform the tests as shown in the following sections:

Test 8.1a: Leading Edge Test

Minimum Leading Edge and Leading Edge ranges .

1. Connect Agilent 81110A to the Scope as shown:

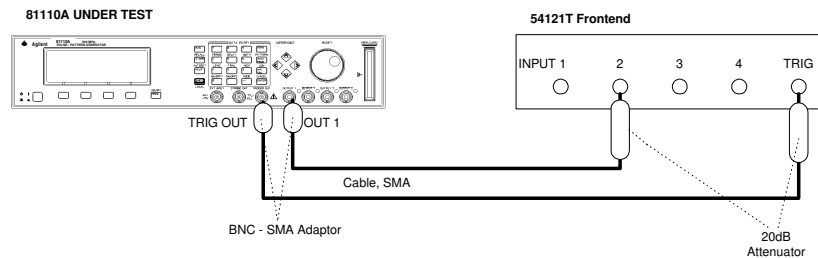

Connecting Agilent 81110A to the Scope

NOTE:

When you connect the test equipment the first time, and whenever you change the setup during the following tests, use the torque wrench (8170-1582) to tighten and loosen the SMA connectors. This will ensure that the connectors are at the correct tightness and give the best signal transfer!

-
2. Set up the Agilent 81110A as described in "Initial Setup of the Agilent 81110A"
 3. On the Agilent 81110A press MORE and set up [OUTPUT 1] and [OUTPUT 2] pages as shown in the following illustrations:

Per 500.0µs Normal		ON	1	<input checked="" type="radio"/> MODIFY
		OFF		
Delay	0ps Offset	+0.0mV	*0.8ns	
DtyCyc	50.00% Amplit	3.80V	1.6ns	
LeadE	0.80ns			
Traie	=LeadE			
MODE/TRG		OUTPUT 1	OUTPUT 2	PATTERN

Configuring Output Screen 1

Per 500.0µs Normal		OFF	2	<input checked="" type="radio"/> MODIFY
		OFF		
Delay	0ps Offset	+0.0mV	*0.8ns	
DtyCyc	50.00% Amplit	3.80V	1.6ns	
LeadE	0.80ns			
Traie	=LeadE			
MODE/TRG		OUTPUT 1	OUTPUT 2	PATTERN

Configuring Output Screen 2

NOTE:

When you are testing instruments with 2 output channels it is necessary to:

- a. Configure *both* channels.
- b. Switch OFF the channel that is not being tested

If you then test the other channel:

c. Switch ON the channel you are testing, and switch OFF the other channel.

-
4. Set the Digitizing Oscilloscope Agilent 54121T:
 - Press AUTOSCALE
 - Center one pulse on screen, e.g.:
 - TIME/DIV = 50 μ s/div, DELAY = 380 μ s,
 - Select the Display menu and set the Number of Averages to 32
 - Select the Channel menu and set the Attenuation factor to 10
 - Select the Delta V menu and turn the voltage markers On
 - Set the Preset Levels = 10-90% and press AUTO LEVEL SET
 - Select the Timebase menu and set TIME/DIV = 1 ns/div, DELAY = 16 ns
 - Select the Delta t menu and turn the markers On
 - Set START ON EDGE = POS1 and STOP ON EDGE = POS1
 5. Set period of Agilent 81110A to: Period = 1 μ s and change the Agilent 81110A Delay to center the leading edge of the first pulse on the screen
 6. After the averaging, while the oscilloscope is in the Delta t menu, Press the PRECISE EDGE FIND key

7. Check the Agilent 81110A rise times at the following leading edge settings:

Oscilloscope TIME/ DIV	Period	Leading Edge	Trailing Edge	Acceptable Range	TR Entry
1 ns/div	1 μ s	0.8 ns	0.8 ns	540 ps to 1.080 ns	8.1a - 1
1 ns/div	1 μ s	1.6 ns	1.6 ns	1.240 ns to 1.960 ns	8.1a - 2

Test 8.1b: Trailing Edge Test

Minimum Trailing Edge and Trailing Edge range.

1. Connect Agilent 81110A to the Scope as shown in Test 8.1a Leading Edge Test.
2. Set up the Agilent 81110A as described in Test 8.1a Leading Edge Test.

NOTE:

When you are testing instruments with 2 output channels it is necessary to:

- a. Configure *both* channels.
- b. Switch OFF the channel that is not being tested

If you then test the other channel:

- c. Switch ON the channel you are testing, and switch OFF the other channel.

-
3. Set the digitizing oscilloscope Agilent 54121T:
 - Select the oscilloscopes Timebase menu and set TIME/DIV to 1 ns/div and DELAY to approximately 510 ns
 - Select the oscilloscopes Delta t menu and set START ON EDGE = NEG1 and STOP ON EDGE = NEG1
 4. While the oscilloscope is in the Delta t menu, press the PRE-CISE EDGE FIND key
 5. Check the Agilent 81110A output signal falls at the following trailing edge settings:

Agilent 81110A/'12A Performance Test

Oscilloscope TIME/DIV	Delay	Period	Trailing Edge	Leading Edge	Acceptable Range	TR Entry
1 ns/div	529 ns	1 μ s	0.8 ns	0.8 ns	540 ps to 1.080 ns	8.1b - 1
1 ns/div	529 ns	1 μ s	1.6 ns	1.6 ns	1.240 ns to 1.960 ns	8.1b - 2

Test 9: Pulse Aberration Test

The following tests are required:

Overshoot and Ringing
Preshoot

Test Specifications

Overshoot/Preshoot/Ringing
 $\pm 5\%$ of amplitude ± 50 mV

Equipment Needed

Digitizing Oscilloscope with Accessories

Procedure

6. Set up the Agilent 81110A as described in "Initial Setup of the Agilent 81110A"
1. Connect Agilent 81110A to the Scope as shown:

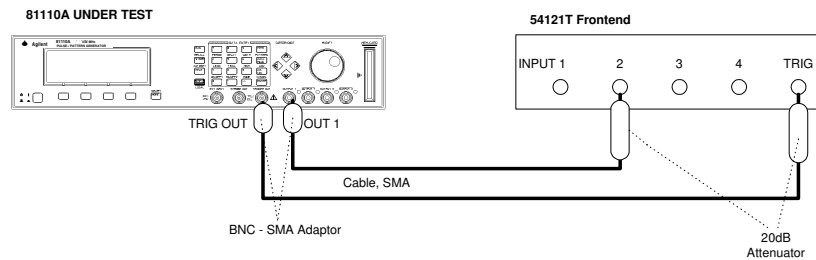

Connecting Agilent 81110A to the Scope

Per 500.0 μ s Normal		ON OFF	1	<input checked="" type="radio"/> MODIFY
Delay	0ps High	+3.8V		+3.80 V
DtyCyc	50.00% Low	+0.0mV		
LeadE	0.80ns			
Traie	=LeadE			
MODE/TRG		OUTPUT 1	OUTPUT 2	PATTERN

Configuring Output Screen 1

Per 500.0 μ s Normal		OFF OFF	2	<input checked="" type="radio"/> MODIFY
Delay	0ps High	+3.8V		+3.80 V
DtyCyc	50.00% Low	+0.0mV		
LeadE	0.80ns			
Traie	=LeadE			
MODE/TRG		OUTPUT 1	OUTPUT 2	PATTERN

Configuring Output Screen 2

NOTE:

When you are testing instruments with 2 output channels it is necessary to:

- a. Configure *both* channels.
- b. Switch OFF the channel that is not being tested

If you then test the other channel:

- c. Switch ON the channel you are testing, and switch OFF the other channel.
-

Overshoot and Ringing

2. Set the digitizing oscilloscope Agilent 54121T:
 - Press AUTOSCALE
 - Select the Display menu and set the Number of Averages to 32
 - Select the Channel menu and set the Attenuation factor to 10
 - Center one pulse horizontally and vertically on screen
 - (e.g. TIME/DIV = 50 μ s/div, DELAY = 250 μ s)
 - Select the delta V menu and turn the voltage markers On
 - Set the VARIABLE LEVELS = 95% - 105% and press AUTO LEVEL SET
 - Select the channel menu and center vertically the top pulse (offset = 5 V)
 - Set the VOLTS/DIV = 200 mV/div
 - Select the Timebase menu and set TIME/DIV = 5 ns/div, DELAY = 16 ns (>> 500 ns)
3. Set the Agilent 81110A to period = 500 ns

4. Check that Overshoot and Ringing are within the $\pm 5\%$ of amplitude ± 50 mV window
5. Enter the result in the Test Report as TR entry 9 - 1

NOTE:

Take the oscilloscope's trace flatness error (GaAs input circuit) into account.

Preshoot

6. Set Agilent 81110A to:
 - Period = 500 μ s
 - High Level = 3.8 V
 - Low Level = 0 V
 - Delay = 10 ns
7. Set the digitizing oscilloscope, Agilent 54121T:
 - Press AUTOSCALE
 - Select the Display menu and set the Number of Averages to 32
 - Select the Channel menu and set the Attenuation factor to 10
 - Center one pulse horizontally and vertically on screen
 - (e.g. TIME/DIV = 50 μ s/div, DELAY = 265 μ s)
 - Select the delta V menu and turn the voltage markers On
 - Set the VARIABLE LEVELS = -5% to +5% and press AUTO LEVEL SET
 - Select the channel menu and center vertically the bottom of the
 - pulse (offset = 0 V)

Agilent 81110A/12A Performance Test

- Set the VOLTS/DIV = 200 mV/div
 - Select the Timebase menu and set TIME/DIV = 5 ns/div, DELAY = 16 ns
8. Set Agilent 81110A to period = 500 ns
 9. Check that Preshoot is within the $\pm 5\%$ of amplitude ± 50 mV window.
 10. Enter the result in the Test Report as TR entry 9 - 3

Agilent 81110A/12A Performance Test Records

Test Facility:

_____ Report No. _____
_____ Date _____
_____ Customer _____
_____ Tested By _____

×

Model Agilent 81110A/12A 330 MHz Pulse Generator

Serial No. _____

Options _____ Ambient temperature _____ °C
_____ Relative humidity _____ %

Firmware Rev. _____ Line frequency _____ Hz

Special Notes:

Test Equipment Used			
Description	Model No.	Trace No.	Cal. Due Date
1. Oscilloscope	Agilent 54121T	_____	_____
2. Counter	Agilent 5334B	_____	_____
3. Digital Voltmeter	Agilent 3458A	_____	_____
4. Pulse Generator	Agilent 8110A	_____	_____
5. Delay Line	Agilent 54008A	_____	_____
6.	_____	_____	_____
7.	_____	_____	_____
8.	_____	_____	_____
9.	_____	_____	_____
10.	_____	_____	_____
11.	_____	_____	_____
12.	_____	_____	_____
13.	_____	_____	_____
14.	_____	_____	_____

Test Results for Agilent 81110A Mainframe

Serial No. _____ Ambient temperature _____ °C

Customer _____ Relative humidity _____ %

CSO# _____ Line frequency _____ Hz

Tested by _____ Date _____

Comments

Internal Oscillator Period

Scope Uncertainty factor _____

TR Entry	Test	Limit Min	Actual Result	Limit Max	Pass	Fail
1-1	3.03ns	2.9391 ns	_____	3.1209 ns	_____	_____
1-2	6.06ns	5.878 ns	_____	6.242 ns	_____	_____
1-3	10.0ns	9.7 ns	_____	10.3 ns	_____	_____
1-4	50.0ns	48.5 ns	_____	51.5 ns	_____	_____
1-5	99.9ns	96.903 ns	_____	102.897 ns	_____	_____

Counter Uncertainty factor _____

TR Entry	Test	Limit Min	Actual Result	Limit Max	Pass	Fail
1-6	100 ns	97.0ns	_____	103.0 ns	_____	_____
1-7	500 ns	485.0 ns	_____	515.0 ns	_____	_____
1-8	1 μ s	970.0 ns	_____	1030.0 ns	_____	_____
1-9	5 00 μ s	485 μ s	_____	5 15 μ s	_____	_____
1-10	500 ms	485 ms	_____	515 ms	_____	_____

PLL Period
(Results measured as frequency by counter)

Counter Uncertainty factor _____

TR Entry	Test	Limit Min	Actual Result	Limit Max	Pass	Fail
2-1	3.03 ns	329.9670MHz	_____	330.0330MHz	__	__
2-2	10.00 ns	99.990MHz	_____	100.010 MHz	__	__
2-3	50.00 ns	19.9980MHz	_____	20.0020MHz	__	__
2-4	100 ns	9.9990MHz	_____	10.0010MHz	__	__
2-5	500 ns	1.9998MHz	_____	2.0002MHz	__	__
2-6	1 μ s	999.9 kHz	_____	1.0001 MHz	__	__
2-7	50 μ s	19.998 kHz	_____	20.002 kHz	__	__
2-8	5 ms	199.98 Hz	_____	200.02 Hz	__	__
2-9	500 ms	1.9998 Hz	_____	2.0002 Hz	__	__
2-10	5 s	0.19998 Hz	_____	0.20002 Hz	__	__

Period Jitter

Scope Uncertainty factor _____

TR Entry	Test	Limit Min	Actual Result	Limit Max	Pass	Fail
6.1a-1	50 ns		_____	20 ps	_____	_____
6.1a-2	500 ns		_____	65 ps	_____	_____
6.1b-1	20 ns		_____	15.2 ps	_____	_____

Test Results for Agilent 81112A Output Channel _____

Serial No. _____

Width

Scope Uncertainty factor _____

TR Entry	Test	Limit Min	Actual Result	Limit Max	Pass	Fail
3-1	1.515 ns	1.22455 ns	_____	1.80545 ns	_____	_____
3-2	6.06ns	5.528 ns	_____	6.492 ns	_____	_____
3-3	10.0 ns	9.450ns	_____	10.550 ns	_____	_____
3-4	50.0 ns	48.25 ns	_____	51.75 ns	_____	_____
3-5	100 ns	96.75 ns	_____	103.25 ns	_____	_____
3-6	500 ns	484.75 ns	_____	515.25 ns	_____	_____
3-7	50 μs	48.5 μs	_____	51.5 μs	_____	_____
3-8	5 ms	4.85 ms	_____	5.15 ms	_____	_____
3-9	500 ms	485 ms	_____	515 ms	_____	_____

Width Jitter

Scope Uncertainty factor _____

TR Entry	Test	Limit Min	Actual Result	Limit Max	Pass	Fail
6.2-1	50 ns	_____	_____	20 ps	_____	_____
6.2-2	500 ns	_____	_____	65 ps	_____	_____

Delay

Scope Uncertainty factor _____

TR Entry	Test	Limit Min	Actual Result	Limit Max	Pass	Fail
4-1	0.00 ns		_____ Fixed Delay		___	___
4-2	5.00 ns	4.35 ns	_____	5.65 ns	___	___
4-3	10 ns	9.20 ns	_____	10.80 ns	___	___
4-4	50.0 ns	48.0 ns	_____	52.0 ns	___	___
4-5	100 ns	96.5 ns	_____	103.5 ns	___	___
4-6	500 ns	484.5 ns	_____	515.5 ns	___	___
4-7	50 μ s	48.5 μ s	_____	51.5 μ s	___	___
4-8	5 ms	4.85 ms	_____	5.15 ms	___	___
4-9	500 ms	485 ms	_____	515 ms	___	___

Delay Jitter

Scope Uncertainty factor _____

TR Entry	Test	Limit Min	Actual Result	Limit Max	Pass	Fail
6.3-1	50 ns	_____	_____	20 ps	_____	_____
6.3-2	500 ns	_____	_____	65 ps	_____	_____

Double Pulse Delay

Scope Uncertainty factor _____

TR Entry	Test	Limit Min	Actual Result	Limit Max	Pass	Fail
5-1	3.015 ns	2.77455 ns	_____	3.25545 ns	___	___
5-2	10.0 ns	9.550 ns	_____	10.45 ns	___	___
5-3	50.0ns	48.35 ns	_____	51.65 ns	___	___
5-4	100ns	96.85 ns	_____	103.15 ns	___	___

Counter Uncertainty factor _____

TR Entry	Test	Limit Min	Actual Result	Limit Max	Pass	Fail
5-5	500 ms	485 ms	_____	515 ms	___	___
5-6	1 s	970.0 ms	_____	1030.0 ms	___	___

High Level 50Ω-50Ω

TR Entry	Test	Limit Min	Actual Result	Limit Max	Pass	Fail
7.1-1	3.80V	3.674 V	_____	3.926 V	___	___
7.1-2	1.0 V	0.93 V	_____	1.07 V	___	___
7.1-3	0.5 V	440 mV	_____	560 mV	___	___
7.1-4	0.1 V	48 mV	_____	152 mV	___	___

Low Level 50Ω-50Ω

TR Entry	Test	Limit Min	Actual Result	Limit Max	Pass	Fail
7.2-1	-0.1 V	-48 mV	_____	-152 mV	___	___
7.2-2	-0.5 V	-440 mV	_____	-560 mV	___	___
7.2-3	-1.0 V	-0.93 V	_____	-1.07 V	___	___
7.2-4	-2.0 V	-1.910 V	_____	-2.090 V	___	___

Leading Edge

Scope Uncertainty factor _____

TR Entry	Test	Limit Min	Actual Result	Limit Max	Pass	Fail
8.1a-1	0.8 ns	540 ps	_____	1.08 ns	____	____
8.1a-2	1.6 ns	1.24 ns	_____	1.96 ns	____	____

Trailing Edge

TR Entry	Test	Limit Min	Actual Result	Limit Max	Pass	Fail
8.1b-1	0.8 ns	540 ps	_____	1.08 ns	____	____
8.1b-2	1.6 ns	1.24 ns	_____	1.96 ns	____	____

Overshoot and Ringing

Scope Uncertainty factor _____

TR Entry	Test	Limit Min	Actual Result	Limit Max	Pass	Fail
9-1	3.8V		_____	$\pm 5\%$ of ampl. $\pm 50\text{mV}$	_____	_____
9-2	500 mV		_____	$\pm 5\%$ of ampl. $\pm 50\text{mV}$	_____	_____

Preshoot

TR Entry	Test	Limit Min	Actual Result	Limit Max	Pass	Fail
9-3	0 V		_____	$\pm 5\%$ of ampl. $\pm 50\text{mV}$	_____	_____

Agilent 81110A/12A Performance Test

Publication Number: 5988-4854EN



Agilent Technologies

www.valuetronics.com