

***SERVICE MANUAL***

**AUTORANGING  
SYSTEM DC POWER SUPPLY  
AGILENT MODELS 6030A, 6031A,  
6032A and 6035A**

**FOR INSTRUMENTS WITH SERIAL NUMBERS**

**Agilent Model 6030A; Serials US38320301 and above**

**Agilent Model 6031A; Serials US38310376 and above**

**Agilent Model 6032A; Serials US38321026 and above**

**Agilent Model 6035A; Serials US38320281 and above**

For instruments with higher serial numbers, a change page may be included.



**Agilent Technologies**

**Agilent Part No. 5959-3344  
Microfiche Part No. 5959-3345**

**Printed in USA  
September, 2000**

## **CERTIFICATION**

*Agilent Technologies certifies that this product met its published specifications at time of shipment from the factory. Agilent Technologies further certifies that its calibration measurements are traceable to the United States National Bureau of Standards, to the extent allowed by the Bureau's calibration facility, and to the calibration facilities of other International Standards Organization members.*

## **WARRANTY**

This Agilent Technologies hardware product is warranted against defects in material and workmanship for a period of three years from date of delivery. Agilent Technologies software and firmware products, which are designated by Agilent Technologies for use with a hardware product and when properly installed on that hardware product, are warranted not to fail to execute their programming instructions due to defects in material and workmanship for a period of 90 days from date of delivery. During the warranty period Agilent Technologies will, at its option, either repair or replace products which prove to be defective. Agilent Technologies does not warrant that the operation of the software, firmware, or hardware shall be uninterrupted or error free.

For warranty service, with the exception of warranty options, this product must be returned to a service facility designated by Agilent Technologies. Customer shall prepay shipping charges by (and shall pay all duty and taxes) for products returned to Agilent Technologies for warranty service. Except for products returned to Customer from another country, Agilent Technologies shall pay for return of products to Customer.

Warranty services outside the country of initial purchase are included in Agilent Technologies product price, only if Customer pays Agilent Technologies international prices (defined as destination local currency price, or U.S. or Geneva Export price).

If Agilent Technologies is unable, within a reasonable time to repair or replace any product to condition as warranted, the Customer shall be entitled to a refund of the purchase price upon return of the product to Agilent Technologies.

## **LIMITATION OF WARRANTY**

The foregoing warranty shall not apply to defects resulting from improper or inadequate maintenance by the Customer, Customer-supplied software or interfacing, unauthorized modification or misuse, operation outside of the environmental specifications for the product, or improper site preparation and maintenance. NO OTHER WARRANTY IS EXPRESSED OR IMPLIED. AGILENT TECHNOLOGIES SPECIFICALLY DISCLAIMS THE IMPLIED WARRANTIES OF MERCHANTABILITY AND FITNESS FOR A PARTICULAR PURPOSE.

## **EXCLUSIVE REMEDIES**

THE REMEDIES PROVIDED HEREIN ARE THE CUSTOMER'S SOLE AND EXCLUSIVE REMEDIES. AGILENT TECHNOLOGIES SHALL NOT BE LIABLE FOR ANY DIRECT, INDIRECT, SPECIAL, INCIDENTAL, OR CONSEQUENTIAL DAMAGES, WHETHER BASED ON CONTRACT, TORT, OR ANY OTHER LEGAL THEORY.

## **ASSISTANCE**

*The above statements apply only to the standard product warranty. Warranty options, extended support contracts, product maintenance agreements and customer assistance agreements are also available. Contact your nearest Agilent Technologies Sales and Service office for further information on Agilent Technologies' full line of Support Programs.*

# SAFETY SUMMARY

*The following general safety precautions must be observed during all phases of operation, service and repair of this instrument. Failure to comply with these precautions or with specific warnings elsewhere in this manual violates safety standards of design, manufacture, and intended use of the instrument. Agilent Technologies Inc. assumes no liability for the customer's failure to comply with these requirements.*

## **BEFORE APPLYING POWER.**

Verify that the product is set to match the available line voltage and the correct fuse is installed.

## **GROUND THE INSTRUMENT.**

This product is a Safety Class 1 instrument (provided with a protective earth terminal). To minimize shock hazard, the instrument chassis and cabinet must be connected to an electrical ground. The instrument must be connected to the ac power supply mains through a three-conductor power cable, with the third wire firmly connected to an electrical ground (safety ground) at the power outlet. For instruments designed to be hard wired to the ac power lines (supply mains), connect the protective earth terminal to a protective conductor before any other connection is made. Any interruption of the protective (grounding) conductor or disconnection of the protective earth terminal will cause a potential shock hazard that could result in personal injury. If the instrument is to be energized via an external autotransformer for voltage reduction, be certain that the autotransformer common terminal is connected to the neutral (earth pole) of the ac power lines (supply mains).

## **INPUT POWER MUST BE SWITCH CONNECTED.**

For instruments without a built-in line switch, the input power lines must contain a switch or another adequate means for disconnecting the instrument from the ac power lines (supply mains).

## **DO NOT OPERATE IN AN EXPLOSIVE ATMOSPHERE.**

Do not operate the instrument in the presence of flammable gases or fumes.

## **KEEP AWAY FROM LIVE CIRCUITS.**

Operating personnel must not remove instrument covers. Component replacement and internal adjustments must be made by qualified service personnel. Do not replace components with power cable connected. Under certain conditions, dangerous voltages may exist even with the power cable removed. To avoid injuries, always disconnect power, discharge circuits and remove external voltage sources before touching components.

## **DO NOT SERVICE OR ADJUST ALONE.**

Do not attempt internal service or adjustment unless another person, capable of rendering first aid and resuscitation, is present.

## **DO NOT EXCEED INPUT RATINGS.**

This instrument may be equipped with a line filter to reduce electromagnetic interference and must be connected to a properly grounded receptacle to minimize electric shock hazard. Operation at the line voltage or frequencies in excess of those stated on the data plate may cause leakage currents in excess of 5.0mA peak.

## **SAFETY SYMBOLS.**



Instruction manual symbol: the product will be marked with this symbol when it is necessary for the user to refer to the instruction manual (refer to Table of Contents) .



Indicates hazardous voltages.

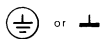

Indicate earth (ground) terminal.

## **WARNING**

The WARNING sign denotes a hazard. It calls attention to a procedure, practice, or the like, which, if not correctly performed or adhered to, could result in personal injury. Do not proceed beyond a WARNING sign until the indicated conditions are fully understood and met.



















## **CAUTION**

The CAUTION sign denotes a hazard. It calls attention to an operating procedure, or the like, which, if not correctly performed or adhered to, could result in damage to or destruction of part or all of the product. Do not proceed beyond a CAUTION sign until the indicated conditions are fully understood and met.

## **DO NOT SUBSTITUTE PARTS OR MODIFY INSTRUMENT.**

Because of the danger of introducing additional hazards, do not install substitute parts or perform any unauthorized modification to the instrument. Return the instrument to an Agilent Technologies Sales and Service Office for service and repair to ensure that safety features are maintained.

*Instruments which appear damaged or defective should be made inoperative and secured against unintended operation until they can be repaired by qualified service personnel.*

Safety Symbol Definitions			
Symbol	Description	Symbol	Description
	Direct current		Terminal for Line conductor on permanently installed equipment
	Alternating current		Caution, risk of electric shock
	Both direct and alternating current		Caution, hot surface
	Three-phase alternating current		Caution (refer to accompanying documents)
	Earth (ground) terminal		In position of a bi-stable push control
	Protective earth (ground) terminal (Intended for connection to external protective conductor.)		Out position of a bi-stable push control
	Frame or chassis terminal		On (supply)
	Terminal for Neutral conductor on permanently installed equipment		Off (supply)
	Terminal is at earth potential (Used for measurement and control circuits designed to be operated with one terminal at earth potential.)		Standby (supply) Units with this symbol are not completely disconnected from ac mains when this switch is off. To completely disconnect the unit from ac mains, either disconnect the power cord or have a qualified electrician install an external switch.

## Printing History

The edition and current revision of this manual are indicated below. Reprints of this manual containing minor corrections and updates may have the same printing date. Revised editions are identified by a new printing date. A revised edition incorporates all new or corrected material since the previous printing date. Changes to the manual occurring between revisions are covered by change sheets shipped with the manual. Also, if the serial number prefix of your power supply is higher than those listed on the title page of this manual, then it may or may not include a change sheet. That is because even though the higher serial number prefix indicates a design change, the change may not affect the content of the manual.

Edition 1     June, 1991  
Edition2     September, 2000

© Copyright 1991, 2000 Agilent Technologies, Inc.

This document contains proprietary information protected by copyright. All rights are reserved. No part of this document may be photocopied, reproduced, or translated into another language without the prior consent of Agilent Technologies, Inc. The information contained in this document is subject to change without notice.

# TABLE OF CONTENTS

<b>Introduction .....</b>	<b>9</b>
Scope .....	9
Calibration and Verification .....	9
Troubleshooting .....	9
Principles of Operation .....	9
Replaceable Parts .....	9
Circuit Diagrams .....	9
Safety Considerations .....	9
Manual Revisions .....	10
Firmware Revisions .....	10
<b>Calibration and Verification .....</b>	<b>11</b>
Introduction .....	11
Test Equipment Required .....	11
Operation Verification Tests .....	11
Calibration Procedure .....	11
Initial Setup .....	14
Voltage Monitor Zero Calibration .....	15
Common Mode Calibration .....	15
Remote Readback Zero Calibration .....	15
Constant Voltage Full Scale Calibration .....	17
Voltage Monitor and Remote Readback Full Scale Calibration .....	17
Constant Voltage Zero Calibration .....	18
Current Monitor Zero Calibration .....	18
Constant Current Zero Calibration .....	18
Current Monitor Full Scale Calibration .....	19
Constant Current Full Scale Calibration .....	19
Power Limit Calibration .....	20
Resistance Programming Full Scale Calibration .....	21
Performance Tests .....	21
Measurement Techniques .....	21
Constant Voltage (CV) Tests .....	22
Constant Current (CC) Tests .....	28
Initialization Procedure .....	31
<b>Troubleshooting .....</b>	<b>33</b>
Introduction .....	33
Initial Troubleshooting Procedures .....	33
Electrostatic Protection .....	34
Repair and Replacement .....	34
A2 Control Board Removal .....	35
A4 FET Board Removal .....	35
A5 Diode Board Removal .....	36
A8 GPIB Board Removal .....	36
A3 Front-Panel Board Removal .....	36
A1 Main Board Removal .....	36
Overall Troubleshooting Procedure .....	37
GPIB Section Troubleshooting .....	39
Primary Interface Troubleshooting .....	40

Secondary Interface Troubleshooting .....	41
Voltage and Current DAC.....	41
Readback DAC Circuits.....	43
Readback Multiplexer (U20):.....	43
Signature Analysis .....	45
Primary SA .....	45
Front Panel SA.....	45
Secondary SA .....	46
Power Section Troubleshooting.....	51
Main Troubleshooting Setup.....	52
Troubleshooting No-Output Failures .....	53
Power Section Blocks .....	54
Troubleshooting AC-Turn-On Circuits.....	57
Troubleshooting DC-To-DC Converter .....	57
Troubleshooting Bias Supplies .....	58
Troubleshooting Down Programmer.....	61
Troubleshooting CV Circuit .....	61
Troubleshooting CC Circuit.....	62
Troubleshooting OVP Circuit .....	62
Troubleshooting PWM & Clock.....	63
<b>Principles of Operation .....</b>	<b>65</b>
Introduction.....	65
GPIB Board .....	65
Primary Microprocessor .....	65
Address Switches .....	65
EEPROM.....	67
Isolation .....	67
Secondary Microprocessor .....	67
Digital-to-Analog Converters.....	67
Analog Multiplexer.....	67
Status Inputs.....	67
Front Panel Board.....	68
Address Latches and Decoders .....	68
Volts and Amps Output Ports and Displays.....	68
RPG and Latches .....	68
Front-Panel Switches and Input Port.....	68
Mode Indicators .....	70
OVP Adjust Control.....	70
Power Clear .....	70
Power Mesh and Control Board.....	70
Overview.....	70
Power Mesh .....	71
Control Board .....	73
<b>Replaceable Parts.....</b>	<b>79</b>
Introduction.....	79
Ordering Information .....	80
<b>Component Location and Circuit Diagrams .....</b>	<b>101</b>

<b>100 Vac Input Power Option 100 .....</b>	<b>119</b>
General Information.....	119
Description.....	119
Scope of Appendix A.....	119
Suggestions for Using Appendix A.....	119
Chapter 1 Manual Changes.....	119
Chapter 2 Manual Changes.....	119
Chapter 3 Manual Changes:.....	123
Chapter 4 Manual Changes:.....	123
Chapter 5 and 6 Manual Changes.....	123
<b>Blank Front Panel Option 001 .....</b>	<b>125</b>
Introduction.....	125
Troubleshooting.....	125
Chapter 2 Manual Changes:.....	125
Chapter 3 Manual Changes:.....	126
Chapter 5 and 6 Manual Changes:.....	126





# Introduction

---

## Scope

This manual contains information for troubleshooting the Agilent 6030A, 6031A, 6032A, or 6035A 1000 W Autoranging Power Supply to the component level. Wherever applicable, the service instructions given in this manual refer to pertinent information provided in the Operation Manual (P/N 5959-3301). Both manuals cover Agilent Models 6030A/31A/32A/35A; differences between models are described as required.

The following information is contained in this manual.

## Calibration and Verification

Contains calibration procedures for Agilent Models 6030A/31A/32A/35A. Also contains verification procedures that check the operation of the supplies to ensure they meet the specifications of Chapter 1 in the Operating Manual.

## Troubleshooting

Contains troubleshooting procedures to isolate a malfunction to a defective component on the main circuit board or to a defective assembly (front panel, power transformer, or cable assembly). Board and assembly level removal and replacement procedures are also given in this section.

## Principles of Operation

Provides block diagram level descriptions of the supply's circuits. The primary interface, secondary interface, and the power mesh and control circuits are described. These descriptions are intended as an aid in troubleshooting.

## Replaceable Parts

Provides a listing of replaceable parts for all electronic components and mechanical assemblies for Agilent Models 6030A/31A/32A/35A.

## Circuit Diagrams

Contains functional schematics and component location diagrams for all Agilent 6030A/31A/32A/35A circuits. The names that appear on the functional schematics also appear on the block diagrams in Chapter 2. Thus, the descriptions in Chapter 2 can be correlated with both the block diagrams and the schematics.

---

## Safety Considerations

This product is a Safety Class 1 instrument, which means that it is provided with a protective earth terminal. Refer to the Safety Summary page at the beginning of this manual for a summary of general safety information. Safety information for specific procedures is located at appropriate places in the manual.

---

## Manual Revisions

Agilent Technologies instruments are identified by a 10-digit serial number. The format is described as follows: first two letters indicate the country of manufacture. The next four digits are a code that identify either the date of manufacture or of a significant design change. The last four digits are a sequential number assigned to each instrument.

<b>Item</b>	<b>Description</b>
-------------	--------------------

<b>US</b>	The first two letters indicates the country of manufacture, where US = USA.
-----------	---

<b>3648</b>	This is a code that identifies either the date of manufacture or the date of a significant design change.
-------------	---

<b>0101</b>	The last four digits are a unique number assigned to each power supply.
-------------	---

If the serial number prefix on your unit differs from that shown on the title page of this manual, a yellow Manual Change sheet may be supplied with the manual. It defines the differences between your unit and the unit described in this manual. The yellow change sheet may also contain information for correcting errors in the manual.

Note that because not all changes to the product require changes to the manual, there may be no update information required for your version of the supply.

Older serial number formats used with these instruments had a two-part serial number, i.e. 2701A-00101. This manual also applies to instruments with these older serial number formats. Refer to Appendix G for backdating information.

---

## Firmware Revisions

The primary and secondary interface microcomputer chips inside of your supply are identified with labels that specify the revision of the supply's firmware. This manual applies to firmware revisions A.00.00, A.00.01, and A.00.02.

## Calibration and Verification

---

### Introduction

This section provides test and calibration procedures. The operation-verification tests comprise a short procedure to verify that the unit is performing properly, without testing all specified parameters. After troubleshooting and repair of a defective power supply you can usually verify proper operation with the turn-on checkout procedure in the Operating Manual. Repairs to the A1 main board, the A2 control board and the A8 GPIB board can involve circuits which, although functional, may prevent the unit from performing within specified limits. So, after A1, A2 or A8 board repair, decide if recalibration and operation verification tests are needed according to the faults you discover. Use the calibration procedure both to check repairs and for regular maintenance.

When verifying the performance of this instrument as described in this chapter, check only those specifications for which a performance test procedure is included.

---

### Test Equipment Required

Table 2-1 lists the equipment required to perform the tests of this section. You can separately identify the equipment for performance tests, calibration and troubleshooting using the USE column of the table.

---

### Operation Verification Tests

To assure that the unit is performing properly, without testing all specified parameters, first perform the turn-on checkout procedure in the Operating Manual. Then perform the following performance tests, in this section.

- Voltage Programming And Readback Accuracy
- Current Programming And Readback Accuracy
- CV Load Effect
- CC Load Effect

---

### Calibration Procedure

Calibrate the unit twice per year and when required during repair. The following calibration procedures should be performed in the sequence given.

**Note:** Some of the calibration procedures for this instrument can be performed independently, and some procedures must be performed together and/or in a prescribed order. If a procedure contains no references to other procedures, you may assume that it can be performed independently.

To return a serviced unit to specifications as quickly as possible with minimal calibration, the technician need only perform calibration procedures that affect the repaired circuit. Table 2-2 lists various power supply circuits with calibration procedures that should be performed after those circuits are serviced.

If the GPIB board (A8) has been replaced, you must first initialize the board before you can calibrate the unit. Refer to Page 31.

---

**Table 2-1. Test Equipment Required**

TYPE	REQUIRED CHARACTERISTICS	USE	RECOMMENDED MODEL
Oscilloscope	Sensitivity: 1 mV Bandwidth: 20MHz & 100MHz Input: differential, 50 Ω & 10MΩ	P,T	Agilent 54504A
RMS Voltmeter	True rms, 10MHz bandwidth Sensitivity: 1 mV Accuracy: 5%	P	Agilent 3400B
Logic Pulser	4.5 to 5.5Vdc @ 35mA	T	Agilent 546A
Multimeter	Resolution: 100nV Accuracy: 0.0035%, 6½ digit	P,C,T	Agilent 3458A
Signature Analyzer	--	T	Agilent 5004A
GPIB Controller	Full GPIB capabilities	C,T,P	HP Series, 200/300
Current Probe	No saturation at 100A Bandwidth: 20Hz to 15MHz	P	Tek P6303 Probe AM503 Amp TM500 Power Module
Electronic Load	6030A 200 V/5 A 60 V/17A 6031A 20 V/50 A 7 V/120 A 6032A 60 V/17.5 A 20 V/50 A 6035A 500 V/2 A 200 V/5 A	P,C	6050A & 60503A (4) 6050A & 60503A (4) 6050A & 60504A (2) 6050A & 60504A (2) 6050A & 60504A (2) 6050A & 60504A (2) Power Resistor 250Ω 1% 1KW 6050A & 60503A (4)
Current Shunt	0.1Ω/0.04%/15A/25W 0.01Ω/0.04%/100A/100W 0.001Ω/0.04%/300A/100W	P,C	Guildline 9230/15 Guildline 9230/100 Guildline 9230/300
Power Resistors*	6030A 3.5Ω/40Ω 1% 1000 W (min.) 6031A 0.069Ω/0.04Ω 1% 1000W (min.) 6032A 0.4Ω/3.5Ω 1% 1000W (min.) 6035A 40Ω/250Ω 1% 1000W (min.)	P,C	
Calibration and Test Resistors	Value: 100Ω, 5%, 1W 1Ω, 5%, ½W 1KΩ, 5%, ¼W 2KΩ, 0.01%, ¼W	C,T	
Terminating Resistors (2)	Value: 50Ω ±5%, noninductive	P	
Blocking Capacitors (2)	Value: 0.01μF, 100Vdc	P	
Variable Voltage Transformer (autotransformer)	Adjustable from -13% to +6% of input voltage range, 4KVA minimum	P,C	
Isolation Transformer	4KVA minimum	T	
Common-mode Toroidal Core	≥3.7μH/turn <sup>2</sup> ≈23mm I.D.	P	Ferrox-Cube 500T600-3C8, Agilent 9170-0061
DC Power Supply	Voltage range: 0-60Vdc Current range: 0-3Adc	C,T	Agilent 6024A

P = performance testing    C = calibration adjustments    T = troubleshooting

\* Not required if using electronic load.

\*\* Less accurate, and less expensive, current-monitor resistors can be used, but the accuracy to which current programming and readback can be checked must be reduced accordingly.

**Table 2-2. Guide to Recalibration After Repair**

<b>Printed Circuit Board</b>	<b>Block Name</b>	<b>Ref. Desig.</b>	<b>Perform These Procedures</b>
A1 Main Board		R3	Current Monitor Full Scale Calibration Constant Current Full Scale Calibration
A1 Main Board		T1, T2	Power Limit Calibration
A5 Diode Board		CR4	Power Limit Calibration
A2 Control Board	Constant Voltage Circuit (All Except Current Source)	All	Voltage Monitor Zero Calibration Common Mode Calibration Remote Readback Zero Calibration Constant Voltage Full Scale Calibration Voltage Monitor and Remote Readback Full Scale Calibration Constant Voltage Zero Calibration
A2 Control Board	Constant Voltage Circuit (Current Source)	All	Resistance Programming Full Scale Calibration
A2 Control Board	Constant Current Circuit	All	Current Monitor Zero Calibration Constant Current Zero Calibration Current Monitor Full Scale Calibration Constant Current Full Scale Calibration
A2 Control Board	Power Limit Comparator	All	Power Limit Calibration
A2 Control Board	Bias Power Supplies (+ & -15V Supplies)	All	All Calibration procedures
A8 GPIB Board	Voltage Monitor Buffer	All	Voltage Monitor Zero Calibration Remote Readback Zero Calibration Constant Voltage Full Scale Calibration Voltage Monitor and Remote Readback Full Scale Calibration Constant Voltage Zero Calibration
A8 GPIB Board	Analog Multiplexer	All	Remote Readback Zero Calibration Constant Voltage Full Scale Calibration Voltage Monitor and Remote Readback Full Scale Calibration Constant Voltage Zero Calibration
A8 GPIB Board	Readback DAC	All	Remote Readback Zero Calibration Constant Voltage Full Scale Calibration Voltage Monitor and Remote Readback Full Scale Calibration Constant Voltage Zero Calibration

**Table 2-2. Guide to Recalibration After Repair (continued)**

Printed Circuit Board	Block Name	Ref. Desig.	Perform These Procedures
A8 GPIB Board	Voltage DAC	All	Remote Readback Zero Calibration Constant Voltage Full Scale Calibration Voltage Monitor and Remote Readback Full Scale Calibration Constant Voltage Zero Calibration
A8 GPIB Board	Current DAC	All	Constant Current Zero Calibration Constant Current Full Scale Calibration
A8 GPIB Board		U5	Remote Readback Zero Calibration Constant Voltage Full Scale Calibration Voltage Monitor and Remote Readback Full Scale Calibration Constant Voltage Zero Calibration Constant Current Full Scale Calibration

### Initial Setup

- a. Unplug the line cable.
- b. Remove the top cover by removing the two top-rear screws. Slide the cover to the rear, and pull up.
- c. Plug a control board test connector onto the A2J7 card edge fingers.
- d. Turn OVERVOLTAGE ADJUST control A3R72 fully clockwise.
- e. Disconnect all loads from output terminals.
- f. Connect power supply for local sensing, and ensure that MODE switches are set as shown below.



- g. Connect a GPIB controller to the power supply.
- h. Reconnect line cable and turn on ac power.
- i. Allow unit to warm up for 30 minutes with the internal cover on. The cover should remain in place during all calibrations.
- j. When attaching the DVM, the minus lead of the DVM should be connected to the first node listed, and the plus lead should be connected to the second node listed.
- k. At the beginning of each calibration procedure, the power supply should be in its power-on state (turn ac power off and back on), with no external circuitry connected except as instructed.
- l. The POWER LIMIT adjustment (A2R25) must be adjusted at least coarsely before many of the calibration procedures can be performed. If you have no reason to suspect that the Power Limit circuit is out of adjustment, do not change its setting. Otherwise, center A2R25 before you begin to calibrate the power supply.
- m. Turn off ac power when making or removing connections to the power supply.

**WARNING**

Maintenance described herein is performed with power supplied to the instrument, and protective covers removed. Such maintenance should be performed only by service trained personnel who are aware of the hazards involved (for example, fire and electrical shock). Where maintenance can be performed without power applied, the power should be removed.

## Voltage Monitor Zero Calibration

- a. Send string "VSET 0; ISET 0; OUT OFF".
- b. Short power supply output terminals.
- c. Attach the DVM from  $\nabla$  M on the rear panel through a  $1k\Omega$  resistor to A2J7 pin 3 (V-MON buffered).
- d. Adjust A2R22 (V-MON ZERO) to  $0V \pm 20\mu V$ . ( $\pm 40\mu V$  6035A).

## Common Mode Calibration

- a. Send string "VSET 0; ISET 0; OUT OFF".
- b. Short power supply sense terminals (+ S to - S) at rear panel.
- c. Attach the DVM from  $\nabla$  M on the rear panel through a  $1k\Omega$  resistor to A2J7 pin 3 (V-MON buffered).
- d. Take initial reading from DVM.
- e. Remove both local sensing straps from rear-panel terminal block, and connect a 1-volt external power supply with its + lead to - S and its--lead to - Out. See Figure 2-1.
- f. Adjust A2R21 (CV LOAD REG) to Initial Reading
  - $\pm 20\mu V$  (6030A)
  - $\pm 80\mu V$  (6031A)
  - $\pm 20\mu V$  (6032A)
  - $\pm 40\mu V$  (6035A)
- g. Replace local sense straps after removing external power supply.

---

**Note:** Common mode calibration is not required for Agilent Model 6035A.

---

## Remote Readback Zero Calibration

---

**Note:** This procedure and the following three procedures must be done as a set, without omitting any of the four procedures. Also, the following four procedures require that V-MON ZERO (A2R22) be adjusted within specifications. If it is not, perform the Voltage Monitor Zero Calibration before proceeding.

---

- a. Connect an external supply to the power supply as shown in Figure 2-2.
- b. Send string "VSET 0; ISET 5; OUT ON".
- c. Attach the DVM from  $\nabla$  M on the rear panel through a  $1K\Omega$  resistor to A2J7 pin 3 (V-MON buffered).
- d. Adjust A8R40 (CV PROG ZERO) to  $625\mu V \pm 30\mu V$ .
- e. Remove the DVM.
- f. Enter and run the following program and begin noting the controller's display:
  - 10 OUTPUT 705; "VOUT"
  - 20 ENTER 705; A
  - 30 DISP A
  - 40 GOTO 10
  - 50 END

- g. Adjust A8R51 (READBACK ZERO) until the value displayed on the controller toggles between:
  - 0 and 50mV (6030A)
  - 0 and 5mV (6031A)
  - 0 and 15mV (6032A)
  - 0 and 125mV (6035A)
- h. After adjusting A8R51 you must continue the calibration procedure through to the completion of Constant Voltage Zero Calibration. Remember to disconnect the external power supply and resistor.

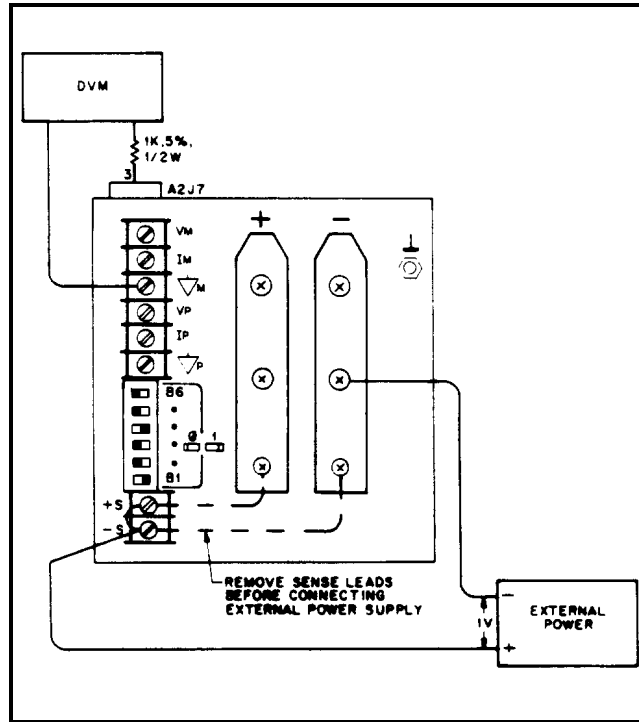

Figure 2-1. Common Mode Setup

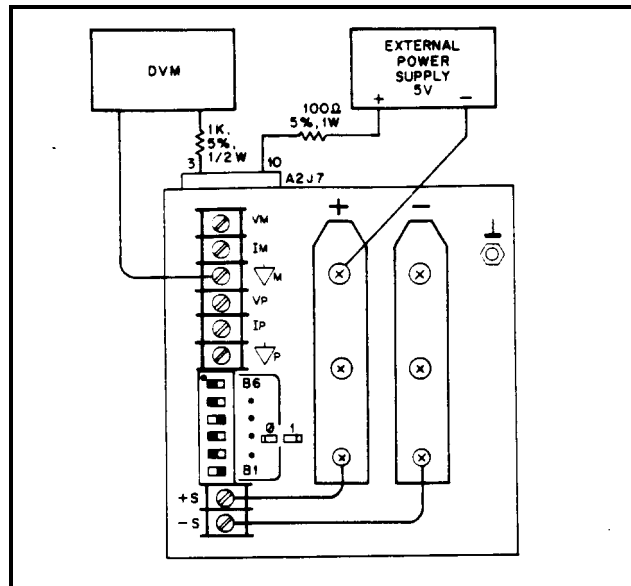

Figure 2-2. Remote Readback Zero And CV Zero Calibration Setup



## Constant Voltage Full Scale Calibration

---

**Note:** Perform this procedure only after completing Remote Readback Zero Calibration.

---

- a. Remove all external test circuits.
- b. Send string:  
"VSET 200; ISET 5; OUT ON" (6030A)  
"VSET 20; ISET 5; OUT ON" (6031A)  
"VSET 60; ISET 5; OUT ON" (6032A)  
"VSET 500; ISET 5; OUT ON" (6035A)
- c. Attach the DVM from - S to + S terminals on rear panel.
- d. Adjust A8R58 (CV PROG F.S.) to:  
200.025  $\pm$ 6mV (6030A)  
20.0025  $\pm$ 0.6mV (6031A)  
60.0075  $\pm$ 1.82mV (6032A)  
500.063  $\pm$ 6mV (6035A)
- e. After adjusting A8R58 you must continue the calibration procedure through to the completion of Constant Voltage Zero Calibration.

## Voltage Monitor and Remote Readback Full Scale Calibration

---

**Note:** Perform this procedure only after completing Constant Voltage Full Scale Calibration.

---

- a. Attach the DVM from  $\nabla$  M on the rear panel to A2J7 pin 3 (V-MON buffered). See DVM connection in Figure 2-1.
- b. Send string:  
"VSET 200; ISET 5; OUT ON" (6030A)  
"VSET 20; ISET 5; OUT ON" (6031A)  
"VSET 60; ISET 5; OUT ON" (6032A)  
"VSET 500; ISET 5; OUT ON" (6035A)
- c. Adjust A8R75 (V-MON F.S.) to 5.000625V  $\pm$ 100 $\mu$ V.
- d. Disconnect the DVM.
- e. Enter and run the following program and begin noting the controller's display.  
10 OUTPUT 705; "VOUT?"  
20 ENTER 705; A  
30 DISP A  
40 GOTO 10  
50 END
- f. Adjust A8R61 (READBACK F.S.) until the value displayed on the controller toggles between:  
200.000 and 200.050 Vdc (6030A)  
20.000 and 20.005 Vdc (6031A)  
60.000 and 60.015 Vdc (6032A)  
500.000 and 500.125 Vdc (6035A)
- g. After adjusting A8R61 you must continue the calibration procedure through to the completion of Constant Voltage Zero Calibration.

## Constant Voltage Zero Calibration

**Note:** Perform this procedure only after completing Voltage Monitor and Remote Readback Full Scale Calibration.

- Send string "VSET 0; ISET 5; OUT ON".
- Connect an external supply to the power supply as shown in Figure 2-2.
- Attach the DVM from - S to + S on the rear panel.
- Adjust A8R40 (CV PROG ZERO) to  $0 \pm 120\mu\text{V}$ .

## Current Monitor Zero Calibration

- Send string "VSET 0; ISET 0; OUT OFF".
- Connect a short across power supply output terminals.
- Attach the DVM from  $\nabla$  M to IM on the rear panel.
- Allow several minutes (3 or more) to ensure thermal settling.
- Adjust A2R8 (I-MON ZERO) to  $0 \pm 100\mu\text{V}$ .

## Constant Current Zero Calibration

- Connect the test setup shown in Figure 2-3.
- Send string "VSET 5; ISET 0; OUT ON".
- Allow several minutes (3 or more) to ensure thermal settling.
- Adjust A8R29 (CC PROG ZERO) to:  
 $0\text{V} \pm 0.6\text{mV}$  (6030A, 6035A)  
 $0\text{V} \pm 8.0\text{mV}$  (6031A)  
 $0\text{V} \pm 1.7\text{mV}$  (6032A)

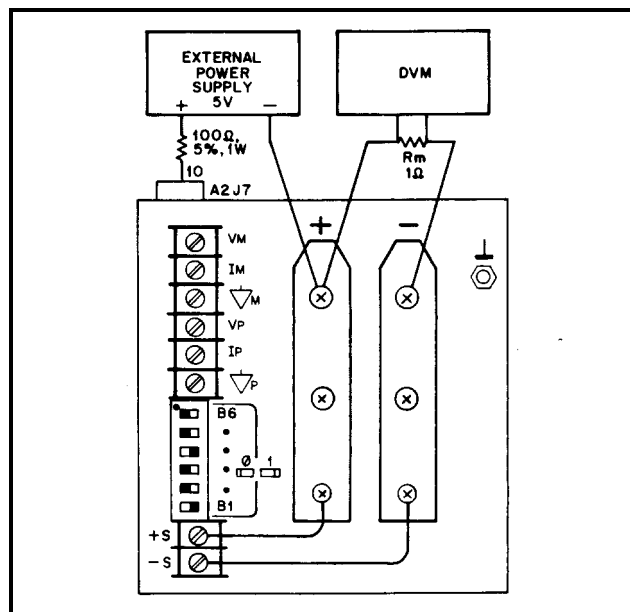

Figure 2-3. CC Zero Calibration Setup

## Current Monitor Full Scale Calibration

---

**Note:** This procedure requires that I-MON ZERO (A2R8) be adjusted within specifications. If it is not, perform the Current Monitor Zero Calibration before proceeding.

---

- a. Connect Rm current-monitoring shunt:  
(1 milliohm, 6031A)  
(10 milliohm, 6030A, 6032A)  
(100 milliohm, 6035A)  
0.05% or better across power supply output terminals.
- b. Send string:  
"VSET 5; ISET 17; OUT ON" (6030A)  
"VSET 5; ISET 120; OUT ON" (6031A)  
"VSET 5; ISET 50; OUT ON" (6032A)  
"VSET 5; ISET 5; OUT ON" (6035A)
- c. Attach DVM from  $\nabla$  M to IM on the rear panel. Use six-digit display on Agilent 3458A DVM.
- d. Take initial reading from DVM.
- e. Attach DVM across Rm. Allow several minutes (3 or more) to ensure thermal settling. This can be noted as a stable reading on the DVM.
- f. Adjust A2R9 (I-MON F.S.) to:  
0.034 \* initial reading  $\pm 33.5\mu\text{V}$  (6030A)  
0.024 \* initial reading  $\pm 80.0\mu\text{V}$  (6031A)  
0.100 \* initial reading  $\pm 0.4\text{mV}$  (6032A)  
0.100 \* initial reading  $\pm 67.0\mu\text{V}$  (6035A)

## Constant Current Full Scale Calibration

---

**Note:** This procedure requires that CC PROG ZERO (A8R29) and I-MON F. S. (A2R9) be adjusted within specifications. If they are not, perform Constant Current Zero and/or Current Monitor Full Scale Calibration before proceeding.

---

- a. Connect Rm current-monitoring shunt:  
( 1 milliohm, 6031A)  
( 10 milliohm, 6030A, 6032A)  
(100 milliohm, 6035A)  
0.05% or better across power supply output terminals.
- b. Send string:  
"VSET 5; ISET 17; OUT ON" (6030A)  
"VSET 5; ISET 120; OUT ON" (6031A)  
"VSET 5; ISET 50; OUT ON" (6032A)  
"VSET 5; ISET 5; OUT ON" (6035A)
- c. Attach DVM across Rm. Allow several minutes (3 or more) to ensure thermal settling.
- d. Adjust A8R55 (CC PROG F.S.) to:  
1.70V  $\pm 0.1\text{mV}$  (6030A)  
0.12V  $\pm 3.0\mu\text{V}$  (6031A)  
0.50V  $\pm 30\mu\text{V}$  (6032A)  
0.50V  $\pm 40\mu\text{V}$  (6035A)

## Power Limit Calibration

---

**Note:** This procedure requires that CC PROG F. S. (A8R55) be adjusted within specifications. If it is not, perform Constant Current Full Scale Calibration before proceeding.

---

- a. Connect the power supply to the ac power line through a variable autotransformer. Connect a DVM across the input power rails, with the + lead to the rear of A1R3 and the - lead to the rear of A1R1. Adjust the autotransformer for 240Vdc on the input power rail. The input power rail must be maintained at 240Vdc during calibration.

---

**WARNING**

The top inside cover must be removed to connect the DVM. Disconnect the ac mains power cord before connecting or disconnecting the DVM.

---

- a. Connect a electronic load across the output terminals, or use a:
  - 3.8 ohm 1500W resistor (6030A)
  - 0.066 ohm 1500W resistor (6031A)
  - 0.44 ohm 1500 W resistor (6032A)
  - 39 ohm 1500 W resistor (6035A)
- b. Set the electronic load for:
  - 17 amperes (6030A)
  - 120 amperes (6031A)
  - 51 amperes (6032A)
  - 5 amperes (6035A)in the constant Current mode.
- c. Turn A2R25 (LOWER KNEE) fully counterclockwise.
- d. Turn on power supply and send string:
  - "VSET 65; ISET 17.4; OUT ON" (6030A)
  - "VSET 8; ISET 121; OUT ON" (6031A)
  - "VSET 22; ISET 51; OUT ON" (6032A)
  - "VSET 200; ISET 5.1; OUT ON" (6035A)
- e. Adjust A2R25 (LOWER KNEE) clockwise until CV LED on front panel turns on. Power supply output should be:
  - 65  $\pm$ 0.2V @17A in CV mode (6030A)
  - 8  $\pm$ 0.08V @120A in CV mode (6031A)
  - 22  $\pm$ 0.2V @50A in CV mode (6032A)
  - 200  $\pm$ 0.5V @5A in CV mode (6035A)
- f. Turn off power supply. Reset the electronic load for:
  - 5.25A in CC mode (6030A)
  - 51A in CC mode (6031A)
  - 18.2A in CC mode (6031A)
  - 2.2A in CC mode (6035A)or change the resistor to:
  - 38ohm 1500W (6033A)
  - 0.4ohm 1500W (6031A)
  - 3.3ohm 1500W(6032A)
  - 227ohm 1500W(6035A)
- g. Turn A2R26 (UPPER KNEE) fully counterclockwise.
- h. Turn on power supply. Send string
  - "VSET 200; ISET 5.5; OUT ON" (6030A)
  - "VSET 20.5; ISET 55; OUT ON" (6031A)
  - "VSET 60; ISET 19; OUT ON" (6032A)
  - "VSET 500; ISET 2.2; OUT ON" (6035A)

- i. Adjust A2R26 (UPPER KNEE) clockwise until front panel CV LED turns on. Power supply output should be:
  - 200  $\pm$ 0.4V @5.25A in CV mode (6030A)
  - 20.5  $\pm$ 0.5V @55A in CV mode (6031A)
  - 60  $\pm$ 0.4V @18.2A in CV mode (6032A)
  - 500  $\pm$ 0.4V @2.2A in CV mode (6035A)

## Resistance Programming Full Scale Calibration

- a. Send string "OUT OFF".
- b. Connect a 2K ohm calibration resistor from  $\nabla$  P to VP on rear panel.
- c. Set rear-panel MODE switches for resistance programming:

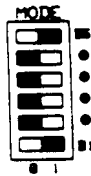

- d. Attach the DVM from  $\nabla$  P to VP on the rear panel.
- e. Adjust A2R23 (R-PROG F.S.) to 2.5V  $\pm$ 4mV.
- f. Remember to reset MODE switches to original settings.

---

## Performance Tests

The following paragraphs provide test procedures for verifying the unit's compliance with the specifications of Table 1-1 in the Operating Manual. Please refer to CALIBRATION PROCEDURE or TROUBLESHOOTING if you observe out-of-specification performance. The performance test specifications are listed in the Performance Test Record in Appendix C through F. You can record the actual measured values in the columns provided.

## Measurement Techniques

**Setup For All Tests.** Measure the output voltage directly at the + S and - S terminals. Connect unit for local sensing, and ensure that MODE switches are set as shown below. Select an adequate wire gauge for load leads using the procedures given in the Operating Manual for connecting the load.

**Electronic Load.** The test and calibration procedures use an electronic load to test the unit quickly and accurately. If an electronic load is not available, you may substitute:

- 40 $\Omega$  1000W load resistor (6030A)
- 0.4 $\Omega$  1000W load resistor (6031A)
- 3.5 $\Omega$  1000W load resistor (6032A)
- 250 $\Omega$  1000W load resistor (6035A)

for the electronic load in these tests:

- CV Source Effect (Line Regulation)
- CC Load Effect (Load Regulation)

You may substitute:

- 3.5 $\Omega$  1000W load resistor (6030A)
- 0.069 $\Omega$  1000W load resistor (6031A)
- 0.4 $\Omega$  1000W load resistor (6032A)
- 40 $\Omega$  1000W load resistor (6035A)

in these tests:

- CV Load Effect (Load Regulation)
- CV PARD (Ripple and Noise)
- CC Source Effect (Line Regulation)
- CC PARD (Ripple and Noise)

The substitution of the load resistor requires adding a load switch and making minor changes to the procedures. The load transient recovery time test procedure is not amenable to modification for use with load resistors.

An electronic load is considerably easier to use than a load resistor. It eliminates the need for connecting resistors or rheostats in parallel to handle the power, it is much more stable than a carbon-pile load, and it makes easy work of switching between load conditions as is required for the load regulation and load transient-response tests.

**Current-Monitoring Resistor.** To eliminate output current measurement error caused by voltage drops in the leads and connections, connect the current-monitoring resistor between -OUT and the load as a four-terminal device. Figure 2-4 shows correct connections. Connect the current-monitoring test leads inside the load-lead connections directly at the monitoring resistor element.

---

**Note:** A current-monitoring resistor with 1% accuracy is suitable for all tests except current programming accuracy and current readback accuracy. For these tests, use the shunt listed in Table 2-1.

---

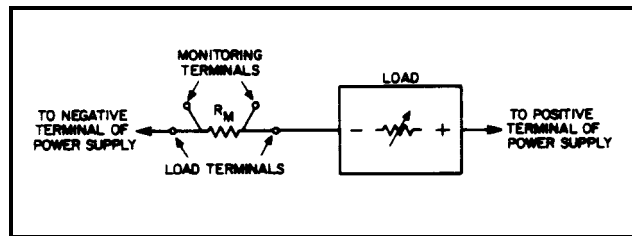

**Figure 2-4. Current-Monitoring Resistor Setup**

**GPIB Controller.** Most performance tests can be performed using only front-panel controls. However, a GPIB controller is required to perform the voltage and current programming accuracy tests and the voltage and current readback accuracy tests.

## Constant Voltage (CV) Tests

**CV Setup.** If more than one meter or a meter and an oscilloscope are used, connect each to the + S and - S terminals by a separate pair of leads to avoid mutual coupling effects. Connect only to + S and -S because the unit regulates the output voltage between + S and - S, not between + OUT and -OUT. Use coaxial cable or shielded 2-wire cable to avoid pickup on test leads. For all CV tests set the output current at full output to assure CV operation.

**Voltage Programming And Readback Accuracy.** This procedure verifies that the voltage programming and readback functions are within specifications. A GPIB controller must be used for this test.

- a. Connect digital voltmeter between + S and - S.
- b. Turn on ac power to the power supply.
- c. Send string:  
"VSET 0.5; ISET 17" (6030A)

"VSET 0.1; ISET 120" (6031A)

"VSET 0.09; ISET 50" (6032A)

"VSET 1.0; ISET 5" (6035A)

- d. The DVM reading should be in the range:

0.354 to 0.645Vdc (6030A)

0.085 to 0.115Vdc (6031A)

0.050 to 0.130Vdc (6032A)

0.598 to 1.400Vdc (6035A)

Note the reading.

- e. Enter and run the following program:

```
10 OUTPUT 705; "VOUT?"
```

```
20 ENTER 705;A
```

```
30 DISP A
```

```
40 GOTO 10
```

```
50 END
```

- f. The value displayed by the controller should be the value noted in step d:

$\pm 0.080$ Vdc (6030A)

$\pm 0.007$ Vdc (6031A)

$\pm 0.020$  Vdc (6032A)

$\pm 0.205$  Vdc (6035A)

- g. Send string:

"VSET 200; ISET 17" (6030A)

"VSET 20; ISET 120" (6031A)

"VSET 60; ISET 50" (6032A)

"VSET 500; ISET 5" (6035A)

- h. The DVM reading should be in the range:

199.785 to 200.215Vdc (6030A)

19.978 to 20.022Vdc (6031A)

59.939 to 60.061 Vdc (6032A)

498.350 to 501.650 Vdc (6035A)

Note the reading.

- i. Run the program listed in step e. The value displayed by the controller should be the value noted in step h:

$\pm 0.240$ Vdc (6030A)

$\pm 0.023$  Vdc (6031A)

$\pm 0.068$  Vdc (6032A)

$\pm 2.700$  Vdc (6035A)

**Load Effect (Load Regulation).** Constant-voltage load effect is the change in dc output voltage ( $E_o$ ) resulting from a load-resistance change from open-circuit to full-load. Full-load is the resistance which draws the maximum rated output current at voltage  $E_o$ . Proceed as follows:

- a. Connect the test equipment as shown in Figure 2-5. Operate the load in constant resistance mode (Amps/Volt) and set resistance to maximum.

- b. Turn the unit's power on, and, using DISPLAY SETTINGS pushbutton switch, turn up current setting to full output.

- c. Turn up output voltage to:

60Vdc (6030A)

7.0Vdc (6031A)

20.0Vdc (6032A)

200Vdc (6035A)

as read on the digital voltmeter.

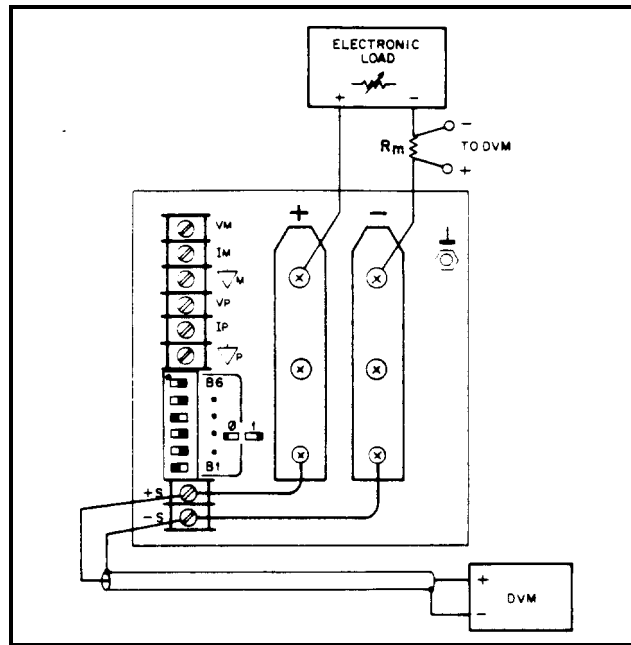

**Figure 2-5. Basic Test Setup**

- d. Reduce the resistance of the load to draw an output current of:
  - 17.0A<sub>dc</sub> (6030A)
  - 120A<sub>dc</sub> (6031A)
  - 50 A<sub>dc</sub> (6032A)
  - 5.0 A<sub>dc</sub> (6035A)
 Check that the unit's CV LED remains lighted.
- e. Open-circuit the load.
- f. Record the output voltage at the digital voltmeter.
- g. Reconnect the load.
- h. When the reading settles, record the output voltage again. Check that the two recorded readings differ no more than:
  - $\pm 0.011$  V<sub>dc</sub> (6030A)
  - $\pm 0.0037$  V<sub>dc</sub> (6031A)
  - $\pm 0.007$  V<sub>dc</sub> (6032A)
  - $\pm 0.033$  V<sub>dc</sub> (6035A)

**Source Effect (Line Regulation).** Source effect is the change in dc output voltage resulting from a change in ac input voltage from the minimum to the maximum value as specified in Input Power Requirements in the Specifications Table, in the Operating Manual. Proceed as follows:

- a. Connect the test equipment as shown in Figure 2-5. Operate the load in constant resistance mode (Amps/Volt) and set resistance to maximum.
- b. Connect the unit to the ac power line through a variable autotransformer which is set for nominal line voltage.
- c. Turn the unit's power on, and, using DISPLAY SETTINGS pushbutton switch, turn up current setting to full output.
- d. Turn up output voltage to:
  - 200V<sub>dc</sub> (6030A)
  - 20.0V<sub>dc</sub> (6031A)
  - 60.0V<sub>dc</sub> (6032A)
  - 500V<sub>dc</sub> (6035A)
 as read on the digital voltmeter.



- e. Reduce the resistance of the load to draw an output current of:
  - 5.0A<sub>dc</sub> (6030A)
  - 50 A<sub>dc</sub> (6031A)
  - 16.5 A<sub>dc</sub> (6032A)
  - 2.0 A<sub>dc</sub> (6035A)
 Check that the unit's CV LED remains lighted.
- f. Adjust autotransformer to the minimum for your line voltage.
- g. Record the output voltage at the digital voltmeter.
- h. Adjust autotransformer to the maximum for your line voltage.
- i. When the reading settles record the output voltage again. Check that the two recorded readings differ no more than:
  - ± 0.011V<sub>dc</sub> (6030A)
  - ± 0.004V<sub>dc</sub> (6031A)
  - ± 0.009V<sub>dc</sub> (6032A)
  - ± 0.063V<sub>dc</sub> (6035A)

**PARD (Ripple And Noise).** Periodic and random deviations (PARD) in the unit's output-ripple and noise-combine to produce a residual ac voltage superimposed on the dc output voltage. Constant-voltage PARD is specified as the root-mean-square (rms) or peak-to-peak (pp) output voltage in a frequency range of 20 Hz to 20 MHz.

**RMS Measurement Procedure.** Figure 2-6 shows the interconnections of equipment to measure PARD in V<sub>rms</sub>. To ensure that there is no voltage difference between the voltmeter's case and the unit's case, connect both to the same ac power outlet or check that the two ac power outlets used have the same earth-ground connection.

Use the common-mode choke as shown to reduce ground-loop currents from interfering with measurement. Reduce noise pickup on the test leads by using 50Ω coaxial cable, and wind it five turns through the magnetic core to form the common-mode choke. Proceed as follows:

- a. Connect the test equipment as shown in Figure 2-6. Operate the load in constant resistance mode (Amps/Volt) and set resistance to maximum.
- b. Turn the unit's power on, and, using DISPLAY SETTINGS pushbutton switch, turn up current setting to full output.
- c. Turn up output voltage to:
  - 60V<sub>dc</sub> (6030A)
  - 7V<sub>dc</sub> (6031A)
  - 20V<sub>dc</sub> (6032A)
  - 200V<sub>dc</sub> (6035A)
- d. Reduce the resistance of the load to draw an output current of:
  - 17.0A<sub>dc</sub> (6030A)
  - 120A<sub>dc</sub> (6031A)
  - 50A<sub>dc</sub> (6032A)
  - 5.0A<sub>dc</sub> (6035A)
 Check that the unit's CV LED remains lighted.
- e. Check that the rms noise voltage at the true rms voltmeter is no more than:
  - 22mV rms (6030A)
  - 8 mV rms (6031A)
  - 6 mV rms (6032A)
  - 50 mV rms (6035A)

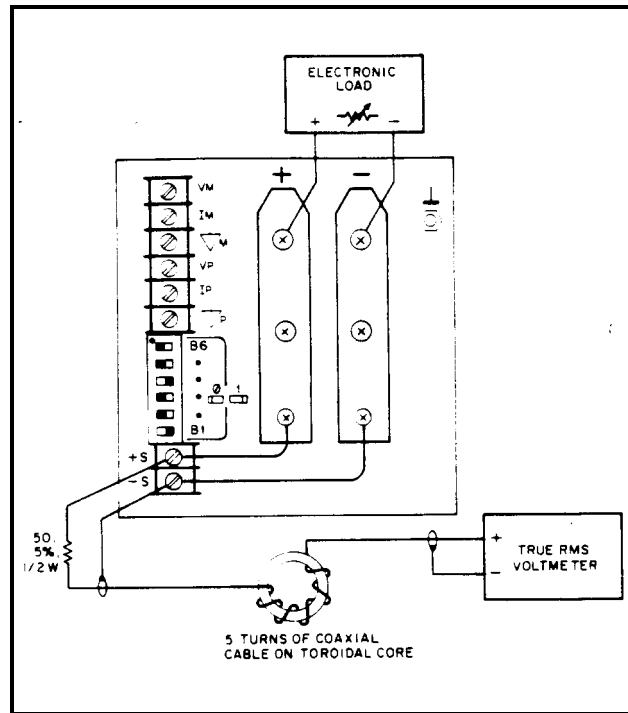

**Figure 2-6. RMS Measurement Test Setup, CV PARD Test**

**Peak Measurement Procedure.** Figure 2-7 shows the interconnections of equipment to measure PARD in  $V_{pp}$ . The equipment grounding and power connection instructions of Paragraph 2-36 apply to this setup also. Connect the oscilloscope to the + S and - S terminals through  $0.01\mu\text{F}$  blocking capacitors to protect the oscilloscope's input from the unit's output voltage. To reduce common-mode noise pickup, set up the oscilloscope for a differential, two-channel voltage measurement. To reduce normal-mode noise pickup, use matched-length, 1 meter or shorter,  $50\Omega$  coaxial cables with shields connected to the oscilloscope case and to each other at the other ends. Proceed as follows:

- a. Connect the test equipment as shown in Figure 2-7. Operate the load in constant resistance mode (Amps/Volt) and set resistance to maximum.
- b. Turn the unit's power on, and, using DISPLAY SETTINGS pushbutton switch, turn up current setting to full output.
- c. Turn up output voltage to:
  - 60Vdc (6030A)
  - 7Vdc (6031A)
  - 20Vdc (6032A)
  - 200 Vdc (6035A)
- d. Turn up output current setting to full output and reduce the resistance of the load to draw an output current of:
  - 17.0A dc (6030A)
  - 120A dc (6031A)
  - 50A dc (6032A)
  - 5.0A dc (6035A)
 Check that the unit's CV LED remains lighted.
- e. Set the oscilloscope's input impedance to  $50\Omega$  and bandwidth to 20MHz. Check that the peak-to-peak is no more than:
  - 50mV (6030A/31A)
  - 40mV (6032A)
  - 160mV (6035A)

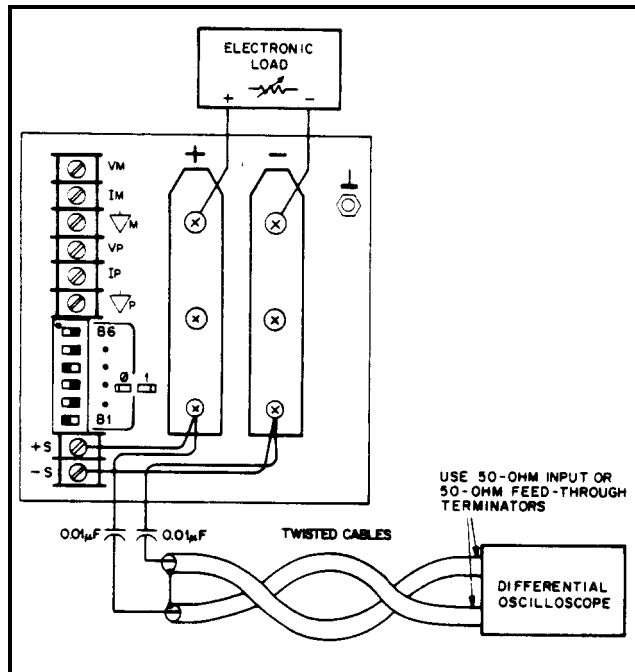

**Figure 2-7. Peak-To-Peak Measurement Test Setup, CV PARD Test**

**Load Transient Recovery Time.** Specified for CV operation only; load transient recovery time is the time for the output voltage to return to within a specified band around its set voltage following a step change in load.

Use the equipment setup of Figure 2-5 to display output voltage transients while switching the load between 10% with the output set at:

- 60Vdc (6030A)
- 7Vdc (6031A)
- 20Vdc (6032A)
- 200Vdc (6035A)

Proceed as follows:

- a. Connect the test equipment as shown in Figure 2-5. Operate the load in constant-current mode and set for minimum current.
- b. Turn the unit's power on, and, using DISPLAY SETTINGS pushbutton switch, turn up current setting to full output.
- c. Turn up output voltage to:
  - 60Vdc (6030A)
  - 7Vdc (6031A)
  - 20.0Vdc (6032A)
  - 200Vdc (6035A)
 as read on the digital voltmeter.
- d. Set the load to vary the load current between:
  - 15.3 and 17Adc (6030A)
  - 108 and 120Adc (6031A)
  - 45 and 50Adc (6032A)
  - 4.5 and 5.0 Adc (6035A)
 at a 30Hz rate for the 10% RECOVERY TEST.
- e. Set the oscilloscope for ac coupling, internal sync and lock on either the positive or negative load transient.
- f. Adjust the oscilloscope to display transients as in Figure 2-8.

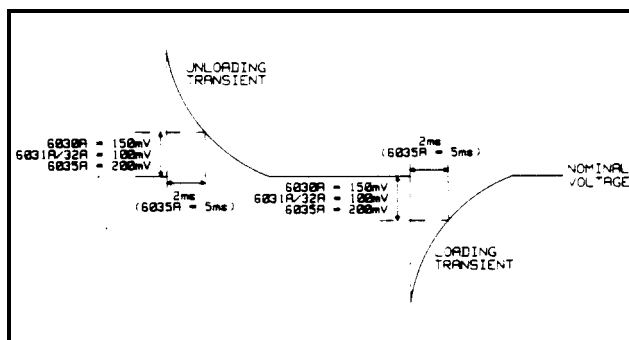

**Figure 2-8. Load Transient Recovery Waveform**

- g. Check that the amplitude of the transient pulse at 1 ms is no more than:
- 150mV/2ms (6030A)
  - 100mV/2ms (6031A)
  - 100mV/2ms (6032A)
  - 200mV/5ms (6035A)

## Constant Current (CC) Tests

**CC Setup.** Constant-current tests are analogous to constant-voltage tests, with the unit's output short circuited and the voltage set to full output to assure CC operation. Follow the general setup instructions of Pages 21 and 22.

**Current Programming And Readback Accuracy.** This procedure verifies that the current programming and readback functions are within specifications. A GPIB controller must be used for this test. The accuracy of the current shunt resistor ( $R_m$ ) must be 0.02% or better. Proceed as follows:

- a. Connect test setup shown in Figure 2-5, except replace the load with a short circuit.
- b. Turn on ac power to the power supply.
- c. Send string:
  - "VSET 200; ISET 0.5" (6030A)
  - "VSET 20; ISET 0.5" (6031A)
  - "VSET 60; ISET 0.5" (6032A)
  - "VSET 500; ISET 0.10" (6035A)
- d. Check that the voltage across  $R_m$  is in the range:
  - 4.75 to 5.25mV (6030A)
  - 248 to 751 $\mu$ V (6031A)
  - 4.14 to 5.86mV (6032A)
  - 1.5 to 18.5mV (6035A)
 Note the reading.
- e. Enter and run the following program:
 

```
10 OUTPUT 705; "IOUT?"
20 ENTER 705; A
30 DISP A
40 GOTO 10
50 END
```
- f. The value displayed by the controller should be the actual output current:
  - $\pm$  17mA (6030A)
  - $\pm$  102mA (6031A)
  - $\pm$  36mA (6032A)
  - $\pm$  50 mA (6035A)

- g. Send string:
  - "VSET 200; ISET 17" (6030A)
  - "VSET 20; ISET 120" (6031A)
  - "VSET 60; ISET 50" (6032A)
  - "VSET 500; ISET 5" (6035A)
- h. Check that the voltage across  $R_m$  is in the range:
  - 169.72 to 170.28mV (6030A)
  - 119.4 to 120.55mV (6031A)
  - 498.1 to 501.8 mV (6032A)
  - 490 to 510 mV (6035A)
 Note the reading.
- i. Run the program listed in step e.
- j. The value displayed by the controller should be the actual output current:
  - $\pm 76\text{mA}$  (6030A)
  - $\pm 580\text{mA}$  (6031A)
  - $\pm 215\text{mA}$  (6032A)
  - $\pm 75\text{mA}$  (6035A)

**Load Effect (Load Regulation).** Constant current load effect is the change in dc output current ( $I_o$ ) resulting from a load-resistance change from short-circuit to full-load, or full-load to short-circuit. Full-load is the resistance which develops the maximum rated output voltage at current  $I_o$ . Proceed as follows:

- a. Connect the test equipment as shown in Figure 2-5. Operate the load in constant resistance mode (Amps/Volt) and set resistance to minimum.
- b. Turn the unit's power on, and, using DISPLAY SETTINGS pushbutton switch, turn up voltage setting to full output.
- c. Turn up output current to:
  - 5.0Adc (6030A)
  - 50Adc (6031A)
  - 16.5Adc (6032A)
  - 2.0Adc (6035A)
- d. Increase the load resistance until the output voltage at +S and -S decreases to:
  - 200Vdc (6030A).
  - 20Vdc (6031A).
  - 60Vdc (6032A)
  - 500Vdc (6035A)
 Check that the CC LED is lighted and AMPS display still reads  $\approx$  current setting.
- e. Short-circuit the load and allow the voltage across  $R_m$  to stabilize.
- f. Record voltage across  $R_m$ .
- g. Disconnect short across load.
- h. When the reading settles ( $\approx 10\text{s}$ ), record the voltage across  $R_m$  again. Check that the two recorded readings differ no more than:
  - $\pm 10\text{mA}$  (6030A)
  - $\pm 20\text{mA}$  (6031A)
  - $\pm 11\text{mA}$  (6032A)
  - $\pm 34\text{mA}$  (6035A)

**Source Effect (Line Regulation).** Constant current source effect is the change in dc output current resulting from a change in ac input voltage from the minimum to the maximum values listed in the Specifications Table in the Operating Manual. Proceed as follows:

- a. Connect the test equipment as shown in Figure 2-5. Operate the load in constant resistance mode (Amps/Volt) and set resistance to minimum.
- b. Connect the unit to the ac power line through a variable autotransformer set for nominal line voltage.
- c. Switch the unit's power on and turn up output voltage setting to full output.

- d. Turn up output current to:
  - 17.0A<sub>dc</sub> (6030A)
  - 120A<sub>dc</sub> (6031A)
  - 50A<sub>dc</sub> (6032A)
  - 5.0 A<sub>dc</sub> (6035A)
- e. Increase the load resistance until the output voltage between + S and - S decreases to:
  - 60V<sub>dc</sub> (6030A)
  - 7.0V<sub>dc</sub> (6031A)
  - 20.0V<sub>dc</sub> (6032A)
  - 200 V<sub>dc</sub> (6035A)
 Check that the CC LED is still on.
- f. Adjust autotransformer to the minimum for your line voltage.
- g. Record the voltage across R<sub>m</sub>.
- h. Adjust autotransformer to the maximum for your line voltage.
- i. When the reading settles record the voltage across R<sub>m</sub> again. Check that the two recorded readings differ no more than:
  - 6mA (6030A)
  - 37mA (6031A)
  - 15mA (6032A)
  - 18 mA (6035A)

**PARD Ripple And Noise.** Periodic and random deviations (PARD) in the unit's output (ripple and noise) combine to produce a residual ac current as well as an ac voltage super-imposed on the dc output. The ac voltage is measured as constant-voltage PARD, Page 23. Constant-current PARD is specified as the root-mean-square (rms) output current in a frequency range 20Hz to 20MHz with the unit in CC operation. To avoid incorrect measurements, with the unit in CC operation, caused by the impedance of the electronic load at noise frequencies, use a:

- 3.5Ω (6030A)
- 0.069Ω (6031A)
- 0.4Ω (6032A)
- 40Ω (6035A)

load resistor that is capable of safely dissipating 1000 watts. Proceed as follows:

- a. Connect the test equipment as shown in Figure 2-9.

---

**Note:** For Agilent 6031A units, use a 30A<sub>dc</sub> power supply in the test setup to subtract from the 120A<sub>dc</sub> of the Agilent 6031A unit under test. This will prevent the current probe specified in Table 2-1 from saturating. Make sure the rms noise of the 30A<sub>dc</sub> supply is less than 10mA rms.

---

- b. Switch the unit's power on and turn the output voltage all the way up.
- c. Turn up output current to:
  - 17.0A<sub>dc</sub> (6030A)
  - 120A<sub>dc</sub> (6031A)
  - 50 A<sub>dc</sub> (6032A)
  - 5.0 A<sub>dc</sub> (6035A)
 Check that the unit's CC LED remains lighted.
- d. Check that the rms noise current measured by the current probe and rms voltmeter is no more than:
  - 15mA rms (6030A).
  - 120mA rms (6031A)
  - 25mA rms (6032A)
  - 50 mA rms (6035A)

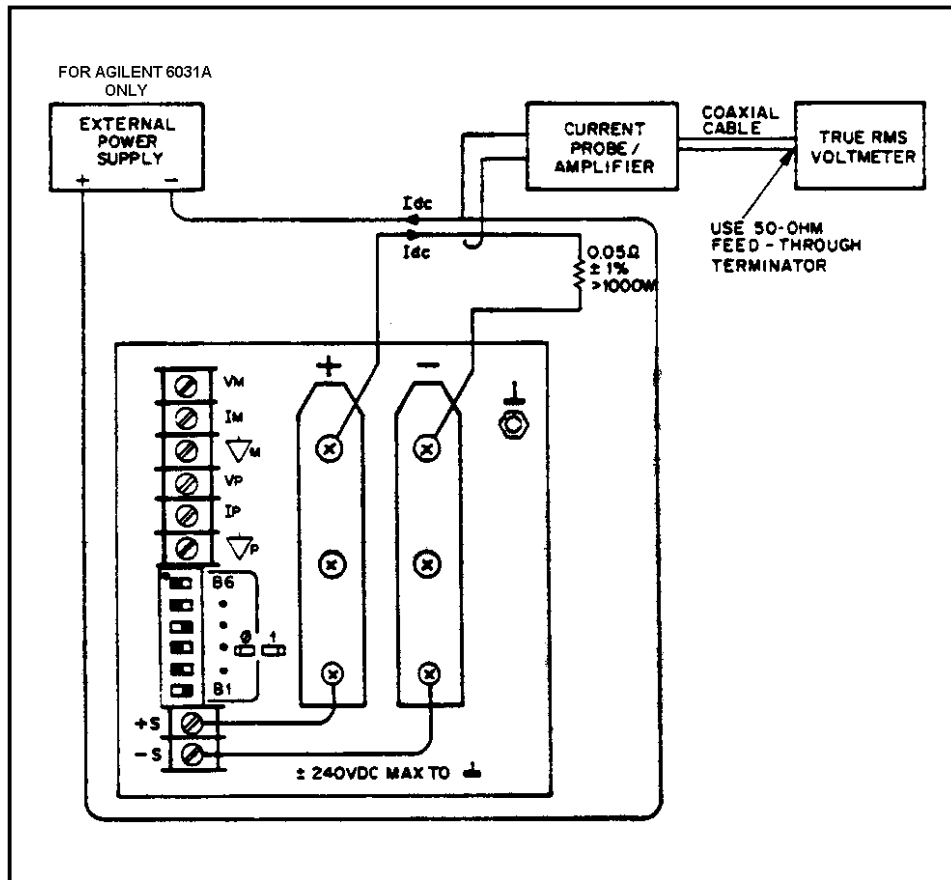

Figure 2-9. CC PARD Test Setup

## Initialization Procedure

Follow the procedure if either the GPIB assembly has been replaced, or the EEPROM (U70) has been replaced:

1. Install the GPIB assembly in the unit.
2. Turn the power on and depending on your unit's model number, send string:  
 "EEINIT 6030"  
 "EEINIT 6031"  
 "EEINIT 6032"  
 or  
 "EEINIT 6035"
3. Turn the power off, wait 5 seconds, then turn the power back on.
4. If the GPIB assembly has been replaced, calibrate the unit.





## Troubleshooting

### WARNING

Maintenance described herein is performed with power supplied to the instrument, and protective covers removed. Such maintenance should be performed only by service-trained personnel who are aware of the hazards involved (for example, fire and electrical shock). Where maintenance can be performed without power applied, the power should be removed.

### Introduction

Before attempting to troubleshoot this instrument, ensure that the fault is with the instrument itself and not with an associated circuit. The performance test enables this to be determined without having to remove the covers from the supply.

The most important aspect of troubleshooting is the formulation of a logical approach to locating the source of trouble. A good understanding of the principles of operation is particularly helpful, and it is recommended that Chapter 4 of this manual be reviewed before attempting to troubleshoot the unit. Often the user will then be able to isolate a problem simply by using the operating controls and indicators. Once the principles of operation are understood, refer to the following paragraphs.

Table 2-1 lists the test equipment for troubleshooting. Chapter 6 contains schematic diagrams and information concerning the voltage levels and waveforms at many of the important test points. Most of the test points used for troubleshooting the supply are located on the control board test "fingers", which are accessible close to the top of the board. See Table 3-9.

If a component is found to be defective, replace it and re-conduct the performance test. When a component is replaced, refer to Calibration Procedure (Chapter 2). It may be necessary to perform one or more of the adjustment procedures after a component is replaced.

### Initial Troubleshooting Procedures

If a problem occurs, follow the steps below in sequence:

- a. Check that input power is available, and check the power cord and rear-panel circuit breaker.
- b. Check that the settings of mode switch A2S1 are correct for the desired mode of operation. (See Operating Manual).
- c. Check that all connections to the power supply are secure and that circuits between the supply and external devices are not interrupted.
- d. Check that the rear-panel GPIB address switch A8S1 is properly set. (See Operating Manual).
- e. If the power supply fails turn-on self-test or gives any other indication of malfunction, remove the unit from the operating system before proceeding with further testing.

### WARNING

Some circuits on the power mesh are connected directly to the ac power line. Exercise extreme caution when working on energized circuits. Energize the supply through an isolation transformer to avoid shorting ac energized circuits through the test instrument's input leads. The isolation transformer must have a power rating of at least 4KVA. During work on energized circuits, the safest practice is to disconnect power, make or change the test connections, and then re-apply power.

Make certain that the supply's ground terminal (⊥) is securely connected to an earth ground before applying power. Failure to do so will cause a potential shock hazard that could result in personal injury.

## Electrostatic Protection

The following caution outlines important precautions which should be observed when working with static sensitive components in the power supply.

### CAUTION

This instrument uses components which can be damaged by static charge. Most semiconductors can suffer serious performance degradation as a result of static charges, even though complete failure may not occur. The following precautions should be observed when handling static-sensitive devices.

- a. Always turn power off before removing or installing printed-circuit boards.
- b. Always stored or transport static-sensitive devices (all semiconductors and thin-film devices) in conductive material. Attach warning labels to the container or bag enclosing the device.
- c. Handle static-sensitive devices only at static-free work stations. These work stations should include special conductive work surfaces (such as Agilent Part No. 9300-0797) grounded through a one-megohm resistor. Note that metal table tops and highly conductive carbon-impregnated plastic surfaces are too conductive; they can act as large capacitors and shunt charges too quickly. The work surfaces should have distributed resistance of between  $10^6$  and  $10^{12}$   $\Omega$  per square.
- d. Ground all conductive equipment or devices that may come in contact with static-sensitive devices or subassemblies containing same.
- e. Where direct grounding of objects in the work area is impractical, a static neutralizer should be used (ionized air blower directed at work). Note that this method is considerably less effective than direct grounding and provides less protection for static-sensitive devices.
- f. While working with equipment on which no point exceeds 500 volts, use a conductive wrist strap in contact with skin. The wrist strap should be connected to ground through a one-megohm resistor. A wrist strap with insulated cord and built-in resistor is recommended, such as 3M Co. No. 1066 (Agilent Part No. 9300-0969 (small) and 9300-0970 [large]).

### WARNING

Do not wear a conductive wrist strap when working with potentials in excess of 500 volts; the one-megohm resistor will provide insufficient current limiting for personal safety.

- g. All grounding (device being repaired, test equipment, soldering iron, work surface, wrist strap, etc.) should be done to the same point.
- h. Do not wear nylon clothing. Keep clothing of any kind from coming within 12 inches of static-sensitive devices.
- i. Low-impedance test equipment (signal generators, logic pulsers, etc.) should be connected to static-sensitive inputs only while the components are powered.
- j. Use a mildly activated rosin core solder (such as Alpha Metal Reliacor No. 1, Agilent Part No. 8090-0098) for repair. The flux residue of this type of solder can be left on the printed circuit board. Generally, it is safer not to clean the printed-circuit board after repair. Do not use Freon or other types of spray cleaners. If necessary, the printed-circuit board can be brushed using a natural-bristle brush only. Do not use nylon-bristle or other synthetic-bristle brushes. Do not use high-velocity air blowers (unless ionized).
- k. Keep the work area free of non-conductive objects such as Styrofoam-type cups, polystyrene foam, polyethylene bags, and plastic wrappers. Non-conductive devices that are necessary in the area can be kept from building up a static charge by spraying them with an anti-static chemical (Agilent Part No. 8500-3397).
- l. Do not allow long hair to come in contact with static-sensitive assemblies.
- m. Do not exceed the maximum rated voltages specified for the device.

## Repair and Replacement

Repair and replacement of most components in the power supply require only standard techniques that should be apparent to the technician. The following paragraphs provide instructions for removing certain assemblies and components for which the procedure may not be obvious upon inspection.

### WARNING

To avoid the possibility of personal injury, remove the power supply from operation before opening the cabinet. Turn off ac power and disconnect the line cord, GPIB plug, load, and remote sense leads before attempting any repair or replacement.

---

**CAUTION**

When replacing any heatsink-mounted components except thermostat, smear a thin coating of heatsink compound between the component and heatsink. If a mica insulator is used, smear a thin coating of heatsink compound on both sides of the mica insulator.

Do not use any heatsink compound containing silicone, which can migrate and foul electrical contacts elsewhere in the system. An organic zinc oxide cream, such as American Oil and Supply Company Heatsink Compound #100, is recommended.

---

---

**CAUTION**

Most of the attaching hardware in this unit is metric. The only non-metric (sometimes called English or inch) fittings are listed below. Be careful when both types of screws are removed not to get them mixed up.

---

- a. Screws that secure the input and output capacitors to A1 main board and output bus bars.
- b. Rear-panel circuit breaker.
- c. Rear-panel ground binding post.
- d. Strap-handle screws (2).
- e. Screws that secure side chassis to front-frame casting (4, 2 on top and 2 on bottom).

**Top Outside Cover Removal.** Remove the two top rear screws using a Size 2, Pozidriv screwdriver. A Phillips head screwdriver does not fully seat into Pozidriv screws and risks stripping the heads. Remove the top cover by sliding it to the rear and lifting at the front.

**Bottom Cover Removal.** Remove the handles from both sides of the unit and remove the bottom cover by sliding it to the rear. Use a Phillips head #2 screwdriver to remove the handle screws. You do not need to remove the unit's feet.

**Inside Top Cover Removal.** The unit includes an inside cover which secures the vertical board assemblies. Remove the inside cover for repair but not for calibration.

Remove the nine mounting screws (Pozidriv, M4x.7) -two on the left side, three on the right side, four on top. Remove the inside cover by lifting at the front edge.

When installing the inside cover, insert it first at the right side. While holding it tilted up at the left, reach through the cutouts in the cover and fit the top tabs of the A8 GPIB board into the mating slots in the cover. Then repeat the process for the A2 control board, the A4 FET board, and the A5 Diode board. Press the inside cover down firmly while tightening screws that secure cover to chassis. Be careful not to bend any boards or components.

## A2 Control Board Removal

After removing the inside cover, unplug the W5 and W6 ribbon cables at the top edge of the A2 control board. Then unplug the W7 and W8 ribbon cables from the lower center of the board. Remove the A2 board by lifting first at the front edge and then pulling it up and out of the unit.

When installing the A2 board, insert it first at the rear of the unit. While holding it tilted up at the front, fit the A2TB1 terminal strip into the mating cutout in the rear panel. Then lower the A2 board's bottom connectors into the mating connectors on the main board. Press the A2 board into the connectors, and reinstall the W5, W6, W7, and W8 ribbon cables.

## A4 FET Board Removal

After removing the inside cover, remove the A4 mesh board by lifting, using the large aluminum heatsink as a handle. One connector and one tab holds the A4 board at its bottom edge.

When installing the A4 power mesh board, lower it vertically, placing its tab into the A1 board slot, align the connector and press in place.

## **A5 Diode Board Removal**

After removing the cover, remove the A5 Diode board by first removing the two screws (Poizidriv) that hold heatsinks to the A1 board, then lift vertically to remove the A5 board from the connector.

When installing the A5 Diode board, lower it vertically into the mating connector on the A1 board, then install a screw between each heatsink and A1 board.

## **A8 GPIB Board Removal**

Remove the A8 board as follows:

- a. Remove the two screws (Poizidriv, M3x.5) which attach the A8 GPIB board to the rear panel. Remove the single screw (Poizidriv, M4x.7) that secures the GPIB board to the side frame near the front corner.
- b. After removing the inside cover, unplug the W5 and W6 ribbon cables at the top edge of the A8 board, the W2 3-wire cable from connector A8J10 and the W1 ribbon cable from connector A8J9.
- c. Remove the A8 board lifting it straight up.

Install the A8 board by reversing the above steps. Lower the rear side of the board into the unit first and fit the bottom tabs into their mating slots.

## **A3 Front-Panel Board Removal**

Remove the A3 front-panel board by first removing the entire front panel assembly. You do not need to remove the top cover. Follow this procedure:

- a. Remove the top plastic insert by prying up with a flat-blade screwdriver.
- b. Remove the four front-panel assembly mounting screws (Poizidriv M4) on the top and bottom at the corners.
- c. Gently pull the front-panel assembly away from the unit as far as permitted by the connecting cables.
- d. Note the locations of the four power-wire connections to the power switch and then unplug the quick-connect plugs.
- e. Unplug the W3 3-wire cable from connector A1J4 on the A2 control board, and unplug the W1 ribbon cable from connector A8J9 on the A8 GPIB board.
- f. Remove the A3 board from the front-panel assembly by removing the six mounting screws (Poizidriv, M4x.7)

Install the A3 Board by reversing the steps above.

## **A1 Main Board Removal**

Removing the A1 main board requires removing the rear-panel, all boards except the A3 front-panel board, and 17 A1 board mounting screws, four standoffs, and two bus bar mounting screws. Component-access cutouts in the bottom inside cover allow unsoldering most A1-board components for repair without removing the A1 board.

Proceed as follows

- a. Remove the A2, A4, A5, and A8 boards according to the above instructions.
- b. Remove the AC power cord from the cooling fan and the four AC Input Power wires.

AC Input Wire		Terminal Destination	
from	color	designator	location
L6 (chassis)	white	P	left rear
RFI filter	white/gray	N	behind A1K1
Circuit breaker	white/brown/gray	L	behind A1K1
L6 (chassis)	white		A1K1 front armature

- c. Remove the following mounting screws, all Pozidriv:
  - 2 (1 each) from the output bus bars
  - 7 from the A1 board
  - 4 from transformer AIT2
  - 4 from transformer AIT3
  - 2 from relay A1K1
  - 4 inside-cover mounting posts 5/16 hex
- d. Lift the A1 board up and toward the rear, then remove the wires from the front panel switch A3S1.

A1 Designator	Wire color	A3S1 Position (Rear View)
A	white/gray	
B	gray	S1
C	white/brown/gray	B -   - A
D	white/red/gray	C -   - D

Install the A1 board by reversing the above steps. Be careful to follow the wire color code.

---

## Overall Troubleshooting Procedure

The overall troubleshooting procedure for the unit involves isolating the problem to one of several circuit blocks and troubleshooting the block individually. The GPIB/microprocessor related circuit blocks are located on the A3 (front panel) and the A8 (GPIB) boards. They are referred to collectively as the GPIB section. The power supply circuit blocks are on the A1 (main), the A2 (control), the A4 (FET), and the A5 (diode) boards. They are referred to collectively as the power section.

The flowchart of Figure 3-1 provides troubleshooting isolation procedures to guide you either to the appropriate circuit or to one of the detailed troubleshooting procedures in this section. The purpose of the flowchart is only to isolate the problem to a specific area of the power supply. If you have already isolated the problem, proceed directly to the applicable troubleshooting section.

Table 3-1 lists the error codes that may appear on the front panel when the unit performs its internal selftest. Along with the error codes, the table also identifies various circuits or components that may have caused that error code to appear.

In the Power Section Troubleshooting, Tables 3-10 and 3-11 give various power supply symptoms that identify the corresponding board, circuit or components that may have caused that symptom. The symptoms in Table 3-10 may become apparent when running the Performance Tests in Section 2.

---

## GPIB Section Troubleshooting

The GPIB section troubleshooting consists of primary and secondary interface troubleshooting. Signature analysis is required to troubleshoot the primary and secondary processor as well as the front panel board. Other circuits on the GPIB board, such as the voltage and current DACs, can be checked using either signature analysis or the front panel controls. The readback circuits cannot be checked using signature analysis. Figure 3-2 illustrates the test setup that allows access to the GPIB board components for troubleshooting.

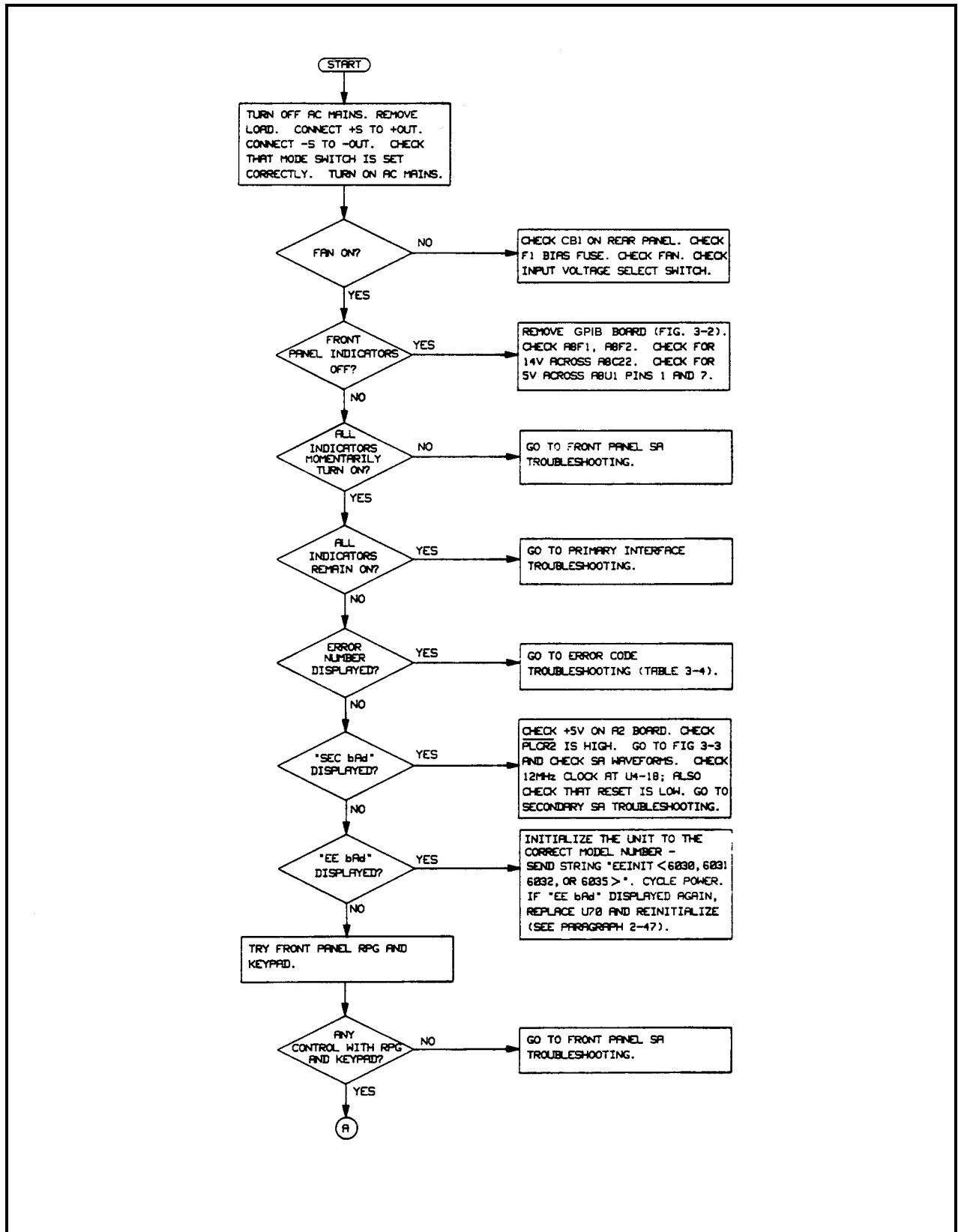

Figure 3-1. Troubleshooting Isolation

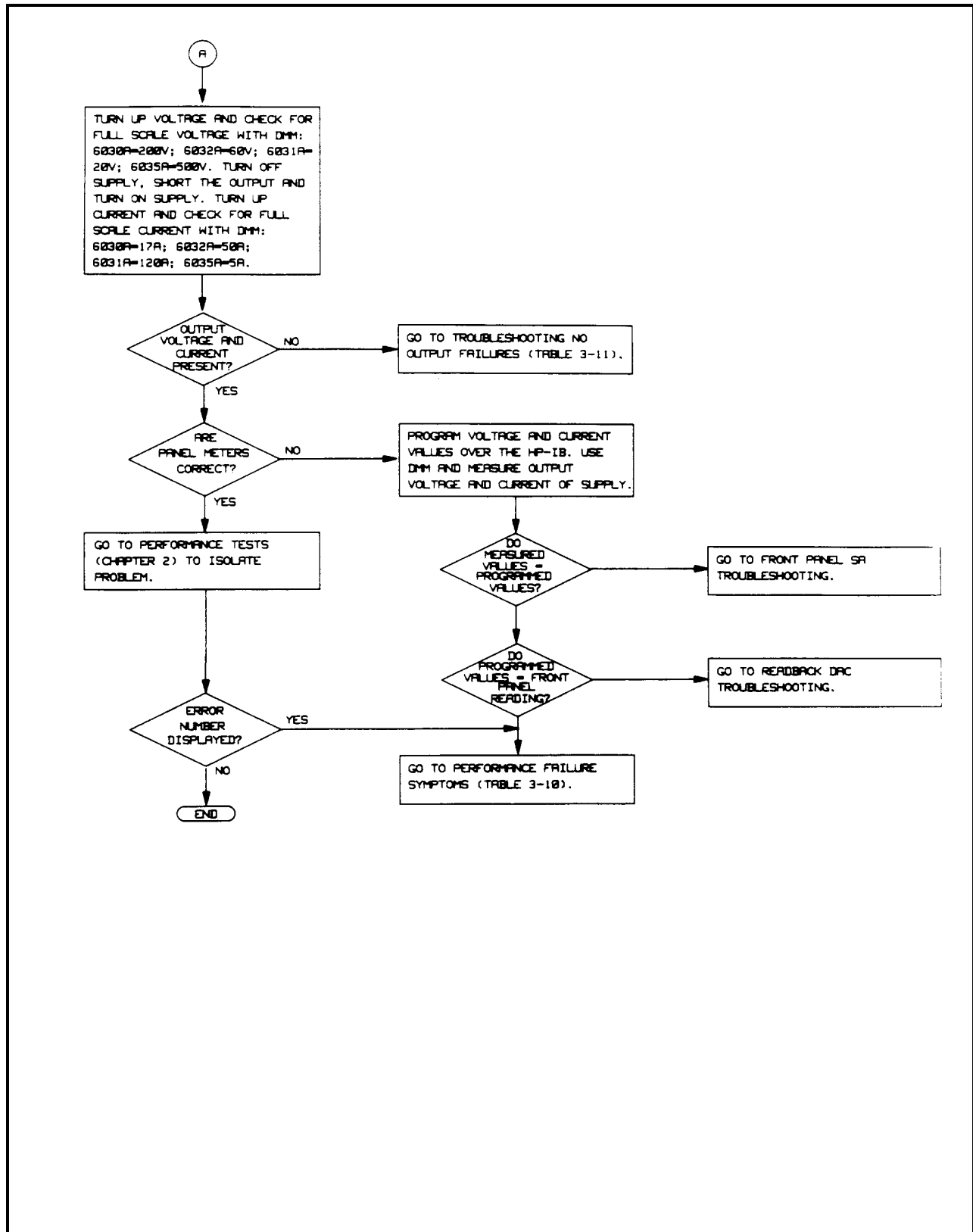

Figure 3-1. Troubleshooting Isolation (continued)

To remove the GPIB board, perform the GPIB board removal procedure discussed earlier in this section. Lay out the board as shown in Figure 3-2 with a piece of insulating material under the board. Reconnect connectors W1, W2, W5, and W6 after the board is on the insulating material.

**Note:** The GPIB board can be placed alongside the unit for troubleshooting by using extender cables provided in service kit Agilent P/N 06033-60005.

**Table 3-1. Selftest Error Code Troubleshooting**

Error Code	Description	Check Functional Circuit
ERROR 4	External RAM Test	Replace A8U8
ERROR 5	Internal RAM Test	Replace A8U14
ERROR 6	External ROM Test	Replace A8U6
ERROR 7	GPIB Test	Replace A8U17
ERROR 8	GPIB address set to 31	
ERROR 10	Internal ROM Test	Replace A8U4
ERROR 12	ADC Zero Too High	Check U11,20,24,66,67; go to Readback DAC Troubleshooting
ERROR 13	Voltage DAC Full Scale Low	Check U2,7,64,69
ERROR 14	Voltage DAC Full Scale High	Check U2,7,64,69
ERROR 15	Voltage DAC Zero Low	Check U2,7,64,69
ERROR 16	Voltage DAC Zero High	Check U2,7,64,69
ERROR 17	Current DAC Full Scale Low	Check U9,65,68
ERROR 18	Current DAC Full Scale High	Check U9,65,68
ERROR 19	Current DAC Zero Low	Check U9,65,68
ERROR 20	Current DAC Zero High	Check U9,65,68

**Go to Secondary SA Troubleshooting**

### Primary Interface Troubleshooting

Primary interface troubleshooting checks for the presence of bias voltages, clock signals (see Figure 3-3), and activity on the data lines. Primary signature analysis may be used to further troubleshoot these circuits, but since the address and data lines go to so many IC's, it may not be cost-effective to narrow an incorrect signature to a specific chip. GPIB board replacement may be the most cost-effective solution.

**Note:** The initialization procedure in Page 31 must be performed when the GPIB board is replaced.

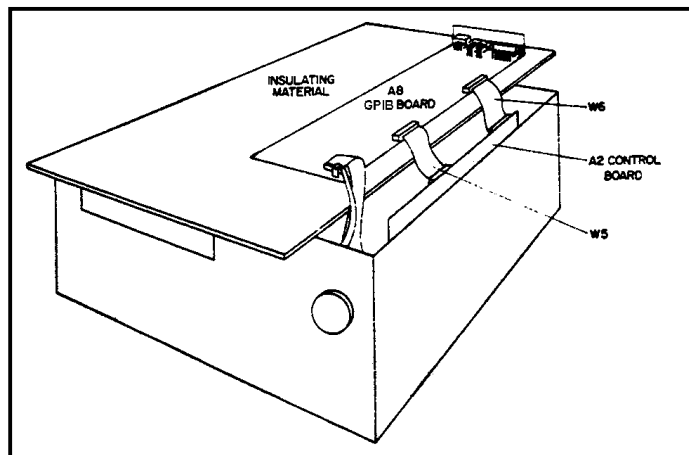

**Figure 3-2. GPIB Board Test Setup**



### +5V and PCLR Circuits:

Node	Measurement
U1-8	≈ 3.5Vdc
U1-2	= 4 Vdc
U1-3	= 4.2Vdc
U1-4	= 4.2Vdc
U1-6	≈50mVdc

**Clock Signals** (see clock waveforms in Figure 3-3)

Node	Measurement	Source
C7+,C8+	= 12MHz (see waveform)	Y2
J5-8	= 6MHz (see waveform)	U14
U35-12	≈ 50mVdc (see waveform)	U35

**Data Lines** Check that all data and address lines are toggling. Address and data lines go to the following IC's:

Address Lines	Data Lines
U6: A0 to A15	U6: D0 to D7
U8: A0 to A15	U8: D0 to D7
U12: A0 to A4	U12: D0 to D7
U14: A8 to A15	U14: D0 to D7
U16: A0 to A7	U16: D0 to D7
U17: A0 to A2	U17: D0 to D7
U36: A7 to A15	

---

**Note:** Data and address lines may not toggle if one line is shorted either high or low. If no short is found, replace all socketed IC's. If the data lines still do not toggle, replace the GPIB (A8) assembly.

---

Node	Measurement
A0 to A15	Toggling
D0 to D7	Toggling

---

## Secondary Interface Troubleshooting

Secondary interface troubleshooting checks the operation of the voltage, current, and readback DACs as well as analog multiplexer and secondary microprocessor. The analog multiplexer is checked in the Readback DAC troubleshooting procedure. The secondary microprocessor can only be checked using secondary SA (refer to Signature Analysis).

### Voltage and Current DAC

The voltage and current DACs can be checked either from the front panel or by secondary SA. Refer to Signature Analysis to troubleshoot the voltage and current DACs in this manner.

---

**Note:** To troubleshoot the voltage and current DACs from the front panel if the unit has failed selftest, place jumper A8J5 in the skip selftest position (see Table 3-2). This lets you operate the unit even though it fails the internal selftest.

---

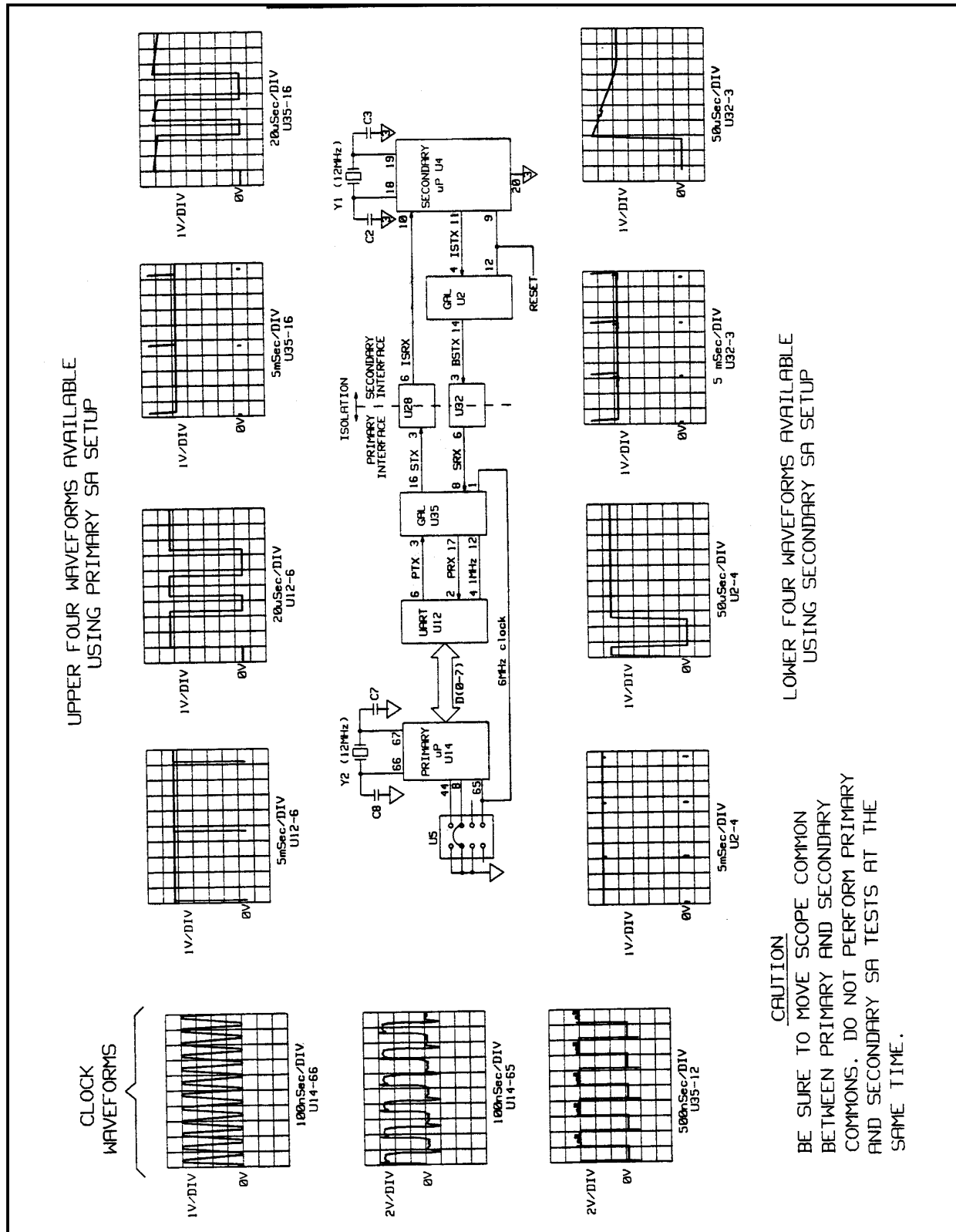

UPPER FOUR WAVEFORMS AVAILABLE USING PRIMARY SA SETUP

LOWER FOUR WAVEFORMS AVAILABLE USING SECONDARY SA SETUP

**CAUTION**  
 BE SURE TO MOVE SCOPE COMMON BETWEEN PRIMARY AND SECONDARY COMMONS. DO NOT PERFORM PRIMARY AND SECONDARY SA TESTS AT THE SAME TIME.

Figure 3-3. Clock and Primary SA Waveforms

Use the front panel controls to vary the output voltage and current from zero to full-scale output. Remember to turn off the unit and connect a short across the output before programming the current from zero to full scale. Use a DMM and check the voltages at the following nodes:

### CV DAC Circuits

Node	Setup	Measurement
U69-6	Voltage set to 0.	0V
	Voltage set to max.	+ 5V
U64-6	Voltage set to 0.	0V
	Voltage set to max.	-10V

### CC DAC Circuits

Node	Setup	Measurement
U68-6	Current set to 0.	0V
	Current set to max.	+ 5V
U65-6	Current set to 0.	0V
	Current set to max.	-10V

### Readback DAC Circuits

Refer to Figure 3-4 for the waveforms to troubleshoot the readback circuits.

The turn-on selftest waveform at U24-7 is obtained by toggling the on/off switch repeatedly to perform the selftest routine. If this waveform is not correct, isolate the problem either to the readback DAC or the multiplexer.

---

**Note:** To troubleshoot the readback DAC from the front panel if the unit has failed selftest, place jumper A8J5 in the skip selftest position (see Table 3-2). This lets you operate the unit even though it fails the internal selftest.

---

Use the front panel controls to vary the output voltage from zero to full-scale output to obtain the waveforms at U67-6. These waveforms check the operation of the readback DAC.

To check the multiplexer, use the front panel controls to obtain the waveforms at the output of the multiplexer (U24-2). Remember to turn off the unit and connect a short across the output before programming the current from zero to full scale. Press "OVP DISPLAY" on the front panel to display the OV\_MON portion of the waveforms.

If the waveforms are not correct, use the front panel controls and a DMM to check the multiplexer input voltages at the following nodes:

### Readback Multiplexer (U20):

Node	Setup	Measurement
U20-9	Voltage set to 0.	0V
	Voltage set to max.	+ 5V
U20-10	Current set to 0.	0V
	Current set to max.	+ 5V
U20-11	OV set to 0.	0V
	OV set to max.	+2.2V

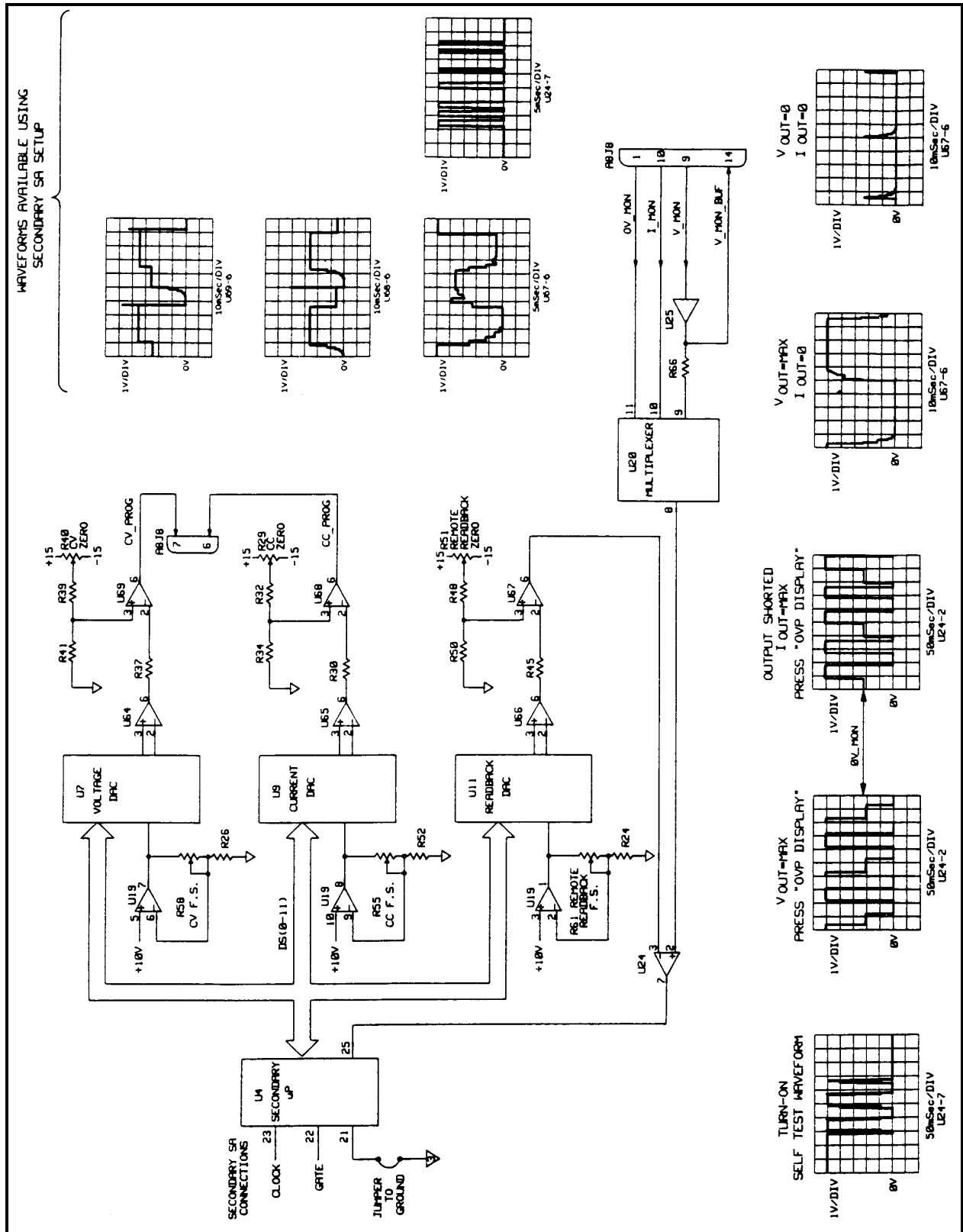

Figure 3-4. Readback and Secondary SA Waveforms

---

## Signature Analysis

Perform the signature analysis only after you have completed the Primary Processor Troubleshooting.

The easiest and most efficient method of troubleshooting microprocessor-based instruments is signature analysis. Signature analysis is similar to signal tracing with an oscilloscope in linear circuits. Part of the microcomputer memory is dedicated to signature analysis and a known bit stream is generated to stimulate as many nodes as possible within the circuit. However, because it is virtually impossible to analyze a bit stream with an oscilloscope, a signature analyzer is used to compress the bit stream into a four-character signature that is unique for each node. By comparing signatures of the unit under test to the correct signatures for each node, faults can usually be isolated to one or two components. Note that signature analysis provides only go/no-go information; *the signature provides absolutely no diagnostic information.*

The following general notes apply to signature analysis of the power supply.

1. Be certain to use the correct setup for the signature being examined.
2. Most signatures are taken on the GPIB, and front panel assemblies.
3. Note the signatures for Vcc and ground on the I.C. being examined. If an incorrect signature is the same as that of Vcc or ground, that point is probably shorted to Vcc or ground.
4. If two pins have identical signatures, they are probably shorted together. If two signatures are similar, it is only coincidence. For example, if the signature at a certain point should be 65C4, a signature of 65C3 is not "almost right". No diagnostic information can be inferred from an incorrect signature.
5. If a signature is incorrect at an input pin, but is correct at its source (output of previous I.C.), check for printed circuit and soldering discontinuity.
6. An incorrect signature at an output could be caused by a faulty component producing that output; or, a short circuit in another component or on the board could be loading down that node.

Tables 3-2 and 3-3 show the primary, front panel, and secondary signature analyzer connections that are required to perform the SA tests in Tables 3-4 through 3-8. Remember that the primary and secondary circuits each reference a different circuit common.

### Primary SA

Place the unit in primary SA mode by moving the J5 jumper as shown in Table 3-2. Connect the signature analyzer as shown in the table. The front panel display should indicate: "SA SA", and all LED's will be on. If the display is different, replace U14.

---

**Note:** The power supply will not go into SA mode if one of the data and address lines is shorted either high or low. Refer to Data Lines troubleshooting.

---

When the unit is in SA mode, check for the waveforms shown in Figure 3-3. Refer to Table 3-4 for the primary SA signatures. Return the J5 jumper to its normal position when the primary signature analysis is complete.

### Front Panel SA

To place the unit in SA mode for Front Panel SA troubleshooting, follow the procedure for Primary SA troubleshooting. When the unit is in SA mode, check the signatures in Tables 3-5 through 3-7.





The signatures in Table 3-5 check the registers that drive the 7-segment LED displays. Most problems will involve only one display or LED indicator. Table 3-6 checks the address latches and decoders. Address latch U15 forwards address data to the address decoders, which enable the shift registers. Table 3-7 checks flip-flop U12, shift register U11, and gate U18. U12 decodes the output of the RPG. U11 and U18 are used by the microprocessor to read the status of the RPG and front panel switches.

Return the J5 jumper to its normal position when the front panel signature analysis is complete.



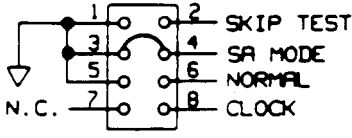

## Secondary SA

For secondary SA troubleshooting, connect the signature analyzer as shown in Table 3-3. Use a jumper wire and short U4 pin 21 to common (U4 pin 20). Check for the waveforms in Figure 3-4 and the signatures in Table 3-8 for the secondary SA. When the secondary signature analysis is complete, disconnect the jumper on U4 pin 21.

**Table 3-2. Primary and Front Panel Signature Analyzer Test Setups**

SIGNATURE ANALYZER INPUT	EDGE SETTING	PRIMARY SA CONNECTIONS
CLOCK		A8J5 pin 8
START		A8U37 pin 16
STOP		A8U37 pin 16
GROUND		A8J5 pin 5
A8J5 (in SA mode)		
		
<p><b>A8J5 JUMPER POSITIONS</b></p> <p>Jumpering pins 1 and 2 skips the internal selftest when the unit is turned on.</p> <p>Jumpering pins 3 and 4 places U37 in SA mode.</p> <p>Jumpering pins 5 and 6 is the normal/operating position of the jumper.</p>		

**Table 3-3. Secondary Signature Analyzer Test Setups**

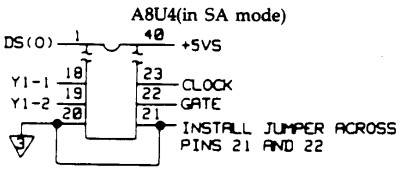
SIGNATURE ANALYZER INPUT	EDGE SETTING	SECONDARY SA CONNECTIONS
CLOCK		A8U4 pin 23
START		A8U4 pin 22
STOP		A8U4 pin 22
GROUND		A8U4 pin 20
A8U4 (in SA mode)		
		
<p><b>A8U4 JUMPER POSITIONS</b></p> <p>Use a jumper wire and connect A8U4 pin 21 to pin 20 (ground).</p> <p>Use a 40-pin test clip (Pomona Model 5240 or eq.) to facilitate test connections to A8U4.</p>		

**Table 3-4. Primary Processor Signature Table  
(A8U6 = P/N 5080-2160 REV A.00.00, A.00.01, A.00.02 and A.00.04)**

	<b>A.00.04</b>	<b>A.00.02</b>	<b>A.00.01</b>	<b>A.00.00</b>						
A(0)	A46A	A46A	A46A	A46A		U16-12	U6-12	U8-12	U12-11	U17-21
A(1)	4148	UH80	UH80	UH80		U16-13	U6-11	U8-11	U12-13	U17-22
A(2)	72F5	82H5	UO39	4FU1		U16-14	U6-10	U8-10	U12-9	U17-23
A(3)	PAU8	9899	HOPF	86C2		U16-15	U6-9	U8-9	U12-10	
A(4)	A4A7	3088	O7FA	5A37		U16-16	U6-8	U8-8	U12-8	
A(5)	45OP	48H5	5823	PHHO		U16-17	U6-7	U8-7		
A(6)	C3UU	UF3H	2682	3F6U		U16-18	U6-6	U8-6		U36-11
A(7)	HOU4	HOU4	F6OP	HFP3		U16-19	U6-5	U8-5		U36-9
A(8)	4U39	4U39	17AF	17AF	U14-52		U6-27	U8-27		U36-8
A(9)	45A8	45A8	62H1	62H1	U14-51		U6-26	U8-26		U36-7
A(10)	278A	278A	OOU3	OOU3	U14-50		U6-23	U8-23		U36-6
A(11)	6OA3	6OA3	6OA3	6OA3	U14-49		U6-25	U8-25		U36-5
A(12)	7826	7826	7826	7826	U14-48		U6-4	U8-4		U36-4
A(13)	5850	5850	5850	5850	U14-47		U6-28	U8-28		U36-3
A(14)	F93H	F93H	F93H	F93H	U14-46		U6-29	U8-3		U36-2
A(15)	79UA	79UA	79UA	79UA	U14-45		U6-3	U8-31		U36-1
D(0)	PH2F	48P2	48P2	48P2	U14-60	U16-9	U6-13	U8-13	U12-22	U17-12
D(1)	HU9O	6O84	6O84	6O84	U14-59	U16-8	U6-14	U8-14	U12-21	U17-13
D(2)	U665	74UH	96C5	HA6P	U14-58	U16-7	U6-15	U8-15	U12-20	U17-14
D(3)	53PP	16A9	UH79	8OC2	U14-57	U16-6	U6-17	U8-17	U12-19	U17-15
D(4)	C9C2	196F	AA13	U64C	U14-56	U16-5	U6-18	U8-18	U12-18	U17-16
D(5)	C27C	132C	8A9F	89AP	U14-55	U16-4	U6-19	U8-19	U12-17	U17-17
D(6)	HO18	4387	497F	2C5F	U14-54	U16-3	U6-20	U8-20	U12-16	U17-18
D(7)	P97H	4FC3	33AO	U44P	U14-53	U16-2	U6-21	U8-21	U12-15	U17-19
WR*	FP65	FP65	FP65	FP65	U14-40			U8-29		U36-12
RD*	unstable	3PPH	3PPH	3PPH	U14-61		U6-24	U8-24		U36-13
ALE	U665	4OAP	4OAP	4OAP	U14-62	U16-11				
READY	26C3	26C3	26C3	26C3	U14-43					U36-15
BANK_SEL	unstable	5AHH	unstable	unstable	U14-27					U36-14
EE(0)	7CF1	7CF1	7CF1	7CF1	U14-19					U70-1
EE(1)	AH32	AH32	AH32	AH32	U14-20					U70-2
EE(2)	HCCH	HCCH	HCCH	HCCH	U14-21					U70-3
EE(3)	9P5F	9P5F	9P5F	9P5F	U14-22					U704
APC	9361	9361	9361	9361	U14-23					U15-22
UART	CHU5	CHU5	CHU5	CHU5					U12-14	U36-16
GPIB	2688	2688	2688	2688						U36-17
ROM	C95F	C95F	C95F	C95F			U6-22			U36-19
RAM	9UPU	9UPU	9UPU	9UPU				U8-22		U36-18

**Table 3-5. Front Panel LED Display and Indicator Drivers**  
**(A8U6 = P/N 5080-2160 REV A.00.00, A.00.01, A.00.02 and A00.04 Inputs)**

<b>Inputs:</b>											
<b>Node</b>	<b>Measurement</b>										
U1 to U10-1	6H15										
U1 to U10-9	Cycle power to unit--Lo to Hi after approx. 160 ms										
U1 to U10-2,14	+5V										
U1 to U10-7	common										
U1-8	F05U										
U2-8	50A9										
U3-8	6F42										
U4-8	AH52										
U5-8	51U7										
U6-8	PHFF										
U7-8	5730										
U8-8	8U73										
U9-8	HU9C										
U10-8	5AHH										
<b>Outputs:</b>											
	<b>Current Display</b>				<b>Voltage Display</b>						
	U1	U2	U3	U4	U5	U6	U7	U8	U9	U10	
pin 3	5AHH	102A	4A3F	5AHH	5AHH	4U91	7499	5AHH	CHP5	0000	
pin 4	5AHH	92FF	C665	5AHH	5AHH	31U5	4475	5AHH	P3PP	0000	
pin 5	5AHH	4FUC	5526	5AHH	5AHH	739H	P7AH	5AHH	H8HC	0000	
pin 6	5AHH	94F0	C4A9	5AHH	5AHH	5724	OUC4	5AHH	84PU	0000	
pin 10	5AHH	102A	A73P	5AHH	5AHH	4U91	1467	5AHH	5UAU	0000	
pin 11	5AHH	92FF	PFP6	5AHH	5AHH	31U5	U810	5AHH	U7A8	0000	
pin 12	5AHH	4FUC	163C	5AHH	5AHH	739H	HA84	5AHH	A60U	0000	
pin 13	5AHH	94F0	IAP8	5AHH	5AHH	5724	C4HC	5AHH	56PA	0000	



**Table 3-6. Front Panel Address Latches and Decoders**  
**(A8U6 = P/N 5080-2160 REV A.00.00, A.00.01, A.00.02 and A.00.04 Inputs)**

<b>Inputs:</b>					
<b>Node</b>	<b>Measurements</b>				
U14-26	Toggling (unstable)				
U14-35	37F8				
U14-38	1ABC				
U15-9, U17-3,6	Cycle power to unit--Lo to Hi after approx. 160 ms				
U17-4,5	Cycle power to unit--Hi to Lo after approx. 160 ms				
<b>Outputs:</b>					
U13-1, U14-1, U15-3	969U	U14-5, U16-6	F615	U16-5, U17-12	9C3C
U13-2, U14-2, U15-4	C7AA	U14-13	Toggling	U16-12, U17-8	4056
U13-3, U14-3, U15-5	A372	U14-14	5AHH	U16-13, U17-10	Toggling
U13-4, U14-4, U17-11	Toggling	U14-15	HU9C	U17-1	37F8
U13-5, U16-3	5C91	U15-1, U17-2	6H15	U17-2	
U13-6, U14-6, U17-9	1ABC	U15-2	+5V		
U13-7	8U73	U15-3			
U13-9	5730	U15-6, U16-2, U17-3	FIP6		
U13-10	PHFF	U15-8, U16-11	P62F		
U13-11	51U7	U15-10, U16-1,4,10	9H84		
U13-12	AH52				
U13-13	6F42				
U13-14	50A9				
U13-15	F05U				

**Table 3-7. Front Panel RPG Latches and Input Port  
(A8U6 = P/N 5080-2160 REV A.00.00, A.00.01 A.00.02, and A.00.04)**

<b>Inputs:</b>					
<b>Node</b>	<b>Measurement</b>				
U11-1	1ABC				
U11-2 U12-4,10	Toggling (unstable)				
U16-10	9H84				
<b>Procedure:</b>					
<b>Node</b>					
S1 LCL	released	U11-13 Lo	U11-7, U16-9	Lo	U16-8 Hi
S1 LCL	depressed	U11-13 Hi	U11-7, U16-8,9	Toggling	
S2 OUTPUT ADJUST	released	U11-14 Lo	U11-7, U16-9	Lo	U16-8 Hi
S2 OUTPUT ADJUST	depressed	U11-14 Hi	U11-7, U16-8,9	Toggling	
S3 DISPLAY OVP	released	U11-3 Lo	U11-7, U16-9	Lo	U16-8 Hi
S3 DISPLAY OVP	depressed	U11-3 Hi	U11-7, U16-8,9	Toggling	
S4 DISPLAY SETTINGS	released	U11-4 Lo	U11-7, U16-9	Lo	U16-8 Hi
S4 DISPLAY SETTINGS	depressed	U11-4 Hi	U11-7, U16-8,9	Toggling	
S5 FOLDBACK	released	U11-5 Lo	U11-7, U16-9	Lo	U16-8 Hi
S5 FOLDBACK	depressed	U11-5 Hi	U11-7, U16-8,9	Toggling	
U12-5	Node toggles when RPG is rotated clockwise				
U12-9	Node toggles when RPG is rotated in either direction				
Set scope for dual trace operation, 2V/div, 10 ms/div, normal triggering, and positive edge on channel A. Connect channel A to U12-3 and channel B to U12-2.					
U12-3	Rotate RPG CW				
U12-2	Rotate RPG CW				
U12-3	Rotate RPG CCW				
U12-2	Rotate RPG CCW				

**Table 3-8. Secondary Processor Signature Table**

DS(0)	P36U	U4-1	U7-15	U9-15	U11-15	
DS(1)	2280	U4-2	U7-14	U9-14	U11-14	
DS(2)	4277	U4-3	U7-13	U9-13	U11-13	
DS(3)	720F	U4-4	U7-12	U9-12	U11-12	
DS(4)	6A31	U4-5	U7-11	U9-11	U11-11	
DS(5)	662U	U4-6	U7-10	U9-10	U11-10	
DS(6)	6020	U4-7	U7-9	U9-9	U11-9	
DS(7)	6327	U4-8	U7-8	U9-8	U11-8	
DS(8)	1377	U4-39	U7-7	U9-7	U11-7	U2-16
DS(9)	FF99	U4-38	U7-6	U9-6	U11-6	U2-17
DS(10)	236P	U4-37	U7-5	U9-5	U11-5	U2-18
DS(11)	H495	U4-36	U7-4	U9-4	U11-4	U2-19
WR*	9FU7	U4-12	U7-17			
WR*	9FF7	U4-13		U9-17		
WR*	9FHU	U4-14			U11-17	
	F817	U4-26				U20-1
	36U7	U4-27				U20-16
	0562	U4-28				U20-15
ISTX	9F97	U4-11				U2-4, 14
	9FH6	U4-17				U2-2
	9FH5	U4-16				U2-11
ALE	0000	U4-30				U2-1
	AU68	U4-35				
+ 5V	9FA8	U4-33,34				

## Power Section Troubleshooting

Table 3-9 describes the signals at each of the control board test points. The test connector provided in service kit P/N 5060-2865 allows easy connection to each test point. The measurements given here include bias and reference voltages as well as power supply status signals. It provides conditions for these measurements and gives the components which are the sources of the signals. Tables 3-10 and 3-11 describe possible symptoms in the power section. Both give lists of circuit blocks or components which can cause the symptoms shown. The appropriate assembly is also given.

If the supply exhibits a symptom given in Table 3-10 or 3-11, go to the block which pertains to that symptom. If the exact symptom seen is not in the tables, start with the symptom that seems to be closest to the one observed. The blocks are given in the Power Section Blocks section starting in Paragraph 3-84. Troubleshooting information for each block will include a brief description of the circuit. The columns provided are as follows:

**NODE:** This column lists the nodes where the measurements should be taken. In some cases this will be stated as NODE( + ) and NODE(-) where the first is the test node and the second is the reference.

**SETUP:** If a certain setup is required for the measurement, it will be given in this column.

**MEASUREMENT:** This column indicates what the expected measurement is for the given node.

**SOURCE:** If applicable, the components which generate the signal will be provided in this column.

**WARNING**

The A4 FET Board should only be raised on an extender when using the main troubleshooting setup. NEVER use a FET Board extender when the unit is operated with its normal ( $\approx 320\text{Vdc}$ ) bus voltage. To do so is a personal shock hazard and can damage the power supply.

To troubleshoot the power supply the A4 power FET board and A2 control board can be raised out of the unit using extender boards and cables provided in service kit P/N 5060-2865.

## Main Troubleshooting Setup

Figure 3-5 shows the troubleshooting setup for troubleshooting all of the unit except the front panel and initial no-output failures (see Paragraph 3-82). The external power supply provides the unit's internal bus voltage. The ac mains connects directly to the unit's A1T3 bias transformer via the isolation transformer, thereby energizing the bias supplies, but it does not connect to the input rectifier and filter to create the bus voltage. With the external supply the unit operates as a dc-to-dc converter. The supply biases A4Q1, A4Q2, A4Q3, and A4Q4 PFETs with a low voltage rather than the 320Vdc bus voltage. This protects the PFETs from failure from excess power dissipation if the power-limit comparator or the off-pulse circuitry are defective. It also reduces the possibility of electrical shock to the troubleshooter.

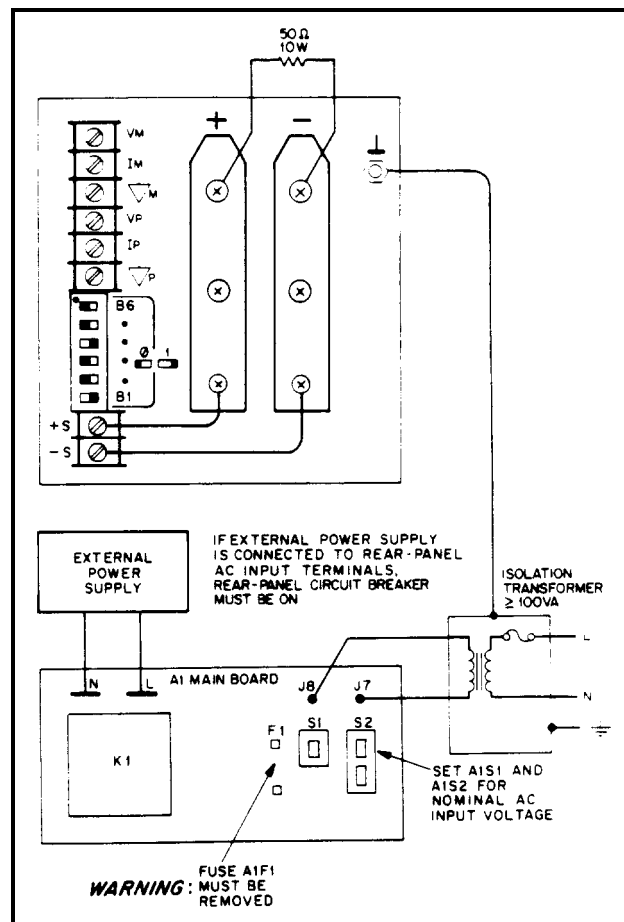

Figure 3 5. Main Troubleshooting Setup

**WARNING**

An isolation transformer provides ac voltage that is not referenced to earth ground, thereby reducing the possibility of accidentally touching two points having high ac potential between them. Failure to use an isolation transformer as shown in Figure 3-5 will cause the ac mains voltage to be connected directly to many components and circuits within the power supply, including the FET heatsinks, as well as to the terminals of the external dc power supply. Failure to use an isolation transformer is a definite personal-injury hazard.

The troubleshooting setup of Figure 3-5 connects high ac voltage to relay K1, fan B1, fuseholder A1F1, and other components and circuits along the front of the A1 main board.

As a convenience in implementing the troubleshooting setup, modify a spare mains cord set as shown in Figure 3-6. This facilitates connecting the unit's power receptacle to the external supply and connecting the bias transformer to the ac mains.

With the mains cord unplugged proceed as follows:

- a. Remove the top cover and the inside cover per Page 35. Remove fuse A1F1.

**WARNING**

Failure to remove fuse A1F1 will result in damage to the power supply, damage to the external dc supply, and is an electrical shock hazard to you.

- a. Install control board test connector onto the A2J7 card-edge fingers.
- b. Connect a 50 $\Omega$  10-W load resistor to the unit's output terminals.
- c. The external dc power supply can be connected to the unit in either of two ways (in either case, the front panel LINE switch should be off):
  1. Remove white/gray wire from main board terminal marked "N" (at left side, just behind relay at front left corner), and remove white/brown, gray wire from terminal "L". Connect external dc power supply to terminals "N" and "L". Either polarity is correct.
  - OR
  2. Ensure that the rear-panel circuit breaker is on. Connect external dc power supply to ac input terminals "L" and "N". Either polarity is correct.
- e. Complete the setup of Figure 3-5 by attaching an ac mains cord to test points J8 (L, black wire) and J7 (N, white wire) and connect the green ground wire to the unit's case ground terminal or a suitably grounded cabinet screw. Connect the mains cord to an isolation transformer.

## Troubleshooting No-Output Failures

No-output failures often include failure of the A4Q1, A4Q2, A4Q3, and A4Q4 PFETs and their fuses A4F1 and A4F2. When either the off-pulses or the power-limit comparator fails, the PFETs can fail from excessive power dissipation. The strategy for localizing no-output failures is to check the voltages and waveforms at the control board test connector to predict if that circuit failure would cause the FETs to fail. This makes it possible to develop your troubleshooting approach without an extensive equipment setup. Proceed as follows:

- a. With the mains cord disconnected remove the A4 FET board per Page 36. Connect the mains cord and switch on power.
- b. Using Table 3-9 check the bias voltages, the PWM-OFF and PWM-ON Control signals and other signals of interest at the A2 control board test fingers, A2J7.
- c. Check for the presence of program voltages, VP and IP, at the rear panel.
- d. Check for presence of the 320Vdc rail voltage with + at the rear facing end of AIR3 and - at the rear facing end of AIR1. If there is no rail voltage, check AIU1.

**WARNING**

AIR1, AIR3, and AIU1 connect to the ac mains voltage. Use a voltmeter with both input terminals floating to measure the rail voltage.

- a. Select the functional circuit for troubleshooting based on your measurements and Table 3-11, which provides direction based on the status of the PWM OFF and PWM ON signals.

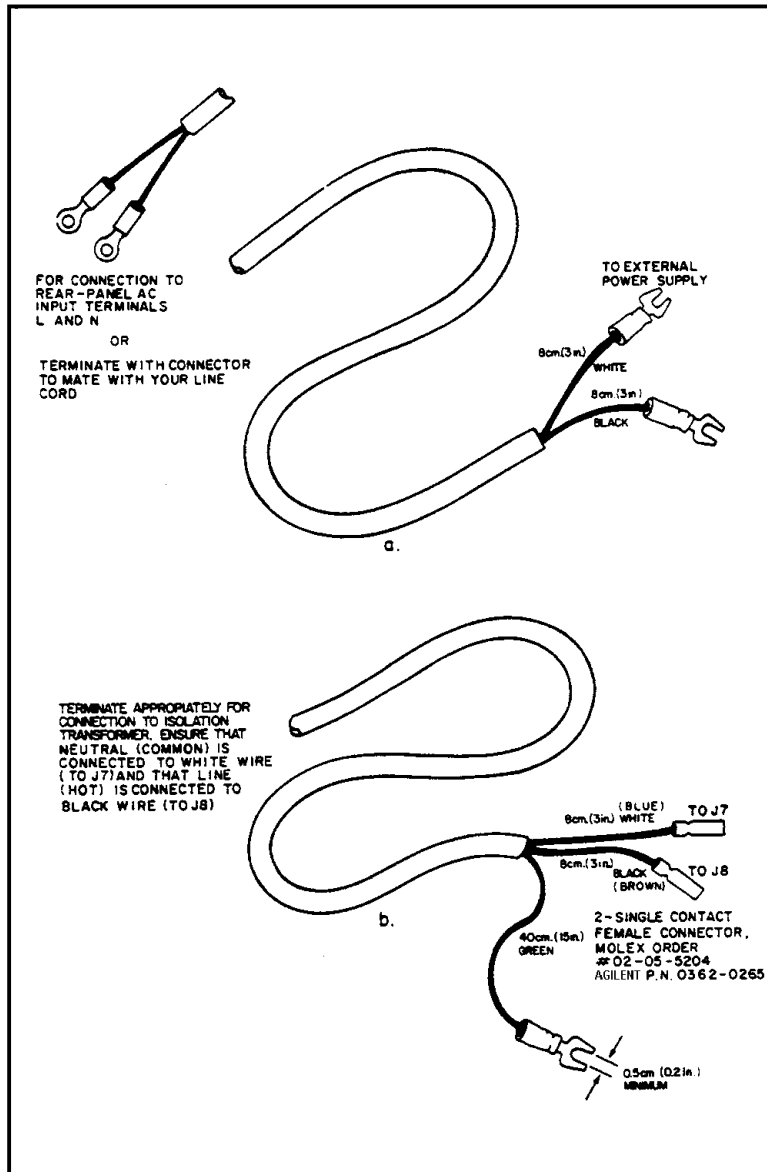

Figure 3-6. Modified Mains Cord Set For Troubleshooting

### Power Section Blocks

This section contains the blocks referenced in Tables 3-10 and 3-11.

**Table 3-9. Control Board Test Connector, A2J7**

PIN NO.	SIGNAL NAME	Vdc	WAVEFORM/CONDITIONS	SOURCE
<b>Digital-Circuits Bias &amp; Reference Voltages</b>				
24	+5V	5.0	with 120Hz & 45KHz ripple	A2Q9 (emitter)
22	+ 20V(5V UNREG)	20.0		A1CR6, A1CR7
14	2.5V ref	2.50		A2U7 (OUT)
6	0.5V ref	0.50		A2R24,A2R84, A2R85
<b>Analog-Circuits Bias Voltages</b>				
2	+ 15V	15.0		A2U11 (OUT)
21	-15V	-15.0		A2U12 (OUT)
<b>Status Signals</b>				
17	$\overline{CV}$	TTL Lo	if in CV operation	A2Q2 (collector)
16	$\overline{CC}$	TTL Lo	if in CC operation	A2Q1 (collector)
13	$\overline{OV}$	TTL Hi	if not OVP shutdown	A2U15-13
11	$\overline{AC\ FAULT}$	TTL Hi	if ac mains okay	A2U15-10
12	$\overline{OT}$	TTL Hi	if not overtemp shutdown	A4TS1,A5TS1
<b>Control Signals</b>				
25	PWM OFF		10 $\mu$ s TTL pulses, 20KHz	A2U16-5
26	PWM ON		1.7 $\mu$ s TTL pulses, 20KHz	A2U15-1
18	Ip MONITOR		1V pk, 1/2 sawtooth, 20KHz (at full power only)	A2CR27 (cathode)
8	$\overline{INHIBIT}$	TTL Hi	if not remotely inhibited	A2U18-9
15	$\overline{DOWN\ PROGRAM}$	1.2-3.0	while not down programming	A2CR17, CR31(anode)
7	OVP PROGRAM	1/100 OVP (6030A) 1/10 OVP (6031A) 1/30 OVP (6032A) 1/250 OVP (6035A)	e.g.: 2 Vdc if OVP set to full voltage output	A3R72 (wiper)
5	$\overline{OV\ CLEAR}$	+5V	inverted OV reset line	A8U4-35
19	$\overline{PCLR}$	+5V	if +5V bias OK	A2Q11-4
<b>Commons &amp; Current-Monitor</b>				
4	COMMON	0.0	return for all bias voltages, status and control signals	
9	COMMON	0.0	return for 2.5V and 0.5V ref	
10	I-TEST	$\approx 0.013 * I_{OUT}(6030A/35A)$ $\approx 0.0017 * I_{OUT}(6031A)$ $\approx 0.0037 * I_{OUT}(6032A)$	inboard-side monitoring res	A1R11,A1T2 (A1R13 (6032A))
3	V-MON-BUF	V-OUT/4 (6031A) V-OUT/12 (6032A) V-OUT/40 (6030A) V-OUT/100 (6035A)	buffered V-MON for readback	A8U25-6
20	Ip-SET	$\approx 0.9$		A2R25 wiper
<p>The diagram shows the pinout for connector J7. On the left, the 'COMPONENT SIDE' is shown with pins 1 through 25. On the right, the 'CIRCUIT SIDE' is shown with pins 26 through 4. Signal names are listed above the pins: +5V, V-MON, OV CLEAR, OVP PROG, COMMON (M), AC FAULT, OVERVOLTAGE, DOWN PROGRAM, CV, PCLR, -15V, N.C., PWM OFF, PWM ON, +20V UNREG, I<sub>p</sub> MONITOR, 2.5V REF, 0.5V REF, INHIBIT, 0.5V REF, COMMON (L), and +15V.</p>				

**Table 3-10. Performance Failure Symptoms**

<b>SYMPTOMS</b>	<b>DEFECTIVE BOARD</b>	<b>CHECK FUNCTIONAL CIRCUITS</b>
unexplained OVP shutdowns	A2	OVP circuit, CV circuit
no current limit	A2	CC circuit
max current < specified	A2	CC Clamp, CC circuit
max power < specified	A2, A1	Power Limit, 20KHz clock, transformer A1T1
max voltage < specified	A2, A1	CV Circuit, diodes A1CR1-CR4
cycles on & off randomly	A2, A1	AC-Surge-&-Dropout Detector, Mains Voltage Select switch A1S2
CV overshoots	A2	A2U5A, A2CR19, A2R62
output noise (<1KHz)	A2,A1	CV circuit, input filter
output noise (>1KHz)	A1, A4	transformer A1T2, Output Filter, snubbers A4R1 to A4R11, A4R13 to A4R19, A4C1 to A4C4, A4CR2, A4CR3, A2R15, A2C2
CV regulation, transient response, programming time	A2, A1	wrong sensing
CC regulation	A2	low ac mains voltage, CV circuit
CV oscillates with capacitive loads	A2	low ac mains voltage, CC circuit
CC oscillates with inductive loads	A2	A2R61, A2R60, A2R58, A2R59, A2C33, A2R64, A2R68, A2C36, A2C37, A2U5, A2R65
		A2R61, A2R60, A2R58, A2R57, A2C33, A2R19
		A2C11, A2R28, A2C12, A2U4, A2R35, A2C20, A2U4, A2R37, A2C17, A2R29, A2C18, A2R31

**Table 3-11. No-Output Failures  
(Bias supplies and AC turn-on circuit functioning)**

<b>Status of FET On/Off-Pulses</b>			
<b>PWM-ON A2J7-26</b>	<b>PWM-OFF A2J7-25</b>	<b>DEFECTIVE BOARD</b>	<b>CHECK FUNCTIONAL CIRCUITS</b>
Lo	Lo	A2	Control ckts: CV & CC thru On- & Off-Pulse Oneshots *
Lo	Hi	A2&A4	PWM and DC-to-DC Converter: A4 PFETS probably failed
Hi	Lo	A2&A4	PWM and DC-to-DC Converter: A4 PFETS probably failed
Hi	Hi	A2&A4	PWM and DC-to-DC Converter: A4 PFETS probably failed
Lo	N	A2	A2U15A, On-Pulse Oneshot and Q11
N	Lo	A2&A4	Off-Pulse Oneshot and DC-to-DC: A4 PFETS probably failed
Hi	N	A2&A4	A2U15A, On-Pulse Oneshot & DC-to-DC: A4 PFETS probably failed
N	Hi	A2&A4	Off-Pulse Oneshot and DC-to-DC: A4 PFETS probably failed
N	N	A2&A4	Power-Limit Comparator and DC-to-DC: A4 PFETS probably failed

Lo= TTL low    Hi= TTL high    N= normal 20KHz pulse train, TTL levels

\* Decide which to troubleshoot--the CV circuit, the CC circuit, or the PWM and Off-Pulse & On-Pulse Oneshots-- by measuring the CV CONTROL (A2CR24, cathode) and the CC CONTROL (A2CR11 cathode) voltages. Troubleshoot whichever is negative, and if neither is negative, troubleshoot the PWM. Make these voltage measurements after you have implemented the Main Troubleshooting Setup.



## Troubleshooting AC-Turn-On Circuits

Relay AIK1 closes at 2.5 seconds and  $\overline{\text{AC FAULT}}$  goes high at 2.9 seconds after 21V UNREG reaches about 13Vdc.  $\overline{\text{AC FAULT}}$  high enables the PWM if  $\overline{\text{OVERVOLTAGE}}$ ,  $\overline{\text{INHIBIT}}$ , and  $\overline{\text{OVERTEMP}}$  are also high.

**Circuits Included.** High AC and AC Dropout Detectors, Bias Voltage Detector, Q11A, 3-Second Delay and Relay Driver--all on A2 control board.

**Setup.** The Main Troubleshooting Setup, Page 53. Apply the ac mains voltage to the isolation transformer, and set the external supply to 0Vdc.

### Inputs:

NODE (+) *	SETUP	MEASUREMENT	SOURCE
A2J7-24		5.0Vdc	A209 (emit.)
A2J7-22		≈ 21Vdc	A1CR2,A1CR5
A2Q11-16		f.w.rect,0.8V pk	A1CR3,A1CR4
A2U20-13		TTL sq wave,20KHz	A2U20-6

### Outputs:

NODE (+) *	SETUP	MEASUREMENT
A2U17-9	cycle power	≈ 13.5Vdc
A2U17-14	cycle power	≈ 1.4Vdc
A2Q11-14	cycle power	transition 0 to 5Vdc at 25 sec
A2Q11-4		Hi (5Vdc)
A2U9-10	cycle power	2.9 s burst 1.25KHz sq. wave
A2U9-15	cycle power	one 840ms pulse then Hi at 2.5 sec
A2U9-14	cycle power	three 420 ms pulses then Hi at 2.9 sec
A2U9-1	cycle power	transition Lo to Hi at 1.7 s
A2U15-10	cycle power	transition Lo to Hi at 2.9 s
$\overline{\text{AC FAULT}}$		
A2Q7-C	cycle power	transition 5.0 to 0.3Vdc at 2.5 sec
$\overline{\text{RELAY ENABLE}}$		

\*Node( - ) = A2J7-4

## Troubleshooting DC-To-DC Converter

Parallel NOR gates A4U1, A4U2 and A4U3A act as drivers and switch on FETs A4Q1,Q2,Q3 and Q4 through pulse transformer A4T1. NOR gate A4U3B turns off the FETs through pulse transformer A4T2 and transistors A4Q5 and A4Q6.

**Circuits Included.** On-Pulse Driver, Off-Pulse Driver, FET Switches and Drivers on A4 FET board.

**Setup.** The Main Troubleshooting Setup, Paragraph 3-40. Apply the ac mains voltage to the isolation transformer, set the external supply to 40Vdc, and switch on the LINE switch. Set the unit's output voltage to 20Vdc and current to above 1Adc. Using the DISPLAY SETTINGS switch. Verify that the OVERRANGE LED lights. See Figure 3-7 for waveforms.

### Inputs:

NODE (+)	NODE (-)	MEASUREMENT	SOURCE
A2J7-26(PWM-ON)	M	1.7µs, 20KHz pulse(see Waveform #1)	A2U15-1,A2J5 11, A4P1-A3
A2J7-25(PWM-OFF)	M	10µs, 20KHz pulse(see Waveform #2)	A2U16-5,A2J5-13,A4P1-A2

NODE (+)	NODE (-)	MEASUREMENT	SOURCE
A4P1-C1	A4P1-A1	10.6Vdc	AIU3-2
A4Q2-D	A4Q4-S	39Vdc	A1C51 (+),A4P1-22 to 25 A1C1(-),A4P1-16 to 18

### Outputs:

NODE (+)	NODE (-)	MEASUREMENT
A4Q1/Q2-G	A4Q2-S	(see Waveform #3)
A4Q3/Q4-G	A4Q4-S	(see Waveform #3)
A4Q2-S	A4Q4-D	(see Waveform #4)
A2J7-18	A2J7-4	(see Waveform #5)

If you replace the FETs, replace both the FETs and associated drive components as furnished in FET Service Kit. Agilent Part No. 5060-2866.



The FETs are static sensitive and can be destroyed by relatively low levels of electrostatic voltage. Handle the A4 FET board and the FETs only after you, your work surface and your equipment are properly grounded with appropriate resistive grounding straps. Avoid touching the FET's gate and source pins.

## Troubleshooting Bias Supplies

**+5V On A2 Control Board.** The PWM A2U22 includes a clock generator (40KHz set by A2R170, A2C79 and A2Q10), and a current limit (2Adc set by 0.15Vdc across A2R172). It turns off each output pulse using the difference between the voltage at voltage divider A2R161-A2R163 and the 2.5Vdc set by voltage regulator A2U21.

**Circuit Included.** +5Vdc bias supply circuitry from connector pins A2J5-1,3 through jumper A2W3 on A2 control board.

**Setup.** The Main Troubleshooting Setup, Page 53. Apply the ac mains voltage to the voltage transformer, and set the external supply to 0Vdc.

### Input:

NODE (+)	NODE (-)	MEASUREMENT	SOURCE
A2J7-22	A2J7-4	≈ 21Vdc	A1CR2,A1CR5

### Outputs:

NODE (+)	NODE (-)	MEASUREMENT
A2U22-7	A2J7-4	≈2 to 4Vdc sawtooth, 40KHz
A2U22-12,13	"	≈ 19V pk, 15µs pulses, 40KHz
A2Q9 (emit)	"	≈ 20V pk, 5µs pulses, 40KHz
A2U21-2	"	2.5 Vdc
A2R161, A2R163	"	2.5 Vdc

To check if load on + 5V is shorted, remove jumper A2W3

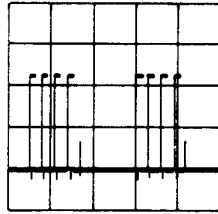

WAVEFORM 1 PWM ON  
2V/DIV  
20 $\mu$ s/DIV

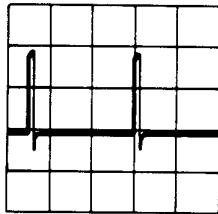

WAVEFORM 2 PWM OFF  
2V/DIV  
20 $\mu$ s/DIV

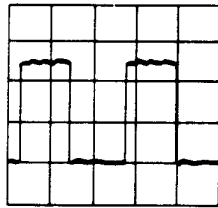

WAVEFORM 3 Vgs  
5V/DIV  
20 $\mu$ s/DIV

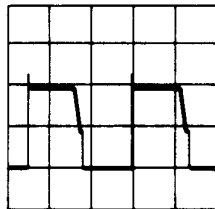

WAVEFORM 4 Vds  
20V/DIV  
20 $\mu$ s/DIV

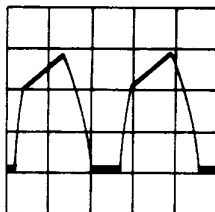

WAVEFORM 5 Ip MONITOR  
0.1V/DIV  
20 $\mu$ s/DIV  
OUTPUT SHORTED  
ISET = 17A (6030A)  
ISET = 120A (6031A)  
ISET = 50A (6032A)  
ISET = 5A (6035A)

Figure 3-7. Waveforms

**+15V On A2 Control Board.** Voltage regulator A2U11 regulates the voltage across resistor A2R99 to be 1.25Vdc. That sets the current through zener diode A2VR3 at 7.5mA. The output voltage is 1.25Vdc plus 11.7Vdc across A2VR3 plus the voltage across A2R100.

**Circuit Included.** +15Vdc bias supply circuitry from connector pin A2J5-5 through test point A2J7-2 on A2 control board.

**Setup.** The Main Troubleshooting Setup, Page 53. Apply the ac mains voltage to the isolation transformer, and set the external supply to 0Vdc.

**Input:**

NODE (+)	NODE (-)	MEASUREMENT	SOURCE
A2C52 (+)	A2C52 (-)	≈ + 25Vdc	A1U4

**Outputs:**

NODE (+)	NODE (-)	MEASUREMENT
A2J7-2	A2U11-3 (ADJ)	1.25Vdc
A2J7-2	A2VR3 (anode)	12.9Vdc
A2J7-2	A2VR3 (anode)	6.2Vdc
A2C50(+)	A2C50(-)	13.8Vdc

To check if load on +15V is shorted, remove jumper A2W1.

**-15 V On A2 Control Board.** Voltage regulator A2U12 regulates the voltage across resistor A2R103 to be 1.25Vdc.

**Circuit Included.** -15 Vdc bias supply circuitry from connector pin A2J5-6 through test point A2J7-21 on A2 control board.

**Setup.** The Main Troubleshooting Setup, Page 53. Apply the ac mains voltage to the isolation transformer, and set the external supply to 0Vdc.

**Input:**

NODE (+)	NODE (-)	MEASUREMENT	SOURCE
A2C55 (+)	A2C55 (-)	≈ - 25Vdc	A1U4

**Outputs:**

NODE (+)	NODE (-)	MEASUREMENT
A2J7-21	A2U12-3 (ADJ)	- 1.25Vdc
A2J7-21	A2VR4 (cath)	- 12.9Vdc
A2C54(+)	A2C54(-)	13.8Vdc

To check if load on -15V is shorted, remove jumper A2W2.

Refer to Down Programmer, for the + 10.6Vdc bias supply, and refer to OVP Circuit, for the + 2.5V bias supply.

## Troubleshooting Down Programmer

The down programmer discharges the output when either PWM OFF is generated or CV ERROR is more negative than about - 3Vdc. Comparator A5U1 triggers down programming when the voltage at A5U1-5 is less than about 4Vdc.

**Circuit Included.** Down programmer and 10.6V bias supply on A1 main board.

**Setup.** The Main Troubleshooting Setup, Page 53, except connect the external supply to the unit's + OUT ( + ) and - OUT ( - ) terminals. Apply the ac mains voltage to the isolation transformer. Set the external supply for an output voltage of 10Vdc and set current limit for 2.5 Amps. Set the power supply under test for a voltage setting of 8.0Vdc and current setting of 2.0Adc using the "DISPLAY SETTING" switch.

### Outputs:

NODE ( + ) *	EXTERNAL SUPPLY	MEASUREMENT
A5C1 ( + ) C3(6031A)	ON/OFF	10Vdc
A5VR1(K)	ON/OFF	6.5Vdc
A5U1-3	ON/OFF	0.2Vdc
A5CR1( K ) CR2(6031A)	OFF	0.6Vdc
A5CR1( K ) CR2(6031A)	ON	0.2Vdc
A5U1-1	OFF	0.5Vdc
A5U1-1	ON	5.0Vdc
A5R20 + (6030A/35)	OFF	< 0.001Vdc
A5R20 + (6030A/35)	ON	1.5Vdc
across A5R1(6031A)	OFF	< 0.001Vdc
across A5R1(6031A)	ON	0.10Vdc
across A5R14(6032A)	OFF	< 0.001Vdc
across A5R14(6032A)	ON	0.17Vdc

\* NODE (-) = A2J7-4

## Troubleshooting CV Circuit

V-MON, the output of CV Monitor Amp A2U2. is 1/40 (6030A); 1/4 (6031A); 1/12 (6032A); 1/100 (6035A) the voltage between + S and - S. CV Error Amp A2U3 compares V-MON to CV PROGRAM. Innerloop Amp A2U5A stabilizes the CV loop with input from A2U5B. The measurements below verify that the operational amplifier circuits provide expected positive and negative dc voltage excursion when the CV loop is open and the power mesh shut down.

**Circuits Included.** Constant Voltage (CV) Circuit and buffer amplifier A2U5B.

**Setup.** The Main Troubleshooting Setup, Page 53. Apply the ac mains voltage to the isolation bias transformer, and disconnect the external supply. Remove the + S jumper and connect A2J7-2 ( +15V) to + S. Set mode switch settings B4, B5 and B6 all to 0. Set VP to 0Vdc by connecting to P or set VP to + 5Vdc by connecting to A2J7-24 according to SETUP below. VP and P are on rear-panel terminal block.

### Outputs:

NODE (+)	NODE (-)	SETUP	MEASUREMENT
VM	A2J7-4		3.75Vdc
A2U5-1	"	VP = 0	-14Vdc
A2U3-6	"	VP = 0	-14Vdc
A2U5-1	"	VP = 5	4.7Vdc
A2U3-6	"	VP = 5	5.1Vdc
A2U5-7	"	short A2J7-24 to A2U5-5	+ 7.5Vdc

If the failure symptoms include output voltage oscillation, check if the CV Error Amp circuit is at fault by shorting A2U3-6 to A2U3-2. If oscillations stop, the CV Error Amp circuit is probably at fault.

### Troubleshooting CC Circuit

I-MON, the output of CC Monitor Amp A2U1, in volts is 5/17 (6030A); 1/24 (6031A); 1/10 (6032A); equals (6035A) the output current in amperes. CC Error Amp A2U4C compares I-MON to CC PROGRAM. Differentiator circuit A2U4A differentiates the inboard voltage sense and stabilizes the CC loop. Its output is summed with CC PROGRAM at CC Error Amp A2U4C.

The measurements below verify that the operational amplifier circuits provide expected positive and negative dc voltage gain when the CC loop is open and the power mesh shut down.

**Circuits Included.** Constant Current (CC) Circuit on A2 control board.

**Setup.** The Main Troubleshooting Setup, Page 53, except connect the external supply with polarity reversed to the unit's + OUT (-) and - OUT (+) terminals. Apply the ac mains voltage to the isolation transformer. Set the external supply to 3.0Adc constant current with a voltage limit in the range 5 to 20Vdc. Set IP to 0Vdc by connecting to P or set IP to +5Vdc by connecting to A2J7-24 according to SETUP below. Set mode switches B1, B2, and B3 AU to 0.

### Outputs:

NODE (+)	NODE (-)	SETUP	MEASUREMENT
IM	A2J7-4		0.88Vdc (6030A) 0.125Vdc (6031A) 0.30Vdc (6032A) 1.00Vdc (6035A)
A2U4-8	"	IP = 0	-14Vdc
A2U4-8	"	IP = 5	+14Vdc

If the failure symptoms include output current oscillation, check if the differentiator circuit is at fault by removing resistor A2R35. If oscillations stop, the differentiator is probably at fault.

### Troubleshooting OVP Circuit

Flip-flop A2U8A-A2U8D is set by comparator A2U8C and reset by OV CLEAR. TTL low at A2U18-12 inhibits the PWM. OVP Program Voltage on A2J7-7 is equal to Eout/250 (6035A), Eout/100 (6030A), Eout/30 (6032A), Eout/10 (6031A).

**Circuit included.** OVP Circuit and 2.5V bias supply on A2 control board.

**Setup.** The Main Troubleshooting Setup, Page 53, except connect the external supply to the unit's + OUT ( + ) and - OUT ( - ) terminals. Apply the ac mains voltage to the isolation transformer. Adjust the unit's OVP limit to 10Vdc. Set the external supply (EXTERNAL) as instructed below.

**Outputs:**

NODE ( - ) = A2J7-4

NODE ( + )	SET VOLTAGE EXTERNAL (Vdc)	SETUP	MEASUREMENT
A2U7-2	-		2.5Vdc
A2J7-7	-		0.1V (6030A) 1.0V (6031A) 0.33V (6032A) 0.04V (6035A)
A2J7-5	-		4.5Vdc
A2J7-13	5		Hi
A2J7-13	15		Lo
A2J7-13	5		Lo
A2J7-13	5	cycle power	Hi

---

**Note:** Connecting a test probe to either input of either comparator in the OV Flip Flop (pins A2U8-1, 6, 7,10,11 or 13 ) may cause the flip flop to change states and cause the probed input to be low.

---

**Troubleshooting PWM & Clock**

The inputs to gates A2U18A and A2U18B are the keys to PWM troubleshooting. The 20KHz Clock starts each PWM output pulse, and the pulse stops when any of the inputs to A2U18A or A2U18B goes low. The PWM is inhibited and prevented from initiating output pulses as long as any of the seven inputs is low.

**Circuit Included.** Pulse Width Modulator (PWM), Off-Pulse Oneshot, On-Pulse Oneshot, 20KHz Clock.

**Setup.** The Main Troubleshooting Setup, Page 53. Apply the ac mains voltage to the isolation transformer. Adjust the unit's current setting above 1.0 Adc. Set the external supply (EXTERNAL) and adjust the unit's voltage setting (INTERNAL) as instructed below.

**Inputs:**

NODE ( - ) = A2J7-4

NODE ( + )	SETUP	MEASUREMENT	SOURCE
A2J7-24		5.0Vdc	A2Q9, A2W3
A2U18-9		Hi	Remote Inhibit
A2U18-10		Hi	A2U15-10
A2U18-12		Hi	A2U15-13
A2U18-13		Hi	A5TS1, A4TS1
A2U18-5		Hi	A2U18-8
A2U18-2		Hi	A2U8-2
A2U18-1	set OUTPUT ADJUST for 1Vdc	Hi	A2U10-7

**Outputs:**

NODE ( + )	SET VOLTAGE (Vdc)		MEASUREMENT	
	EXTERNAL	INTERNAL		
A2U20-1	0	0	TTL sq wave, 320KHz	
A2U20-5	0	0	TTL sq wave, 40KHz	
A2U20-6	0	0	TTL sq wave, 20KHz	
A2U19-5	0	2	20KHz	
A2U19-6	0	2	20KHz	
A2U16-5	40	2	10µs pulse, 20KHz	
A2U16-5	40	0	Lo	
A2U16-4	40	20	48µs pulse, 20KHz	
A2U16-4	40	0	hi	
A2U15-1	40	20	1.7µs pulse, 20KHz	
A2U15-1	40	0	Lo	
+OUT	40	20	≈ 40Vdc (6030A)	} OVERRANGE
			≈ 8Vdc (6031A)	
			≈ 14Vdc (6032A)	
			≈ 80Vdc (6035A)	
+OUT	40	2	2.0Vdc (CV)	



# Principles of Operation

---

## Introduction

This chapter contains block diagrams, simplified schematics, and related descriptions of the power supply. The instrument can be thought of as comprising two major sections: the GPIB, microcomputer, and interface circuitry; and the power mesh and control circuits. Block diagrams represent the GPIB board, the front panel board, and the power mesh and control board. The descriptions associated with these block diagrams explain the function of each block without describing how individual components within the circuit accomplish that function. Detailed descriptions are provided only for those individual circuits whose operation may not be obvious to the user.

The circuit names and layouts of the block diagrams are the same as used on the complete schematics; however, some items, such as bias supplies, are left off the block diagrams for clarity. In general, circuits are described as they appear on the diagrams from left to right. Signal names that appear on the drawings are printed in capitals in the descriptions, as are front-panel labels for indicators and controls. Signal names that describe an operating mode or condition are active when that condition exists. For example, OT is high and  $\overline{OT}$  is low if an overtemperature condition exists. Signal flow is from left to right and top to bottom, unless arrows indicate otherwise.

The following paragraphs describe the GPIB and the front-panel board. These circuits provide the interface between the power mesh circuits and the controller and/or operator. The GPIB and front-panel boards are referenced to earth common. Isolation is achieved by optical isolators on the GPIB board. Data is sent between boards serially.

---

## GPIB Board

Circuits on the GPIB board, see Figure 4-1, provide the interface between the power supply and the user, generate the fault/inhibit and relay controls signals (DFI/RI), and supply the analog control and reference signals for the power mesh and readback circuit. Two microprocessors (primary and secondary) control all data communication between the power supply and the user. Additional circuits on the GPIB board include the serial interface ports, address switches, an EEPROM, and status registers.

### Primary Microprocessor

The primary microprocessor controls the GPIB/serial link interface, the front panel data communication, and the DFI/RI interface. It communicates with the secondary microprocessor through two serial link data lines that are optically coupled to provide the proper isolation of the user interface from the power mesh. The GPIB board also has a ROM, which contains the operating firmware, and a RAM, which stores variables such as programmed voltage and current and readback values.

### Address Switches

The primary microprocessor determines the GPIB address by reading the address switch settings. Two of the address switches determine the power-on SRQ state and the DFI/RI port setting.

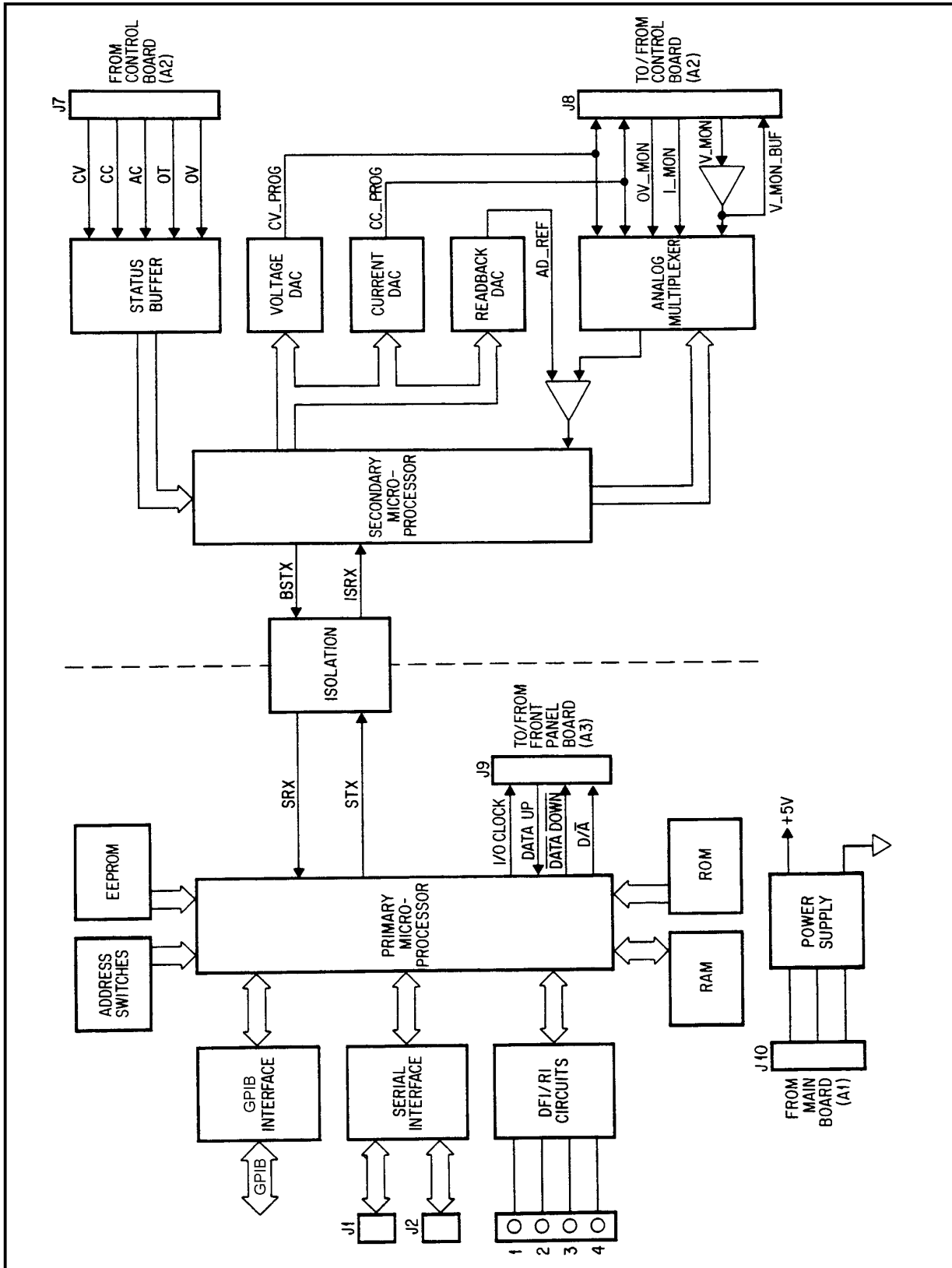

Figure 4-1. GPIB Block Diagram

## EEPROM

The primary microprocessor determines the power supply ID, start-up parameters, calibration constants and scale factors by reading the factory-initialized EEPROM.

## Isolation

Two optical isolators transmit serial data between the primary and secondary microprocessors while maintaining electrical isolation between the controller/user-interface and the power mesh.

## Secondary Microprocessor

The secondary microprocessor translates the serial data from the primary microprocessor into a parallel data bus and other control signals. Values are loaded into the voltage, current, and readback DAC via the data bus. The secondary microprocessor also controls the analog multiplexer, which is used when reading back the actual output.

## Digital-to-Analog Converters

Output voltage and current are controlled by two 12-bit DACs whose digital inputs are directly connected to the secondary microprocessor. The microprocessor programs the DACs according to data received over the GPIB or from the front panel rotary pulse generator. The DAC circuits also include buffers and compensation amplifiers.

The 12-bit readback DAC is connected to the input of a comparator where its output is compared to the unknown voltage output of the analog multiplexer. The secondary microprocessor programs the output of the readback DAC starting with the MSB and continuing down to the LSB. Each bit is programmed either on or off until the output of the DAC is closest to the unknown voltage output of the multiplexer. At this point, the microprocessor returns the programmed value of the readback DAC.

## Analog Multiplexer

The analog multiplexer selects one of five input voltages to be compared to the readback DAC. This comparison allows the microprocessor to determine the value of the input voltage. The five inputs of the multiplexer are: CV\_PROG and CC\_PROG, which are only used during selftest, at power-on, or in response to the TEST? query when the supply is disabled; OV\_MON, which represents the overvoltage trip setting; and I\_MON and V\_MON, which represent the measured values of output current and voltage.

## Status Inputs

The status inputs from the main board provide the following status information to the secondary microprocessor. They are: CC, which is set when the supply is operating in constant current mode; CV, which is set when the supply is in constant voltage mode; AC\_FAULT, which signals that ac power has dropped below the minimum operating voltage of the supply; OT, which indicates an overtemperature condition has occurred on the supply; and OV, which indicates an overvoltage has occurred on the supply.

---

## Front Panel Board

The front-panel board, see Figure 4-2, contains the VOLTS and AMPS display circuits, the rotary pulse generator (RPG) and RPG decoders, five pushbutton switches, mode indicators, and the OVP ADJUST potentiometer. Data from the microprocessor is shifted to the display circuits via  $\overline{\text{DATA DOWN}}$ , and data from the front-panel controls circuits is shifted to the microprocessor via DATA UP. Circuits on the front-panel board operate from bias voltages supplied from the GPIB board, and are referenced to the same common as the GPIB board (earth ground). The OVP ADJUST potentiometer is part of the power mesh control circuitry (referenced to power supply negative output), and is not connected to any circuits on the front-panel board.

## Address Latches and Decoders

DATA DOWN bits received while  $D / \overline{A}$  is low are latched and decoded in this circuit, which then steers clock pulses to the addressed circuit when  $D / \overline{A}$  goes high.

## Volts and Amps Output Ports and Displays

These circuits display values sent by the microprocessor via DATA DOWN. Normally, these are the actual output voltage and current readings. Pressing the DISPLAY SETTINGS switch causes the microprocessor to send the voltage and current values that have been sent by the controller (remote) or RPG (local). If the unit is in CV mode, the voltage display should show the same reading for actual and set values; the current display will switch from the actual value to the current limit. In CC mode, the current readings will be the same and the voltage display will switch from actual value to the voltage limit. Pressing the DISPLAY OVP switch causes the voltage display to show the OVP trip voltage that has been set.

The microprocessor also uses the readout to display the GPIB address switch settings, self test error messages, and readback overrange conditions.

## RPG and Latches

When rotated, the RPG produces two pulse trains that are 90 degrees phase shifted from each other, with the phase relationship determined by the direction of rotation. This circuit contains two flip-flops that monitor the RPG outputs. The output of one flip-flop goes low to indicate that the RPG has been rotated, and the output of the other goes low to indicate CW rotation or high to indicate CCW rotation. This data is loaded into an input port when  $D / \overline{A}$  is low, and the flip-flops are set back to their quiescent state by clock pulses from the address decoder when the input port is addressed.

Because the microprocessor reads the input approximately every millisecond, it can determine if the RPG is being turned rapidly (for a large change) or slowly (for fine adjustment), and the microprocessor varies the rate it changes the DAC inputs accordingly.

## Front-Panel Switches and Input Port

Five front-panel pushbutton switches plus the two RPG flip-flop outputs are connected to this input port. Data is loaded when  $D / \overline{A}$  is low, and is shifted out by clock pulses from the address decoders. The microprocessor reads data in via DATA UP approximately every millisecond, and checks the switches every 10 ms, thereby ensuring that even rapid switch operations will be captured.

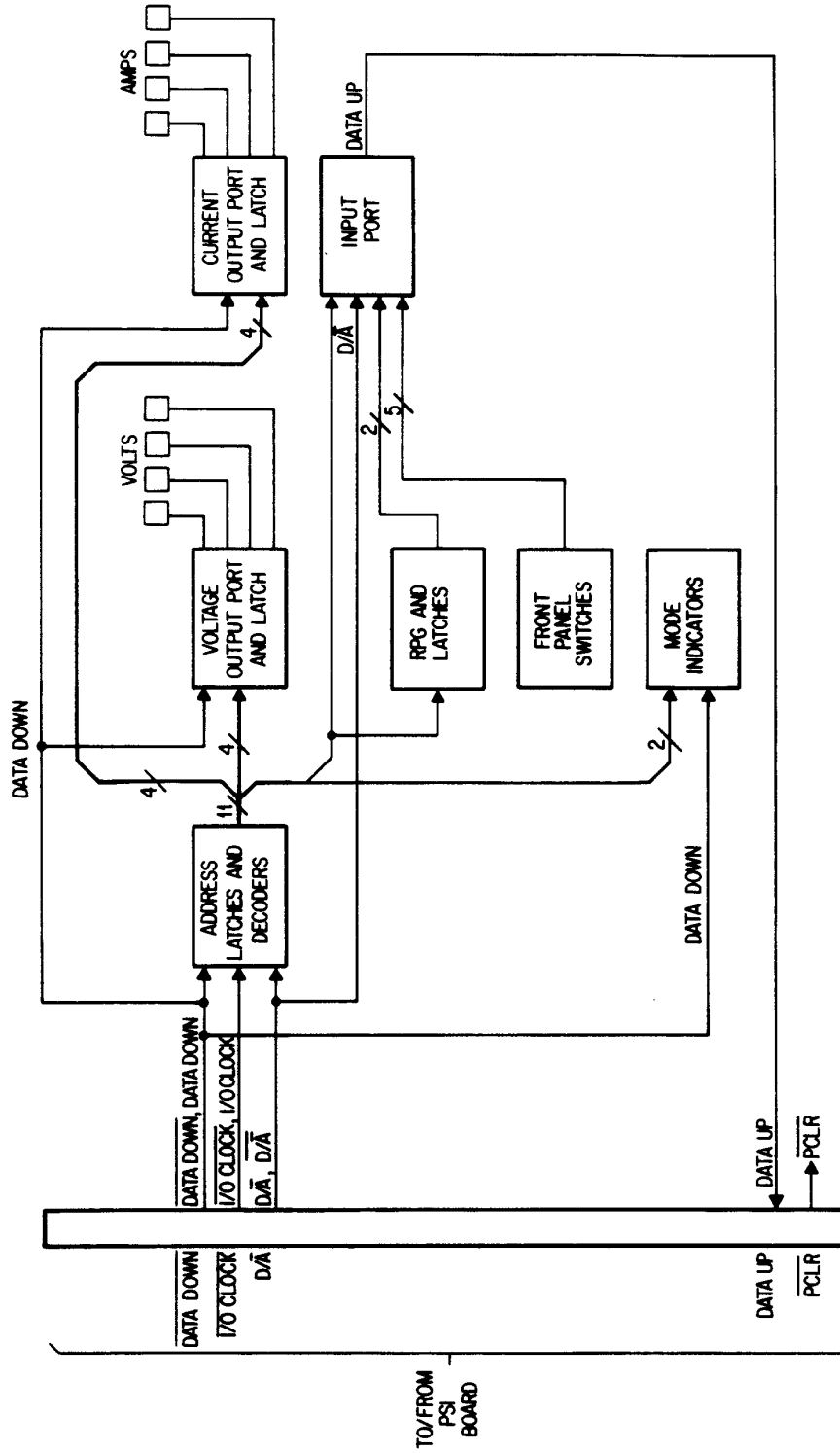

Figure 4-2. Front Panel Block Diagram

## Mode Indicators

The front-panel mode indicators are controlled by the microprocessor via DATA DOWN and the mode indicator output ports and latches. DATA DOWN signals are shifted in by clock pulses from the address decoders.

## OVP Adjust Control

The OVP ADJUST potentiometer sets the voltage level at which the overvoltage protection (OVP) circuit trips.

## Power Clear

The power clear signal ( $\overline{\text{PCLR}}$ ) from the GPIB board goes low when the unit is turned on, and remains low until the bias power supplies have stabilized. This low level resets the display-circuit latches on the front panel board, causing all indicators and display segments to turn on and remain on until the microprocessor updates the display (approximately one second).

---

## Power Mesh and Control Board

The basic operating concepts of the power mesh and control circuits are described in the following paragraphs. The beginning paragraphs describe the basic difference between an autoranging power supply and a conventional CV/CC power supply in terms of the available output, and provide an overview of the basic theory of operation. Later paragraphs describe the functions of the individual circuits on the power mesh and control board.

### Overview

The basic difference between an autoranging power supply and conventional types of Constant Voltage/Constant Current (CV/CC) power supplies can be seen by comparing the maximum-output-power characteristics of each. A conventional CV/CC power supply can provide maximum output power at only one combination of output voltage and current, as shown in Figure 4-3a. The range of a power supply can be extended by designing an instrument with two or more switch-selectable voltage/current ranges within the maximum power-output capability, as shown in Figure 4-3b. An autoranging power supply provides maximum output power over a wide and continuous range of voltage and current combinations, as shown in Figure 4-3c, without the operator having to select the proper output range.

The unit is a flyback-type switching power supply, so-called from the flyback technique of generating high voltage in television receivers. Energy is stored in the magnetic field within a transformer while current flows in the primary, and is transferred to the secondary circuit when current flow in the primary is turned off. Current flow in the primary is controlled by FET switches which are turned on and off at a 20KHz rate by a pulse width modulator. Regulation is accomplished by controlling the on time of the FET switches. On pulses are initiated by a clock circuit. Off pulses are initiated when current flow in the primary has stored enough energy for the output circuit, which is determined as follows.

Sense voltages representing the actual output voltage and current are compared to reference voltages set either by front-panel controls or remote programming signals. These comparisons produce a control voltage, which represents the amount of power required by the output circuit. Current flow in the primary circuit produces a ramp voltage that represents the amount of energy being stored for transfer to the output circuit. An off pulse is generated when the ramp voltage exceeds the control voltage. It can be seen that the power available in the output circuit corresponds to the duty cycle of the FET switches.

Figure 4-4 shows the relationship of various signals associated with the FET on/off cycle.

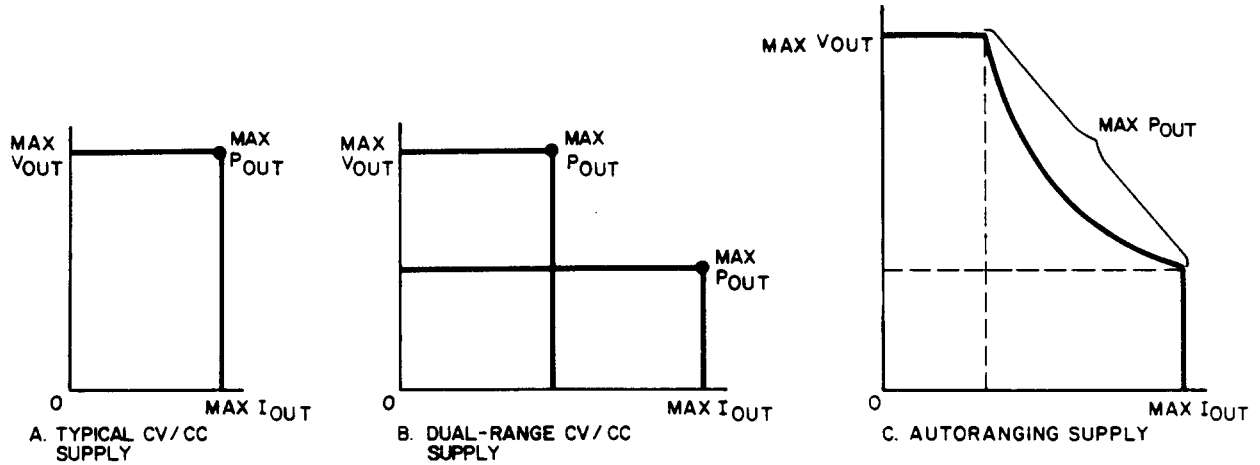

Figure 4-3. Output Characteristics; Typical, Dual Range, and Autoranging Supplies

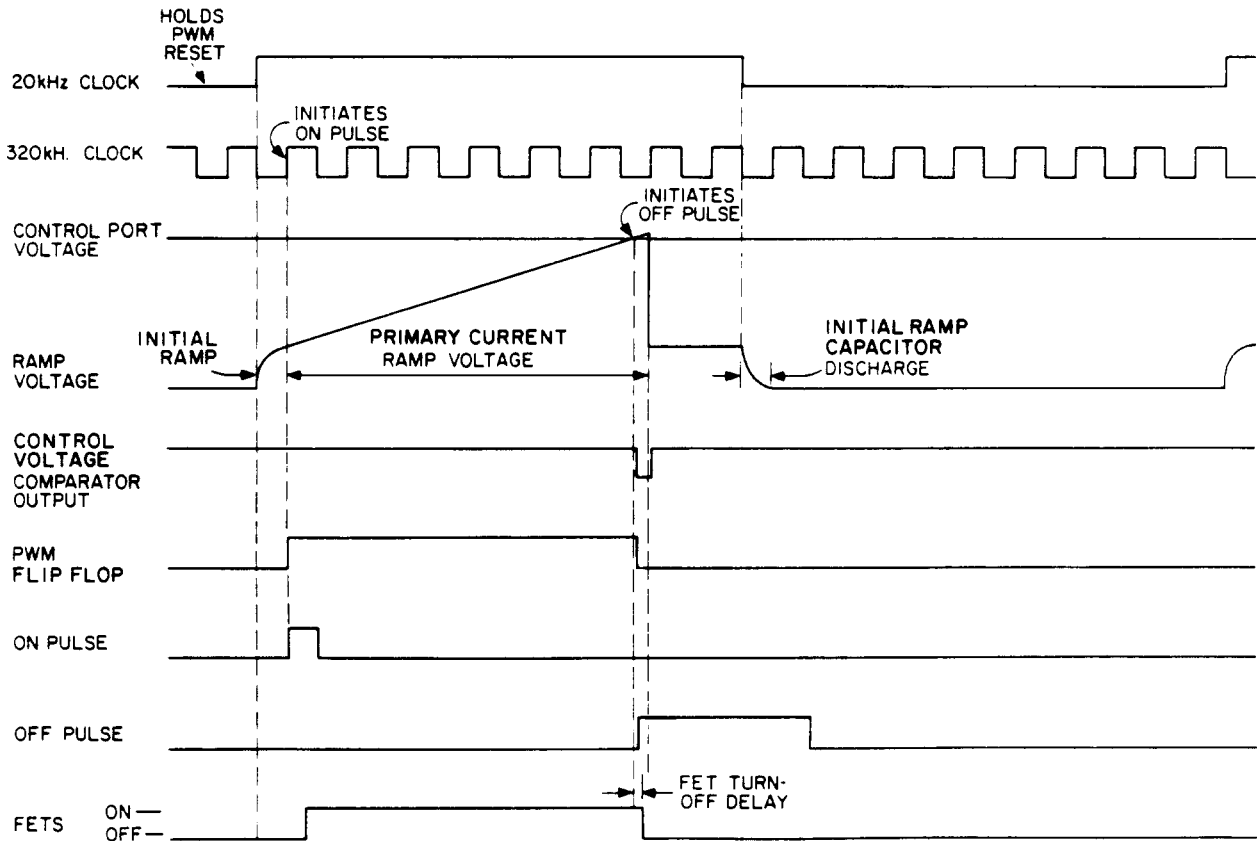

Figure 4-4. FET Control Signals Timing Diagram

## Power Mesh

Figure 4-5 is a block diagram of the power mesh. These circuits convert the ac input power to approximately 320Vdc, and convert this dc voltage to the proper dc output voltage.

**Input Circuits.** Primary power is connected through the AC Input Filter to the LINE switch and to the normally open contacts of the Inrush-Limit relay. When LINE switch is closed, current flows through the inrush current limiting resistor and the normally closed relay contacts to the Bridge Rectifier/Voltage Doubler. This circuit is jumper connected as a voltage doubler for 100 or 115Vac operation and as a full-wave bridge charges to about 320Vdc for any input voltage. Current also flows through the Voltage Select Switch to the Bias Power Supplies, which provide the operating voltages for the power supply. The Voltage Select Switch connects the primary windings of the bias transformer for operation at 100, 120, 220, or 240Vac. The Voltage Select Switch also supplies 120 Vac to the fan and Relay Circuits.

The Inrush Limit relay is energized by  $\overline{\text{RELAY ENABLE}}$ , which is generated on the control board after the unit has checked that various operating voltages are within acceptable limits. After a delay of approximately 2-1/2 seconds, which allows the Input Filter capacitors to charge, the relay is energized, bypassing the Inrush Limit resistor. A switch on the main board switches in more Inrush Limit resistance for 220 or 240Vac operation.

**DC To DC Conversion.** Current flow from the input rails through the power transformer is controlled by FET switches. On and off pulses for the FETs are generated on the control board, as will be described shortly. On pulses are applied through the On Driver and pulse transformer T1 to the gates of both pairs of FETs. Although the on pulse is only about 1.7 $\mu$ s duration, the FETs' input capacitance holds the FETs on after the on pulse has disappeared.

When the FETs are turned on, current flows through the primaries of Power Transformer T2 and Primary-Current Monitor Transformer T1. The Output Diodes are reverse biased and block current flow in the T2 secondary. Consequently, energy is stored in the field that builds around the T2 transformer windings. The longer that voltage is applied to the primary, the more energy is stored. Current flow in the secondary of T1 is connected to the control board, where it generates a ramp voltage. The amplitude of this linearly increasing voltage corresponds to the amount of current flow through the T2 primary; therefore, it represents the amount of energy being stored in the field around T2. It is this ramp voltage that is compared to a control voltage to determine when the FETs should be turned off.

Off pulses turn on Q5 and Q6, which discharge the FET gates, thereby turning the FETs off. When the FETs are turned off, the collapsing magnetic field reverses the polarity across the T2 primary and secondary, and current flows from T2 secondary through output diodes to charge the output filter capacitors. The level to which the output capacitors are charged corresponds to the length of time that the FETs are on and current flows in T2 primary.

Leakage inductance of T2 attempts to maintain current flow in the primary circuit when the FETs turn off. Flyback diodes in the FET board protect the FETs by conducting this current around the FETs and back to the input filter.

**Down Programmer.** This circuit allows the output voltage to be lowered rapidly when required. In order to lower the output voltage it is necessary to discharge the output filter capacitors (typically, through the load). In situations that require the output voltage to drop more rapidly than can be accomplished through the load, the Down Programmer discharges the capacitors and pulls the output line low.  $\overline{\text{DOWN PROGRAM ENABLE}}$  is generated on the control board. Six conditions can trigger down programming: programming of a lower output voltage, overvoltage, overtemperature, remote disable, remote inhibit, or primary power failure.

The + 10.6Vdc bias supply for the Down Programmer stores enough energy in its input capacitor to operate the Down Programmer after loss of primary power. This ensures that the Down Programmer will be able to discharge the output circuit completely when primary power is turned off.

The Agilent 6030A/35A units contain an active bleed circuit, connected across the output, which allows regulation at low output current and/or low output voltage levels. This circuit also minimizes dielectric absorption effects, which show up as noise on the output of the supply.

**Current Monitor Resistor.** A highly stable resistance element in the -output line develops the CURRENT SENSE voltage, which is proportional to the power supply output current. This signal is supplied to the CC Circuit on the control board.



## Control Board

Figure 4-6 is a block diagram of the control board. These circuits monitor the power supply operation and provide the signals that control the power mesh.

**+ 5V Bias Supply.** This circuit operates from the + 5V Unregulated voltage from the main board, and generates + 5V and + 2.5V used by circuits on the control board. Regulated + 5V is also supplied back to the main board for use by the relay circuits, FET Drivers, and Down Programmer. The + 5V Bias Supply is regulated by a pulse width modulator chip that is synchronized by the 40KHz clock signal to the main Pulse Width Modulator; this eliminates the possibility of frequency modulated signals on common lines.

**Bias Voltage Detector and Relay Driver.** The Bias Voltage Detector monitors + 5V Unregulated to determine when bias voltages are sufficient to ensure proper operation. After turn-on, as the output of the + 5V bias supply rises from 0Vdc through approximately 1Vdc, three transistor switches in the Bias Voltage Detector turn on. They inhibit the relay driver and the on-pulse driver, and generate the power-clear signal. The switches remain on until the + 5V Unregulated input exceeds approximately 13 volts, which is sufficient to ensure both a stable + 5V output and adequate FET drive voltage.

$\overline{\text{PCLR}}$  holds various circuits reset until after the bias voltages stabilize and control circuits are certain to be working.  $\overline{\text{RELAY ENABLE}}$ , which is delayed for approximately 2 ½ seconds by the Time Delay Circuit, drives relay circuits on the main board that short out inrush current limiting resistors after input filter capacitors are charged up.  $\overline{\text{RELAY ENABLE}}$  cannot occur until bias voltages have stabilized and time delay has expired.  $\overline{\text{ON - PULSE INHIBIT}}$  shorts ON pulses to ground whenever bias voltage is insufficient to ensure proper operation.

Note that Bias Voltage Detector inhibits power supply operation in two circumstances: while bias voltages are stabilizing after turn-on, and when ac input drops below an adequate level (brownout).

**+ 15V Bias Supply.** This circuit produces the + 15V and +5.9V bias voltages. It also produces the reference voltage used by the CC and CV Current Sources.

**Time-Delay Circuit.** This circuit generates the signal that delays RELAY ENABLE for approximately 2 ½ seconds after cessation of an ac fault (Dropout or High AC). The AC FAULT signal is extended for the duration of the time delay and supplied to: the 1.25KHz counter in the 20KHz Clock Circuit to reset the counter, so that the time delay output of the Time Delay Circuit will remain set; the Pulse Width Modulator (PWM) to inhibit the PWM in case of an ac fault.

**AC Dropout Detector.** The AC Dropout Detector operates to shut down the power mesh when primary power is turned off or lost. The circuit monitors the 120Hz signal (full-wave rectified 60 Hz ac) from the bias transformer on the main board. Dropout is detected by a ramp circuit that is reset by the 120 Hz pulses. If the ramp is not reset within approximately 20 milliseconds of the previous reset, the circuit generates AC FAULT, which is supplied to the Time Delay Circuit to disable  $\overline{\text{RELAY ENABLE}}$  and the PWM.

**High AC Detector.** The High AC Detector protects the power supply from damage from ac power line surges. The circuit contains a comparator that monitors the voltage level of the 120Hz signal. If this voltage exceeds a safe operating level, the circuit generates the  $\overline{\text{HIGH AC}}$  signal, which is ORED with  $\overline{\text{AC DROPOUT}}$ . Either can cause generation of the AC FAULT signal.

**Turn-On Overshoot Control.** The Turn-On Overshoot Control Circuit prevents output overshoot when the Pulse Width Modulator is turned back on after having been turned off. The circuit monitors the  $\overline{\text{PWM OFF}}$  signal from the Pulse Width Modulator. If the PWM is turned off because of  $\overline{\text{INHIBIT}}$  (from GPIB),  $\overline{\text{AC FAULT}}$ ,  $\overline{\text{OT}}$  (overtemperature), or  $\overline{\text{OV}}$  (overvoltage), the power supply output will be down programmed to zero, and both the CC and CV Circuit outputs will increase to maximum in an attempt to restore the output level. This circuit holds the CONTROL PORT at a low level to prevent output overshoot when  $\overline{\text{PWM OFF}}$  is removed.

**Constant Current (CC) Circuit.** The Constant Current Circuit compares the CURRENT SENSE voltage level to CC PROGRAMMING VOLTAGE to produce CC CONTROL SIGNAL. CURRENT SENSE is developed across the current-monitor resistor on the main board, and is proportional to the power supply output current. CC PROGRAMMING VOLTAGE comes from one of a number of sources as selected by the rear-panel mode switches, and represents the desired output current or current limit.

CC CONTROL SIGNAL varies from approximately -1 to +0.5 volts when the power supply is in constant current mode, and is most positive when the CC Circuit is calling for maximum power supply output. CC CONTROL SIGNAL is connected through an output diode, CR11, shown at the wired-OR gate that is the CONTROL PORT.

The amplified current-sense signal is brought out of the CC Circuit as I-MON (current monitor). I-MON is connected to the rear-panel IM terminal, and varies from 0 to + 5 volts as the output current varies from zero to full scale.

A differentiator circuit in the CC Circuit block provides increased stability for highly reactive loads.

**Constant Voltage (CV) Circuit.** Operation of the CV Circuit is similar to the CC Circuit. The CV Circuit compares the output SENSE voltage to the CV PROGRAMMING VOLTAGE to produce the CV CONTROL SIGNAL. + OUT and - OUT are also supplied to the circuit as protection in case the sense leads are inadvertently disconnected. CV CONTROL SIGNAL also varies between approximately -1 to + 0.5 volts, and is connected through diode CR24 to the CONTROL PORT.

The buffered voltage-sense signal is brought out of the CV Circuit as V\_MON (voltage monitor). V\_MON is connected to the rear-panel VM terminal, and varies from 0 to + 5 volts as the output voltage varies from zero to full scale. Both V-MON and I-MON are referenced to monitor common ( M).

The CV Circuit also produces the  $\overline{\text{DOWN PROGRAM ENABLE}}$  signal when the CV PROGRAMMING VOLTAGE is changed quickly from a relatively high level to a relatively low level. This allows the power supply output voltage to be lowered more rapidly than if the output filter capacitors had to be discharged solely through the load.

**CC And CV Current Sources.** This circuit generates constant currents that are connected to front-panel VOLTAGE and CURRENT potentiometers of non-- GPIB units to develop the CC and CV programming voltages.

**Mode Switches.** The rear-panel mode switches select the source of the CC and CV PROGRAMMING VOLTAGES. For GPIB units, the programming voltages are supplied via the GPIB board, and are connected through mode switches B1 and B4 to the CC and CV Circuits. For non-- GPIB units, mode switches B2, B3, and B5, B6 are closed. The CC and CV Current Source outputs are connected through B2 and B5 to the front-panel CURRENT and VOLTAGE potentiometers, and the voltages developed across the potentiometers are connected through B3 and B6 to the CC and CV Circuits.

Remote analog programming voltages can be supplied to the CC and CV Circuits from the rear-panel IP and VP terminals. IP and VP are referenced to program common ( P).

**Primary Current Ramp.** The output from the primary current-monitor transformer on the main board is developed across R116 and R117 to produce a ramp voltage that represents the amount of energy being stored in the power transformer for transfer to the power supply output circuits. This ramp voltage is connected to the Power Limit Comparator and to the Control Voltage Comparator.

**Power Limit Comparator.** The power supply maximum output power curve (shown in Specifications Table in the Operating Manual) is defined by this circuit. The PRIMARY CURRENT RAMP voltage, which represents the amount of power being supplied to the power supply output, is compared to a voltage which represents the maximum amount of power that the power supply can supply safely. If the ramp voltage exceeds the limit voltage, the POWER LIMIT signal is produced to turn off the PWM.

The Power Limit Comparator Circuit includes a dynamic primary-current-limit circuit, which decreases the primary current limit to maintain the output power curve at specified limits.

**Control Voltage Comparator.** This circuit compares the voltage at the CONTROL PORT (represents power required at output) with PRIMARY CURRENT RAMP voltage (represents energy being stored for transfer to output). When RAMP voltage exceeds CONTROL PORT voltage, the Control Voltage Comparator generates the  $\overline{\text{CONTROL LIMIT}}$  signal to turn the PWM off. The CONTROL PORT is biased to approximately + 1.3 volts. Whichever control signal, CC or CV, is more negative (calling for less output power) forward biases its output diode and determines the voltage at the CONTROL PORT.

As can be seen from the waveforms in Figure 4-4, there is a delay between the time when PRIMARY CURRENT RAMP voltage exceeds the CONTROL PORT voltage and the time when the FETs turn off. This delay consists of the comparator switching time, gate delays, transformer delay, and FET turn-off time, and it results in a certain amount of power being transferred to the output after the desired off time. If the CONTROL PORT voltage is at a very low level (unit supplying little or no output power), this power may exceed the amount required by the load. To eliminate the delay, the Control Voltage Comparator includes an initial ramp circuit that generates a small ramp voltage before the FETs are turned on. The added ramp voltage starts with the 20KHz clock pulse, and causes the combined-ramp voltage to exceed the CONTROL PORT voltage earlier, thereby effectively eliminating the FET turn-off delay.

**Status Drivers.** Inputs from the CC and CV Circuits indicate which circuit, if either, is regulating the power supply output. If neither circuit is regulating the output (load calling for more power than the power supply can deliver), logic circuits within Status Driver block determine that output is unregulated.

In GPIB units, CC and CV signals go to the microcomputer, which will take appropriate action, including lighting front-panel indicators. In non-- GPIB units, Status Driver outputs go to front-panel indicators.

**20KHz Clock.** This circuit contains a 320KHz crystal oscillator and dividers that produce 40KHz, 20KHz, and 1.25KHz signals. Both the 320KHz and 20KHz signals are supplied to the PWM, with the 20KHz signal controlling the repetition rate of the PWM.

The 40 KHz signal is supplied to the +5V Bias Supply Circuit to synchronize the PWM in that circuit to the main power supply PWM. The 1.25KHz output is supplied to the Time Delay Circuit for generating the time delay used to control the power supply turn-on sequence.

The 1.25KHz signal is subsequently disabled by the AC FAULT output from the Time Delay Circuit at the end of the time delay.

**Pulse Width Modulator (PWM).** The PWM generates the ON and OFF pulses that control the power FETs in the power mesh. ON pulses are generated at a 20KHz rate, and, as can be seen in Figure 4-4, are initiated by the first 320KHz dock pulse after the start of the 20KHz clock pulse. When the FET switches turn on, current flows through the Primary Current Monitor transformer on the main board, and the Primary CURRENT RAMP voltage starts to rise. OFF pulses are normally initiated when CONTROL LIMIT becomes active (low), indicating that the ramp voltage has exceeded the CONTROL PORT voltage. However, an off pulse can be initiated by any one of a number of other signals.

An overtemperature ( $\overline{\text{OT}}$ ), overvoltage ( $\overline{\text{OV}}$ ), remote inhibit,  $\overline{\text{AC FAULT}}$  condition or an  $\overline{\text{INHIBIT}}$  signal from GPIB will initiate an OFF pulse, and will also trigger the Down Programmer to reduce output voltage to zero. These conditions will also cause  $\overline{\text{PWM OFF}}$  to be sent to the TurnOn Overshoot Control Circuit.

OFF pulses can also be initiated by  $\overline{\text{POWER LIMIT}}$  and by the trailing edge of the 20KHz clock signal. The 20KHz clock signal ensures that even if nothing else, such as  $\overline{\text{CONTROL LIMIT}}$  or  $\overline{\text{POWER LIMIT}}$ , initiates an OFF pulse, the FET duty cycle will be limited to less than 50%.

**Overvoltage Protection (OVP).** The OVP circuit monitors the power supply output voltage and compares it to a preset limit determined by a front-panel OVP ADJUST potentiometer. If the output voltage exceeds the limit, the OVP Circuit initiates a PWM OFF pulse, which also triggers the Down Programmer. The OVP Circuit latches itself until it receives  $\overline{\text{OV CLEAR}}$  or ac power is turned off.







# Replaceable Parts

## Introduction

This chapter contains information for ordering replacement parts. Table 5-1 lists parts in alpha-numeric order by reference designators and provides the following information:

- Reference Designators. Refer to Table 5-1.
- Agilent Technologies model in which the particular part is used.
- Agilent Technologies Part Number.
- Description. Refer to Table 5-2 for abbreviations.

Parts not identified by reference designator are listed at the end of Table 5-4 under Mechanical and/or Miscellaneous.

**Table 5-1. Reference Designators**

A	Assembly
B	Blower
C	Capacitor
CR	Diode
DS	Signaling Device (light)
F	Fuse
FL	Filter
G	Pulse Generator
J	Jack
K	Relay
L	Inductor
Q	Transistor
RT	Thermistor Disc
S	Switch
T	Transformer
TB	Terminal Block
TS	Thermal Switch
U	Integrated Circuit
VR	Voltage Regulator (Zener diode)
W	Wire Jumper
X	Socket*
Y	Oscillator

\* Reference designator following "X" (e.g. XA2) indicates assembly or device mounted in socket.

---

## Ordering Information

To order a replacement part, address order or inquiry to your local Agilent Technologies sales office. Specify the following information for each part: Model, complete serial number, and any Option or special modification (J) numbers of the instrument; Agilent Technologies part number; circuit reference designator; and description. To order a part not listed in Table 5-4, give a complete description of the part, its function, and its location.

**Table 5-2. Description Abbreviations**

ADDR	Addressable
ASSY	Assembly
AWG	American Wire Gauge
BUFF	Buffer
CER	Ceramic
COMP	Carbon Film Composition
CONV	Converter
DECODER/DEMULTI	Decoder/Demultiplexer
ELECT	Electrolytic
EPROM	Erasable Programmable Read-Only Memory
FET	Field Effect Transistor
FF	Flip-Flop
FXD	Fixed
IC	Integrated Circuit
INP	Input
LED	Light Emitting Diode
MET	Metalized
MOS	Metal-Oxide Silicon
OP AMP	Operational Amplifier
OPTO	Optical
OVP	Over Voltage Protection
PCB	Printed Circuit Board
PORC	Porcelain
POS	Positive
PRIOR	Priority
ROM	Read-Only Memory
RAM	Random Access Memory
RECT	Rectifier
REGIS	Register
RES	Resistor
TBAX	Tube Axial
TRIG	Triggered
UNI	Universal
VAR	Variable
VLTG REG	Voltage Regulator
WW	Wire Wound



**Table 5-3. Replaceable Parts List**

Ref. Desig	Agilent Model	Agilent Part Number	Description
A1	6030A	06030-61032	Main Board Assembly
	6031A	06031-61032	"
	6032A	06032-61032	"
	6035A	06030-61033	"
C1,2,4,5,6,8	all	0180-4528	cap 1800µF 200V
C9	all	0160-5932	cap 0.47µF 250V
C10	6030A,35A	0180-3699	cap 470µF 20% 35V
	6031A,32A	0180-0426	cap 22µF 250V
C11,12	6030A, 31A	0160-5895	cap 0.047µF
	6032A, 35A	0160-5933	cap 0.022µF 10%
C13,14	6030A	0180-3702	cap 1600µF 125V
	6031A	0180-3425	cap 5500µF 40V
	6032A*	0180-3492	cap 2600µF 75V
	6035A	0180-4240	cap 900µF 350V
C15,16	6030A,32A,35A	0180-3587	cap 1000µF 50 V
	6031A	0180-3425	cap 5500µF 40V
C17,18	6030A,32A,35A	0180-0291	cap 1µF 35V
	6031A	0180-3587	cap 1000µF 50V
C19	6030A*	0160-0269	cap 0.047µF 20%
	6031A	0180-0291	cap 1µF 35V
	6032A*	0160-5286	cap 0.47µF 20%
	6035A*	0180-0904	cap 0.05µF 1KV
C20	6030A,35A*	0160-6392	cap 0.047µF 20%
	6031A	0180-0291	cap 1µF 35V
	6032A*	0160-7732	cap 0.47µF
C21	6030A,35A*	0160-6392	cap 0.047µF
C22	6030A,35A*	0160-6392	cap 0.047µF 20%
	6031A*	0160-5377	cap 2.2µF 10% 63V
	6032A*	0160-7732	cap 0.47µF
C23	6030A,35A*	0160-6392	cap 0.047µF
	6031A*	0160-7732	cap 0.47µF
C24	6032A*	0160-4281	cap 2200pF 20%
C25	6030A*	0160-0269	cap 0.047µF 20%
	6031A*	0160-5377	cap 2.2µF 10% 63V
	6032A*	0160-5286	cap 0.47µF 20%
	6035A*	0180-0904	cap 0.05µF 1KV
	6031A*	0160-5377	cap 2.2µF 10% 63V
C26	6032A*	0160-4281	cap 2200pF 20%
	6032A*	0160-4281	cap 2200pF 20%
C27	All	0160-6805	cap 0.01µF 400V
C27	6031A*	0160-4281	cap 2200pF 20%
C28	6031A*	0160-7732	cap 0.47µF
C29	6030A,32A,35A	0160-4323	cap 0.047µF 20%, 250V
	6031A*	0160-4281	cap 2200pF 20%
C30	6030A,32A,35A	0160-7606	cap 1µF 20%
C32	6031A	0160-4323	cap 0.047µF 20%, 250V
C33	6031A	0160-7606	cap 1µF 20%
C34	All	0160-6805	cap 0.01µF 400V

\* Part of output filter, mounted on output bus bars.

**Table 5-3. Replaceable Parts List (continued)**

Ref. Desig	Agilent Model	Agilent Part Number	Description
CR1	all	1901-0731	power rectifier 400V
CR2	all	1901-0731	power rectifier 400V 1A
CR3,4	all	1901-0050	diode, switching 80V 200mA
CR5-13	all	1901-0731	power rectifier 400V
DS1	all	1990-0517	LED, visible
F1	all	2110-0001	fuse 1AM, 250V
F2	all	2110-0671	fuse 250mAM, 125V
J2	all	1251-5384	connector, 3-pin
J5	all	5060-2877	ribbon cable (W8)
J6	all	5060-2878	ribbon cable (W7)
J7,8	all	1251-0600	connector, single contact
J9,10	all	1251-5613	connector, single contact
L,N,P	all	1251-5613	connector, single contact
J11-14	all	1251-0600	connector, single contact
K1, K2	all	0490-1834	relay 1C 15Vdc-coil 30A 30Vdc
L1	all	9170-0707	ferrite core (jumper 06012-80003)
L2	6030A,32A,35A	9170-1267	magnetic core (jumper 5080-2040)
	6031A	06011-80092	output choke
L3	6030A	9140-1064	output choke
	6031A	06011-80092	output choke
	6032A	06012-80095	output choke (core 9170-0721)
	6035A	5080-2131	output choke 18μH 5A
L4	6031A	9170-1267	magnetic core (jumper 5080-2040)
Q1	6030A,31A,32A	1855-0456	MOSFET N-chan
	6035A	1855-0456	MOSFET N-chan
Q2	all	1855-0665	MOSFET N-chan
R1-4	all	0811-1866	res 10K 1% 5W
R5	all	0757-0418	res 619 1% 1/8W
R7	all	0698-5525	res 6.8 5% 1/2W
R8	all	0757-0765	res 36.5K 1% 1/8W
R9	all	0811-3700	res 20 10% 20W
R10	all	0811-3699	res 6 10% 20W
R11	6030A,35A	5080-2079	current sensing resistor
	6032A	06032-80001	current sensing resistor
R12	6030A,31A,32A	0699-0188	res 2.2 5% 1/4W
	6035A	0698-3492	res 26.1 ohms
R13	6030A,32A	0699-0188	res 2.2 5% 1/4W
	6031A	06011-80001	current sensing resistor
	6035A	0698-3492	res 26.1 ohms
R14,15	6031A	7175-0057	solid tinned copper wire
	6032A	0812-0100	res 2K 5% 5W
R16,17	all	0683-1065	res 10M 5% 1/4W
R18	all	0757-0921	res 750 1% 1/8W
R19	all	0757-0403	res 121 1% 1/8W
R20*	6031A	0699-0208	res 1 5% 1/4W
R21-22*	6032A	0699-0208	res 1 5% 1/4W
R23*	6031A	0699-0208	res 1 5% 1/4W
R24	all	0686-2015	res 200 5% 1/2W
R25	6031A,32A	0811-1869	res 30 3W

\* Part of output filter, mounted on output bus bars.

Table 5-3. Replaceable Parts List (continued)

Ref. Desig	Agilent Model	Agilent Part Number	Description
R29,30	6030A	0811-1887	res 0.05 5% 10W
	6035A	0811-3557	res 0.5 5% 10W
R31	6030A	0757-0367	res 100K 1% 1/2W
	6035A	0698-8959	res 619K 1% 1/8W
R32	6030A	0686-7535	res 75K 5% 1/2W
	6035A	0698-8959	res 619K 1% 1/8W
R33	6030A	0757-0451	res 24.3K 1% 1/8W
	6035A	0757-0471	res 182K 1% 1/8W
R34	6030A,35A	0757-0438	res 5.11K 1% 1/8W
R35	6030A,35A	0698-8827	res 1M 1% 1/8W
R36,37	6030A	0811-1909	res 500 5% 10W
	6035A	0811-1913	res 1.5K 5% 10W
R38,39	6030A,35A	0757-0467	res 121K 1% 1/8W
R41	6030A,35A	0764-0041	res 30 5% 2W
R43,44	all	0698-0085	res 2.61k 1% 1/8W
R45	all	0698-8827	res 1M 1% 1/8W
R46	all	0757-0419	res 681 1% 1/8W
R47, 48	all	0698-3622	res 120 5% 2W
R49	all	0757-0401	res 100 1% 1/8W
S1	all	3101-2046	switch, DPDT slide
S2	all	3101-1914	switch, 2-DPDT slide
T1	all	9100-4350	current transformer
T2	6030A	06030-80090	power transformer
	6031A	06011-80090	power transformer
	6032A	06032-80090	power transformer
	6035A	9100-4827	power transformer
T3	all	9100-4864	bias transformer
U1	all	1906-0389	rectifier bridge
U3	all	1826-0393	IC, voltage regulator 1.2/37V
U5	all	1826-0643	IC, voltage regulator 3/30V
U6	all	1990-1074	IC, opto-isolator
VR1	all	1902-0955	diode, zener, 7.5V
XA4,5	6030A,35A	1252-1052	connector 64-pin
	6031A,32A	1251-7891	connector 64-pin
	6030A	5060-3520	Output filter board
	6031A	5060-3524	Output filter board
	6032A	5060-3523	Output filter board
	6035A	5060-3521	Output filter board
		<b>A1 Mechanical</b>	
	all	1205-0282	heatsink (U3)
	all	1205-0862	heatsink (U1)
	all	2110-0726	fuse clips (F1)
	all	0403-0086	bumper foot (R9,10)
	all	0380-1692	standoff, 109mm (4)

**Table 5-3. Replaceable Parts List (continued)**

<b>Ref. Desig</b>	<b>Agilent Model</b>	<b>Agilent Part Number</b>	<b>Description</b>
A2	6030A	06030-60022	<b>Control Board Assembly</b>
	6031A	06011-60022	"
	6032A	06032-60022	"
	6035A	06030-60028	"
C1-4	all	0160-5422	cap 0.047μF 20% 50V
C5	all	0160-4801	cap 100pF 5% 100V
C6-7	all	0160-5422	cap 0.047μF 20% 50V
C8	all	0160-5892	cap 0.22μF 10%
C9	all	0160-5422	cap 0.047 20% 50V
C10	all	0160-4807	cap 33pF 5% 100V
C11	all	0160-5892	cap 0.22μF 10%
C12	all	0160-4830	cap 2200pF 10% 100V
C13-16	all	0160-5422	cap 0.047μF 20% 50V
C17	6030A,32A,35A	0160-4833	cap 0.022μF 10% 100V
	6031A	0160-4832	cap 0.01μF 10% 100V
C18	all	0160-5892	cap 0.22μF 10%
C19	6030A,31A,32A	0160-5469	cap 1μF 10% 50V
	6035A	0160-5534	cap 0.1μF 10% 63V
C20	6030A,32A,35A	0160-5892	cap 0.22μF 10%
	6031A	0160-5534	cap 0.1μF 10% 63V
C21,22	all	0160-5422	cap 0.047μF 20% 50V
C24	6030A,32A,35A	0160-0162	cap 0.022μF 10% 200V
	6031A	0160-0161	cap 0.01μF 10% 200V
C25	6030A,32A,35A	0160-4812	cap 220pF 5% 100V
C26	all	0160-4807	cap 33pF 5% 100V
C27	6030A,32A,35A	0160-5892	cap 0.22μF 10%
	6031A	0160-5534	cap 0.1μF 10% 63V
C28	6030A,32A,35A	0160-4834	cap 0.047μF 10% 100V
	6031A	0160-4833	cap 0.022μF 10% 100V
C29	all	0160-5422	cap 0.047μF 20% 50V
C30	all	0160-4807	cap 33pF 5% 100V
C31	all	0160-5422	cap 0.047μF 20% 50V
C32	6030A,32A,35A	0160-5644	cap 0.033μF 10% 50V
	6031A	0160-4832	cap 0.01μF 10% 100V
C33	6030A	0160-4822	cap 1000pF 5% 100V
	6032A	0160-4831	cap 4700pF 10% 100V
	6035A	0160-4824	cap 680pF 5% 100V
C34	6031A	0160-4832	cap 0.01μF 10% 100V
	6032A	0160-4835	cap 0.1μF 10% 50V
C35	all	0160-5422	cap 0.047μF 20% 50V
C36	all	0160-4812	cap 220pF 5% 100V
C37	6032A	0160-4830	cap 2200pF 10% 100V
C38-40	all	0160-5422	cap 0.047μF 20% 50V
C41	all	0160-4831	cap 4700pF 10% 100V
C42	all	0160-4812	cap 220pF 5% 100V
C43	all	0160-4831	cap 4700pF 10% 100V
C44	all	0160-5422	cap 0.047μ F 20% 50V
C45	all	0160-4812	cap 220pF 5% 100V
C46	6030A,31A,32A	0160-5166	cap 0.015μF 20% 100V
	6035A	0160-4832	cap 0.01μF 20% 100V

**Table 5-3. Replaceable Parts List (continued)**

<b>Ref. Desig</b>	<b>Agilent Model</b>	<b>Agilent Part Number</b>	<b>Description</b>
C47	all	0160-5422	cap 0.047 $\mu$ F 20% 50V
C48,49	all	0160-4835	cap 0.1 $\mu$ F 10% 50V
C50	all	0180-0291	cap 1 $\mu$ F 10% 35V
C51	all	0180-1731	cap 4.7 $\mu$ F 50V
C52	all	0180-0230	cap 1 $\mu$ F 20% 50V
C53	all	0180-1731	cap 4.7 $\mu$ F 50V
C54	all	0180-0291	cap 1 $\mu$ F 10% 35V
C55	all	0180-0230	cap 1 $\mu$ F 20% 50V
C56,57	all	0160-5422	cap 0.047 $\mu$ F 20% 50V
C58	all	0160-4801	cap 100pF 5% 100V
C59	all	0160-4835	cap 0.1 $\mu$ F 10% 50V
C60	all	0160-5422	cap 0.047 $\mu$ F 20% 50V
C61	all	0160-4812	cap 220pF 5% 100V
C62	all	0160-1835	cap 0.1 $\mu$ F 10% 50V
C63	all	0180-1980	cap 1 $\mu$ F 5% 35V
C64	all	0180-0116	cap 6.8 $\mu$ F 10% 35V
C65	all	0160-5422	cap 0.047 $\mu$ F 20% 50V
C66	all	0160-4801	cap 100pF 5% 100V
C67	all	0160-5422	cap 0.047 $\mu$ F 20% 50V
C68	all	0160-1822	cap 1000pF 5% 100V
C69,70	all	0160-5422	cap 0.047 $\mu$ F 20% 50V
C71	all	0180-0376	cap 0.47 $\mu$ F 10% 35V
C72	all	0180-2624	cap 2000 $\mu$ F 10V
C73	all	0180-3407	cap 2200 $\mu$ F 35V
C74,75	all	0160-5098	cap 0.22 $\mu$ F 10% 50V
C76	all	0160-4835	cap 0.1 $\mu$ F 10% 50V
C77	all	0160-4833	cap 0.022 $\mu$ F 10% 100V
C78	all	0160-4832	cap 0.01 $\mu$ F 10% 100V
C79	all	0160-4830	cap 2200pF 10% 100V
C80	all	0160-4813	cap 180pF 5% 100V
C81	all	0160-5422	cap 0.047 $\mu$ F 20% 50V
C82	all	0160-4812	cap 220pF 5% 100V
C83	all	0160-5422	cap 0.047 $\mu$ F 20% 50V
C84	all	0160-4812	cap 220pF 5% 100V
C85	all	0160-4832	cap 0.01 $\mu$ F 10% 100V
CR1-6	all	1901-0033	gen prp 180V 200mA
CR7,8	all	1901-0050	switching 80V 200mA
CR9,10	all	1901-0033	gen prp 180V 200mA
CR11	all	1901-0050	switching 80V 200mA
CR12	all	1901-0033	gen prp 180V 200mA
CR13,14	all	1901-0050	switching 80V 200mA
CR15,16	all	1901-0033	gen prp 180V 200mA
CR17,18	all	1901-0050	switching 80V 200mA
CR19	all	1901-0033	gen prp 180V 200mA
CR20-31	all	1901-0050	switching 80V 200mA
CR32	all	1901-0992	schottky 40V 3A
J1,2	all	1251-8417	connector 16-pin
J3	6030A,35A	1251-7743	connector 26-pin
	6031A,32A	1251-5927	connector 26-pin
J4	all	1251-8676	connector 5-pin

**Table 5-3. Replaceable Parts List (continued)**

Ref. Desig	Agilent Model	Agilent Part Number	Description
J5,6	all	1251-5240	connector 20-pin
J15	6030A,35A	1251-0600	connector 1-pin
L1	all	06023-80090	choke
Q1-3	all	1854-0823	transistor NPN Si
Q4-6	all	1855-0413	J-FET P-chan Si
Q7	all	1854-0823	transistor NPN Si
Q8	all	1853-0012	transistor PNP Si
Q9	all	1854-0635	transistor NPN Si
Q10	all	1853-0036	transistor PNP Si
Q11	all	1858-0023	transistor array
R1,2	all	0686-5125	res 5.1K 5% 1/2W
R3	all	0683-5125	res 5.1K 5% 1/4W
R4	all	0757-0483	res 562K 1% 1/8W
R5	all	0683-2015	res 200 5% 1/4W
R6	6030A	0698-6615	res 3.75K 0.1%
	6031A	0699-1011	res 3.32K 1% 1/8W
	6032A	0698-7631	res 2.87K 1%
	6035A	0757-0424	res 1.1K 1% 1/8W
R7	all	0683-5125	res 5.1K 5% 1/4W
R8	all	2100-3353	trimmer 20K 10%
R9	6030A,31A,32A	2100-3352	trimmer 1K 10%
	6035A	2100-3351	trimmer 500 10%
R10	all	0698-3433	res 28.7 1% 1/8W
R11,12	6030A,32A,35A	0757-0465	res 100K 1% 1/8W
R13	6030A,35A	0698-3430	res 21.5 1% 1/8W
	6032A	0757-0379	res 12.1 1% 1/8W
R14,15	all	0686-5125	res 5.1K 1/2W
R16	all	0683-2015	res 200 5% 1/4W
R17	all	0698-7082	res 100K 1% 1/8W
R18	all	0683-1025	res 1K 5% 1/4W
R19	all	0757-0442	res 10K 1% 1/8W
R20	6030A,35A	0686-5135	res 51K 5% 1/2W
	6031A,32A	0686-1025	res 1K 5% 1/4W
R21	6030A,35A	2100-3274	trimmer 10K 10%
	6031A	2100-3350	trimmer 200 10%
	6032A	2100-3273	trimmer 2K 10%
R22	all	2100-3353	trimmer 20K 10%
R23	all	2100-3273	trimmer 2K 10%
R24	all	2100-3350	trimmer 200 10%
R25	all	2100-3273	trimmer 2K 10%
R26	all	2100-3274	trimmer 10K 10%
R27	all	0757-0470	res 162K 1% 1/8W
R28	all	0757-0464	res 90.9K 1% 1/8W
R29	all	0698-4509	res 80.6K 1% 1/8W
R30	all	0757-0280	res 1K 1% 1/8W
R31	6030A,31A,32A	0698-3260	res 464K 1% 1/8W
	6035A	0757-0741	res 182K 1% 1/8W
R32	all	0698-8827	res 1M 1% 1/8W
R33	all	0698-3449	res 28.7K 1% 1/8W
R34	6030A,32A,35A	0757-0458	res 51.1K 1% 1/8W

**Table 5-3. Replaceable Parts List (continued)**

Ref. Desig	Agilent Model	Agilent Part Number	Description
R35	6031A	0757-0442	res 10K 1% 1/8W
	6030A,35A	0683-1055	res 1M 5% 1/4W
	6031A	0683-3355	res 3.3M 5% 1/4W
R36	6032A	0683-1555	res 1.5M 5% 1/4W
	all	0698-3455	res 261K 1% 1/8W
R37	all	0698-4536	res 340K 1% 1/8W
R38	6030A,35A	0698-4536	res 340K 1% 1/8W
	6031A,32A	0698-3455	res 261K 1% 1/8W
R39	all	0683-4725	res 4.7K 5% 1/4W
R40	6030A,32A	0699-1210	res 80K 0.1% 0.1W
	6035A	0698-6979	res 111.1K 1%
R41	6035A	0683-2055	res 2M 1%
	6030A	0699-1744	res 280K 1% 0.1W
	6031A	0699-0118	res 20K 0.1% 0.1W
R42	6032A	0699-1210	res 80K 0.1% 0.1W
	6035A	0699-3104	res 250K 0.1% 0.1W
	6030A,35A	0699-1742	res 70K 0.1% 0.1W
	6031A	0699-0059	res 5K 0.1% 0.1W
R43	6032A	0699-0642	res 10K 0.1% 0.1W
	6030A,35A	0699-1743	res 345K 0.1% 0.1W
	6031A	0699-0118	res 20K 0.1% 0.1W
R44	all	0757-0199	res 21.5K 1% 1/8W
R45	all	0698-8816	res 2.15 1% 1/8W
R46	6030A,32A,35A	0683-1255	res 1.2M 5% 1/4W
	6031A	0698-4539	res 402K 1% 1/8W
R47	6030A,32A,35A	0757-0470	res 162K 1% 1/8W
	6031A	0757-0458	res 51.1K 1%
R48	all	0757-0458	res 51.1K 1%
R49	6030A	0699-1745	res 560K 0.1% 1/4W
	6031A	7175-0057	jumper
	6032A	0698-7496	res 20K 0.1% 1/4W
	6035A	0698-6369	2 - resistors 1M 1% (assembled in series )
R50	6030A,35A	0686-5135	res 51K 5% 1/2W
	6031A,32A	0686-1025	res 1K 5% 1/2W
R51	6030A,32A,35A	7175-0057	jumper
	6031A	0698-3433	res 28.7 1% 1/8W
R52	6030A,35A	0699-1742	res 70K 0.1% 0.1W
	6031A	0699-0059	res 5K 0.1% 0.1W
	6032A	0699-0642	res 10K 0.1% 0.1W
R53	6030A,35A	0757-0451	res 24.3K 1% 1/8W
	6031A	0757-0462	res 75K 1% 1/8W
	6032A	0757-0458	res 51.1K 1% 1/8W
R54	all	0698-3450	res 42.2K 1% 1/8W
R55	6030A,35A	0757-0451	res 24.3K 1% 1/8W
	6031A	0757-0462	res 75K 1% 1/8W
R56	6032A	0757-0458	res 51.1K 1% 1/8W
	6030A,32A,35A	0757-0199	res 21.5K 1% 1/8W
	6031A	7175-0057	jumper
R57	6030A,31A,32A	0698-3155	res 4.64K 1% 1/8W

┌ assembled  
in parallel



**Table 5-3. Replaceable Parts List (continued)**

Ref. Desig	Agilent Model	Agilent Part Number	Description
R57	6035A	0757-0124	res 39.2K 1% 1/8W
R58	6030A	0757-0344	res 1M 1% 1/4W
	6031A	0757-0449	res 20K 1% 1/8W
	6032A	0698-3572	res 60.4K 1% 1/8W
	6035A	0699-1630	res 4M 0.25% 1/2W
R59,60	6030A	0698-4486	res 24.9K 1% 1/8W
	6031A	0757-0442	res 10K 1% 1/8W
	6032A	0757-0438	res 5.11K 1% 1/8W
	6035A	0698-7668	res 39.91K 1%
R61	6030A	0757-0344	res 1M 1% 1/4W
	6031A	0757-0449	res 20K 1% 1/8W
	6032A	0698-3572	res 60.4K 1% 1/8W
	6035A	0699-1630	res 4M 0.25% 1/2W
R62	all	0757-0124	res 39.2K 1% 1/8W
R63	all	0683-1015	res 100 5% 1/4W
R64	6030A,32A,35A	0757-0124	res 39.2K 1% 1/8W
	6031A	0757-0270	res 249K 1% 1/8W
R65	6032A	0757-0473	res 221K 1% 1/8W
R66	all	0683-4725	res 4.7K 5% 1/4W
R67	6031A	0757-0459	res 56.2K 1% 1/8W
	6032A	0757-0123	res 34.8K 1% 1/8W
R68	all	0757-0270	res 249K 1% 1/8W
R69	all	0683-1015	res 100 5% 1/4W
R70	all	0757-0449	res 20K 1% 1/8W
R71	all	0698-0085	res 2.61K 1% 1/8W
R72	all	0757-0452	res 27.4K 1% 1/8W
R73	6030A,35A	0757-0289	res 13.3K 1% 1/8W
	6031A	0757-0442	res 10K 1% 1/8W
	6032A	0757-0461	res 68.1K 1% 1/8W
R74	all	0757-0460	res 61.9K 1% 1/8W
R75	all	0698-8827	res 1M 1% 1/8W
R76	all	0757-0438	res 5.11K 1% 1/8W
R77	all	0683-4715	res 470 5% 1/4W
R78	all	0698-6322	res 4K 1% 1/8W
R79,80	all	0683-2035	res 20K 5% 1/4W
R81	6030A,32A,35A	0757-0419	res 681 1% 1/8W
	6031A	0698-3444	res 316 1% 1/8W
R82	all	0683-4715	res 470 5% 1/4W
R83	all	0698-6322	res 4K 1% 1/8W
R84	all	0698-6320	res 5K 0.1% 1/8W
R85	all	0698-6983	res 20.4K 0.1% 1/8W
R86	all	0757-0465	res 100K 1% 1/8W
R87	6030A	0699-1741	res 5.657K 0.1% 1/8W
	6031A	0698-6322	res 4K 1% 1/8W
	6032A	0698-7933	res 3.83K 0.1% 1/8W
	6035A	0699-2850	res 10.04K 0.1%
R88	6030A	0699-1745	res 500 0.1% 1/8W
	6031A	0698-8695	res 36K 0.1% 1/8W
	6032A	0698-6979	res 111.1K 01% 1/8W
	6035A	0698-6950	2 - resistors 1.25M .1% (assembled in series )



**Table 5-3. Replaceable Parts List (continued)**

<b>Ref. Desig</b>	<b>Agilent Model</b>	<b>Agilent Part Number</b>	<b>Description</b>
R89-91	all	0683-2225	res 2.2K 5% 1/4W
R92	6030A,35A	0898-4480	res 15.8K 1% 1/8W
	6031A	0757-0457	res 47.5K 1% 1/8W
	6032A	0757-0464	res 90.9K 1% 1/8W
R93	all	0683-3325	res 3.3K 5% 1/4W
R94,95	all	0683-2225	res 2.2K 5% 1/4W
R96	all	0757-0481	res 475K 1% 1/8W
R97	all	0757-0290	res 6.19K 1% 1/8W
R98	all	0757-0444	res 12.1K 1% 1/8W
R99	all	0698-4416	res 169 1% 1/8W
R100	all	0757-0404	res 130 1% 1/8W
R101	all	0698-4608	res 806 1% 1/4W
R102	all	0698-4447	res 280 1% 1/8W
R103	all	0698-4416	res 169 1% 1/8W
R104,105	all	0683-4725	res 4.7K 5% 1/4W
R106	6030A,35A	0757-0404	res 130 5% 1/4W
	6031A,32A	0683-2715	res 270 5% 1/4W
R107	6030A,35A	0757-0404	res 130 5% 1/4W
	6031A,32A	0683-1815	res 180 5% 1/4W
R108	6030A,35A	0757-0404	res 130 5% 1/4W
	6031A,32A	0683-2715	res 270 5% 1/4W
R109	6030A,35A	0757-0404	res 130 5% 1/4W
	6031A,32A	0683-1815	res 180 5% 1/4W
R110	all	0683-5105	res 51 5% 1/4W
R111	all	0683-2035	res 20K 5% 1/4W
R112	all	0757-0199	res 21.5K 1% 1/8W
R113	all	0757-0283	res 2K 1% 1/8W
R114	all	0683-2225	res 2.2K 5% 1/4W
R115	all	0757-0280	res 1K 1% 1/8W
R116,117	all	0757-0346	res 10 1% 1/8W
R118	all	0698-3498	res 8.66K 1% 1/8W
R119	all	0757-0438	res 5.11K 1% 1/8W
R120	all	0683-4725	res 4.7K 5% 1/4W
R121	all	0683-2025	res 2K 5% 1/4W
R122	all	0683-1025	res 1K 5% 1/4W
R123	all	0683-4715	res 470 5% 1/4W
R124	all	0757-0442	res 10K 1% 1/8W
R125	all	0757-0465	res 100K 1% 1/8W
R126	all	0757-0442	res 10K 1% 1/8W
R127	all	0698-8827	res 1M 1% 1/8W
R128	all	0698-3136	res 17.8K 1% 1/8W
R129	all	0698-4121	res 11.3K 1% 1/8W
R131	all	0757-0449	res 20K 1% 1/8W
R132	all	1810-0205	network, sip 4.7K X7
R133	all	0683-5625	res 5.6K 5% 1/4W
R134	all	0683-1025	res 1K 5% 1/4W
R135	all	0683-1855	res 1.8M 5% 1/4W
R136	all	0757-0420	res 750 1% 1/4W
R137	all	0698-4435	res 2.49K 1% 1/8W
R138	all	0757-0199	res 21.5K 1% 1/8W

**Table 5-3. Replaceable Parts List (continued)**

<b>Ref. Desig</b>	<b>Agilent Model</b>	<b>Agilent Part Number</b>	<b>Description</b>
R139	all	0683-4725	res 4.7K 5% 1/4W
R140	all	0683-2025	res 2K 5% 1/4W
R141	all	0683-5135	res 51K 5% 1/4W
R142	all	0683-6835	res 68K 5% 1/4W
R143	all	0683-4725	res 4.7K 5% 1/4W
R144	all	0757-0415	res 475 1% 1/8W
R145	all	0683-1005	res 10 5% 1/4W
R146	all	0683-1035	res 10K 5% 1/4W
R147	all	0683-5115	res 510 5% 1/4W
R148	all	0757-0422	res 909 1% 1/8W
R149	all	0683-2025	res 2K 5% 1/4W
R150	6030A,35A 6031A,32A	0754-0404	res 130 5% 1/4W
R151	all	0683-4725	res 4.7K 5% 1/4W
R152	all	0757-0442	res 10K 1% 1/8W
R153	all	0757-0443	res 11K 1% 1/8W
R154	all	0757-0451	res 24.3K 1% 1/8W
R155	all	0757-0444	res 12.1K 1% 1/8W
R156	all	0683-4725	res 4.7K 5% 1/4W
R157	all	0683-1005	res 10 5% 1/4W
R158	all	0686-2005	res 20 5% 1/2W
R159,160	all	0680-6215	res 620 5% 1/2W
R161	all	0757-0283	res 2K 1% 1/8W
R162	all	0757-0442	res 10K 1% 1/8W
R163	all	0757-0283	res 2K 1% 1/8W
R164	all	0757-0434	res 3.65K 1% 1/8W
R165	all	0683-1035	res 10K 5% 1/4W
R166,167	all	0686-1315	res 130 5% 1/2W
R168	all	0683-1515	res 150 5% 1/4W
R169	all	0757-0124	res 39.2K 1% 1/8W
R170	all	0698-3136	res 17.8K 1% 1/8W
R171	all	0757-0280	res 1K 1% 1/8W
R172	all	0811-3174	res 0.07 5% 5W
R173	all	0683-2225	res 2.2K 5% 1/4W
R174	all	0683-3625	res 3.6K 5% 1/4W
R175	all	0683-1525	res 1.5K 5% 1/4W
R176	all	0683-2225	res 2.2K 5% 1/4W
R177	all	0683-0335	res 3.3 5% 1/4W
R178,179	all	0683-4725	res 4.7K 5% 1/4W
R180	all	0683-1045	res 100K 5% 1/4W
R182	all	0698-8827	res 1M 1% 1/8W
S1	all	3101-2097	switch (6) 1A
U1-3	all	1826-0493	IC op amp Lo-bias Hi-impedance
U4,5	all	1826-0161	IC op amp quad general purpose
U6	all	1826-0346	IC op amp dual general purpose
U7	all	1826-0544	IC voltage reference 2.5V
U8	all	1826-0138	IC comparator quad
U9	all	1820-0935	IC counter binary CMOS
U10	all	1826-0065	IC comparator precision
U11	all	1826-0393	IC voltage regulator 1.2/37V

**Table 5-3. Replaceable Parts List (continued)**

<b>Ref. Desig</b>	<b>Agilent Model</b>	<b>Agilent Part Number</b>	<b>Description</b>
U12	all	1826-0527	IC voltage regulator 1.2/37V
U13	all	1820-1287	IC buffer quad NAND
U15	all	1820-1272	IC buffer quad NOR
U16	all	1820-1437	IC multivibrator monostable dual
U17	all	1826-0138	IC comparator quad
U18	all	1820-1205	IC gate dual AND
U19	all	1820-1112	IC flip flop D-type
U20	all	1820-2096	IC counter binary dual
U21	all	1826-0544	IC voltage reference 2.5V
U22	all	1826-0428	IC voltage regulator 1/40V
U23	all	1826-0065	IC comparator precision
VR1	all	1902-3110	diode, zener 5.9V 2%
VR2	all	1902-0777	diode, zener 6.2V
VR3,4	all	1902-0018	diode, zener 11.7V
VR5	all	1902-0575	diode, zener 6.5V 2%
VR6	all	7175-0057	jumper
W1-3	all	7175-0057	jumper
Y1	all	0960-0586	resonator, ceramic
		A2 Mechanical	
	all	1205-0282	heat sink (Q9, U11, U12)
	all	1200-0485	IC socket (S1)
	all	1200-0181	insulator, (Q8)
	all	0360-2195	terminal block, 6-position
	all	0360-2192	terminal block, 2-position
<b>A3</b>	all	06031-60020	<b>Front Panel Board</b>
C1-4	all	0160-5422	cap 0.047μF 20% 50V
C5	all	0180-0374	cap 10μF 20%
C6-9	all	0160-5422	cap 0.047μF 20% 50V
C10	all	0180-0374	cap 10μF 20%
C11-13	all	0160-5422	cap 0.047μF 20% 50V
DS1-6	all	1990-0835	LED
DS7-12	all	1990-0831	LED
DS13-15	all	1990-0835	LED
DS16-23	all	1990-0985	display-kit
G1	all	06032-60006	rotary pulse generator
J1	all	1251-8417	connector 16-pin
J2,3	all	1251-8675	connector 5-pin
L1	all	9100-1618	coil 5.6μH 10%
R1	all	1810-0272	network, sip 330 X9
R2	all	0683-2225	res 2.2K 5% 1/4W
R3-5	all	0683-3315	res 330 5% 1/4W
R6-38	all	0683-4715	res 470 5% 1/4W
R40-64	all	0683-4715	res 470 5% 1/4W
R65-68	all	0683-2225	res 2.2K 5% 1/4W
R69-71	all	0683-3315	res 330 5% 1/4W
R72	all	2100-1775	trimmer 5K 5%
R73	all	0683-1015	res 100 5% 1/4W
S1-5	all	5060-9436	switch, lighted pushbutton

Table 5-3. Replaceable Parts List (continued)

Ref. Desig	Agilent Model	Agilent Part Number	Description
U1-4, 6-11	all	1820-1433	IC shift register, 8-bit
U5	all	1820-1216	IC decoder, 3-to-8 line
U12	all	1820-1216	IC decoder, 3-to-8 line
U13	all	1820-1112	IC flip flop, D-type
U14	all	1820-1199	IC inverter, HEX
U15	all	1820-1197	IC gate quad NAND
U16	all	1820-1433	IC shift register, 8-bit
U17	all	1820-1975	IC shift register, 8-bit
	all	A3 Mechanical 4040-1615	stand off (DS1-15)
<b>A4</b>	all	06011-60023	<b>FET Board</b>
C1	all	0160-4569	cap 0.01 $\mu$ F 10% 800Vdc
C2	all	0160-5981	cap 0.047 $\mu$ F 10% 630Vdc
C3	all	0160-4569	cap 0.01 $\mu$ F 10% 800Vdc
C4	all	0160-5981	cap 0.047 $\mu$ F 10% 630Vdc
C5,6	all	0160-4835	cap 0.1 $\mu$ F 10% 50V
C7	all	0180-0116	cap 6.8 $\mu$ F 10% 35V
C8	all	0180-0228	cap 22 $\mu$ F 10% 15V
CR1	all	1901-1418	power rectifier 600V
CR2,3	all	1901-1087	power rectifier 600V
CR4	all	1901-1418	power rectifier 600V
CR5-11	all	1901-0050	diode, switching 80V 200mA
F1,2	all	2110-0671	fuse 125mAM, 125V
L14	all	9100-1610	coil 0.15 $\mu$ H 20%
P1	all	1252-1053	connector 64-pin
Q1-4	all	1855-0473	FET N-channel
Q5,6	all	1854-0585	transistor NPN Si
R1-4	all	0811-1065	res 150 5% 10W
R5-8	all	0698-3609	res 22 5% 2W
R9-11	all	0698-5139	res 3.9 5% 5W
R12	all	0757-0466	res 110K 1% 1/8W
R13-16	all	0698-3609	res 22 5% 2W
R17-19	all	0698-5139	res 3.9 5% 0.5W
R20	all	0757-0379	res 12.1 1% 1/8W
R21	all	0683-1505	res 15 5% 1/4W
R22	all	0683-1815	res 180 5% 1/4W
R23,24	all	0686-2005	res 20 5% 1/2W
R25	all	0757-0466	res 110K 1% 1/8W
R26	all	0683-1815	res 180 5% 1/4W
R27	all	0757-0379	res 12.1 1% 1/8W
R28	all	0683-1505	res 15 5% 1/4 W
R29-33	all	0683-0475	res 4.7 5% 1/4W
R34	all	0683-0275	res 2.7 5% 1/4W
TS1	all	3103-0081	switch, thermal +202F
T1	all	06011-80091	transformer
T2	all	06011-80095	transformer
U1-3	all	1820-1050	IC driver dual NOR
VR1,2	all	1902-0779	diode, zener 11.8V 5%

**Table 5-3. Replaceable Parts List (continued)**

Ref. Desig	Agilent Model	Agilent Part Number	Description
		A4 Mechanical	
	all	1205-0398	heatsink (CR1,4)
	all	1252-0093	socket pin (Q1-4) (8)
	all	06032-20001	heatsink (Q1,Q2)
	all	06032-20002	heatsink (Q3,Q4)
	all	0380-1524	standoff, hex (7)
<b>A5</b>	6030A	06030-60024	<b>Diode Board</b>
	6031A	06011-60024	"
	6032A	06032-60029	"
	6035A	06030-60029	"
C1	6030A,32A,35A	0180-3167	cap 1000µF 20% 25V
	6031A	0160-4832	cap 0.01µF 10% 100V
C2	6030A	0160-5464	cap 0.01µF 5% 1.5KVdc
	6031A	0160-5422	cap 0.047µF 20% 50V
	6032A	0160-4569	cap 0.01µF 10% 800Vdc
	6035A	0160-7222	cap 0.0022µF 10% 1600Vdc
C3	6030A,32A,35A	0160-5422	cap 0.047µF 20% 50Vdc
	6031A	0180-3167	cap 1000µF 25V
C4	6030A,32A	0160-4832	cap 0.01µF 10% 100Vdc
	6031A	0160-6077	cap 0.015µF 200V
	6035A	0160-4835	cap 0.1µF 10% 50V
C5	6030A	0160-5464	cap 0.01µF 5% 1.5KVdc
	6031A	0160-6077	cap 0.015µF 200V
	6035A	0160-7222	cap 0.0022µF 10% 1600Vdc
C7	6035A	0160-5166	cap 0.015µF 10% 100Vdc
CR1	6030A,32A,35A	1901-0050	diode, switching 80V 200ma
	6031A	1901-1127	power rectifier 150V 70A
CR2	6030A,32A,35A	1901-0731	power rectifier 400V 1A
	6031A	1901-0050	diode, switching 80V 200ma
CR3	all	1901-0050	diode, switching 80V 200mA
CR4	6030A	1901-1542	power rectifier 400V 50A
	6031A	1901-0731	power rectifier 400V 1A
	6032A	1901-0887	power rectifier 300V 50A
	6035A	1901-1388	power rectifier 1KV 40A
CR5	6030A	1901-1542	power rectifier 400V 50A
	6031A	1901-1127	power rectifier 150V 70A
	6035A	1901-1388	power rectifier 1KV 40A
CR6	6030A,35A	1902-3203	diode, zener 14.7V 5%
F1	6031A,32A	2110-0546	fuse 5AM, 125V
L1	6030A	9170-1334	ferrite core (jumper 5080-2065)
	6031A	06011-80003	ferrite core (jumper 8150-4777)
	6032A	9170-0707	ferrite core (jumper 06012-80003)
	6035A	5080-2132	inductor L2
L2	6030A	9170-1334	ferrite core (jumper 5080-2065)
	6031A	06011-80003	ferrite core (jumper 8150-4777)
	6035A	5080-2132	inductor
L3	6030A, 35A	9170-0894	core shield bead (ref Q1)
P1	all	1252-1053	connector 64-pin

**Table 5-3. Replaceable Parts List (continued)**

Ref. Desig	Agilent Model	Agilent Part Number	Description
Q1	6030A, 35A	1855-0767	FET N-channel
	6031A	1854-0264	transistor NPN, Si
	6032A	1855-0549	FET N-channel
Q2	6031A	1855-0549	FET N-channel
	6032A	1854-0755	transistor NPN Si
R1	6030A,32A,35A	0683-1855	res 1.8M 5% 1/4W
R2	6031A	0811-3460	res 0.05 5% 5W
	6030A,32A,35A	0698-3151	res 2.87K 1% 1/8W
R3	6031A	0686-1005	res 10 5% 1/2W
	6030A,32A,35A	0757-0459	res 56.2K 1% 1/8W
R4	6031A	0683-1025	res 1K 5% 1/8 W
	6030A,32A,35A	0698-3202	res 1.74K 1% 1/8W
R5	6031A	0757-0317	res 1.33K 1% 1/8W
	6030A,32A,35A	0757-0317	res 1.33K 1% 1/8W
R6	6031A	0698-4196	res 1.07K 1% 1/8W
	6030A,32A,35A	0683-1045	res 100K 5% 1/4W
R7	6031A	0698-4211	res 158K 1% 1/8W
	6030A, 35A	0683-2735	res 26K 5% 1/4W
R8	6031A	0757-0465	res 100K 1% 1/8W
	6032A	0683-1025	res 1K 5% 1/4W
	6030A,32A,35A	0698-7332	res 1M 1% 1/8W
R9	6031A	0757-0447	res 16.2K 1% 1/8W
	6030A	0698-8144	res 787K 1% 1/8W
	6031A	0757-0428	res 1.62K 1% 1/8W
R10	6032A	0757-0480	res 432K 1% 1/8W
	6035A	0683-2055	res 2M 5%
	6030A, 35A	0698-3512	res 1.8K 1% 1/8W
R11	6031A	0698-3601	res 10 5% 2W
	6032A	0698-4196	res 1.07K 1% 1/8 W
	6031A	0698-3601	res 10 5% 2W
R12	6032A	0686-1005	res 10 5% 1/2W
	6030A, 32A, 35A	0757-0447	res 16.2K 1% 1/8W
R13	6031A	0698-3609	res 22 55% 2W
	6030A, 32A, 35A	0683-1005	res 10 5% 1/4W
R14	6031A	0698-3609	res 22 55% 2W
	6030A	0811-1746	res 0.36 5% 2W
	6031A	0757-0459	res 56.2K 1% 1/8W
R15	6032A	0811-3290	res 0.1 5% 2W
	6035A	0811-0923	res 0.91 5% 2W
	6030A	0811-3729	res 250 5% 10W
R16	6031A	0683-1855	res 1.8M 5% 1/4W
	6032A	0811-1068	res 50 5% 10W
	6035A	0811-3842	res 600 10% 10W
R17	6030A	0811-3729	res 250 5% 10W
	6031A	0698-7332	res 1M 1% 1/8W
	6035A	0811-3842	res 600 10% 10W
R18	6030A	0811-3729	res 250 5% 10W
	6031A	0698-4444	res 4.87K 1% 1/8W
	6035A	0811-3842	res 600 10% 10W
	6030A	0811-3729	res 250 5% 10W

**Table 5-3. Replaceable Parts List (continued)**

<b>Ref. Desig</b>	<b>Agilent Model</b>	<b>Agilent Part Number</b>	<b>Description</b>
R18	6031A	0683-1005	res 10 10% 1/4W
	6035A	0811-3842	res 600 10% 10W
R20	6030A, 35A	0811-3731	res 1.2 K% 2W
T1	6031A	9170-0061	magnetic-core (jumper 8150-4777)
TS1	all	3103-0081	switch, thermal +202F
U1	all	1826-0346	IC op amp
VR1	all	1902-0575	diode, zener 6.5 V 2%
		<b>A5 Mechanical</b>	
	6030A,35A	5020-2877	heatsink (CR5)
	6030A,35A	5020-2878	heatsink (CR4, Q1)
	6030A,35A	0340-1123	insulator (L1,2) (6)
	6030A,35A	1251-7600	socket pin (Q1) (2)
	6031A	06011-20001	heatsink (CR1,CR5)
	6031A	1205-0520	heatsink (Q1)
	6031A	1205-0398	heatsink (Q2)
	6031A	0380-1524	standoff, hex (4)
	6031A	06011-00001	bracket (CR1, CR5 heatsink)
	6032A	06032-00018	heatsink (CR4,Q2)
	6032A	1205-0398	heatsink (Q1)
	6032A	1251-7600	socket pin (Q2) (2)
	6032A	0380-1524	standoff, hex (4)
	6032A	06032-00017	bracket (CR4, Q2 heatsink)
<b>A6</b>	6030A,31A,32A	5060-3522	<b>AC Input Filter</b>
	6035A	06011-60028	"
C101	6030A,31A,32A	0160-4355	cap 0.01μF 10% 250Vac
	6035A	0160-4048	cap 0.022μF 10% 250Vac
C102	6030A,31A,32A	0160-4281	cap 2200pF 20% 250Vac
	6035A	0160-4439	cap 0.0047μF 10% 250Vac
C103	6030A,31A,32A	0160-4355	cap 0.01μF 10% 250Vac
	6035A	0160-4048	cap 0.022μF 10% 250Vac
C104	6030A,31A,32A	0160-4281	cap 2200pF 20% 250Vac
	6035A	0160-4439	cap 0.0047μF 10% 250Vac
C105	all	0160-4962	cap 1μF 20% 250Vac
C106, 107	6030A,31A,32A	0160-4183	cap 1000pF 20% 250Vac
	6035A	0160-4439	cap 0.0047μF 10% 250Vac
C108, 109	all	0160-4962	cap 1μF 20% 250V
L101	all	66000-80004	choke, input
R101	all	0686-3945	res 390K 5% 0.5W
W101-103	all	1251-5613	connector, single
		<b>A6 Mechanical</b>	
	all	0360-2217	terminal block 3-position



**Table 5-3. Replaceable Parts List (continued)**

<b>Ref. Desig</b>	<b>Agilent Model</b>	<b>Agilent Part Number</b>	<b>Description</b>
<b>A8</b>	all	5063-3463	<b>GPIB Board</b>
C1	all	0160-5422	cap 0.047 $\mu$ F 20% 50V
C2,3	all	0160-4807	cap 33pF 5% 100V
C4	all	0160-5422	cap 0.047 $\mu$ F 20% 50V
C5	all	0160-4822	cap 1000pF 100V
C6	all	0180-0197	cap 2.2 $\mu$ F 10% 20V
C7,8	all	0160-4807	cap 33pF 5% 100V
C9	all	0160-5422	cap 0.047 $\mu$ F 20% 50V
C10	all	0160-4801	cap 100pF 5% 100V
C11,12	all	0160-5422	cap 0.047 $\mu$ F 20% 50V
C13	all	0160-4801	cap 100pF 5% 100V
C14	all	0160-4832	cap 0.01 $\mu$ F 10% 50V
C15	all	0160-5422	cap 0.047 $\mu$ F 20% 50V
C16	all	0160-4801	cap 100pF 5% 100V
C22	all	0180-3798	cap 4700 $\mu$ F 25V
C23	all	0180-4136	cap 10 $\mu$ F 10% 20V
C24	all	0180-0393	cap 39 $\mu$ F 10% 10V
C25,26	all	0160-5422	cap 0.047 $\mu$ F 20% 50V
C27	all	0180-0374	cap 10 $\mu$ F 10% 20V
C28-31	all	0160-5469	cap 1 $\mu$ F 10% 50V
C32-37	all	0160-5422	cap 0.047 $\mu$ F 20% 50V
C38	all	0180-0116	cap 6.8 $\mu$ F 10% 35V
C39,40	all	0160-5422	cap 0.047 $\mu$ F 20% 50V
C41,42	all	0160-4820	cap 1800pF 5% 100V
C43-47	all	0160-5422	cap 0.047 $\mu$ F 20% 50V
C48	all	0180-0116	cap 6.8 $\mu$ F 10% 35V
C49-51	all	0160-5422	cap 0.047 $\mu$ F 20% 50V
C52	all	0160-4822	cap 1000pF 100V
C53-58	all	0160-5422	cap 0.047 $\mu$ F 20% 50V
C59,60	all	0160-4822	cap 1000pF 100V
C61	all	0160-4830	cap 2200pF 10% 250V
C62,63	all	0160-4807	cap 33pF 5% 100V
C64	all	0160-5422	cap 0.047 $\mu$ F 20% 50V
C65	all	0180-0393	cap 39 $\mu$ F 10% 10V
C66	all	0160-5422	cap 0.047 $\mu$ F 20% 50V
C67-70	all	0160-4832	cap 0.01 $\mu$ F 10% 50V
C71,73	all	0160-4830	cap 2200pF 10% 250V
C142	all	0160-4801	cap 100pF 5% 100V
C143,144	all	0160-5422	cap 0.047 $\mu$ F 20% 50V
D8,9	all	1901-0731	diode, power rectifier
D13-17	all	1901-1098	diode, switching
D20,21	all	1901-1080	diode, 1N5817
D22	all	1901-1098	diode, switching
F1,2	all	2110-0712	fuse, 4AM, 125V
J1,2	all	1251-7330	telephone jacks
J3	all	1200-0485	right angle socket
J4	all	1252-0268	GPIB connector
J5	all	1251-4926	connector 8-contact
J6	all	1251-4927	connector 16-contact
J7,8	all	1251-8417	connector 16-contact



**Table 5-3. Replaceable Parts List (continued)**

<b>Ref. Desig</b>	<b>Agilent Model</b>	<b>Agilent Part Number</b>	<b>Description</b>
J9	all	1251-4927	connector 16-contact
J10	all	1251-5384	connector 3-contact
L1	all	9170-1680	choke
L2-4	all	9170-1454	core-shield bead
Q1,4	all	1853-0089	transistor 2N4917
R1	all	0757-0457	res 47.5 1% 1/8W
R2	all	0698-3155	res 4.64K 1% 1/8W
R3	all	0757-0442	res 10K 1% 1/8W
R4	all	0698-3155	res 4.64K 1% 1/8W
R5	all	0683-1065	res 10M 5% 1/4W
R6	all	0698-4037	res 46.4 1% 1/8W
R7	all	0698-3155	res 4.64K 1% 1/8W
R8-11	all	0757-0401	res 100 1% 1/8W
R12	all	0698-3155	res 4.64K 1% 1/8W
R14	all	0698-0082	res 464 1% 1/8W
R15-17	all	0698-4037	res 46.4 1% 1/8W
R18	all	0757-0280	res 1K 1% 1/8W
R19	all	0698-8827	res 1M 1% 1/8W
R20-22	all	0698-3155	res 4.64K 1% 1/8W
R23	all	0698-0082	res 464 1% 1/8W
R24,26	all	0698-3156	res 14.7K 1% 1/8W
R28	all	0699-0059	res 5K 0.1% 1/10W
R29	all	2100-3353	trimmer 20K 10%
R30	all	0699-0642	res 10K 0.1% 1/10W
R32	all	0757-0457	res 47.5K 1% 1/8W
R33	all	0698-6360	res 10K 0.1% 1/8W
R34	all	0757-0401	res 100 1% 1/8W
R35	all	0699-0059	res 5K 0.1% 1/10W
R36	all	0757-0316	res 42.2 1% 1/8W
R37	all	0699-0642	res 10K 0.1% 1/10W
R39	all	0757-0270	res 249K 1% 1/8W
R40	all	2100-3353	trimmer 20K 10%
R41	all	0757-0401	res 100 1% 1/8W
R42	all	0757-0411	res 332 1% 1/8W
R43	all	0699-0059	res 5K 0.1% 1/10W
R44	all	0757-0316	res 42.2 1% 1/8W
R45	all	0699-0642	res 10K 0.1% 1/10W
R46	all	0757-0411	res 332 1% 1/8W
R48	all	0757-0457	res 47.5K 1% 1/8W
R49	all	0698-6360	res 10K 0.1% 1/8W
R50	all	0757-0401	res 100 1% 1/8W
R51	all	2100-3353	trimmer 20K 10%
R52	all	0698-3156	res 14.7K 1% 1/8W
R55,58	all	2100-3732	trimmer 500 10%
R59,60	all	0698-3558	res 4.02K 1% 1/8W
R61	all	2100-3732	trimmer 500 10%
R62-64	all	0698-3558	res 4.02K 1% 1/8W
R65	all	0757-0280	res 1K 1% 1/8W
R66	all	0698-3558	res 4.02K 1% 1/8W
R67	all	0698-6320	res 5K 0.1% 1/8W

**Table 5-3. Replaceable Parts List (continued)**

<b>Ref. Desig</b>	<b>Agilent Model</b>	<b>Agilent Part Number</b>	<b>Description</b>
R68	all	0757-0400	res 90.9 1% 1/8W
R69	all	0698-6320	res 5K 0.1% 1/8W
R70	all	0757-0400	res 90.9 1% 1/8W
R71	all	0698-6320	res 5K 0.1% 1/8W
R72	all	0757-0400	res 90.9 1% 1/8W
R73	all	0757-0451	res 24.3K 1% 1/8W
R74	all	0757-0199	res 21.5K 1% 1/8W
R75	all	2100-3273	trimmer 2K 10%
R76	all	0698-3455	res 261K 1% 1/8W
R78	all	0698-3156	res 14.7K 1% 1/8W
R79,80	all	8159-0005	res 0 ohm
R82	all	0698-0082	res 464 1% 1/8W
R83-88	all	0698-3155	res 4.64K 1% 1/8W
R89	all	0757-0280	res 1K 1% 1/8W
R90,98,99	all	0698-3155	res 4.64K 1% 1/8W
R101	all	0698-6360	res 10K 0.1% 1/8W
R102	all	0698-3558	res 4.02K 1% 1/8W
R103	all	0698-3455	res 261K 1% 1/8W
R106	all	1810-0206	network, sip 10K X7
R109,110	all	0698-3155	res 4.64K 1% 1/8W
R111	all	0757-0316	res 42.2 1% 1/8W
R112	all	1810-0305	network, sip 4.7K X8
S1	all	3101-1973	GPIB switch
TB1	all	0360-2312	terminal block 4-contact
U1	all	1826-0468	IC MC3423P1 0V-level detect
U2	all	5080-2157	IC GAL programmed
U4	all	1820-8773	IC 80C51 microprocessor
U5	all	1826-1369	IC LT1021 voltage regulator 10V
U6	all	5080-2624	IC EPROM AM27512
U7	all	1826-2187	IC converter PM-7545
U8	all	1818-4134	IC RAM MCM6164C55
U9	all	1826-2187	IC converter PM-7545
U11	all	1826-2187	IC converter PM-7545
U12	all	1820-3210	IC UART MC68B50P
U13	all	1990-0543	IC opto-isolator
U14	all	1821-1479	IC 80C196 microprocessor
U16	all	1820-2724	IC latch 74HC373
U19	all	1826-0161	IC LM324N quad op amp
U20	all	1826-0609	IC 8-input multiplexer
U24	all	1826-1475	IC LT1011 comparator
U25	all	1826-1896	IC LT1001 op amp
U28	all	1990-1387	IC opto-isolator
U31	all	1820-6789	IC 75176B RS485 driver
U32	all	1990-1387	IC opto-isolator
U33	all	1826-0536	IC LM340AK-5 voltage regulator 5V
U35	all	5080-2156	IC GAL programmed
U36	all	5080-2625	IC GAL programmed
U37	all	1820-4185	IC DS3658N interface
U64-69	all	1826-1896	IC LT1001 op amp
U70	all	1818-4932	IC EEPROM NMC9346

**Table 5-3. Replaceable Parts List (continued)**

<b>Ref. Desig</b>	<b>Agilent Model</b>	<b>Agilent Part Number</b>	<b>Description</b>
U115	all	1820-6045	IC SN75ALS61610
U116	all	1820-6170	IC SN75ALS6160
U117	all	1821-1740	IC 9914 talker/listener
VR2	all	1902-3172	diode, zener 11V
VR3,4	all	1902-0049	diode, zener 6.19V
VR6,7,8	all	1902-0766	diode, zener 18.2V
Y1,2	all	0410-2109	oscillator 12MHz
		<b>A8 Mechanical</b>	
	all	1205-0564	heat sink (U33)
	all	5001-6732	GPIB mounting plate
<b>A9</b>	6035A	5060-3401	<b>Output Board</b>
C1,2	6035A	0180-4231	cap 750µF 350V
C3	6035A	0160-2569	cap 0.02µF 2KV
CR1	6035A	1901-0325	diode 700V 35A
CR2,3	6035A	1901-0759	diode 600V 3A
R1-4	6035A	0764-0027	res 75K 5% 2W
		<b>Chassis Electrical</b>	
B1	all	3160-0097	fan
C6	6030A	0160-2569	cap 0.02µF 20% 2KVdc (output board)
C2	6030A	0180-3703	cap 1500µF 250V (output board)
	6031A	0180-3493	cap 10000µF 40V (output board)
	6032A	0180-3491	cap 2600µF 75V (output board)
CB1	all	3105-0126	circuit breaker 25A 250Vac
L4	all	5080-2307	choke (input line) 380µH
S3	all	3101-0402	switch DPST (on/off)
W1	all	06032-60003	ribbon cable (A3 to A8)
W2	all	8120-4352	cable assembly, 3-pin (A1 to A8)
W3	all	06032-60002	cable assembly, 5-pin (A2 to A3)
W5,6	all	8120-4356	ribbon cable (A2 to A8)
		<b>Chassis Mechanical</b>	
	all	06032-00025	chassis
	all	5021-8403	front frame casting
	all	5041-8802	top trim strip
	all	5001-0539	side trim strip (2)
	all	06032-00015	front sub-panel
	6030A	06030-00012	front panel, screened
	6031A	06031-00013	front panel, screened
	6032A	06032-00023	front panel, screened
	6035A	06035-00001	front panel, screened
	all	01650-47401	knob, RPG adjust
	all	2190-0736	spacer
	all	5041-0309	plain key cap (4)
	all	5041-2089	lettered key cap (LCL)
	all	4040-1954	display window
	all	06032-00011	fan baffle
	all	06032-00012	dc output plate (lettered)

**Table 5-3. Replaceable Parts List (continued)**

<b>Ref. Desig</b>	<b>Agilent Model</b>	<b>Agilent Part Number</b>	<b>Description</b>
		Chassis Mechanical (cont)	
	all	06032-00010	output buss bar (2)
	all	0340-1095	insulator for bus bar (4)
	all	0380-1362	standoff, 12mrn (buss bar) (2)
	all	1510-0044	binding post, rear panel ground
	all	0400-0086	insulated bushing (under A6) (2)
	all	5001-6739	cover, top
	all	5001-6738	cover, bottom
	all	06032-00024	cover, internal (lettered)
	all	5040-1626	cover, dc output
	all	5040-1627	cover, ac input
	all	5040-1625	strain relief (line cord)
	all	5062-3703	strap handle (2)
	all	5041-8819	handle retainer, front (2)
	all	5041-8820	handle retainer, back (2)
	all	5041-8801	foot (4)

## Component Location and Circuit Diagrams



This chapter contains component location diagrams, schematics, and other drawings useful for maintenance of the power supply. Included in this section are:

- Component location illustrations (Figures 6-1 through 6-9), showing the physical location and reference designators of almost all electrical parts. (Components located on the rear panel are easily identified.)
- Notes (Table 6-1) that apply to all schematic diagrams.
- Schematic diagrams (Figures 6-10 through 6-13).

### WARNING

AC line voltage is present on the A1 Main Board Assembly whenever the power cord is connected to an ac power source.

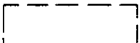
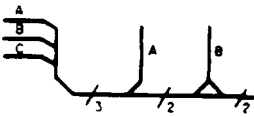
**Table 6-1. Schematic Diagram Notes**

-  denotes front-panel marking.
-  denotes rear-panel marking.
- Complete reference designator consists of component reference designator prefixed with assembly number (e.g.: A2R14).
- Resistor values are in ohms. Unless otherwise noted, resistors are either 1/4W, 5% or 1/8W, 1%. Parts list provides power rating and tolerance for all resistors.
- Unless otherwise noted, capacitor values are in microfarads.
- Square p.c. pads indicate one of the following:
  - pin 1 of an integrated circuit.
  - the cathode of a diode or emitter of a transistor.
  - the positive end of a polarized capacitor.
- Schematic components marked with an asterisk (\*) indicate that different values are used in each model. Refer to the parts list for the applicable values.
- Schematic components marked with a dagger (†) are listed under chassis, electrical in the parts list.
- This capacitor is only used on 6030A and 6035A units. C6 is mounted on the chassis on 6030A units. C3 is mounted on the A9 board on 6035A units.
-  indicates multiple paths represented by only one line. Reference designators with pin numbers indicate destination, or signal names identify individual paths. Numbers indicate number of paths represented by the line.
- Inter-board commons have letter identifications (e.g.: ); commons existing on a single assembly have number identifications (e.g.: ).

**Table 6-1. Schematic Diagram Notes (continued)**

For single in-line resistor packages, pin 1 is marked with a dot. For integrated circuit packages, pin 1 is either marked with a dot, or pin 1 is to the left (as viewed from top) of indentation on the integrated circuit package (except for A8U6 and A8U8).

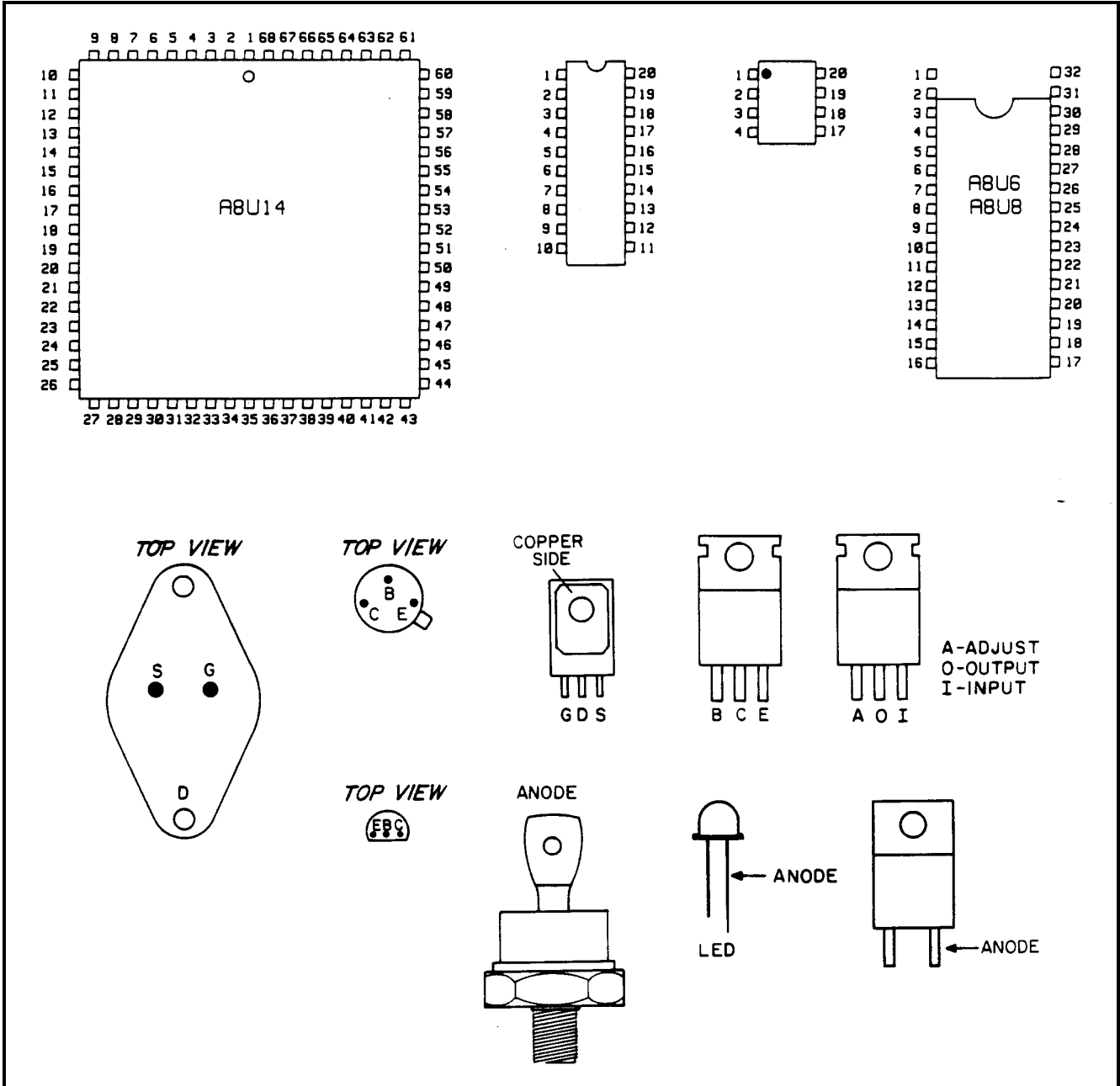

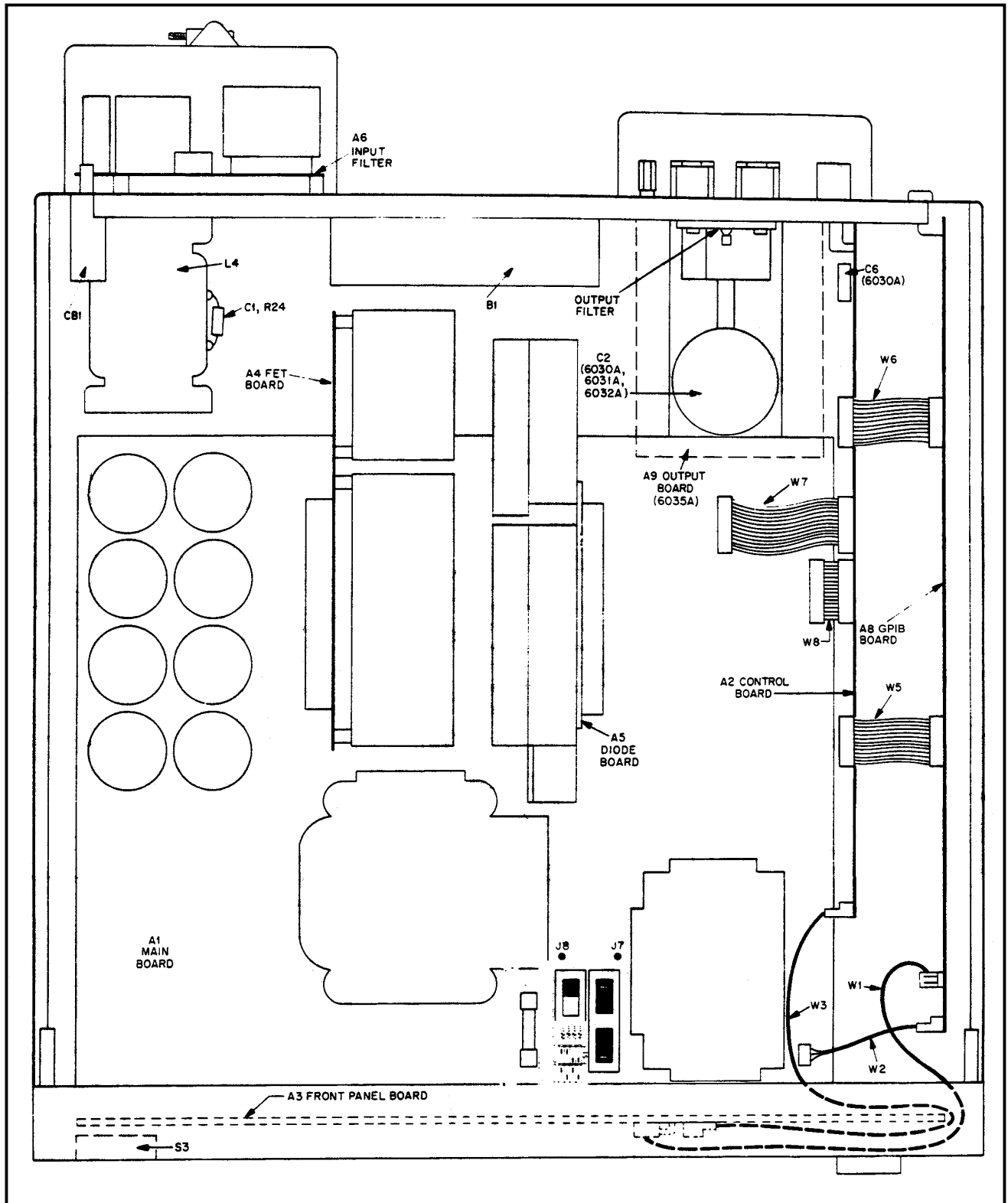

Figure 6-1. Top View, Top Covers Removed

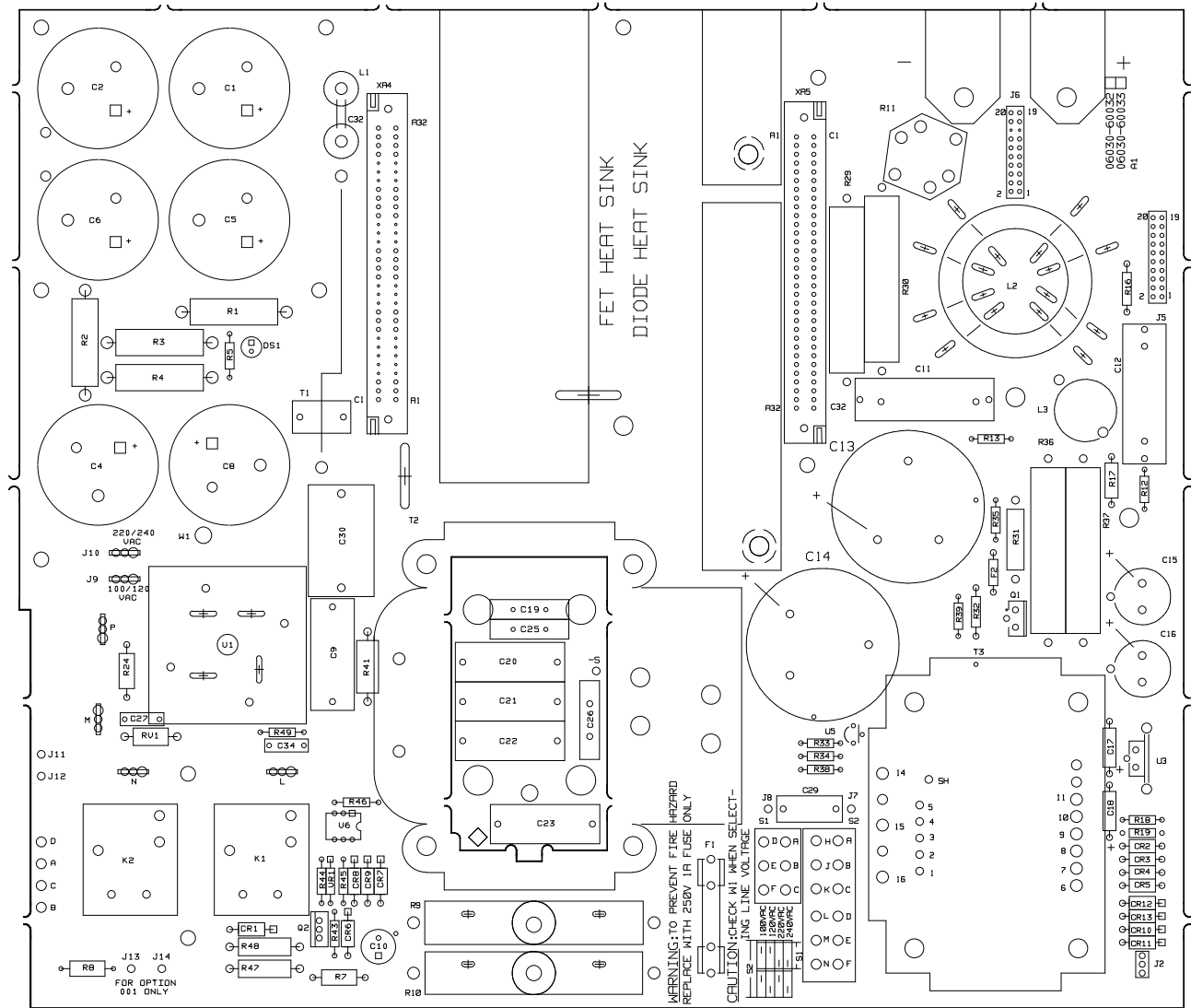

Figure 6-2A. 6030A/35A Main Board (A1) and Output Filter Component Location



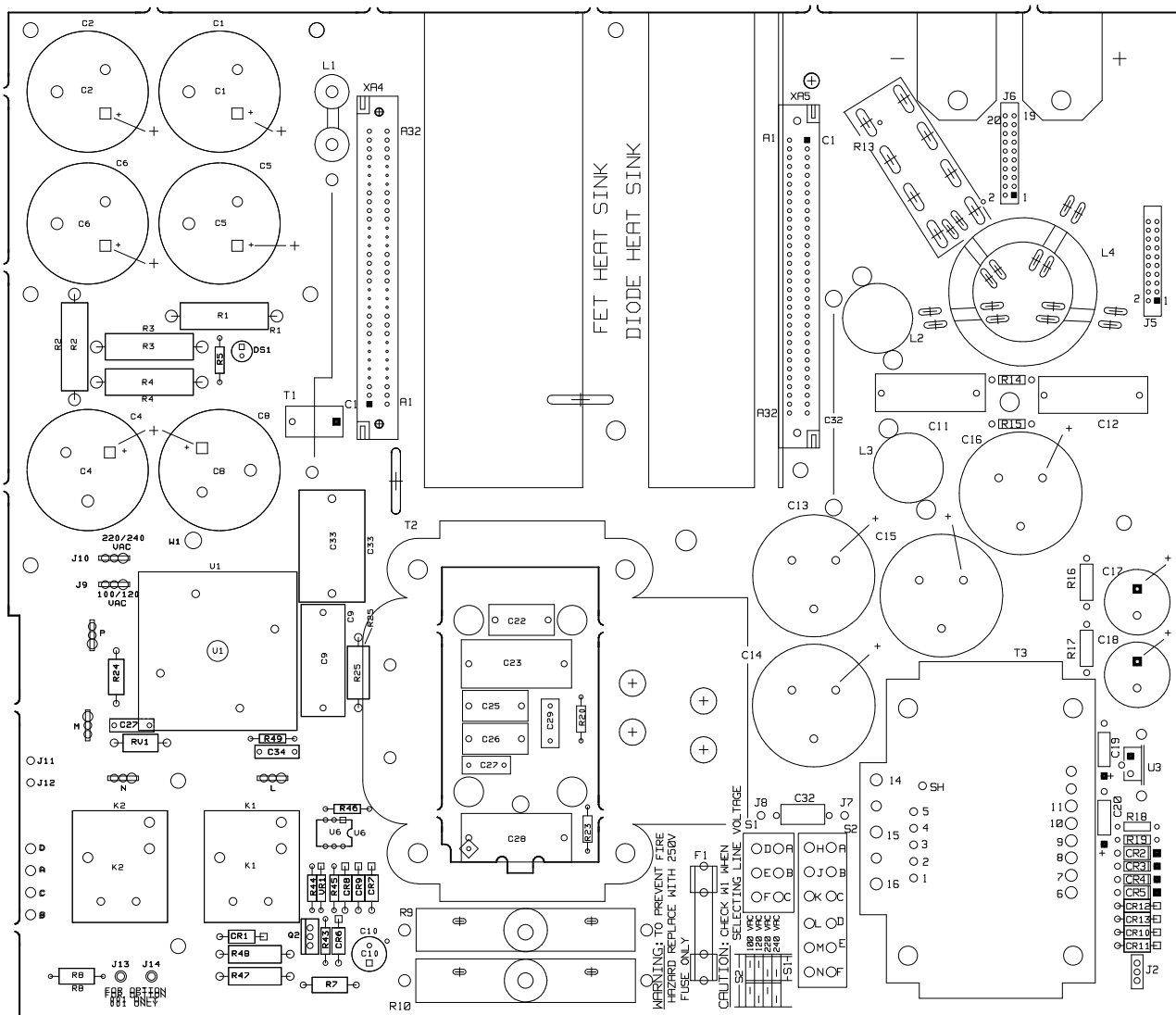

Figure 6-2B. 6031A Main Board (A1) and Output Filter Component Location

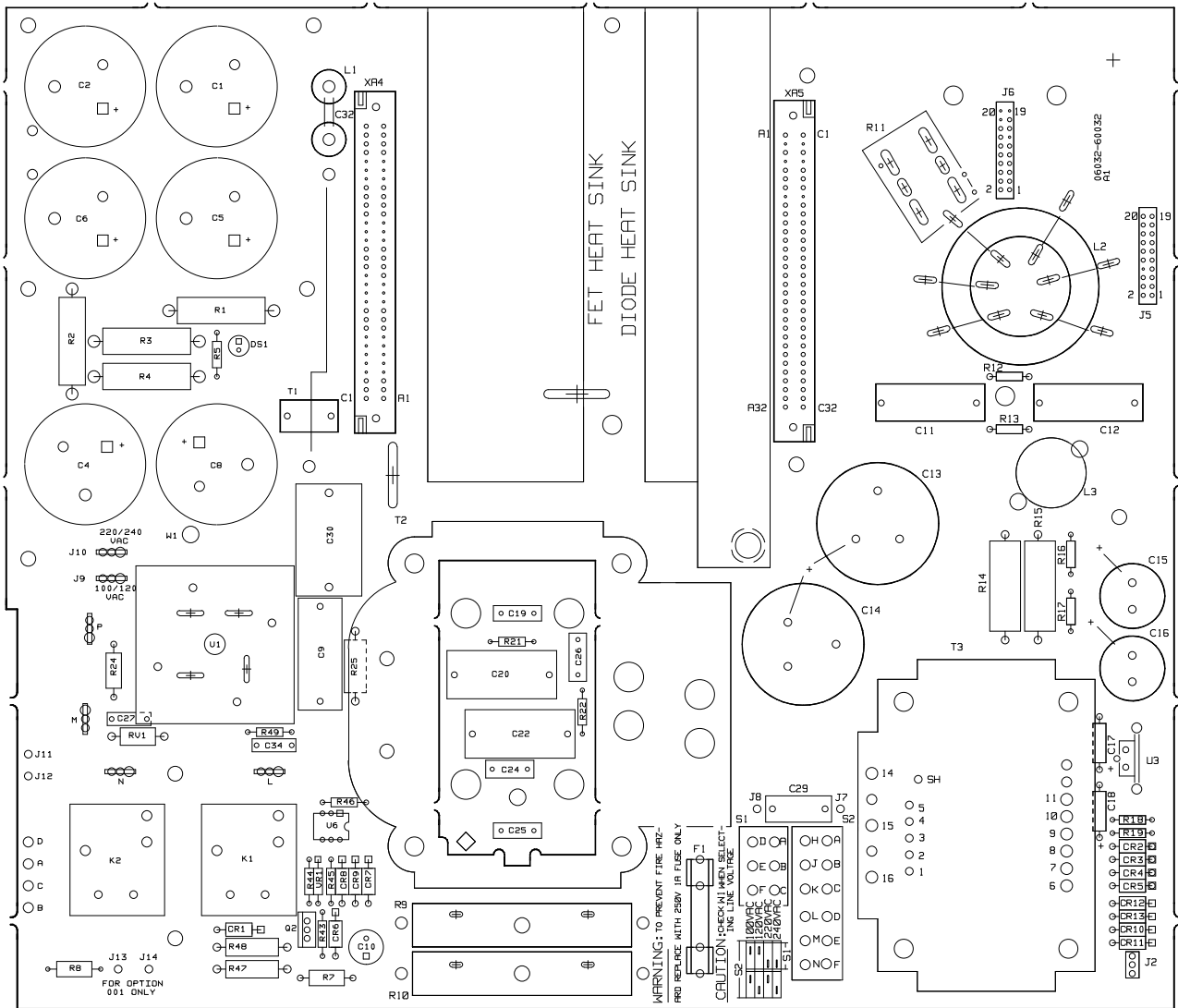

Figure 6-2C. 6032A Main Board (A1) and Output Filter Component Location

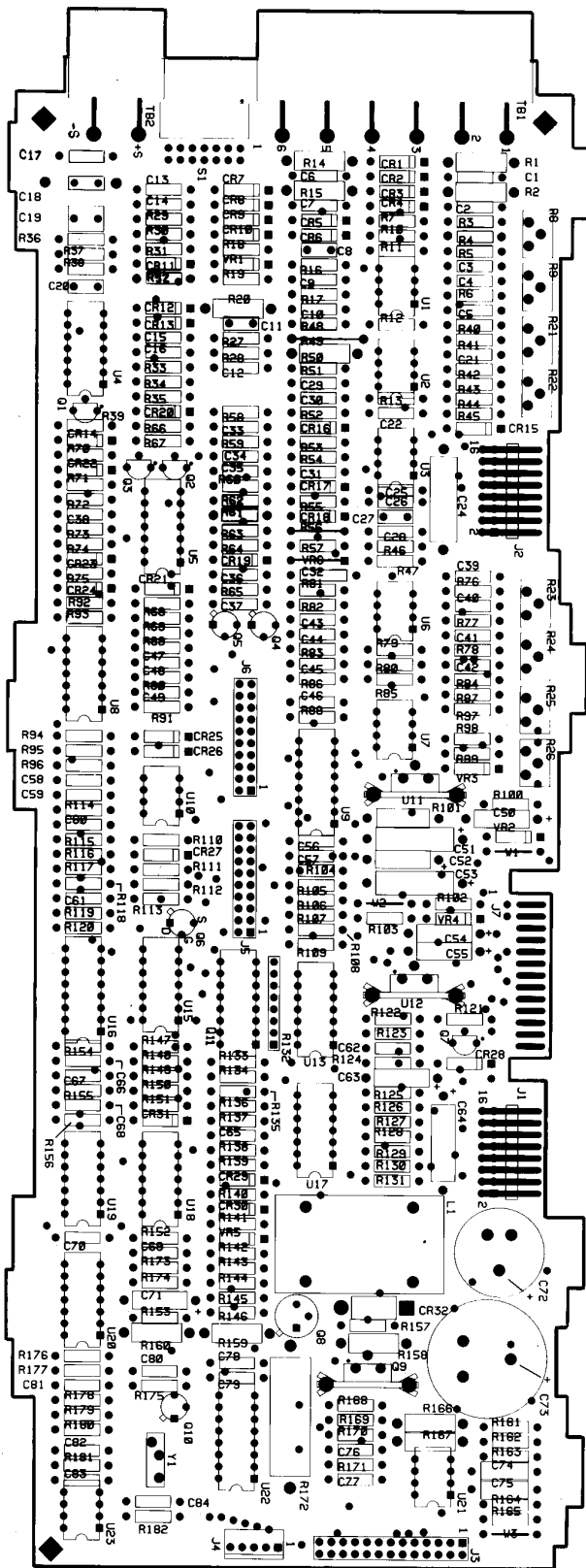

Figure 6-3. Control Board (A2) Component Location

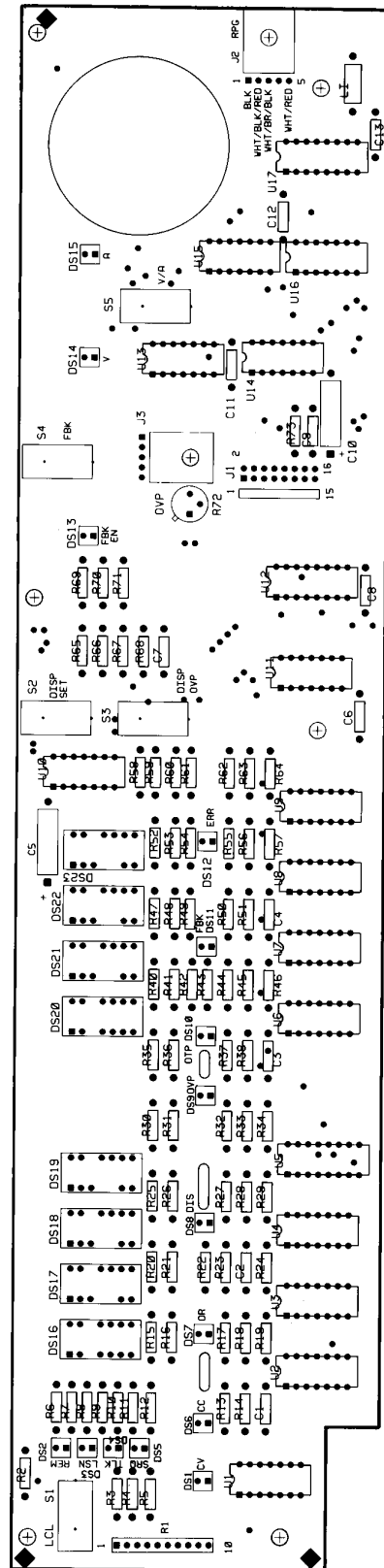

Figure 6-4. Front Panel Board (A3) Component Location

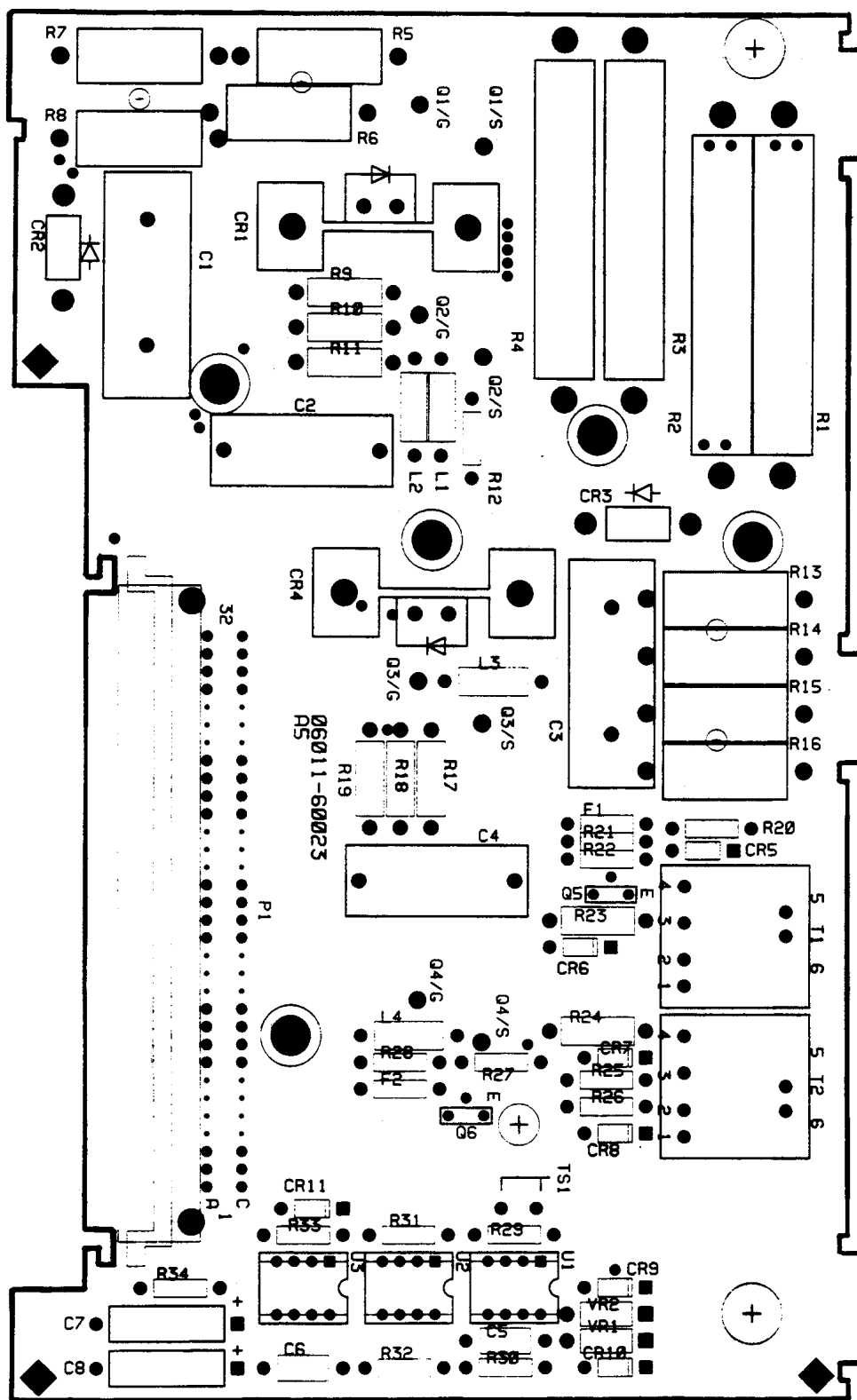

Figure 6-5. FET Board (A4) Component Location

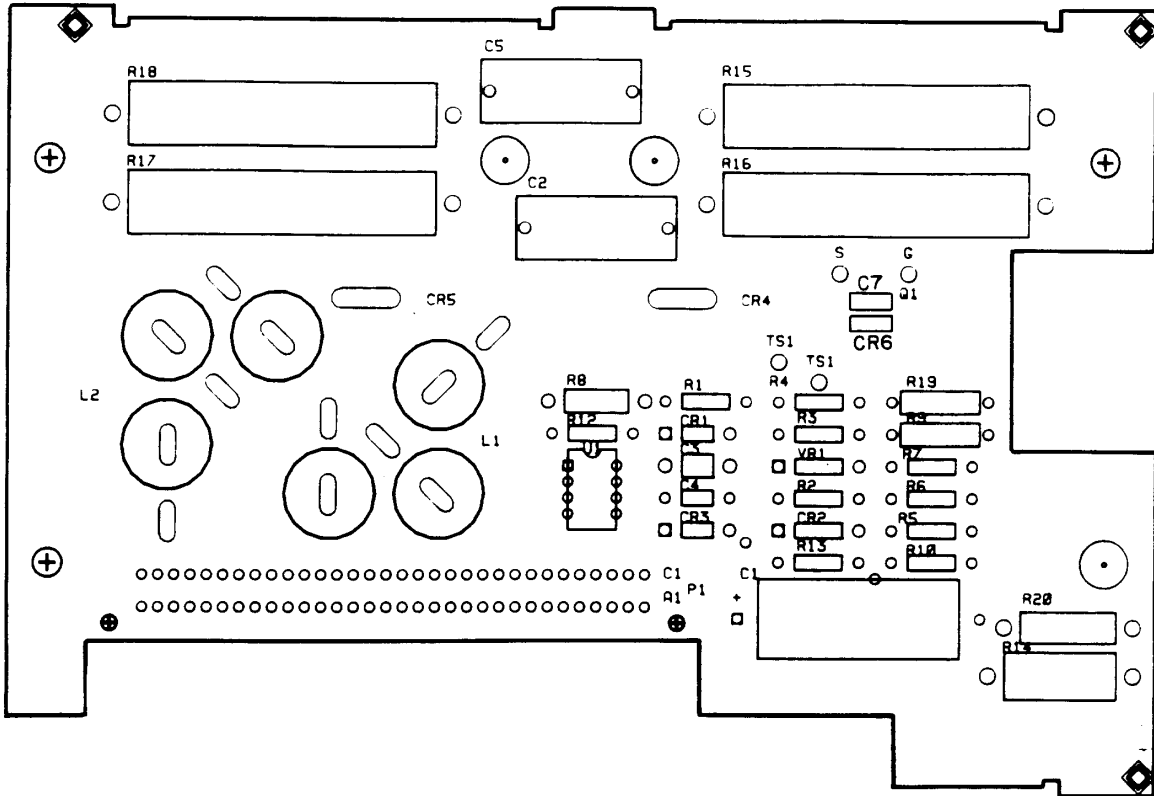

Figure 6-6A. 6030A/35A Diode Board (A5) Component Location

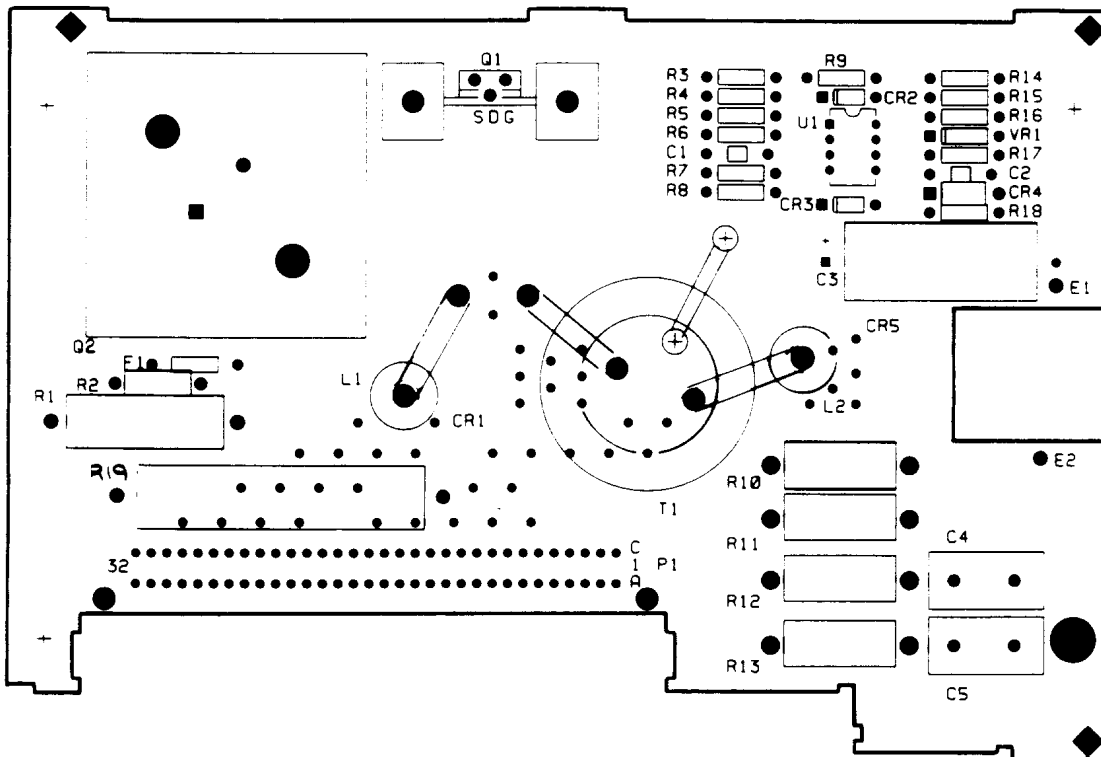

Figure 6-6B. 6031A Diode Board (A5) Component Location

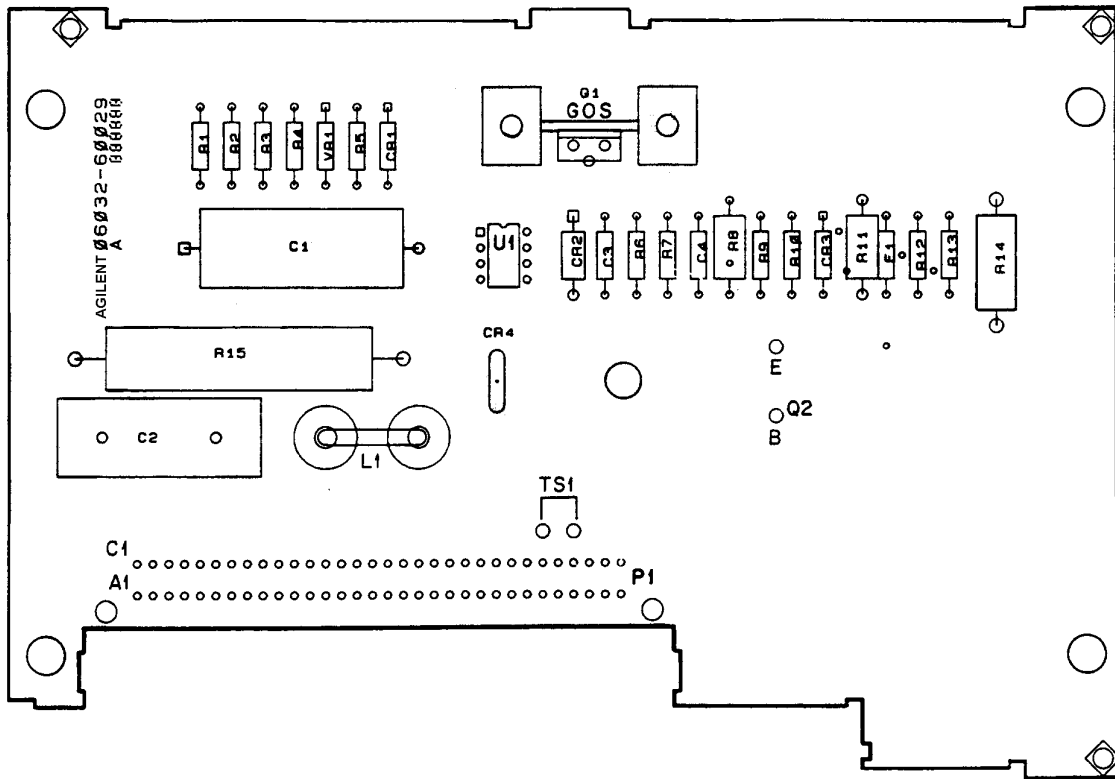

Figure 6-6C. 6032A Diode Board (A5) Component Location

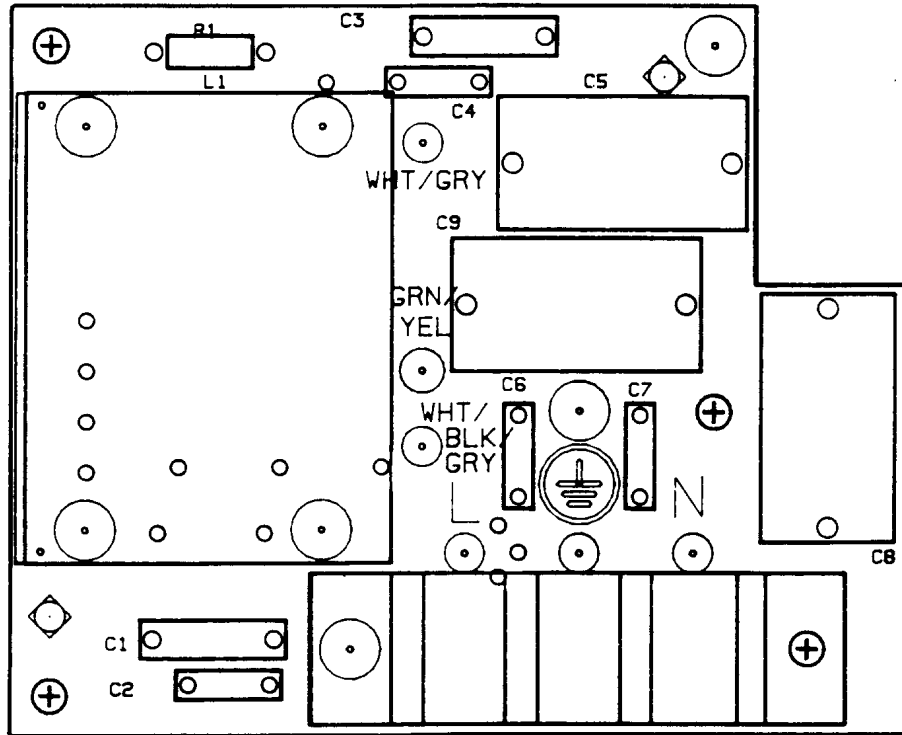

Figure 6-7. AC Input Filter (A6) Component Location

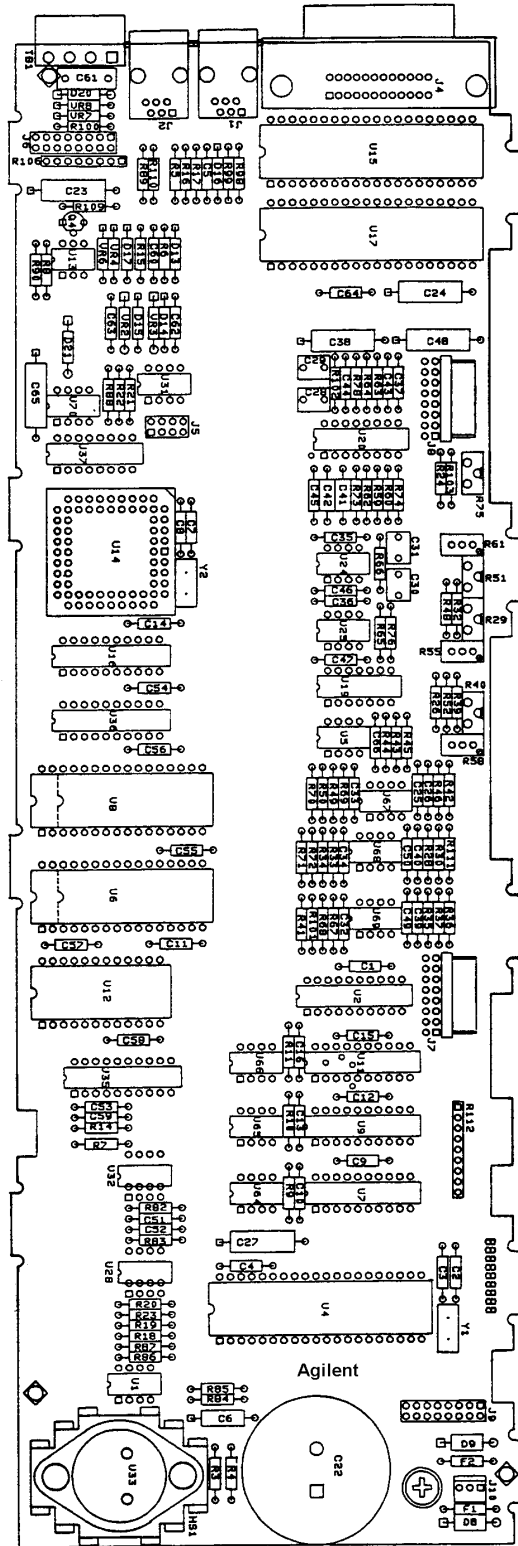

Figure 6-8. GPIB Board (A8) Component Location

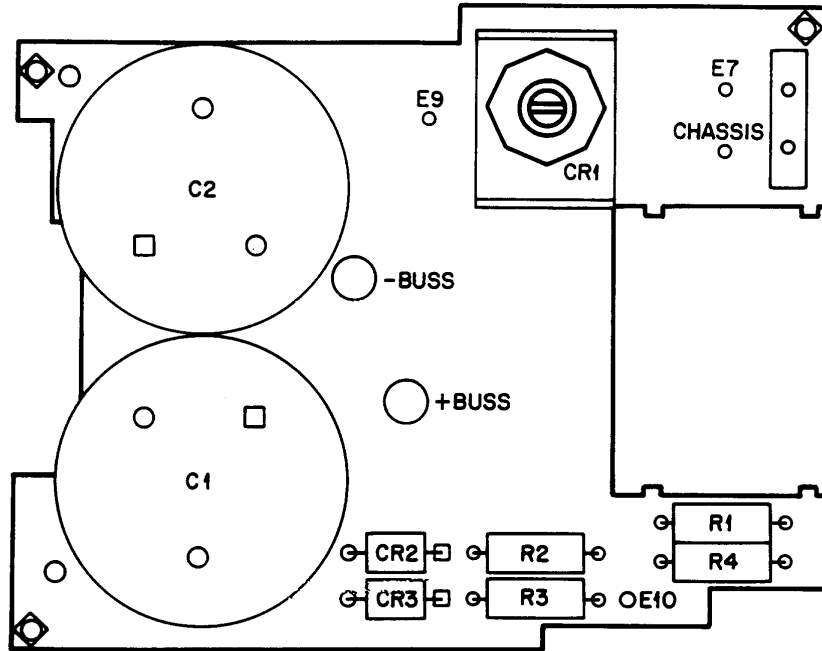

Figure 6-9. 6035A Output Board (A9) Component Location



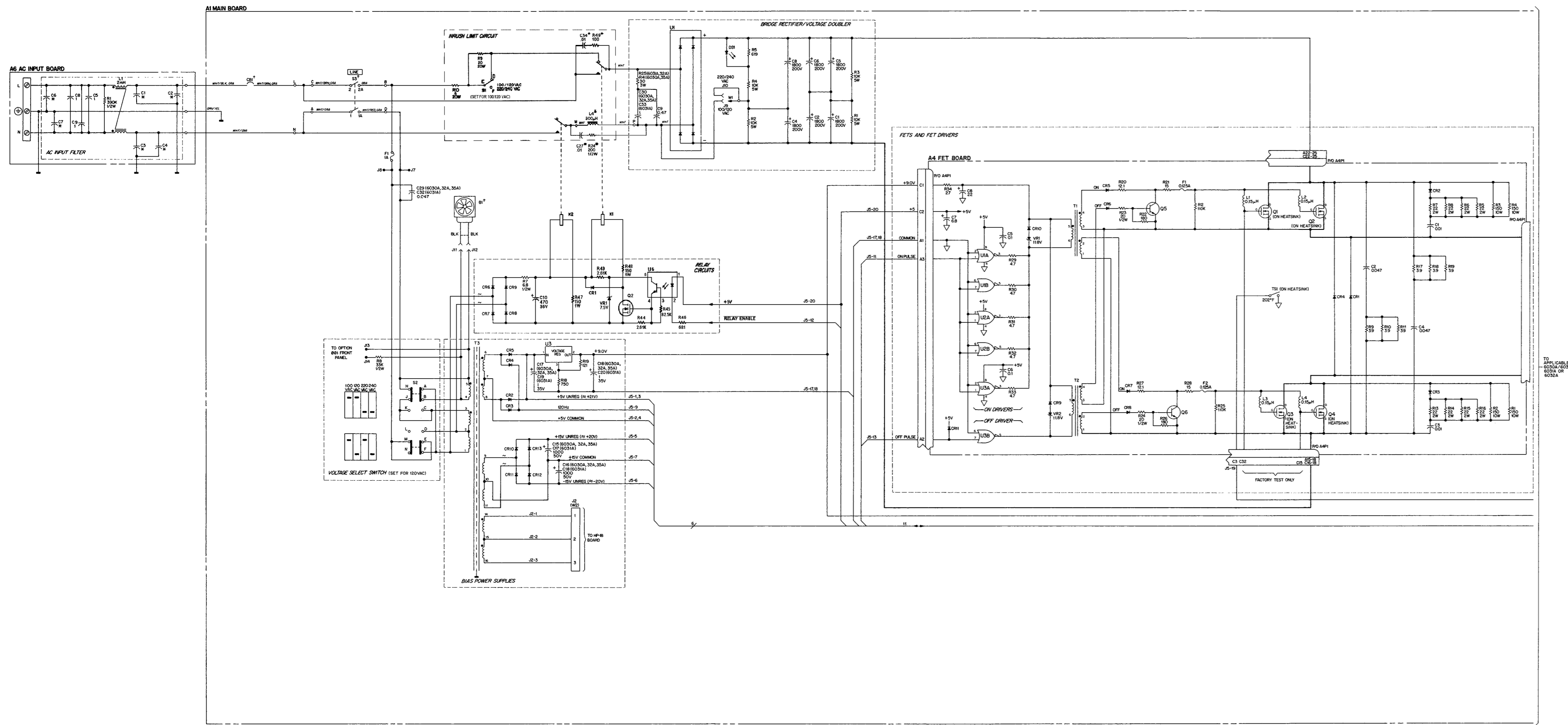

Figure 6-10A. Power Mesh Schematic Diagram (AC Input and FET Board)

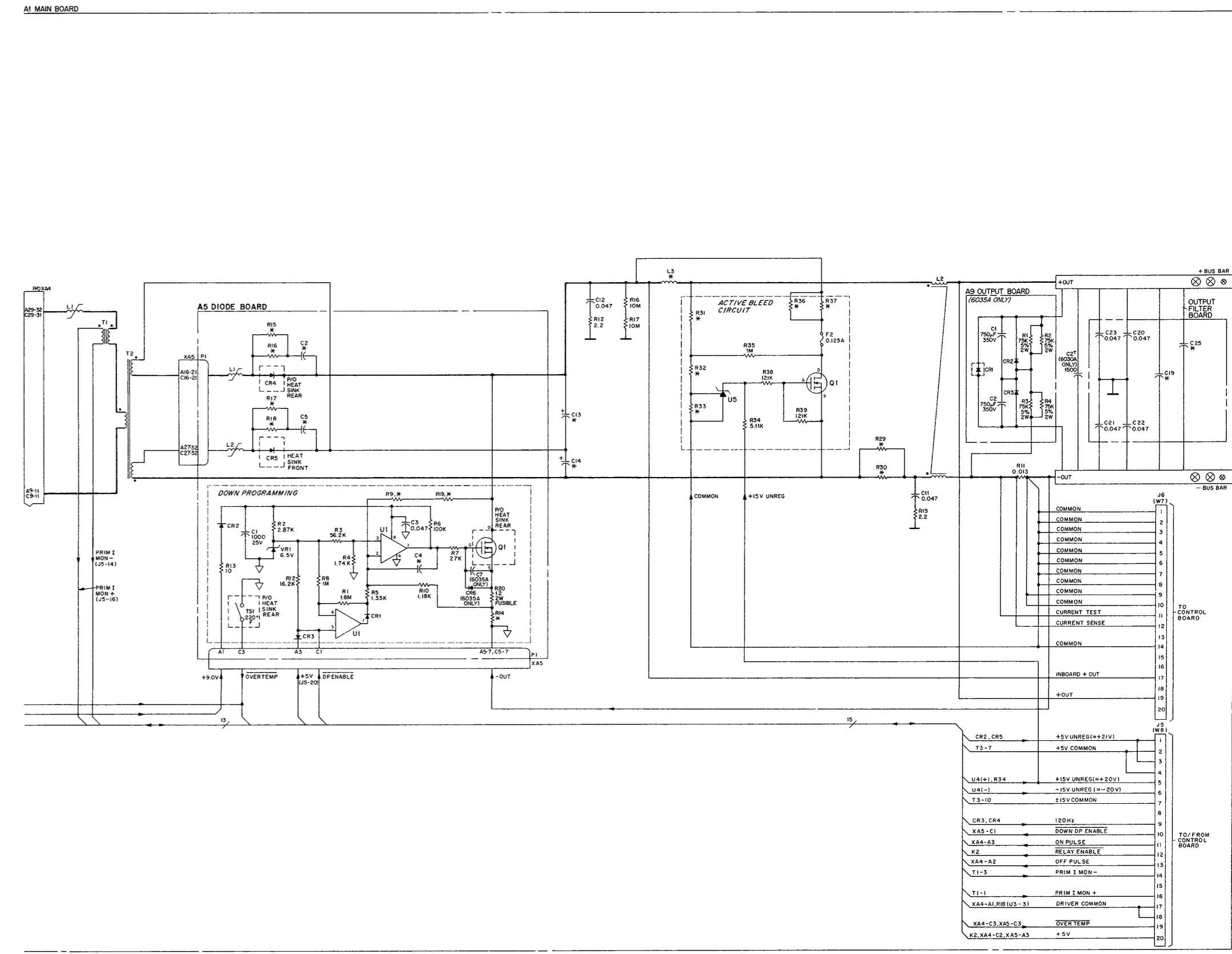
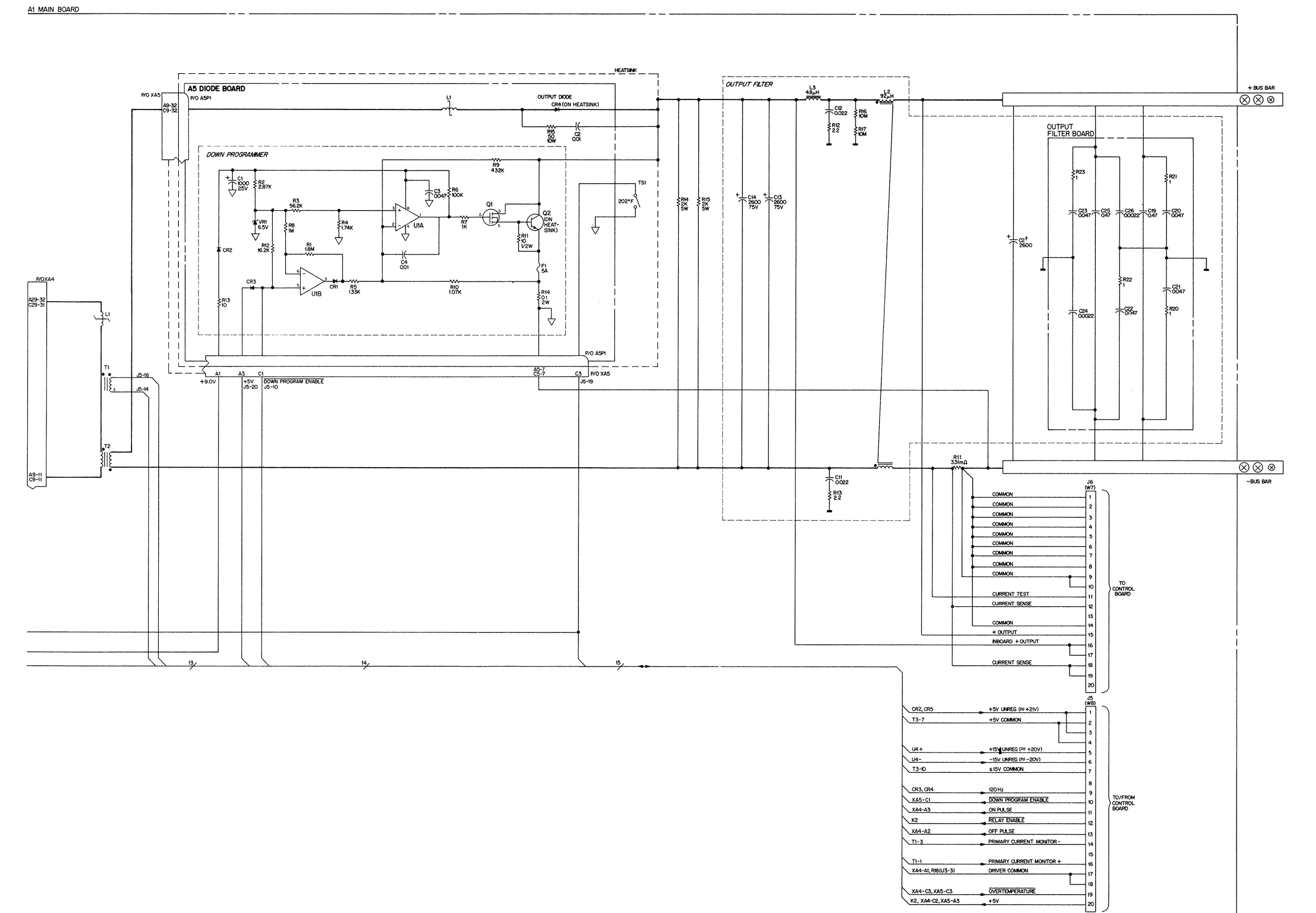
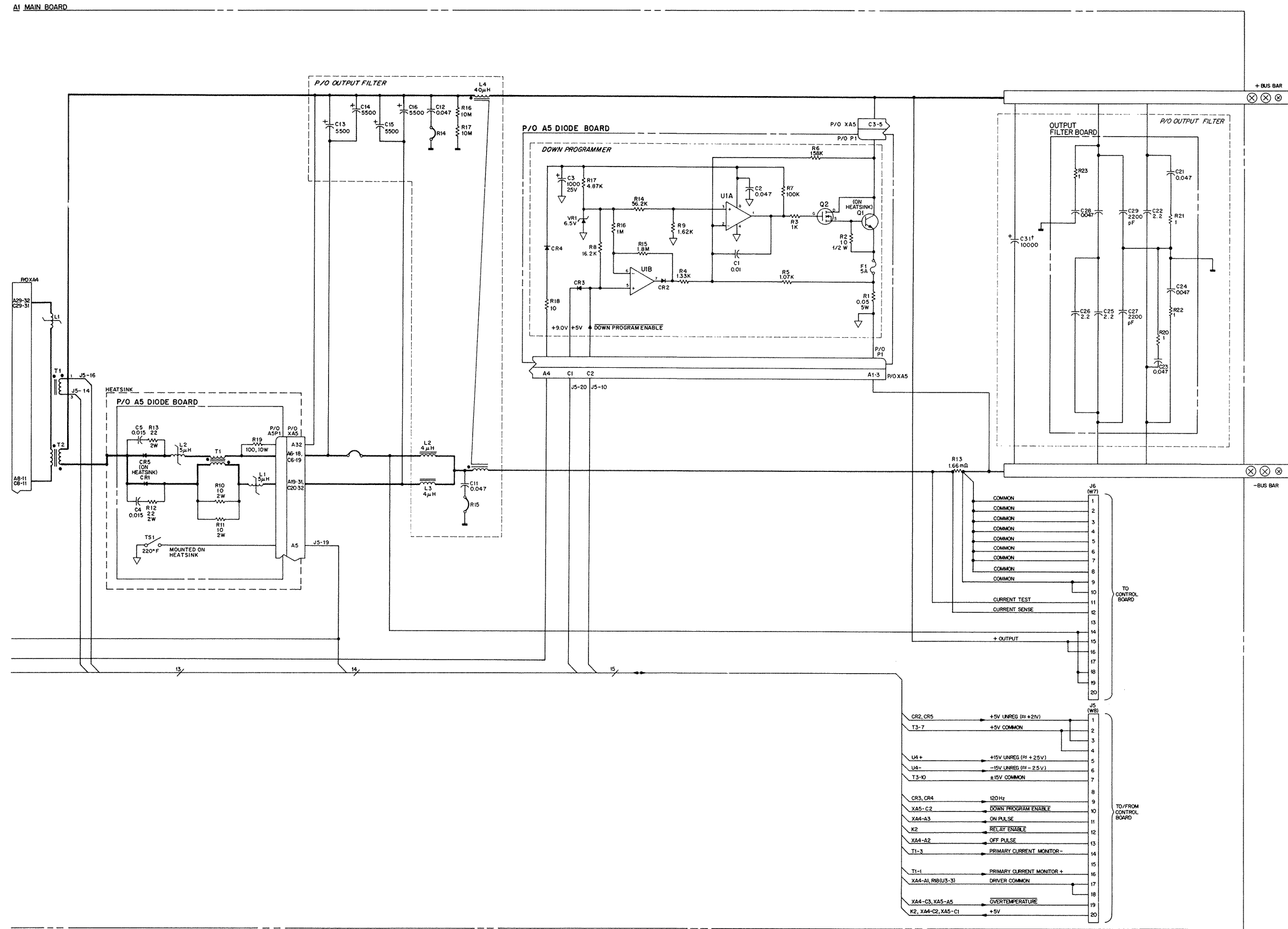
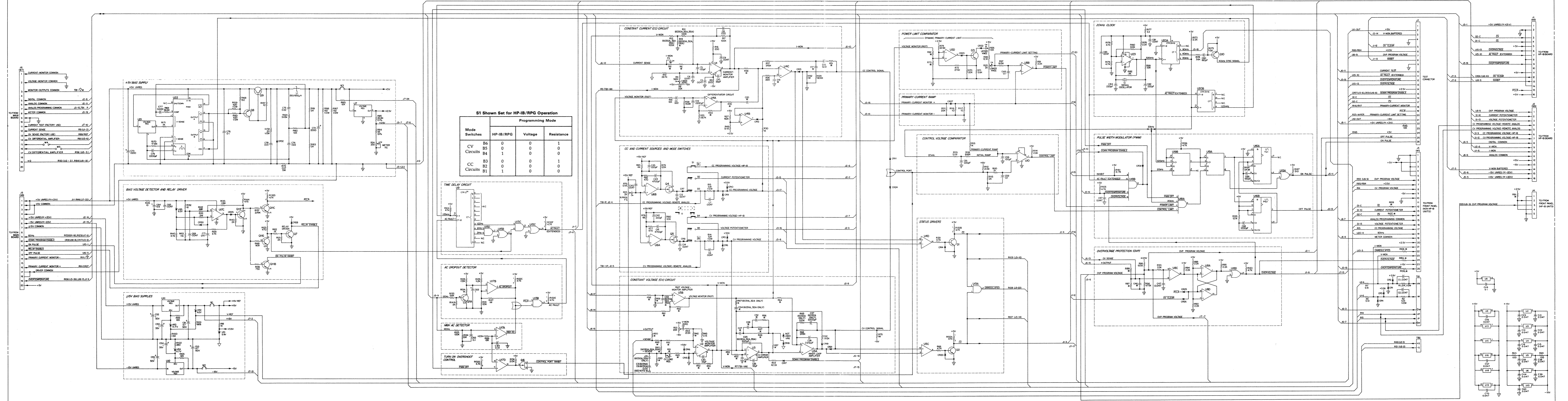

Figure 6-10B. 6030A/35A Power Mesh Schematic Diagram (Diode Board and Output Filter)







**S1 Shown Set for HP-IB/RPG Operation**

Programming Mode			
Mode Switches	HP-IB/RPG	Voltage	Resistance
CV B6	0	0	1
B5	0	0	0
B4	1	0	0
B3	0	0	1
B2	0	0	0
B1	1	0	0

Figure 6-11. Control Board Schematic Diagram



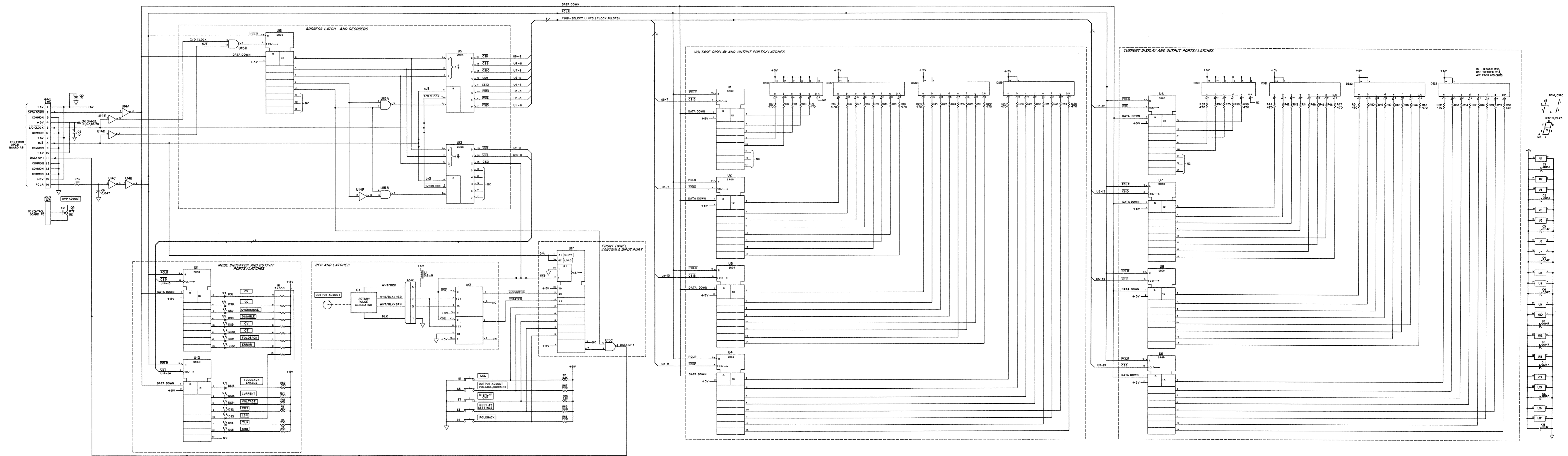

Figure 6-12. Front Panel Board Schematic Diagram

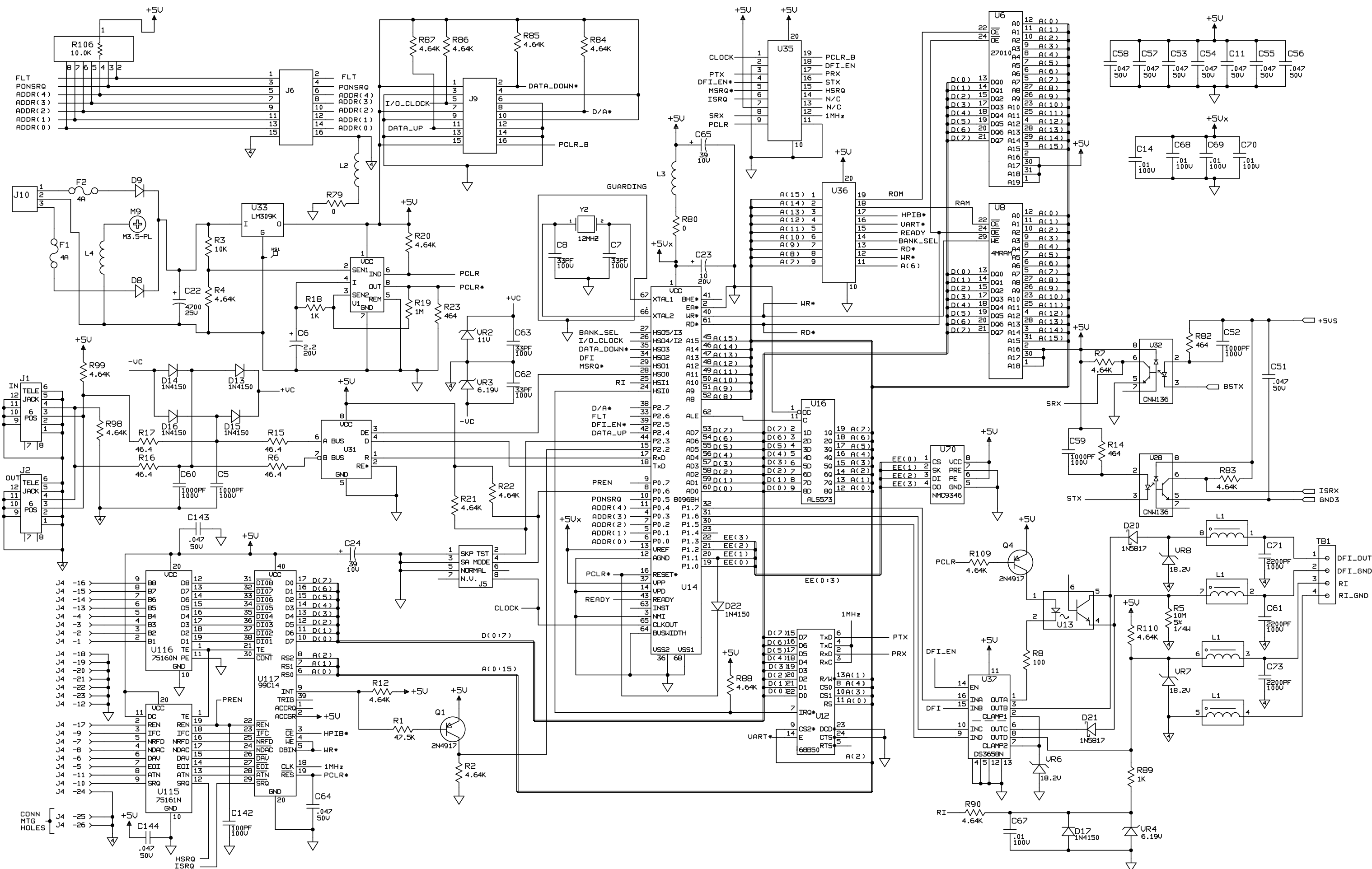

Figure 6-13A. GPIB Board Schematic Diagram

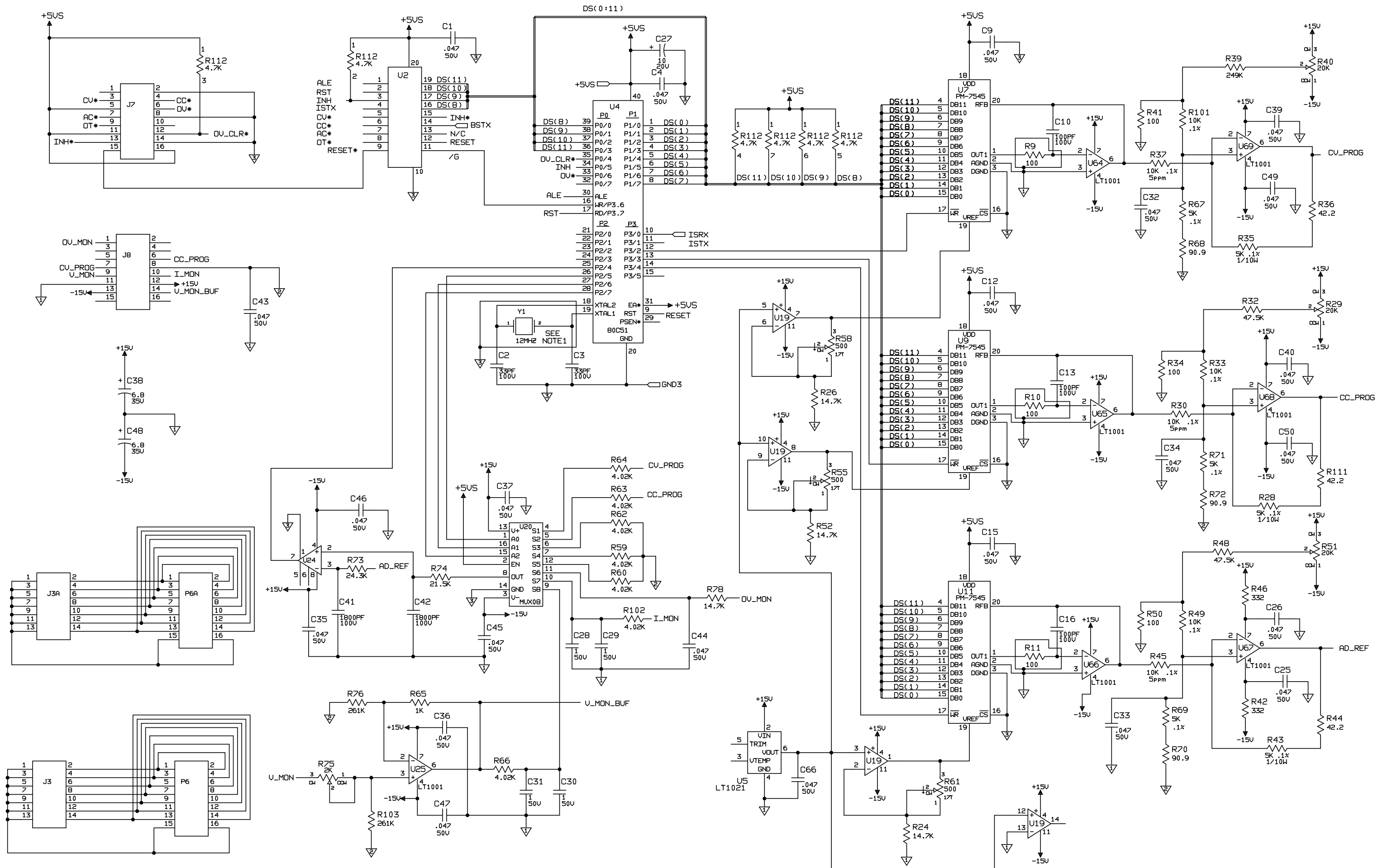

Figure 6-13B. GPIB Board Schematic Diagram

## 100 Vac Input Power Option 100

---

### General Information

#### Description

Option 100 is a modification of Agilent 6030A/31A/32A/35A power supplies that involves changing resistors on the A2 board, recalibrating the supply, and changing the Front Panel. These changes allow the units to operate at a lower line voltage of 87 to 106 Vac, while operating on the same line frequency of 48 to 63 Hz. The reduced input voltage limits the output power to approximately 700 watts. Other specifications that change due to Option 100 include Programming Response Time, Overvoltage Protection and Remote Analog Programming.

#### Scope of Appendix A

This appendix contains all the information necessary to support Agilent 6033A/31A/32A/35A power supplies that are equipped with Option 100. The appendix describes only the changes pertaining to Option 100 and how they affect the other portions of this manual. Unless otherwise specified in Appendix A, all other portions of the manual apply to both the standard unit and the Option 100 unit.

#### Suggestions for Using Appendix A

The Option 100 changes are listed sequentially, starting with Chapter 1 in the main body of the manual and working back through Chapter 6. It is recommended that the user mark all the necessary changes directly into his manual. This will update the manual for Option 100 and eliminate the need for constant referrals back to Appendix A.

#### Chapter 1 Manual Changes

On Page 9, in Scope change the output power from 1000 to 700 watts.

#### Chapter 2 Manual Changes

On Page 17, in Constant Voltage Full Scale Calibration step b, and Voltage Monitor and Remote Readback Full Scale Calibration step b, change the VSET values to:

VSET 170 (6030A)

VSET 50 (6032A)

VSET 425 (6035A)

On Page 17, in Voltage Monitor and Remote Readback Full Scale Calibration step d, change the A8R58 adjustment to:

170.025  $\pm$  6mV (6032A)  
50.0075  $\pm$  1.52mV (6032A)  
425.063  $\pm$  6 $\mu$ V (6035A)

On Page 17, in Voltage Monitor and Remote Readback Full Scale Calibration step c, change 5.000625V to:

4.250625V  $\pm$  100 $\mu$ V (6030A/35A)  
4.167187V  $\pm$  100 $\mu$ V (6032A)

On Page 17, in Voltage Monitor and Remote Readback Full Scale Calibration step f, change the A8R61 adjustment to between:

170.00 and 170.50Vdc (6030A)  
50.00 and 50.025Vdc (6032A)  
425.00 and 425.125Vdc (6035A)

On Page 20, in Power Limit Calibration step a, change 240 Vdc to 206 Vdc.

On Page 20, in Power Limit Calibration step b, change the load resistor as follows:

2.9 ohm 1500 W (6030A)  
0.05 ohm 1500 W (6031A)  
0.29 ohm 1500 W (6032A)  
32 ohm 1500 W (6035A)

On Page 20, in Power Limit Calibration step e, change the VSET values to:

VSET 50 (6030A)  
VSET 6 (6031A)  
VSET 14.5 (6032A)  
VSET 163 (6035A)

On Page 20, in Power Limit Calibration step f, change the output values to:

50  $\pm$  1V (6030A)  
6  $\pm$  0.08V (6031A)  
14.5  $\pm$  0.1V (6032A)  
163  $\pm$  1V (6035A)

On Page 20, in Power Limit Calibration step g, change the current and resistor settings to:

32 ohm 1500W (6030A)  
0.50 ohm 1500W (6031A)  
2.8 ohm 1500W (6032A)  
212 ohm 1500W (6035A)

On Page 20, in Power Limit Calibration step i, change the VSET or ISET values to:

VSET 170 (6030A)  
ISET 40 (6031A)  
VSET 50; ISET 18 (6032A)  
VSET 425 (6035A)

On Page 21, in Power Limit Calibration step j, change the output values to:

170  $\pm$  2V (6030A)  
@40A (6031A)  
50  $\pm$  0.4V @17.5A (6032A)  
425  $\pm$  0.4V @2A (6035A)



On Page 21, in Electronic load, make the following resistor changes:

from 40 to 36 ohms (6030A)  
from 0.4 to 0.57 ohms (6031A)  
from 3.5 to 3 ohms (6032A)  
from 250 to 300 ohms (6035A)

from 3.5 to 2.4 ohms (6030A)  
from 0.069 to 0.043 ohms (6031A)  
from 0.4 to 0.27 ohms (6032A)  
from 40 to 30 ohms (6035A)

On Page 23, in Voltage Programming and Readback Accuracy step g, change the VSET values to:

VSET 170 (6030A)  
VSET 50 (6032A)  
VSET 425 (6035A)

On Page 23, in Voltage Programming and Readback Accuracy step h, change the range values to:

169.796 to 170.205Vdc (6030A)  
49.9375 to 50.0525Vdc (6032A)  
423.538 to 426.462Vdc (6035A)

On Page 23, in Voltage Programming and Readback Accuracy step i, change the values to:

$\pm 0.216$ Vdc (6030A)  
 $\pm 0.060$ Vdc (6032A)  
 $\pm 2.325$ Vdc (6035A)

On Page 23, in Load Effect (Load Regulation) step c, change the output voltage to:

42Vdc (6030A)  
5.2Vdc (6031A)  
13.5Vdc (6032A)  
150Vdc (6035A)

On Page 24, in Load Effect (Load Regulation) step h, change the values to:

0.009Vdc (6030A)  
0.0035Vdc (6031A)  
0.006Vdc (6032A)  
0.028Vdc (6035A)

On Page 24, in Source Effect (Line Regulation) step d, change the output voltage to:

170Vdc (6030A)  
50Vdc (6032A)  
425Vdc (6035A)

On Page 25, in Source Effect (Line Regulation) step e, change the output current to:

4.7A dc (6030A)  
35A dc (6032A)  
16A dc (6035A)  
1.38A dc (6035A)

On Page 25, in Source Effect (Line Regulation) step i, change the values to:

0.022Vdc (6030A)  
0.008Vdc (6032A)  
0.055Vdc (6035A)

On Pages 25-27, in RMS Measurement Procedure, Peak Measurement and Load Transient Recovery Time, change the output voltage to

42Vdc (6030A)  
5.2Vdc (6031A)  
13.5Vdc (6032A)  
150Vdc (6035A)

On Page 28 and 29, in paragraph Current Programming and Readback Accuracy steps c and g, change the VSET values to:

VSET 170 (6030A)  
VSET 50 (6032A)  
VSET 425 (6035A)

On Page 29, in Load Effect (Load Regulation) step c, change the output current to:

4.7A dc (6030A)  
35A dc (6032A)  
16A dc (6035A)  
1.38A dc (6035A)

On Page 29, in Load Effect (Load Regulation) step cd change the output voltage to:

170Vdc (6030A)  
50Vdc (6032A)  
425Vdc (6035A)

On Page 30, in Source Effect (Line Regulation) step d, change the output current to:

17A dc (6030A)  
120A dc (6032A)  
50A dc (6035A)  
5A dc (6035A)

On Page 30, in Source Effect (Line Regulation) step e, change the output voltage to:

42Vdc (6030A)  
5.2Vdc (6031A)  
13.5Vdc (6032A)  
150Vdc (6035A)

On Page 30, in PARD Ripple and Noise, make the following resistor changes:

from 3.5 to 2.4 ohms (6030A)  
from 0.069 to 0.043 ohms (6031A)  
from 0.4 to 0.27 ohms (6032A)  
from 40 to 30 ohms (6035A)

On Page 30, Initialization, change step 2 as follows:

2. Turn the power on, and depending on your unit's model number, send the following strings:

"EEINIT 6030"	"EEINIT 6031"
"EEPROM 10,4,175.00"	"EEPROM 10,4,17.5"
"EEINIT 6032"	"EEINIT 6035"
"EEPROM 10,4,51.495"	"EEPROM 10,4,437.50"

### **Chapter 3 Manual Changes:**

On Page 45, in Readback Multiplexer (U20), change Node U20-9, Measurement from + 5V to:  
+ 4.25V (6030A/31A/35A)  
+ 4.167V (6032A)

On Page 53 in Main Troubleshooting and on Page 54 in Troubleshooting No-Out Failures step d, change 320Vdc to 250Vdc.

### **Chapter 4 Manual Changes:**

On Page 74 In Power Mesh and Input Circuits, change 320Vdc to 250Vdc.

### **Chapter 5 and 6 Manual Changes**

On Page 86, change the A2 board from:  
06030-60022 to 06030-60026 (6030A)  
06011-60022 to 06031-60026 (6031A)  
06032-60022 to 06032-60026 (6032A)  
06030-60028 to 06035-60020 (6035A)

On Page 91 and on the schematic diagram Figure 6-10, change R81 to:  
1.82K, 1% 1/8W Agilent P/N 0757-0429 (6030A, 6035A only)  
1.78K, 1% 1/8W Agilent P/N 0757-0278 (6032A only)

On Page 92 and on the schematic diagram Figure 6-10, change R92 to:  
10K, 1% 1/8W Agilent P/N 0757-0442 (6030A, 6035A only)  
34.8K, 1% 1/8W Agilent P/N 0757-0123 (6031A only)  
11.5K, 1% 1/8W Agilent P/N 0698-5383 (6032A only)

On Page 94, add option 100 label (A2 board) 9320-5540.

On Page 102, change front panel from:  
06030-00012 to 06030-00011 (6030A)  
06031-00013 to 06031-00012 (6031A)  
06032-00023 to 06032-00022 (6032A)  
06035-00001 to 06035-00003 (6035A)

On Page 103, add line voltage label (rear panel) Agilent P/N 06032-81004.



# Blank Front Panel Option 001

---

## Introduction

This appendix describes the blank front panel option (Option 001) for the Agilent 6030A/31A/32A power supplies. Option 001 is designed for applications in which front panel operation and monitoring are unnecessary. It has no front-panel controls and indicators except for the LINE switch and OVP ADJUST control found on the standard unit, and a pilot light to indicate when ac input power is turned on. All other characteristics of the standard are retained.

Except for references to front-panel controls and indicators, most of the information in the manual applies to Option 001 units. No attempt has been made in this appendix to change every reference to front-panel controls and indicators. In general, information in this appendix replaces only those procedures whose modification may not be obvious to the user. When reading the manual, the user can usually skip over references to front-panel controls and indicators other than the LINE switch and OVP ADJUST control.

## Troubleshooting

The major difference between troubleshooting an Option 001 unit and a standard power supply is that the front panel is not available to help you isolate the problem to a specific section in the power supply. If you know which section of the supply is defective, simply go to that section in the troubleshooting procedure and troubleshoot as described in Chapter 3.

To help you isolate the problem to a specific area of the supply, use the flowchart provided in this section.

If you cannot isolate the problem using the flowchart, you could replace the blank front panel of your supply with a standard front panel and then troubleshoot the unit. Part numbers for front panel assemblies are provided in Chapter 5.

## Chapter 2 Manual Changes:

On Page 20 Power Limit Calibration, change step f to read: Connect a DVM to control board test connector A2J7 pin 16 (CC). Observe the DVM while adjusting A2R25 (POWER LIMIT) clockwise. Stop adjusting as soon as test point A2J7-16 goes from high to low.

---

**Note:** You can also send an STS? query (or SCPI equivalent) in a looping program and monitor when the power supply status changes to CC mode.

---

Under the Performance Tests section, any references to front panel control will have to be accomplished using GPIB commands. Use the following guidelines:

1. To set the voltage and current to specific values, use the VSET and ISET (or SCPI equivalent) commands.
2. If the procedure says to check the CC or CV LED's, use an STS? query (or SCPI equivalent). A returned value of 1 indicates CV mode; a value of 2 indicates CC mode.

### **Chapter 3 Manual Changes:**

Replace Figure 3-1 with the figure on the next page. SA Tables 3-5 through 3-7 do not apply to Option 001 units.

### **Chapter 5 and 6 Manual Changes:**

On Page 94 under A3 Front Panel Board, the only part that applies to the Option 001 unit is R72, the OVP-adjust potentiometer. Change R72 from 2100-1775 to 2100-4060.

On Page 102 under Chassis Electrical, add Neon Pilot Light, P/N 1450-0647. Also add OVP Cable (R72), P/N 06032-60004. Under Chassis Mechanical, change screened front panel to:

06030-00010 (6030A)

06031-00011 (6031A)

06032-00021 (6032A)

On Figure 6-9, add the neon pilot light in series with R8, 33K, across pins 4 and 5 of transformer T3.

On Figure 6-12, the only part that applies to the Option 001 unit is R72, the OVP-adjust potentiometer.

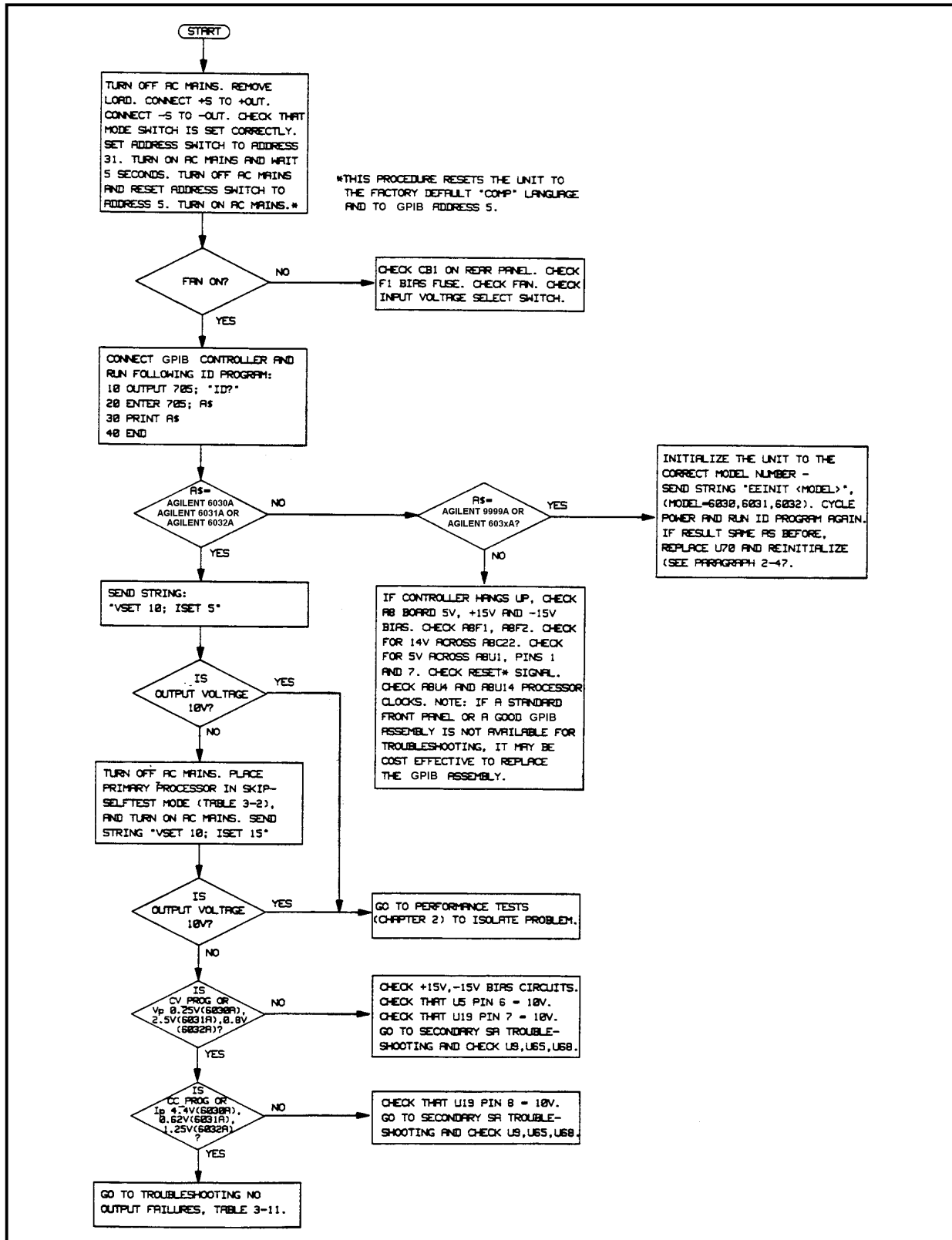

Figure 3-1. Troubleshooting Isolation (option 001)





# Agilent 6030A Test Record

## Performance Test Record - Agilent 6030A POWER SUPPLY (Page 1 of 2)

**Test Facility:**

\_\_\_\_\_ Report No. \_\_\_\_\_  
 \_\_\_\_\_ Date \_\_\_\_\_  
 \_\_\_\_\_ Customer \_\_\_\_\_  
 \_\_\_\_\_ Tested By \_\_\_\_\_

Model **Agilent 6030A** Ambient Temperature \_\_\_\_\_ °C  
 Serial No. \_\_\_\_\_ Relative Humidity \_\_\_\_\_ %  
 Options \_\_\_\_\_ Nominal Line Frequency \_\_\_\_\_ Hz (nominal)  
 Firmware Revision \_\_\_\_\_

Special Notes:

\_\_\_\_\_  
 \_\_\_\_\_  
 \_\_\_\_\_  
 \_\_\_\_\_  
 \_\_\_\_\_  
 \_\_\_\_\_  
 \_\_\_\_\_  
 \_\_\_\_\_  
 \_\_\_\_\_

Test Equipment Used			
Description	Model No.	Trace No.	Cal. Due Date
1. AC Source	_____	_____	_____
2. DC Voltmeter	Agilent 3458A	_____	_____
3. RMS Voltmeter	Agilent 3400A	_____	_____
4. Oscilloscope	Agilent 54504A	_____	_____
5. Electronic Load	Agilent 6050A and Agilent 60503A	_____	_____
6. Current Probe	_____	_____	_____
7. Current Shunt	Guildline 9230/100	_____	_____
_____	_____	_____	_____
_____	_____	_____	_____
_____	_____	_____	_____
_____	_____	_____	_____

**Performance Test Record - Agilent 6030A POWER SUPPLY (Page 2 of 2)**

<b>MODEL Agilent 6030A</b>	Report No. _____	Date _____
----------------------------	------------------	------------

Page No.	Test Description	Minimum Spec.	Results *	Maximum Spec.	Measurement Uncertainty
<b>Constant Voltage Tests</b>					
23	<b>Voltage Programming and Readback</b>				
	Low Voltage (0.500V)	0.354	_____ V	0.645	7μV
	Front Panel Display	V <sub>OUT</sub> - 0.065	_____ V	V <sub>OUT</sub> + 0.065	7μV
	GPIB Readback	V <sub>OUT</sub> - 0.080	_____ V	V <sub>OUT</sub> + 0.080	7μV
	High Voltage (200V)	199.785	_____ V	200.215	2.7mV
	Front Panel Display	V <sub>OUT</sub> - 0.72	_____ V	V <sub>OUT</sub> + 0.72	2.7mV
	GPIB Readback	V <sub>OUT</sub> - 0.24	_____ V	V <sub>OUT</sub> + 0.24	2.7mV
23	<b>Load Effect (60.0V)</b>	V <sub>OUT</sub> - 0.011	_____ mV	V <sub>OUT</sub> + 0.011	40μV
24	<b>Source Effect (200V)</b>	V <sub>OUT</sub> - 0.011	_____ mV	V <sub>OUT</sub> + 0.011	350μV
	<b>PARD (Ripple and Noise)</b>				
25	RMS	0	_____ mV	0.022	3.3mV
26	Peak-to-Peak	0	_____ mV	0.050	1.5mV
27	<b>Transient Recovery (90% to 100% Full Load)</b>	0	_____ mV	0.150/2ms	18mV
<b>Constant Current Tests</b>					
28	<b>Current Programming and Readback</b>				
	Low Current (0.50A)	0.475	_____ A	0.525	220μA
	Front Panel Display	I <sub>OUT</sub> - 0.017	_____ A	I <sub>OUT</sub> + 0.017	220μA
	GPIB Readback	I <sub>OUT</sub> - 0.017	_____ A	I <sub>OUT</sub> + 0.017	220μA
	High Current (17.0A)	16.941	_____ A	17.059	7mA
	Front Panel Display	I <sub>OUT</sub> - 0.081	_____ A	I <sub>OUT</sub> + 0.081	7mA
	GPIB Readback	I <sub>OUT</sub> - 0.076	_____ A	I <sub>OUT</sub> + 0.076	7mA
29	<b>Load Effect (5.0A)</b>	I <sub>OUT</sub> - 0.010	_____ mA	I <sub>OUT</sub> + 0.010	2μA
29	<b>Source Effect (17.0A)</b>	I <sub>OUT</sub> - 0.006	_____ mA	I <sub>OUT</sub> + 0.006	15μA
30	<b>PARD (Ripple and Noise)</b>	0	_____ mA	0.015	2mA

# Agilent 6031A Test Record

## Performance Test Record - Agilent 6031A POWER SUPPLY (Page 1 of 2)

<b>Test Facility:</b>	
_____	Report No. _____
_____	Date _____
_____	Customer _____
_____	Tested By _____
Model <b>Agilent 6031A</b>	Ambient Temperature _____ °C
Serial No. _____	Relative Humidity _____ %
Options _____	Nominal Line Frequency _____ Hz (nominal)
Firmware Revision _____	
<b>Special Notes:</b>	
_____	
_____	
_____	
_____	
_____	
_____	
_____	
_____	

Test Equipment Used			
Description	Model No.	Trace No.	Cal. Due Date
1. AC Source	_____	_____	_____
2. DC Voltmeter	Agilent 3458A	_____	_____
3. RMS Voltmeter	Agilent 3400A	_____	_____
4. Oscilloscope	Agilent 54504A	_____	_____
5. Electronic Load	Agilent 6050A and Agilent 60504A	_____	_____
6. Current Probe	_____	_____	_____
7. Current Shunt	Guildline 9230/300	_____	_____
_____	_____	_____	_____
_____	_____	_____	_____
_____	_____	_____	_____
_____	_____	_____	_____

**Performance Test Record - Agilent 6031A POWER SUPPLY (Page 2 of 2)**

<b>MODEL Agilent 6031A</b>	Report No. _____	Date _____
----------------------------	------------------	------------

Page No.	Test Description	Minimum Spec.	Results *	Maximum Spec.	Measurement Uncertainty
<b>Constant Voltage Tests</b>					
23	<b>Voltage Programming and Readback</b>				
	Low Voltage (0.10V)	0.085	_____ V	0.115	3μV
	Front Panel Display	V <sub>OUT</sub> - 0.007	_____ V	V <sub>OUT</sub> + 0.007	3μV
	GPIB Readback	V <sub>OUT</sub> - 0.007	_____ V	V <sub>OUT</sub> + 0.007	3μV
	High Voltage (20.0V)	19.978	_____ V	20.022	335μV
	Front Panel Display	V <sub>OUT</sub> - 0.028	_____ V	V <sub>OUT</sub> + 0.028	335μV
	GPIB Readback	V <sub>OUT</sub> - 0.023	_____ V	V <sub>OUT</sub> + 0.023	335μV
23	<b>Load Effect (7.0V)</b>	V <sub>OUT</sub> - 0.0037	_____ mV	V <sub>OUT</sub> + 0.0037	1μV
24	<b>Source Effect (20.0V)</b>	V <sub>OUT</sub> - 0.004	_____ mV	V <sub>OUT</sub> + 0.004	20μV
	<b>PARD (Ripple and Noise)</b>				
25	RMS	0	_____ mV	0.008	1.2mV
26	Peak-to-Peak	0	_____ mV	0.050	1.5mV
27	<b>Transient Recovery (90% to 100% Full Load)</b>	0	_____ mV	0.100/2ms	12mV
<b>Constant Current Tests</b>					
28	<b>Current Programming and Readback</b>				
	Low Current (0.50A)	0.248	_____ A	0.751	220μA
	Front Panel Display	I <sub>OUT</sub> - 0.303	_____ A	I <sub>OUT</sub> + 0.303	220μA
	GPIB Readback	I <sub>OUT</sub> - 0.102	_____ A	I <sub>OUT</sub> + 0.102	220μA
	High Current (120A)	119.450	_____ A	120.550	50mA
	Front Panel Display	I <sub>OUT</sub> - 1.140	_____ A	I <sub>OUT</sub> + 1.140	50mA
	GPIB Readback	I <sub>OUT</sub> - 0.580	_____ A	I <sub>OUT</sub> + 0.580	50mA
29	<b>Load Effect (50.0A)</b>	I <sub>OUT</sub> - 0.020	_____ mA	I <sub>OUT</sub> + 0.020	25μA
29	<b>Source Effect (120A)</b>	I <sub>OUT</sub> - 0.037	_____ mA	I <sub>OUT</sub> + 0.037	136mA
30	<b>PARD (Ripple and Noise)</b>	0	_____ mA	0.120	18mA

# Agilent 6032A Test Record

## Performance Test Record - Agilent 6032A POWER SUPPLY (Page 1 of 2)

<b>Test Facility:</b>		Report No. _____
_____		Date _____
_____		Customer _____
_____		Tested By _____
Model <b>Agilent 6032A</b>		Ambient Temperature _____ °C
Serial No. _____		Relative Humidity _____ %
Options _____		Nominal Line Frequency _____ Hz (nominal)
Firmware Revision _____		
<b>Special Notes:</b>		
_____		
_____		
_____		
_____		
_____		
_____		
_____		

Test Equipment Used			
Description	Model No.	Trace No.	Cal. Due Date
1. AC Source	_____	_____	_____
2. DC Voltmeter	Agilent 3458A	_____	_____
3. RMS Voltmeter	Agilent 3400A	_____	_____
4. Oscilloscope	Agilent 54504A	_____	_____
5. Electronic Load	Agilent 6050A and Agilent 60504A	_____	_____
6. Current Probe	_____	_____	_____
7. Current Shunt	Guildline 9230/100	_____	_____
_____	_____	_____	_____
_____	_____	_____	_____
_____	_____	_____	_____
_____	_____	_____	_____

**Performance Test Record - Agilent 6032A POWER SUPPLY (Page 2 of 2)**

<b>MODEL Agilent 6032A</b>	Report No. _____	Date _____
----------------------------	------------------	------------

Page No.	Test Description	Minimum Spec.	Results *	Maximum Spec.	Measurement Uncertainty
<b>Constant Voltage Tests</b>					
23	<b>Voltage Programming and Readback</b>				
	Low Voltage (0.090V)	0.050	_____ V	0.130	3μV
	Front Panel Display	V <sub>OUT</sub> - 0.020	_____ V	V <sub>OUT</sub> + 0.020	3μV
	GPIB Readback	V <sub>OUT</sub> - 0.020	_____ V	V <sub>OUT</sub> + 0.020	3μV
	High Voltage (60.0V)	59.939	_____ V	60.061	845μV
	Front Panel Display	V <sub>OUT</sub> - 0.118	_____ V	V <sub>OUT</sub> + 0.118	845μV
	GPIB Readback	V <sub>OUT</sub> - 0.068	_____ V	V <sub>OUT</sub> + 0.068	845μV
23	<b>Load Effect (20.0V)</b>	V <sub>OUT</sub> - 0.007	_____ mV	V <sub>OUT</sub> + 0.007	20μV
24	<b>Source Effect (60.0V)</b>	V <sub>OUT</sub> - 0.009	_____ mV	V <sub>OUT</sub> + 0.009	40μV
	<b>PARD (Ripple and Noise)</b>				
25	RMS	0	_____ mV	0.006	900μV
26	Peak-to-Peak	0	_____ mV	0.040	1.2mV
27	<b>Transient Recovery (90% to 100% Full Load)</b>	0	_____ mV	0.100/2ms	12mV
<b>Constant Current Tests</b>					
28	<b>Current Programming and Readback</b>				
	Low Current (0.50A)	0.414	_____ A	0.586	220μA
	Front Panel Display	I <sub>OUT</sub> - 0.041	_____ A	I <sub>OUT</sub> + 0.041	220μA
	GPIB Readback	I <sub>OUT</sub> - 0.036	_____ A	I <sub>OUT</sub> + 0.036	220μA
	High Current (50.0A)	49.815	_____ A	50.185	20mA
	Front Panel Display	I <sub>OUT</sub> - 0.270	_____ A	I <sub>OUT</sub> + 0.270	20mA
	GPIB Readback	I <sub>OUT</sub> - 0.215	_____ A	I <sub>OUT</sub> + 0.215	20mA
29	<b>Load Effect (16.5A)</b>	I <sub>OUT</sub> - 0.011	_____ mA	I <sub>OUT</sub> + 0.011	15μA
29	<b>Source Effect (50.0A)</b>	I <sub>OUT</sub> - 0.015	_____ mA	I <sub>OUT</sub> + 0.015	25μA
30	<b>PARD (Ripple and Noise)</b>	0	_____ mA	0.025	3.7A

# Agilent 6035A Test Record

## Performance Test Record - Agilent 6035A POWER SUPPLY (Page 1 of 2)

<b>Test Facility:</b>		Report No. _____
_____		Date _____
_____		Customer _____
_____		Tested By _____
Model <b>Agilent 6035A</b>		Ambient Temperature _____ °C
Serial No. _____		Relative Humidity _____ %
Options _____		Nominal Line Frequency _____ Hz (nominal)
Firmware Revision _____		
<b>Special Notes:</b>		
_____		
_____		
_____		
_____		
_____		
_____		
_____		

Test Equipment Used			
Description	Model No.	Trace No.	Cal. Due Date
1. AC Source	_____	_____	_____
2. DC Voltmeter	Agilent 3458A	_____	_____
3. RMS Voltmeter	Agilent 3400A	_____	_____
4. Oscilloscope	Agilent 54504A	_____	_____
5. Electronic Load	Agilent 6050A and Agilent 60503A	_____	_____
6. Current Probe	_____	_____	_____
7. Current Shunt	Guildline 9230/15	_____	_____
8. Power Resistor	250 ohms 1% 1KW (min.)	_____	_____
_____	_____	_____	_____
_____	_____	_____	_____
_____	_____	_____	_____

**Performance Test Record - Agilent 6035A POWER SUPPLY (Page 2 of 2)**

<b>MODEL Agilent 6035A</b>	Report No. _____	Date _____
----------------------------	------------------	------------

Page No.	Test Description	Minimum Spec.	Results *	Maximum Spec.	Measurement Uncertainty
<b>Constant Voltage Tests</b>					
23	<b>Voltage Programming and Readback</b>				
	Low Voltage (1.00V)	0.598	_____ V	1.400	12μV
	Front Panel Display	V <sub>OUT</sub> - 0.300	_____ V	V <sub>OUT</sub> + 0.300	12μV
	GPIB Readback	V <sub>OUT</sub> - 0.205	_____ V	V <sub>OUT</sub> + 0.205	12μV
	High Voltage (500V)	498.350	_____ V	501.650	6.5mV
	Front Panel Display	V <sub>OUT</sub> - 3.500	_____ V	V <sub>OUT</sub> + 3.500	6.5mV
	GPIB Readback	V <sub>OUT</sub> - 2.700	_____ V	V <sub>OUT</sub> + 2.700	6.5mV
23	<b>Load Effect (200V)</b>	V <sub>OUT</sub> - 0.060	_____ mV	V <sub>OUT</sub> + 0.060	350μV
24	<b>Source Effect (500V)</b>	V <sub>OUT</sub> - 0.063	_____ mV	V <sub>OUT</sub> + 0.063	800μV
	<b>PARD (Ripple and Noise)</b>				
25	RMS	0	_____ mV	0.050	7.5mV
26	Peak-to-Peak	0	_____ mV	0.160	4.8mV
27	<b>Transient Recovery (90% to 100% Full Load)</b>	0	_____ mV	0.200/5ms	24mV
<b>Constant Current Tests</b>					
28	<b>Current Programming and Readback</b>				
	Low Current (0.10A)	0.015	_____ A	0.185	56μA
	Front Panel Display	I <sub>OUT</sub> - 0.060	_____ A	I <sub>OUT</sub> + 0.060	56μA
	GPIB Readback	I <sub>OUT</sub> - 0.050	_____ A	I <sub>OUT</sub> + 0.050	56μA
	High Current (5.0A)	4.900	_____ A	5.100	2mA
	Front Panel Display	I <sub>OUT</sub> - 0.085	_____ A	I <sub>OUT</sub> + 0.085	2mA
	GPIB Readback	I <sub>OUT</sub> - 0.075	_____ A	I <sub>OUT</sub> + 0.075	2mA
29	<b>Load Effect (2.0A)</b>	I <sub>OUT</sub> - 0.034	_____ mA	I <sub>OUT</sub> + 0.034	2μA
29	<b>Source Effect (5.0A)</b>	I <sub>OUT</sub> - 0.018	_____ mA	I <sub>OUT</sub> + 0.018	2μA
30	<b>PARD (Ripple and Noise)</b>	0	_____ mA	0.050	5mA



## Manual Backdating

This section describes changes that must be made to the manual so that it applies to instruments with serial numbers lower than those listed on the title page. Look in the following table for the serial number of your instrument, and make only those changes listed for your instrument. Note that for some changes you may be instructed to update the instrument if certain components are being replaced during repair.

Prefix	Serial Number	Make Changes	Prefix	Serial Number	Make Changes
<u>6030A</u>			<u>6032A</u>		
2934A	01825-01829	1-7, 9, 10, 12, 14-18	3004A	05881-05885	1, 3-7, 9-12, 14, 17, 18
3023A	01925-02408	1-7, 9, 10, 12, 14-18	3023A	06181-07180	1, 3-7, 9-12, 14, 17, 18
3123A	02409-02538	1-7, 9, 10, 12, 14-18	3123A	07181-07480	1, 3-7, 9-12, 14, 17, 18
3137A	02539-02568	1-7, 9, 10, 12, 14-17	3138A	07481-07880	1, 3-7, 9-12, 14, 17
3141A	02569-02748	1-7, 9, 10, 12, 14-16	3211A	07881-08020	1, 3-7, 9-12, 14, 17
3211A	02749-02778	1-7, 9, 10, 12, 14-16	3221A	08021-08200	1, 3-7, 9-12, 14
3215A	02779-02808	1-7, 9, 10, 12, 14, 15	3232A	08201-08480	1, 3-7, 9-12, 14
3220A	02809-03068	1-7, 9, 10, 12, 14	3250A	08481-08560	1, 3-7, 9-12
3251A	03069-03108	1-7, 9, 10, 12	3304A	08561-08780	1, 3-7, 9-11
3305A	03109-03308	1-7, 9, 10	3319A	08781-08820	1, 3-7, 9, 10
3332A	03309-03568	1-7, 9	3304A	08821-08860	1, 3-7, 9, 10
3415A	03569-03648	1-7	3319A	08861-08980	1, 3-7, 9, 10
3430A	03649-03708	1-6	3323A	08981-09580	1, 3-7, 9
3441A	03709-03818	1-5	3415A	09581-09900	1, 3-7
3506A	03819-04088	1-4	3431A	09901-10140	1, 3-6
3544A	04089-04478	1-3	3440A	10141-10580	1, 3-5
3702A	04479-04848	1, 2	3510A	10581-11160	1, 3-4
US3702	0101-0260	1, 2	3542A	11161-13020	1, 3
US3832	0261-0300	1	US3542	0101-0880	1, 3
			US3832	0881-1025	1
<u>6031A</u>			<u>6035A</u>		
2934A	01821-01825	1, 3-7, 9-12, 14, 16,17,18	3038A	00101-00177	1-10, 12-18
3026A	01921-02280	1, 3-7, 9-12, 14, 16,17,18	3124A	00178-00217	1-10, 12-18
3121A	02281-02410	1, 3-7, 9-12, 14, 16,17,18	3140A	00218-00297	1-10, 12-16
3137A	02411-02430	1, 3-7, 9-12, 14, 16, 17	3211A	00298-00317	1-10, 12-15
3140A	02431-02520	1, 3-7, 9-12, 14, 16	3224A	00318-00347	1-10, 12-14
3213A	02521-02560	1, 3-7, 9-12, 14, 16	3239A	00348-00387	1-10, 12, 13
3221A	02561-02650	1, 3-7, 9-12, 14	3251A	00388-00417	1-10, 12
3302A	02651-02690	1, 3-7, 9-12	3308A	00418-00477	1-10
3304A	02691-02700	1, 3-7, 9-11	3330A	00478-00517	1-9
3313A	02701-02760	1, 3-7, 9-10	3330A	00518-00537	1-9
3325A	02761-02920	1, 3-7, 9	3351A	00538-00597	1-8
3416A	02921-02990	1, 3-7	3418A	00598-00637	1-7
3429A	02991-03020	1, 3-6	3432A	00638-00682	1-5
3440A	03021-03110	1, 3-5	3512A	00683-00862	1-4
3506A	03111-03280	1, 3, 4	3542A	00863-01112	1-3
3543A	03281-03890	1, 3	3702A	01113-01342	1,2
US3543	0101-0340	1, 3	US3702	0101-0250	1,2
US3831	0341-0375	1	US3832	0251-0280	1

CHANGE 1:

Under A1 Main Board, change R45 to 82.5k p/n 0757-0563.

CHANGE 2:

Under A8 GPIB Board.

Add: R100 p/n 0698-4037.

U17 p/n 1820-2549

Delete: C67-70 0.01uF 10%, p/n 0160-4832, qty 4.

C71,73 2200pF 10%, p/n 0160-4830, qty 2.

L1 choke, p/n 9170-1680.

L2-4 core-shield bead, p/n 9170-1454, qty 3.

: Q1 transistor 2N4917, p/n 1853-0089.

R1 47.5K 1%, p/n 0757-0457.

R2,12 4.64K 1%, p/n 0698-3155, qty 2.

R79,80 0 ohm, p/n 8159-0005, qty 2.

U117 IC-9914 talker/listener, p/n 1821-1740.

Change: A8, GPIB board to p/n 5060-3551.

C14 to 0.047uF, p/n 0160-5422.

C23 to 39uF, p/n 0180-0393.

C61 to p/n 0160-4281.

U6 to p/n 5080-2160.

U36 to p/n 5080-2158.

CHANGE 3:

Under A5 Diode Board, change CR4 and CR5 for model 6030A to p/n 1901-1182. Change CR4 and CR5 for model 6035A to p/n 1901-1316. Change Q1 for model 6030A to p/n 1855-0486 and for model 6035A to p/n 1855-0802. Under A5 Mechanical, change heatsink (CR5) for models 6030A,35A to p/n 06030-00003. Change heatsink (CR4, Q1) for models 6030A,35A to p/n 06030-00004.

CHANGE 4:

Under A4 FET Board, change CR1 and CR4 to p/n 1901-1137. Both diodes must be the same part number.

CHANGE 5:

Under A8 GPIB Board, change U33 to p/n 1820-0430.

CHANGE 6:

Under A8 GPIB Board, change U14 to p/n 1820-6721.

CHANGE 7:

Under A8 GPIB Board:

Add: U15, p/n 1LH4-0001.

Delete: U115, SN75ALS61610, p/n 1820-6045.

U116, SN75ALS6160, p/n 1820-6170.

C142 100pF, p/n 0160-4801.

C143-144 .047uF, p/n 0160-5422.

Change: A8, GPIB board to p/n 5060-3305.

CHANGE 8:

Under A1 Main Board, change K1, K2 to p/n 0490-1746. Change R47 and R48 150 ohms p/n 0761-0035.

CHANGE 9:

Under A2 Control Board,

\*\*\*\*\* For Model 6035A only \*\*\*\*\*

Change R40 to 95k p/n 0699-1211 and 1.21M p/n 0699-1271. Change R41 to 200k p/n 0698-6376.

CHANGE 10:

Under A3 Front Panel, change G1 to p/n 06032-60005.

On page 5-18 under Chassis Mechanical, change Knob to p/n 0370-1303. Delete Spacer, p/n 2190-0736.

CHANGE 11:

Under A1 Main Board,

Add: C3, C7, 1400uF p/n 0180-3460

R6, 1.3k, p/n 0811-1803

U2, U4, rectifier, p/n 1906-0006

Delete: C27, 34, cap 0.01uF 400V, p/n 0160-6805

CR6-13, power rectifier 400V, p/n 1901-0731

R24, res 200 5% 1/2W, p/n 0686-2015

R43, 44, res 2.61k 1% 1/8W, p/n 0698-0085

R45, res 82.5k 1% 1/8W, p/n 0757-0463

R46, res 681 1% 1/8W, p/n 0757-0419

R47, 48, res 150 5% 1W p/n 0761-0035

R49, res 100 1% 1/8W, p/n 0757-0401

Q2, FET N-channel, p/n 1855-0665

VR1, diode zener 7.5V 5%, p/n 1902-0955

U6, opto-isolator, p/n 1990-1074

Change: A1 (6030A) to p/n 06030-60021

A1 (6031A) to p/n 06011-60021

A1 (6032A) to p/n 06032-60021

A1 (6035A) to p/n 06030-60027

C1,2,4-6,8 to 1400uF p/n 0180-3460

C10 to 22uF p/n 0180-3696

CR1 to 1901-0028

DS1 to display, p/n 1990-0325

K1 to relay p/n 0490-1457

K2 to relay p/n 0490-1341.

R5 to 300, p/n 0686-3015

R7 to 10, p/n 0686-1005

R8 to 33k, p/n 0686-3335

R41 to 30, p/n 0811-1869

Under A6 AC Input Filter, change the part number of the board to 06011-60025 for models 6030A,31A,32A, and 06011-60028 for model 6035A.

Under Chassis Electrical at the end of the parts list, change L4 to p/n 06011-80093.

CHANGE 12:

Under A1 Main Board,

\*\*\*\*\* For Model 6031A only \*\*\*\*\*

Change C23 and C28 to .047uF Agilent p/n 0160-5895.

Add C21 and C24, .047uF Agilent p/n 0160-5895.

Add R21 and R22, 1 ohm p/n 0699-0208.

\*\*\*\*\* For Model 6032A only \*\*\*\*\*

Change C20 and C22 to .047uF Agilent p/n 0160-5895.

Add C21 and C23, .047uF Agilent p/n 0160-5895.

Add R20 and R23, 1 ohm p/n 0699-0208.

CHANGE 13:

Under A8 GPIB Board, change U8 to p/n 1818-4111.

CHANGE 14:

Under A1 Main Board, change C11,12 to 0.047uF, p/n 0160-5895. On page 5-3, change R12 and R13 to 2.2 ohms, p/n 0699-0188.

CHANGE 15:

Under A8 GPIB Board, delete D22.

CHANGE 16:

Under A5 Diode Board, delete L3.

CHANGE 17:

Under A1 Main Board, change U1 to p/n 1906-0218.

CHANGE 18:

Under A6 AC Input Filter, change L1 to p/n 06011-80094.

## **Manual Updates**

The following updates have been made to this manual since the print revision indicated on the title page.

4/07/04

Pages 38, 104, 105, 106 and 107 have been corrected.