

Errata

Title & Document Type: 54510A Digitizing Oscilloscope Front-Panel Reference Manual

Manual Part Number: 54510-90901

Revision Date: December 1, 1990

HP References in this Manual

This manual may contain references to HP or Hewlett-Packard. Please note that Hewlett-Packard's former test and measurement, semiconductor products and chemical analysis businesses are now part of Agilent Technologies. We have made no changes to this manual copy. The HP XXXX referred to in this document is now the Agilent XXXX. For example, model number HP8648A is now model number Agilent 8648A.

About this Manual

We've added this manual to the Agilent website in an effort to help you support your product. This manual provides the best information we could find. It may be incomplete or contain dated information, and the scan quality may not be ideal. If we find a better copy in the future, we will add it to the Agilent website.

Support for Your Product

Agilent no longer sells or supports this product. You will find any other available product information on the Agilent Test & Measurement website:

www.tm.agilent.com

Search for the model number of this product, and the resulting product page will guide you to any available information. Our service centers may be able to perform calibration if no repair parts are needed, but no other support from Agilent is available.



Front-Panel Reference

HP 54510A 1 GSa/s Digitizing Oscilloscope



©Copyright Hewlett-Packard Company 1990

HP Part Number 54510-90901

Printed in the U.S.A. December 1990

Herstellerbescheinigung

Hiermit wird bescheinigt, daß das Gerät/System

HP 54510A

in Übereinstimmung mit den Bestimmungen von Postverfügung 1046/84 funkentstört ist.

Der Deutschen Bundespost wurde das Inverkehrbringen dieses Gerätes/Systems angezeigt und die Berechtigung zur Überprüfung der Serie auf Einhaltung der Bestimmungen eingeräumt.

Zusatzinformation für Meß- und Testgeräte

Werden Meß- und Testgeräte mit ungeschirmten Kabeln und/oder in offenen Meßaufbauten verwendet, so ist vom Betreiber sicherzustellen, daß die Funk-Entstörbestimmungen unter Betriebsbedingungen an seiner Grundstücksgrenze eingehalten werden.

Manufacturer's declaration

This is to certify that this product meets the radio frequency interference requirements of directive 1046/84. The German Bundespost has been notified that this equipment was put into circulation and was granted the right to check the product type for compliance with these requirements.

Additional Information for Test- and Measurement Equipment

Note: If test and measurement equipment is operated with unshielded cables and/or used for measurements on open set-ups, the user must insure that under these operating conditions, the radio frequency interference limits are met at the border of his premises.

Product Warranty

This Hewlett-Packard product has a warranty against defects in material and workmanship for a period of three years from date of shipment. During warranty period, Hewlett-Packard Company will, at its option, either repair or replace products that prove to be defective.

For warranty service or repair, this product must be returned to a service facility designated by Hewlett-Packard. However, warranty service for products installed by Hewlett-Packard and certain other products designated by Hewlett-Packard will be performed at the Buyer's facility at no charge within the Hewlett-Packard service travel area. Outside Hewlett-Packard service travel areas, warranty service will be performed at the Buyer's facility only upon Hewlett-Packard's prior agreement and the Buyer shall pay Hewlett-Packard's round trip travel expenses.

For products returned to Hewlett-Packard for warranty service, the Buyer shall prepay shipping charges to Hewlett-Packard and Hewlett-Packard shall pay shipping charges to return the product to the Buyer. However, the Buyer shall pay all shipping charges, duties, and taxes for products returned to Hewlett-Packard from another country.

Hewlett-Packard warrants that its software and firmware designated by Hewlett-Packard for use with an instrument will execute its programming instructions when properly installed on that instrument. Hewlett-Packard does not warrant that the operation of the instrument software, or firmware will be uninterrupted or error free.

Limitation of Warranty

The foregoing warranty shall not apply to defects resulting from improper or inadequate maintenance by the Buyer, Buyer-supplied software or interfacing, unauthorized modification or misuse, operation outside of the environmental specifications for the product, or improper site preparation or maintenance.

**NO OTHER WARRANTY IS EXPRESSED OR IMPLIED.
HEWLETT-PACKARD SPECIFICALLY DISCLAIMS THE
IMPLIED WARRANTIES OR MERCHANTABILITY AND FITNESS
FOR A PARTICULAR PURPOSE.**

Exclusive Remedies THE REMEDIES PROVIDED HEREIN ARE THE BUYER'S SOLE AND EXCLUSIVE REMEDIES. HEWLETT-PACKARD SHALL NOT BE LIABLE FOR ANY DIRECT, INDIRECT, SPECIAL INCIDENTAL, OR CONSEQUENTIAL DAMAGES, WHETHER BASED ON CONTRACT, TORT, OR ANY OTHER LEGAL THEORY.

Assistance Product maintenance agreements and other customer assistance agreements are available for Hewlett-Packard products.

For any assistance, contact your nearest Hewlett-Packard Sales and Service Office.

Certification Hewlett-Packard Company certifies that this product met its published specifications at the time of shipment from the factory. Hewlett-Packard further certifies that its calibration measurements are traceable to the United States National Bureau of Standards, to the extent allowed by the Bureau's calibration facility, and to the calibration facilities of other International Standards Organization members.

Safety This product has been designed and tested according to International Safety Requirements. To ensure safe operation and to keep the product safe, the information, cautions, and warnings in this manual must be heeded.

Contents

Chapter 1	Introducing the HP 54510A	
	Introduction	1-1

Chapter 2	Instrument Setup	
	Introduction	2-1
	Initial Inspection	2-1
	Contents of Shipment	2-1
	Available Accessories	2-2
	Operating Environment	2-2
	Storage and Shipping	2-2
	Rear Panel	2-3
	Power Requirements	2-3
	Selecting Line Voltage	2-4
	Verifying the Fuse	2-5
	Power Cord	2-5
	Line Switch	2-5
	Intensity Control	2-7
	Air Flow Requirements	2-7
	Connecting External Equipment	2-8

Chapter 3	Front-Panel Overview	
	Introduction to the Front Panel	3-1
	System Control	3-2
	RUN/STOP Key	3-2
	SINGLE Key	3-3
	CLEAR DISPLAY Key	3-3
	LOCAL Key	3-3
	HARDCOPY Key	3-3
	Setup	3-4
	AUTOSCALE Key	3-5
	RECALL Key	3-5
	SAVE Key	3-6
	SHOW Key	3-6
	Menus	3-7

Entry	3-8
Numeric Keypad	3-8
Knob	3-9
FINE Key	3-9
Input	3-9
Display	3-10
Instrument Reset	3-11

Chapter 4

Timebase Menu

Introduction to the Timebase	4-1
Time/Div Key	4-1
delay Key	4-3
reference Key	4-3
repetitive/ realtime Key	4-4
repetitive mode	4-4
realtime mode	4-4
Memory Bar Exercise	4-5
Single Shot Exercise	4-8
Single Shot in Repetitive Mode	4-8
Single Shot in Real Time Mode	4-11
Pan and Zoom	4-12
Pan and Zoom Exercise	4-12
Zooming	4-13
Panning	4-15

Chapter 5

Channel Menu

Introduction to Channels	5-1
CHANNEL Key	5-2
Vertical Sensitivity Key	5-2
offset Key	5-2
Coupling Key	5-3
Input Impedance	5-3
more Key	5-4
probe key	5-4
ECL Key	5-5
TTL Key	5-5

Chapter 6

Trigger Menu

Introduction to the Triggers	6-1
Trigger Mode Interaction	6-1
Edge Trigger Mode	6-2
trig'd/auto Key	6-3
source Key	6-3
level Key	6-3
slope Key	6-3
noise reject Key	6-3
holdoff Key	6-3
Holdoff Exercise	6-4
Instrument Setup	6-4
Oscilloscope Setup	6-5
Pattern Trigger Mode	6-8
pattern Key	6-9
when Key	6-9
holdoff Key	6-10
Pattern Trigger Exercise	6-10
Instrument Setup	6-11
Oscilloscope Setup	6-11
State Trigger Mode	6-15
clock Key	6-15
when Key	6-15
present Key	6-16
holdoff Key	6-16
State Trigger Exercise	6-16
Instrument Setup	6-16
Oscilloscope Setup	6-17
Delay Trigger Mode	6-20
qualify on Key	6-20
qualify on edge	6-20
qualify on pattern	6-21
qualify on state	6-21
delay Key	6-22
trigger on Key	6-23
Delay Trigger Exercise	6-23
Instrument Setup	6-23
Oscilloscope Setup	6-24

TV Trigger	
Mode	6-27
Standard Select Key	6-27
Source Select Key	6-27
level/polarity Key	6-28
field Key	6-28
line Key	6-28
holdoff Key	6-28
TV Trigger Exercise	6-29
Instrument Setup	6-29
Oscilloscope Setup	6-29

Chapter 7

Display Menu

Introduction to the Display	7-1
Display Mode Key	7-3
norm	7-3
avg	7-4
env	7-5
# of screens Key	7-5
off/frame/ axes/grid Key	7-6
connect dots Key	7-7

Chapter 8

Delta t/Delta V Menu

Introduction to the Markers	8-1
ΔV markers Key	8-2
Vmarker 2 Key	8-2
Vmarker 1 Key	8-2
Δt markers Key	8-3
start marker Key	8-3
stop marker Key	8-3

Chapter 9

Waveform Math Menu

Introduction to the Functions	9-1
Defining a Function	9-2
Function Key	9-2
display Key	9-2
chan/mem Key	9-3
Operator Key	9-3

chan/mem Key	9-4
sensitivity Key	9-4
offset Key	9-4
Vertical Scaling Units	9-4
Displaying Functions	9-5
Waveform Math Exercise	9-7
Instrument Setup	9-7
Oscilloscope Setup	9-7

Chapter 10

Waveform Save Menu

Introduction to the Memories	10-1
waveform/pixel Key	10-1
waveform Menu	10-2
nonvolatile Key	10-2
display Key	10-2
source Key	10-2
store Key	10-2
pixel Menu	10-3
volatile Key	10-3
display Key	10-4
clear memory Key	10-4
add to memory Key	10-4
Waveform Save Exercise	10-4
Instrument Setup	10-4
Oscilloscope Setup	10-4

Chapter 11

Define Measure Menu

Introduction to Measurements	11-1
Measurement Selection	11-2
meas/meas def/meas limit Key	11-3
meas Submenu	11-3
continuous Key	11-3
statistics Key	11-3
Measure Define Sub-menu	11-4
standard/user defined Key	11-4
thresholds/ measurements Key	11-4
Measure Limit Submenu	11-7
test Key	11-7

set Key	11-8
fail if > Key	11-8
or if < Key	11-8
save to Key	11-8
after fail Key	11-8

Chapter 12

Utility Menu

Introduction to the Utilities	12-1
HP-IB menu	12-2
talk only mode	12-2
addressed mode	12-2
form feed Key	12-3
paper length Key	12-3
device mode Key	12-3
exit menu Key	12-3
SELFTEST MENU	12-4
ram Test	12-6
rom Test	12-6
acquisition Test	12-6
Miscellaneous Test	12-6
loop Test	12-6
start test Key	12-6
test all Key	12-6
exit menu Key	12-6
PROBE CAL MENU	12-7
attenuation submenu	12-8
channel Key	12-8
start cal Key	12-8
continue Key	12-8
abort Key	12-8
exit menu Key	12-8
time null submenu	12-9
time Key	12-9
exit menu Key	12-9
Self Cal menu	12-10
cal select Key	12-10
channel Key	12-11
start cal Key	12-11
print cals Key	12-11
continue Key	12-11

abort Key	12-11
exit menu Key	12-11
service menu	12-11
clicker Key	12-12
ac BNC Key	12-12
Calibration Procedure	12-12

Appendix A

Algorithms

Measurement Setup	A-1
Making Measurements	A-1
Standard Measurements	A-2
User defined Measurements	A-2
Automatic Top-Base	A-2
Edge Definition	A-3
Algorithm Definitions	A-3
delay	A-3
+ width	A-4
- width	A-5
Period	A-5
Frequency	A-5
Duty Cycle	A-5
Risetime	A-5
Falltime	A-5
Vmax	A-5
Vmin	A-5
Vp-p	A-5
Vtop	A-6
Vbase	A-6
Vamp	A-6
Vavg	A-6
Vrms	A-6
Integrate	A-6
Differentiate	A-6

Appendix B

General Information

Instrument Description	B-1
Accessories Supplied	B-1
Accessories Available	B-1
Options Available	B-1

Performance Specifications	B-2
Vertical	B-2
Horizontal	B-2
Trigger	B-2
Performance Characteristics	B-3
Vertical	B-3
Horizontal	B-5
Trigger	B-5
Operating Characteristics	B-5
Vertical	B-5
Horizontal	B-7
Trigger Modes	B-7
Delayed Trigger	B-8
TV Trigger	B-9
Display	B-9
Display Modes	B-10
Delta-t / Delta-V	B-11
Waveform Math	B-11
Waveform Save	B-11
User-definable Measurement Thresholds	B-12
Setup Aids	B-12
Hardcopy	B-13
Full HP-IB Programmability	B-13
Product Support	B-15
General Characteristics	B-16
Environmental Conditions	B-16
Power Requirements	B-16
Weight	B-16
Dimensions	B-18

Introduction

The HP 54510A Digitizing Oscilloscope is a general-purpose repetitive and real-time oscilloscope, fully programmable and transportable. The HP 54510A has two input channels and an external trigger input. Full HP-IB programmability is incorporated for use in a broad range of HP-IB applications, from high-speed ATE to device characterization in research and development environments. The HP 54510A also features powerful triggering, easy waveform storage, automatic measurements, and instant hardcopy output.

The HP 54510A features an easy-to-use human interface, yet has many sophisticated capabilities and multiple triggering functions. Waveforms are easily stored for future reference, waveform measurements are automatic, and instant hardcopy is available when the HP 54510A is used with an HP-IB compatible printer or plotter.

Some of the key features of the HP 54510A are listed here. See Appendix B for a complete listing of specifications and characteristics.

- Bandwidth – dc to 250 MHz (real time and repetitive)
- Maximum Sample Rate – 1 GSa/s
- Memory Depth per Channel – 8 k

- 8 bits Vertical Resolution
- Two-channel Input and Display
- External Trigger Input

- Advanced Logic Triggering
- TV Trigger (including user-defined)
- Pre and Post-Trigger Viewing

- Autoscale for Automatic Setup
- Automatic Measurements (User-defined and Statistical)
- Hardcopy Output

- **Measurement Limit Test**
- **Waveform Math (+, -, vs, invert, only)**
- **Waveform Calculus (integrate and differentiate)**

- **Postacquisition Pan and Zoom**
- **Four Nonvolatile Setup Memories**
- **Four Nonvolatile Waveform Memories**

- **Two Volatile Pixel Memories**
- **Full HP-IB Programmability**
- **Segmentable Memory over HP-IB**
- **HP-IB Multiple Single-shot Capability**
(300 k RAM, up to 500 Waveforms per Second)

Introduction

This chapter contains information for unpacking, applying power, and connecting optional accessories to the HP 54510A. Inspection, power requirements, and instructions for running the HP 54510A self-test for performance verification are also included in this chapter.

For safe and trouble-free operation, follow the instructions and advisories in this chapter. Read the Safety Summary included in this manual.

Initial Inspection

Inspect the shipping container for damage. If the shipping container or cushioning material is damaged, keep it until the contents of the shipment have been checked. Check the shipment for completeness and check the instrument electrically and mechanically.

If the contents are incomplete, there is mechanical damage or defect, or if the instrument does not pass the selftest performance verification, notify the nearest Hewlett-Packard Office. Keep the shipping materials for carrier's inspection. The Hewlett-Packard Office will arrange for repair or replacement at HP's option without waiting for claim settlement.

Contents of Shipment

The following items are shipped with the HP 54510A Digitizing Oscilloscope:

- Two HP 10441A Probes
- Probe to BNC Adapter, 1250-1454
- *HP 54500 Digitizing Oscilloscopes Getting Started Guide*
- *HP 54510A Front-Panel Reference*
- *HP 54510A Programming Reference*
- *HP 54510A Service Manual*
- *Feeling Comfortable with Digitizing Oscilloscopes*

Available Accessories The following optional accessories are available for use with the HP 54510A:

- Carrying Case, HP Part Number 1540-1066
- Rack Mount Kit, HP Part Number 5061-6175
- HP 1180A Testmobile
- HP 1133A TV/Video Sync Pod
- HP 1141A Differential Probe
- HP 1137A High-Voltage Probe
- HP 10024A Integrated Circuit 16-pin Test Clip
- HP 10211A Integrated Circuit 24-pin Test Clip
- PC Board Horizontal Mini-Probe Socket, HP Part Number 1250-1737
- PC Board Vertical Mini-Probe Socket, HP Part Number 1250-1918

Operating Environment

The HP 54510A oscilloscope is operated in a normal lab or bench environment without any additional considerations. Note the non-condensing humidity limitation in the list of characteristics supplied in this manual. Condensation in the instrument cabinet can cause poor operation or malfunction. Protection should be provided against temperature extremes which cause condensation.

Storage and Shipping The HP 54510A may be stored or shipped in environments with the following limitations:

- Temperature: -40° C to +75° C (-40° F to +158° F)
- Humidity: Up to 90% at 65° C (149° F)
- Altitude: Up to 15,300 meters (50,000 feet)

If the HP 54510A is to be shipped to a Hewlett-Packard Service Center for service or repair, attach a tag to the instrument identifying owner, address of owner, complete instrument model number and serial number and a description of required service.

If the original packaging material is no longer available, identical packing material is available through local Hewlett-Packard offices. Mark the container FRAGILE to ensure careful handling. In any correspondence, refer to the instrument by the model and serial number.

Rear Panel

The rear panel of the HP 54510A contains the power input, voltage selector module, power switch, external connectors, and calibrator protection switches as shown in figure 2-1.

Power Requirements The HP 54510A requires a power source of either 115 or 230 Volts ac, - 25% to + 15%; single phase, 48 to 66 Hz; 200 Watts maximum power.

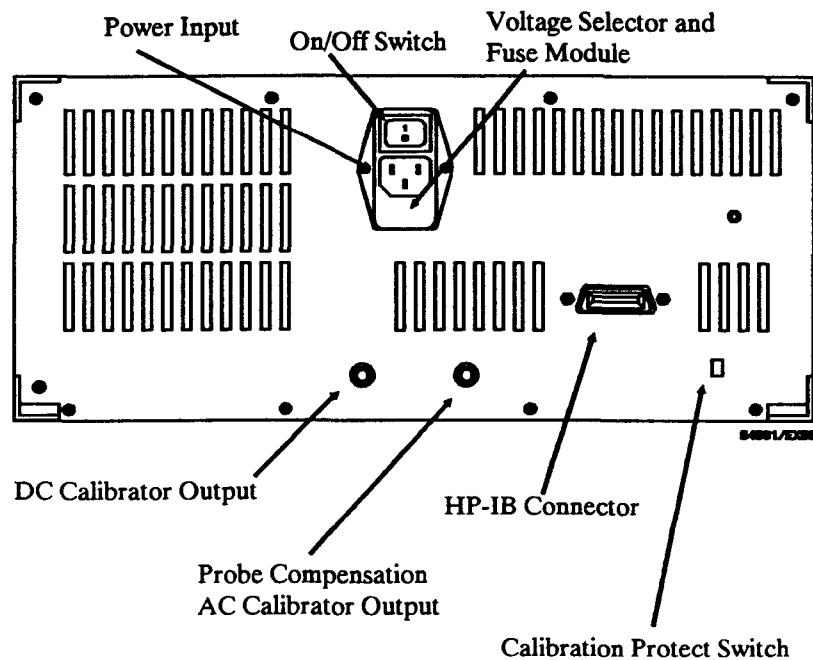

Figure 2-1. HP 54510A Rear Panel

Selecting Line Voltage The fuse module is set at Hewlett-Packard to the line voltage used in the country of destination. Check the setting of the fuse module to verify it is in the correct position for the voltage to be used. If the setting needs to be changed, use the following procedure.

CAUTION

BEFORE APPLYING POWER TO THE INSTRUMENT, BE SURE THE FUSE MODULE IS SET TO THE CORRECT LINE VOLTAGE POSITION. Severe damage will occur if the line voltage is not properly set.

Change the fuse module position by pulling the fuse module out and reinserting it with the appropriate arrows aligned.

- Carefully pry at the top center of the module as shown in figure 2-2, until it can be grasped and pulled out.

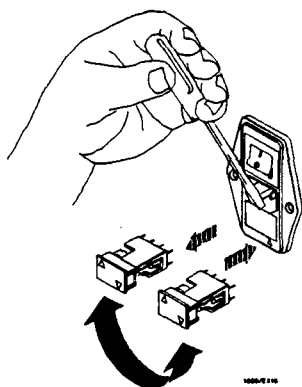

Figure 2-2. Selecting Line Voltage

Verifying the Fuse If it is necessary to check or change fuses, remove the fuse module and look at each fuse for its amperage and voltage ratings.

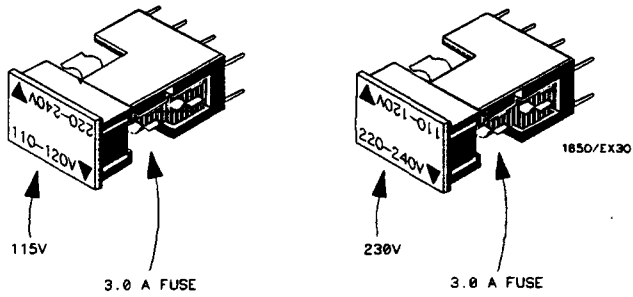

Figure 2-3. Checking for the Correct Fuse

Power Cord The HP 54510A is a Safety Class 1 instrument with an exposed chassis that is directly connected to earth via the power supply cord to meet IEC Standard 348. This instrument is provided with a three-wire power cable. When connected to an appropriate ac power outlet, this cable grounds the instrument cabinet. The type of power cable plug shipped depends on the country of destination. See the next page for available power cords.

Line Switch The line switch is located on the rear panel. Turn on the oscilloscope by pressing 1 on the rocker switch. The rocker switch is labeled 1 and 0, corresponding to on and off, respectively.

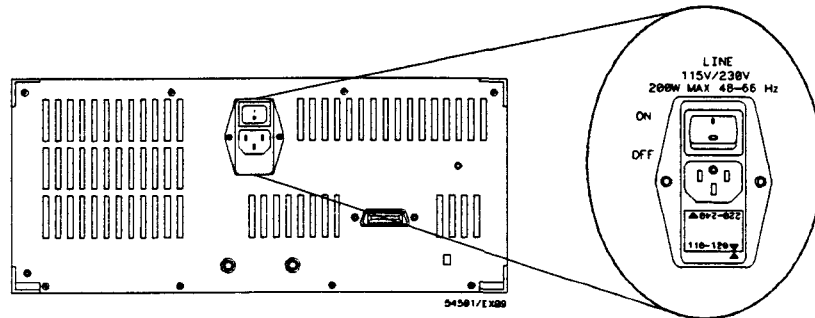











Figure 2-4. Line Switch

PLUG TYPE	CABLE PART NO.	PLUG DESCRIPTION	LENGTH IN/CM	COLOR	COUNTRY
OPT 900  250V	812D-1551 812D-1703	Straight *BS1363A 90°	90/228 90/228	Gray Mint Gray	United Kingdom, Cyprus, Nigeria, Zimbabwe, Singapore
OPT 901  250V	812D-1369 812D-0696	Straight *NZSS198/ABC 90°	79/200 87/221	Gray Mint Gray	Australia New Zealand
OPT 902  250V	812D-1688 812D-1692 812D-2857	Straight *CEE7-Y11 90° Straight (Shielded)	79/200 79/200 79/200	Mint Gray Mint Gray Coco Brown	East and West Europe, Saudi Arabia, So. Africa, India (Unpolarized in many nations)
OPT 903**  125V	812D-1378 812D-1521 812D-1992	Straight *NEMA5-15P 90° Straight (Medical) UL544	90/228 90/228 96/244	Jade Gray Jade Gray Black	United States, Canada, Mexico, Philippines, Taiwan
OPT 904**  250V	812D-0698	Straight *NEMA5-15P	90/228	Black	United States, Canada
OPT 905  250V	812D-1396 812D-1625	CEE22-V1 (System Cabinet Use) 250V	30/76 96/244	Jade Gray	For interconnecting system components and peripherals. United States and Canada only
OPT 906  250V	812D-2104 812D-2296	Straight *SEV1011 1959-24507 Type 12 90°	79/200 79/200	Mint Gray Mint Gray	Switzerland
OPT 912  220V	812D-2956 812D-2957	Straight *DNCK107 90°	79/200 79/200	Mint Gray Mint Gray	Denmark
OPT 917  250V	812D-4211 812D-4600	Straight SABS164 90°	79/200 79/200	Jade Gray	Republic of South Africa India
OPT 918  100V	812D-4753 812D-4754	Straight Miti 90°	90/230 90/230	Dark Gray	Japan

Rev. 11/20/98

AR100018

*Part number shown for plug is industry identifier for plug only. Number shown for cable is HP part number for complete cable including plug.

**These cords are included in the CSA certification approval of the equipment.

E=Earth Ground
L=Line
N=Neutral

Figure 2-5. Available Power Cords

Intensity Control Once the oscilloscope has been turned on, the display intensity can be adjusted, if necessary. The intensity is adjusted with the Display Intensity control on the rear panel.

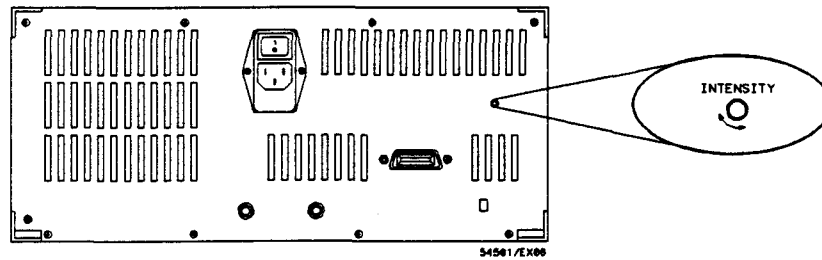

Figure 2-6. Intensity Control

Air Flow Requirements The HP 54510A must have unrestricted air flow for the fan and ventilation openings in the rear panel. The HP 54510A may be stacked under, over, or between other instruments provided the other instruments are adequately cooled.

Connecting External Equipment

The HP 54510A is equipped with an HP-IB connector on the rear panel. This allows a direct connection to an HP-IB compatible printer, plotter, or external controller.

Connect an HP-IB cable to the oscilloscope and any HP-IB compatible device. Tighten the HP-IB cable with the captive screws of the cable to avoid disconnecting the cable.

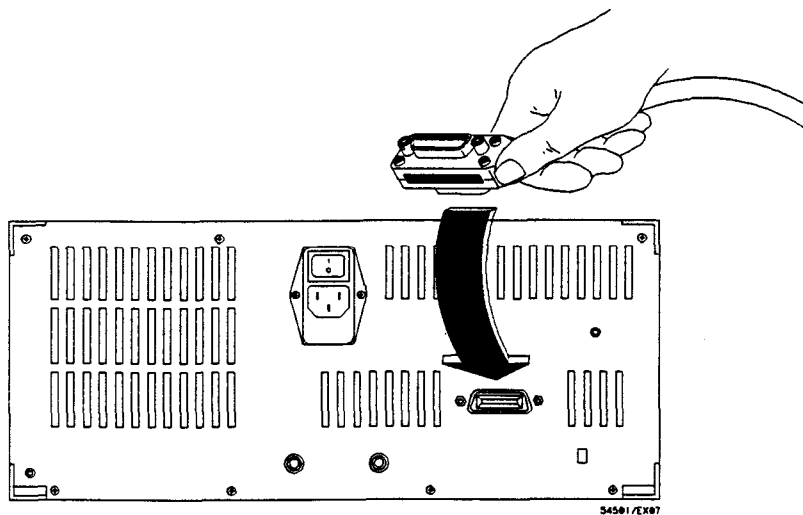

Figure 2-7. Connecting External Equipment

The HP 54510A must be properly addressed to communicate with the connected device. The HP 54510A HP-IB address is set in the HP-IB submenu. See "HP-IB Menu" in Chapter 12 for detailed information about the HP-IB submenu.

Introduction to the Front Panel

This chapter describes the functional sections of the HP 54510A front panel. The explanation of each area also contains their interaction with each other and provide a basis for applications and usages.

The front panel is separated into six functional areas.

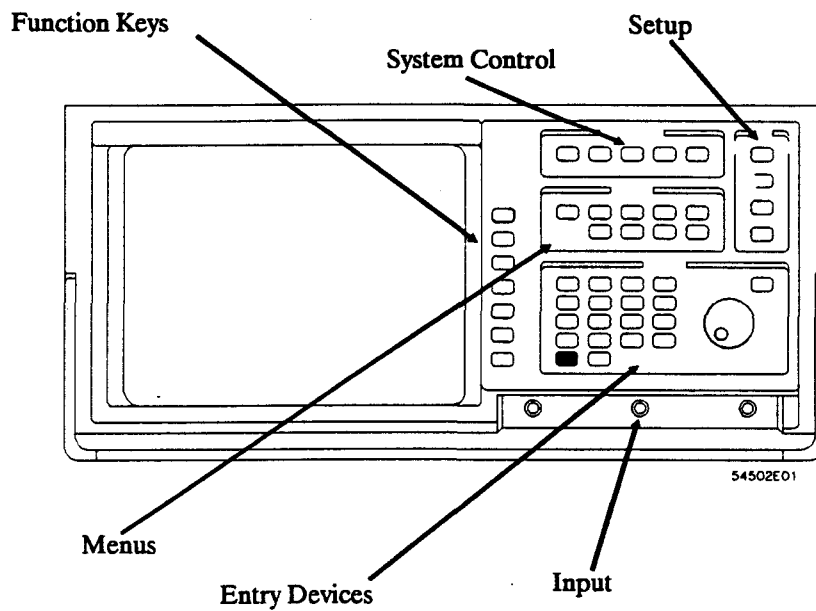

Figure 3-1. HP 54510A Front Panel

System Control

The SYSTEM CONTROL keys are located along the top of the oscilloscope to the right of the display. This section controls the following functions:

- Dynamic display features
- Selecting local control
- Activating hardcopy

Selection of any key in the SYSTEM CONTROL section causes the oscilloscope to execute that command immediately.

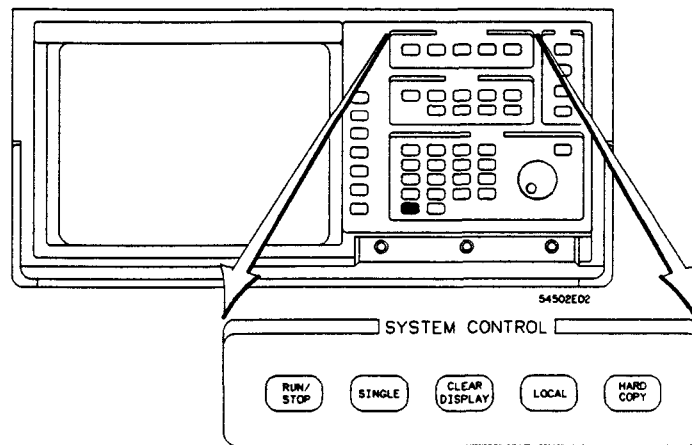

Figure 3-2. System Control Section

RUN/STOP Key The RUN/STOP key toggles the acquisition status of the HP 54510A. If the oscilloscope is currently running (the current status is displayed in the top left corner of the display in the message field), the instrument is placed in the *stopped* mode. In this mode, normal acquisition is stopped and the last acquired data is displayed. If the oscilloscope is stopped, it is immediately changed to another mode (for example, *running*, *awaiting* or *trigger*, *auto-trigger*).

SINGLE Key The SINGLE key activates the acquisition system for one trigger event. One acquisition is made and displayed; then the data acquisition and display cycle is stopped. In repetitive mode, this single acquisition is superimposed on the current displayed data. If the display has been cleared before the SINGLE key is pressed, only one acquisition is displayed.

CLEAR DISPLAY Key The CLEAR DISPLAY key clears the display and resets all associated measurements. If the oscilloscope is in the stopped mode, all data that is currently displayed is erased. If the oscilloscope is *running*, all data is erased; however, new data is displayed on the next acquisition. The RUN/STOP and SINGLE keys are not affected.

The RUN/STOP, SINGLE, and CLEAR DISPLAY keys have a relationship that make it possible to manipulate data acquisitions and view one, two, or several acquisitions. It is possible to stop acquiring data, to clear the display, and to capture one acquisition for evaluation. The display can be cleared while acquiring to capture new data. The acquisitions can be manipulated with these three keys and other keys and settings are not affected.

LOCAL Key The LOCAL key sends a return to local control message to the HP-IB interface and returns control to the front panel. This key can be locked out if a local lockout command is executed over the HP-IB.

This is the only active front-panel key while the oscilloscope is in remote operation, if it has not been locked out.

HARDCOPY Key The HARDCOPY key executes an immediate hardcopy of the currently displayed data on a compatible plotter or graphics printer and stops all other oscilloscope functions while printing.

The oscilloscope must be in the talk only mode, and the hardcopy device must be in the listen always mode. Setup of the hardcopy options is accessed in the HP-IB submenu (see Chapter 12, "Utilities Menu").

Selection of any key aborts the hardcopy action.

Setup

The **SETUP** section of the front panel controls subsystems for displaying input data. The setup section controls the following display information:

- **AUTOSCALE** for automatic scaling of the waveform display area
- **SAVE** and **RECALL** setups
- Quick access to channel, function, and trigger information on the **SHOW** screen

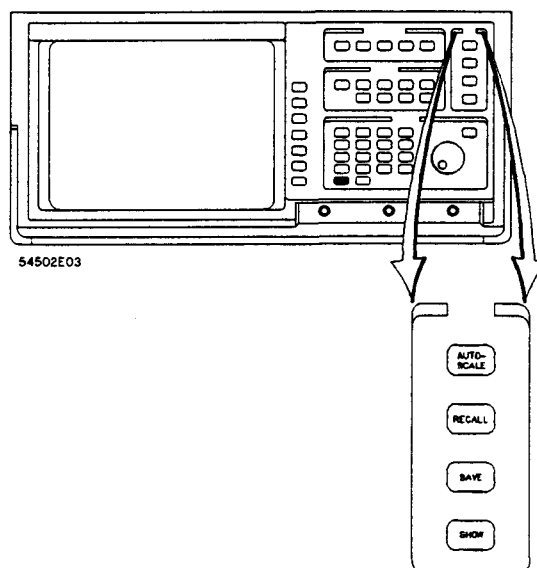

Figure 3-3. Setup Section

AUTOSCALE Key This key causes the oscilloscope to evaluate all input signals and set the correct conditions to display the signals. When AUTOSCALE is pressed the following conditions are set:

- Vertical sensitivity on all channels (if applicable)
- Vertical offset on all channels (if applicable)
- Trigger edge mode, positive slope, and proper trigger level for the trigger source
- Sets to minimum persistence when in normal display and repetitive acquisition modes (single persistence in real time acquisition mode)
- Time per division

Autoscale also includes a soft reset which performs the following:

- Turns off $\Delta t/\Delta V$ markers
- Turns off all measurements
- Turns off measurement limit test
- Turns off waveform math functions
- Turns off waveform/pixel memory display
- Turns off statistics
- Turns off connect-the-dots
- Sets holdoff to 40 ns (minimum value)

The previous oscilloscope settings are stored in volatile memory RECALL 0. To recall settings, press RECALL 0.

RECALL Key The RECALL key has three primary functions:

- Pressing the RECALL key and then selecting 1, 2, 3, or 4, causes a recall of a previously saved setup configuration.
- The current configuration is automatically saved before execution of an autoscale, recall, or setting up ECL/TTL presets. RECALL 0 is an undo of these actions. Waveforms cannot be saved to RECALL 0.
- Pressing RECALL CLEAR resets the instrument and returns the HP 54510A to default/power-up settings. The oscilloscope does not perform power-up self-tests (see Instrument Reset).

SAVE Key The SAVE key immediately stores the oscilloscope setup configuration in nonvolatile memory. Press SAVE, and then select a save register: 1, 2, 3, or 4. An advisory is displayed above the waveform display area indicating the setup configuration has been saved.

SHOW Key The SHOW key accesses the following information:

- Channel scaling
- Channel offset
- Channel coupling
- 50 Ω
- Probe attenuation
- Trigger source
- Trigger level
- Math function operation
- Math function scaling
- Math function offset
- Memories

Pressing the SHOW key toggles between the currently selected menu and the SHOW screen.

This screen presents the most complete and detailed instrument setup information. Select this screen before making a hardcopy to include all SHOW screen information on the hardcopy.

Menus

The MENUS section consists of nine keys:

- TIMEBASE
- CHANNEL
- TRIG
- DISPLAY
- $\Delta t/\Delta V$
- WFORM MATH
- WFORM SAVE
- DEFINE MEAS
- UTIL

Each of these menus is discussed in the following chapters.

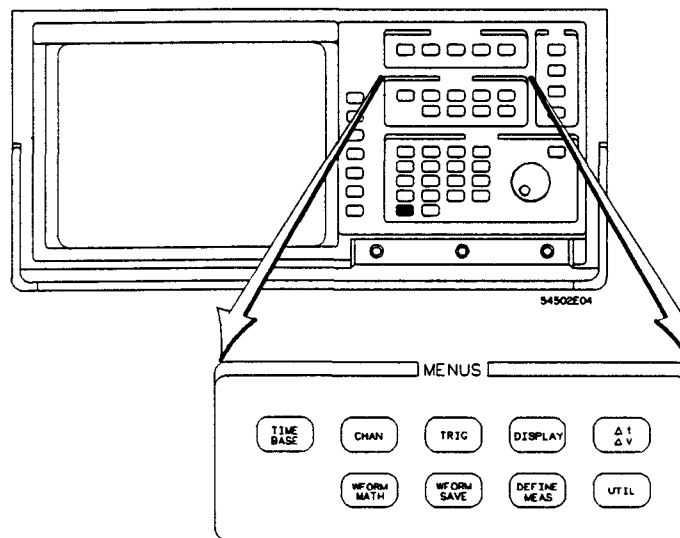

Figure 3-4. Menu Section

Entry

The ENTRY device section contains a multifunction numeric keypad, a selection knob, and a FINE key.

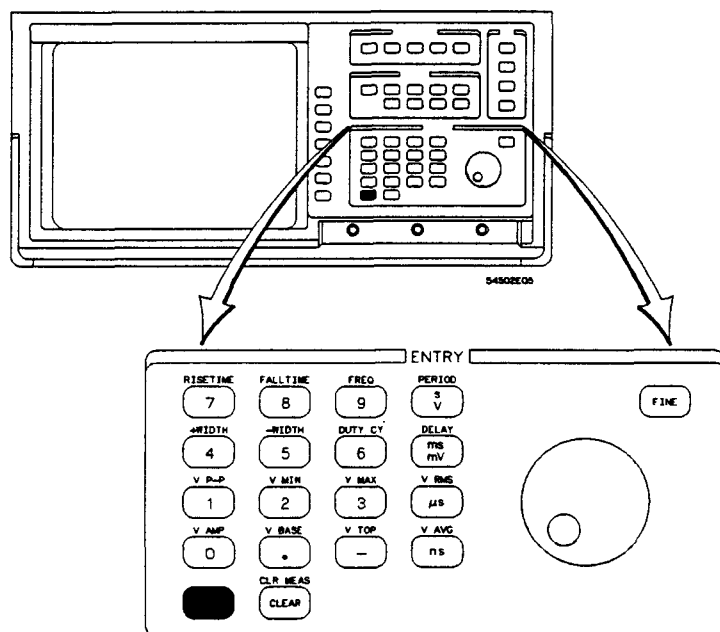

Figure 3-5. Entry Section

Numeric Keypad

The keypad is for direct numeric input. To input known values directly, press the associated softkey to activate the desired field on screen, and then select the units with the numeric keys. For example, do the following steps to set the vertical sensitivity to 500 mV:

- Select **V/div** in the Channel menu to ensure it is the active field (displayed in fullbright)
- Press 5, 0, 0, mV in sequence.

The blue key on the numeric keypad selects the alternate function when pressed before a numeric key on the front-panel keypad. The alternate function of the keys on the right column are measurement units. The CLEAR key clears any selections made for the active field.

Knob The knob changes values within each function. It increments, decrements, or toggles the selection in the active field or function. The current selection is displayed in fullbright in the displayed menu area and can be changed with the knob.

FINE Key The FINE key changes the increment and decrement sequence. Instead of sequencing in the normal sequence, the values increment/decrement in more precise values. Use this feature when the normal sequence is too coarse for precision measurements or settings.

When the HP 54510A is operating in the fine mode, the word *fine* is displayed in the lower right corner of the CRT.

Input

The input section consists of connectors for signal input. Channel inputs 1 and 2 select 1 M Ω or 50 Ω input impedances and each is shunted by approximately 7 pF at the input BNC with a maximum input voltage of 250 V (> 50 mV/div range). See Appendix B, "General Information" for specifications on the input channels.

Introduction to the Timebase

This chapter contains a description of the TIMEBASE menu and how the entire horizontal display and parameters are controlled with this menu.

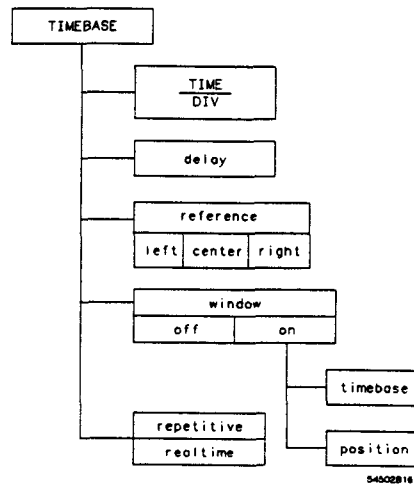
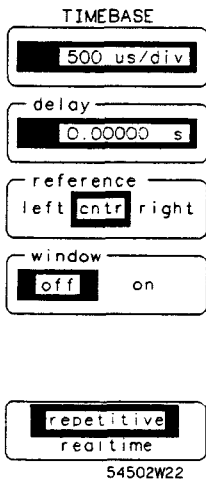

Figure 4-1. Timebase Menu

Time/Div Key

The time/division function controls the time scale on the horizontal axis from 1 ns/div to 5 sec/div. The main timebase is incremented and decremented in a 1-2-5 sequence. The FINE key does not affect the timebase settings while the acquisition is running.

This key affects the sample rate at which the scope acquires data. The sample rate for the selected time/div setting is displayed below the time/div field. In the realtime mode and with the acquisition stopped, this key also controls the zoom feature (see repetitive/realtime key in this chapter).

Acquisitions are not displayed until all data is available (similar to normal acquisitions) to display. As data is being sampled, the advisory **n s to initialized** is displayed while pre-trigger data is collected and **n s to complete** is displayed while post-trigger data is collected. This message indicates the time needed to complete acquisition where **n** is the remaining time (in seconds, **s**) and continues to countdown until the time has elapsed. The advisory **running** is displayed as the write cycle to the screen is executed and displayed data is updated.

The total time acquired and the sample rate are dependent on the timebase setting. Listed below are the total acquisition times and the sample rate for each timebase setting in real time mode.

TIMEBASE	TOTAL TIME ACQUIRED (real time)	SAMPLE RATE
1 ns → 50 ns/div	8 usec	1 GSa/s
100 ns/div	16 usec	500 MSa/s
200 ns/div	32 usec	250 MSa/s
500 ns/div	80 usec	100 MSa/s
1 us/div	160 usec	50 MSa/s
2 us/div	320 usec	25 MSa/s
5 us/div	800 usec	10 MSa/s
10 us/div	1.6 msec	5 MSa/s
20 us/div	3.2 msec	2.5 MSa/s
50 us/div	8 msec	1 MSa/s
100 us/div	16 msec	500 kSa/s
200 us/div	32 msec	250 kSa/s
500 us/div	80 msec	100 kSa/s
1 ms/div	160 msec	50 kSa/s
2 ms/div	320 msec	25 kSa/s
5 ms/div	800 msec	10 kSa/s
10 ms/div	1.6 sec	5 kSa/s
20 ms/div	3.2 sec	2.5 kSa/s
50 ms/div	8 sec	1 kSa/s
100 ms/div	16 sec	500 Sa/s
200 ms/div	32 sec	250 Sa/s
500 ms/div	80 sec	100 Sa/s
1 s/div	160 sec	50 Sa/s
2 s/div	320 sec	25 Sa/s
5 s/div	800 sec	10 Sa/s

delay Key

Selecting **delay** assigns delay as the active function. When delay is set to 0 the trigger event occurs at the delay reference point. Positive delay indicates time after trigger and negative delay indicates time before trigger. Therefore, a delay setting of -50 ns indicates that the trigger event occurs 50 ns after the delay reference point. In the real-time mode and with the acquisition stopped, delay controls the pan feature (see the pan and zoom exercise in this chapter.)

$$\text{reference} = \text{trigger event} + \text{delay}$$

reference Key

The reference key changes the delay reference point to one of three reference points:

- left
- cntr (center)
- right

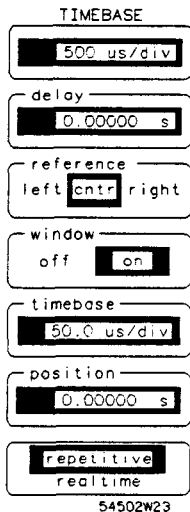

If delay is set to 0, the reference point consists of pre-trigger data to the left and post-trigger data to the right.

NOTE

The time from trigger changes with the delay setting and is displayed at the bottom of the waveform area at the left, center, and right of the display.

repetitive/ realtime Key

The bottom function key selects one of the two acquisition modes used by the HP 54510A:

- repetitive acquisition
- realtime acquisition

See Chapter 7, "Display Menu" for more on acquisition modes.

repetitive mode The repetitive mode sets the HP 54510A to acquire data in the repetitive acquisition mode (see *Feeling Comfortable With Digitizing Oscilloscopes*). In this mode, the oscilloscope samples data continuously and builds up a repetitive waveform after many data points have been attained; this mode is useful when viewing a continuous waveform.

In the repetitive mode:

- The HP 54510A displays data collected from multiple acquisitions from either or both channel inputs.
- Data from multiple acquisitions can be averaged to generate a display (the *avg* key is activated when in the *repetitive avg* mode).
- Data from each acquisition can be displayed for a definable period of time (*persistence*).
- Waveform records are established at 501 data points on all time/division settings.

realtime mode When in realtime mode the HP 54510A displays data collected during successive single-shot acquisitions from either or both input channels. The HP 54510A can make a single-shot capture simultaneously on both channels.

Two simultaneous, non-recurring, or very low repetition rate events can be captured at the same time.

Some or all of the 8k waveform buffer memories (each channel has its own 8k buffer) can be displayed. The displayed signal is completely updated as each acquisition is made.

The following graphics are shown at the top of the display area and in figure 4-2:

- memory bar - represents the displayed portion of the waveform record
- memory bar display line - represents the entire 8k waveform record
- "T" - indicates the trigger point's location within the 8k waveform record.

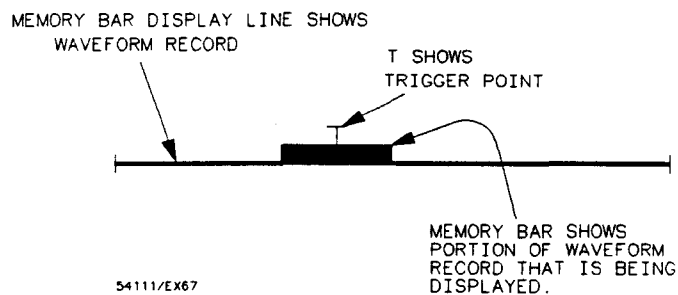

Memory Bar Exercise

This exercise demonstrates the real time acquisition mode memory bar and the ability to display signals that occur before and after the trigger event of the displayed signal. The memory bar shows the portion of the waveform record that is being displayed.

- Connect the HP 54510A rear-panel AC CALIBRATOR signal to channel 1 with a coaxial cable.

HP 54510A
Front-Panel Reference

Timebase
4-5

- Disconnect any other signals that may be connected to other inputs.
- Press AUTOSCALE and then stop the acquisition with the RUN/STOP key.
- Select delay in the TIMEBASE menu.
- Use the entry devices to vary the delay. The memory bar at the top of the display moves with the delay reference changes. The memory bar is shown in figures 4-3, 4-4, and 4-5.

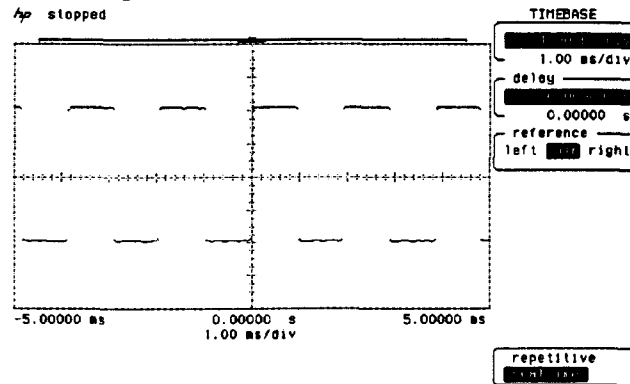

4-3. Memory Bar at Center of Acquisition

Three different portions of the waveform can be viewed while the acquisition is running as shown in figures 4-2, 4-3, and 4-4. Either left, center, or right can be selected with the delay reference key in the TIMEBASE menu.

When the acquisition is stopped, the the display can be placed at any portion of the waveform record by changing the delay value in the TIMEBASE menu.

The delay value moves the 8k acquisition display relative to the trigger point.

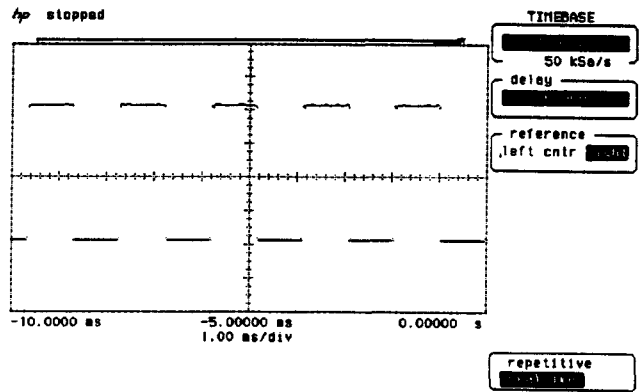

4-5. Memory Bar at Right of Acquisition

As the delay value is changed, the "T" moves to the right or to the left along the memory bar depending on a positive or negative delay value. Negative delay values show pre-trigger events and positive delay values show post-trigger events in the acquisition display.

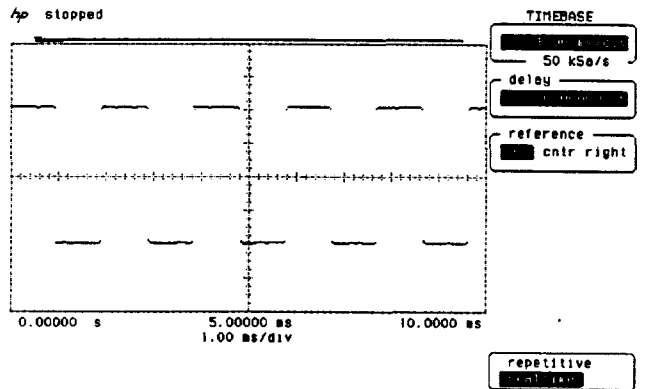

4-4. Memory Bar at Left of Acquisition

Single-shot Exercise

This exercise shows the single-shot capabilities of the HP 54510A. Single-shot, in repetitive display mode, is used to build a waveform while displaying the 1 gigasample/second rate. Single-shot, in real-time mode, is used to compare interpolated with non-interpolated data.

The 1 gigasample/second digitizing rate of the HP 54510A allows capture of very fast non-recurring events, such as a microprocessor start-up sequence. Error causing glitches that disrupt system performance can be captured for analysis.

Single-shot in Repetitive Mode

Single-shot is used to build a waveform while displaying the 1 gigasample/second sample and digitize rate.

- Connect the HP 54510A rear-panel AC CALIBRATOR signal to channel 1 with a coaxial cable.
- Disconnect any other signals that may be connected to other inputs.
- Press AUTOSCALE.
- In the TIMBASE menu, change timebase to 10 ns.
- Set the acquisition mode to **repetitive**.
- Press the STOP/RUN key to stop acquisition.
- Press CLEAR to clear the display.
- Press the SINGLE and CLEAR keys alternately to display and erase single-shot data.
- Press the SINGLE key repeatedly. The waveform fills in with each single-shot addition to the waveform, as in figure 4-6.

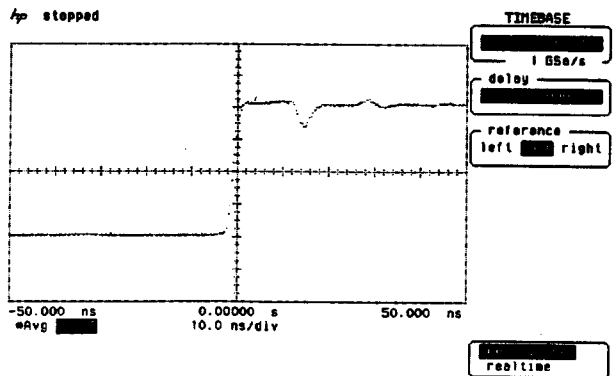

4-6. Single-shot Waveform Built-up in Repetitive Mode

When averaging is off:

- data points on the display are not changed by new data when the SINGLE key is pressed.
- data stays on screen until the instrument setup is modified or CLEAR is pressed.

When averaging is on:

- data on screen is averaged with new data each time SINGLE is pressed.
- it is assumed enough data points have been acquired to satisfy the number of averages set in the DISPLAY menu.

To view the 1 gigasample/second digitizing rate:

- Press CLEAR.
- Press SINGLE.

The display shows a series of points 1 ns apart as in figure 4-7. This 1 ns separation is defined by the 1 gigasample/second digitizing rate.

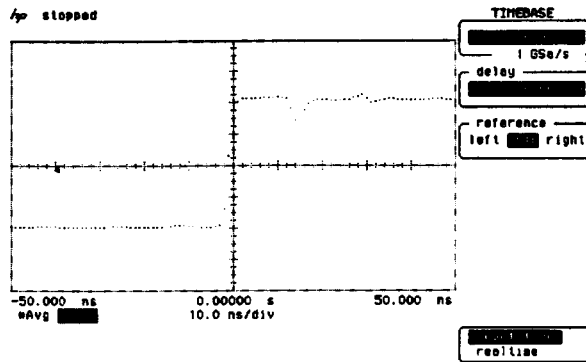

4-7. 1 Giga-sample/second Digitizing Rate

To observe the limitations of single-shot in the repetitive acquisition mode:

- Select the TIMEBASE menu and set timebase to 1 ns.
- Press CLEAR and then SINGLE. Ten data points from the input signal are displayed as in figure 4-8.

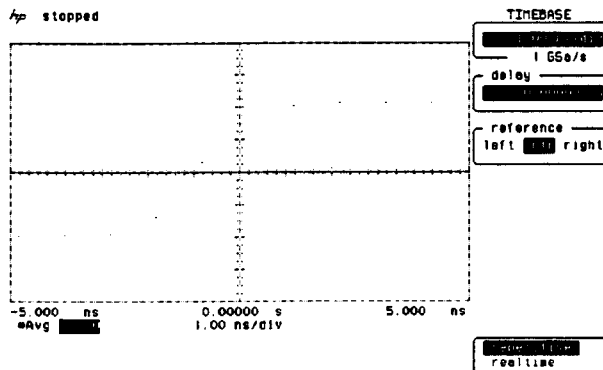

4-8. Ten-point Waveform in Repetitive Mode

Timebase
4-10

HP 54510A
Front-Panel Reference

Single-shot in Real Time Mode

In the real time acquisition mode, the data is interpolated at faster timebase settings for a more useful display. To observe the difference between non-interpolated and interpolated data:

- Select **realtime** in the **DISPLAY** menu.
- Press the **CLEAR** key.
- Press the **SINGLE** key. The waveform is displayed as in figure 4-9.

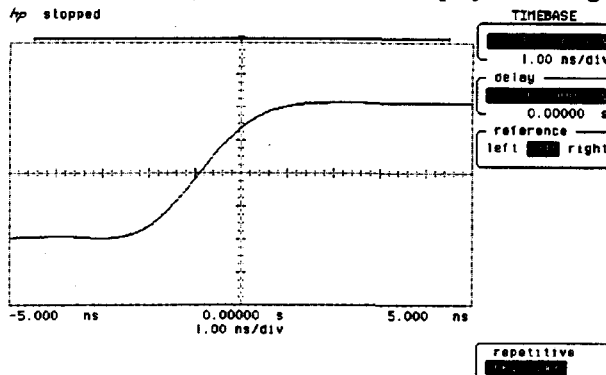

4-9. Ten-point Waveform in Real Time Mode

In the real time acquisition mode, the HP 54510A uses a digital oversampling filter to provide a more continuous waveform display. It automatically operates when there are less than 501 points on the display.

51m 补插 (由)

Pan and Zoom

Pan and zoom features are available in the real time acquisition mode and operable only when the acquisition is stopped. Applications that require precise evaluation of low repetition rate signals, such as radar and transponder pulse trains, are simplified by zooming and panning on single-shot data.

Zooming either expands or compresses the acquired waveform on the horizontal axis of the display. It is controlled by the timebase **time/div** control for expansion, magnification, or compression of a single-shot waveform in the real time acquisition mode. Decreasing **time/div** expands the waveform and is referred to as "zooming in". Increasing **time/div** compresses the waveform and is referred to as "zooming out".

Panning is moving the acquired waveform horizontally on the display. It is controlled by the timebase delay control. Increasing the delay moves the waveform to the left and increasing the delay moves the waveform to the right.

Pan and Zoom Exercise

This exercise shows how the timebase is used to zoom in on and zoom out of a single-shot waveform. The delay timebase is then used to pan the waveform horizontally on the display.

- Using a coaxial cable, connect the rear-panel AC CALIBRATOR signal of the HP 54510A to channel 1.
- Press AUTOSCALE. The rear-panel signal is displayed on screen as in figure 4-10.

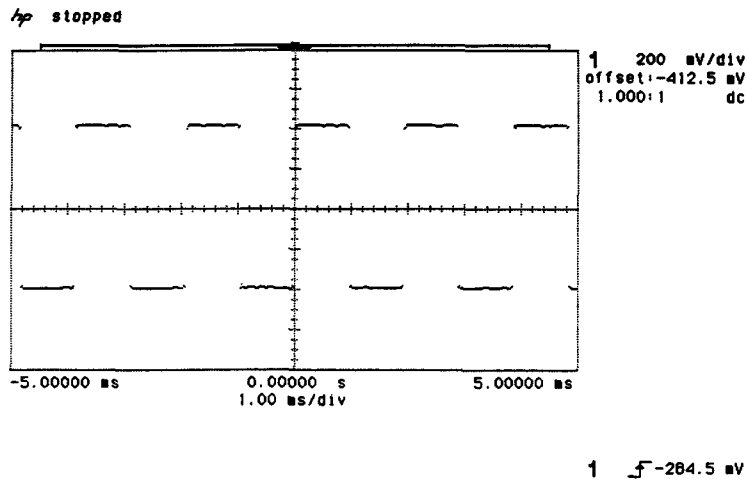

4-10. Rear-Panel Signal Autoscaled

Zooming In **TIMEBASE** menu, select **realtime** acquisition mode.

- Press **RUN/STOP** key to stop the acquisition.
- Press **CLEAR** key to clear the screen.
- Press the **SINGLE** key to acquire one data acquisition.
- Select time/division in the **TIMEBASE** menu.
- Rotate the front-panel knob. Increasing **time/div** displays more of the acquired waveform on the screen. Decreasing **time/div** zooms in on the acquired waveform.
- Set timebase to **20 ms/div**. The entire acquired waveform is displayed as in figure 4-11. The memory bar also shows that the entire memory is on the screen.

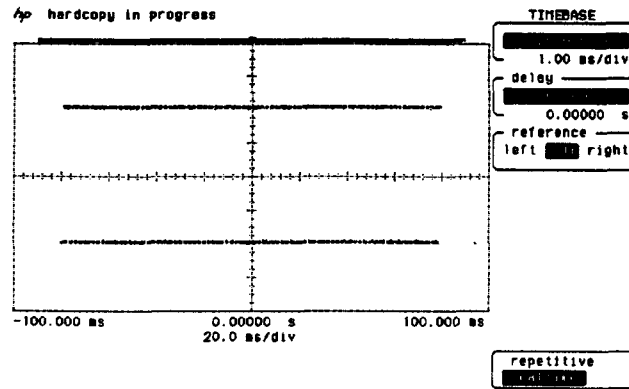

4-11. Zooming Out of the Acquisition

- Set timebase to 20 us/div to zoom in on the acquisition as in figure 4-12.

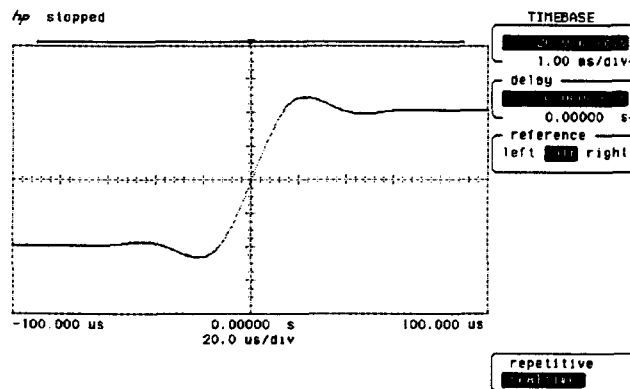

4-12. Zooming In on the Acquisition

The HP 54510A uses a digital oversampling filter to fill in the waveform for a more usable display at this sampling rate. The memory bar indicates the portion of the acquisition that is displayed.

Panning Panning moves the acquisition left and right for analyzation of waveforms.

- Select delay in the TIMEBASE menu.
- Use the front-panel knob to increase and decrease delay.

As delay is increased, the acquisition pans to the left because the window is past the trigger point, as in figure 4-13.

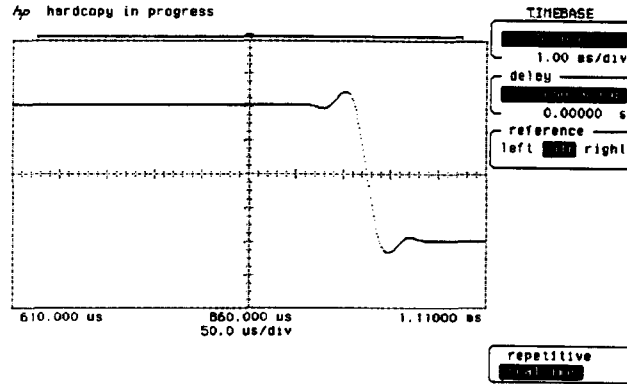

4-13. Panning to the Left

When the delay is decreased the waveform pans to the right as in figure 4-14. The data before the trigger point is being displayed.

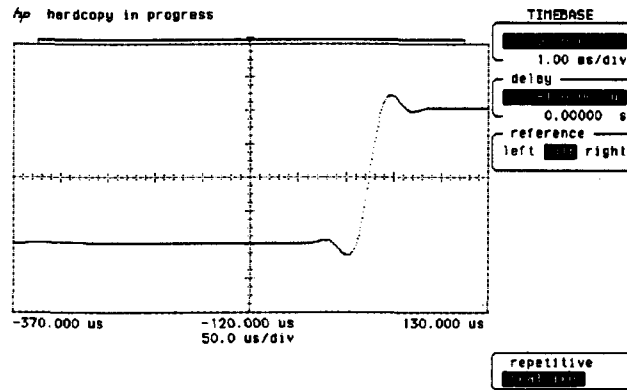

4-14. Panning to the Right

The memory bar moves to the left or right as the acquisition is panned. Panning and zooming can be used concurrently to examine the acquisition.

- Zoom out of the acquisition by increasing the timebase.
- Select delay and use the knob to center the acquisition area of interest.
- Zoom back in on the waveform of interest.

Introduction to Channels

The channel menu is a two-level menu and controls the vertical operation of the HP 54510A. This chapter describes the use of the two input channels, including vertical sensitivity, offset, coupling, attenuation and preset levels.

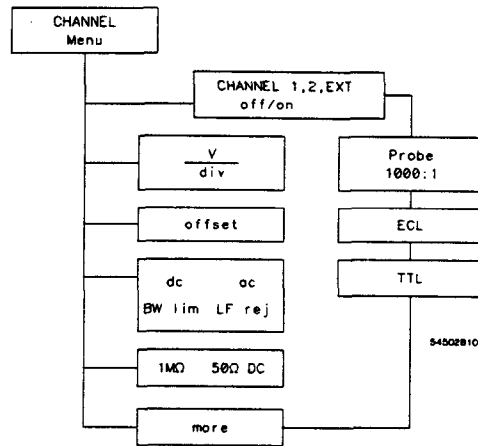

Figure 5-1. HP 54510A Channel Menu

CHANNEL Key

The top key in the channel menu is for channel selection. This key toggles between channels 1, 2, and external. When a channel is selected (highlighted in inverse video) it can then be turned on. When a channel is turned on the small circle immediately below the channel number is highlighted.

Note

It is possible to have a channel turned on and view while being in the vertical control menu of another channel. When making changes, ensure you have the proper channel and function selected and you are changing the channel you intend to change.

Vertical Sensitivity Key

The vertical sensitivity key is the third key from the top in the channel menu. The field itself is not labeled, however, the current volts/division is displayed with the units of the current selection. When this function is selected, either of the entry devices can be used for data entry.

The range of the vertical sensitivity for the HP 54510A is from 1 mV/division to 5 V/division. Vertical sensitivity changes in a 1-2-5 sequence with the knob. When the front-panel FINE key is selected, fully calibrated vernier adjustments can also be made using direct keypad entry or the knob.

offset Key

When offset is selected, the trace can be moved up or down with the knob or the keypad. Offset moves the voltage level at mid-screen.

Offset moves the displayed signal up or down, similar to the vertical position adjustment on an analog oscilloscope. However, because this oscilloscope has a true dc offset at the front end, it provides a much wider offset range. The offset voltage (referenced to the vertical midpoint of the

waveform display) is shown at the right of the waveform display when the SHOW key is pressed.

Coupling Key

The coupling key has several selection variables:

- dc
- dc BW lim
- ac
- ac BW lim
- ac LF reject

When dc is selected, 1 M Ω and 50 Ω dc input impedances are available as choices for input impedance.

Bandwidth limit is switchable with the different combinations of the coupling function. Bandwidth limit reduces the effective dc bandwidth to about 30 MHz. Ac coupling provides a high-pass filter that rejects frequencies below about 90 Hz. The LF reject provides a high-pass filter rejecting frequencies below about 450 Hz. Bandwidth limits and LF reject filters reduce the noise in the vertical path and the trigger path.

Input Impedance

Input impedance is 1 M Ω for ac coupling and selectable 1 M Ω or 50 Ω dc when dc coupling is selected in the coupling function.

more Key

The **more** key toggles between the two levels of the channel menu.

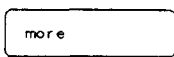
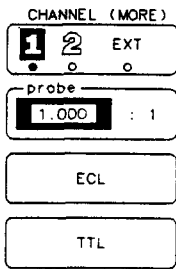

54502W26

probe key

The **probe** key selects probe attenuation with a range of 1000:1 to .9000:1. Attenuation is adjusted by either knob or entry keypad. When the knob is in coarse mode, adjustments are incremented or decremented in the 1-2-5 sequence. When in fine mode adjustments are in 0.1 increments.

Probe attenuation affects scaling factors for the display, not sensitivity at the input.

Probe attenuation is calibrated in the Utility menu. See Chapter 12, "Utility Menu", for information on probe calibration.

Attenuation factors are saved with the front panel setup.

ECL Key

The ECL key sets the oscilloscope to levels optimized for ECL circuits:

- V/Div: 200 mV/div (400 mV/div if # of screens is 2)
- offset: -1.3 V
- coupling: dc
- Trigger level: -1.3 V
- Trigger slope: no change

RECALL 0 returns the menu to the previous settings.

TTL Key

The TTL key sets the oscilloscope to levels optimized for TTL circuits:

- V/Div: 1 V/div (2 V/div if # of screens is 2)
- offset: 2.5 V
- coupling: dc
- Trigger level: 1.4 V
- Trigger slope: no change

To return to the previous settings press RECALL 0.

Introduction to the Triggers

The trigger modes of the HP 54510A provide many distinctive techniques to trigger and capture data. The triggering capabilities range from simple edge triggering to logic triggering on multiple signals.

This chapter contains descriptions of the triggering modes, and explanations on how to use them, and exercises detailing some real life applications. The HP 54510A has five triggering modes:

- Edge
- Pattern
- State
- Delay
- TV

Trigger Mode Interaction

The trigger level (threshold) for each channel is set in the edge trigger menu and is independent for each channel. It is carried over to all other modes, except the TV trigger mode. These levels are important settings because the high and low levels in the pattern, state, and delay modes are defined as being greater than or less than the trigger level.

The level for TV trigger mode is a special case and is set in the TV trigger menu.

Edge Trigger Mode

The edge trigger mode has the following selections:

- Trig'd/auto
- Trigger source
- Trigger level adjust
- Slope
- Noise reject
- Holdoff

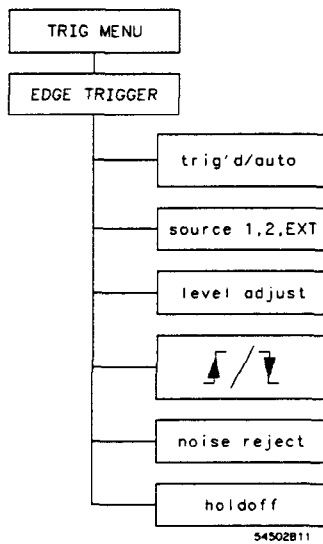

Figure 6-1. Edge Trigger Menu

- trig'd/auto Key** The trig'd/auto selection toggles between the two trigger modes. The current selection is displayed in inverse video. This field is available in all trigger menus.
- In the trig'd mode, the oscilloscope does not display data until all of the trigger requirements are satisfied. While waiting for the trigger requirements, the message *awaiting trigger* is displayed. In the auto mode, if a trigger is not found, a trigger is generated and acquired data is displayed. A status message is displayed in the upper left corner of the screen.
- source Key** The source key selects the trigger source. The options are channels 1 or 2, or external trigger. The current selection is highlighted in inverse video.
- level Key** The level key sets the trigger level. The range on this function is ± 12 divisions from center. It provides flexibility for setting exact triggering points and specifies levels used in the more sophisticated triggering modes. The center can also be selected with **centered**.
- slope Key** This field is not labeled, however, the available selections are graphic representations of the rising edge and falling edge. The current selection is highlighted in inverse video.
- noise reject Key** Turn noise reject on for triggering on noisy signals without the problem of false triggering.
- holdoff Key** Pressing the holdoff key assigns the entry devices to control holdoff. Holdoff disables the trigger circuit for a selectable time period or number of events after the trigger event. Holdoff is selected in 20 ns time increments, from 40 ns to 320 ms or in number of events from 2 to 16 000 000. Time and event are toggled with the knob. Events are number of patterns (**patrn**), state (**state**), or edge and tv (**edge**).

Edge Trigger (with Holdoff) Exercise

This exercise sets up the oscilloscope and a signal generator to view some of the features of the edge trigger. Holdoff is used to gain a stable trigger. This technique is not necessary for most applications and waveforms, however, for many non-recurring and irregular waveforms it is useful.

Instrument Setup Follow the instructions for setting up the signal generator. The signal for this exercise is a burst pattern with two positive cycles that repeats every $5\ \mu\text{s}$. Use an HP 8116A Pulse/Function Generator with the burst option or a signal generator capable of the same signal.

Make the following settings:

- MODE: I.BUR
- RPT: $5.00\ \mu\text{s}$
- BUR: 2
- FRQ: 1 MHz
- DTY: 50%
- AMP: 1 V
- OFS: -200 mV
- Set the signal for a square wave.

Oscilloscope Setup Connect the the signal generator to the channel 1 input and disconnect all other inputs.

- Press **AUTOSCALE** (see Figure 6-2).

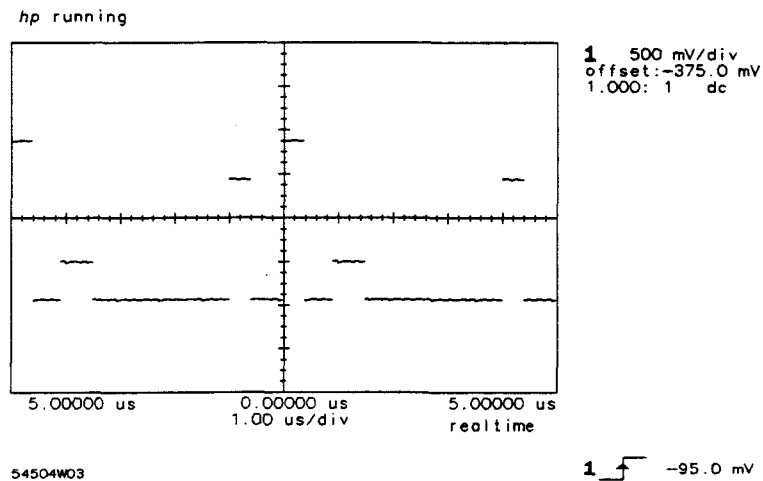

Figure 6-2. Two-Burst Waveform after Autoscale

- Select the **TIMEBASE MENU**.
- Set the sweep speed to **500 ns/div**.
- Set acquisition mode to **repetitive**.

The HP 54510A sets up the display parameters. It is now attempting to trigger on the first rising edge of the two cycle burst.

- Enter the **TRIGGER MENU** and press the **slope** key.

The oscilloscope is now attempting to trigger on the first falling edge of the two-cycle burst. Press the **slope** key again to trigger on the positive edge.

Note

The signal generator is set for two 500 ns pulses. The display on the oscilloscope appears to have three pulses. This is an unstable trigger condition. The following steps explain this condition and how to overcome it.

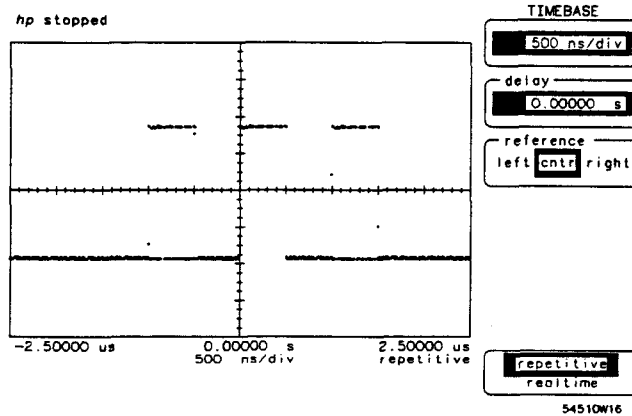

6-3. Two-burst Pulse

- **Determining holdoff time.** Change the time/div setting to 2 μ s/div. Press RUN/STOP (STOP), CLEAR DISPLAY, and SINGLE. This shows the period of the waveform. Since the oscilloscope is recognizing two valid trigger events (edges, in this case) of the burst, the holdoff time needs to be set such that it ignores the second pulse in the burst. Using Δt markers, the second edge can be found to be about 1 μ s from the first edge. (See Chapter 8, "Delta t/Delta V Menu.")
- Press the holdoff key.
- Set holdoff to 1.04000 μ s, with keypad or knob.

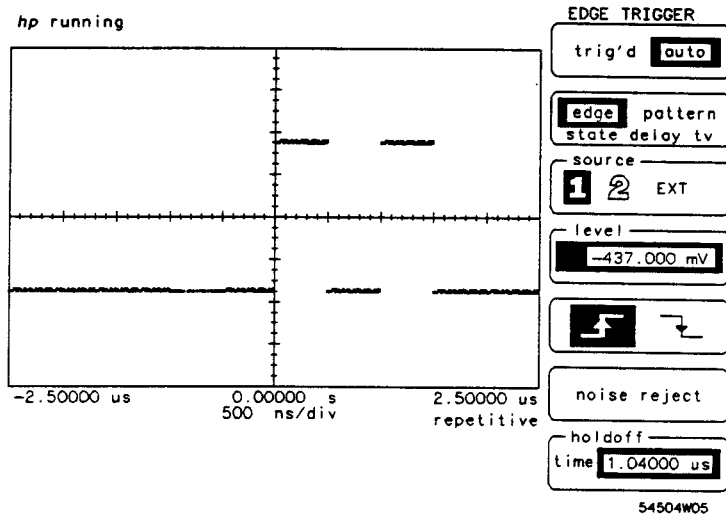

Figure 6-4. Two-Burst Pulse w/Stable Trigger

The input signal to the oscilloscope has two 500 ns pulses. On the first rising edge a trigger occurs and activates the holdoff timer. When the holdoff time (1.04000 μ s) has elapsed, the oscilloscope looks for another trigger. The oscilloscope triggers on the first rising edge of the second burst. Each trigger event occurs on a different pulse, and is consequently an unstable condition.

By adjusting holdoff to wait until the rising edge of the second pulse passes, the oscilloscope triggers only on the first rising edge and the signal is stable. In this case the trigger is stable with approximately 1.04 μ s holdoff.

Pattern Trigger Mode

The pattern mode defines a 3-bit pattern for the oscilloscope to recognize and generate a trigger event. When the inputs satisfy the trigger pattern and conditions, the HP 54510A triggers and displays the desired portion of the waveform.

The pattern mode is very useful for glitch detection because the HP 54510A triggers on a glitch and displays the resulting waveform.

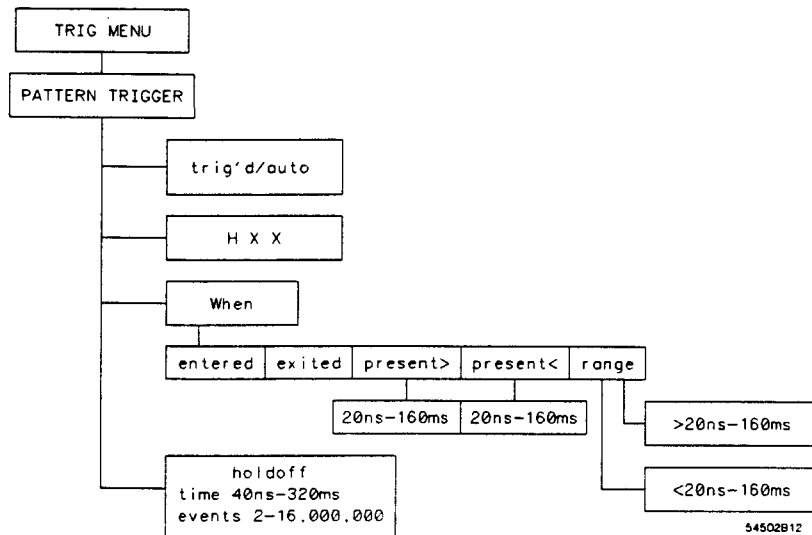

Figure 6-5. Pattern Trigger Menu

pattern Key This is an unlabelled field. The display depicts the 3-bit pattern. The active field is displayed in full-bright and is changed with the knob. The function key changes the bit selection of three levels:

pattern Key This is an unlabelled field. The display depicts the 3-bit pattern. The active field is displayed in full-bright and is changed with the knob. The function key changes the bit selection of three levels:

- H – high
- L – low
- X – don't care

The criteria for high is higher than the current trigger level, and low is lower than the current trigger level.

The 3-bit pattern represents the two channel inputs and the external trigger. The left-most bit corresponds to channel 2 and the right-most bit corresponds to the external trigger channel.

For example, if the pattern is LXH, the voltage on channel 1 must be lower than the trigger level set for channel 1, channel 2 is don't care so the input level is disregarded, and the external trigger input must be higher than the trigger level set for external trigger. If these conditions are satisfied by the inputs, then the oscilloscope generates a trigger event.

Note

When any channel is not being used in the qualifier pattern, it should be set as don't care. The trigger level is still compared to the no input channel and a high or low is determined. The only true don't care is X.

If the pattern XXX is selected, a trigger event does not occur because a trigger event is not defined.

when Key This key controls five sets of conditions that must be satisfied to generate a trigger event. These conditions are as follows:

- when entered: a trigger is generated on the first transition that makes a pattern true. The pattern must be false and go true to generate the trigger.

- **when exited:** a trigger is generated on the first transition that makes the pattern false. The pattern must be true and go false to generate a trigger.
- **when present > :** a trigger is generated when a trigger pattern is true longer than a specified minimum time period. This time period is specified in the next selection key that is activated when present > is selected. The present > time ranges from 20 ns to 160 ms.
- **when present < :** a trigger is generated when a trigger pattern is true less than a specified maximum time period. This time period is specified in the next selection key that is activated when present < is selected. The present < time ranges from 20 ns to 160 ms.
- **range:** this trigger condition is a combination of present < and present > . A trigger is generated when a trigger pattern is true for longer than a specified minimum and shorter than a specified maximum time period. These time periods are specified in the next two selection keys that are activated when range is selected. The first range time setting must be less than the second range time setting.

holdoff Key The holdoff key assigns the entry devices to control holdoff. Holdoff disables the trigger circuit for a selectable time period or number of events after the trigger event. Holdoff is selected in time units, from 40 ns to 320 ms and is incremented in 20 ns intervals or by number of patrn (patterns) from 2 to 16 000 000.

Pattern Trigger Exercise

This exercise demonstrates how to define the 3-bit pattern and how it affects the trigger and the resulting display.

Note

Set the trigger level for each trigger source while in the edge mode. These trigger levels must be set before you go to the pattern mode, or proper triggering may not occur.

Instrument Setup To perform the following exercise use the HP 8116A Pulse/Function Generator, or another function generator capable of producing the same 1 MHz, 1 volt, square wave signal.

Set up the HP 8116A Pulse/Function Generator:

- Mode = NORM
- FRQ = 1.00 MHz
- DTY = 50%
- AMP = 1.00 V
- OFS = -200 mV
- Set the generator for a square wave signal

Connect the signal to a BNC tee on channel 1 using a 1-meter coaxial cable. Connect another 1-meter cable from the other side of the BNC tee and terminate in 50 Ω to channel 2.

Oscilloscope Setup The extra cable length between channels 1 and 2 provides a time delay between the signals displayed on the oscilloscope. The propagation of a 1-meter coaxial cable is approximately 6 to 7 ns. This time delay is used to demonstrate the HP 54510A triggering capability.

- Press AUTOSCALE.

Set up the HP 54510A as follows:

- Timebase = 10.00 ns/div
delay = 0.00 s
reference = cntr
acquisition mode = repetitive
- Channel 1
Vertical sensitivity = 400 mV/div
offset = -200.00 mV
dc coupling
input impedance = 1 M Ω

- **Channel 2**
Vertical sensitivity = 400 mV/div
offset = -200.00 mV
dc coupling
input impedance = 50 Ω
- **Display**
minimum persistence
2 screens
axes
- **Trigger**
Channel 1 level = -200 mV
Channel 2 level = -200 mV
Set the trigger mode to pattern.

Set the pattern to HLX as follows:

- Press the function key until the first character is highlighted.
- Turn the knob until the highlighted area is H.
- Select the next character in the pattern.
- Continue until all characters are selected in the HLX pattern.
- Press the when key until entered is selected.

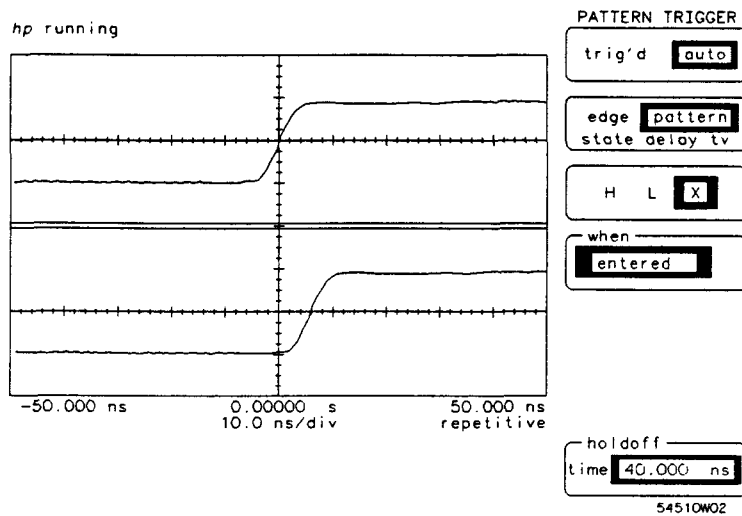

Figure 6-6. HLX when entered Pattern

Channel 1 is displayed in the top screen. To satisfy the conditions of the bit pattern, channel 1 must be high (higher than the channel 1 trigger level) or greater than -200 mV. When the signal on channel 1 goes higher than -200 mV and channel 2 is still low (less than -200 mV) the pattern conditions have been satisfied as the signal is entering the trigger conditions and the HP 54510A triggers.

- Press the when key and change the condition to when exited.

The oscilloscope triggers on the first transition that makes the bit pattern false, in this case when channel 2 goes high.

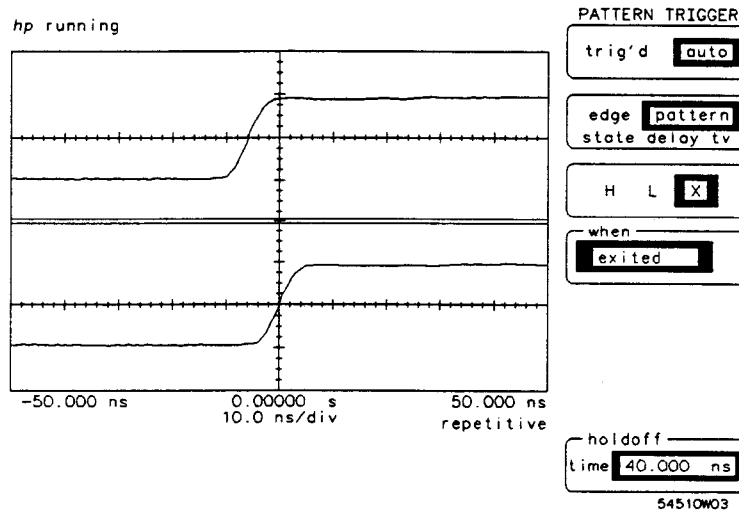

Figure 6-7. HLX when exited Pattern

- Change the bit pattern to HHX and select the entered condition.

To satisfy this bit condition both channels must be high. The oscilloscope does not trigger until channel 2 goes high while channel 1 is high.

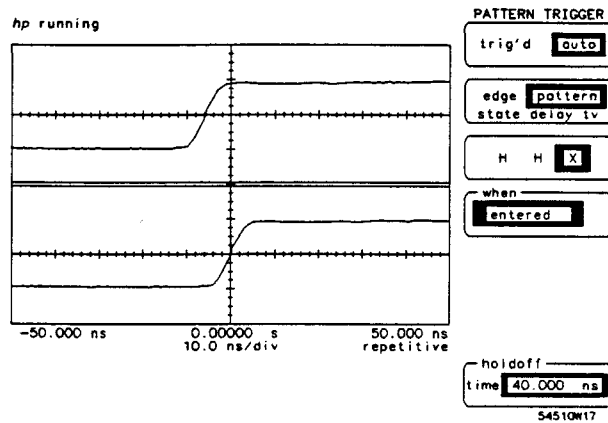

Figure 6-9. HHX when entered Pattern

- Change the trigger condition to when exited.

While channel 2 is still high, when channel 1 goes low the bit pattern is no longer true and the HP 54510A triggers.

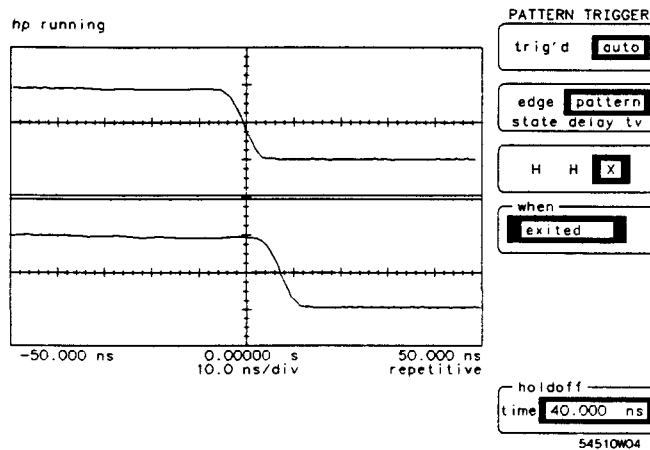
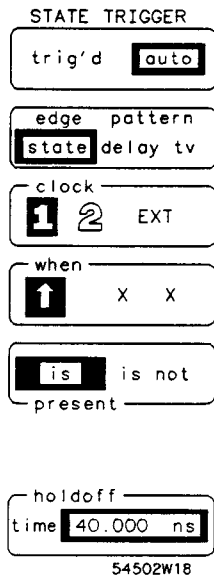

Figure 6-8. HHX when exited Pattern

State Trigger Mode



The state trigger mode is similar to the pattern trigger mode except that one channel is selected as a clock edge and the other two trigger sources define a pattern. When the pattern becomes true the HP 54510A triggers on the next clock edge if the pattern meets setup and hold criteria.

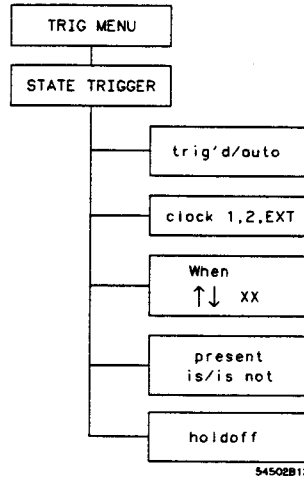

Figure 6-10. State Trigger Menu

The **trig'd/auto** and trigger mode function keys remain displayed in all trigger modes.

- clock Key** Select any channel to be used as the state clock. Select the channel by pressing the function key until the desired channel is highlighted. The clock selection is reflected in the next field with an arrow, pointing either up for a positive slope or down for a negative slope.
- when Key** The when key depicts the desired pattern. The displayed pattern shows the arrow at the selected clock channel. The other two trigger sources define the logic pattern that must be satisfied to generate a trigger event using the H, L, X convention described in the pattern trigger mode section of this chapter.

To change the pattern:

- Press the function key until the bit to be changed is highlighted.
- Rotate the knob until the desired setting is highlighted.
- Select the arrow to change the trigger slope, if necessary, and turn the knob until the desired settings appear.

present Key A trigger event is generated on the selected edge when the pattern is true and is **present** is selected, or a trigger occurs when the pattern is false and **not present** is selected.

holdoff Key The **holdoff** key assigns the entry devices to control holdoff. Holdoff disables the trigger circuit for a selectable time period after the trigger event. Holdoff is selected in 20 ns time increments, from 40 ns to 320 ms, or for events (count of states) 2 to 16 000 000. Time and event are toggled with the knob.

State Trigger Exercise

This exercise demonstrates how an input pattern is used to qualify a clock edge as a trigger.

State triggering extends the logic triggering capability of the HP 54510A by selecting one of the inputs as a clock and using the other inputs as qualifiers.

This is useful when it is necessary to synchronize the display with a system clock to detect a system state. For example, consider a synchronous memory bus. The state trigger mode enables only those events that occur when reading from a block of memory to be captured and displayed.

Instrument Setup To perform the following exercise use an HP 8116A Pulse/Signal generator or another signal generator capable of the same 1 MHz, 1 volt square wave.

Set up the HP 8116A as follows:

- Mode = NORM
- FRQ = 1.00 MHz
- DTY = 50%
- AMP = 1.00 V
- OFS = -200 mV
- Set the generator for a square wave signal

Connect the signal to a BNC tee on channel 1 using a 1-meter coaxial cable. Connect another 1-meter cable from the other side of the BNC tee to channel 2.

Oscilloscope Setup

The extra cable length between channels 1 and 2 provides a time delay between the signals displayed on the oscilloscope. The propagation of a 1-meter coaxial cable is approximately 6 to 7 ns. This time delay demonstrates the HP 54510A triggering capability.

- Press AUTOSCALE.

Set up the HP 54510A as follows:

- Timebase = 10.00 ns/div
delay = 0.00 s
reference = cntr
acquisition mode = repetitive
- Channel 1 turned on
Vertical sensitivity = 400 mV/div
offset = -200 V
dc coupling
input impedance = 1 M Ω
- Channel 2 turned on
Vertical sensitivity = 400 mV/div
offset = -200 mV
dc coupling
input impedance = 50 Ω

- **Display**
 minimum persistence
 2 screens
- **Trigger**
 Channel 1 level = -200 mV
 Channel 2 level = -200 mV
 Set the trigger mode to state
- Set the pattern to ↑L X as follows:
 1. Press the function key until the first bit is highlighted.
 2. Turn the knob until the highlighted area is ↑.
 3. Select the next bit in the pattern and select L.
 4. Continue until all bits are selected in the ↑L X pattern.
- Press the when key until is present is selected (see Figure 6-11).

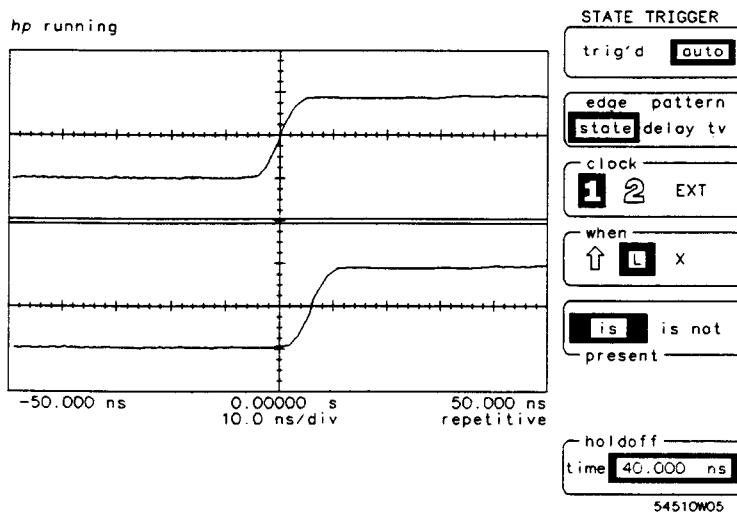

Figure 6-11. Channel 1 Clock LX State

Channel 1 is displayed in the top screen. To satisfy the conditions of the bit pattern, channel 2 must be low (lower than the channel 2 trigger level) or less than -200 mV. When the signal on channel 1 goes higher than -200 mV and channel 2 is still low (less than -200 mV) the pattern conditions have been satisfied, the HP 54510A triggers.

- Change the bit pattern to ↑ LX and select the is not present condition.

To satisfy this bit condition the clock channel must go low while channel 2 is high. The oscilloscope triggers on the falling edge of channel 1 when the L on channel 2 is not present, i.e. channel 2 is high.

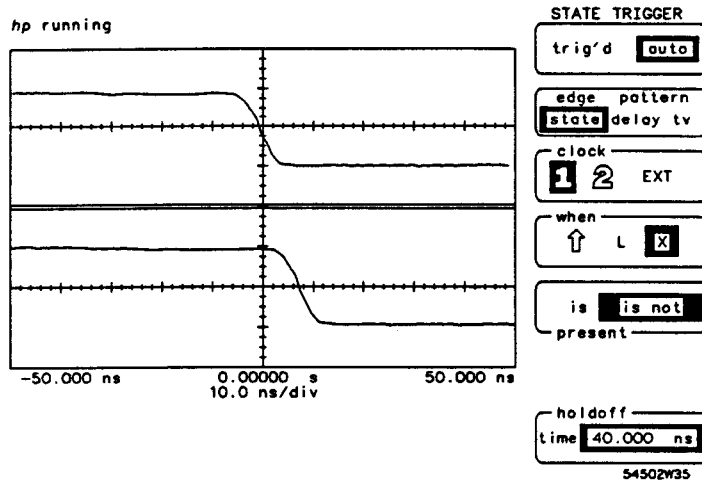
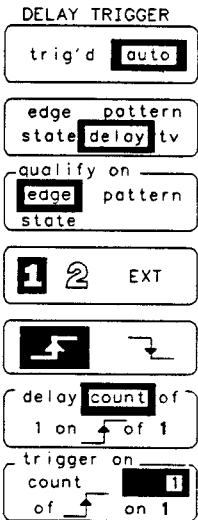

Figure 6-12. Channel 1 Clock LX State

Delay Trigger Mode

The delay trigger mode qualifies on a signal edge, pattern, or state, delay for a period of time (or occurrence of edges), and then triggers on a selected edge from any source.



54502W13

This trigger mode is versatile and accommodates most complex triggering situations. It has the flexibility to select different trigger sources, delay times, delay counts and then display various points of the waveform.

qualify on Key

The **qualify on** key selects which mode to qualify the trigger before a delay is defined.

The qualify options are:

- edge
- pattern
- state

qualify on edge

Select the edge qualifier and the next two function keys defines the parameters. The next key is an unlabelled field that selects the channel to be the source. The second key below the edge selection is the slope selection.

qualify on pattern When the pattern trigger option is selected, the next function key defines the qualifier pattern. Defining a pattern is the same as in the pattern trigger mode.

- Highlight the bit to be changed by pressing the function key.
- Change the bit by rotating the knob.

After selecting through all four bits, the active field is changed to the condition field. This field to sets conditions as in the Pattern Trigger mode:

- when entered
- when exited
- when present > [time]
- when present < [time]
- range > [time2] and < [time1]

These settings activate the next field, as appropriate, so the specific time parameters can be set.

qualify on state If the state trigger option is selected the next two function keys define the state conditions.

As in the state trigger mode, select the channel to define the state clock. This selection is reflected in the pattern with an arrow and the slope is depicted with the arrowhead pointing up or down. Use the function key to move the highlighted bit to change the pattern. When the pattern is set, the is/not present setting can be changed by moving the highlight to the is/not present field label and pressing the function key again. When the label is highlighted, toggle the setting between is/not present with the knob.

delay Key This field selects between two delay options. To change between the **time** and **count** options rotate the knob until the desired option is displayed in the inverse video field.

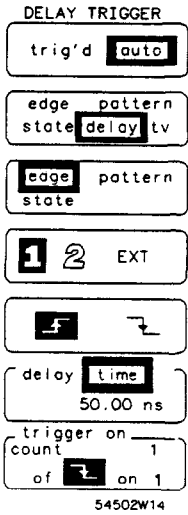

delay time disables the trigger circuit for a selected period of time, from 30 ns to 160 ms after the trigger has been qualified

Note

Time delay is not available in the time qualified pattern settings of when present >, when present <, or range.

- Press the function key until the highlight is on the first numeric field. This field selects the amount of delay after qualification, ranging from 30 ns to 160 ms.

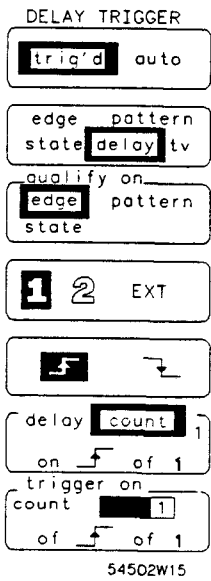

delay count (delay by edges) disables the trigger circuit for a selected count from 1 to 16 000 000 after the trigger has been qualified. After the selected count has been attained the HP 54510A looks for the user specified trigger edge.

- Press the function key until the highlight is on the first numeric field. This field to selects the number of edges to delay after the trigger has been qualified (from 1 to 16 000 000).
- Press the function key once more to activate the rising edge/falling edge option and select the desired edge with the knob.
- Press the function key once more to highlight the third option field and select the channel to delay on.
- Press the function key a fourth time to return to the first numeric field.

trigger on Key This key selects a specific edge to trigger on after the qualification and delay conditions have been satisfied. All other keys in this menu have dealt with defining qualifying conditions, however, this field sets the trigger point. This is another three position option switch.

- Press the function key to highlight the numeric field and select which occurrence to trigger, using the knob to set the number (1 to 16 000 000).
- Press the function key again and move the highlighted field to select the slope. The knob toggles the selection between rising and falling edge.
- Press the function key again and highlight the channel selection. The knob is used to change the channel selection.

Delay Trigger Exercise

This exercise demonstrates how to use the delay trigger to trigger on the exact point of a waveform. The exercise leads through setting up a complex signal, setting up the HP 54510A, and changing settings and counts for viewing various points on the waveform.

Instrument Setup Set up an HP 8116A (or comparable signal/generator) for a burst pulse with ten bursts that repeats every 50 μ seconds.

Set up the HP 8116A Pulse/Function Generator:

- Mode = I.BUR
- RPT = 50 μ s
- BUR = 10
- FRQ = 5.0 MHz
- DTY = 50%
- AMP = 1.00 V
- OFS = -200 mV
- Set generator for a pulse signal

Connect the signal to channel 1 of the HP 54510A.

Oscilloscope Setup The HP 54510A autoscales and displays this signal, however, for this example make the listed triggering changes after autoscaling.

- Press AUTOSCALE.

hp running

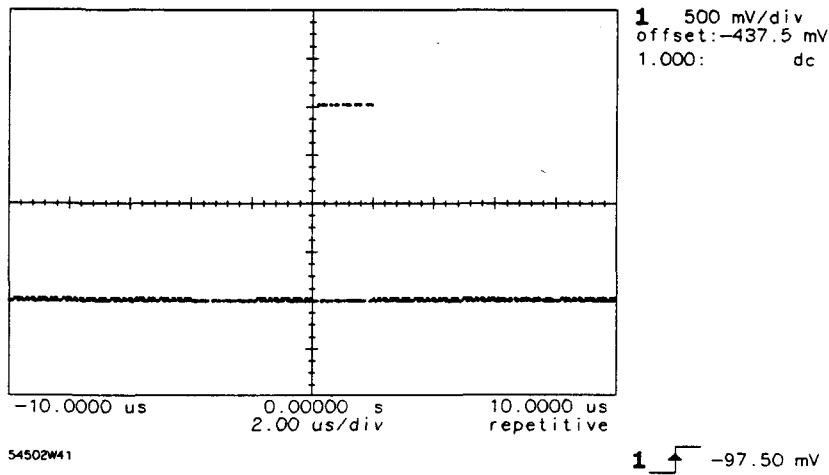

Figure 6-13. Ten Burst Pulse after AUTOSCALE

Set up the HP 54510A as follows:

- Press TIMEBASE and select repetitive.
- Press TRIG and select trig'd display.
- Select delay trigger mode.
- Qualify on edge and the rising edge of channel 1 as the source.
- Select a delay time of 2.5 μ s to gain a stable trigger.
- Set trigger on to trigger on rising edge 1 of channel 1.

This trigger setup qualifies on the first rising edge of the burst, delays through the remaining portion of the burst, then triggers on the first edge of the next burst.

- Press **TIMEBASE** and set time/division to **500 ns**.

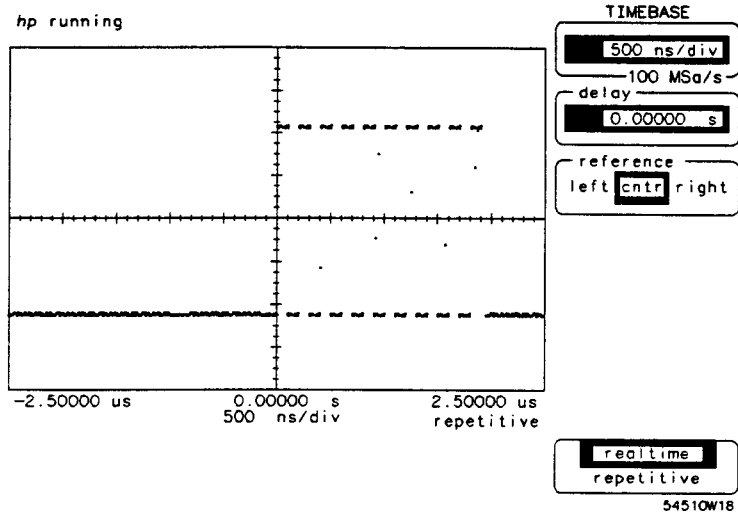

Figure 6-14. Ten Burst Pulse w/Stable Trigger

- Return to the trigger menu and set **trigger on count** to **5**. This tells the oscilloscope to trigger on the 5th rising edge of the next burst (see Figure 6-15).

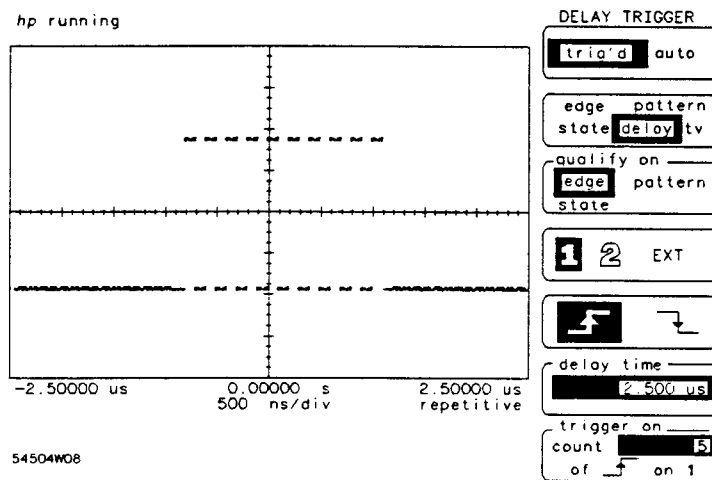

Figure 6-15. Ten Burst Pulse Triggered on Pulse 5

- Change the trigger on count key to 9 (see Figure 6-16).

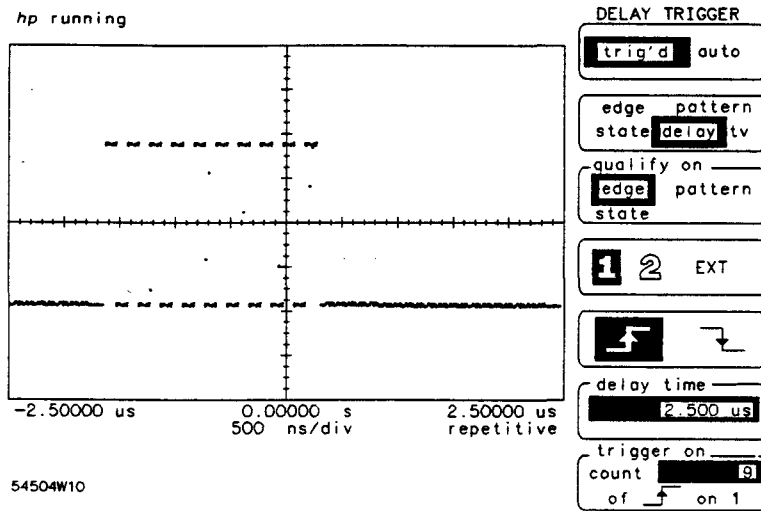
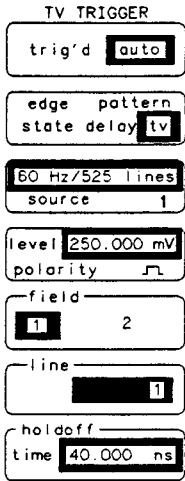

Figure 6-16. Ten Burst Pulse Triggered on Pulse 9

By setting the oscilloscope to the delay trigger mode, a specific time or count to delay between qualification and trigger can be added.

In this exercise, the trigger was delayed to get a stable display. When the time delay had elapsed the HP 54510A began counting rising edges until it found the ninth edge.

TV Trigger Mode



54501/WF 17

The TV TRIGGER menu enables the HP 54510A to trigger on clamped tv signals. The two most common tv standards; 60 Hz/525 lines or NTSC is the standard used in the United States, 50 Hz/625 lines is the standard used in most European countries. This trigger menu also allows for user defined tv signals that may be used in other parts of the world.

To move the highlighted inverse video window within a field you must press the selection key and to change the value displayed in the window you must rotate the knob.

Note

Pay close attention to the movement of the highlighted window; it moves to various options within the field.

Standard Select Key

The source key chooses between the NTSC standard tv signal used in the United States with a 60 Hz and 525 lines per frame, the standard of 50 Hz and 625 lines per frame used in most countries in Europe. The third option is for user defined ranges of the tv signal. User-defined ranges can be used to trigger on any of the proposed HDTV standards.

To make the desired selection:

- Press the selection key and select the standard by rotating the knob. The active field is highlighted in inverse video.

Source Select Key

To select the trigger channel to be used as a source,

- Press the selection key and move the highlighted field, rotate the knob until the desired channel is displayed.

level/polarity Key The level option sets the trigger level that is applicable only to the tv trigger source.

- Press the function key again and the highlighted window moves to the polarity option and selects the rising edge or falling sync pulses to trigger on.

field Key The field key selects field, 1 or 2.

line Key The line key selects which line the trigger will be generated on. This selection is dependent upon which field has been selected previously.

If the previous selection is the 60 Hz, 525 lines standard, the options available depend upon which field, 1 or 2 is selected:

- If field 1 is selected, select from line 1 to 263 in field 1.
- If field 2 is selected, choose from line 1 to 262 in field 2.

This tv trigger mode is compatible with broadcast standard M.

If the 50 Hz, 625 lines standard is selected, the options are also dependent upon field settings:

- If field 1 is selected the range of lines is from 1 to 313,
- If field 2 is selected the range of lines is from 314 to 625.

This tv trigger mode is compatible with broadcast standards: B, C, D, G, H, I, K, K1, L, and N.

holdoff Key The holdoff key enables the oscilloscope to hold off the trigger event from 40 ns to 320 ms and is incremented in 20 ns time frames.

TV Trigger Exercise

Video signals are unique, and as such have unique requirements for proper triggering. This exercise demonstrates how to display and work with video signals on the HP 54510A.

Instrument Setup Use a standard NTSC signal generator with clamped video output for this exercise. Turn color bars on.

Oscilloscope Setup Connect the NTSC video signal to channel 1 of the HP 54510A.

- Press AUTOSCALE.
- Select the tv trigger mode.
- Set 60 Hz/525 lines and channel 1 as the source.

Determine the polarity of the sync pulse.

- Select the trigger level and rotate the knob until a stable display is attained. When a sync pulse is visible, determine the polarity, select polarity (press the function key) and set the sync pulse in accordance with the actual pulse.
- Set the trigger level at approximately the midpoint of the sync pulse.

This sets the trigger level just below the middle of the sync pulse and tells the oscilloscope to trigger on the leading edge.

- Set trig'd/auto to trig'd.

This eliminates the possibility of a premature trigger event occurring.

- Select field 1 and line 1.
- Press TIMEBASE and set time/division to 100 μ s/div.

- Press DISPLAY and set persistence to ≈ 600.0 ms to accommodate video signals.

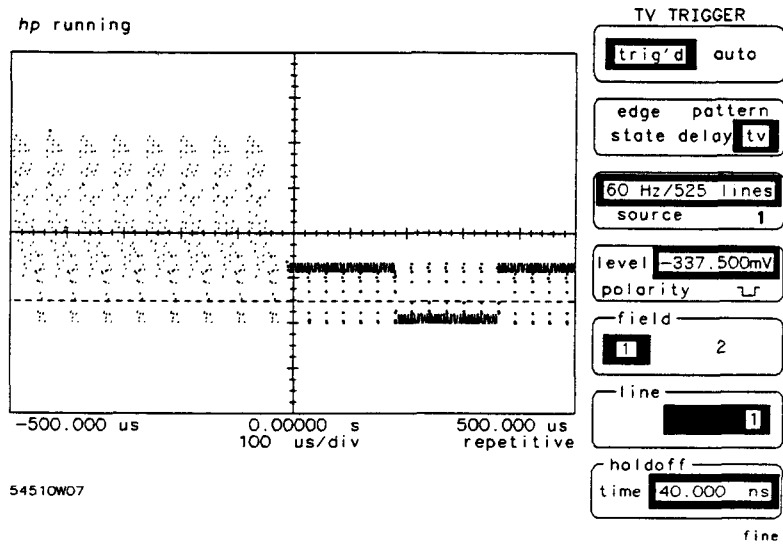

Figure 6-17. Trigger at Field 1, Line 1

The HP 54510A is triggering on the first equalizing pulse of field 1, the first pulse in the vertical interval. The pretrigger data that is being viewed (left half of the screen) is field 2, lines 256-262.

- Set time/division to $10 \mu\text{s}/\text{div}$ and set the trigger to field 1, line 10.

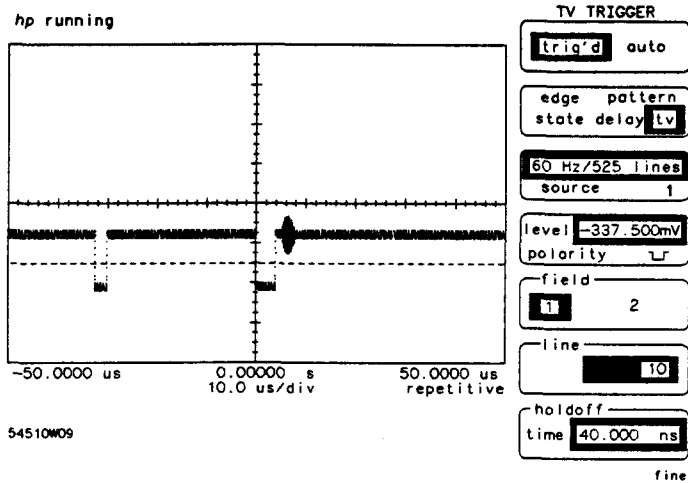

Figure 6-18. Trigger on Field 1, Line 10

The trigger is now on the first horizontal sync pulse in the vertical interval with color burst information.

- Change the trigger point to field 1, line 21.

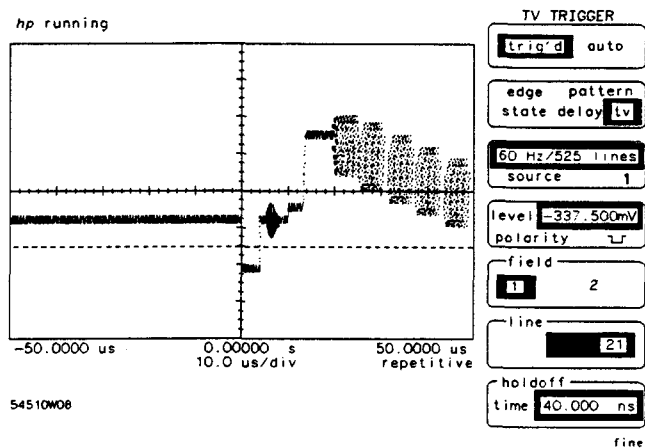

Figure 6-19. Trigger on Field 1, Line 21

The trigger point is now on the last sync pulse of the vertical interval. The next line contains color information, in this case color bars are present.

- Change the trigger to field 2, line 1.

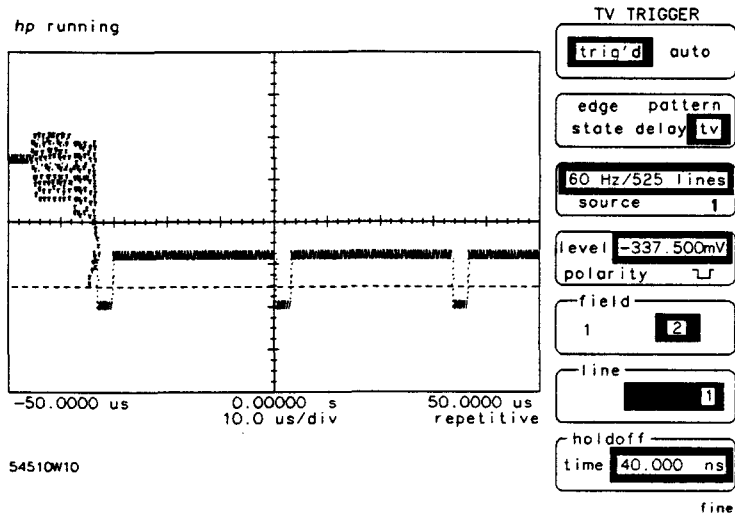

Figure 6-20. Trigger on Field 2, Line 1

The trigger point is on the second sync pulse of the vertical interval. This is the correct trigger point because fields 1 and 2 are interlaced.

Introduction to the Display

The **DISPLAY** menu controls most of the features that dictate how the acquired data is displayed. These features include ways to manipulate data for clarity, to eliminate noise, viewing best case/worst case situations, or the displayed background. There are two display menus, depending on which acquisition mode the oscilloscope is set to in the **TIMEBASE** menu.

This chapter describes the **DISPLAY** menu, the submenus, how to control all the features, and how to display the most meaningful waveform for measurements.

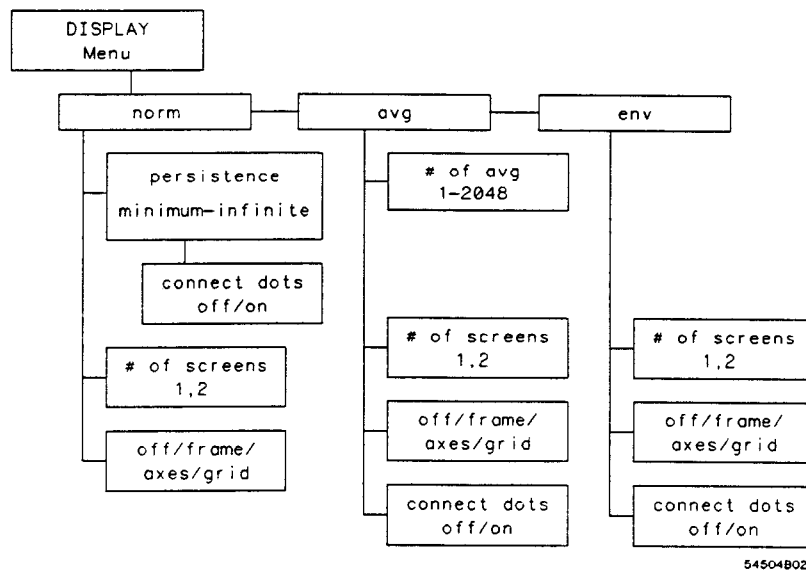
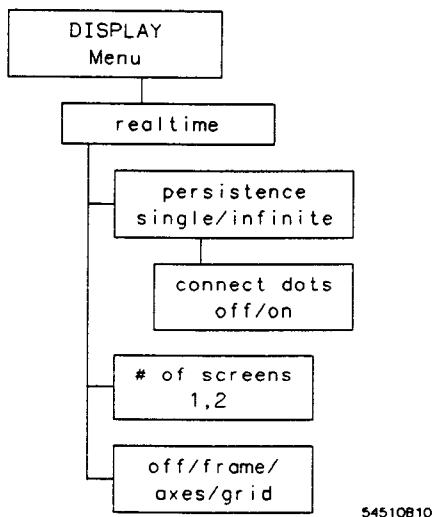

Figure 7-1. Repetitive Acquisition Mode Display Menu



7-2. Realtime Acquisition Mode Display Menu

Display Mode Key

The DISPLAY mode key selects one of three display modes:

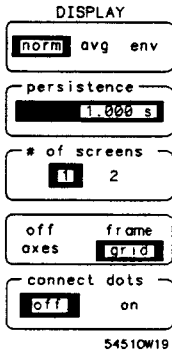

- normal
- averaged
- envelope

norm The **norm** mode sets the time parameters for displaying data or persistence. The range in the variable persistence mode is from minimum, very fast overwriting and updating the display, to infinite with variable settings in between, from 500 ms to 10 seconds. This means that data display records can be preset to any of the persistence settings. Settings less than infinite display data for the specified period of time and then overwrite old data.

In realtime acquisition mode:

- Single or infinite persistence are the two choices during realtime acquisition. Single persistence is very fast overwrite. As each new acquisition is displayed it overwrites the previous data. The current display is always the most recent acquisition.

In repetitive acquisition mode:

- Fast persistence settings are useful when the input signal is changing and immediate feedback is needed.
- More persistence is useful when observing long-term changes in the signal or low signal repetition rates.

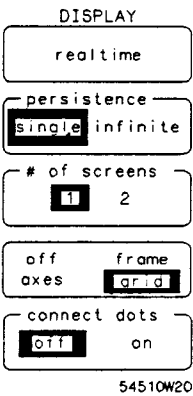

In both acquisition modes:

Infinite persistence can be used for worst-case characterizations of signal noise, jitter, drift, etc. In this mode the HP 54510A is used as a storage oscilloscope.

In repetitive acquisition mode:

At minimum persistence, a point is erased when a new point is acquired in the same time on the display. Therefore, the waveform fills quickly and each point remains for a minimum amount of time.

Note

When the keypad is used to change persistence settings, any entry longer than 10 seconds causes the message value out of range, set to limit to be displayed. Persistence then is automatically set to infinite. Any entry less than 500 ms causes the same message to be displayed and persistence is set to minimum.

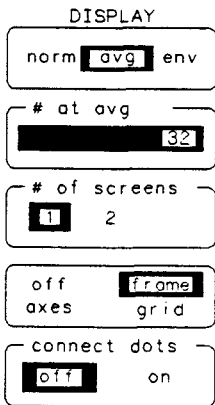

avg

When **norm** is selected, the function key beneath the norm field is activated. This field displays the current persistence setting that can be set using either of the entry devices. Connect-the-dots is available for waveform memories, but not for channels with persistence.

The averaged mode selects the number of waveform acquisitions that are averaged to generate the displayed waveform. The range for the averaging function is 1 to 2048 in powers of 2.

When averaged mode is selected, the next function key is activated and the number of averages is set using either entry keys or knob.

Displayed signal noise is significantly reduced by using the averaging mode. As the number of averages is increased from 1 to 2048, the display becomes less responsive to changes in the input signal(s), however, using more averages reduces the effects of displayed signal noise and improves resolution.

env The envelope mode needs no other parameters set. The display reflects the minimum and maximum voltages in each horizontal position. This is useful in viewing voltage or time jitter.

of screens Key

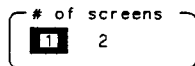
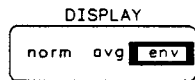

54510W22

The next function key selects the number of screens to be displayed:

- **1:** the entire display area is one screen and any displayed waveforms are superimposed on top of each other.
- **2:** the display area is divided into two screens. Channel 1 is displayed in the top screen and channel 2 is displayed in the bottom screen (See figure 7-2).

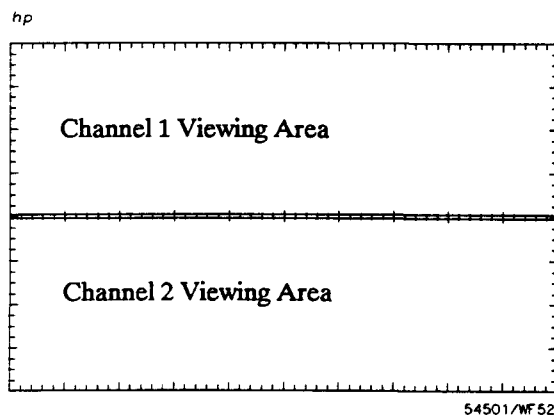

Figure 7-3. Dual Screen Display

**off/frame/
axes/grid Key**

This unlabeled field selects one of four display backgrounds:

- **off:** turns the background graticule off. The displayed waveform and waveform information is not turned off.
- **frame:** displays the outside border with a measurement scale. The measurement scale is incremented/decremented with major divisions and minor divisions based on the vertical and horizontal measurement settings.
- **axes:** displays a background with the measurement scale crossing at mid-screen.
- **grid:** background is a complete graticule with ten horizontal major divisions and eight vertical major divisions. Only the axes portion of the graticule has a minor division scale.

connect dots Key

Connect-the-dots is a technique used to display waveforms with all data points connected. This makes viewing the waveforms easier because the signal is complete and has no breaks. The waveform in figure 7-4 is the same as in figure 6-15 after the connect-the-dots key is on.

Note

Connect-the-dots does not generate data points. The HP 54510A connects data points linearly.

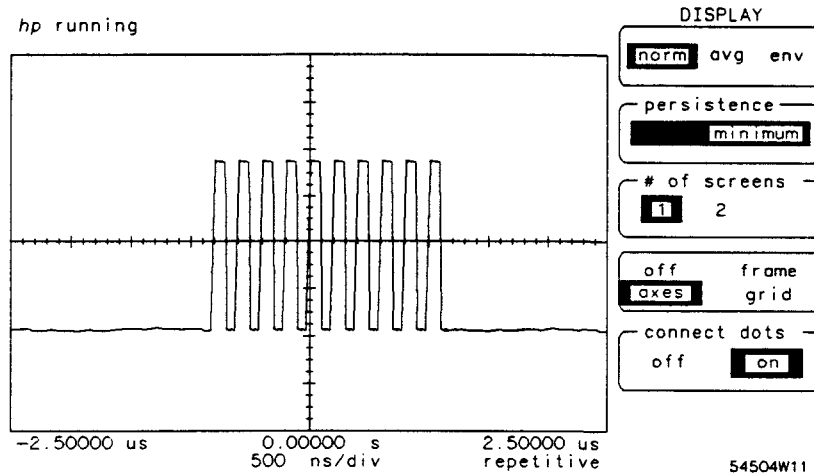

Figure 7-4. Connect the Dots

Introduction to the Markers

This chapter describes how to use the markers and make manual measurements on displayed waveforms.

In this menu, two sets of markers, the ΔV markers (horizontal voltage markers) and the Δt markers (vertical time markers) are controlled. When the desired set of markers have been turned on the two marker fields are turned on. Each marker is individually controlled.

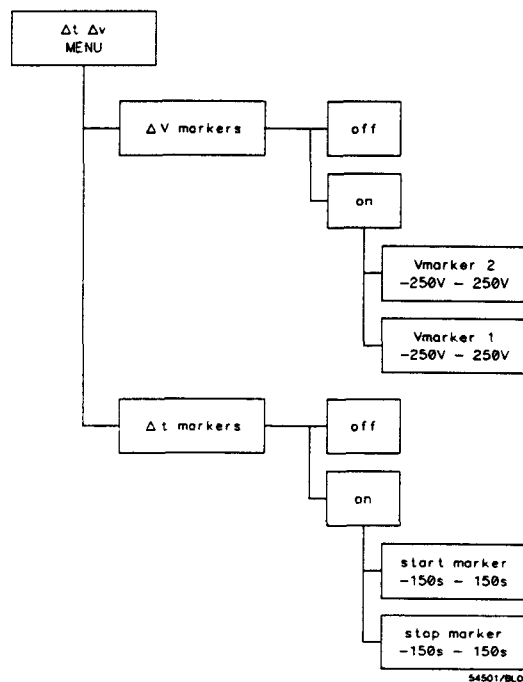
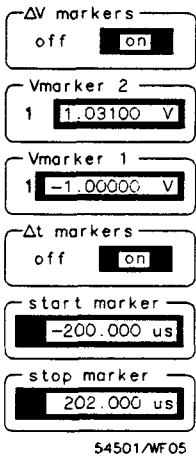
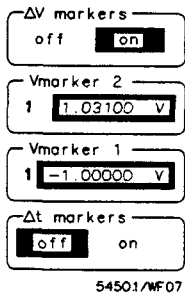

Figure 8-1. Delta t/Delta V Menu

ΔV markers Key



This function key toggles the markers on and off. With the ΔV function turned on the next two fields are activated allowing individual control of the two markers.

When the ΔV markers are turned on, *Vmarker2*, *Vmarker1*, and *delta V* appear in the factors display area. The delta V entry is calculated as the following:

$$\text{Vmarker 2} - \text{Vmarker 1} = \text{delta V}$$

If delta V is negative, Vmarker 1 is located at a more positive voltage level than Vmarker 2.

Vmarker 2 Key

This function key is a two function control field. The first selection is the desired channel, memory, or function to place Vmarker 2 for measurement. By pressing the key again, the highlighted field moves to the numeric display to select the voltage level. Typically, place Vmarker 2 at the desired level on the waveform display and read the level in the highlighted field, and in the factors area of the waveform display.

Vmarker 2 is the voltage marker with shorter dashes.

Vmarker 1 Key

Vmarker 1 operation is identical to Vmarker 2, except it is represented by longer dashes.

Note

The markers can be moved on a selected source even though that source is not displayed. Make sure that the markers are assigned to the proper source to be measured, or the numeric field may be incorrect.

Δt markers Key



This function key toggles the time markers on and off. With the Δt function turned on the next two fields are activated allowing individual control of the two markers.

The markers are placed on the display respective of the trigger point. Positive time values are to the right of the trigger point and negative time values are to the left. Delta t values are determined by the following:

$$\text{stop marker} - \text{start marker} = \text{delta t}$$

There is no such thing as negative delta t, this only means that the start marker is placed later in time than the stop marker.

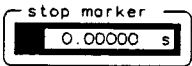
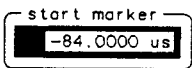

54501/WF64

The inverse of delta t is $1/\text{delta t}$. Since the inverse of time is frequency, this ratio produces an answer in frequency. However, if the markers are placed across parts of a waveform of differing time frames, the answer may not be valid. This feature is useful when looking for the frequency in a burst that is different from the rest of the waveform. Place the time markers across the burst (at similar points on the waveform) to determine the frequency of the burst.

start marker Key To set the start marker, press the function key to highlight the field. This makes the start marker field active. Set the marker with the knob.

The start marker is represented with long dashes.

stop marker Key The stop marker is identical to the start marker, except that it is represented by short dashes.

Introduction to the Functions

The WAVEFORM MATH menu defines one of two math functions. The functions are used on data that is displayed on screen from either channel or from any of the four waveform memories. If data from a channel is used for a function, the channel must be turned on. However, if data from a waveform memory is used for a function, that memory does not have to be displayed.

A function is generated by mathematically manipulating one or two operands with known the following operations:

- plus (+)
- minus (-)
- times (x)
- versus
- only
- invert
- integrate
- differentiate

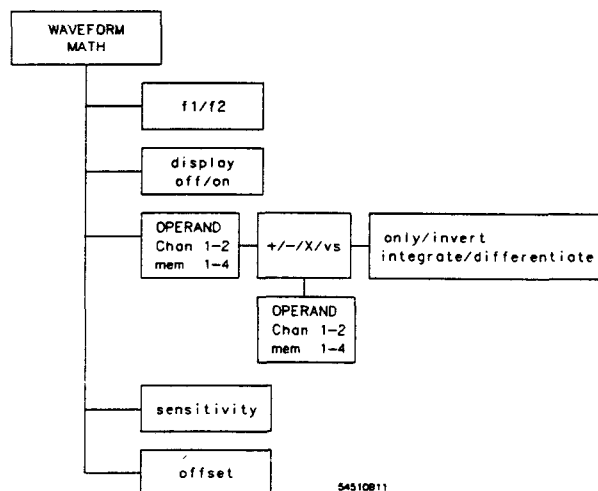

54510B11

Figure 9-1. Waveform Math Menu

The vertical display and offset can be adjusted to place the function for best viewing.

When the function has been calculated, it can be used in the following manners:

- displayed
- evaluated with the measurement features
- stored in memory
- transferred over the HP-IB

Defining a Function

The Waveform Math menu selects and presets any of various operations, sources, and displayed results.

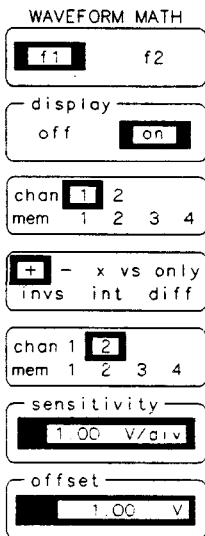

54510W14

Function Key This key selects either function 1 or function 2.

display Key The display key turns the selected function on or off. The vertical sensitivity and offset are displayed in the function menu fields.

The display of the functions depends on the display mode in the DISPLAY MENU. In single display the functions are displayed in one screen. In dual mode display, function 1 is displayed in the top screen and function 2 is displayed in the bottom screen.

operand (chan/mem) Key Press this key to select the first operand of the mathematical operation, or the waveform to be manipulated. The choice can be any displayed channel or any waveform memory that has a waveform stored. Ensure that the channel or memory source is turned on.

If the operator is **only** or **invert**, this is the only operand that may be selected.

Operator Key This key selects any of the six functions. Continue pressing the selection key until the operation desired is highlighted.

- **plus (+)**: the two selected operands are added together. Addition is calculated on a point-by-point basis.
- **minus (-)**: the minus operation subtracts the second operand from the first.
- **times (x)**: the times operation multiplies the value of the first operand by the value of the second operand. Each data point is multiplied with a corresponding data point and the product is placed on the function display. The displayed waveform is scaled to correspond to a different sized waveform.
- **vs (versus)**: the versus function draws a volts versus volts display of the two selected operands. Versus cannot be stored in a waveform memory because measurements cannot be made on the resultant waveform, however, it can be stored in pixel memory. In source x versus source y, the vertical range of source y determines the horizontal range of the vs function.
- **only**: The only function displays the first operand and scales it.
- **invs (inverse)**: The inverse function inverts the data of the first operand.

- **int (integrate):** The integrate function calculates the integral (with respect to time) of the vertical value of the designated operand. Integration proceeds on a point-by-point basis. If a data point is not encountered in the operand, integration uses the next valid data point. Any non-existing data points encountered are not summed, only the available data is integrated. Default scaling is determined by the original operand.
- **diff (differentiate):** The differentiate function calculates the derivative of the designated operand with respect to time. Differentiation proceeds on a point-by-point basis. If a data point is not encountered in the operand, then differentiation uses the next valid data point. Default scaling is determined by the original operand. The differentiation function, by nature, amplifies noise effects. Therefore, differentiation should be applied to signals with high signal-to-noise ratios.

chan/mem Key This key selects the second operand, or the waveform that is manipulated against the first operand. The choices are any of the displayed channels or any of the memories.

This key is not available if the operator is **only** or **invert**.

sensitivity Key The vertical sensitivity of the function is set with this key. This setting is for ease of viewing and making measurements with the newly developed waveform.

offset Key The offset of the function is set with this key.

Vertical Scaling Units

The fundamental measuring units of an oscilloscope are volts/division in the vertical axis and time/division on the horizontal axis. This philosophy is used regardless of the mathematical function chosen. No provisions have been made to manage units for all combinations of operands and operations.

For example, apply a +2V signal to channel 1 and a -3V signal to channel 2. The HP 54510A displays the product as -6V, when in reality it is $-6V^2$.

Displaying Functions

The HP 54510A has two screen variations available to accommodate a 2-channel display, as well as two functions.

- In the single screen mode with a function on, the mathematical results and the operands are displayed using the full display area.

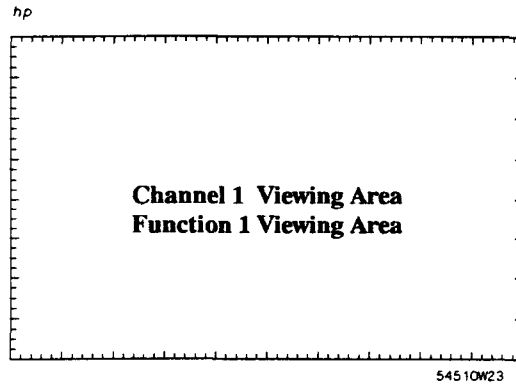
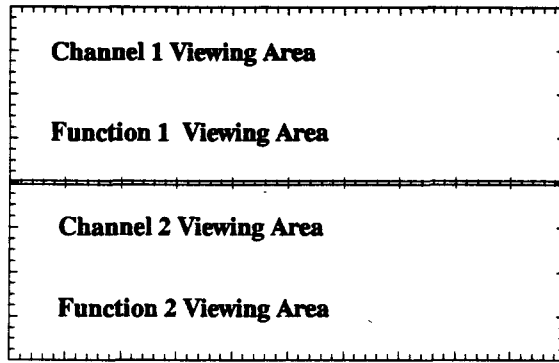

Figure 9-2. Single Screen w/Function On

hp



54501/WF 52

- In the dual screen mode function 1 is displayed in the top half of the screen, and function 2 is displayed in the bottom half.

Waveform Math Exercise

In this exercise the **WAVEFORM MATH** menu is used to subtract one waveform from another.

Instrument Setup Set up an HP 8116A, or a signal generator capable of a 1 MHz, 1 volt squarewave, as follows:

- **MODE** = NORM
- **FRQ** = 1 MHz
- **DTY** = 50%
- **AMP** = 1.00 V
- **OFS** = 0.00 V
- Set the generator for a square wave signal

Connect the signal to a BNC tee on channel 1 using a 1-meter coaxial cable. Connect another 1-meter cable from the other side of the BNC tee and terminate in 50 Ω to channel 2.

Oscilloscope Setup The extra cable length between channels 1 and 2 provides a time delay between the signals on the oscilloscope. The propagation of a 1-meter coaxial cable is approximately 6 to 7 ns. This delay is used to demonstrate the math function.

The following procedure assists in setting up the HP 54510A for optimal viewing.

- Press **AUTOSCALE**.
- Press **DISPLAY** to set the best viewing conditions. Set display mode to *avg*, # of *avg* to 8, # of *screens* to 2.
- Press **WFORM MATH** to define the function. Select *f1* and turn the display on. Select *chan 1*, - (*minus*), *chan 2* and set the function sensitivity to 2.00 V/div.

The function subtracts channel 2 from channel 1. The propagation between channels has allowed a 6 to 7 ns spike. To better view the results:

- Press TIMEBASE and set the horizontal display to 50.0 ns/div (see Figure 9-5) . This display is best viewed when the oscilloscope is in repetitive acquisition mode.

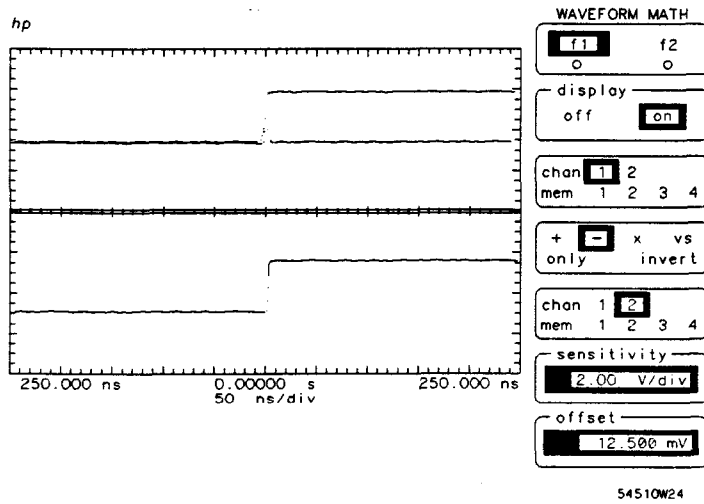

Introduction to the Memories

This chapter describes how to select the waveform and pixel memories on the HP 54510A. The menu consists of two submenus:

- waveform memories m1 - m4 used to store one waveform at a time.
- pixel memories p1 and p2 used as a screen store. In this manner the memories are used as a storage oscilloscope.

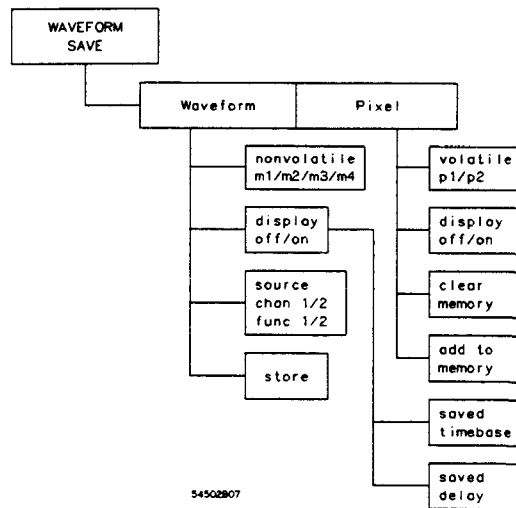
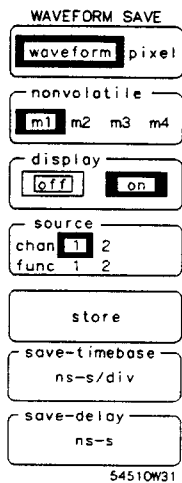

Figure 10-1. Waveform Save Menu

waveform/pixel Key

This is the function key used to choose the desired type of memory. The active menu is highlighted. Each memory type, waveform or pixel, has a separate menu. When this key is pressed, the rest of the menu changes.

waveform Menu



The waveform menu has four available memories, m1, m2, m3, and m4. These memories are nonvolatile and will not be cleared during AUTOSCALE, RECALL CLEAR, or recycling power. This permits disconnection of power and transportation of the oscilloscope without losing the contents of waveform memories.

A waveform memory consists of a single waveform record, including the horizontal and vertical scaling parameters. This allows measurements on previously stored waveform and function data. Voltage and time markers can be set on waveforms when they are displayed however, the time markers follow the TIMEBASE menu time/division and not that of the memory waveform.

When the HP 54510A is in the envelope display mode and a waveform store is executed, the minimum value and maximum value are stored separately. The minimum value will be stored in m1 if m1 or m3 are the selected store locations, or m2 if m2 or m4 are the storage locations. The maximum values are stored in m3 or m4 respectively. A store message is displayed above the waveform display area to show the storage locations of both values.

- nonvolatile Key** This key selects which memory to use. The selections are nonvolatile memories m1, m2, m3 and m4. When a memory is turned on the small circle below the label is highlighted. The waveform memories are record memories that store 8000 points of waveform information in each memory.
- display Key** This key toggles the selected waveform memory display on or off.
- source Key** The source key selects the source waveform to be stored. The source alternatives are any channel or either function.
- store Key** This is the active key in the menu. By pressing this key the specified waveform is stored in the specified memory. When the key is pressed an immediate erase of the selected memory and a write to the memory is executed.

pixel Menu

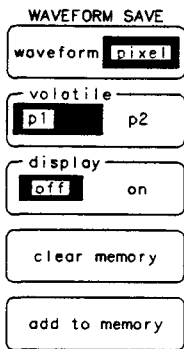

54501/WF 19

The pixel submenu selects the pixel memories. These memories are useful when additive memory capabilities are needed. Waveforms can be stored to and added to indefinitely.

volatile Key This is the memory select key. The alternatives are pixel memory 1 or 2. The pixel memories are complete pixel saves of the waveform area (excluding the graticule and markers) in volatile memory. The waveform display area is 256 by 451 pixels.

In pixel memory the entire screen is saved. Therefore, data is mapped directly onto the display and displayed in halfbright. There are no measurement capabilities on pixel memories.

Pixel memories are additive. When all pixels are full, adding to memory will overwrite existing data.

display Key This key toggles the selected pixel memories on or off.

clear memory Key This key purges all data from the selected pixel memory.

add to memory Key Pressing this key adds the currently displayed waveforms to the specified pixel memory.

Waveform Save Exercise

This exercise demonstrates how a waveform is stored, the offset setting changed, and the stored waveform recalled to be compared with the current display.

Instrument Setup Set up an HP 8116A or a signal generator capable of a 6-kHz, 1-volt squarewave:

- Mode = NORM
- FRQ = 6.00 kHz
- DTY = 50%
- AMP = 1.00 V
- OFS = 0.00 V
- Set the generator for a square wave signal

Oscilloscope Setup This procedure assists in setting up the HP 54510A for optimal viewing.

- Connect this signal to the Channel 1 input.
- Press AUTOSCALE.
- Press WFORM SAVE and select the waveform submenu.
- Press the **nonvolatile** key until **m3** is selected.
- Press the **source** key until **chan 1** is selected.

- Press the **store** key.

The currently displayed waveform is saved in nonvolatile memory **m3**. The remainder of this exercise demonstrates how to recall the stored waveform.

- Press the **display** key to turn on the **m3** display.
- Press the **CHAN** menu key, change the **offset** of channel 1.

This moves the current display so the stored waveform can be viewed. The display should look like figure 10-2.

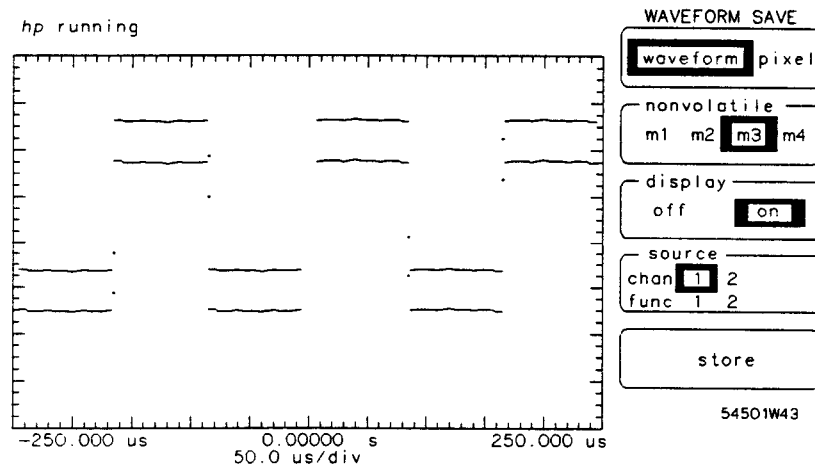

Figure 10-2. Displayed Memory

Introduction to Measurements

This chapter contains a description of the measurement menu. The entire measurement function, with all possible options, is accessed with the **DEFINE MEAS** menu.

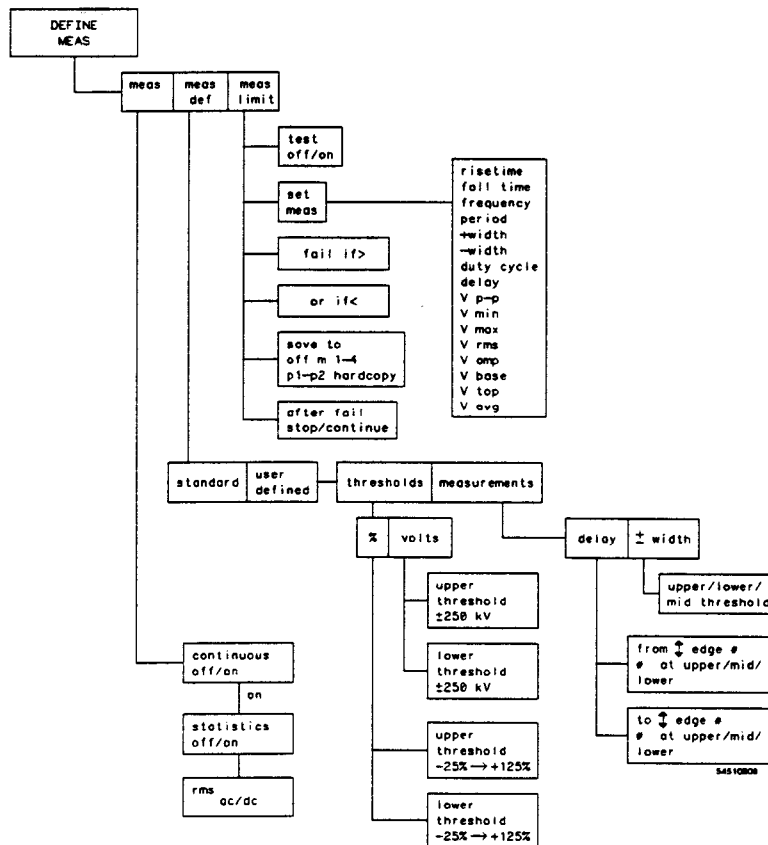

Figure 11-1. Define Measure Menu

The first menu sets the dynamic controls for measurements. The second menu sets user-defined parameters for the measurements. The third menu sets up the measurement comparison test.

Measurement Selection

Each key in the numeric keypad section has a secondary function. Above each key is a measurement selection printed in blue. To make an immediate measurement of the displayed waveform, perform the following keystrokes:

- Press the blue (Shift) key on the numeric keypad to access the secondary keys.
- Press the key that corresponds to the measurement about to be made.
- Rotate the knob to select the measurement source (channel number, c#; memory number, m#; or function number, f#). The choice made is displayed below the waveform display area.
- Press the appropriate number to select the source, channels 1 or 2, memories 1, 2, 3, or 4, or functions 1 or 2.
- Make sure the measurement source is on.

Upon selection of the measurement, the time and voltage markers are placed on the waveform. The markers show where the measurement was made if continuous measurements are off.

To clear measurements, press Shift CLR MEAS.

For complete details of the measurement definitions and algorithms, see Appendix A, "Algorithms."

meas/meas def/meas limit Key

This key is the primary submenu selection key. Press to select one of the available submenus. This field is always the top selection so other submenus may be selected at any time.

meas Submenu

The measure submenu is the default condition. Continuous and statistics options are accessed from this submenu.

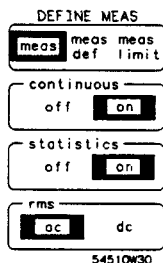

continuous Key If this option is turned on when a measurement selection is made, the displayed measurement is updated periodically. All subsequent measurements are continuously updated when selected.

When **continuous** is off, the measurement is made once, and the $\Delta t/\Delta V$ markers are placed on that measurement showing where the measurement was made.

statistics Key The continuous function must be on before the statistics key is available. When **continuous** is on, statistics display the *min value*, *max value*, *average value*, and *current value* on up to three measurements.

rms Key Select either ac or dc rms voltage with the rms key. The ac rms voltage of the first cycle of the displayed signal is measured when ac is selected. The true rms voltage of the first cycle of the displayed signal is measured when dc is selected. See "Appendix A, Algorithms" for the formulas used to calculate these values.

Measure Define Sub-menu

The Measure Define submenu selects measurement standards assigned by the user. This gives the option of making measurements based on signal width or delay settings or threshold parameters.

standard/user defined Key

If **standard** is selected, no other choices are available and the HP 54510A makes measurements based on IEEE standards.

If, however, **user defined** is selected, two sets of test conditions are available to define the measurements.

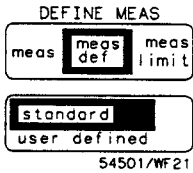

thresholds/measurements Key

This key sets vertical test conditions, voltage or percentage ratios, independent of the horizontal test conditions, edge, slope, and count. Both sets of test conditions must be set to define the measurement.

The **thresholds** submenu sets the following vertical test conditions:

- percentage ratio from - 25% to 125%
- voltage levels from - 250 kV to + 250 kV

Note

The upper and lower thresholds must be set to levels that will fall on the displayed waveform. The message 'not found' is displayed if either threshold is not found on the waveform.

Threshold settings apply to all user-defined front panel measurements.

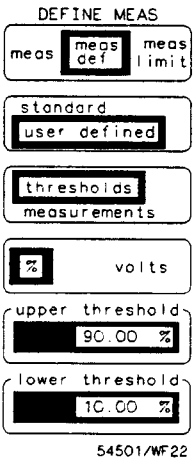

This feature is useful when measuring for excessive overshoot or ringing. By defining the measurements, pass/fail criteria of any choice can be tested. Test from the front panel, or set the HP 54510A in the limit test, and allow the oscilloscope to report without supervision.

Note

If the user-defined upper and lower thresholds are placed too close together, it is possible the HP 54510A will not be able to determine the midpoint. The message 'not found' will be displayed in the measurement factors area.

Measurements define more parameters, the horizontal test conditions, for three specific front panel keypad measurements:

- Delay
- + width
- - width

When any of the three measurements are selected, the measurement is made on the selected edge count, slope, and transition point. The HP 54510A starts counting edges from the left edge of the screen, not at the reference point. The selected edge must be displayed. If the edge is not displayed, the message *not found* is displayed in the measurement results area below the screen.

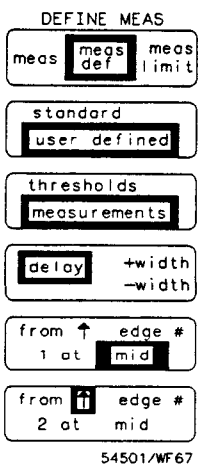

Measurement delay, not to be confused with timebase delay, is useful when measuring source-to-source delays or measuring time separation on the same source or a different source (see chapter 4, "Timebase Menu"). The front panel delay measurement can be redefined by edge slope, edge count (from 1 to 4000), and the part of the transition edge (upper, lower, mid) used as a reference point.

- When setting edge count fields, it is handy to press the fine key. In the course mode the HP 54510A increments/decrements by tens (1, 11, 21,...,4000). In the fine mode the increment/decrement sequence is in 1's.
- When the delay measurement is selected from the front panel, the source (c#, f#, m#) and the source number must also be selected.
- + width allows choice of only the point on the waveform transition (upper, lower, mid) to measure when making the positive width of a displayed waveform.
- – width allows the choice of only the point on the waveform transition (upper, lower, mid) to measure when making the negative width of a displayed waveform.

Measure Limit Submenu

The HP 54510A can run limit tests on up to three measurements. The menu presets certain conditions and stores any failure data for evaluation at a later time. Set the limit test while in this menu and select the measurement from the front panel.

DEFINE MEAS

meas	meas	meas
def		limit

test

off	on
-----	----

set

period

fail if >

50.0000 s

or if <

1.000 ns

save to

off	m1	m2	m3	m4
p1	p2	hardcopy		

after save

stop	continue
------	----------

54504W06

When a test is running, statistical data is displayed describing the test:

- current measurement
- minimum value
- maximum value
- average value

Failure data, as well as information regarding memory and save data is displayed.

Note

At least one measurement (and up to three measurements) must be selected from the keypad. The limit test runs on front-panel measurements.

test Key This key toggles the test routine on or off. When the test is turned on, the oscilloscope starts running in the test mode on the most current measurements that have been selected.

set Key This key selects the measurement. There are sixteen measurements available; these are same ones as are available on the numeric keypad.

- Press the function key to highlight the field and rotate the knob to select the desired measurement.

Note

This key does not select the measurements on which the limit test operates, that selection is made from the keypad with the blue (Shift) key.

fail if > Key This field sets the upper failure threshold. The range on this field is dependent upon the units of the desired measurement.

or if < Key This key sets the lower threshold of the failure parameters.

save to Key This key saves the data associated with the failure to memories or to a hardcopy device. The source of the save is selected in the **WAVEFORM SAVE** menu.

- In the case of saving to nonvolatile memory, one memory may be selected. If multiple failures occur, only the last failure data is saved because the most current data will overwrite the memory contents.
- If the data is saved to pixel memory, an accumulated save occurs. No measurements may be made on the pixel data.
- A save to a printer immediately sends the data to the peripheral device.
- The save to key can be turned off and no save is affected.

after fail Key The test can be stopped when a failure occurs, or it can be continued.

Introduction to the Utilities



The **UTILITY** menu accesses the calibration and service functions, as well as sets up the HP-IB interface. The submenus include self-test, calibration, service, and a listing for the current firmware revision date.

This menu controls all of the service functions that maintain the reliable performance of the oscilloscope.

These submenus are part of the **UTILITY** menu:

- HP-IB menu
- selftest menu
- probe cal menu
- self cal menu
- service menu

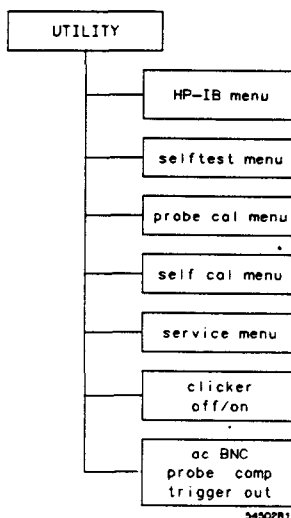

Figure 12-1. Utility Menu

HP-IB menu

The HP-IB submenu makes settings so the HP 54510A can talk to peripheral devices. This interface includes two primary settings:

- Talk-only mode
- Addressed mode

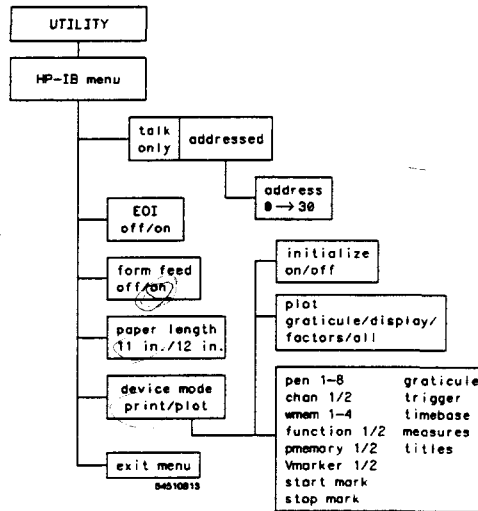
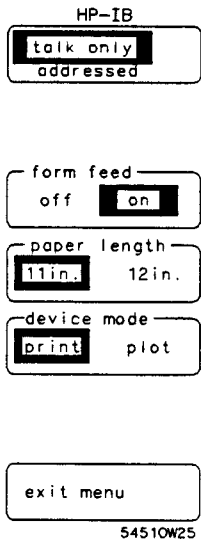

Figure 12-2. HP-IB Menu

talk only mode Set the oscilloscope to **talk only** to perform a hardcopy without intervention from an external controller. The attached printer, or plotter, must be set in the **listen only** or **listen always** mode.

addressed mode This mode selectively addresses the HP 54510A for talking or listening. The address of the HP 54510A can be selected while the instrument is in the addressed mode.

The range of available addresses is 0 through 30.

form feed Key If the form feed option is on, the printer performs a form feed at the end of the hardcopy. If form feed is off, the page is scrolled up four lines when the hardcopy is complete.

paper length Key This key selects between 11-inch or 12-inch pagelengths for auto form feed. The 11-inch page is a U.S. standard and the 12-inch page a U.K. and European standard.

device mode Key This key selects whether the hardcopy goes to a printer or plotter. The HP 54510A sends hardcopy to HP printers and plotters with HP-IB options.

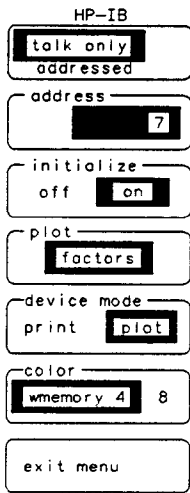

54510W26

The following printers have been tested with the HP 54510A:
 HP 2225A HP-IB ThinkJet, HP 2227B QuietJet, and
 HP 3630A Option 002 PaintJet.

The following plotters have been tested with the HP 54510A:
 HP 7440A Option 002 Color Pro, HP 7470A Option 002, HP 7475A
 Option 002, HP 7550A and HP 9872C.

When plot is selected in device mode, three options appear on the menu. Initialize before plot can be turned on or off and Graticule, Display, Factors, or All, can be chosen for the plot.

In the pen field, nineteen of the display parameters can be selected. Any pen, 1 through 8, can be assigned to the parameter for assorted plotter pen colors or weights. The following parameters can be selected:

channel1	wmemory3	pmemory1	startMark	timebase
channel2	wmemory4	pmemory2	stopMark	measures
wmemory1	function1	graticule	titles	
wmemory2	function2	trigger		

exit menu Key Pressing exit returns the UTILITY menu to the screen.

SELFTEST MENU

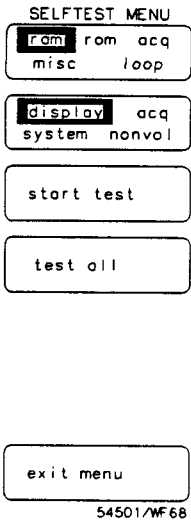

54501/WF68

The HP 54510A is designed to perform internal diagnostics. This selftest submenu tests the oscilloscope to give a high confidence level of instrument functionality. Before starting any self-test, always perform a key-down power-up (RECALL CLEAR). This resets critical parameters to known values to assure erroneous test failures do not occur.

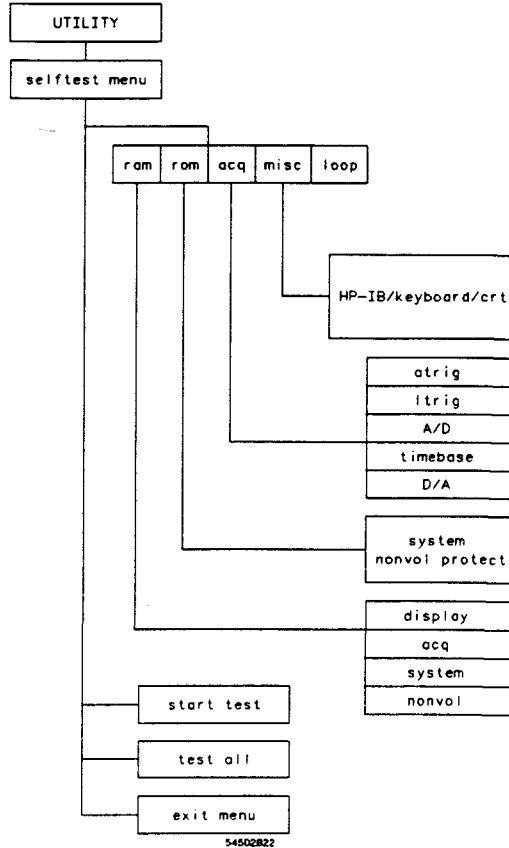

54502822

Figure 12-3. Self-Test Menu

If the HP 54510A fails any self-test, perform the following:

- Recalibrate the oscilloscope.
- If that does not fix the problem, refer to the *HP 54510A Service Manual*.

The HP 54510A self-diagnostics and self-tests, are designed to run operational tests on the following:

- RAM
- ROM
- Acquisition
- Miscellaneous
- Loop for service testing

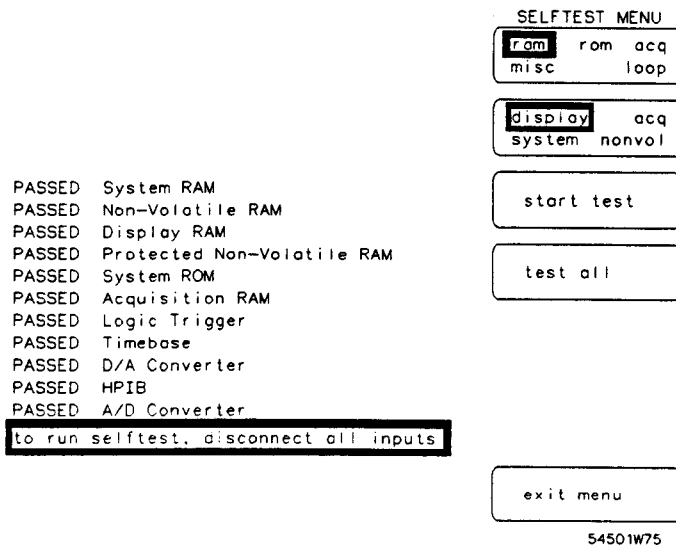

Figure 12-4. Results of Selftest

ram Test The RAM test is a multiple selection field. The options are:

- display
- acquisition
- system
- unprotected nonvolatile memory

rom Test Two ROM tests are available:

- system
- protected nonvolatile memory

acquisition Test Five acquisition tests are available:

- atrig
- ltrig
- A/D
- timebase
- D/A

Miscellaneous Test Three miscellaneous tests are available:

- HP-IB
- keyboard
- CRT

loop Test The loop test is a function designed for use by qualified service personnel. It is unnecessary to use this function for normal oscilloscope operation. When a self-test loop has been initiated it runs until stopped by pressing and holding any key.

start test Key Pressing this key begins the selected test.

test all Key This key runs all tests in sequence.

exit menu Key Pressing this key returns the Utility menu to the screen.

PROBE CAL MENU

Two probe calibration procedures are available in the probe cal menu:

- attenuation
- time null

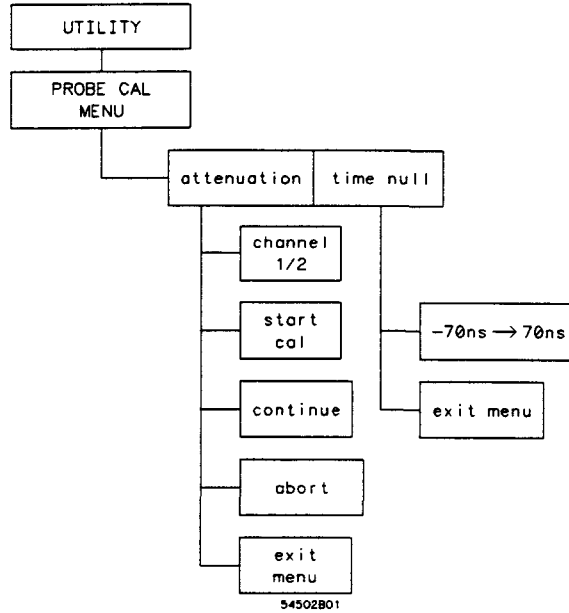
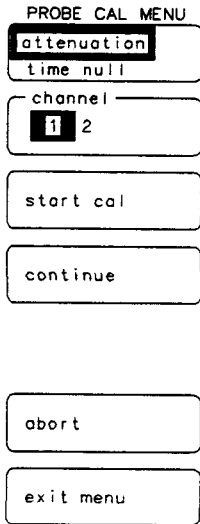

Figure 12-5. Probe Cal Menu

attenuation submenu

The attenuation submenu calibrates channel gain at the probe tip. Channel gain can be corrected through probe attenuation down to 0.9 attenuation.



- Below 0.9 the error message *Attenuation less than 1, see manual for action* is displayed. The corrective action is to recalibrate the HP 54510A.

If the probe is not connected to the DC CALIBRATOR OUTPUT on the rear panel or the probe attenuation exceeds approximately 250, the error message *Attenuation too high or bad connection* is displayed. The corrective action is to check the connections and recalibrate. If recalibration is unsuccessful, refer to the *HP 54510A Service Manual*.

- If the probe attenuation calibration is successful the displayed message is *Probe Attenuation = n.nnnnn This value has been entered into your channel probe setting.*

channel Key Pressing this key selects a channel to calibrate.

start cal Key When the channel to be calibrated has been selected, press **start cal**. The advisory appears at the bottom of the waveform display area *Connect the rear-panel DC CALIBRATOR OUTPUT to the probe of channel n, then press continue*. Pressing this key prompts for setup requirements.

continue Key Press this key when all setup requirements have been satisfied. The actual calibration process begins.

abort Key This is the only active front panel key during the calibration process. The calibration process is terminated with the previous calibration factors intact when this key is pressed.

exit menu Key Pressing this key returns the Utility menu to the screen.

time null submenu Time null sets the timing of all channels to correspond to each other at the probe tip. This eliminates time discrepancies between channels and channel-to-channel skew variations. This is useful to manually adjust any differences in cable length.

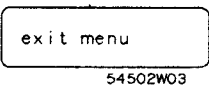
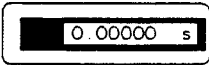
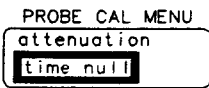

time Key This is an unlabelled field. The time null between the two channels can be set using either of the entry devices. The range is ± 70 ns.

exit menu Key Pressing this key returns to the Utility menu.

Self Cal menu

The self cal menu calibrates two internal functions:

- vertical cal
- delay and repetitive cal

cal select Key This field selects which of the calibration processes to perform. The cal select key and the highlighted window increments through 0-1 and the active field in the display changes to correspond with the selection. See Calibration procedure in this chapter.

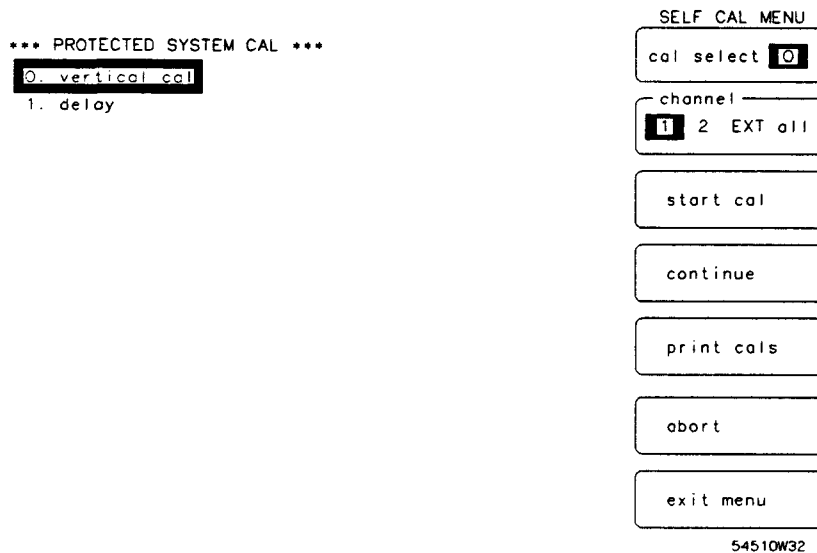

Figure 12-6. Self Cal Options

Note

Cal 0 must pass before Cal 1 can be performed successfully.

- channel Key** The channel key selects the channel to calibrate.
- start cal Key** When the channel to calibrate is selected, and the specific cal routine is selected, press the **start cal** key and follow the instructions displayed.
- print cals Key** The print cals key sends a complete listing of the most recent self calibration factors to a printer, if connected to the oscilloscope. Refer to the service manual for more information on self calibration and calibration factors.
- continue Key** When all of the setup requirements are satisfied, press the **continue** key and the actual calibration process begins.
- abort Key** This is the only active front panel key during the calibration process. Pressing this key terminates the calibration process leaving the previous calibration factors intact.
- exit menu Key** This key returns to the Utility menu.
-

service menu

The service menu is used for firmware calibrations, hardware adjustments, and calibrations that need not be performed often. These are explained in the service manual and are to be used only by qualified service personnel.

Note

When certain calibrations have been performed, other calibrations must be continued. Only qualified service personnel, with access to the service manual, are to perform calibrations in the service menu.

See the *HP 54510A Service Manual* for complete information on the service menu and calibration cycles.

clicker Key

The clicker key turns on the clicker function. When the clicker is turned on, an audible click is heard each time a key is pressed. The selections are either on or off.

ac BNC Key

The ac BNC key selects the output for the rear panel BNC. The probe compensation signal is a square wave of approximately 500 Hz. When trigger out is selected, the BNC is a trigger output.

Calibration Procedure

There are two levels of calibration for the HP 54510A. The first level is in the self cal menu and suggested by HP to be performed under the following conditions:

- at six month intervals or every 1000 hours of use
- if the ambient temperature changes more than 10° C from the temperature at full calibration
- the user would like to optimize measurement accuracy

Self cals do not require any equipment other than cables. It is necessary to UNPROTECT the calibration which may not be allowed in some circumstances. Follow the Self Cal Menu calibration procedures to perform this first level of self cal.

The second level of self calibrations are to be performed only by qualified service personnel with access to the service manual.

Note

Before the HP 54510A can be calibrated the CALIBRATION toggle switch on the rear panel must be set to UNPROTECTED.

The procedure for calibration is:

- Set the rear panel CALIBRATION switch to UNPROTECTED. .
- Select 0 in the cal select field and calibrate the vertical factors. This routine calibrates the A/D, vertical gain, offset, and trigger with the rear panel dc calibrator signal.
- Select 1 in the cal select field and calibrate the delay and the repetitive factors. This procedure uses the rear panel ac calibrator signal.

When the software calibrations are complete reset the CALIBRATION toggle switch on the rear panel to PROTECTED.

One of the primary features of the HP 54510A is the ability to make automatic measurements on displayed waveforms. This chapter provides details on how automatic measurements are calculated and some tips on how to improve results.

Measurement Setup

Measurements typically should be made at the fastest possible sweep speed for the most accurate measurement results. The entire portion of the waveform that is to be measured must be displayed on the oscilloscope. For the most accurate measurements, consider the following conditions:

- at least one complete cycle must be displayed for period or frequency measurements
 - the entire pulse must be displayed for width measurements
 - the leading edge of the waveform must be displayed for risetime measurements
 - the trailing edge of the waveform must be displayed for falltime measurements
-

Making Measurements

If more than one waveform, edge, or pulse is displayed, the measurements are made on the first (leftmost) portion of the displayed waveform that can be used. If there are not enough data points the oscilloscope will display \leq with the measurement results. This is to remind you that the results may not be as accurate as possible. It is recommended that you re-scale the displayed waveform and make your measurement again.

Standard Measurements When any of the standard measurements are requested, the HP 54510A first determines the top-base voltage levels at 100%-0%. From this information, it can determine thresholds (10%, 90%, and 50%) needed to make the measurements. The 10% and 90% thresholds are used in the risetime and falltime measurements. The 50% midpoint is used for measuring frequency, period, pulse width, and duty cycle.

The voltage thresholds are precise settings and sets specific locations on the waveform. If the thresholds are not placed on the waveform (above or below) the HP 54510A cannot make a measurement.

User defined Measurements When any of the user defined measurements are requested, the HP 54510A still must determine the top-base voltage thresholds. From this information it can determine user defined upper and lower thresholds. The mid-point is then determined to be the 50% point between the upper and lower threshold.

Automatic Top-Base

Top-Base is the heart of most automatic measurements. It is used to determine V_{top} and V_{base} , the 0% and 100% voltage levels at the top and the bottom of the waveform. From this information the oscilloscope can determine the 10%, 50%, and 90% points, which are also used in most measurements. The top or base of the waveform is not necessarily the maximum or minimum voltage present on the waveform. Consider a pulse that has slight overshoot. It would be wrong to select the highest point of the waveform as the top since the waveform normally rests below the perturbation.

Top-Base performs a histogram on the waveform and finds the most prevalent point above and below the waveform midpoint. The most prevalent point is one that represents greater than approximately 5% of the total display points (501) and is considered to be either the top or base. If no point accounts for more than 5% of the total, then the top is chosen as the absolute maximum and the base is chosen as the absolute minimum.

Edge Definition

Both rising and falling edges are defined as transitional edges that must cross three thresholds.

A rising edge must cross the lower threshold in a positive direction (defining it as a rising edge), cross the mid threshold (any number of crossings, both positive and negative are permissible) and then cross the upper threshold without any crossing of the lower threshold.

A falling edge must cross the upper threshold in a negative direction, cross the mid threshold (any number of times), and then cross the lower threshold without crossing the upper threshold.

Note

Most time measurements are made based on the position of the first crossing of the middle threshold.

Algorithm Definitions

Following are the definitions that all measurements are based on:

delay There are three types of delay measurement:

- jitter
- standard
- user-defined

Jitter occurs only under the following circumstances:

- standard/user-defined key is set to standard
- two delay parameters are the same
- display mode is envelope

if
first edge on minimum waveform is rising

then
delay = mid-threshold of first rising edge of max waveform minus
mid-threshold of first rising edge on min waveform

else
delay = mid-threshold of first falling edge on min waveform
minus mid-threshold of first falling edge on max waveform

The standard delay measurement occurs when in the standard mode (not user-defined) and is not a jitter measurement.

standard delay = mid-threshold of the first edge of second
parameter minus mid-threshold of the first edge of the first
parameter

Note

Negative delay is possible.

User defined delay = second channel edge minus first channel
edge

+ width The + width algorithm has standard and user-defined considerations.

if
first edge is rising

then
+ width = mid-threshold crossing of first falling edge -
mid-threshold crossing of first rising edge

else
+ width = mid-threshold crossing of second falling edge -
mid-threshold crossing of first rising edge

User-defined is the same as Standard definition except user-defined threshold.

- width The - width algorithm has standard and user-defined considerations:

```
if
  first edge is rising
then
  - width = second rising edge - first falling edge
else
  - width = first rising edge - first falling edge
```

```
Period
if
  first edge is rising
then
  period = second rising edge - first rising edge
```

Frequency frequency = 1/period

Duty Cycle duty cycle = (+ width/period) * 100

Note

+ width is always calculated using mid-threshold.

Risetime risetime = time at upper threshold - time at lower threshold

Falltime falltime = time at lower threshold - time at upper threshold

V_{max} V_{max} = voltage of the maximum point on screen

V_{min} V_{min} = voltage of the minimum point on screen

V_{p-p} V_{p-p} = V_{max} - V_{min}

V_{top} **V_{top} = most prevalent point above waveform midpoint**

V_{base} **V_{base} = most prevalent point below waveform midpoint**

V_{amp} **V_{amp} = V_{top} - V_{base}**

V_{avg} Average voltage of the first cycle of the displayed signal is measured. If a complete cycle is not present the oscilloscope averages all data points.

V_{rms} The rms voltage of the first cycle of the displayed signal is measured. If a complete cycle is not present, the measurement computes rms on all data points. Either ac or dc rms value can be selected in the measure submenu of the Define Measure menu. The ac rms calculation removes the dc component.

~~$$V_{rms(ac)} = \left[\frac{1}{n} \sum_{j=0}^{n-1} (V_n - \frac{1}{m} \sum_{i=0}^{m-1} V_m) \right]^2 \frac{1}{2}$$~~

$$V_{rms(dc)} = \left[\frac{1}{n} \sum_{j=0}^{n-1} (V_n) \right]^2 \frac{1}{2}$$

Integrate

$$I_n = \sum_{i=0}^{n-1} C_i \Delta t$$

The equation is the integral of the channel, where I represents the integral and C represents the channel. The integral is calculated by adding voltage points multiplied by the time bucket width, Δt .

$$V_{rms(ac)} = \left[\frac{1}{n} \left(\sum_{j=0}^{n-1} (V_j^2) \right) - \left(\frac{1}{n} \left(\sum_{j=0}^{n-1} V_j \right) \right)^2 \right] \frac{1}{2}$$

Differentiate $d_1 = 0$

$$d_n = \frac{c_n - c(n-1)}{\Delta t}$$

The equation is the differential waveform of the channel, where d represents the differential and c represents the channel. The differential is the voltage differences between consecutive points in time divided by the time bucket width, Δt .

Instrument Description

The HP 54510A Digitizing Oscilloscope is a general-purpose oscilloscope with 250-MHz bandwidth. It simultaneously digitizes two input channels, each with 8000 samples of memory. The channels have 1 mV to 5 V/div sensitivity in a 1-2-5 sequence. Channel input impedance is 1 M Ω or 50 Ω , switchable.

The time base provides sweep speeds from 1 ns to 5 s/div in a 1-2-5 sequence. Pan and zoom can be used to expand a displayed waveform for a detailed view.

An external trigger input with 1 M Ω or 50 Ω switchable impedance can be combined with the channel triggers for complex triggering functions.

The HP 54510A has an Autoscale feature, 17 automatic pulse parameter measurements, and easy waveform storage. It has full programmability over the HP-IB, and when set up with a printer or plotter, the HP 54510A provides instant hardcopy output.

Accessories Supplied

The following accessories are supplied with the HP 54510A Digitizing Oscilloscope.

- Two HP 10441A miniature passive probes (2 meters)
- One miniature probe to BNC male adapter (HP 1250-1454)
- One 2.3 meter (7.5 feet) power cord (See chapter 2 for available power cords)
- One Front-Panel Reference and Programming Reference Set
- One Service Manual

Accessories Available

The following accessories are available for use with the HP 54510A.

- HP 10437A 1:1 50 Ω probe (2m)
- HP 10438A 1:1 probe (1m)
- HP 10439A 1:1 probe (2m)
- HP 10441A 10:1 1 M Ω probe (2m)
- HP 10002A 50:1 1 M Ω (1000 V peak) probe
- HP 10020A Resistive Divider Probe Kit
- HP 1137A 1000:1 High voltage divider probe
- HP 1133A TV/Video Sync Pod
- HP 1141A Differential Probe
- HP 5061-6175 Rack Mount Kit
- HP 1494-0015 Rack Mount Slide Kit
- HP 1540-1066 Soft Carrying Case
- HP 9211-2645 Transit Case
- HP 5061-6183 Front Panel Cover
- HP 1180A Tilt-tray Testmobile
- HP 92199B Power Strip

Options Available

The following options are available for the HP 54510A.

- Option 908 - Rack Mount Kit (HP 5061-6175)
- Option 910 - Additional Service Manual and Operating and Programming Manual set
- Option 090 - Deletion of probes

Performance Specifications

The following are performance specifications for the HP 54510A Digitizing Oscilloscope.

Vertical Bandwidth (-3dB, dc coupled):¹ dc to 250 MHz

Rise Time:² 1.4 ns

Input R (selectable): 1 M Ω \pm 1% or 50 Ω \pm 1%

Maximum Input Voltage³

1 M Ω : \pm 250 V [dc + peak ac (< 10 kHz)]

50 Ω : 5 V_{rms}

Offset Accuracy:⁴ \pm (1% of channel offset + 2% of full scale)

Voltage Measurement Accuracy (dc) ^{4,5}

Dual Cursor: \pm (1.25% of full scale + 0.032 \times V/div)

Single Cursor: \pm (1.25% of full scale + offset accuracy + 0.016 \times V/div)

Horizontal Delta-t Accuracy⁶

Repetitive (\geq 8 averages): \pm (0.005% \times delta-t + 2E-6 \times delay setting + 100 ps)

Real Time (single acquisition): \pm (0.005% \times delta-t + 2E-6 \times delay setting + 150 ps)

Trigger Trigger Sensitivity⁴

Internal (dc to 50 MHz): 0.5 division

Internal (50 MHz to 250 MHz): 1.0 division

External (dc to 250 MHz): 100 mV_{p-p} into 50 Ω

NOTES:

1. Upper bandwidth reduces by 2.5 MHz for each °C above 35°C. Bandwidth in Repetitive mode is typically greater than 300 MHz.
2. Rise time figures are calculated from: $t_r = 0.35/\text{Bandwidth}$.
3. On ranges ≤ 50 mV/div, the maximum overdrive of the input must not exceed 100 V.
4. Magnification is used below 7 mV/div range so vertical resolution and accuracies are correspondingly reduced. Below 7 mV/div, full scale is defined as 56 mV.
5. Voltage measurement accuracy decreases 0.08% per °C from firmware calibration temperature. This specification is valid for a temperature range $\pm 10^\circ$ from software calibration temperature. Specification applies to both modes; repetitive and realtime (single acquisition).
6. Specification applies at the maximum sampling rate. At lower sampling rates the specification is $\pm (0.005\% \times \text{delta-t} + (2 \times 10^{-6}) \times \text{delay setting} + 0.15 \times \text{sample interval})$ for bandwidth limited signals ($t_r = 1.4 \times \text{sample interval}$). Sample interval is defined as $1/(\text{sample rate})$. Specification also applies to those automatic measurements computing time intervals on identical slope edges (i.e. pos-pos, neg-neg).

**Performance
Characteristics**

The following are performance characteristics of the HP 54510A Digitizing Oscilloscope.

- Vertical** **Switchable Bandwidth Limits**
ac-coupled (lower -3 dB frequency): 90 Hz
LF reject (lower -3 dB frequency): 450 Hz
Bandwidth Limit (upper -3 dB frequency): 30 MHz
- Number of Channels:** 2 (simultaneous acquisition)
- Vertical Sensitivity Range:** 1 mV/div to 5 V/div
- Vertical Gain Accuracy (dc):**^{1,2} $\pm 1.25\%$ of full scale

General Information
B-4

HP 54510A
Front-Panel Reference

Vertical Resolution:² 8 bits over 8 divisions ($\pm 0.4\%$), 10 bits via HP-IB with averaging ($\pm 0.1\%$)

Maximum Sample Rate: 1 GSa/s

Waveform Record Length:³ 8001 points real time, 501 points repetitive

Input C: 7 pF nominal

Input Coupling: ac, dc

Offset Range: Vertical Sensitivity Available Offset

1 mV - 50 mV/div	± 2 V
> 50 mV - 250 mV/div	± 10 V
> 250 mV - 1.25 V/div	± 50 V
> 1.25 V - 5 V/div	± 250 V

Dynamic Range: $\pm 1.5 \times$ full scale from center of screen

Channel-to-channel Isolation (with channels at equal sensitivity):

dc to 50 MHz: 40 dB

50 to 250 MHz: 30 dB

NOTES:

1. Gain accuracy decreases 0.08% of full scale per $^{\circ}\text{C}$ from firmware calibration temperature. This characteristic is valid for a temperature range $\pm 10^{\circ}\text{C}$ from software calibration temperature. Characteristic applies to both modes; repetitive (eight or more averages) and real time (single acquisition).

2. Expansion is used below 7 mV/div range so vertical resolution and accuracies are correspondingly reduced. Below 7 mV/div full scale is defined as 56 mV.

3. Available over HP-IB, waveform record length is:

Real Time-	8,000 points
Repetitive-	500 points

HP 54510A
Front-Panel Reference

General Information
B-5

Horizontal Time Base Range: 1 ns/div to 5 s/div

Time Base Resolution: 20 ps

Delay Range (post-trigger): $10,000 \times (\text{s/div})$

Delay Range:	Time/div Setting	Available Delay
(pretrigger)	100 ns - 5 s/div	$- 160 \times (\text{s/div})$
	1 ns - 50 ns/div	$- 8 \mu\text{s}$

Trigger Trigger Pulse Width (minimum)

Internal: 1.75 ns

External: 2.8 ns

Trigger Level Range

Internal: $\pm 1.5 \times$ full scale from center of screen

External: $\pm 2 \text{ V}$

Operating Characteristics

The following are operating characteristics of the HP 54510A Digitizing Oscilloscope.

Vertical Deflection Factors: Channels 1 and 2: With single screen selected, deflection factors are adjustable from 1 mV/div to 5 V/div in a 1-2-5 sequence with the knob. Fully calibrated vernier adjustments can be made using direct keypad entry or the knob with the FINE key selected.

Probe Attenuation Factors: Values from 0.9 to 1000 may be entered to scale the oscilloscope for external probes or attenuators attached to the channel inputs. When probe tip calibration is done, this value is calculated automatically.

Input Impedance: 1 M Ω or 50 Ω , selectable for CH1, CH2 and EXT TRIG.

Bandwidth Limit (HF Reject): Provides low pass filter with a – 3 dB point at approximately 30 MHz for both triggering and signal display. Can be selected for each vertical input individually.

LF Reject: Provides high pass filter with a – 3 dB point at approximately 450 Hz for triggering and vertical signal. Can be selected for each vertical input individually.

ac Coupling: Provides high-pass filter with a – 3 dB point at approximately 90 Hz for both triggering and signal display. Can be selected for each vertical input individually.

ECL/TTL Presets: Vertical deflection factor, coupling, offset, and trigger level can be preset independently on both channels for ECL and TTL levels.

Effective Resolution: The maximum sample rate and the number of bits in an oscilloscope's digitizer are too often used for comparing oscilloscopes. These specifications, however, do not describe performance under dynamic signal conditions. Effective Resolution is a figure of merit that describes the digitizing oscilloscope's performance under dynamic conditions, and is measured using the sinewave curve fit test. This method considers:

- Quantization error
- Non-linearities(including preamp and A/D)
- System noise
- Frequency of input signal

All of these affect the effective resolution of the instrument. Some manufacturers specify effective bits using half-scale sinewaves. While the effective bits performance using half-scale testing is overstated when compared to full-scale testing, Hewlett-Packard publishes both sets of numbers for the 54510A so that, when comparing effective bits performance between digitizing oscilloscopes, a fair comparison can be made.

The HP 54510A's typical performance for a single acquisition is shown below:

Frequency	50 kHz	1 MHz	20 MHz	50 MHz	100 MHz	250 MHz
Full scale	7.2	6.7	6.3	5.6	5.0	4.9
Half scale	7.4	7.1	7.0	6.4	6.0	5.2

For more information about effective resolution, please contact your Hewlett-Packard sales office, and ask for Product Note 5180A-2, *Dynamic Performance Testing of A to D Converters*, (pub # 02-5952-7629).

Horizontal Pan and Zoom: Changing the Time/div and/or Delay values once acquisition has been stopped allows access to all 8k points of data that are captured on each acquisition (Real-time mode only.)

Delay Between Channels: Difference in delay between channels can be nulled out to compensate for differences in input cables or probe length. Use "time null cal," found in the Probe Cal menu (see UTIL key).

Reference Location: The reference point can be located at the left edge, center, or right edge of the display. The reference point is defined as the trigger point plus the delay time.

Trigger Modes Edge Trigger: Positive or negative edge can be selected for trigger on channels 1 and 2, or on the external trigger input.

Pattern Trigger: A pattern can be specified using channels 1, 2 and the external trigger input. Each of the inputs can be specified as a *high*, *low*, or *don't care* with respect to the level setting in the edge trigger menu. The trigger can be selected to occur on the last edge to enter the specified pattern or the first edge to exit the specified pattern.

Time Qualified Pattern Trigger: A trigger will occur on the first edge to exit a pattern only if it meets the specified time criteria. The available time qualified modes are (user-specified time is in brackets):

- pattern present < [time]
- pattern present > [time]
- range: pattern present > [time1] and < [time2]

The time settings are adjustable from 20 ns to 160 ms ($\pm 3\% \pm 2$ ns). The time filter recovery time is ≤ 12 ns. In the "pattern present < [time]" mode, the pattern must be present for more than 1.75 ns, (2.8 ns for the external trigger) before the trigger will respond.

Glitch Trigger: Use "pattern present < [time]" with [time] selected such that it is just less than the nominal pulse width of the signal you are analyzing. The minimum glitch width is 1.75 ns, (2.8 ns for the external trigger).

State Trigger: A pattern is specified on any two of the three inputs with the third input used as clock. The user may specify that a trigger will occur on the rising or falling edge of the input specified as the clock, when the pattern is present or not present. Setup time for the pattern with respect to the clock is 10 ns or less and hold time is zero.

Delayed Trigger

Event-Delayed Mode: The trigger can be qualified by an edge, pattern, time qualified pattern, or state. The delay can be specified as a number of occurrences of a rising or falling edge of any of the three inputs. After the delay, an occurrence of a rising or falling edge of any of the three inputs will generate the trigger. The trigger occurrence value is selectable from 1 to 16,000,000. The maximum edge counting rate is 70 MHz.

Time-Delayed Mode: The trigger can be qualified by an edge, pattern, or state. The delay is selectable from 30 ns to 160 ms. After the delay, an occurrence of a rising or falling edge of any of the three inputs will generate the trigger. The trigger occurrence value is selectable from 1 to 16,000,000. The maximum edge counting rate is 70 MHz.

TV Trigger 60 Hz / 525 Lines: Trigger source is selected to be any one of the three inputs. Trigger level is adjustable for the selected trigger source. Polarity is selected for positive or negative synchronizing pulses. A trigger occurs on the selected line and field of a 2/1 interlaced composite video signal. Line numbering is 1 to 263 for field 1 and 1 to 262 for field 2. This TV trigger mode is compatible with broadcast standard M.

50 Hz / 625 Lines: Same as 60 Hz / 525 lines except that line numbering is 1 to 313 for field 1 and 314 to 625 for field 2. This TV trigger mode is compatible with broadcast standards B, C, D, G, H, I, K, K1, L, and N.

User-Defined Mode: Source is selected to be any one of the three inputs. Trigger level is adjustable for the selected source. The trigger is qualified with a high or low pulse that meets a selectable time range. The trigger is an occurrence of a rising or falling edge of the source after the qualifying pulse. The time settings for the qualifier are selectable from 20 ns to 160 ms. The trigger occurrence value is selectable from 1 to 16,000,000.

NOTE: *All TV trigger modes require a clamped video signal for stable triggering. Use the HP 1133A TV/Video Sync Pod to provide clamped video output that can be used in conjunction with the HP 54510A's TV triggering capabilities.*

Trigger Holdoff: Trigger can be held off either by time or events over the ranges:

- time: 40 ns - 320 ms
- events: 2 - 16,000,000

An event is defined as the specified trigger condition. A separate holdoff setting (time or events) is available for each trigger mode except delayed trigger, which is set to 40 ns.

Noise Reject Trigger: Provides improved triggering on noisy signals by increasing trigger hysteresis (internal trigger only).

Display **Data Display Resolution:** 451 points horizontally by 256 points vertically.

Number of Screens: 1 or 2 screens can be selected. This can provide overlapping channels or memories for comparison, or separate displays on a split viewing area.

Display Modes **Graticules:** The user may choose full grid, axes, frame, or no graticule.

Connect-the-Dots: Provides a continuous display, connecting the sample points with straight lines. *Connect-the-dots* is operative for modes in which a single-valued waveform can be connected, including average, envelope, single, and minimum-persistence modes. *Connect-the-dots* is not available in the variable or infinite persistence mode.

Time Base In Repetitive Mode

Averaging: The number of averages can be specified in powers of 2, up to 2,048. On each acquisition, $1/n$ times the new data is added to $(n-1)/n$ of the previous value at each time coordinate. Averaging operates continuously, except for the HP-IB *digitize* command, for which averaging terminates at the specified number of averages.

Envelope: Provides a display of the running maximum and minimum voltage levels at each horizontal time position.

Minimum Persistence: One waveform data value is displayed in each horizontal time position of the display. The waveform is updated as new data is acquired for a particular horizontal time position.

Variable Persistence: The time that each data point is retained on the display can be varied from 500 ms to 10 seconds, or the points can be displayed indefinitely.

Time Base in Realtime Mode

Single Persistence: One waveform data value is displayed in each horizontal time position. The entire waveform is replaced with each new acquisition.

Infinite Persistence: Waveform data is allowed to continuously accumulate on the screen, and remains until display is cleared.

Oversampling Filter: On time/division settings when less than 500 points are acquired across the screen (≤ 20 ns/div) a built-in digital filter automatically reconstructs the data. This filter is a combination between a $(\sin X)/X$ and a Gaussian filter.

Delta-t / Delta-V Markers: Dual voltage markers and dual time markers are available. Voltage markers can be independently assigned to channels, memories, or functions.

Waveform Math Two independent functions are provided for waveform math. The operators are +, -, \times , \div , *invertse only*, *integrate*, and *differentiate*. The vertical channels or any of the waveform memories can be used as operands for waveform math. Sensitivity and offset for these functions can be adjusted independently.

Waveform Save The HP 54510A contains four non-volatile waveform memories and two volatile pixel memories. Waveform memories store single-valued waveforms, such as an averaged waveform. If an envelope waveform is stored to a waveform memory, it will automatically be stored with the upper waveform in one waveform memory and the lower waveform in another.

Pixel memories store an entire screen of waveform data. They are useful for storing multiple overlapping waveforms and infinite persistence waveforms. Automatic measurements may be performed on the four non-volatile waveform memories but not on the volatile pixel memories.

Automatic Pulse Parameter Measurements: The HP 54510A offers 17 automatic pulse parameter measurements from the front panel (shown below) and additional measurements via HP-IB including *All*, *Overshoot*, and *Preshoot*. The standard measurements are performed with 10%, 50%, and 90% voltage thresholds, as defined by IEEE standard 194-1977, "IEEE Standard Pulse Terms and Definitions."

Automatic measurements available on the HP 54510A:

Rise time	Pulse Width +	Volts amp	Volts avg	Preshoot (HP-IB only)
Fall time	Pulse width -	Volts base	Volts max	
Frequency	Duty Cycle	Volts top	Volts min	Overshoot (HP-IB only)
Period	Delay	Volts p-p	Volts RMS dc Volts RMS ac	

**User-definable
Measurement
Thresholds**

The HP 54510A allows you to set your own thresholds for automatic measurements. Both the upper and lower thresholds can be set from - 25% to 125%, as long as the upper threshold value is always greater than or equal to the lower threshold. The middle threshold is always equal to the mid-value between the upper and lower threshold.

Continuous Measurements: Can be turned on or off. With continuous measurements off, the voltage and time markers are placed on the waveform to indicate where the last measurement was taken.

Measurement Statistics: The maximum, minimum, average, and most recent of continuously updated measurements are calculated and displayed. Any three measurements can be selected for simultaneous display.

Measurement Limit Test: Maximum and minimum limits can be set for any three of the front-panel automatic measurements. These continuously updated measurements are compared to the maximum and minimum limits. If the measurements are found to be outside the defined limits, the waveform can be stored in a memory or the screen can be sent to a

hardcopy device. In addition, the HP-IB Service Request line can be set to flag the controller. Measurement limit test can be set to stop after test limits have been exceeded, or to continue testing.

Setup Aids **Autoscale:** Pressing the Autoscale button automatically adjusts the vertical and horizontal deflection factors, and the trigger level for a display appropriate to the signals applied to the inputs. The Autoscale feature requires a signal with a duty cycle greater than 0.5% and a frequency greater than 50 Hz. Autoscale is operative only for relatively stable input signals.

Save/Recall: Four front panel setups (1-4) may be saved in non-volatile memory.

Recall Clear: Pressing the RECALL key followed by the CLEAR key resets the HP 54510A to its factory default settings.

Recall 0: If Autoscale, ECL or TTL preset, or recall setup are inadvertently selected, recall 0 restores the instrument to its last state prior to erroneous selection.

Show: Displays instrument status, including volts/div, offset, and trigger condition.

Hardcopy The CRT display, including menus and measurement answers, can be transferred directly to an HP-IB raster graphics printer, including the HP 2225A ThinkJet, HP 2227B QuietJet, or other compatible printers. Hardcopy from HP graphics plotters including the HP 7440A, HP 7470A, HP 7475A, and HP 7550A is also available.

Full HP-IB Programmability The HP 54510A is fully programmable. Instrument settings and operating modes, including automatic measurements, may be remotely programmed via HP-IB (IEEE-488). HP-IB programming complies with IEEE 488.2-1988 "Standard Codes, Formats, Protocols, and Common Commands."

Sequential Single-shot Data Acquisition and Transfer Rate: Using the HP-IB command "Raw Data" the HP 54510A can automatically capture, store, and label a waveform; and re-arm the trigger; and then repeat this process until the HP 54510A's entire 150k RAM (volatile) is filled. Once the specified number of waveforms have been captured and stored, the HP 54510A can transfer the entire block of waveforms to the external computer. Users can specify the number of points to be stored and the number of waveforms to be captured. Repetition rates vary depending on record length and time base setting (slower sampling rates). See figures below.

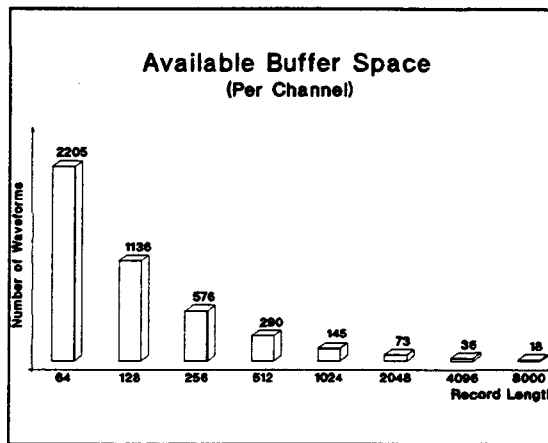
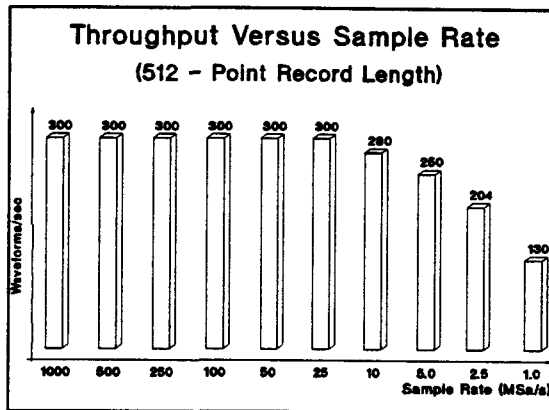
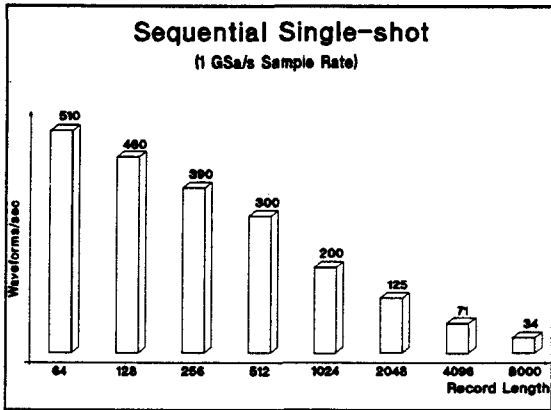

Data Transfer Rate: Approximately 120 kBytes per second.

Probe Compensation, ac Calibrator Output: A 500 Hz (approx.) square wave is provided for probe compensation. A probe-to-BNC adapter is used to connect the probe to the rear panel Probe Compensation BNC output. During instrument self-calibration, this output is used to provide other calibration signals, as described in the Service Manual.

This same BNC connector is used for trigger output. The utility menu allows the user to switch the BNC from probe compensation and calibration signals to a trigger output pulse. The rising edge, with amplitude from approximately -400 mV to 0 V (when terminated into 50 Ω), is synchronous with system trigger. The falling edge of this pulse occurs approximately at the end of holdoff. The rising edge should be used as the edge synchronous with trigger.

dc Calibrator Output: This output is used for vertical calibration of the HP 54510A, as described in the Service Manual.

Product Support **Built in Self-Test and Calibration Routines:** Internal self-test capabilities provide a 90% confidence the instrument is operating properly. External test procedures in the service manual provide a 100% confidence. Self-calibration routines, also selected through the front panel "utility" menu, ensure that the instrument is operating with its greatest accuracy and require no external test equipment.

Low Cost of Ownership: The HP 54510A includes a standard three year, return to HP warranty.

To minimize the mean time to repair and calibration time, the HP 54510A was designed with only one main assembly adjustment per channel. In addition, Hewlett-Packard's board exchange program assures economical and timely repair of units, reducing the cost of ownership.

Reliability: Estimated mean time between failures (MTBF) for the HP 54510A is 30,000 hours. MTBF is computed using an instrument usage of 2,000 hours per year.

Solutions: Hewlett-Packard's System Engineering Organization can help you configure an HP-IB system and provide software support for your application, developing solutions to meet your measurement needs. Contact your HP Sales and Service office for more information.

General Characteristics

Environmental Conditions

Temperature

Operating: 0°C to +55°C (32°F to +131°F)

Non-operating: -40°C to +70°C (-40°F to +158°F)

Humidity

Operating: up to 95% relative humidity (non-condensing) at +40°C (+104°F)

Non-operating: up to 90% relative humidity at +65°C (+149°F)

Altitude

Operating: up to 4,600 meters (15,000 ft)

Non-operating: up to 15,300 meters (50,000 ft)

Vibration

Operating: Random vibration 5-500 Hz, 10 minutes per axis, 0.3 grms.

Non-operating: Random vibration 5-500 Hz, 10 minutes per axis, 2.41 grms. Resonant search 5 to 500 Hz swept sine, 1 Octave/minute sweep rate, (0.75g), 5 minute resonant dwell at 4 resonances per axis.

HP 54510A
Front-Panel Reference

General Information
B-17

Power Requirements Voltage: 115/230 V ac, - 25% to +15%, 48-66 Hz.
Power: 350 VA maximum.

Weight Net: approximately 10 kg (22 lb).
Shipping: approximately 20 kg (44 lb).

Dimensions Refer to the outline drawings below.

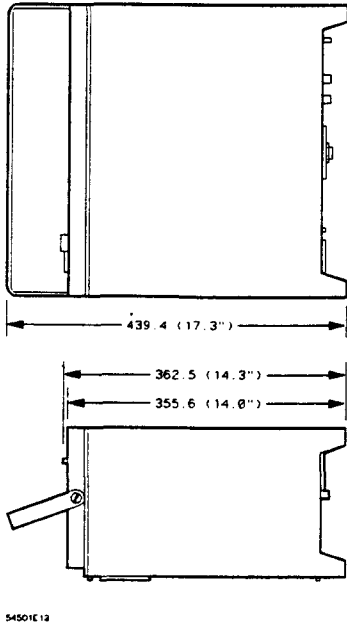

NOTES

1. Dimensions are for general information only. If dimensions are required for building special enclosures, contact your HP field engineer.
2. Dimension are in millimetres and (inches).

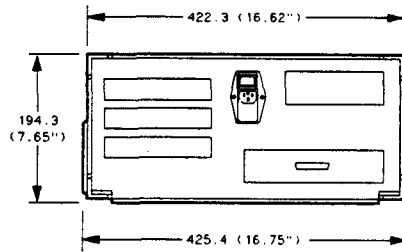

General Information
B-18

HP 54510A
Front-Panel Reference

Index

!

+ width, A-4
- width, A-5

A

A/D acquisition test, 12-6
abort Key, 12-6, 12-8, 12-11
accessories, 2-1
Accessories Available, B-2
Accessories Supplied, B-1
acquisition
 relationship to timebase and sample rate, 4-2
acquisition status, 3-2
acquisition Test, 12-6
acquisition, realtime, 4-4
acquisition, repetitive, 4-4
acquisitions, 4-2
add to memory Key, 10-4
addressed, 12-2
addressed menu, 12-2
after fail Key, 11-8
Air Flow Requirements, 2-7
Algorithms, A-1
alternate function key, 3-9
Altitude, 2-2
atrig acquisition test, 12-6
attenuation submenu, 12-8
auto-trigger, 3-2, 6-3

HP 54510A
Front-Panel Reference

Automatic measurements, 1-1, A-1
Automatic Top-Base, A-2
AUTOSCALE Key, 3-5
Available Accessories, 2-2, B-2
available options, B-2
awaiting trigger, 3-2, 6-3
axes, 7-6

B

blue key, 3-9

C

cable, HP-IB connection, 2-8
cal select Key, 12-10
Calibration Procedure, 12-12
calibrator protection, 2-3
chan/mem Key, 9-3
Channel coupling, SHOW, 3-6
CHANNEL Key, 5-1, 12-8, 12-11
Channel Menu, 5-1
channel offset, 5-2
Channel offset, SHOW, 3-6
Channel scaling, SHOW, 3-6
channel select, 5-2
channel sensitivity, 5-2
characteristics, general, B-17
characteristics, operating, B-6
characteristics, performance, B-4
CLEAR DISPLAY Key, 3-3

Index-1

key (continued)

- FINE, 3-9
- Function, 9-2
- Hardcopy, 3-3
- holdoff, 6-3, 6-10, 6-16, 6-28
- level (adjust/centered), 6-3
- level/polarity, 6-28
- line, 6-28
- Local, 3-3
- meas/meas def/meas limit, 11-3
- more, 5-4
- nonvolatile, 10-2
- off/frame/axes/grid, 7-6
- offset, 9-4
- offset, channel, 5-2
- operand, 9-3
- operator, 9-3
- or if, 11-8
- paper length, 12-3
- pattern, 6-8
- present, 6-16
- probe, 5-4
- qualify on, 6-20
- RECALL, 3-5
- reference, 4-3
- repetitive/realtime, 4-4
- rms (ac,dc), 11-3
- SAVE, 3-6
- sensitivity, 9-4
- sensitivity, channel, 5-2
- set, 11-8
- SHOW, 3-6
- single, 3-3
- slope, 6-3
- source, 6-3, 6-27
- source (waveform save), 10-2
- Standard Select (tv), 6-27
- start cal, 12-8, 12-11
- start test, 12-6
- statistics, 11-3
- store (waveform), 10-2

key (continued)

- test, 11-7
- thresholds/measurements, 11-4
- Time/Div, 4-1
- trigger on, 6-23
- TTL, 5-5
- Vertical Sensitivity, 5-2
- volatile, 10-3
- waveform/pixel, 10-1
- when, 6-9, 6-15
- vertical sensitivity, 5-2
- key features, 1-1
- Key-down power up, 3-11
- keyboard test, 12-6
- knob, 3-8 - 3-9

L

- level adjust Key, 6-3
- level/polarity Key, 6-28
- line Key, 6-28
- Line Switch, 2-5
- line voltage, selecting, 2-4
- LOCAL Key, 3-3
- loop Test, 12-6
- ltrig acquisition test, 12-6

M

- Making Measurements, A-1
- markers, 8-1
- markers after autoscale, 3-5
- markers, time, 8-3
- Math function offset, SHOW, 3-6
- Math function operation, SHOW, 3-6
- Math function scaling, SHOW, 3-6
- meas Sub-menu, 11-3
- meas/meas def/meas limit Key, 11-3

Measure Define, 11-4
Measure Limit, 11-7
measurement limit test after autoscale, 3-5
Measurement Selection, 11-2
Measurement Setup, A-1
measurements after autoscale, 3-5
Memories, SHOW, 3-6
memory bar, 4-5
menu
 channel, 5-1
Menus, 3-7
Menus section, 3-7
Miscellaneous Test, 12-6
more key, 5-4

N

negative delay, 4-3
noise reject Key, 6-3
nonvolatile Key, 10-2
nonvolatile memory, 10-2
of screens, 7-5
numeric keypad, 3-8

O

offset Key, 5-2, 9-4
offset level for ECL, 5-5
offset level for TTL, 5-5
Offset, hysteresis, trigger cal, 12-10
1/delta t, 8-3
Operating Characteristics, B-6
Operating Environment, 2-2, B-17
Operator Key, 9-3
Options Available, B-2
or if Key, 11-8

P

pan and zoom, 4-12
panning, 4-12
panning example, 4-15
paper length Key, 12-3
pattern Key, 6-8
Pattern Trigger Exercise, 6-10
Performance Characteristics, B-4
Performance Specifications, B-3
period, A-5
persistence after autoscale, 3-5
pixel Menu, 10-3
positive delay, 4-3
power input, 2-3
Power Requirements, 2-3
power switch, 2-3
present Key, 6-16
probe attenuation, 5-4
probe attenuation failure, 12-8
Probe attenuation, SHOW, 3-6
probe cal menu, 12-7
probe key, 5-4
product description, 1-1

Q

qualify on
 edge, 6-20
 pattern, 6-21
 state, 6-21
qualify on Key, 6-20

R

- ram test, 12-6
- range, 6-10
- realtime acquisition, 4-4
- Realtime Mode (operating characteristics), B-12
- Rear Panel Layout, 2-3
- RECALL 0, 3-5
- RECALL CLEAR, 3-5, 3-11
- RECALL Key, 3-5
- reference Key, 4-3
- repetitive acquisition, 4-4
- Repetitive Bandwidth, 1-1
- Repetitive Mode (operating characteristics), B-11
- repetitive mode, single-shot exercise, 4-8
- repetitive/realtime Key, 4-4
- reset, 3-11
- risetime, A-5
- risetime measurements, A-1
- rms (ac, dc) Key, 11-3
- rom Test, 12-6
- RUN/STOP Key, 3-2 - 3-3
- running, 3-2

S

- sample rate
 - relationship to acquisition and timebase, 4-2
- SAVE Key, 3-6
- save to Key, 11-8
- selecting line voltage, 2-4
- Self Cal menu, 12-10
- selftest menu, 12-4
- sensitivity (CHANNEL menu), 5-2
- sensitivity Key, 9-4
- service menu, 12-11
- set Key, 11-8

- settings after autoscale, 3-5
- Setup, 3-4
- Setup Aids (operating characteristics), B-14
- SETUP section, 3-4
- shift key, 3-9
- Shipping an instrument, 2-2
- SHOW display, 3-11
- SHOW Key, 3-6
- SINGLE Key, 3-3
- single shot
 - Real Time Mode, 4-11
- single shot
 - Repetitive Mode, 4-8
- single-shot
 - exercise, 4-8
 - single-shot in repetitive mode, 4-8
- slope after autoscale, 3-5
- slope Key, 6-3
- soft reset, 3-5, 3-11
- softkeys, 3-10
- source (trigger) Key, 6-3, 6-27
- source (waveform save) Key, 10-2
- specifications, performance, B-3
- standard + width, A-4
- standard - width, A-5
- Standard Select Key (tv), 6-27
- standard/user defined Key, 11-4
- start cal Key, 12-8, 12-11
- start marker, 8-3
- start test Key, 12-6
- State Trigger Exercise, 6-16
- state Trigger Mode, 6-15
- statistics after autoscale, 3-5
- statistics Key, 11-3
- status message, 3-2
- status of acquisition, 3-2
- stop marker, 8-3
- stopped mode, 3-3
- store (waveform) Key, 10-2
- storing an instrument, 2-2
- supplied accessories, B-1

Index-6

HP 54510A
Front-Panel Reference

sweep speed, time/division function, 4-1
SYSTEM CONTROL keys, 3-2

T

T, trigger point
 position above memory bar, 4-5
talk only, 12-2
talk only menu, 12-2
Test
 acquiiton, 12-6
 loop, 12-6
 ram, 12-6
 rom, 12-6
test Key, 11-7
threshold, 6-1
thresholds/measurements Key, 11-4
time Key, 12-9
time markers, 8-3
time null submenu, 12-9
Time/Div Key, 4-1
timebase acquisition test, 12-6
Timebase Menu, 4-1
timebase setting
 relationship to sample rate and acquisition , 4-2
Trig'd/auto Key, 6-3
trigger
 delay, 6-1, 6-20
 edge, 6-1 - 6-2
 pattern, 6-1, 6-8
 state, 6-1, 6-15
 tv, 6-1, 6-27
trigger characteristics, B-6
trigger edge mode after autoscale, 3-5
trigger level, 6-1
trigger level after autoscale, 3-5
trigger level for ECL, 5-5
trigger level for TTL, 5-5
Trigger level, SHOW, 3-6
Trigger Menu, 6-1

Trigger Modes (operating characteristics), B-8
trigger on Key, 6-23
trigger point in memory bar, 4-5
Trigger source, SHOW, 3-6
trigger specifications, B-3
TTL Key, 5-5
TV Trigger (operating characteristics), B-10
tv Trigger Exercise, 6-29
tv Trigger Mode, 6-27

U

Unpacking the instrument, 2-1
User-definable Measurement Thresholds , B-13
user-defined + width, A-5
Utility Menu, 12-1

V

V/div for ECL, 5-5
V/div for TTL, 5-5
Vamp, A-6
Vavg, A-6
Vbase, A-6
vertical characteristics, B-4
vertical operating characteristics, B-6
vertical position, 5-2
Vertical Resolution, 1-1
vertical sensitivity after autoscale, 3-5
Vertical Sensitivity Key, 5-2
vertical specifications, B-3
vertical offset after autoscale, 3-5
Vmarker 1, 8-2
Vmarker 2, 8-2
Vmax, A-5
Vmin, A-5
volatile Key, 10-3
voltage selector module, 2-3

HP 54510A
Front-Panel Reference

Index-7

Vp-p, A-5
Vrms, A-6
Vrms (ac), A-6
Vrms (dc), A-6
Vtop, A-6

W

Waveform Math (Operating Characteristics), B-12
Waveform Math Exercise, 9-7
waveform math functions, autoscaled, 3-5
Waveform Math Menu, 9-1
waveform Menu, 10-2
Waveform Save (operating characteristics), B-12
Waveform Save Exercise, 10-4
Waveform Save Menu, 10-1
waveform/pixel Key, 10-1
waveform/pixel memory display after autoscale, 3-5
Weight, B-18
when entered, 6-9
when exited, 6-9
when Key (pattern trigger mode), 6-9
when Key (state trigger mode), 6-15
when present, 6-10

Z

zooming, 4-12
zooming example, 4-13

Index-8

HP 54510A
Front-Panel Reference