

# DECLARATION OF CONFORMITY

According to ISO/IEC Guide 22 and CEN/CENELEC EN 45014

**Manufacturer's Name:** Agilent Technologies Japan, Ltd.

**Manufacturer's Address:** 1-3-2, Murotani, Nishi-ku, Kobe-shi,  
Hyogo, 651-2241 Japan

Declares, that the product:

**Product Name:** 4-Channel High Resistance Meter

**Model Number:** 4349B

**Product Options:** This declaration covers all options of the above product

Conforms with the following product standards:

EMC:	Standard	Limit
	IEC 61326-1:1997 +A1:1998 / EN 61326-1:1997 +A1:1998	
	CISPR 11:1997 / EN 55011:1998 / AS/NZS 2064.1/2	Group 1, Class A <sup>(1)</sup>
	IEC 61000-4-2:1995 / EN 61000-4-2:1995 +A1:1998	4 kV CD, 4 kV AD
	IEC 61000-4-3:1995 / EN 61000-4-3:1996 +A1:1998	3 V/m 80% AM 80 - 1000 MHz
	IEC 61000-4-4:1995 / EN 61000-4-4:1995	0.5 kV signal lines, 1 kV power lines
	IEC 61000-4-5:1995 / EN 61000-4-5:1995	0.5 kV line-line, 1 kV line-ground
	IEC 61000-4-6:1996 / EN 61000-4-6:1996	3 V 80% AM 0.15 - 80 MHz
	IEC 61000-4-11:1994 / EN 61000-4-11:1994	1 cycle, 100%
	Canada: ICES-001	
<b>Safety:</b>	IEC 61010-1:1990 +A1:1992 +A2:1995 / EN 61010-1:1993 +A2:1995	
	CAN / CSA C22.2 No. 1010.1-92	

## Conformity / Supplementary Information:

The product herewith complies with the requirements of the Low Voltage Directive 73/23/EEC and the EMC Directive 89/336/EEC (including 93/68/EEC) and carries the CE-marking accordingly (European Union).

LEDs in this product are Class 1 in accordance with EN 60825-1:1994.

<sup>(1)</sup> The product was tested in a typical configuration with Agilent Technologies test systems.

Kobe, Japan      Dec. 15, 2000  
Date

  
Name Koichi Yanagawa / Quality Engineering Manager

For further information, please contact your local Agilent Technologies sales office, agent or distributor.



---

## **Safety Summary**

---

When you notice any of the unusual conditions listed below, immediately terminate operation and disconnect the power cable.

Contact your local Agilent Technologies sales representative or authorized service company for repair of the instrument. If you continue to operate without repairing the instrument, there is a potential fire or shock hazard for the operator.

- Instrument operates abnormally.
- Instrument emits abnormal noise, smell, smoke or a spark-like light during the operation.
- Instrument generates high temperature or electrical shock during operation.
- Power cable, plug, or receptacle on instrument is damaged.
- Foreign substance or liquid has fallen into the instrument.



---

## WARNING

---

The 4349B 4-Channel High Resistance Meter and the 16117E Test Lead provided by Agilent Technologies conform the safety requirements of IEC and CSA, when the 4349B and the 16117E are operated following the description in this *Operation Manual*.

Secure the safety of the measurement system, which you have set up. To secure the safety and to prevent an electrical shock, observe the following safety precautions when the external voltage source outputs a dangerous voltage, more than  $\pm 60\text{Vdc}$  and  $\pm 2\text{ mAdc}$ , defined by the safety requirements of IEC and CSA



- Agilent Technologies recommends you to attach the safety interlock function to the measurement system so that the operator can not touch the parts where dangerous voltage may appear. If not possible, warn the operators and the workers around the measurement system not to touch the parts.
- Use the parts with the safety function to prevent an electrical shock caused by the insulation breakdown, even if dangerous voltage does not appear on the parts directly.
- Turn OFF the output of the external voltage source and discharge the remanent charge of the DUT thoroughly, before touching the measurement system or the DUT where the dangerous voltage may appear.
- Use the power cord shipped with the 4349B and provide an uninterruptible safety earth ground to the instrument.
- Do *not* apply a dc voltage exceeding  $\pm 50\text{V}$  or  $\pm 50\text{ mA}$  to the INPUT terminals.



Confirm the ac line frequency setting of the 4349B.

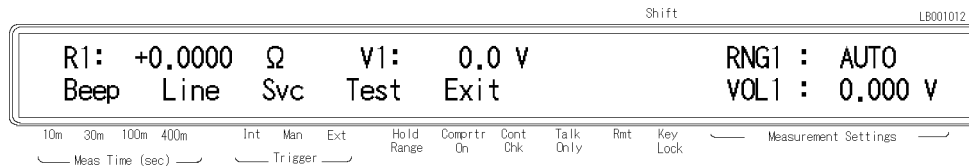

1. Press  .

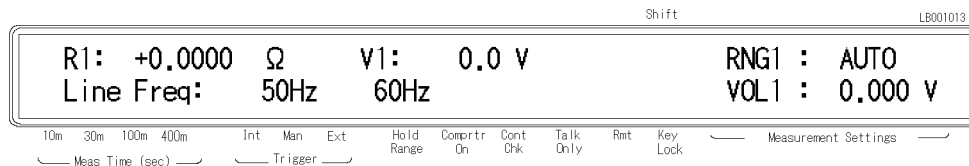

2. Press  until Line blinks, then press .



A blinking item means that it is currently selected.

3. If the setting is not matched to the ac line frequency, press  to toggle the setting between 50 Hz and 60 Hz.
4. Press  two times to exit this menu.

The power line frequency setting is stored and is not changed after reset or power-off. Once you set it, you do not need to set the line frequency as long as the same power line frequency is being used.





# Agilent 4349B 4-Channel High Resistance Meter

# Operation Manual

## SERIAL NUMBERS

This manual applies directly to instruments with serial number prefix JP1KD, or firmware revision 1.04 or greater. For additional important information about serial numbers, read “Serial Number” in Appendix A.



**Agilent Technologies**

Agilent Part No. 04349-90050  
Printed in Japan March 2003

Seventh Edition

---

## Notice

The information contained in this document is subject to change without notice.

This document contains proprietary information that is protected by copyright. All rights are reserved. No part of this document may be photocopied, reproduced, or translated to another language without the prior written consent of the Agilent Technologies.

Agilent Technologies Japan, Ltd.  
Component Test PGU-Kobe  
1-3-2, Murotani, Nishi-ku, Kobe-shi,  
Hyogo, 651-2241 Japan

## Manual Printing History

March 1996 .....	First Edition (part number: 04349-90010)
December 1996 .....	Second Edition (part number: 04349-90020)
June 1998 .....	Third Edition (part number: 04349-90030)
August 1998 .....	Fourth Edition (part number: 04349-90040)
March 2000 .....	Fifth Edition (part number: 04349-90040)
January 2001 .....	Sixth Edition (part number: 04349-90040)
March 2003 .....	Seventh Edition (part number: 04349-90050)

---

## Safety Summary

The following general safety precautions must be observed during all phases of operation, service, and repair of this instrument. Failure to comply with these precautions or with specific **WARNINGS** elsewhere in this manual may impair the protection provided by the equipment. In addition it violates safety standards of design, manufacture, and intended use of the instrument.

*The Agilent Technologies assumes no liability for the customer's failure to comply with these requirements.*

---

**Note** 4349B comply with INSTALLATION CATEGORY II and POLLUTION DEGREE 2 in IEC1010-1. 4349B are INDOOR USE product.



---

**Note** LEDs in 4349B are Class 1 in accordance with IEC825-1. CLASS 1 LED PRODUCT



---

### Ground The Instrument

To avoid electric shock hazard, the instrument chassis and cabinet must be connected to a safety earth ground by the supplied power cable with earth blade.

### DO NOT Operate In An Explosive Atmosphere

Do not operate the instrument in the presence of flammable gasses or fumes. Operation of any electrical instrument in such an environment constitutes a definite safety hazard.

### Keep Away From Live Circuits

Operating personnel must not remove instrument covers. Component replacement and internal adjustments must be made by qualified maintenance personnel. Do not replace components with the power cable connected. Under certain conditions, dangerous voltages may exist even with the power cable removed. To avoid injuries, always disconnect power and discharge circuits before touching them.

### DO NOT Service Or Adjust Alone

Do not attempt internal service or adjustment unless another person, capable of rendering first aid and resuscitation, is present.

### DO NOT Substitute Parts Or Modify Instrument

Because of the danger of introducing additional hazards, do not install substitute parts or perform unauthorized modifications to the instrument. Return the instrument to a Agilent Technologies Sales and Service Office for service and repair to ensure that safety features are maintained.

## Dangerous Procedure Warnings

**Warnings** , such as the example below, precede potentially dangerous procedures throughout this manual. Instructions contained in the warnings must be followed.

---

**Warning**



**Dangerous voltages, capable of causing death, are present in this instrument. Use extreme caution when handling, testing, and adjusting this instrument.**

---

---

## Certification

Agilent Technologies certifies that this product met its published specifications at the time of shipment from the factory. Agilent Technologies further certifies that its calibration measurements are traceable to the United States National Institute of Standards and Technology, to the extent allowed by the Institution's calibration facility, or to the calibration facilities of other International Standards Organization members.

---

## Warranty

This Agilent Technologies instrument product is warranted against defects in material and workmanship for a period of one year from the date of shipment, except that in the case of certain components listed in *General Information* of this manual, the warranty shall be for the specified period. During the warranty period, Agilent Technologies will, at its option, either repair or replace products that prove to be defective.

For warranty service or repair, this product must be returned to a service facility designated by Agilent Technologies. Buyer shall prepay shipping charges to Agilent Technologies and Agilent Technologies shall pay shipping charges to return the product to Buyer. However, Buyer shall pay all shipping charges, duties, and taxes for products returned to Agilent Technologies from another country.

Agilent Technologies warrants that its software and firmware designated by Agilent Technologies for use with an instrument will execute its programming instruction when properly installed on that instrument. Agilent Technologies does not warrant that the operation of the instrument, or software, or firmware will be uninterrupted or error free.

---

## Limitation Of Warranty

The foregoing warranty shall not apply to defects resulting from improper or inadequate maintenance by Buyer, Buyer-supplied software or interfacing, unauthorized modification or misuse, operation outside the environmental specifications for the product, or improper site preparation or maintenance.

*No other warranty is expressed or implied. Agilent Technologies specifically disclaims the implied warranties of merchantability and fitness for a particular purpose.*

## **Exclusive Remedies**

*The remedies provided herein are buyer's sole and exclusive remedies. Agilent Technologies shall not be liable for any direct, indirect, special, incidental, or consequential damages, whether based on contract, tort, or any other legal theory.*

---

## **Assistance**

Product maintenance agreements and other customer assistance agreements are available for Agilent Technologies products.

For any assistance, contact your nearest Agilent Technologies Sales and Service Office. Addresses are provided at the back of this manual.

## Safety Symbols

General definitions of safety symbols used on equipment or in manuals are listed below.



Instruction manual symbol: the product is marked with this symbol when it is necessary for the user to refer to the instruction manual.



Alternating current.



Direct current.



On (Supply).



Off (Supply).



Frame or chassis terminal

### Warning



This **Warning** sign denotes a hazard. It calls attention to a procedure, practice, condition or the like, which, if not correctly performed or adhered to, could result in injury or death to personnel.

### Caution



This **Caution** sign denotes a hazard. It calls attention to a procedure, practice, condition or the like, which, if not correctly performed or adhered to, could result in damage to or destruction of part or all of the product.

### Note



**Note** denotes important information. It calls attention to a procedure, practice, condition or the like, which is essential to highlight.



## **Herstellerbescheinigung**

GERXISCHEMISSION

LpA < 70 dB  
am Arbeitsplatz  
normaler Betrieb  
nach DIN 45635 T. 19

---

## **Manufacturer's Declaration**

ACOUSTIC NOISE EMISSION

LpA < 70 dB  
operator position  
normal operation  
per ISO 7779

---

## Contents of this Manual

### **Chapter 1, Getting Started**

Provides the product overview and basic measurement procedure. First time users of the 4349B should read this chapter first.

### **Chapter 2, Operating the 4349B**

Shows how to operate the 4349B from its front panel. Refer to this chapter when you wish to learn about operations using the front panel keys.

### **Chapter 3, Function Reference**

Describes all functions of this instrument. Refer to this chapter when you wish to learn about the functions of the front and rear panel keys and terminals.

### **Chapter 4, Remote Operation**

Shows how to remotely operate the 4349B. Refer to this chapter when you wish to learn about the procedures for remotely operating the 4349B via the GPIB.

### **Chapter 5, GPIB Reference**

Contains complete information on remotely operating the 4349B via the GPIB. Refer to this chapter when you wish to learn about the GPIB commands, status reporting mechanism, trigger system, and data transmission format.

### **Chapter 6, Application Measurement**

Provides a measurement example using the 4349B.

### **Chapter 7, Measurement Basics**

Provides information for effective operations.

### **Chapter 8, General Information**

Provides specifications, reference data, and other general information.

### **Chapter 9, Maintenance**

Describes how to verify the specifications.

## **4349B**

### **Appendix A, Manual Changes**

Contains information on using the 4349Bs which were manufactured before this manual was printed.

### **Appendix B, Handler Interface Installation**

Contains information which is required for using the handler interface. Before using the handler interface, read this appendix and set the handler interface input/output signal.

### **Appendix C, Overload/No-Contact Operations**



The summary of operations when the 4349B detects OVL (Overload), or N.C. (No-Contact).



# Contents

---

## 1. Getting Started





















 Introduction . . . . .	1-1
Overview . . . . .	1-2
Features . . . . .	1-2
Accessories Available . . . . .	1-3
Options Available . . . . .	1-3
Front Panel . . . . .	1-4
Display . . . . .	1-6
Rear Panel . . . . .	1-7
Initial Inspection . . . . .	1-8
Providing clearance to dissipate heat at installation site . . . . .	1-8
Instruction for Cleaning . . . . .	1-8
Power Cable . . . . .	1-9
Preparation for Use . . . . .	1-11
Power Requirements . . . . .	1-11
 Fuse . . . . .	1-11
Turning ON the 4349B . . . . .	1-12
Using Front Panel Keys . . . . .	1-13
Direct Execution Keys . . . . .	1-13
Toggle Keys . . . . .	1-13
Selection Keys . . . . .	1-13
Value Setup Keys . . . . .	1-14
Numeric Keys . . . . .	1-14
Maximum and Minimum Keys . . . . .	1-15
Left/Down and Right/Up Arrow Keys . . . . .	1-15
Back Space Key . . . . .	1-15
If you have any problems . . . . .	1-16

## 2. Operating the 4349B

Introduction . . . . .	2-1
External Voltage Source . . . . .	2-2
Test Leads . . . . .	2-2
Specifications . . . . .	2-2
 Installation . . . . .	2-3
Measurement Configuration . . . . .	2-5
To Reset the 4349B . . . . .	2-5
To Perform the OPEN Correction Function . . . . .	2-5
To Select a Measurement Parameter . . . . .	2-5
To Select the Channel . . . . .	2-6
To Enter the Voltage Value . . . . .	2-6
To Select the Measurement Range . . . . .	2-6
To Select the Measurement Time Mode . . . . .	2-7
To Set the Averaging Rate . . . . .	2-7

To Set the Trigger Delay Time . . . . .	2-7
To Set the Contact Check . . . . .	2-8
Reading the Limit Data of Contact Check Function . . . . .	2-9
Reading the Capacitance Data at DUT Measurement . . . . .	2-10
To Set the Beeper Mode . . . . .	2-10
Saving and Recalling Instrument Settings . . . . .	2-11
Making a Measurement . . . . .	2-12
Triggering a Measurement . . . . .	2-12
To Use the Comparator Function . . . . .	2-12
To Select the Display Mode and Display Digits . . . . .	2-14
To Change the Measurement Settings Display . . . . .	2-14
Locking Out the Front Panel Keys . . . . .	2-15
Selecting Local Mode . . . . .	2-15
Setting the GPIB Address . . . . .	2-15
Printing Measurement Data . . . . .	2-15
To Test the 4349B . . . . .	2-16
Performing a Self-Test . . . . .	2-16
Testing the Front Panel Keys' Functionality . . . . .	2-16
If Your 4349B Has a Problem . . . . .	2-17
If the Display is Blank and the 4349B Appears Dead . . . . .	2-17
If an Error Message is Displayed . . . . .	2-17
If the 4349B does not Accept Any Key Input . . . . .	2-17
If the Resistance Value Is Always 0 $\Omega$ . . . . .	2-17

### 3. Function Reference

Introduction . . . . .	3-1
Front Panel . . . . .	3-2
Display . . . . .	3-2
LINE Switch . . . . .	3-3
Chassis Terminal . . . . .	3-3
⚠ INPUT (Ch1, Ch2, Ch3, and Ch4) Terminals . . . . .	3-3
Channel key  . . . . .	3-4
Voltage Entry Key  . . . . .	3-4
Measurement Time Key  . . . . .	3-4
Average Key   . . . . .	3-4
Measurement Parameter Key  . . . . .	3-4
Show Setting Key  . . . . .	3-4
Display Mode Key   . . . . .	3-5
Auto/Hold Range Key  . . . . .	3-5
Range Setup Key   . . . . .	3-5
Comparator Limit Key   . . . . .	3-5
Trigger Key  . . . . .	3-6
Local Key  . . . . .	3-6
Address Key   . . . . .	3-6
Trigger Mode Key  . . . . .	3-6
Delay Key   . . . . .	3-7

Save Key		3-7
Recall Key		3-7
Right/Up Arrow Key and Left/Down Arrow Key	 	3-7
0, . . . , 9, .(point), -(minus) Key	   	3-7
BLUE Shift Key		3-7
Exponential Key		3-8
Back Space Key		3-8
Enter Key		3-8
Minimum Key		3-8
Maximum Key		3-8
Comparator Key		3-8
Contact Check Key		3-9
Open Key		3-9
Key Lock Key		3-9
Reset Key		3-10
Configuration Key		3-11
Rear Panel		3-12
External Trigger		3-12
LINE Fuse Holder		3-13
LINE Voltage Selector		3-13
Serial Number Plate		3-13
Power Cord Receptacle		3-13
Power Cord		3-13
Handler Interface		3-14
Specifications		3-14
GPIB Interface		3-18
Theory of Operation		3-19
Overall Measurement Theory		3-19
Overall Block Diagram		3-20
Contact check feature		3-21
<b>4. Remote Operation</b>		
Introduction		4-1
Getting Started		4-2
Input/Output Statements		4-2
Reading the GPIB Address		4-2
Sending a Remote Command		4-2
Returning to Local Mode		4-3
Query Commands		4-3
Getting Data from the 4349B		4-3
To Control the 4349B from an External Computer		4-4
To Set Up the 4349B		4-5
To Reset the 4349B		4-5
To Set the LINE Frequency		4-5
To Perform the OPEN Correction		4-5
To Select the Measurement Parameter		4-5

To Enter Voltage Value . . . . .	4-6
To Select the Measurement Range . . . . .	4-6
To Set the Measurement Time Mode . . . . .	4-6
To Set the Averaging rate . . . . .	4-7
To Set the Trigger Delay time . . . . .	4-7
To Perform the Contact Check . . . . .	4-7
To Set the Beeper Mode . . . . .	4-7
To Lock Out the Front Panel Keys . . . . .	4-7
To Use the Comparator Function . . . . .	4-8
To Wait Until Previously Sent Commands are Completed . . . . .	4-8
To Get the Current Instrument Settings . . . . .	4-9
To Save and Recall Instrument Settings . . . . .	4-9
To Trigger a Measurement . . . . .	4-10
To Retrieve Data Efficiently . . . . .	4-12
To Transfer Data Using the Real Data Format . . . . .	4-12
To Use Data Buffer . . . . .	4-12
Other Features . . . . .	4-13
To test the 4349B . . . . .	4-13
To Report the Instrument's Status . . . . .	4-13
If You Have a Problem . . . . .	4-15
If the 4349B Hangs Up When You Send the ABORt Command . . . . .	4-15

## 5. GPIB Reference

Introduction . . . . .	5-1
GPIB Commands . . . . .	5-1
Common Commands . . . . .	5-1
Subsystem Commands . . . . .	5-1
Subsystem Command Tree . . . . .	5-4
Program Message Syntax . . . . .	5-5
Case . . . . .	5-5
Program Message Terminator . . . . .	5-5
Subsystem Command Syntax . . . . .	5-5
Common Command Syntax . . . . .	5-5
Parameters . . . . .	5-5
Parameter Types . . . . .	5-6
Suffix . . . . .	5-7
Multiple Messages . . . . .	5-7
Query and Response Message Syntax . . . . .	5-7
Command Reference . . . . .	5-8
Notations . . . . .	5-8
ABORt Command . . . . .	5-9
:ABORt . . . . .	5-9
CALCulate Subsystem . . . . .	5-10
:CALCulate{1 2 3 4}:LIMit:BEEPer:CONDition { FAIL   PASS } . . . . .	5-10
:CALCulate{1 2 3 4}:LIMit:BEEPer[:STATe] { ON   OFF   1   0 } . . . . .	5-10
:CALCulate{1 2 3 4}:LIMit:CLEar . . . . .	5-11
:CALCulate{1 2 3 4}:LIMit:FAIL? . . . . .	5-11
:CALCulate{1 2 3 4}:LIMit:LOWer[:DATA] <numeric_value> . . . . .	5-11
:CALCulate{1 2 3 4}:LIMit:LOWer:STATe { ON   OFF   1   0 } . . . . .	5-11
:CALCulate{1 2 3 4}:LIMit:STATe { ON   OFF   1   0 } . . . . .	5-11
:CALCulate{1 2 3 4}:LIMit:UPPer[:DATA] <numeric_value> . . . . .	5-12
:CALCulate{1 2 3 4}:LIMit:UPPer:STATe { ON   OFF   1   0 } . . . . .	5-12
CALCulate{1 2 3 4}:PATH? . . . . .	5-12
DATA Subsystem . . . . .	5-13
:DATA[:DATA]? DBUF . . . . .	5-13



:DATA:FEED DBUF,< <i>data_handle</i> > . . . . .	5-14
:DATA:FEED:CONTRol DBUF,{ALWays NEVer} . . . . .	5-14
:DATA:POINts DBUF,< <i>numeric_value</i> > . . . . .	5-14
DISPlay Subsystem . . . . .	5-15
:DISPlay:ENABle { ON   OFF   1   0 } . . . . .	5-15
:DISPlay:WINDow{1 2 3 4}[:STATe] { ON   OFF   1   0 } . . . . .	5-15
:DISPlay:WINDow{1 2 3 4}:TEXT1:PAGE { 1   2 } . . . . .	5-15
:DISPlay:WINDow{1 2 3 4}:TEXT1:DIGit { 3   4   5 } . . . . .	5-16
:DISPlay:WINDow{1 2 3 4}:TEXT2:PAGE { 1   2   3 } . . . . .	5-16
FETCh? Query . . . . .	5-17
:FETCh? . . . . .	5-17
FORMat Subsystem . . . . .	5-18
:FORMat[:DATA] { ASCii   REAL[,64] } . . . . .	5-18
INITiate Subsystem . . . . .	5-19
:INITiate[:IMMediate] . . . . .	5-19
:INITiate:CONTinuous { ON   OFF   1   0 } . . . . .	5-19
SENSe Subsystem . . . . .	5-20
[:SENSe]:AVERage:COUNt < <i>numeric_value</i> > . . . . .	5-20
[:SENSe]:AVERage[:STATe] { ON   OFF   1   0 } . . . . .	5-20
[:SENSe]:CORRection:COLLect[:ACQuire] OFFSet . . . . .	5-20
[:SENSe]:CORRection:DATA{1 2 3 4}? OFFSet . . . . .	5-21
[:SENSe]:CORRection:DATA{1 2 3 4}? SCAPacitance . . . . .	5-21
[:SENSe]:CORRection[:STATe] { ON   OFF   1   0 } . . . . .	5-21
[:SENSe]:CONTact:DATA{1 2 3 4}? . . . . .	5-21
[:SENSe]:CONTact:LIMit{1 2 3 4}? . . . . .	5-21
[:SENSe]:CONTact:OFFSet{1 2 3 4} < <i>numeric_value</i> > . . . . .	5-22
[:SENSe]:CONTact:VERify { ON   OFF   1   0 } . . . . .	5-22
[:SENSe]:CURRent:APERture < <i>numeric_value</i> >[MS S] . . . . .	5-22
[:SENSe]:CURRent:RANGe{1 2 3 4}:AUTO { ON   OFF   1   0 } . . . . .	5-23
[:SENSe]:CURRent:RANGe{1 2 3 4}[:UPPer] < <i>numeric_value</i> >[PA NA UA MA A] . . . . .	5-23
[:SENSe]:FUNCTion < <i>sensor_function</i> > . . . . .	5-23
SOURce Subsystem . . . . .	5-24
:SOURce:VOLTage{1 2 3 4}[:LEVel][:IMMediate][:AMPLitude] < <i>numeric_value</i> > . . . . .	5-24
STATus Subsystem . . . . .	5-25
:STATus:OPERation[:EVENT]? . . . . .	5-25
:STATus:OPERation:CONDition? . . . . .	5-25
:STATus:OPERation:ENABle < <i>numeric_value</i> > . . . . .	5-25
:STATus:PRESet . . . . .	5-26
:STATus:QUEStionable[:EVENT]? . . . . .	5-26
:STATus:QUEStionable:CONDition? . . . . .	5-26
:STATus:QUEStionable:ENABle < <i>numeric_value</i> > . . . . .	5-26
SYSTem Subsystem . . . . .	5-27
:SYSTem:BEEPer[:IMMediate] . . . . .	5-27
:SYSTem:BEEPer:STATe { ON   OFF   1   0 } . . . . .	5-27
:SYSTem:ERRor? . . . . .	5-27
:SYSTem:KLOCK { ON   OFF   1   0 } . . . . .	5-27
:SYSTem:LFRequency < <i>numeric_value</i> > . . . . .	5-27
:SYSTem:PRESet . . . . .	5-28
:SYSTem:VERSion? . . . . .	5-28
TRIGger Subsystem . . . . .	5-29
:TRIGger:DELay < <i>numeric_value</i> >[MS S] . . . . .	5-29
:TRIGger[:IMMediate] . . . . .	5-29
:TRIGger:SOURce { BUS   EXTernal   INTernal   MANual } . . . . .	5-29
Common Commands . . . . .	5-30
*CLS . . . . .	5-30

*ESE <numeric_value>	5-30
*ESE?	5-30
*ESR?	5-30
*IDN?	5-30
*LRN?	5-30
*OPC	5-30
*OPC?	5-31
*OPT?	5-31
*RCL <numeric_value>	5-31
*RST	5-31
*SAV <numeric_value>	5-31
*SRE <numeric_value>	5-31
*SRE?	5-31
*STB?	5-32
*TRG	5-32
*TST?	5-32
*WAI	5-32
Status Reporting Structure	5-33
Service Request (SRQ)	5-33
Status Byte Register	5-34
Standard Event Status Register	5-35
Standard Operation Status Group	5-36
Operation Status Register	5-37
Questionable Status Register	5-37
Trigger System	5-38
4349B Trigger System Configuration	5-38
Idle State	5-38
Initiate State	5-39
Event Detection State	5-39
Sequence Operation State	5-39
Data Transfer Format	5-40
AScii	5-40
REAL	5-41

## 6. Application Measurement

 Introduction	6-1
High Throughput Measurement	6-2
Multi Test Voltages Measurement	6-5
Note on Measuring Insulation Resistance of Capacitors	6-8
The External DC Voltage Source	6-8
How to Select the Optimum Measurement Range	6-8
Additional Error Due to Voltage Source Noise	6-10
How to Reduce the Measurement Error	6-11
Precharge Time and Wait Time	6-12

<b>7. Measurement Basics</b>	
Introduction . . . . .	7-1
Insulation Resistance Measurement . . . . .	7-1
Residual Charge Effect . . . . .	7-1
Absorption Phenomena . . . . .	7-1
Voltage Coefficient and Temperature Coefficient . . . . .	7-1
Shielding . . . . .	7-2
<b>8. General Information</b>	
Introduction . . . . .	8-1
Specifications . . . . .	8-2
Measurement Parameters . . . . .	8-2
Measurement Conditions . . . . .	8-2
Measurement Range . . . . .	8-3
Measurement Accuracy . . . . .	8-3
Measurement Support Functions . . . . .	8-5
General . . . . .	8-6
Supplemental Performance Characteristics . . . . .	8-7
Typical Measurement Accuracy . . . . .	8-7
Measurable Capacitance Range . . . . .	8-8
Additional Error Due To the Voltage Source Noise . . . . .	8-9
Additional Error Reduction by Connecting a Series Resistor . . . . .	8-12
Measurement Time . . . . .	8-15
Consumption Memory Duration . . . . .	8-15
Contact Check Effective Range . . . . .	8-16
<b>9. Maintenance</b>	
Introduction . . . . .	9-1
Test Equipment . . . . .	9-1
Performance Tests . . . . .	9-2
Introduction . . . . .	9-2
Test Equipment . . . . .	9-2
Calculation Sheet . . . . .	9-2
Performance Test Record . . . . .	9-2
Calibration Cycle . . . . .	9-2
Ammeter Offset Voltage and Input Resistance Test . . . . .	9-3
Specifications . . . . .	9-3
Test Equipment . . . . .	9-3
Procedure . . . . .	9-3
Ammeter Offset Voltage Test . . . . .	9-3
Ammeter Input Resistance Test . . . . .	9-4
Current Measurement Accuracy Test . . . . .	9-6
Specification . . . . .	9-6
Test Equipment . . . . .	9-6
Procedure . . . . .	9-6
Resistance Measurement Accuracy Test . . . . .	9-9
Specification . . . . .	9-9
Test Equipment . . . . .	9-9
Procedure . . . . .	9-9
Calculation Sheet . . . . .	9-12
Ammeter Input Resistance Test (Channel 1) . . . . .	9-12
Ammeter Input Resistance Test (Channel 2) . . . . .	9-12
Ammeter Input Resistance Test (Channel 3) . . . . .	9-12
Ammeter Input Resistance Test (Channel 4) . . . . .	9-12
RC Box Calibration Values . . . . .	9-12

Current Measurement Accuracy Test (Channel 1) . . . . .	9-13
Current Measurement Accuracy Test (Channel 2) . . . . .	9-13
Current Measurement Accuracy Test (Channel 3) . . . . .	9-14
Current Measurement Accuracy Test (Channel 4) . . . . .	9-14
Resistance Measurement Accuracy Test (Channel 1) . . . . .	9-15
Resistance Measurement Accuracy Test (Channel 2) . . . . .	9-15
Resistance Measurement Accuracy Test (Channel 3) . . . . .	9-16
Resistance Measurement Accuracy Test (Channel 4) . . . . .	9-16
Performance Test Record . . . . .	9-17
Ammeter Offset Voltage and Input Resistance Test (Channel 1) . . . . .	9-18
Current Measurement Accuracy Test (Channel 1) . . . . .	9-18
Resistance Measurement Accuracy Test (Channel 1) . . . . .	9-18
Ammeter Offset Voltage and Input Resistance Test (Channel 2) . . . . .	9-19
Current Measurement Accuracy Test (Channel 2) . . . . .	9-19
Resistance Measurement Accuracy Test (Channel 2) . . . . .	9-19
Ammeter Offset Voltage and Input Resistance Test (Channel 3) . . . . .	9-20
Current Measurement Accuracy Test (Channel 3) . . . . .	9-20
Resistance Measurement Accuracy Test (Channel 3) . . . . .	9-20
Ammeter Offset Voltage and Input Resistance Test (Channel 4) . . . . .	9-21
Current Measurement Accuracy Test (Channel 4) . . . . .	9-21
Resistance Measurement Accuracy Test (Channel 4) . . . . .	9-21
Functional Test . . . . .	9-22
Introduction . . . . .	9-22
Test Equipment . . . . .	9-22
Handler Interface Functional Test . . . . .	9-23
Test Equipment . . . . .	9-23
Procedure . . . . .	9-23
Initial Setup . . . . .	9-23
Key Lock Function Test . . . . .	9-23
External Trigger Function Test . . . . .	9-23
Handler Interface Output Test . . . . .	9-24
Contact Check Functional Test . . . . .	9-25
Test Equipment . . . . .	9-25
Procedure . . . . .	9-25
<b>A. Manual Changes</b>	
Introduction . . . . .	A-1
Manual Changes . . . . .	A-1
Serial Number . . . . .	A-2
Change 1 . . . . .	A-3
Change 2 . . . . .	A-4
<b>B. Handler Interface Installation</b>	
Introduction . . . . .	B-1
Electrical Characteristics . . . . .	B-1
Output Signals . . . . .	B-1
Input Signals . . . . .	B-3
Setting Up the Handler Interface Board . . . . .	B-5
Tools and Fasteners . . . . .	B-5
Procedure . . . . .	B-5

**C. Overload/No-Contact Operations**

**Messages**

Instrument Errors . . . . . Messages-2  
GPIB Errors . . . . . Messages-3

**Index**

# Figures

---

1-1. Power Cable Supplied . . . . .	1-10
2-1. 16117E Test Lead . . . . .	2-2
2-2. Typical Measurement System . . . . .	2-3
3-1. Front Panel . . . . .	3-2
3-2. Rear Panel . . . . .	3-12
3-3. Required External Trigger Pulse Specification . . . . .	3-12
3-4. Pin Assignment For Handler Interface Connector . . . . .	3-14
3-5. Timing Diagram . . . . .	3-17
3-6. Simplified Model of the 4349B . . . . .	3-19
3-7. 4349A Overall Block Diagram . . . . .	3-20
3-8. . . . .	3-21
3-9. . . . .	3-21
4-1. Simple Resistance Measurement Program Example . . . . .	4-4
5-1. Proper Use of the Colon and Semicolon . . . . .	5-4
5-2. Status Reporting Structure . . . . .	5-33
5-3. Status byte Register . . . . .	5-34
5-4. Standard Event Status Register . . . . .	5-35
5-5. Standard Operation Status Group Structure . . . . .	5-36
5-6. Trigger System Configuration . . . . .	5-38
5-7. Inside an Event Detection State . . . . .	5-39
5-8. NR1 Format . . . . .	5-40
5-9. NR2 Format . . . . .	5-40
5-10. NR3 Format . . . . .	5-40
5-11. Real Data Format . . . . .	5-41
6-1. High Throughput Measurement System . . . . .	6-2
6-2. High Throughput Measurement Sample Program . . . . .	6-4
6-3. Multi Test Voltage Measurement System . . . . .	6-5
6-4. Multi Test Voltage Measurement Sample Program . . . . .	6-7
6-5. Additional Error Due to Voltage Source Noise . . . . .	6-10
6-6. 10% Additional Error . . . . .	6-11
6-7. Precharge Time . . . . .	6-12
6-8. Wait Time . . . . .	6-13
8-1. Resistance to Current Conversion Diagram . . . . .	8-3
8-2. Current Measurement Additional Error (Measurement Time:10 msec) . . . . .	8-9
8-3. Current Measurement Additional Error (Measurement Time:30 msec) . . . . .	8-10
8-4. Current Measurement Additional Error (Measurement Time:100 msec) . . . . .	8-10
8-5. Current Measurement Additional Error (Measurement Time:400 msec) . . . . .	8-11
8-6. 10 % Additional Error (Measurement Time: 10 msec) . . . . .	8-12
8-7. 10 % Additional Error (Measurement Time: 30 msec) . . . . .	8-13
8-8. 10 % Additional Error (Measurement Time: 100 msec) . . . . .	8-13
8-9. 10 % Additional Error (Measurement Time: 400 msec) . . . . .	8-14
8-10. Relation Between $C_x$ and Cable Capacitance $C_{ig}$ . . . . .	8-16
9-1. Ammeter Offset Voltage Test Setup . . . . .	9-3
9-2. Ammeter Input Resistance Test Setup Using DC Power Supply . . . . .	9-4
9-3. Ammeter Input Resistance Test Setup Using DC Voltage Calibrator . . . . .	9-5
9-4. Current Measurement Accuracy Test Setup . . . . .	9-6

9-5. Current Measurement Accuracy Test Setup Using DC Power Supply . . . . .	9-7
9-6. Current Measurement Accuracy Test Setup Using DC Voltage Calibrator . . . . .	9-7
9-7. Resistance Measurement Accuracy Test Setup . . . . .	9-9
9-8. Resistance Measurement Accuracy Test Setup Using DC Power Supply . . . . .	9-10
9-9. Resistance Measurement Accuracy Test Setup Using DC Voltage Calibrator . . . . .	9-10
9-10. Handler Interface Functional Test Setup . . . . .	9-23
9-11. Handler interface Output Order . . . . .	9-24
9-12. Contact Check Functional Test Setup . . . . .	9-25
A-1. Serial Number Plate . . . . .	A-2
B-1. Handler Interface Comparison Output Signals Diagram . . . . .	B-2
B-2. Handler Interface Control Output Signals Diagram . . . . .	B-3
B-3. Handler Interface Input Signal Diagram . . . . .	B-4
B-4. A1 Main Board . . . . .	B-8

# Tables

---

1-1. Power Voltage Selector Setting . . . . .	1-11
3-1. Reset Settings . . . . .	3-10
3-2. Line Voltage selection . . . . .	3-13
3-3. Contact Assignment for Comparator Function . . . . .	3-15
3-4. GPIB Interface Capability . . . . .	3-18
5-1. Suffix Multiplier . . . . .	5-7
5-2. Status Byte Assignments . . . . .	5-34
5-3. Standard Event Status Register Assignments . . . . .	5-35
5-4. Operation Status Register Assignments . . . . .	5-37
5-5. Questionable Status Register Assignments . . . . .	5-37
6-1. Measurable DC Current and Capacitance in Each Range . . . . .	6-9
8-1. Measurement Accuracy . . . . .	8-4
8-2. Measurable Current Range and Measurable Capacitance Range . . . . .	8-8
9-1. Required Equipment . . . . .	9-1
9-2. Substitute Equipment for Reference Voltage . . . . .	9-1
9-3. Current Measurement Accuracy Test Settings . . . . .	9-8
9-4. Resistance Measurement Accuracy Test Settings . . . . .	9-11
A-1. Manual Changes by Serial Number . . . . .	A-1
A-2. Manual Changes by ROM Version . . . . .	A-1
A-3. OVLN/N.C. Operations (Meas. parameter: R) . . . . .	A-4
A-4. OVLN/N.C. Operations(Meas. parameter: I) . . . . .	A-4
B-1. Handler Output Electrical Characteristics . . . . .	B-1
B-2. Handler Input Electrical Characteristics . . . . .	B-3
B-3. Pull-up Resistor Locations . . . . .	B-9
C-1. OVLN/N.C. Operations (Meas. parameter: R) . . . . .	C-1
C-2. OVLN/N.C. Operations(Meas. parameter: I) . . . . .	C-2





## Getting Started

### Introduction

This chapter provides information to get you started using your 4349B 4-Channel High Resistance Meter. This chapter discusses the following topics:

- Overview
- Initial Inspection
- Ventilation Requirements
- Instruction for Cleaning
- Power Cable
- Preparation for Use
- Using the Front-Panel Keys

**Caution**  Do *not* apply a dc voltage exceeding  $\pm 50$  V or  $\pm 50$  mA to the INPUT terminals, or the 4349B's input circuits will be destroyed. Connect a current limiting resistor to avoid the over current when a shorted device is connected. Refer to " Installation" in Chapter 2 for details.

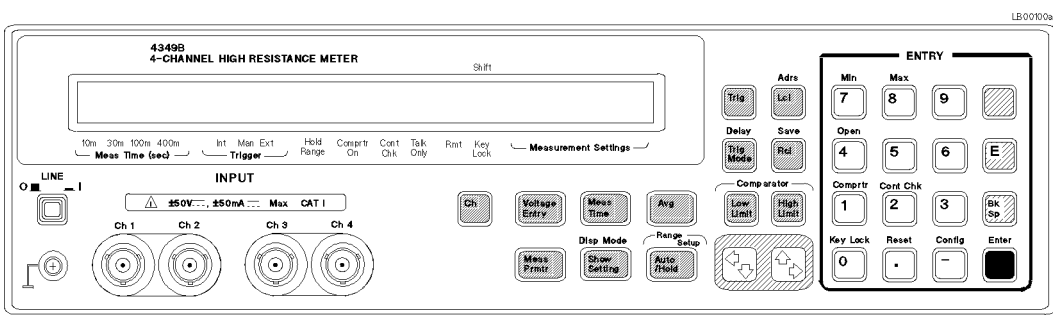

**4349B 4-Channel High Resistance Meter**

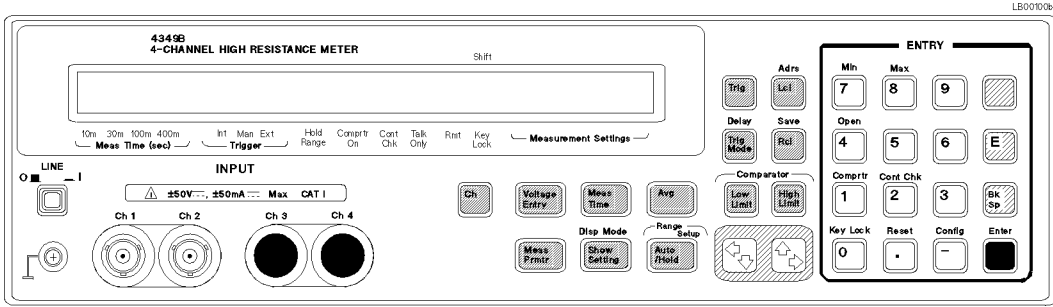

**4349B 4-Channel High Resistance Meter with Option 001 ( 2 channels )**

---

## Overview

The 4349B 4-Channel High Resistance Meter is a high throughput, digital high resistance meter. The 4349B is designed for production testing of capacitors.

## Features

- Designed for capacitor measurements
- 4-channel input
- High speed measurement
- Fast settling time
- High speed contact check
- Comparator function

### ■ High Throughput

To verify component reliability, capacitor manufacturers need to test capacitor insulation resistance at different voltage levels. The 4-channel configuration permits simultaneous testing of four capacitors with different test voltages. This testing technique reduces the investment cost for instruments to 25% when compared to a single channel instrument. The 4349B's 11 ms 4-channel simultaneous measurement improves the test throughput on capacitor production lines.

When insulation resistance testing for capacitor manufacturers, capacitor charge time is a key factor in slowing down measurement speed. The 4349B's front-end has a 1 k $\Omega$  input resistance to reduce the capacitor's charge time, and thus increases test throughput.

The contact check function verifies that the signal path between the handler and the DUTs is optimal for a measurement. Contact checking maintains automatic handler/DUT integrity while keeping system throughput high.

### ■ System Integration

Built-in comparators for all four channels and the GPIB/handler interface make system integration with automatic handlers and computers a fast and clean process.

---

## Note



The 4349B has no test voltage source so an external voltage source is required to make resistance measurements. (The 4349B converts current measurement data into resistance using the test voltage data entered into memory.)

---

## **4349B**

### **Accessories Available**

16117E Low Noise Test Leads (1 m, with connector, 1 unit)

### **Options Available**

Option 700      4 Channels

Option 001      2 Channels

## Front Panel

This section gives a guided tour of the front panel.

- For a detailed description of each key's function, see Chapter 3.
- A description starting with (Shift) is the secondary function of the key, which is available by pressing the BLUE shift key (see 31).

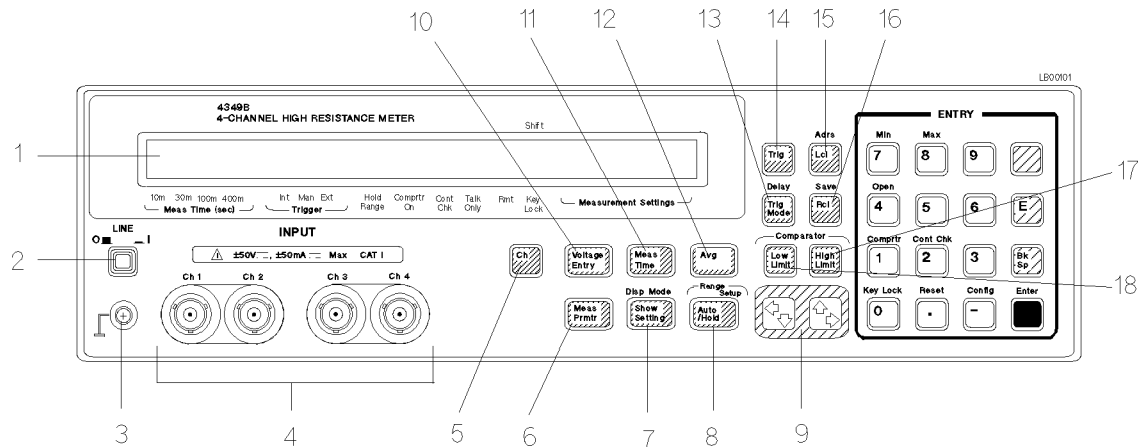

1. **Display** displays results, instrument states, and error messages.
2. **LINE Switch** turns the 4349B ON and OFF.
3. **Chassis Terminal** is tied to the instrument's chassis.
4. **INPUT Terminals** are connection ports for the test leads. (If your 4349B is equipped with Option 001, 2 Channels, then only Ch 1 and Ch 2 exist.)

### INSTALLATION CATEGORY I

5. **Channel Key** selects one of the four channels to display.
6. **Measurement Parameter Key** selects the measurement parameter to be displayed.
7. **Show Setting Key** changes the mode of the Measurement Settings display on the right side of the LCD display.
  - (Shift) **Display Mode key** selects the display mode.
8. **Range Auto/Hold Key** toggles the measurement range mode between Auto and Hold.
  - (Shift) **Range Setup Key** selects the measurement range.
9. **Left/Down Arrow Key and Right/Up Arrow Key** increases or decreases the setting value.
10. **Voltage Entry Key** enters the test voltage value, which is used with the measured current value to calculate the resistance.
11. **Measurement Time Key** sets the measurement time to 10 ms, 30 ms, 100 ms or 400 ms.
12. **Average Key** sets the averaging rate used to average the measurement value.
13. **Trigger Mode Key** selects trigger source from Internal, Manual, or External.
  - (Shift) **Delay Key** sets the trigger delay time.
14. **Trigger Key** triggers a measurement when in the manual trigger mode.

## 1-4 Getting Started

## 4349B

15. **Local Key** returns the 4349B to the local mode from the GPIB remote mode.

(Shift) **Address Key** sets the GPIB address.

16. **Recall Key** recalls instrument state data from the internal memory.

(Shift) **Save Key** stores instrument state data to the internal memory.

17. **High Limit Key** sets the upper comparator limit value.

18. **Low Limit Key** sets the lower comparator limit value.

19. **0 Key** / (Shift) **Key Lock key** toggles to disable and enable the front panel key input.

20. **. (point) key** / (Shift) **Reset Key** resets the 4349B to the default state.

21. **- (minus) Key** / (Shift) **Configuration Key** sets the beeper and the power line frequency, and executes the internal test.

22. **Enter Key** enters the input value to the 4349B.

23. **2 Key** / (Shift) **Contact Check Key** toggles contact check function between ON and OFF.

24. **1 Key** / (Shift) **Comparator Key** toggles the comparator function between ON and OFF.

25. **4 Key** / (Shift) **Open key** takes OPEN correction data.

26. **5 Key**

27. **7 Key** / (Shift) **Minimum Key** inputs the minimum value when setting a parameter.

28. **8 Key** / (Shift) **Maximum Key** enters the maximum value when setting a parameter.

29. **9 Key**

30. **BLUE Shift Key** activates the secondary functions printed above the front-panel keys.

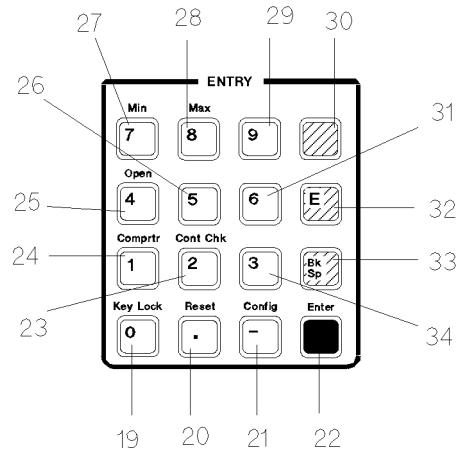

---

**Note** In this manual, the BLUE shift key is expressed as , the top of the key is not labelled with “blue”.

---



31. **6 Key**

32. **Exponential Key** enters exponent value when entering numeric values.

33. **Back Space Key** erases the last character entered when entering numeric values.

34. **3 Key**

## Display

This section introduces the display. For a detailed description of each display field, see Chapter 3.

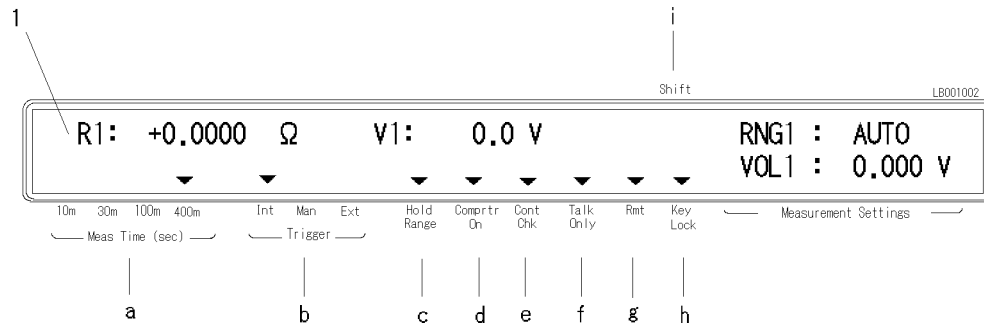

1. **Character Display Area** displays the measurement result, setting data, and instrument messages. The **Measurement Settings** area displays the current 4349B settings.
2. **Annunciator** (▼) points to the currently selected instrument settings. The annunciator labels are as follows:
  - a. **Measurement Time** shows the selected measurement time is 10 ms, 30 ms, 100 ms, or 400 ms.
  - b. **Trigger** shows the trigger mode is Internal, Manual, or External.
  - c. **Hold Range** indicates that the 4349B is in Hold range mode. The annunciator is not displayed when in Auto mode.
  - d. **Comparator On** indicates that the comparator function is ON.
  - e. **Contact Check** indicates that the contact check function is ON.
  - f. **Talk Only** indicates that the 4349B is in the Talk Only mode.
  - g. **Remote** indicates that the 4349B is in the GPIB remote mode.
  - h. **Key Lock** indicates that the 4349B's front-panel keys are locked out.
  - i. **Shift** indicates that the shifted key functions are active.

## 4349B

### Rear Panel

This section gives a guided tour of the rear panel. For a detailed description of each item on the rear panel, see Chapter 3.

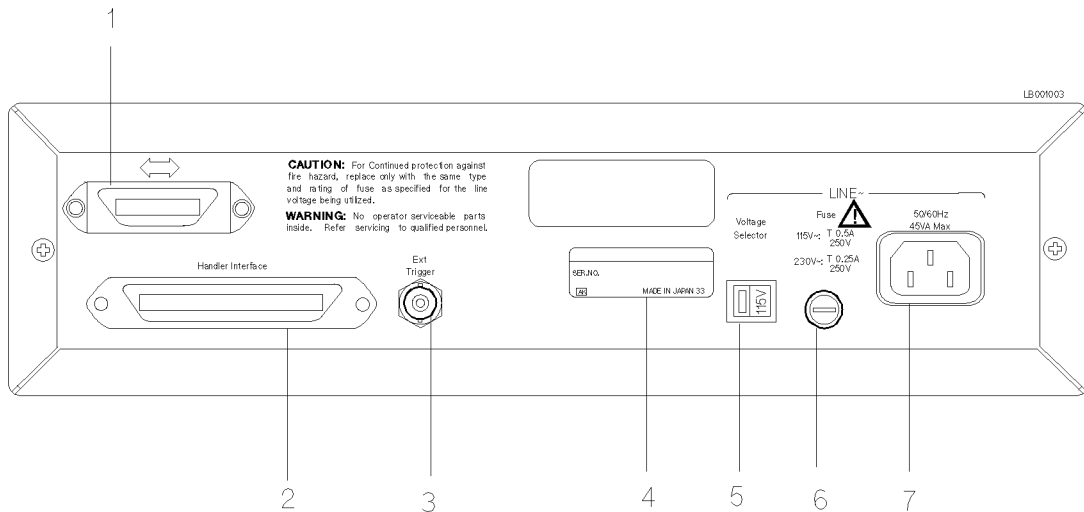

1. **GPIB Interface** is used to control the 4349B from an external controller using GPIB command.
2. **Handler Interface** is used to synchronize timing with an external handler machine.
3. **Ext Trigger Terminal** is used to trigger a measurement by external signal.
4. **Serial Number Plate** gives the instrument's manufacturing information.
5. **Line Voltage Selector Switch** is used to set the 4349B to the voltage of the AC power source.
6. **Line Fuse Holder**
7. **Power Cord Receptacle**

---

## Initial Inspection

### Warning



**To avoid hazardous electrical shock, do not turn on the 4349B when there are signs of shipping damage to any portion of the outer enclosure (for example, covers, panel, or display)**

---

Inspect the shipping container for damage. If the shipping container or cushioning material is damaged, it should be kept until the contents of the shipment have been checked for completeness and the 4349B has been checked mechanically and electrically. The contents of the shipment should be as follows:

- 4349B 4-Channel High Resistance Meter
- Power cable
- Operation Manual (Option ABA, This book)

If the contents are incomplete, if there is mechanical damage or defect, or if the analyzer does not pass the power-on selftests, notify the nearest Agilent Technologies office. If the shipping container is damaged, or the cushioning material shows signs of unusual stress, notify the carrier as well as the Agilent Technologies office. Keep the shipping materials for the carrier's inspection.

---

## Providing clearance to dissipate heat at installation site

To ensure the specifications and measurement accuracy of the product, you must keep ambient temperature around the product within the specified range by providing appropriate cooling clearance around the product or, for the rackmount type, by forcefully air-cooling inside the rack housing. For information on ambient temperature to satisfy the specifications and measurement accuracy of the product, refer to Chapter 8, Specifications.

When the ambient temperature around the product is kept within the temperature range of the operating environment specification (refer to "General" in Chapter 8), the product conforms to the requirements of the safety standard. Furthermore, under that temperature environment, it has been confirmed that the product still conforms to the requirements of the safety standard when it is enclosed with cooling clearance as follows:

	Conditions
Rear	250 mm
Side	100 mm
Upper	15 mm

---

## Instruction for Cleaning

For cleaning, wipe with soft cloth that is soaked with water and wrung tightly without undue pressure.



## Power Cable

In accordance with international safety standards, this instrument is equipped with a three-wire power cable. When connected to an appropriate ac power outlet, this cable grounds the instrument frame. The type of power cable shipped with each instrument depends on the country of destination. Refer to Figure 1-1 for the part numbers of the power cables available.

---

### Warning



**For protection from electrical shock, the power cable ground must not be defeated. The power plug must be plugged into an outlet that provides a protective earth ground connection.**

---

<p><b>OPTION 900</b></p>  <p>Plug : BS 1363A, 250V Cable : 8120-1351</p>	<p><b>OPTION 901</b></p>  <p>Plug : NZSS 198/AS C112, 250V Cable : 8120-1369</p>
<p><b>OPTION 902</b></p>  <p>Plug : CEE-VII, 250V Cable : 8120-1689</p>	<p><b>OPTION 903</b></p>  <p>Plug : NEMA 5-15P, 125V, 15A Cable : 8120-1378</p>
<p><b>OPTION 904</b></p>  <p>Plug : NEMA 6-15P, 250V, 15A Cable : 8120-0698</p>	<p><b>OPTION 906</b></p>  <p>Plug : SEV 1011.1959-24507 Type 12, 250V Cable : 8120-2104</p>
<p><b>OPTION 912</b></p>  <p>Plug : DHCR 107, 220V Cable : 8120-2956</p>	<p><b>OPTION 917</b></p>  <p>Plug : SABS 164, 250V Cable : 8120-4211</p>
<p><b>OPTION 918</b></p>  <p>Plug : JIS C 8303, 125V, 15A Cable : 8120-4753</p>	<p><b>OPTION 922</b></p>  <p>Plug : GB 1002, 250V Cable : 8120-8376</p>
<p>NOTE: Each option number includes a 'family' of cords and connectors of various materials and plug body configurations (straight, 90° etc.).</p>	

Figure 1-1. Power Cable Supplied

## Preparation for Use

Before you use the 4349B, you must set the 4349B to match the available power line voltage and frequency.

- Set line voltage—see “Power Requirements”.
- Set line frequency—see “Turning ON the 4349B”.

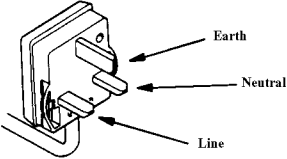
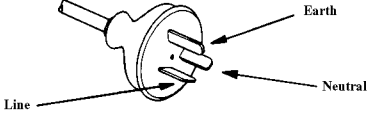
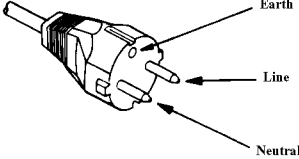
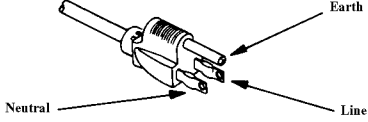
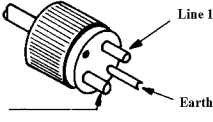
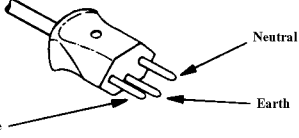
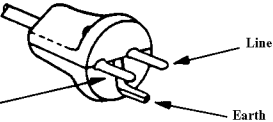
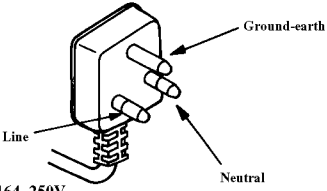
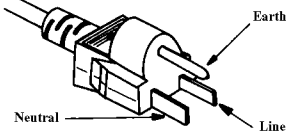
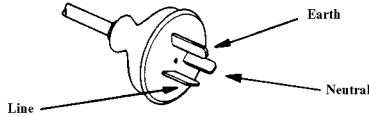
### Power Requirements

The 4349B’s power source requirements are as follows:



**Line Voltage** : 100 / 120 / 220 / 240 V ac ( $\pm 10\%$ )

**Line Frequency** : 47 to 66 Hz

**Power Consumption** : 45 VA maximum

Confirm that the LINE Voltage Selector on the rear panel is set to match the power line voltage before plugging in the 4349B. Refer to Table 1-1.

**Table 1-1. Power Voltage Selector Setting**

Voltage Selector	Line Voltage	Required Fuse
	100V/120Vac( $\pm 10\%$ )	UL/CSA type, Time delay 0.5A 250V (Agilent part number 2110-0202)
	220V/240Vac( $\pm 10\%$ )	UL/CSA type, Time delay 0.25A 250V (Agilent part number 2110-0201)

### Fuse

Use the fuse shown in Table 1-1. If you require the fuse, contact the nearest Agilent Technologies sales office.

The fuse can be replaced by turning the fuse holder counterclockwise until the fuse holder pops out with a minus screw driver. For the fuse holder location, see “Rear Panel” in this chapter.

## Turning ON the 4349B

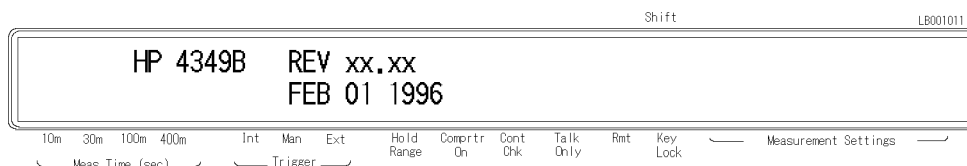

1. Connect the power cable to the Power Cord Receptacle on the rear panel.
2. Push the LINE switch in. The 4349B will emit a beep when it turns ON, and performs the self test. (If any message is displayed, see “Error Messages” back of this manual.) The 4349B will be ready for operation after a message like shown in the following figure is displayed.



3. Confirm the ac line frequency setting of the 4349B.

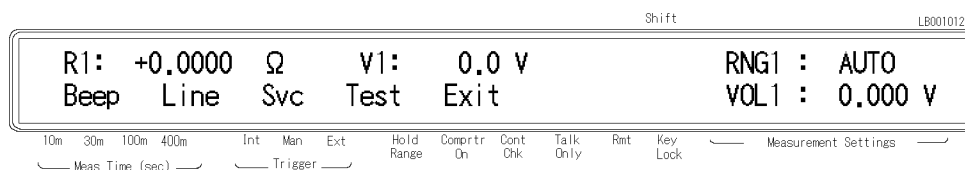

- a. Press  .

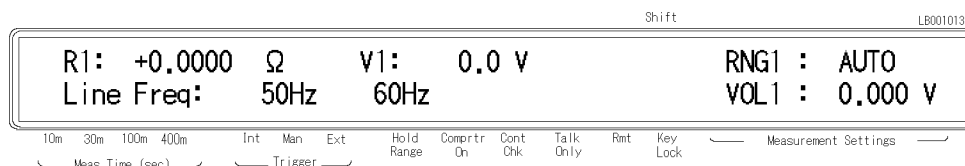

- b. Press  until Line blinks, then press .



A blinking item means that it is currently selected.

- c. If the setting is not matched to the ac line frequency, press  to toggle the setting between 50 Hz and 60 Hz.
- d. Press  two times to exit this menu.

The power line frequency setting is stored and is not changed after reset or power-off. Once you set it, you do not need to set the line frequency as long as the same power line frequency is being used.

## Using Front Panel Keys

The 4349B has four type of keys as follows:

- Direct Execution Keys
- Toggle Keys
- Selection Keys
- Value Setup Keys

This section tells how to operate the 4349B using its front-panel keys.



### Note



If you want to exit an operation and go back to the measurement display, press  several times.

### Direct Execution Keys

Pressing a direct execution key will perform the pressed key's function immediately. For example,



Press  . The 4349B will begin the OPEN correction immediately.

### Toggle Keys

Pressing a toggle key will switch between several conditions. An annunciator(▼) will indicate the current condition. For example,

Press . The **Meas Time** annunciator(▼) points to 10 ms, 30 ms, 100 ms, or 400 ms.

### Selection Keys

Pressing a selection key will display the selection display. The blinking item is the one currently selected. By using  , or the selection key itself, the item selected can be changed.

For example, to perform self test,

1. Press  . Exit is blinking.

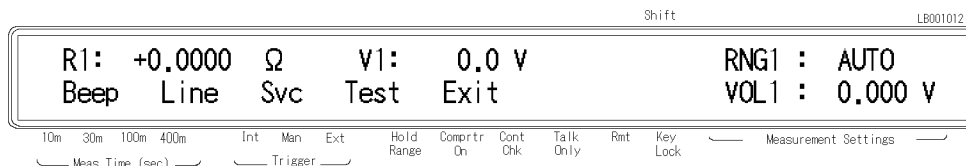

2. Press  to select Test.

3. Press . The self test will start immediately. After the test is finished, the 4349B displays any existing error code, and returns to the menu.

4. Press  to Exit the menu.

## Value Setup Keys

Pressing a value setup key will display parameter entry display and prompt you to enter a value.

For example, pressing  displays,

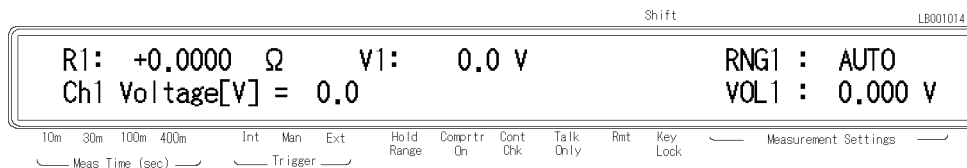

The displayed value can be altered by using the following keys:

Numeric Keys

Maximum and Minimum Keys

Left/Down and Right/Up Arrow Keys

Back Space Key

## Numeric Keys

Some commands use numeric parameters. A numeric parameter is the actual value used by the 4349B. For example, to set the test voltage value to 100 V,

1. Press   **1**  **0**  **0** .

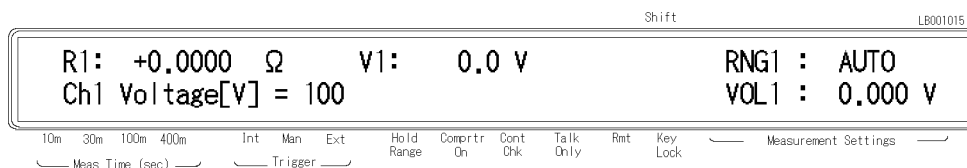

2. Press  to enter the value and to exit.

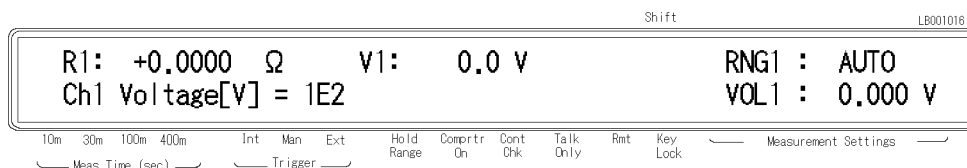

You can also enter numeric parameters using exponential notation.

1. Press   **1**  **E**  **2** .





2. Press  to enter the value and to exit.

**Note**

Before you press  the previous setting is still the current setting, even if the displayed value has changed. If you press a key other than one of the keys in ENTRY block before pressing , the setting will not change and the displayed value will be discarded.

**Maximum and Minimum Keys**

These keys enter the maximum and minimum numeric value in place of having to use the numeric keys. For example,

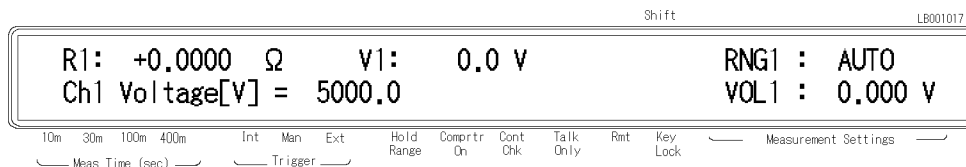

1. Press   , and you will get the maximum voltage value.



2. Press  to enter the value and to exit.

**Left/Down and Right/Up Arrow Keys**

Increments or decrements the numeric entry. For example,

1. Press  to bring up the averaging setup display.
2. Press  several times and confirm a change in value.
3. Press  to exit the averaging setup display.

**Back Space Key**

Erases the last entered character to cancel an input value. For example,

1. Press      .

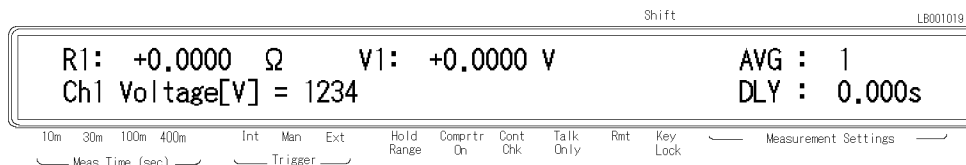

2. Press  . The last entered number, 4, is erased.

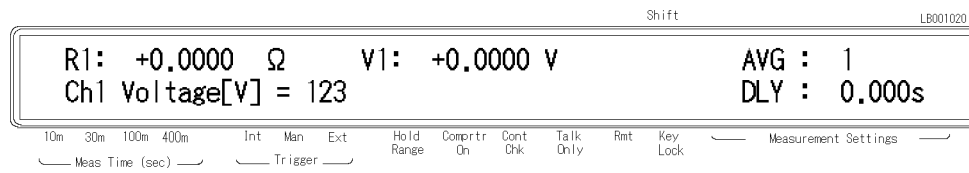

---

## If you have any problems

If you have any problems operating the 4349B see “If Your 4349B Has a Problem” in Chapter 2.



## Operating the 4349B

---

### Introduction

This chapter provides step-by-step instructions for using the 4349B 4-Channel High Resistance Meter.

This chapter includes the following sections:

- Installation
- Measurement Configuration
- Making measurements
- Testing the 4349B
- If You Have a Problem

Refer to Chapter 3 for the description of each front panel key function.

## External Voltage Source

The 4349B has no internal test voltage source. You must supply a suitable external voltage source in order to make resistance measurements.

In a typical case, measuring the insulation resistance of capacitors whose insulation resistance value is expressed  $\leq 1 \text{ G}\Omega \cdot \mu\text{F}$  within  $\leq 10\%$  measurement accuracy, the external voltage source must meet the following specifications:

Ripple :	$\leq 1 \text{ mV}_{\text{rms}}$ ( $\leq 0.7 \text{ mV}_{\text{rms}}$ preferable) @ 50/60 Hz
Wide Band Noise :	$\leq 5 \mu\text{V}_{\text{rms}}/\sqrt{\text{Hz}}$ ( $\leq 2 \mu\text{V}_{\text{rms}}/\sqrt{\text{Hz}}$ preferable) @ 50 Hz
Switching Noise :	$\leq 50 \text{ mV}_{\text{rms}}$

## Test Leads

Use the 16117E Test Lead to connect the 4349B and the DUT. The 16117E contains one cable (1 m, with triaxial connectors on the both ends) and one connector (Triaxial Female). So, four 16117E Test Leads are required when you want to use four channels.

## Specifications

- Cable Length : 1 m (triaxial connector to triaxial connector)
- Operating Temperature : 0 to 45 °C
- Operating Humidity :  $\leq 70\%$  RH (@ 40 °C)
- Non-operating Temperature : -40 to 70 °C
- Non-operating Humidity :  $\leq 95\%$  RH (@ 40 °C)

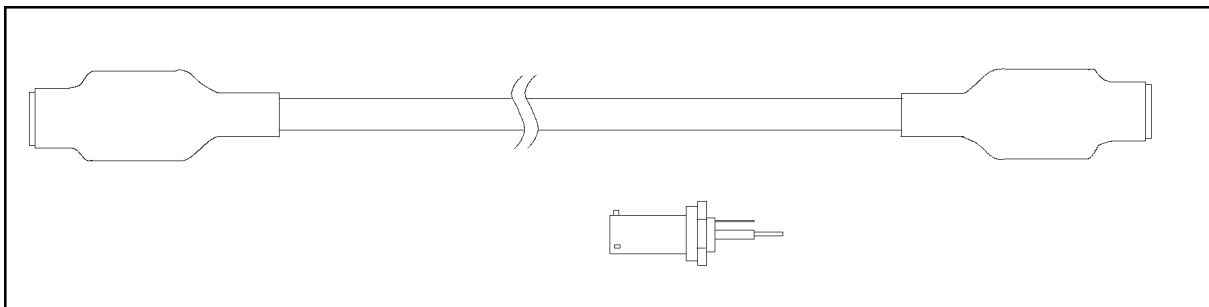

LB002000

Figure 2-1. 16117E Test Lead

## ⚠ Installation

Figure 2-2 shows the typical system using the 4349B.

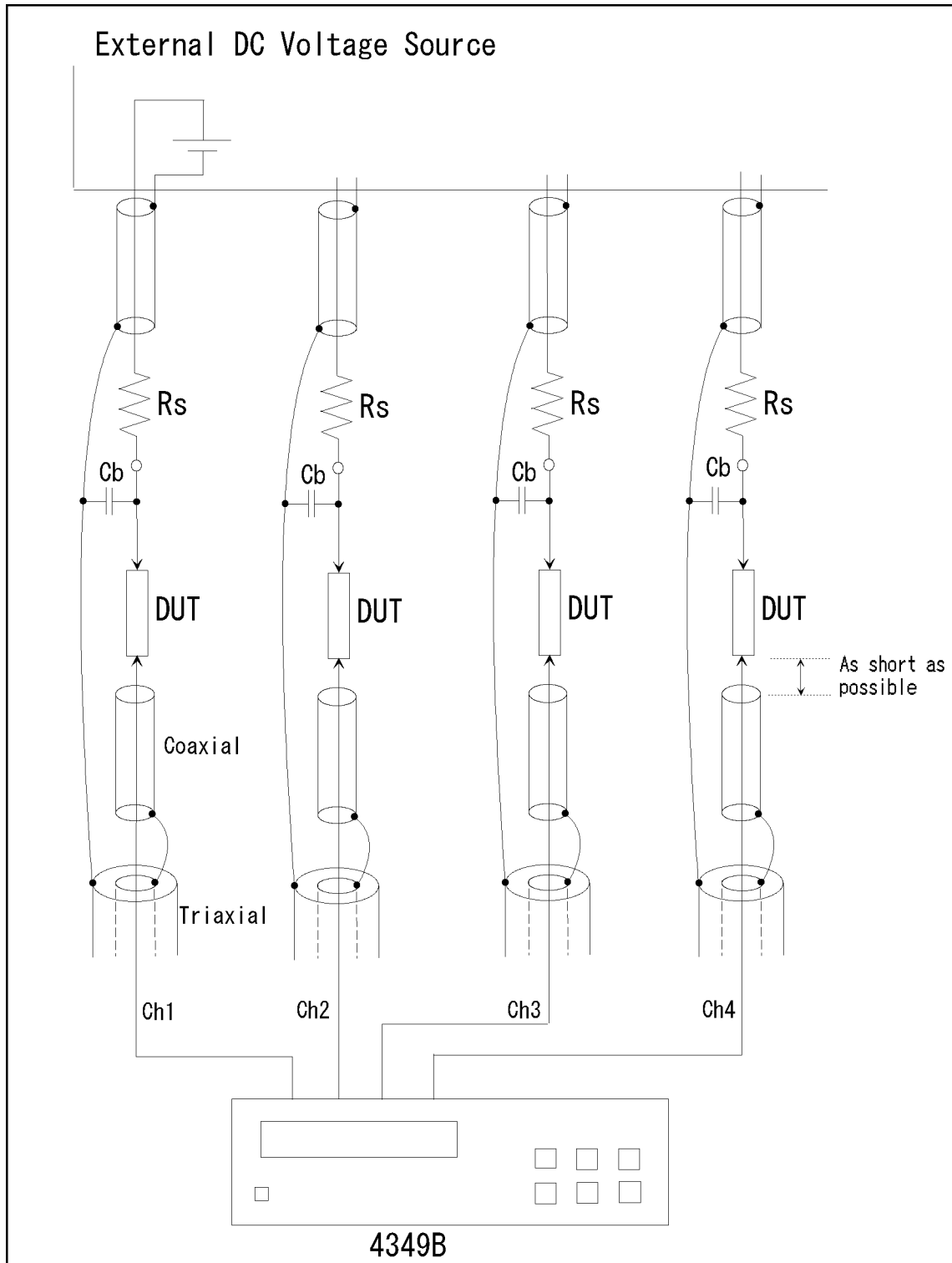

LB002101

Figure 2-2. Typical Measurement System

- Connect capacitors ( $C_b$ ) with a value of about 500 pF (100 to 1000 pF) between the test voltage side terminal of the device under test and the shield of the triaxial test cable to bypass the contact check signal. (When  $R_s$  is greater than 1 k $\Omega$ .)
- For the principle of operation of the contact check, refer to Chapter 3 “Principle of Operation.”
- Insert a resistor between the test voltage source and device under test. This resistor is for limiting the current and reducing the voltage source noise effect. The minimum value for current limit is calculated as follows:

$$R_s = \text{Test Voltage} / \text{Current Limit}$$

(For details about reducing the voltage source noise effect, refer to “How to Reduce the Measurement Error” in Chapter 6.)

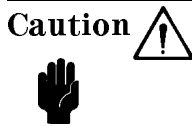

Do *not* apply a dc voltage exceeding  $\pm 50$  V or  $\pm 50$  mA to the INPUT terminals, or the 4349B’s input circuits will be destroyed. Connect a current limiting resistor between the test voltage source and device under test to avoid the over current when a shorted device is connected. The series resistance value should be:

$$R_s > ( \text{Test Voltage}[V] / 0.05[A] )$$

---

**Warning**



The measurement system using the 4349B and the external voltage source may output dangerous voltage. To prevent an electrical shock, observe the following safety precautions.

- Agilent Technologies recommends you to attach the safety interlock function to the measurement system so that the operators can not touch the parts where dangerous voltage may appear. If not possible, warn the operators and the workers around the measurement system not to touch the parts.
- Use the parts with the safety function to prevent an electrical shock caused by the insulation breakdown, even if dangerous voltage does not appear on the parts directly.
- Turn OFF the output of the external voltage source and discharge the remanent charge of the DUT thoroughly, before touching the measurement system or the DUT where the dangerous voltage may appear.
- Use the power cord shipped with the 4349B and provide an uninterruptible safety earth ground to the instrument.
- Do not apply a dc voltage exceeding  $\pm 50$  V or  $\pm 50$  mA to the INPUT terminals.

Agilent Technologies warrants the 4349B and its accessories provided by Agilent Technologies. Agilent Technologies does not warrant any accidents caused by trouble in an external voltage source or the measurement system.



---



## Measurement Configuration

This section discusses the 4349B's general configuration topics that apply to many or all measurement functions.

### To Reset the 4349B



Resetting sets the 4349B to its default settings. To reset the 4349B:

Press   to display the system reset menu.

Select Yes using  or  and press .

### To Perform the OPEN Correction Function

The OPEN correction cancels the 4349B's offset error and the test fixture's leakage current. To perform the OPEN correction:

1. Connect the test leads for all channels to the 4349B without connecting the DUT.
2. Press  . While the OPEN Correction procedure is in progress, the message **Open Correction** will be displayed, and when the OPEN correction procedure is finished, the previous display is returned.

### To Select a Measurement Parameter

The current measurement parameter is shown on the left side of the display when the display is in the Data display mode; R for resistance and I for current. To select measurement parameter:

1. Press .

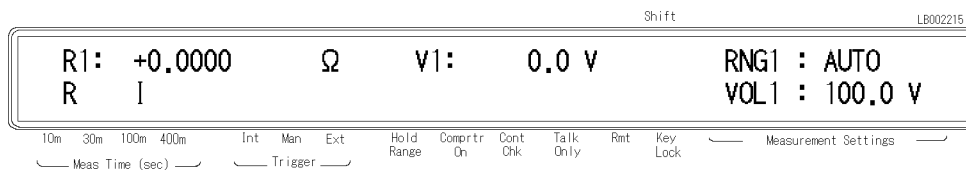

2. Select R or I using  , and press .

## To Select the Channel

The channel to be displayed or to set the values is selected by using  . To change the channel:

Press  until the desired channel is selected.

The currently selected channel is indicated by the suffix of R (or I) and V in the display.

## To Enter the Voltage Value

The current voltage setting is displayed on the right of the measurement data, or in the **Measurement Settings** area. To enter the voltage value:

1. Select the channel for which the voltage value is to be entered.
2. Press  .

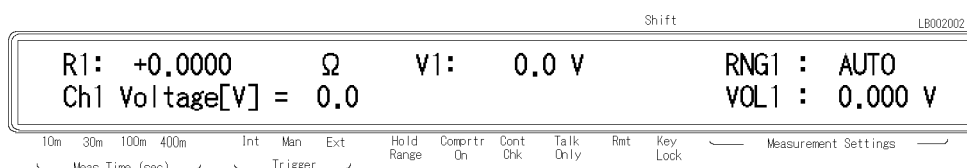

3. Enter the voltage value, and press  to set the value and to exit.

## To Select the Measurement Range

The **Hold Range** annunciator() gives the current range status; the Auto range mode when it is OFF, or the Hold range mode when it is ON.



- To select the Auto range mode when the 4349B is in the hold range mode:

Press  . The **Hold Range** annunciator() turns OFF.

- To select the range in the Hold range mode:

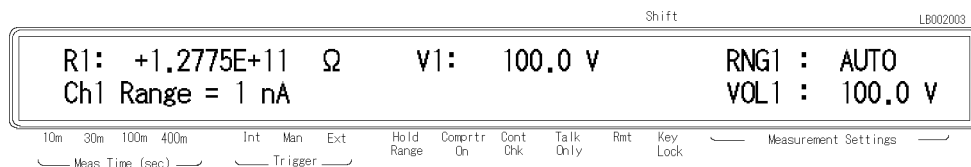
1. Select the channel for which the range is to be set.
2. Press  to display the range setup menu.



3. Press  or  to select the range.
4. Press  to set the range and to exit.

The currently selected range is displayed in the **Measurement Settings** area.

## 4349B

### To Select the Measurement Time Mode

The current measurement time setting is indicated by the **Meas Time** annunciator(▼).  
To select the measurement time:



Press  until the measurement time is set to the desired value (10 ms, 30 ms, 100 ms, or 400 ms.)

### To Set the Averaging Rate

To set the averaging rate or to show the current setting:

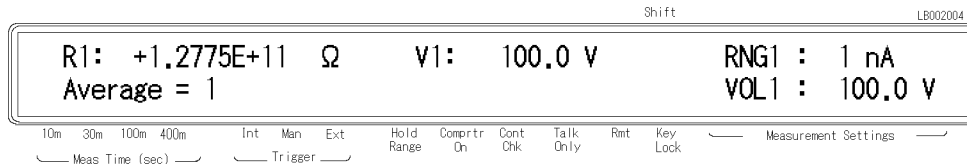
1. Press  .



2. Enter the desired value, or press   to select the value.

3. Press  to set the value and to exit.

The current averaging rate can be displayed in the **Measurement Settings** area (see “To Change the Measurement Settings Display”).

### To Set the Trigger Delay Time

To set the trigger delay time:

1. Press   .

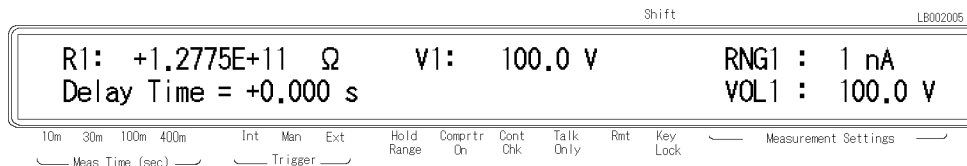

2. Enter the desired value.

3. Press  to set the value and to exit.

The current trigger delay time can be displayed in the **Measurement Settings** area of the LCD display (see “To Change the Measurement Settings Display”).

## To Set the Contact Check

The **Cont Check** annunciator(▼) tells the current contact check status. To set or abort the contact check function:

### Note



Before performing the contact check, perform the OPEN correction to measure the reference value of the contact check.

### Note



The contact check feature of the 4349B discriminates Contact/NO Contact based on the difference in capacitance between when the DUT is connected and when it is not connected (Open). Therefore, if the change of capacitance between those two different states is not enough, the discrimination may fail.

To enable or disable the contact check function:

1. Press .

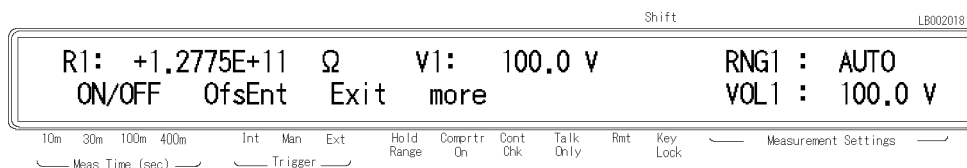

2. Select ON/OFF using or and press to select.

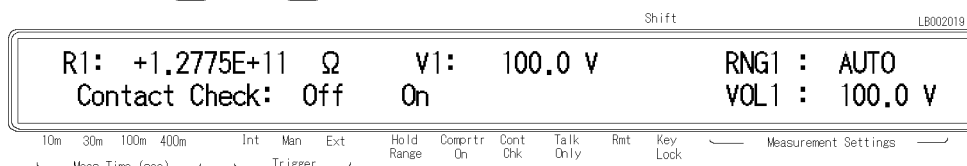

3. Select On or Off using or , and press to exit to the previous display.
4. Select Exit using or , and press to exit.

5. The **Cont Chk** annunciator(▼) turns ON if the contact check function is enabled.

In the case of the contact check function is enabled, N.C. (No-Contact) will be displayed when the contacts between dut and fixture are open. See “Contact Check Effective Range” in Chapter 8 for the contact check effective range.

To perform the contact check effectively, note the following:

- Connect the coaxial cable as close to the DUT as possible.
- If the judgment result is Contact when the DUT is not connected due to variation in residual capacitance of the fixture or cable used for the automated test equipment, set an Offset value for the Limit value to provide a stricter discrimination criterion.

For the principle of operation of the contact check, refer to Chapter 3 “Principle of Operation.”

Contact check compares a measured capacitance data of dut with a limit data. Interpretation of the limit data and the measured capacitance data of the dut are shown below.



## 4349B

### Reading the Limit Data of Contact Check Function

1. Select the desired channel.

2. Press   .

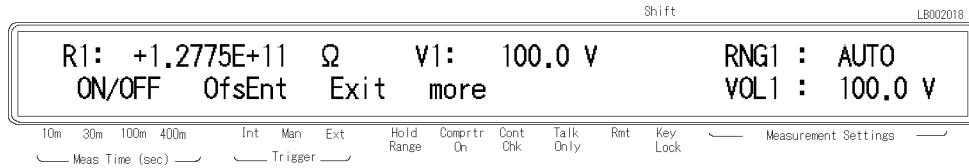

3. Select more using  or  , then press  .

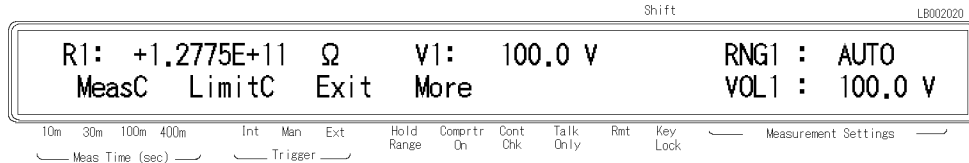

4. Select LimitC using  or  , then press  .

5. The limit value is displayed.

The limit data (*Limit*) is calculated by the following equation.

$$Limit = C_s * 1.035 + 0.40 * 10^{-12} + Offset$$

Where:

*C<sub>s</sub>* Stray capacitance at open measurement (Value returned from the GPIB command: SENS:CORR:DATA? SCAP)

*Offset* Data entered by `OfsEnt`





`OfsEnt` is set to '0'(default) in normal measurement. In case of a parallel capacitor measurement, `OfsEnt` will be set to the capacitance of the parallel capacitor.

---



**Note** Set the offset value to more than 0.

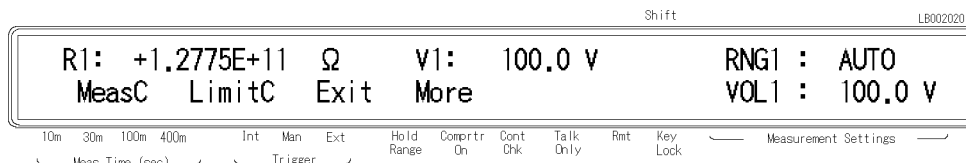

## Reading the Capacitance Data at DUT Measurement

1. Select the channel.
2. Press   .
3. Select more using  or  , then press  .



4. Select MeasC using  or  , then press  .
5. The capacitance value at measured DUT is displayed.  
The condition of N.C.(No Connection) is shown below.

$$MeasC < Limit$$

Where

*MeasC* Data displayed in MeasC  
*Limit* Data displayed in LimitC

The capacitance is not measured in the case of the contact check function is unenabled.

## To Set the Beeper Mode





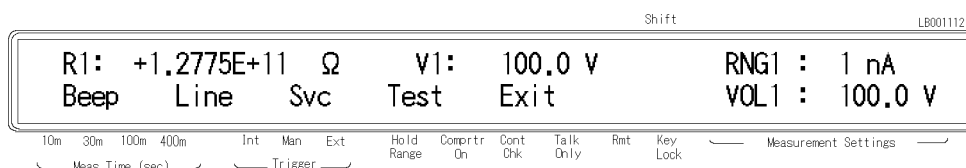

To set the beeper mode for the comparator result reporting:

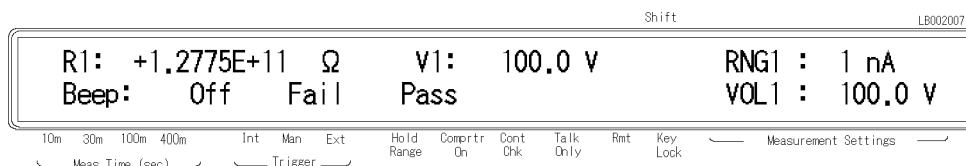
1. Press   .



2. Select Beep using  or  and press  .





3. Select the desired beeper mode using  or  and press  .
4. Select Exit using  or  and press  .

## 4349B

### Saving and Recalling Instrument Settings

The 4349B can save and recall the instrument's settings into non-volatile memory (EEPROM).

■ To save the current settings:

1. Press   .
2. Enter the register number (0 to 9) that you want to save the settings into.

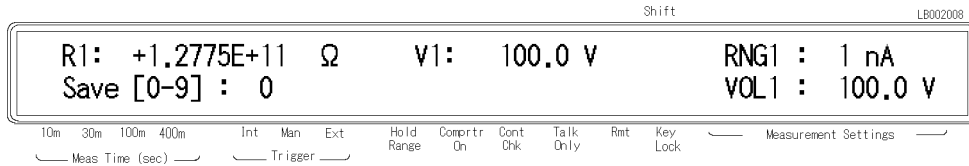

3. Press  to save.

---

**Note** Record the register number that you used for future reference.



■ To recall a setting.

1. Press  .
2. Enter the register number (0 to 9) that you want to recall the settings from.

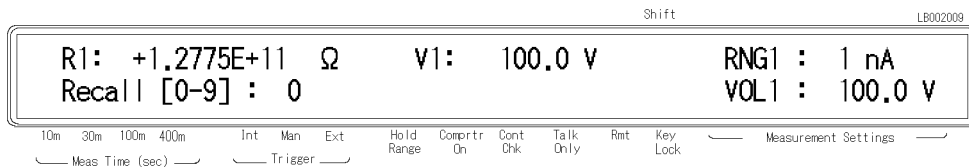

3. Press  to recall.

## Making a Measurement

This section discusses the methods for making measurements after configuring for measurement.

### Triggering a Measurement

The 4349B has four trigger source modes: Internal, Manual, External, or Bus. The **Trigger** annunciator(▼) shows which trigger source is selected.

#### Note



When the bus trigger mode is selected, none of the **Trigger** annunciator(▼) is ON. The bus trigger mode can be set by GPIB commands only.



#### ■ To Trigger Internally

1. Press  until the **Int** annunciator(▼) is ON.

#### ■ To Trigger Manually

1. Press  until the **Man** annunciator(▼) is ON.
2. Press  to trigger a measurement.



#### ■ To Trigger Externally

1. Connect an external trigger source to the Ext Trigger terminal on the 4349B's rear panel.
2. Press  until the **Ext** annunciator(▼) is ON.
3. Apply a TTL level trigger signal to trigger a measurement. (Refer to “External Trigger Terminal” in Chapter 3 for trigger specifications.)

### To Use the Comparator Function

The comparator function can be used to sort DUTs according to user set parameter limits.

#### ■ To set the limit values:

1. Press  to select the channel to set.
2. Press  .

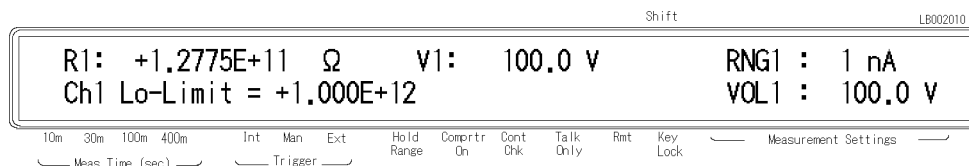

Enter the lower limit value, and press .

## 4349B

3. Press  .

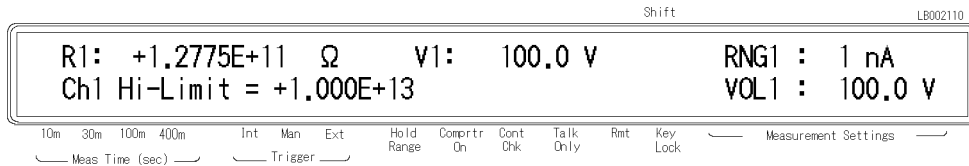

Enter the upper limit value, and press  .

■ To start sorting:

Press   .

■ To display the sorting results:

1. Press   .

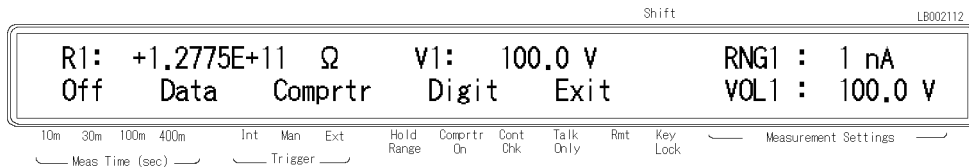

2. Select **Comprtr** using  or  and press  .

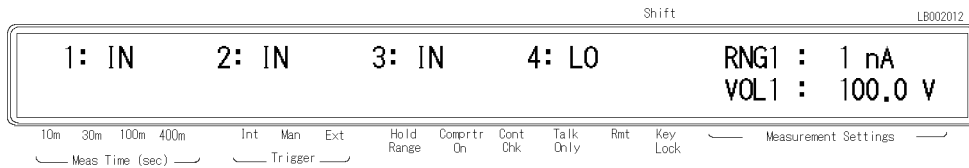





The comparator results of four channels are displayed.

■ To stop sorting:



  .

## To Select the Display Mode and Display Digits

Press  . The display mode selection menu appears.

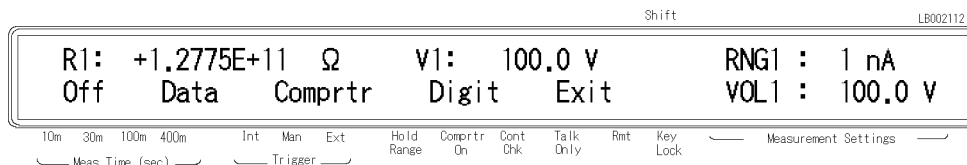
Select the desired mode using  or  (Data:Measurement Data, Comprtr:Comparator results, Off:Display OFF). To exit the menu, select **Exit**.



If you select **Digit**, the display digits selection menu appears. Select the desired digits (3, 4, or 5) using  or , and press . After selecting the display digits, the 4349B returns to the display mode selection menu.

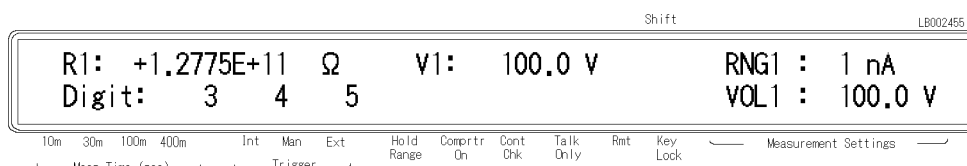

## To Change the Measurement Settings Display

Each time  is pressed, the display mode of the Measurement Settings area is changed as follows:

1. Measurement range RNG and Voltage value VOL of the selected channel

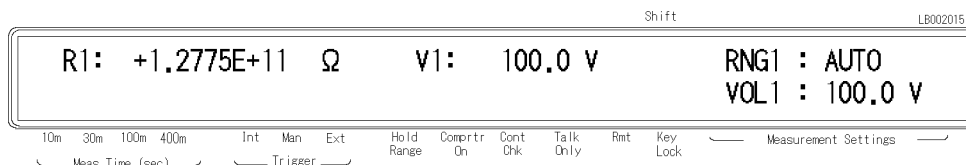

2. Averaging rate AVG and Trigger delay time DLY

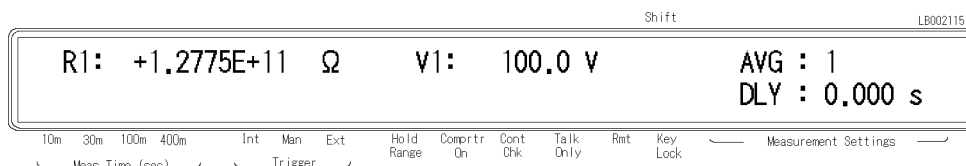

3. Upper comparator limit H and Lower comparator limit L of the selected channel

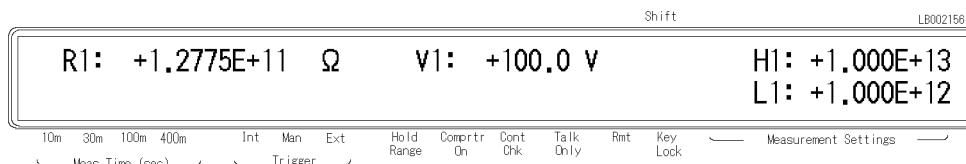

## 4349B

### Locking Out the Front Panel Keys

To lockout the keys:

Press  .

To unlock the keys:

Press   again.

### Selecting Local Mode

To return the 4349B to local mode from GPIB remote mode:

Press .

### Setting the GPIB Address

1. Press  .

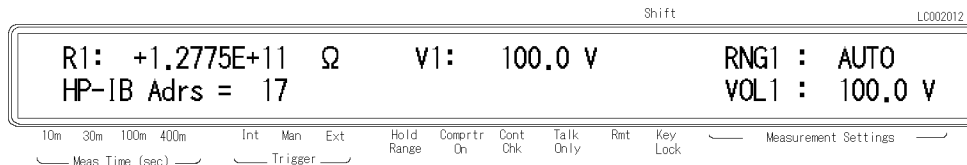

2. Enter the desired value, then press  to set the value and to exit.

When you just want to see the current setting, press .

### Printing Measurement Data

The 4349B can print measurement data to an GPIB compatible printer without using an external controller. To do so, you must:

1. Set the printer to listen-always mode. (Consult the printer manual for instructions.)
2. Connect the printer to the 4349B's GPIB port.
3. Turn the printer ON.
4. Set the 4349B's GPIB address to 31 (talk only mode).

Press     .

The printer will automatically begin printing the measurement data.

5. To stop printing, change the 4349B's GPIB address to an address other than 31 (for example, 17, which is the default setting).

Press     .





## To Test the 4349B

### Performing a Self-Test

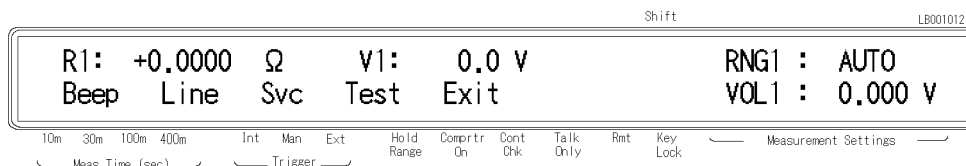
The 4349B has a self-test function to check its basic performance.

1. Press  .



2. Select Test using  or , and press  to execute the self test. If any error message is displayed, refer to “Messages” back of this manual.
3. Select Exit and press  to exit.



### Testing the Front Panel Keys’ Functionality

The 4349B has a service function to test the functionality of the front panel keys (as well as the handler interface, the ROM, the RAM, and the EEPROM).

This section describes how to test the front panel keys’ functionality.

(For the handler interface test, refer to Chapter 9 for the procedure. The other tests are for use by service personnel only.)

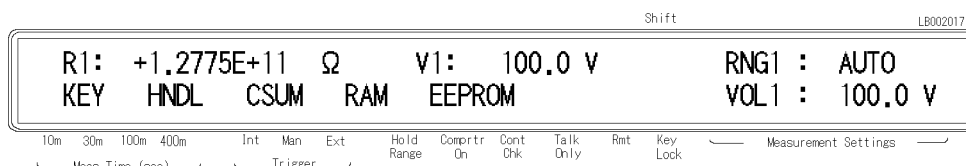

1. Press  .

2. Select Svc using  or  and press .





3. Select KEY using  or  and press .

4. Press the front panel key that you want to test.

For example, if you want to test , press .

When the key functions properly, Key Code:5 Trigger is displayed; otherwise, there will be no such display, and the key is not functioning correctly. Contact your nearest Agilent Technologies office.

5. To exit the front panel key test, press  twice.
6. Select Exit and press  to exit.



---

## If Your 4349B Has a Problem

### If the Display is Blank and the 4349B Appears Dead

If the display is blank, and even the annunciators are not ON:

- Check the fuse.

### If an Error Message is Displayed



- Refer to “Messages.”

### If the 4349B does not Accept Any Key Input

- Check whether the **Rmt** annunciator is ON.
  - Check whether the external controller is disabling all the front-panel controls using the LOCAL LOCKOUT command.

If so, send the LOCAL command from the external controller.

- Press  .
- Check whether the **Key Lock** annunciator is ON.
  - Check whether the handler or the 16064B LED display/trigger box is connected to the 4349B and it locks out the keys.

If so, unlock the keys from the handler or the 16064B.
- Press   .

### If the Resistance Value Is Always 0 Ω

- Enter a test voltage value.



## Function Reference

---

### Introduction

This chapter provides information on all of the 4349B's functions.

- Front Panel
- Rear Panel
- Theory of Operation

## Front Panel

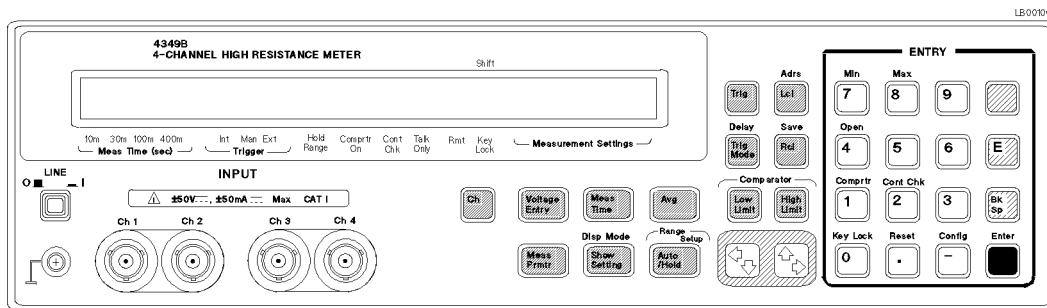



Figure 3-1. Front Panel



### Note



In this manual, the blue shift key is expressed as , the top of the key is not labelled with “blue”.

## Display

The display has two functions—the character display and annunciator display.

The character display displays the measurement result, setting data, and instrument messages. The 4349B has three measurement display modes. For details on the display modes, refer to “Display Mode Key  ”.

The annunciator () points to the current setting of the 4349B. The annunciators are,

- Meas Time** (Measurement Time) indicates measurement time—10 ms, 30 ms, 100 ms, or 400 ms.
- Trigger** indicates the trigger mode—Internal, Manual or External.
- Hold Range** shows the measurement range mode—Hold (when the annunciator is displayed) or Auto (when the annunciator is not displayed).
- Comprtr On** (Comparator On) indicates the comparator function is ON.
- Cont Chk** (Contact Check) indicates the contact check function is ON.
- Talk Only** (Talk Only) indicates the 4349B is in the Talk Only mode.
- Rmt** (Remote) indicates the 4349B is in the GPIB remote mode.
- Key Lock** indicates the 4349B’s front panel key is disabled.
- Shift** indicates the secondary key functions (printed above the keys in blue characters) are the active functions.

## 4349B

### LINE Switch

Power ON/OFF switch. In the 1 (ON) position power is applied and all operating voltages are applied to the instrument. In the 0 (OFF) position no power is applied and no operating voltages are applied to the instrument.

The 4349B's settings are held in backup memory for 72 hours after power is turned OFF, and are restored as the current settings when power is turned ON again within the 72 hours period. The backed up settings are:

- Test voltage entry for each channel
- Measurement parameter
- Auto / Hold range
- Measurement range for each channel
- Measurement time
- Averaging rate
- Trigger mode
- Trigger delay
- Comparator ON / OFF state
- High and low limit value for each channel
- Contact check ON / OFF state
- Display mode

### Chassis Terminal

The Chassis terminal is tied to the instrument's chassis.



### INPUT (Ch1, Ch2, Ch3, and Ch4) Terminals

These are the terminals used to connect the test leads to measure the DUT. The connector type is triaxial, which is configured as a center conductor, an inner shield, and an outer shield. The outer shield, connected to the ground, shields the test the test signal from noise. The inner shield, to which nothing should be connected, guards the very small current signal, and cuts the leakage current of the contact check signal. The center conductor, lead to the test electrode, is the test signal path.

The 4349B has four channels, Ch1, Ch2, Ch3, and Ch4 (If your 4349B is equipped with Option 001, 2 Channels, there are only two channels, Ch 1 and Ch 2.), and a measurement is simultaneously performed at each channel when the 4349B is triggered to make a measurement. The displayed channel is selected using  .

Each channel has the respective settings for the following functions:

- Test voltage entry
- Measurement range (in Hold Range mode)
- Limit values for comparator

---

**Caution**  DO NOT apply a dc voltage exceeding  $\pm 50$  V, or dc current exceeding  $\pm 50$  mA to the UNKNOWN terminals, or the 4349B's input circuits will be destroyed.



## Channel key

The Channel key selects channel to be displayed or whose value is to be set. The channel selection is indicated by the suffix of the displayed parameter such as R, I, or V. The channel key is not the key which selects the measurement channel, because the 4349B always performs a measurement simultaneously on all four channels.

## Voltage Entry Key

The Voltage Entry key is used to enter the test voltage value which the 4349B uses to calculate and display the resistance value. The available values are from  $-0$  V to 5 kV with 0.1 V resolution. The current setting value, V1 (or V2, V3, V4) is displayed along with the measurement result. The default value is 0 V.

## Measurement Time Key

The Measurement Time key sets the measurement time mode: 10 ms, 30 ms, 100 ms, or 400 ms. The current setting is indicated by the **Meas Time** annunciator(). The default measurement time is 30 ms.

## Average Key

The Average key sets the measurement averaging rate. The 4349B averages the measurement results automatically. Averaging rate can be set from 1 to 256. The default averaging rate is 1.

## Measurement Parameter Key

The Measurement Parameter key selects the measurement parameter. The 4349B has the following measurement parameters:

R      Resistance (calculated from the measured I value and voltage value entered by )

I      Current

The currently selected measurement parameter is displayed on the left side of the measurement display. The default measurement parameter is R.

---

**Note**      The V displayed with R or I is not a measured value but a user-entered value entered using .



## Show Setting Key

The Show Setting key changes the display mode of the **Measurement Settings** area. Each time  is pressed, the displayed information is changed as follows:

1. Range and Voltage value of the selected channel
2. Averaging rate and Trigger delay time
3. Comparator limits of the selected channel

## 4349B

### Display Mode Key



The Display Mode key sets the 4349B to one of the following three display modes:

- Measure Display** displays the measured result of selected channel. When the contact check function is ON and a contact check fails, the message N.C.(no-contact) is displayed instead of measured data. (default)
- Comparison Display** (When comparator function ON) displays the result message of the comparator as HI(greater than upper limit), IN(passed), LO(less than lower limit), and in addition, when the contact check function is ON, N.C.(contact check failed) for all channels.  
(When comparator function OFF) displays OFF.
- Display Off** Display OFF mode. No measurement result is displayed.

If you select Digit in the display mode selection menu, you can select the display digits for the measurement data. The available digits are 3, 4, and 5.

### Auto/Hold Range Key



The Auto/Hold Range key toggles the measurement ranging mode between Auto and Hold. The Auto mode selects the optimum measurement range automatically within 5 measurement cycles. The Hold mode fixes the measurement range setting to range you selected. When the Hold mode is selected, the **Hold Range** annunciator(▼) will be displayed. The default measurement range mode is Auto.

### Range Setup Key



The Range Setup key sets the measurement range. The available measurement range settings are as follows:

- 100 pA (not available for 10 ms measurement time)
- 1 nA
- 10 nA
- 100 nA
- 1  $\mu$ A
- 10  $\mu$ A (not available for 100 ms and 400 ms measurement time)
- 100  $\mu$ A (not available for 30 ms, 100 ms and 400 ms measurement time)

Each measurement range is scaled 1.45 times of the range setup value. The optimum measurement range setting is obtained by the full-scale measurement.

### Comparator Limit Key



The Comparator Limit keys set the comparator upper and lower limit value.

## Trigger Key

The Trigger key triggers a measurement in manual trigger mode.

## Local Key

The Local key returns the 4349B to the local mode (front-panel) operation from the GPIB remote mode (computer controlled). When the 4349B in the remote mode, the **Rmt** annunciator(▼) will be displayed.

## Address Key

The Address key sets the 4349B's GPIB address. The available GPIB addresses are the integer numbers 0 to 30. Address 31 is the talk only mode in which the 4349B sends data through GPIB interface.

In the talk only mode, the output data is,

*<stat1>,<data1>,<comp1>,<stat2>,<data2>,<comp2>,<stat3>,<data3>,<comp3>,<stat4>,<data4>,<comp4>*

Where,

- <stat1-4>* measurement status of each channel
  - 0 : normal
  - 1 : overload
  - 2 : no-contact
- <data1-4>* measurement data of each channel
- <comp1-4>* comparison result of each channel (no output when the comparator function is OFF)
  - 1 : in
  - 2 : high
  - 4 : low
  - 8 : no-contact

The system reset or power-on doesn't affect the address setting.

## Trigger Mode Key

The Trigger mode key toggles three trigger mode— Internal, Manual, or External. The 4349B also has another trigger mode, BUS.

- Internal (Int)** The internal trigger mode. In this mode measurements are free running and continuous. (Default)
- Manual (Man)** The manual trigger mode. In this mode, the 4349B performs a single measurement when the front-panel key  is pressed.
- External (Ext)** The external trigger mode. The 4349B is triggered by a TTL level pulse input through the rear panel External Trigger connector, or through the handler interface. For more information, refer to “External Trigger”.
- Bus** This mode is available only in the GPIB remote mode. In this mode, the GET command and \*TRG command trigger a single measurement.



## 4349B

### Delay Key

The Delay key sets the delay time from the trigger to the actual start of the measurement. The available delay range is 0 ms to 9999 ms with 1 ms resolution. The default delay value is 0 ms.

**Note** The trigger delay time cannot be set individually for each channel. Once you set the trigger delay time, the all channels will use the same delay setting.



### Save Key

The Save key stores the current instrument's settings into non-volatile memory (EEPROM). Saved settings are the same as the backup settings listed in "LINE Switch" description. You must enter the register number, 0 to 9, to assign the register into which the settings will be saved. Up to 10 sets of instrument settings can be saved.

**Caution** The 4349B overwrites the instrument's setting into assigned register without notice, if settings are already stored in the assigned register, they will be lost.







### Recall Key

The Recall key recalls instrument's setting saved in non-volatile memory (EEPROM). You must enter the register number, 0 to 9, to assign the register from which the settings will be recalled. If the register selected is empty, the error message, "RECALL FAILED" is displayed.

### Right/Up Arrow Key and Left/Down Arrow Key



These keys serve the following functions:

- When entering a value,  key increases, and  key decreases a value.
- While 4349B is displaying several items, these keys are used to select (a selected item blinks continuously so we will refer to selecting a setting as blinking a setting) adjacent items in the list (  blinks the previous item and the  blinks the next item).

### 0, . . . , 9, .(point), -(minus) Key . . .

These keys are used to enter numeric data.  terminates data input.

### BLUE Shift Key

The BLUE Shift key activates secondary functions printed above the keys. For example, pressing   executes the OPEN correction.

The BLUE shift key function is cleared by a single execution of a shifted function or by pressing the BLUE shift key again. The **Shift** annunciator(▼) is displayed when the BLUE shift key is toggled to the active mode.

## Exponential Key

The Exponential key is used to enter exponential values.

## Back Space Key

The Back Space key deletes a single preceding character of an input value.

## Enter Key

The Enter key terminates numeric input data and the displayed menu.

## Minimum Key

The Minimum key enters the minimum value during a setting operation.

## Maximum Key

The Maximum key enters the maximum value during a setting operation.

## Comparator Key

The Comparator key toggles comparator function ON and OFF. The default is comparator function OFF.

The Comparator distinguishes whether or not the measurement result is within the upper and lower comparator limits. When the comparator is ON, **Comprtr On** annunciator(▼) will be displayed. The comparison results output are assigned as follows:

Destination	Condition
Comparison Display	: HI, IN, LO, No-Contact
Handler Interface	: HI, IN, LO, No-Contact
Beep (FAIL mode)	: HI, LO, No-Contact
(PASS mode)	: IN

Where,

HI	greater than upper limit
IN	between the upper limit and lower limit
LO	less than lower limit
No-Contact	contact check failed (at contact check ON state)

When a measurement parameter changes, the comparator function is automatically turned OFF.

## 4349B

### Contact Check Key

The Contact Check key toggles the contact check function ON and OFF. The Contact Check function detects a broken cable or miss contact. The decision limit value for a contact is obtained during the OPEN correction procedure. When an OPEN admittance is measured, non-connection capacitance is measured and stored. The 4349B compares this value and DUT's capacitance. The **Cont Chk** annunciator(▼) indicates if the Contact Check function is in the ON state. The default Contact Check function is OFF.



### Open Key

The Open key executes the OPEN correction function. The OPEN correction data is used to cancel the offset error of the 4349B and the leakage of the test fixture. The OPEN correction measures also the stray capacitance for the contact check function. The OPEN correction data is stored in non-volatile memory (EEPROM).

The offset error of 4349B is temperature dependent. For maximum measurement accuracy,

Perform the OPEN correction after warming up the 4349B (30 minutes).

Perform the OPEN correction when ambient temperature changes more  $\pm 5^\circ\text{C}$  from the temperature at which the OPEN correction was performed.

At reset   , the correction data is cleared.

---

#### Note



OPEN correction must be performed at the condition that test lead or fixture are connected to Ch1, Ch2, Ch3, and Ch4 terminals, without DUT.

---



### Key Lock Key

The Key Lock key toggles the disabling and enabling key input from the front panel. When the key input is disabled, the **Key Lock** annunciator(▼) will be displayed.

---

#### Note



The key lock state can be controlled also through the handler interface. When the handler key lock function controls the key lock states, all the front-panel keys are locked out including   , so you can only cancel the key lock out state from handler.

---

## Reset Key

The Reset key resets all instrument settings and correction data to the default values. The 4349B can also be reset by sending GPIB commands :SYST:PRES and \*RST, with the same results, except in a couple of cases. The following table lists the difference among the results of pressing the Reset key and sending the :SYST:PRES and \*RST command, and also lists where the settings are stored.

Data stored in the back-up memory is held for about 72 hours after powering OFF, The items saved by the Save key or recalled by the Recall key are the same as those stored in the back-up memory.

Data stored in the EEPROM is not affected by powering OFF.

**Table 3-1. Reset Settings**

Item	Reset Key	:SYST:PRES <sup>1</sup>	*RST <sup>1</sup>	Stored in
Test voltage value Ch1	0 V	←	←	Back-up memory
Test voltage value Ch2	0 V	←	←	Back-up memory
Test voltage value Ch3	0 V	←	←	Back-up memory
Test voltage value Ch4	0 V	←	←	Back-up memory
Measurement parameter	R	←	←	Back-up memory
Measurement range mode	Auto	←	←	Back-up memory
Measurement range	(Auto)	←	←	Back-up memory
Measurement time mode	30 ms	←	←	Back-up memory
Averaging rate	1	←	←	Back-up memory
Trigger source	Internal	←	←	Back-up memory
Trigger delay	0 s	←	←	Back-up memory
Contact check	OFF	←	←	Back-up memory
Limit data	0	←	←	Back-up memory
Offset data	0	←	←	Back-up memory
Comparator	OFF	←	←	Back-up memory
Comparator Limits	MAX, MIN	←	←	Back-up memory
Display mode	Measurement Data	←	OFF	Back-up memory
Correction	ON	←	OFF	—
Correction data	Cleared	←	←	EEPROM
Beeper	ON	←	←	EEPROM
Beeper mode	FAIL mode	←	←	EEPROM
Data transfer format	ASCII	←	←	EEPROM
Power line frequency	No effect	←	←	EEPROM
GPIB Address	No effect	←	←	EEPROM
Key lock	N/A	No effect	OFF	—
:INTT:CONT	ON	←	OFF	—

<sup>1</sup> “←” indicates the value is the same as what’s indicated to the left.

## 4349B

### Configuration Key

The Configuration key is used to set the beep mode and the power line frequency, and to run the performance tests.

- **Beep**—Comparison results output to the beeper are classified as follows:

Off	no output to beeper.
Pass	beeps when comparison result are IN for all measurement channels.
Fail	beeps when the comparison result is HI, LO, or No-Contact for any channel. (default)

In the beeper **Pass** or **Fail** mode, the 4349B emits a beep whenever a system or operation error occurs. In the beeper **Off** mode, the error beep function is turned OFF.

The setting is saved in the EEPROM.

- **Line**—Available power line frequency selections are 50 Hz and 60 Hz.

The power line frequency setting is stored and does not change after reset or power-off. Once you set it, you do not need to set the line frequency again as long as the power line frequency remains the same.

- **Svc**—There are five service functions:

KEY	test front-panel keys.
HNDL	test the handler output signal.
CSUM	run ROM check sum program.
RAM	read-write test RAM. After the test, the 4349B resets its setting.
EEPROM	test EEPROM. The data stored in EEPROM is not affected if no error detected. If the error detected, the 4349B clears the data and restores the default data.

- **Test** preforms the self-test which tests the 4349B's basic performance and displays the results as the sum of the existing error codes.

Item	Result	Error Code
1. Beeper	beep once	-
2. Display	display all digits and segments	-
3. RAM	display error message if fail <sup>1</sup>	1
4. EPROM	display error message if fail <sup>1</sup>	2
5. Calibration data (EEPROM)	display error message if fail <sup>1</sup>	4
6. User's data (EEPROM)	display error message if fail <sup>2</sup>	8
7. A/D converter	display error message if fail <sup>1</sup>	16
8. Backup RAM	display error message if fail <sup>2</sup>	32

1 During power-on test, the 4349B suspends operation if an error occurs

2 During power-on test, the 4349B takes default, and continues test.

The self-test is also executed at power-on. After the test, the 4349B's settings are not affected.

- **Exit** return to measurement.

## Rear Panel

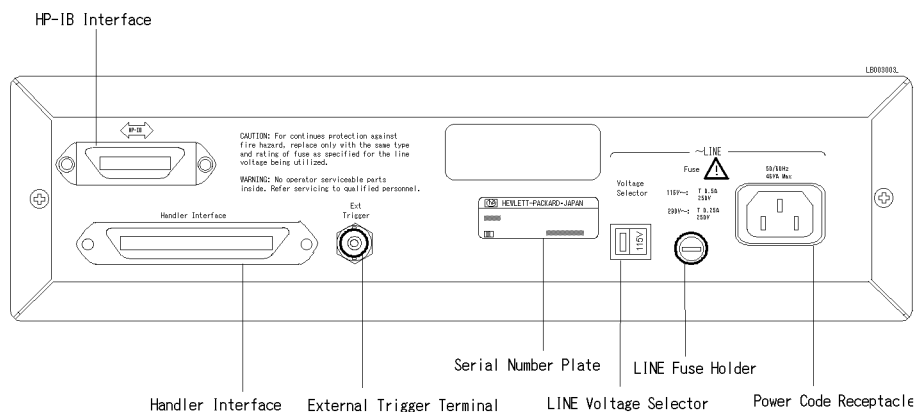

**Figure 3-2. Rear Panel**

## External Trigger

When the 4349B is set to the external trigger mode, the 4349B is triggered by an active-low rising edge TTL pulse input. Figure 3-3 shows the specifications required for the TTL pulse.

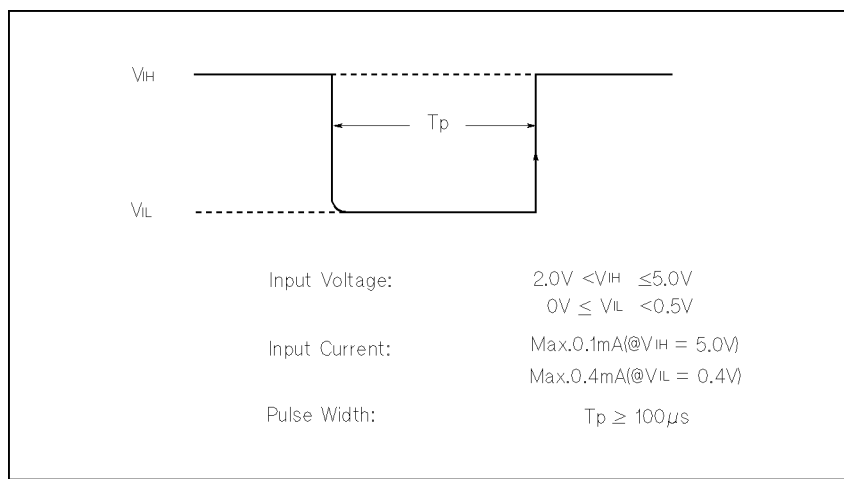

**Figure 3-3. Required External Trigger Pulse Specification**

## 4349B



### LINE Fuse Holder

The 4349B's line fuse is selected depending on the LINE Voltage selection.

### LINE Voltage Selector

The Line Voltage Selector is used to match the 4349B to the power line voltage being used. The line voltage selections are as follows:

**Table 3-2. Line Voltage selection**

Voltage Selector	Line Voltage	Required Fuse
115V	100/120Vac( $\pm 10\%$ )	UL/CSA type, Time delay 0.5A 250V (Agilent part number 2110-0202)
230V	220/240Vac( $\pm 10\%$ )	UL CSA type, Time delay 0.25A 250V (Agilent part number 2110-0201)

### Serial Number Plate

The serial number plate gives manufacturing information about the 4349B. For details, see Appendix A.

### Power Cord Receptacle

The Power Cord Receptacle is used to plug in the power cord.

### Power Cord

The 4349B is equipped with a three-conductor power cord that, when plugged into the appropriate AC power receptacle, grounds the instrument. The offset pin on the power cord is the safety ground.

## Handler Interface

The handler interface is used to synchronize timing with an external handler.

Before using the handler interface, connect the pull-up resistors to enable output signals and set the dip switch to select the voltage of the input signals. Refer to Appendix B for these procedures.

## Specifications

Output signal: Negative true, open collector, opto-isolated

Decision Output:

Comparator High, In, Low  
DUT and test electrode's contact failed.

Index: Analog measurement complete

Measurement complete: Full measurement complete

Alarm: Notification that a momentary power failure was detected.

Input Signal: Opto-isolated

Keylock: Front panel keyboard lockout

External Trigger: Pulse width  $\geq 1 \mu\text{s}$

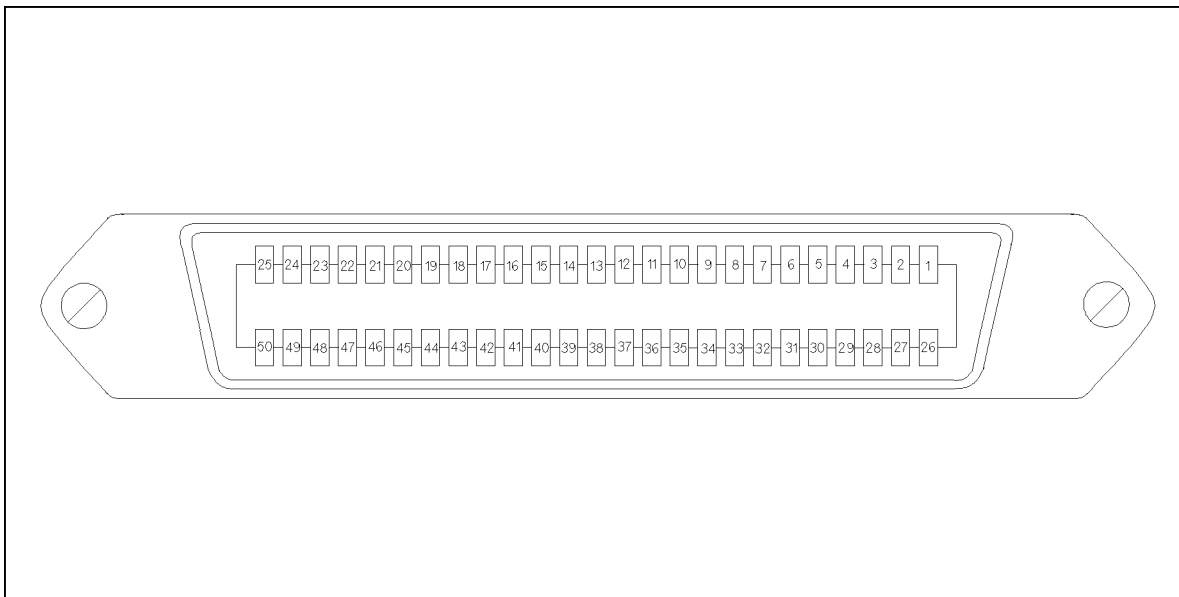

**Figure 3-4. Pin Assignment For Handler Interface Connector**



**Table 3-3. Contact Assignment for Comparator Function**

Pin No.	Signal Name <sup>1</sup>	Description
1 2	EXT DCV1 EXT DCV1	External DC Voltage 1: DC Voltage supply pins for DC isolated open collector outputs (/HI1-4, /IN1-4, /LO1-4, /NO-CONTACT1-4). Maximum voltage input is +24V, minimum +5V.
3	/HI1	This signal is asserted when the comparison result of Ch1 is High. <sup>2</sup>
4	/IN1	This signal is asserted when the comparison result of Ch1 is In. <sup>2</sup>
5	/LO1	This signal is asserted when the comparison result of Ch1 is Low. <sup>2</sup>
6	/HI2	This signal is asserted when the comparison result of Ch2 is High. <sup>2</sup>
7	/IN2	This signal is asserted when the comparison result of Ch2 is In. <sup>2</sup>
8	/LO2	This signal is asserted when the comparison result of Ch2 is Low. <sup>2</sup>
9	/HI3	This signal is asserted when the comparison result of Ch3 is High. <sup>2</sup>
10	/IN3	This signal is asserted when the comparison result of Ch3 is In. <sup>2</sup>
11	/LO3	This signal is asserted when the comparison result of Ch3 is Low. <sup>2</sup>
12	/HI4	This signal is asserted, when the comparison result of Ch4 is High. <sup>2</sup>
13	/IN4	This signal is asserted, when the comparison result of Ch4 is In. <sup>2</sup>
14	/LO4	This signal is asserted, when the comparison result of Ch4 is Low. <sup>2</sup>
18	/KEY LOCK	KEY LOCK: When this line is asserted, all of the 4349B's front panel key functions are disabled.
19	/EXT TRIG	EXT TRIG: The 4349B is triggered on the rising edge of a pulse applied to this pin when the trigger mode is set to External <sup>3</sup>
20 21	EXT DCV2 EXT DCV2	External DC voltage 2: DC voltage supply pins for DC isolated inputs (/EXT TRIG, /KEY LOCK) and DC isolated outputs (/ALARM, /INDEX, /EOM). Maximum voltage input is +15V, minimum +5V.
24 25	+5 V +5 V	Internal voltage supply (max. output 0.1A): Exceeding 0.1A will cause the internal voltage output and the output signals to go to zero.
26 27	COM1 COM1	Common for EXT DCV1.
28	NO CONTACT1	This signal is asserted when the contact check failed at Ch1. <sup>2</sup>
31	NO CONTACT2	This signal is asserted when the contact check failed at Ch2. <sup>2</sup>
34	NO CONTACT3	This signal is asserted when the contact check failed at Ch3. <sup>2</sup>
37	NO CONTACT4	This signal is asserted when the contact check failed at Ch4. <sup>2</sup>

1 The / (slash) means that the signal is asserted when low.

2 If an error occurs and the 4349B stops operation, these lines retain the condition that existed just before the error occurs.

3 If an error occurs and the 4349B stops operation, the 4349B will not trigger a measurement if it receives the /EXT TRIG signal.

**Table 3-3. Contact Assignment for Comparator Function (continued)**

Pin No.	Signal Name <sup>1</sup>	Description
42	/ALARM	Alarm: This signal is asserted when a power failure or the error (E11, E12, E13, E14, E15, E20, or E313) occurs. The signal length is 200ms.
43	/INDEX	Index: This signal is asserted when an analog measurement is completed and the 4349B is ready for the next DUT to be connected to the INPUT terminals. The measurement data, however, is not valid until /EOM is asserted. <sup>2</sup>
44	/EOM	End of Measurement: This signal is asserted when the measurement data and comparison results are valid. <sup>2</sup>
45	COM2	Common for EXT DCV2.
46	COM2	
49	GND	Ground tied to chassis.
50	GND	

---

**Note** All the output signals are available only when the comparator function is ON.



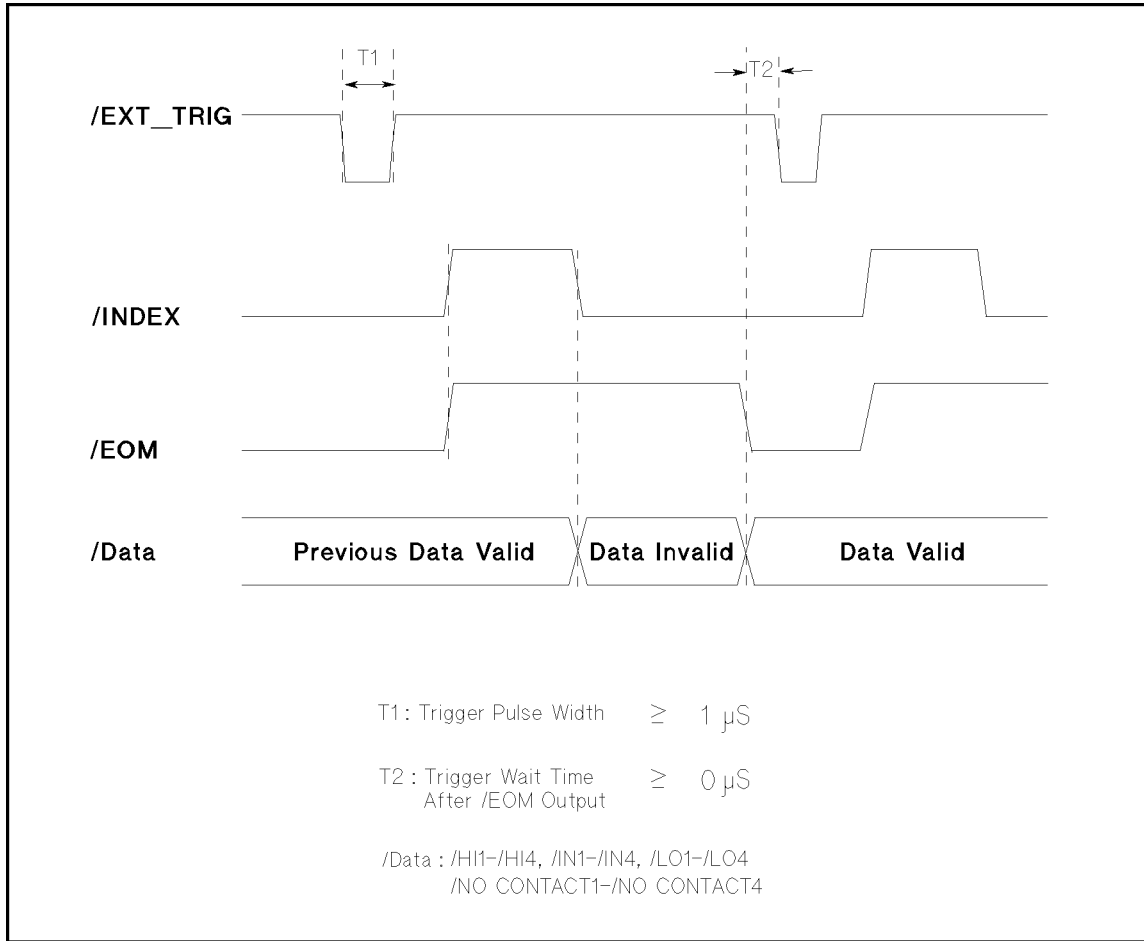

**Figure 3-5. Timing Diagram**

**Note**



This timing diagram is also applied when the contact check fails. Because the measurement is performed and the measurement result is output, even if the contact check fails.

## GPIB Interface

GPIB Interface is used for remote control of the 4349B using the Hewlett-Packard Interface Bus(GPIB).

GPIB is an instrument interface standard. This supports worldwide standards IEEE 488.1, IEC-625, IEEE 488.2, and JIS-C1901. The GPIB interface allows the instrument to be controlled by an external computer that sends commands or instructions to and receives data from the instrument via GPIB. It also defines handshaking, addressing, and the general protocol used for transmitting individual bytes of data between instruments and a controller.

With an GPIB system, many different types of devices including instruments, computers, plotters, and printers can be connected in parallel. When configuring an GPIB system, the following restrictions must be adhered to:

- The length of cable between one device and another must be less than or equal to four meters. The total length of cable in one bus system must be less than or equal to two meters times the number of devices connected on the bus (the GPIB controller counts as one device) and the total length of cable must not exceed 20 meters.
- A maximum of 15 devices can be connected on one bus system.
- There are no restrictions on how the cables are connected together. However, it is recommended that no more than four piggyback connectors be stacked together on any one device. The resulting structure could exert enough force on the connector mounting to damage it.

Every GPIB device has a unique address for identification. The available gpib addresses are the integer values 0 to 30. Any device on an GPIB bus must have a unique address otherwise there will be bus contention as devices with the same address try to use the bus at the same time.

Every GPIB device must be capable of performing one or more of the following interface functions:

<b>Talker</b>	A talker sends device-dependant data when addressed to talk. In a GPIB system, there can be only one active talker at any given time.
<b>Listener</b>	A listener receives device-dependant data when addressed to listen. In an GPIB system, there can be any number of active listener at any given time.
<b>Controller</b>	A controller manages the operation of the bus and addresses talker's and listener's. In an GPIB system, there can be only one active controller at any time.

Table 3-4 lists the 4349B's gpib capability and functions. These functions provide the means for an instrument to receive, process, and transmit commands, data, and status over the gpib bus.

**Table 3-4. GPIB Interface Capability**

<b>Code</b>	<b>Function</b>
SH1	Complete Source Handshake capability
AH1	Complete Acceptor Handshake capability
T5	Basic Talker; serial poll; unaddressed if MLA; Talk-Only
L4	Basic Listener; unaddressed if MTA; no Listen Only
SR1	Service Request capability
RL1	Remote/Local capability
DC1	Device Clear capability
DT1	Device Trigger capability
C0	No Controller capability
E1	Drivers are open-collector

## Theory of Operation

This section provides the 4349B's theory of operation.

### Overall Measurement Theory

The 4349B measures the resistance of the Device Under Test (DUT) in the following manner.

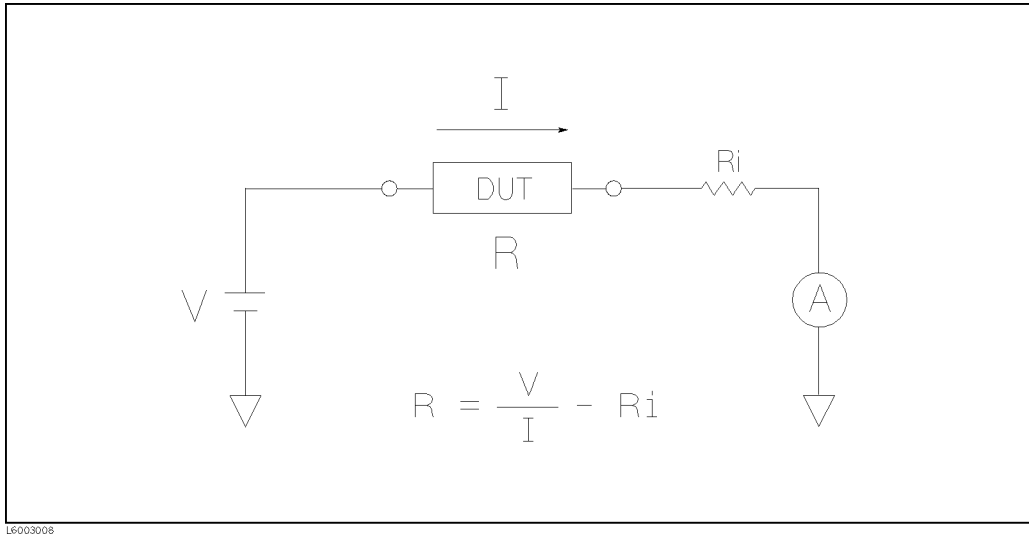

**Figure 3-6. Simplified Model of the 4349B**

Figure 3-6 shows the simplified model of the 4349B measuring a DUT. In Figure 3-6, a DUT is connected in series with test voltage source  $V$ , and ammeter  $A$ .  $R_i$  is the 4349B's input resistance ( $R_i = 1k\Omega$ ).

In the current measurement mode (the measurement parameter is  $I$ ), the 4349B displays the actual current  $I$  for the measurement result. For example, if  $R$  is  $100k\Omega$ , and  $V$  is  $1V$ , the measurement result will be  $9.9\mu A$  ( $\frac{1}{100k+1k}$ ).

In the resistance measurement mode (the measurement parameter is  $R$ ), the 4349B displays the "derived" DUT resistance,  $R$ , which coincides with the actual DUT resistance. In other words, if the ammeter measures  $I$  when the source voltage is  $V$ , the 4349B displays the DUT resistance  $R$ , calculated using the following equation:

$$R = \frac{V}{I} - R_i$$

## Overall Block Diagram

Figure 3-7 shows the overall block diagram of the 4349B.

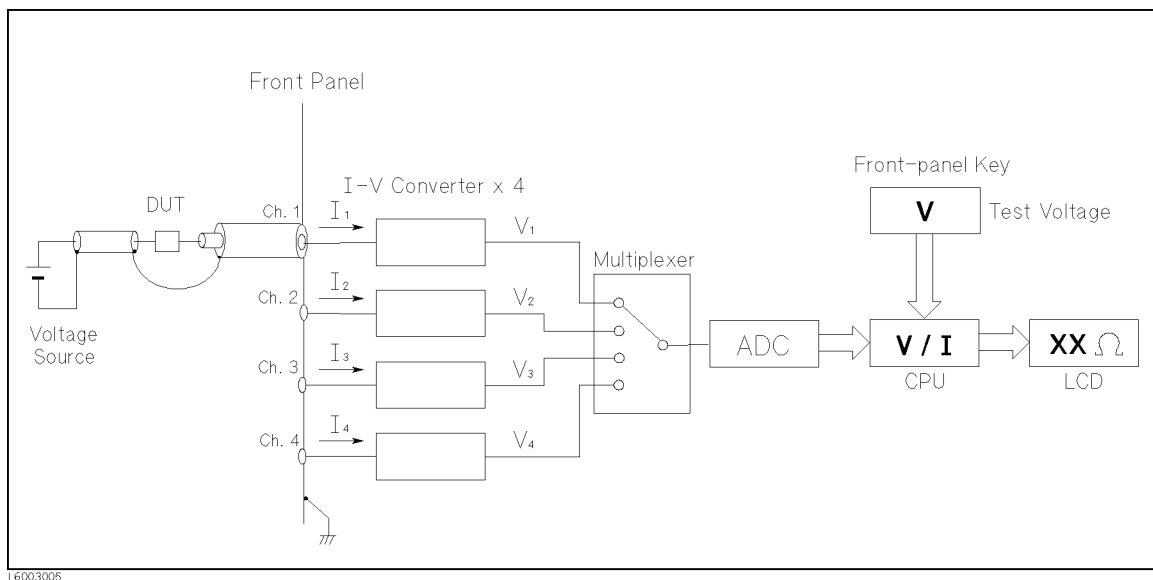

**Figure 3-7. 4349A Overall Block Diagram**

The 4349B doesn't have a test voltage source, and an external voltage source must be supplied for operation. The 4349B has four input channels, from which the test current flowing through the DUT are input. The multiplexer switches four channels on a single measurement trigger. Each  $V$ , which is proportional to the input  $I$ , is analog-to-digital converted. The CPU calculates  $I$  from the converted data, then calculates the DUT's resistance  $R$ , by dividing the measurement voltage by the measured current.

### Note



The test voltage is data which must be input by the front-panel keys or through GPIB interface. The 4349B itself has neither voltage output nor voltage measurement capability.

**Contact check feature**

The contact check feature of the 4349B measures the capacitance of the DUT using a 480-kHz ac signal (OSC1) and makes the judgment of Contact/NO Contact from whether the result is greater than the limit vale. The limit value used for the judgment is determined by the following equation using the capacitance in the Open state (Cs) measured when the Open correction was executed.

$$\text{Limit} = C_s * 1.035 + 0.40 * 10E-12 + \text{offset}$$

Where offset is any value the user can set. Usually set it to 0 (default value).

For the 4349B, when measuring capacitance in the contact check and the Open correction, an ac signal with the same phase as OSC1 is applied from OSC2 to the inner shield to reduce the effect of C1 and C0. However, because it is impractical to apply an ac signal with the completely same phase to both the core wire and the inner shield considering the input resistance (1kΩ) of the ammeter, some residual capacitance is observed. Especially when the coaxial extension cable is long, this residual capacitance becomes larger.

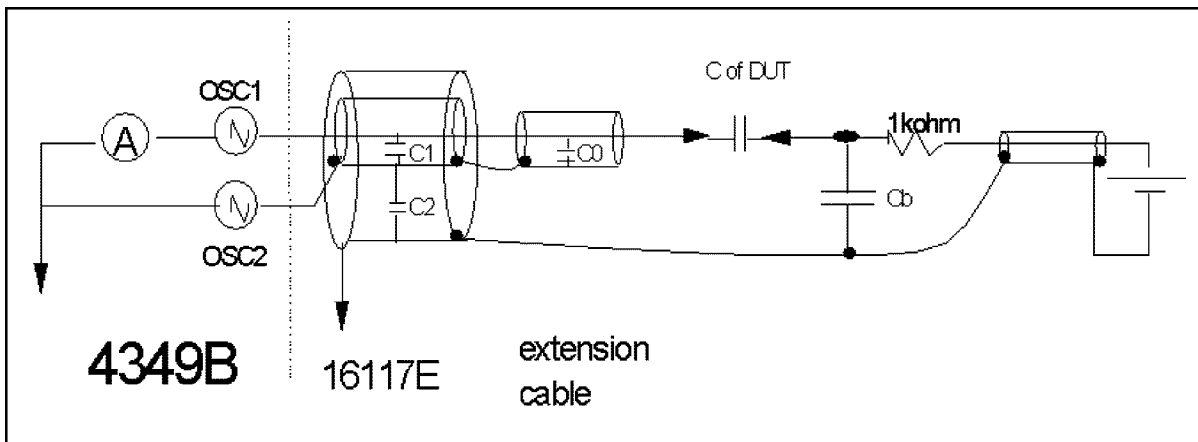

1b0j3006

**Figure 3-8.**

The contact check is performed at the following timing.

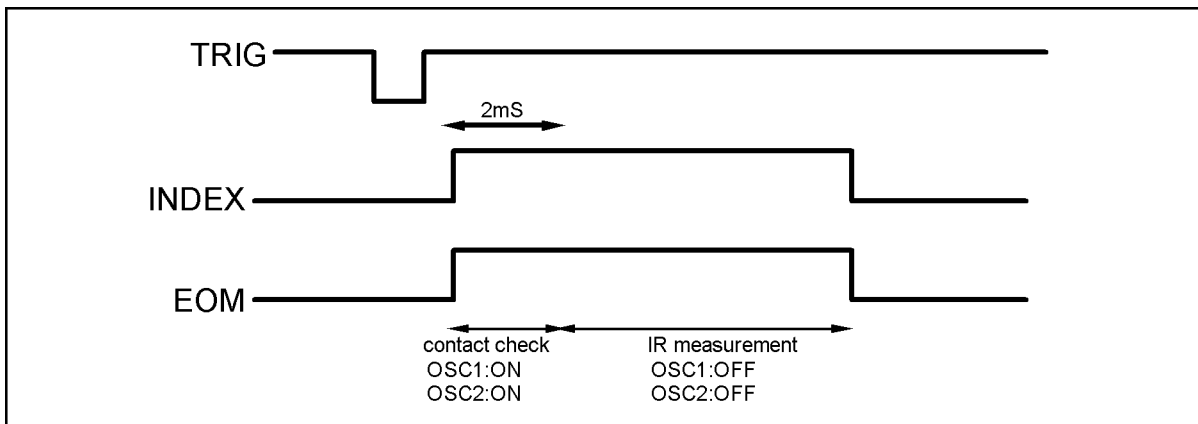

1b0j3007

**Figure 3-9.**





## Remote Operation

---

### Introduction

This chapter provides step-by-step instructions for controlling the 4349B using GPIB remote mode. The examples in this manual use the HP 9000 series 200 or 300 BASIC language. This chapter covers the following:

- Getting started
- Setting up the 4349B
- Triggering a measurement
- Retrieving measurement data
- Other features
- If you have a problem

Refer to Chapter 5 for the description of each GPIB command.

---

#### Note



This chapter is not intended to teach BASIC programming language or the Standard Commands for Programmable Instruments (SCPI) programming, or to discuss GPIB theory; refer to the following documents which are better suited for these tasks.

For more information concerning BASIC, refer to the manual set for the BASIC version being used:

*BASIC Programming Techniques*  
*BASIC Language Reference*

For more information concerning SCPI, refer to the following:

*Beginner's Guide to SCPI*

For more information concerning GPIB operation, refer to the following:

*BASIC Interfacing Techniques*  
*Tutorial Description of the General Purpose Interface Bus*  
*Condensed Description of the General Purpose Interface Bus*

---

## Getting Started

This section will teach you the basics of operating the 4349B in GPIB remote mode (from now on referred to as remote). This includes reading the GPIB address, sending commands to the 4349B, and retrieving data from the 4349B.

### Input/Output Statements

The statements used to operate the 4349B in remote depend on the computer and the programming language being used. In particular, you need to know the statements the language uses to input and output information. For example, the input statements for the HP 9000 series 200 or 300 BASIC language are:



ENTER or TRANSFER

The output statement is:

OUTPUT

Read your computer manuals to find out which statements you need to use.

### Reading the GPIB Address

Before you can operate the 4349B in remote, you need to know its GPIB address (factory setting=17). To check the address, press  . A typical display is:

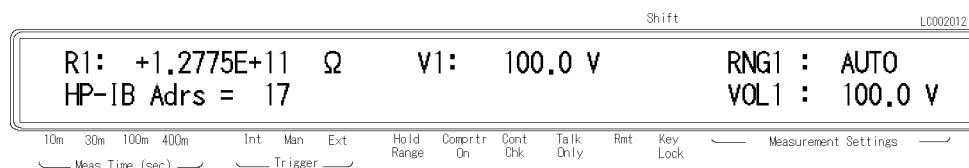

The displayed response is the device address. When sending a remote command, you append this address to the GPIB interface's select code (normally 7). For example, if the select code is 7 and the device address is 17, the appended combination is 717.

Every device on the GPIB bus must have a unique address. You can assign new GPIB addresses.

### Sending a Remote Command



To send a remote command to the 4349B, combine the computer's output statement with the GPIB select code, the device address, and finally the 4349B command. For example, to reset the 4349B, send:

```
OUTPUT 717;"*RST"
```

Notice that the display's **Rmt** annunciator(▼) is ON. This means the 4349B is in the remote mode.

## 4349B

### Returning to Local Mode

When you press a key on the 4349B's keyboard while operating in remote, the 4349B does not respond. This is because in remote (as indicated by the display's **Rmt** annunciator) the 4349B ignores all front panel inputs except the  key. To return the 4349B to the Local mode, press the .

### Query Commands

There are several commands in the alphabetic command directory that end with a question mark. These commands are called query commands because each returns a response to a particular question.

In addition to the queries described above, you can create others by appending a question mark to most commands.

### Getting Data from the 4349B

The 4349B can output readings and responses to query commands. As an example, have the 4349B generate a response to a query command by sending:

```
OUTPUT 717;"*IDN?"
```

When you send a query from remote, the 4349B does not display the response as it did when you executed the command from its front panel. Instead, the 4349B sends the response to its output buffer. The output buffer is a register that holds a query response or data for a single measurement until it is read by the computer or replaced by new information. Use the computer's input statement to get the response from the output buffer. For example, the following program reads the response (4349B) and prints it.

```
10 ENTER 717;A$  
20 PRINT A$  
30 END
```

## To Control the 4349B from an External Computer

Most measurements can be modeled the following simple three step sequence:

1. Set up the 4349B.

Typically, you begin the setup step by sending the reset command to set the instrument to its default settings. Next, if you need values different from the default settings, change the settings one by one as required.

2. Trigger the measurement.

The trigger may be generated automatically by steps taken in your setup commands, or you can send an explicit trigger command.

3. Retrieve the measurement data

The following sections describes how to perform the tasks at each step.

Figure 4-1 shows a simple resistance measurement program.

```

:
! Step 1
OUTPUT 717;"*RST"           Resetting
OUTPUT 717;" :INIT:CONT ON" Initiating trigger system
OUTPUT 717;" :SENS:FUNC 'RESI'" Resistance Measurement
OUTPUT 717;" :SOUR:VOLT1 100" Ch 1 Test Voltage: 100 V
OUTPUT 717;" :SOUR:VOLT2 100" Ch 2 Test Voltage: 100 V
OUTPUT 717;" :SOUR:VOLT3 100" Ch 3 Test Voltage: 100 V
OUTPUT 717;" :SOUR:VOLT4 100" Ch 4 Test Voltage: 100 V
! Step 2
OUTPUT 717;" :TRIG:SOUR BUS" Trigger Source: BUS
OUTPUT 717;"*TRG"           Triggering
! Step 3
ENTER 717;S1,D1,S2,D2,S3,D3,S4,D4 Retrieving Readings
PRINT S1,D1,S2,D2,S3,D3,S4,D4
:

```

**Figure 4-1. Simple Resistance Measurement Program Example**

## To Set Up the 4349B

### To Reset the 4349B

The following commands reset the 4349B:

- \*RST
- :SYST:PRES

---

**Note**            \*RST initiates the trigger system also.



---

For example,

```
OUTPUT 717; "*RST"
```

### To Set the LINE Frequency

The following command sets the LINE frequency:

- :SYST:LFR

For example, to set the LINE frequency to 50 Hz,

```
OUTPUT 717; "SYST:LFR 50"
```

### To Perform the OPEN Correction

The following commands perform the OPEN correction:

- :SENS:CORR
- :SENS:CORR:COLL

For example,

```
OUTPUT 717; ":SENS:CORR:COLL OFFS"
```

### To Select the Measurement Parameter

The following command selects the measurement parameters:

- :SENS:FUNC

To select the resistance mode,

```
OUTPUT 717; ":SENS:FUNC 'RESI' "
```

To select the current mode,

```
OUTPUT 717; ":SENS:FUNC 'CURR' "
```

### To Enter Voltage Value

The following command enters the voltage value used to calculate the resistance value:

■ :SOUR:VOLT{1|2|3|4}

{1|2|3|4} means that one of the four numbers is attached to the root mnemonic to give the channel number.

For example, to enter the voltage value for the channel 1 to 100 V,

```
OUTPUT 717;":SOUR:VOLT1 100"
```

### To Select the Measurement Range

The following commands select the measurement range:

■ :SENS:CURR:RANG{1|2|3|4}

■ :SENS:CURR:RANG{1|2|3|4}:AUTO

For example, to select the auto range,

```
OUTPUT 717;":SENS:CURR:RANG1:AUTO ON"
```

For example, to set the 10  $\mu$ A range,

```
OUTPUT 717;":SENS:CURR:RANG1:AUTO OFF"
OUTPUT 717;":SENS:CURR:RANG1 1E-5"
```

### To Set the Measurement Time Mode

The following command sets the measurement time:

■ :SENS:CURR:APER

To set the measurement time to 10 ms,

```
OUTPUT 717;":SENS:CURR:APER 0.01"
```

To set the measurement time to 30 ms,

```
OUTPUT 717;":SENS:CURR:APER 0.03"
```

To set the measurement time to 100 ms,

```
OUTPUT 717;":SENS:CURR:APER 0.1"
```

To set the measurement time to 400 ms,

```
OUTPUT 717;":SENS:CURR:APER 0.4"
```

## 4349B

### To Set the Averaging rate

The following commands set the averaging rate:

- :SENS:AVER
- :SENS:AVER:COUN

For example, to set the averaging rate to 4,

```
OUTPUT 717;":SENS:AVER:COUN 4"
```

### To Set the Trigger Delay time

The following command sets the trigger delay time:

- :TRIG:DEL

For example, to set the trigger delay time to 10 ms,

```
OUTPUT 717;":TRIG:DEL 1E-2"
```

### To Perform the Contact Check

The following command performs the contact check function:

- :SENS:RES:CONT:VER

For example,

```
OUTPUT 717;":SENS:RES:CONT:VER ON"
```

### To Set the Beeper Mode

The following commands set the beeper mode:

- :SYST:BEEP
- :SYST:BEEP:STAT
- :CALC{1|2|3|4}:LIM:BEEP
- :CALC{1|2|3|4}:LIM:BEEP:COND

For example, to set the beeper mode to emit a beep when comparison result is PASS,

```
OUTPUT 717;":CALC1:LIM:BEEP:COND PASS"
```

### To Lock Out the Front Panel Keys

The following command locks out the front panel keys:

- :SYST:KLOC

For example,

```
OUTPUT 717;":SYST:KLOC ON"
```

## To Use the Comparator Function

The following commands operate the comparator function:

- CALC{1|2|3|4}:LIM:LOW
- CALC{1|2|3|4}:LIM:LOW:STAT
- CALC{1|2|3|4}:LIM:UPP
- CALC{1|2|3|4}:LIM:UPP:STAT
- CALC{1|2|3|4}:LIM:STAT
- CALC{1|2|3|4}:LIM:BEEP
- CALC{1|2|3|4}:LIM:BEEP:COND
- CALC{1|2|3|4}:LIM:CLE
- CALC{1|2|3|4}:LIM:FAIL?
- CALC{1|2|3|4}:PATH?
- DISP:ENAB
- DISP:WIND{1|2|3|4}
- DISP:WIND{1|2|3|4}:TEXT1:PAGE

For example, to set the limit values for channels 1 to 4, and to enable the comparator function,

```

:
OUTPUT 717;":CALC1:LIM:LOW 1E12;UPP 1E13"
OUTPUT 717;":CALC2:LIM:LOW 1E12;UPP 1E13"
OUTPUT 717;":CALC3:LIM:LOW 1E12;UPP 1E13"
OUTPUT 717;":CALC4:LIM:LOW 1E12;UPP 1E13"
OUTPUT 717;":CALC1:LIM:STAT ON"
:
OUTPUT 717;":FETC?"
ENTER 717;S1,D1,C1,S2,D2,C2,S3,D3,C3,S4,D4,C4
:

```

## To Wait Until Previously Sent Commands are Completed

The following commands make the 4349B wait until the previously sent commands are completed.

- \*OPC
- \*OPC?
- \*WAI

For example, to wait until the OPEN correction is completed,

```

OUTPUT 717;":SENS:CORR:COLL OFF"      Perform OPEN Correction
OUTPUT 717;":*OPC?"                  Wait for OPEN Correction completion
ENTER 717;A

```



## 4349B

### To Get the Current Instrument Settings

The following command gets the current instrument settings.

- \*LRN?

For example,

```
DIM A$[1000]
:
OUTPUT 717;"*LRN?"
ENTER 717;A$
PRINT A$
```

### To Save and Recall Instrument Settings

The following commands save and recall instrument settings.

- \*SAV
- \*RCL

To save the instrument settings to register no. 1,

```
OUTPUT 717;"*SAV 1"
```

To recall the instrument settings from register no. 1,

```
OUTPUT 717;"*RCL 1"
```

## To Trigger a Measurement

The following commands are used to trigger measurements from an external controller and to handle the 4349B's trigger system. Refer to "Trigger System" in Chapter 5 for the information about the 4349B's trigger system.

- :TRIG
- :TRIG:SOUR
- :INIT
- :INIT:CONT
- :ABOR
- \*TRG
- :FETC?
- Group Execution Trigger (GET)

For example, to set the Internal trigger mode:

```

:
OUTPUT 717;":TRIG:SOUR INT"
OUTPUT 717;":INIT:CONT ON"
LOOP
  OUTPUT 717;":FETC?"
  ENTER 717;S1,D1,S2,D2,S3,D3,S4,D4
  PRINT S1,D1,S2,D2,S3,D3,S4,D4
END LOOP
:

```

For example, to set to the Manual trigger mode:

```

:
OUTPUT 717;":STAT:OPER:ENAB 16"
OUTPUT 717;":*SRE 128"
ON INTR 7 GOSUB Data_available
ENABLE INTR 7;2
!
OUTPUT 717;":TRIG:SOUR MAN"
OUTPUT 717;":INIT:CONT ON"
LOOP
  LOCAL 717 ! Press the Trig key.
END LOOP
!
Data_available: !
OUTPUT 717;":FETC?"
ENTER 717;S1,D1,S2,D2,S3,D3,S4,D4
PRINT S1,D1,S2,D2,S3,D3,S4,D4
A=SPOLL(717)
OUTPUT 717;":STAT:OPER?"
ENTER 717;A
ENABLE 7;2
RETURN
:

```

## 4349B

For example, to set to the External trigger mode:

```
:
OUTPUT 717;":STAT:OPER:ENAB 16"
OUTPUT 717;":*SRE 128"
ON INTR 7 GOSUB Data_available
ENABLE INTR 7;2
!
OUTPUT 717;":TRIG:SOUR EXT"
OUTPUT 717;":ININ:CONT ON"
LOOP ! Apply trigger signals from the external trigger source.
END LOOP
!
Data_available: !
OUTPUT 717;":FETC?"
ENTER 717;S1,D1,S2,D2,S3,D3,S4,D4
PRINT S1,D1,S2,D2,S3,D3,S4,D4
A=SPOLL(717)
OUTPUT 717;":STAT:OPER?"
ENTER 717;A
ENABLE 7;2
RETURN
:
```

For example, to set to the Bus trigger mode:

Using the \*TRG IEEE 488.2 Common Command,

```
OUTPUT 717;":TRIG:SOUR BUS"
OUTPUT 717;":*TRG"
ENTER 717;S1,D1,S2,D2,S3,D3,S4,D4
```

Using the Group Execution Trigger (GET):

```
OUTPUT 717;":TRIG:SOUR BUS"
TRIGGER 717
ENTER 717;S1,D1,S2,D2,S3,D3,S4,D4
```

For example, triggering a measurement regardless of the trigger source:

```
OUTPUT 717;":TRIG"
OUTPUT 717;":FETC?"
ENTER 717;S1,D1,S2,D2,S3,D3,S4,D4
```

## To Retrieve Data Efficiently

The basic procedure to retrieve measurement data is described in "To Trigger a Measurement". This section describes how to retrieve the measurement data efficiently.

### To Transfer Data Using the Real Data Format

The following command transfers data faster by using the real data format to transfer the data:

■ :FORM REAL

For example,

```
ASSIGN @Binary TO 717;FORMAT OFF
:
OUTPUT 717;":FORM REAL"
OUTPUT 717;":FETC?"
ENTER @Binary USING "#,4A";A$
ENTER @Binary;S1,D1,S2,D2,S3,D3,S4,D4
ENTER @Binary USING "#,A";A$
PRINT S,D1,D2
:
```

### To Use Data Buffer

The following commands use the data buffer function:

■ :DATA?

■ :DATA:POIN

■ :DATA:FEED

■ :DATA:FEED:CONT

For example,

```
:
OPTION BASE 1
DIM D(600)
:
OUTPUT 717;":TRIG:SOUR BUS"
!
OUTPUT 717;":DATA:POIN DBUF,50"
OUTPUT 717;":DATA:FEED DBUF,'SENS'"
OUTPUT 717;":DATA:FEED:CONT DBUF,ALW"
!
FOR I=1 TO 50
  OUTPUT 717;":TRIG"
NEXT I
!
OUTPUT 717;":DATA? DBUF"
ENTER 717;D(*)
PRINT D(*)
:
```

---

## Other Features

### To test the 4349B

The following command runs the 4349B's internal self test:

- \*TST?

For example,

```

:
OUTPUT 717;"*TST?"
ENTER 717;A
IF A<>0 THEN PRINT "Self Test: Error"
:

```

### To Report the Instrument's Status

The following commands report the instrument's status:

- \*CLS
- \*ESE
- \*ESE?
- \*ESR?
- \*SRE
- \*SRE?
- \*STB?
- :STAT:OPER?
- :STAT:OPER:COND?
- :STAT:OPER:ENAB
- :STAT:QUES?
- :STAT:QUES:COND?
- :STAT:QUES:ENAB
- :STAT:PRES
- HP BASIC SPOLL command

For example, to generate a service request whenever an error is placed in the error queue.

```
OUTPUT 717;"*ESE 52; *SRE 32"
```

For example, to detect the measurement completion:

```

OUTPUT 717;":SYST:OPER:ENAB 16"      Enable Measurement bit of Operation Status Register
OUTPUT 717;"*SRE 128"                Enable Operation Status Register Summary bit
REPEAT                                Wait until Operation Status Register Summary bit
  A=SPOLL(717)                        is set
UNTIL BIT(A,7)

```

For example, to generate an interrupt when an error occurs in the 4349B:

```

:
DIM Err$(50)
!
:
OUTPUT 717;"*CLS"           Clears status byte register
OUTPUT 717;"*ESE 48"       Sets Command Error Bit and Execution Error Bit
OUTPUT 717;"*SRE 32"       Sets Standard Event Status Register Summary Bit
!
ON INTR 7 GOSUB Err_report  Tells where to branch to when interrupted
ENABLE INTR 7;2             Enable an interrupt from GPIB interface
!
:
LOOP
:
END LOOP
STOP
!
Err_report:!
Stat=SPOLL(717)             Clears the SRQ bit of the Status Byte
OUTPUT 717;"*ESR?"         Asks contents of the Standard Event Status Register
ENTER 717;Estat
PRINT "Syntax Error detected."
!
OUTPUT 717;":SYST:ERR?"    Asks to output error number and message
ENTER 717;Err,Err$
PRINT Err,Err$
!
ENABLE INTR 7
RETURN
END

```

## **If You Have a Problem**

Check all GPIB addresses and connections; most GPIB problems are caused by an incorrect address and bad or loose GPIB cables.

### **If the 4349B Hangs Up When You Send the ABORt Command**

- Send the device clear command to the 4349B:

For example,

```
CLEAR(717)
```





## GPIB Reference

---

### Introduction

This chapter provides reference information for the gpib commands used to control the 4349B in the gpib remote mode.

- GPIB Commands
- Status Reporting Structure
- Trigger System
- Data Transfer Format

The 4349B can be operated using the General Purpose Interface Bus(GPIB). GPIB commands correspond to the Standard Commands for Programmable Instruments(SCPI). SCPI is the instrument command language for controlling instrument that goes beyond IEEE 488.2 to address a wide variety of instrument functions in a standard manner.

---

### GPIB Commands

GPIB commands can be separated into two groups: common commands and subsystem commands.

#### Common Commands

Common commands are generally not measurement related, but are used to manage macros, status registers, synchronization, and data storage. All common commands begin with an asterisk. Common commands are defined in the IEEE 488.2 standard.

#### Common Commands

*CLS		*OPC		*SRE	<numeric_value>
*ESE	<numeric_value>	*OPC?		*SRE?	
*ESE?		*OPT?		*STB?	
*ESR?		*RCL	<numeric_value>	*TRG	
*IDN?		*RST		*TST?	
*LRN?		*SAV	<numeric_value>	*WAI	

#### Subsystem Commands

Subsystem commands include all measurement functions and some general purpose functions. Each subsystem is a set of commands that roughly corresponds to a functional block inside the instrument. For example, the SOURce subsystem contains commands for signal generation, while the STATus subsystem contains commands for accessing status registers.

Subsystem commands have a hierarchical structure, called a **command tree**, which consists of several key words separated by a colon between each word.

## Subsystem Commands

Command	Parameter	Note
ABORt		no query
CALCulate{1 2 3 4}		
:LIMit		
:BEEPer		
:CONDition	{FAIL   PASS}	
[:STATe]	< Boolean >	
:CLEAr		no query
:FAIL?		query only
:LOWer		
[:DATA]	< numeric_value >	
:STATe	< Boolean >	
:STATe	< Boolean >	
:UPPer		
[:DATA]	< numeric_value >	
:STATe	< Boolean >	
:PATH?		
DATA		
[:DATA]?	DBUF	query only
:FEED	DBUF,< data_handle >	
:CONTRol	DBUF,{ALWays NEVer}	
:POINts	DBUF,< numeric_value >	
DISPlay		
:ENABle	< Boolean >	
:WINDow{1 2 3 4}		
[:STATe]	< Boolean >	
:TEXT1		
:DIGit	{3 4 5}	
:PAGE	{1 2}	
:TEXT2		
:PAGE	{1 2 3}	
FETCh?		query only
FORMat		
[:DATA]	{ASCIi REAL[,64]}	
INITiate		
:CONTInuous	< Boolean >	
[:IMMEdiate]		no query
[SENSe]		
:AVERage		
:COUNt	< numeric_value >	
[:STATe]	< Boolean >	
:CORRection		
:COLLect		
[:ACQuire]	OFFSet	no query
:DATA{1 2 3 4}?	{OFFSet SCAPacitance}	no query
[:STATe]	< Boolean >	

## Subsystem Commands (continued)

Command	Parameter	Note
[SENSe] (continued)		
:CURRent		
:APERture	<numeric_value>[MS S]	
:RANGe{1 2 3 4}		
:AUTO	<Boolean>	
[:UPPer]	<numeric_value>[PA NA UA MA A]	
:FUNctIon	<sensor_function>	
:CONtAct		
:DATA{1 2 3 4}?		query only
:LIMit{1 2 3 4}?		query only
:OFFSet{1 2 3 4}	<numeric_value>[PF F]	
:VERify	<Boolean>	
SOURce		
:VOLTage{1 2 3 4}		
[:LEVel]		
[:IMMediate]		
[:AMPLitude]	<numeric_value>	
STATus		
:OPERation		
:CONDition?		query only
:ENable	<numeric_value>	
[:EVENT]?		query only
:PRESet		
:QUEStionable		
:CONDition?		query only
:ENable	<numeric_value>	
[:EVENT]?		query only
SYSTem		
:BEEPer		
[:IMMediate]		
:STATe	<Boolean>	
:ERRor?		query only
:KLOCK	<Boolean>	
:LFRequency	<numeric_value>	
:PRESet		
:VERSion?		query only
TRIGger		
:DELay	<numeric_value>[MS S]	
[:IMMediate]		no query
:SOURce	{BUS EXTeRnal INTeRnal MANual}	

## Subsystem Command Tree

Top of the subsystem command tree is called the **root command**, or simply the **root**. To reach the low-level commands, you must specify a particular **path** just like you would specify a DOS file directory path. After Power ON or after an \*RST command, the current path is set to the root. The path settings are changed as follows:

**Message Terminator** A message terminator, such as <new line> character, sets the current path to the root.

**Colon (:)** When a colon is placed between two command mnemonics, the colon moves the current path down one level on the command tree. When the colon is the first character of a command, it specifies the following command mnemonic is a root-level command.

**Semicolon (;)** A semicolon separates two commands in the same message without changing the current path.

Common commands, such as \*RST, are not part of any subsystem. The 4349B interprets them in the same way, regardless of the current path setting.

Figure 5-1 shows examples of how to use the colon and semicolon to navigate efficiently through the command tree.

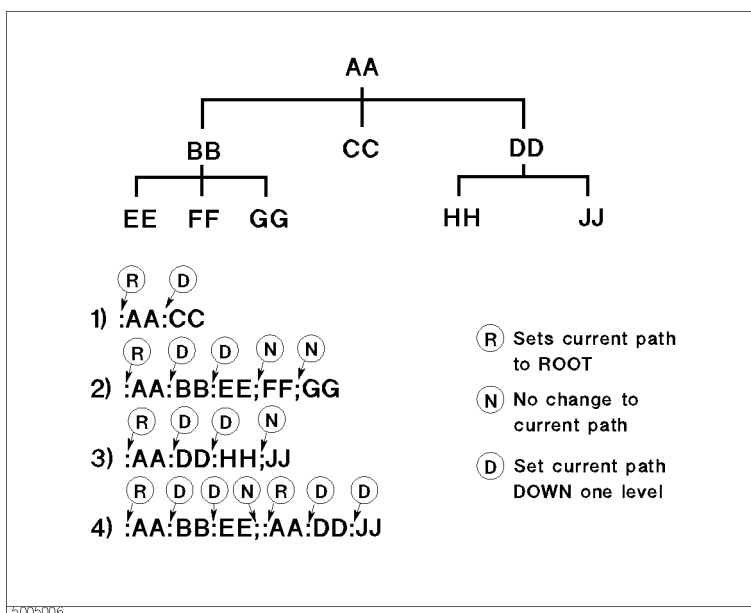

Figure 5-1. Proper Use of the Colon and Semicolon

In Figure 5-1, notice how proper use of the semicolon can save typing. Sending this message:

```
:AA:BB:EE; FF; GG
```

Is the same as sending these three messages:

```
:AA:BB:EE
:AA:BB:FF
:AA:BB:GG
```

## Program Message Syntax

This section provides an example of constructing of a SCPI program message. A program message is the message sent from a computer to an instrument. Program messages consist of commands combined with appropriate punctuation and program message terminators.

### Case

Letter case (upper and lower) is ignored.

### Program Message Terminator

A program message must end with one of the three **program message terminators**, <new line>, <^END>, or <new line><^END>. <^END> means that EOI is asserted on the GPIB interface at the same time the preceding data byte is sent. For example, HP BASIC OUTPUT statement automatically sends an message terminator after the last data byte is sent. If you are using a PC, you can usually configure your system to send whatever terminator you specify.

### Subsystem Command Syntax

Subsystem command consists of the level mnemonics which are separated with colons. For example, command form of APERture under [SENSe]:CURRent subsystem becomes as follows:

```
:CURRent:APERture
```

Abbreviated mnemonics are also available for command headers. In the above example, :CURR:APER is available.

### Common Command Syntax

Common commands do not have a hierarchical structure. They are just sent as follows:

```
*CLS
```

### Parameters

There must be a <space> between the last command mnemonic and the first parameter in a subsystem command.

```
:CURR:APER␣parameter
```

␣ means a space (ASCII character (decimal 32)) is inserted here.

If you send more than one parameter with a single command, each parameter must be separated by a comma. For example, :POINts command of DATA subsystem is followed by two parameters as follows.

```
:DATA:POIN␣parameter,parameter
```

## Parameter Types

SCPI defines different data formats for use in program messages and query responses. The 4349B accepts commands and parameters in various formats and responds to a particular query in a predefined and rigid format. Each command reference contains information about available parameter types for the individual commands.

- *<numeric\_value>* is used in both common commands and subsystem commands.

*<numeric\_value>* represents numeric parameter as followings:

100	no decimal point required
100.	fractional digits optional
-1.23, +235	leading signs allowed
4.56eL3	space allowed after e in exponentials
-7.89E-01	use either E or e in exponentials
.5	digits left of decimal point optional

4349B settings programmed with a numeric parameter can assume a finite number of values, so the 4349B automatically rounds the parameter. For example, the 4349B has programmable line frequencies of 50 or 60 Hz. If you specified 50.1, it would be rounded off to 50.

The subsystem commands can use extended numeric parameters. Extended numeric parameters accept all numeric parameter values and other special values, for instance, MAXimum, MINimum or UP, DOWN. The special values available for a command are described in the each command's reference description.

Query response to *<numeric\_value>* is always a numeric value.

- *<Boolean>* represents a single binary condition that is either ON or OFF. *<Boolean>* allows the following parameters:

ON, OFF	In a program message
1, 0	In a program message and query response

- *<sensor\_function>* and *<data\_handle>* are string parameters which contain ASCII characters. A string must begin with a single quote(ASCII 39 decimal) or a double quote (ASCII 34 decimal) and end with the same character. The quote to mark the beginning and end of the string is called the delimiter. You can include the delimiter as part of the string by typing it twice without any characters in between.

Example of *<sensor\_function>* "CURR",

```
10 OUTPUT @Meter;":FUNC 'CURR' "    using single quote
20 OUTPUT @Meter;":FUNC ""CURR""    using double quote
```

Query response is the string between the double quote delimiters.

## 4349B

### Suffix

When a command has specified suffix, the suffix multiplier and suffix units (The suffix multiplier must be used with the suffix unit.) can be used with parameters.

**Table 5-1. Suffix Multiplier**

Definition	Suffix Multiplier	Suffix Unit
10 <sup>-3</sup> (Milli)	M	A (ampere) S (second)
10 <sup>-6</sup> (Micro)	U	
10 <sup>-9</sup> (Nano)	N	
10 <sup>-12</sup> (Pico)	P	

For example,

```
10 OUTPUT @Meter;" :TRIG:DEL 30MS" 30MS is a parameter which means 30 ms
```

The suffix is optional and can be omitted. The suffixes available for the commands are described in the reference for each command.

### Multiple Messages

To send more than one command in the same message, you must separate the commands with a semicolon:

```
*CLS; :INIT
```

### Query and Response Message Syntax

All subsystem commands can be queried except for the commands described as “no query” in the command reference. To send a query message, add ? after last command mnemonic.

```
:CURR:APER?
```

A response message may contain both commas and semicolons as separators. When a single query command returns multiple values, a comma is used to separate each data item. When multiple queries are sent in the same message, the group of data items corresponding to each query are separated by a semicolon. For example, the fictitious query :QUERY1?;QUERY2? might return a response message of:

```
<data1>,<data1>;<data2>,<data2>
```

After the message, <new line><^END> is always sent as a response message terminator.

## Command Reference

In this section, all the commands which are available with the 4349B are listed in alphabetical order.

### Notations

The following conventions and definitions are used in this chapter to describe GPIB operation.

**:CALClate{1|2|3|4}:LIMit:LOWer[:DATA] <numeric\_value>**

sets the lower limit value.

**:CALClate{1|2|3|4}:LIMit:LOWer[:DATA] { ON | OFF | 1 | 0 }**

enables or disables the lower limit.

- < > Angular brackets enclose words or characters that are used to symbolize a program code parameter or an GPIB command.
- [ ] Square brackets indicates that the enclosed items are optional.
- { } When several items are enclosed by braces, one and only one of these elements may be selected.
- | A vertical bar can be read as “or” and is used to separate alternative parameter options.

for example,

:CALClate{1|2|3|4} means :CALC1, :CALC2, :CALC3 or :CALC4.

[:DATA] is optional, so this allows to omit the keyword, like

:CALC1:LIM:LOW <numeric\_value>

### Note



The 4349B equipped with **Option 001 ( 2 Channels )** cannot use channels 3 and 4. If your 4349B is an Option 001 4349B, delete 3 and 4 in following commands.

```
CALCulate{1|2|3|4}
DISPlay:WINDow{1|2|3|4}
[SENSe:]CURRent:RANGe{1|2|3|4}
SOURce:VOLTage{1|2|3|4}
```



---

## ABORt Command

### :ABORt

The ABORt command resets the trigger system and places all trigger sequences in the IDLE state. Any actions related the trigger system that are in progress, such as acquiring a measurement, are aborted immediately. The execution of an ABORt command will set any the pending operation flags to false, for example flags that were set by the initiation of the trigger system. See “Trigger System”.

Unlike \*RST, ABORt does not alter the settings programmed by other commands. (No query)

---

#### Note



After FETCh? query, \*TRG command, or the BASIC command TRIGGER, the ABORt command causes the GPIB bus to hang up. To avoid this, before ABORt command execution, clear the gpib bus with the BASIC command CLEAR(*address*).

---

## CALCulate Subsystem

The CALCulate subsystem controls comparator function.

COMMAND	PARAMETER
CALCulate{1 2 3 4}	
:LIMit	
:BEEPer	
[:STATe]	<Boolean>
:CONDition	{FAIL   PASS}
:CLEAr	
:FAIL?	
:LOWer	
[:DATA]	<numeric_value>
:STATe	<Boolean>
:STATe	<Boolean>
:UPPer	
[:DATA]	<numeric_value>
:STATe	<Boolean>
:PATH?	

### :CALCulate{1|2|3|4}:LIMit:BEEPer:CONDition { FAIL | PASS }

Defines comparator output to beeper.

FAIL cause a beep when the comparison result is FAIL(High, Low or No-contact).  
PASS cause a beep when the comparison result is PASS(In).

This command is effective when SYSTem:BEEPer:STATe command is set to ON and CALCulate{1|2|3|4}:LIMit:BEEPer:STATe command is set to ON.

Query response is {FAIL|PASS}.

#### Note



The comparator output states of each channel are linked together. So the CALCulate{1|2|3|4}:LIMit:BEEPer command toggles the comparator function of all channels to PASS or FAIL.

### :CALCulate{1|2|3|4}:LIMit:BEEPer[:STATe] { ON | OFF | 1 | 0 }

Sets or queries if the comparator output to the beeper is enabled.

ON, 1 enables comparator output to the beeper as defined by  
CALCulate{1|2|3|4}:LIMit:BEEPer:CONDition command.  
OFF, 0 disables comparator output to the beeper.

When you enable the beep function, :SYSTem:BEEPer:STATe command is automatically set to ON.

Query response is {1|0}.

#### Note



The comparator output states of each channel are linked together. So the CALCulate{1|2|3|4}:LIMit:BEEPer command toggles the comparator function of all channels ON or OFF.

**:CALCulate{1|2|3|4}:LIMit:CLEAr**

Clears the data which is reported by CALCulate{1|2|3|4}:LIMit:FAIL? command. (no query)  
 CALCulate{1|2|3|4} selects the channel.

**:CALCulate{1|2|3|4}:LIMit:FAIL?**

Returns the comparison result from the selected channel. (query only)

CALCulate{1|2|3|4} selects the channel.

Query response is {1|0}. Where,

1 comparison result is FAIL.  
 0 comparison result is PASS.

**:CALCulate{1|2|3|4}:LIMit:LOWer[:DATA] <numeric\_value>**

Sets or queries the lower limit value of the selected channel.

CALCulate{1|2|3|4} selects the channel.

<numeric\_value> is,

<i>numeric</i>	$-9.9 \times 10^{37}$ to $9.9 \times 10^{37}$
MAXimum	$9.9 \times 10^{37}$
MINimum	$-9.9 \times 10^{37}$

Query response is <numeric\_value>, in <NR3> format.

**:CALCulate{1|2|3|4}:LIMit:LOWer:STATe { ON | OFF | 1 | 0 }**

Sets or queries if the lower limit of selected channel is enabled.

CALCulate{1|2|3|4} selects the channel.

ON, 1 enables the lower limit.  
 OFF, 0 disables the lower limit.

Query response is {1|0}.

**:CALCulate{1|2|3|4}:LIMit:STATe { ON | OFF | 1 | 0 }**

Sets or queries if the comparator function is enabled.

ON, 1 sets comparator function ON.  
 OFF, 0 sets comparator function OFF.

Query response is {1|0}.

**Note**

The comparator ON/OFF states of each channel are linked together. So the CALCulate{1|2|3|4}:LIMit:STATe command toggles the comparator function of all channels ON or OFF.

**:CALCulate{1|2|3|4}:LIMit:UPPer[:DATA] <numeric\_value>**

Sets or queries the upper limit value of the selected channel.

CALCulate{1|2|3|4} selects the channel.

<numeric\_value> is,

<i>numeric</i>	$-9.9 \times 10^{37}$ to $9.9 \times 10^{37}$
MAXimum	$9.9 \times 10^{37}$
MINimum	$-9.9 \times 10^{37}$

**:CALCulate{1|2|3|4}:LIMit:UPPer:STATe { ON | OFF | 1 | 0 }**

Sets or queries if the upper limit of the selected channel is enabled.

CALCulate{1|2|3|4} selects the channel.

ON, 1 enables the upper limit.

OFF, 0 disables the upper limit.

Query response is {1|0}.

**CALCulate{1|2|3|4}:PATH?**

The CALCulate{1|2|3|4}:PATH? query returns the CALCulate subsystems in the order in which they are to be performed. Actually, while the 4349B has only the CALCulate{1|2|3|4}:LIMit subsystem other than CALCulate:PATH?, the query always returns :LIMit. (query only)

Query response is {LIM}.

## DATA Subsystem

The DATA subsystem commands are used to store and read measurement data to and from the 4349B's data buffer. The 4349B provides a data buffer which is named DBUF. You can store the data up to 50 measurements into DBUF.

COMMAND	PARAMETER
DATA	
[:DATA]?	DBUF
:FEED	DBUF,<data_handle>
:CONTRol	DBUF,{ALWays NEVer}
:POINts	DBUF,<numeric_value>

### :DATA[:DATA]? DBUF

Returns the data held in the data buffer, DBUF, according to the format determined by commands in the FORMat subsystem. (query only)

This query must have the parameter DBUF, which is the name of the data buffer to be read.

Query response is,

<set1>,<set2>, ... <setn>

Where,

<set1>           : data set of the first measurement point  
 <set2>           : data set of the second measurement point  
                   :  
 <setn>           : data set of the last measured point (*n* is specified by DATA:POINts DBUF command)

Each data set consists of following data:

<stat1>,<data1>,<comp1>,<stat2>,<data2>,<comp2>,<stat3>,<data3>,<comp3>,<stat4>,<data4>,<comp4>

Where,

<stat1-4> measured status of each channel  
     0 : normal  
     1 : overload  
     2 : No-Contact

<data1-4> measured data of each channel

<comp1-4> comparison result of each channel  
     0 : comparator OFF  
     1 : In  
     2 : High  
     4 : Low  
     8 : No-Contact

**:DATA:FEED DBUF,<data\_handle>**

Sets or queries whether or not measurement data is fed into data buffer, DBUF.

The :DATA:FEED? query needs parameter, DBUF, which is the data buffer's name. So, the query form is :DATA:FEED? DBUF.

<i>&lt;data_handle&gt;</i>	<b>description</b>
"SENSe"	set to feed measured data into the data buffer
""(null string)	set not to feed data into the data buffer

Query response is { "SENS" | "" }.

**:DATA:FEED:CONTRol DBUF,{ALWays|NEVer}**

Sets or queries whether or not data is fed into data buffer, DBUF. The data set by this command is specified by :DATA:FEED DBUF command. This command has no effect if :DATA:FEED DBUF is set to "".

When the data buffer , DBUF is full, a bit in the status register is set and no more data can be feed into DBUF.

The :DATA:FEED:CONTRol? query must have the parameter, DBUF, which is the data buffer's name. So, the query form is :DATA:FEED:CONTRol? DBUF.

ALWays	feeds data into data buffer, DBUF, whenever new data is available
NEVer	no data is fed.

At \*RST, :DATA:FEED:CONTRol DBUF is set to NEVer.

Query response is {ALW|NEV}.

---

**Note** When data buffer, DBUF, is full, the standard operation status register is set(refer to "Operation Status Register").

**:DATA:POINts DBUF,<numeric\_value>**

Sets or queries size of data buffer, DBUF. The amount of measurement data that can be stored into DBUF is defined by this command.

This command returns the data buffer pointer to point to the head of the buffer. After that, data will be stored starting from the head of the buffer.

:DATA:POINts? query must have the parameter, DBUF, which is data buffer's name. So, the query form is :DATA:DEFine? DBUF.

*<numeric\_value>* is,  
*numeric* 1 to 50

Query response is *<numeric\_value>*.

## DISPlay Subsystem

The DISPlay subsystem controls the selection of the channel displayed and the display mode.

COMMAND	PARAMETER
DISPlay	
:ENABle	<Boolean>
:WINDow{1 2 3 4}	
[:STATe]	<Boolean>
:TEXT1	
:DIGit	{3 4 5}
:PAGE	{1 2}
:TEXT2	
:PAGE	{1 2 3}

**Note** The state of each channel's display mode, display digits and display mode of the Measurement Settings are linked.



### **:DISPlay:ENABle { ON | OFF | 1 | 0 }**

Controls or queries whether the display is ON or OFF.

ON, 1            set display visible.  
OFF, 0           set display blank.

Query response is {1|0}.

### **:DISPlay:WINDow{1|2|3|4}[:STATe] { ON | OFF | 1 | 0 }**

Selects the channel to be displayed and controls whether or not the display is turned ON, or queries whether or not the selected channel is set to ON.

WINDow{1|2|3|4}        selects the displayed channel.

ON, 1            displays selected channel.  
OFF, 0           sets the display blank.

Query response is {1|0}.

### **:DISPlay:WINDow{1|2|3|4}:TEXT1:PAGE { 1 | 2 }**

Selects the displayed channel and display mode.

WINDow{1|2|3|4}        selects the displayed channel.

1                displays the measurement results of selected channel.  
2                displays the comparison results of all channels.

Query response is {1|2}.

**:DISPlay:WINDow{1|2|3|4}:TEXT1:DIgit { 3 | 4 | 5 }**

Selects the displayed channel and display digits.

WINDow{1|2|3|4} selects the displayed channel.

- 3 3 digits display mode
- 4 4 digits display mode
- 5 5 digits display mode

Query response is {3|4|5}.

**:DISPlay:WINDow{1|2|3|4}:TEXT2:PAGE { 1 | 2 | 3 }**

Selects the display mode of the Measurement Settings area.

WINDow{1|2|3|4} selects the displayed channel.

- 1 displays Range and Voltage setting of the selected channel.
- 2 displays Averaging rate and Trigger delay time
- 3 displays Comparator limits of the selected channel.

Query response is {1|2|3}.

---

**Note** "1" of :TEXT1 can be omitted, but "2" of :TEXT2 cannot be omitted.





---

## FETCh? Query

### :FETCh?

The FETCh? query retrieves the measurements taken by the INITiate command and places them into the 4349B's output buffer. (Query only)

Query response is,

*<stat1>*,*<data1>*,*<comp1>*,*<stat2>*,*<data2>*,*<comp2>*,*<stat3>*,*<data3>*,*<comp3>*,  
*<stat4>*,*<data4>*,*<comp4>*

Where,

*<stat1-4>* measurement status of each channel

0 : normal

1 : overload

2 : no-contact

*<data1-4>* measurement data of each channel

*<comp1-4>* comparison result of each channel (no output when the comparator function is OFF)

1 : In

2 : High

4 : Low

8 : No-Contact

Format is specified by FORMat subsystem.

For more information, refer "To Trigger a Measurement" in Chapter 4.

---

## FORMat Subsystem

COMMAND	PARAMETER
FORMat [:DATA]	{ ASCii REAL[,64]}

### **:FORMat[:DATA] { ASCii | REAL[,64] }**

Sets the data format for transferring numeric and array information retrieved using the DATA subsystem or the FETCh? query.

ASCii sets data transfer format to the ASCII transfer format.

REAL [,64] sets the data transfer format to the real 64-bit transfer format.

For details about data transfer formats, see “Data Transfer Format”, later in this chapter.

Query response is {ASC|REAL,64}.

## INITiate Subsystem

The INITiate subsystem controls the initiation of the trigger system. It indicates all trigger sequences as a group. The detailed description of trigger system is in “Trigger System”.

COMMAND	PARAMETER
INITiate	
:CONTinuous	<Boolean>
[:IMMEDIATE]	

### :INITiate[:IMMEDIATE]

The :INITiate[:IMMEDIATE] command causes all sequences to exit the IDLE state and enter the INITIATE state. This command causes the trigger system to initiate and complete one full trigger cycle, returning to IDLE on completion. (No query)

If the 4349B is not in IDLE or if INITiate:CONTinuous is set to ON, an :INITiate:IMMEDIATE command has no effect on the trigger system and an error –213 is generated.

### :INITiate:CONTinuous { ON | OFF | 1 | 0 }

The INITiate:CONTinuous command sets or queries whether or not the trigger system is being continuously initiated.

ON, 1           continuously initiated.  
OFF, 0          not continuously initiated.

Query response is {1|0}.

## SENSe Subsystem

COMMAND	PARAMETER
[SENSe]	
:AVERage	
:COUNT	<numeric_value>
[:STATe]	<Boolean>
:CORRection	
:COLLect	
[:ACQuire]	OFFSet
:DATA{1 2 3 4}?	{OFFSet SCAPacitance}
[:STATe]	<Boolean>
:CURRent	
:APERTure	<numeric_value>[MS S]
:RANGe{1 2 3 4}	
:AUTO	<Boolean>
[:UPPer]	<numeric_value>[PA NA UA MA A]
:FUNCTion	<sensor_function>
:CONTAct	
:DATA{1 2 3 4}?	
:LIMit{1 2 3 4}?	
:OFFSet{1 2 3 4}	<numeric_value>[PF F]
:VERify	<Boolean>

### **[[:SENSe]:AVERage:COUNT** <numeric\_value>

Sets or queries the averaging rate.

<numeric\_value> is,

<i>numeric</i>	1 to 256 (integer), default is 1
MAXimum	256
MINimum	1

Query response is <numeric\_value>, in <NR1> format.

### **[[:SENSe]:AVERage[:STATe]** { ON | OFF | 1 | 0 }

Sets or queries if the averaging function is enabled.

ON, 1	enables averaging.
OFF, 0	disables averaging.

Query response is {1|0}.

### **[[:SENSe]:CORRection:COLLect[:ACQuire]** OFFSet

Performs the OPEN correction for all channels. The OPEN correction takes data with which to cancel the offset error of the 4349B and the leakage of the test fixture, and takes stray capacitance data for the contact check function. The OPEN correction data is stored in non-volatile memory(EEPROM). (no query)

The offset error of 4349B depends on the temperature. The OPEN correction must be performed when the temperature changes.

To perform a valid OPEN correction, confirm that required test fixtures are connected to test terminals on the front panel.

**Note**

This command sets [SENSE:]CORREction[:STATe] ON, which enables the correction function. The \*RST, or :SYSTEM:PRESet commands clear the correction data.

---

**[[:SENSE]:CORREction:DATA{1|2|3|4}? OFFSet**

Returns the OPEN correction data (DC current measurement value). (query only)

Query response is a numeric value in <NR3> format.

**[[:SENSE]:CORREction:DATA{1|2|3|4}? SCAPacitance**

Returns the capacitance measurement data Cres which is taken in the OPEN correction and used for the contact check function. Cres is required to find the contact check effective range. See Chapter 8 for more detail. (query only)

The capacitance value Cres returned by this command shows the total measurement system's stray capacitance, including the 4349B's internal stray capacitance.

The returned Cres is typical data, and it is not guaranteed.

Query response is a numeric value in <NR3> format.

**[[:SENSE]:CORREction[:STATe] { ON | OFF | 1 | 0 }**

Sets or queries if the correction data is enabled or not.

ON, 1	Correction data is enabled.
OFF, 0	Correction function is disabled.

Query response is {1|0}.

**[[:SENSE]:CONTact:DATA{1|2|3|4}?**

Returns the capacitance data at dut measurement. The contact check function uses this capacitance data. Refer to "Reading the Limit Data of Contact Check Function" in Chapter 2 for detail. (query only)

Query response is a numeric value in <NR3> format.

The data is incorrect if the measurement range was changed after dut measurement.

**Note**

The accuracy of the capacitance data is not guaranteed.

---

**[[:SENSE]:CONTact:LIMit{1|2|3|4}?**

Returns the contact check limit data. Refer to "Reading the Limit Data of Contact Check Function" in Chapter 2 for detail. (query only)

Query response is a numeric value in <NR3> format.

**[[:SENSe]:CONtact:OFFSet]{1|2|3|4} <numeric\_value>**

Set or queries an offset of contact check limit data.

Sets (:SENSe:CONtact:LIMit{1|2|3|4}?) The offset value is set when the \*RST command is executed. See “Reading the Limit Data of Contact Check Function” in Chapter 2 for details.

---

**Note** Set the offset value to more than 0.



<numeric\_value> is,

<i>numeric</i>	-75 to 75 [PF]
MAXimum	75 [PF]
MINimum	0

**[[:SENSe]:CONtact:VERify { ON | OFF | 1 | 0 }**

Sets or queries if the contact check function is enabled.

Where,

ON or 1	Enables the contact check function.
OFF or 0	Disables the contact check function.

The reference data for the contact check is obtained by an OPEN correction. An OPEN correction is required before the contact check turns on.

Query response is 1 or 0.

**[[:SENSe]:CURRent:APERture <numeric\_value>[MS|S]**

Sets or queries measurement time mode: 10 ms(=0.01 s), 30 ms(=0.03 s), 100 ms(=0.1 s), or 400 ms(=0.4 s).

<numeric\_value> is,

<i>numeric</i>	0.01, 0.03, 0.1, or 0.4 (s)
----------------	-----------------------------

The following suffixes can be used with <numeric\_value>.

S : s	MS : ms
-------	---------

Query response is <numeric value> in <NR3> format.

**[[:SENSe]:CURRent:RANGe{1|2|3|4}:AUTO { ON | OFF | 1 | 0 }**

Sets or queries if the Auto range measurement mode is enabled. In this mode the 4349B automatically selects the optimum measurement range.

ON, 1            The Auto mode ON  
 OFF, 0          The Auto mode OFF and the measurement range setting is Hold mode.

Query response is {1|0}.

---

**Note**

The Auto measurement range ON/OFF states of each channel are linked together. So the [[:SENSe]:CURRent:RANGe{1|2|3|4}:AUTO command toggles the Auto range mode of all channels to ON or OFF.

---

**[[:SENSe]:CURRent:RANGe{1|2|3|4}[:UPPer]**  
**<numeric\_value>[PA|NA|UA|MA|A]**

Sets or queries the measurement range. Available values are 100 pA, 1 nA, 10 nA, 100 nA, 1  $\mu$ A, 10  $\mu$ A, and 100  $\mu$ A, which specifies the upper limits of each range.

WINDow{1|2|3|4}          selects the displayed channel.

<numeric\_value> is,

<i>numeric</i>	1.0 $\times$ 10 <sup>-10</sup> , 1.0 $\times$ 10 <sup>-9</sup> , 1.0 $\times$ 10 <sup>-8</sup> , 1.0 $\times$ 10 <sup>-7</sup> , 1.0 $\times$ 10 <sup>-6</sup> , 1.0 $\times$ 10 <sup>-5</sup> , 1.0 $\times$ 10 <sup>-4</sup> (A)
MAXimum	100 $\mu$ A
MINimum	100 pA
UP	move to upper range
DOWN	move to lower range

Following suffixes can be used with <numeric\_value>.

A : A            UA :  $\mu$ A            NA : nA            PA : pA

---

**Note**

100 pA is not available when the measurement time mode is 10 ms.  
 10  $\mu$ A is not available when the measurement time mode is 100 ms or 400 ms.  
 100  $\mu$ A is not available when the measurement time mode is 30 ms, 100 ms, or 400 ms.

---

**[[:SENSe]:FUNctIon <sensor\_function>**

Selects the measurement parameter.

<i>sensor_function</i>	<b>Measurement Parameter</b>
"CURRent[:DC]"	DC current
"RESistance"	DC resistance

Query response is { "CURR" | "RES" }.

---

## SOURce Subsystem

COMMAND	PARAMETER
SOURce	
:VOLTage{1 2 3 4}	
[:LEVel]	
[:IMMediate]	
[:AMPLitude]	<numeric_value>

**:SOURce:VOLTage{1|2|3|4}[:LEVel][:IMMediate][:AMPLitude]**  
 <numeric\_value>

Entries or queries the external source voltage value, with which DUT's resistance is calculated using measured current value.

VOLTage{1|2|3|4} selects the channel.

<numeric\_value> is,

<i>numeric</i>	0 V to 5000 V
MAXimum	5000 V
MINimum	0 V

Query response is <numeric\_value>.

---

### Note



The 4349B does not have a test voltage source, and this command is not used to control the test voltage level but to enter the voltage value which is used to calculate resistance.

---



## STATus Subsystem

The STATus subsystem commands controls the OPERation and QUEStionable registers in the status-reporting structures(See “Status Reporting Structure”).

COMMAND	PARAMETER
STATus	
:OPERation	
:CONDition?	
:ENABle	<numeric_value>
[:EVENT]?	
:PRESet	
:QUEStionable	
:CONDition?	
:ENABle	<numeric_value>
[:EVENT]?	

### :STATus:OPERation[:EVENT]?

Returns the contents of the event register of the standard operation status group. (Query only)

Query response is the decimal expression of the contents of the register, in <NR1> format.

**Note** Reading the event register clears it.



### :STATus:OPERation:CONDition?

Returns the contents of the condition register of the standard operation status group. (Query only)

Query response is the decimal expression of the contents of the register, in <NR1> format.

**Note** Reading the condition register is nondestructive.



### :STATus:OPERation:ENABle <numeric\_value>

Sets the enable register of the standard operation status group.

<numeric\_value> is,

*numeric* decimal expression of the contents of the register, in <NR1> format.

Query response is decimal expression of the contents of the register, in <NR1> format.

**:STATus:PRESet**

Clears the OPERation and QUEStionable register groups. Both event and enable registers are cleared. (no query)

**:STATus:QUEStionable[:EVENT]?**

Returns the contents of the event register of the standard questionable status group. (query only)

Query response is the decimal expression of the contents of the register, in <NR1> format.

The 4349B has no operation to report the event to the questionable status event register, all of whose bits are always set to 0.

**:STATus:QUEStionable:CONDition?**

Returns the contents of the condition register of the standard questionable status group. (Query only)

Query response is the decimal expression of the contents of the register, in <NR1> format.

The 4349B has no operation to report the event to the questionable status condition register, all of whose bits are always 0.

**:STATus:QUEStionable:ENABle <numeric\_value>**

Sets or queries the enable register of standard questionable status group.

<numeric\_value> is,

*numeric*                    decimal expression of the contents of the register

Query response is decimal expression of the contents of the register, in <NR1> format.

## SYSTem Subsystem

The SYSTem subsystem reports the firmware version and errors, sets the beeper, locks out front-panel key, and defines the power LINE frequency.

COMMAND	PARAMETER
SYSTem	
:BEEPer	
[:IMMediate]	
:STATe	<Boolean>
:ERRor?	
:KLOCK	<Boolean>
:LFRequency	<numeric_value>
:PRESet	
:VERSion?	

### :SYSTem:BEEPer[:IMMediate]

Emits a beep. (no query)

### :SYSTem:BEEPer:STATe { ON | OFF | 1 | 0 }

Sets or queries if the beeper is enabled.

ON, 1 enables the beeper output, and set beeper mode as defined by CALCulate{1|2|3|4}:LIMit:BEEPer command.

OFF, 0 disables the all beeper output, including error beep.

Query response is {1|0}.

### :SYSTem:ERRor?

Returns the existing error numbers and messages in the 4349B's error queue. (Query only)

### :SYSTem:KLOCK { ON | OFF | 1 | 0 }

Sets or queries whether or not the front-panel keys of the 4349B locked.

ON, 1 the front-panel keys are locked.

OFF, 0 the front-panel keys are unlocked.

Query response is {1|0}.

### :SYSTem:LFRequency <numeric\_value>

Sets or queries the 4349B's operating power line frequency. Available line frequency selections are 50 Hz and 60 Hz.

<numeric\_value> is,

*numeric* 50 or 60 (integer)

**:SYSTEM:PRESet**

Resets the 4349B to its default state. (no query)

Reset states are as follows:

Test Voltage Value	CH1	: 0 V
Test Voltage Value	CH2	: 0 V
Test Voltage Value	CH3	: 0 V
Test Voltage Value	CH4	: 0 V
Measurement Parameter		: R
Measurement Range		: Auto
Measurement Time		: Long
Averaging Rate		: 1
Trigger Source		: Internal
Trigger Delay		: 0 msec
Comparator		: OFF
Comparator limits		: MAX, MIN
Contact Check ON/OFF state		: OFF
Display Mode		: Measured data display mode
Correction ON/OFF state		: ON
Beep ON/OFF state		: ON
Beep Mode		: FAIL beep mode
Open Correction Data		: Cleared
Data Transfer Format		: ASCII
:INIT:CONT		: ON

**:SYSTEM:VERSion?**

Returns the value corresponding to SCPI version number for which the instrument complies.  
(Query only)

Query response is YYYY.V, in <NR2> format.

Where,

YYYY	year-version
V	revision number for the year

## TRIGger Subsystem

The TRIGger subsystem controls measurement trigger functions.

COMMAND	PARAMETER
TRIGger	
:DElay	<numeric_value>[MS S]
[:IMMediate]	
:SOURce	{BUS EXTernal INTernal MANual}

### **:TRIGger:DElay** <numeric\_value>[MS|S]

Sets or queries the trigger delay time.

<numeric\_value> is,

<i>numeric</i>	0 to 9999 ms, 1 ms resolution. Default is 0 sec.
MAXimum	9999 ms
MINimum	0

Following suffixes can be used with <numeric\_value>.

S : s            MS : ms

### **:TRIGger[:IMMediate]**

Causes the trigger to execute a measurement, regardless of the trigger state. (No query)

### **:TRIGger:SOURce** { **BUS** | **EXTernal** | **INTernal** | **MANual** }

Sets or queries the trigger mode.

BUS	GET command and *TRG command trigger a single shot measurement.
EXTernal	TTL pulse input of the rear panel's external trigger connector or the handler interface trigger a measurement.
INTernal	makes free running continuous measurements.
MANual	The 4349B performs a measurement in response to the front-panel trigger key being pressed.

Query response is {BUS|EXT|INT|MAN}.

---

## Common Commands

### \*CLS

The \*CLS (clear status) command clears the status byte register, the operation status event register, the questionable status register, and the standard event status register.

### \*ESE <numeric\_value>

The \*ESE (Event Status Enable) command sets the bits of standard event status enable register.

### \*ESE?

The \*ESE? (Event Status Enable) query reads the bits in the standard event status enable register.

Query response is the decimal expression of the contents of the register, in <NR1> format.

### \*ESR?

The \*ESR? (standard event status register) query returns the contents of the standard event status register.

Query response is the decimal expression of the contents of the register, in <NR1> format.

### \*IDN?

The \*IDN? (identification) query returns an identification string which is 4 fields separated by commas.

Query response is <Field 1>,<Field 2>,<Field 3>,<Field 4>.

Where,

<i>Field 1:</i>	manufacturer (always Agilent Technologies)
<i>Field 2:</i>	model number (always 4349B)
<i>Field 3:</i>	serial number in HP format (like 2419J00100)
<i>Field 4:</i>	firmware version number (like 01.00)

### \*LRN?

The \*LRN? (learn Device Setup) query returns a sequence of commands that places the 4349B in the current state. The returned sequence of commands can be sent back to the 4349B to place in this state.

### \*OPC

The \*OPC (operation complete) command tells the 4349B to set bit 0 (OPC bit) in the standard event status register when it completes all pending operations.

**\*OPC?**

The \*OPC? (Operation Complete) query places an ASCII character 1 into the 4349B's Output Queue when all pending operations have been finished.

**\*OPT?**

The \*OPT? (OPTION identification) query tells the 4349B to identify the options installed in the system interface.

**\*RCL** *<numeric\_value>*

The \*RCL (recall) command recalls the instrument state which was stored in the specified register number. The 4349B has 10 available storage registers.

*<numeric\_value>* is,

*numeric*                    0 to 9, <NR1> format

**\*RST**

The \*RST (reset) command returns the 4349B to the default state (see :SYSTem:PRESet command) and sets the following commands:

```
INITiate:CONTinuous OFF
[SENSe:]CORRection[:STATe] OFF
SYSTem:KLOCK OFF
```

**\*SAV** *<numeric\_value>*

The \*SAV (save) command saves the instrument state in the specified register number. The 4349B has 10 available storage registers.

*<numeric\_value>* is,

*numeric*                    0 to 9, <NR1> format

**\*SRE** *<numeric\_value>*

The \*SRE (service request enable) command sets the bits of the service request enable register.

*<numeric\_value>* is,

*numeric*                    decimal expression of the contents of the service request enable register (Bit 6 must always be 0), <NR1> format

**\*SRE?**

The \*SRE? (service request enable) query returns the contents of the service request enable register.

Query response is a decimal expression of the contents of the register (Bit 6 is always 0), in <NR1> format.

**\*STB?**

The \*STB? (status byte) query reads the status byte by reading the master summary status bit.

Query response is a decimal expression of the contents of the status byte register, in <NR1> format.

**\*TRG**

The \*TRG (trigger) command triggers the 4349B when the trigger mode is set to the BUS trigger mode.

**\*TST?**

The \*TST? (self-test) query executes an internal self-test and returns the test result as the sum of error codes of existing errors. If there is no error the 4349B returns 0.

Test Item	Error Code
1. RAM	1
2. EPROM	2
3. Calibration data (EEPROM)	4
4. User's data (EEPROM)	8
5. A/D converter	16
6. Backup RAM	32

Query response is 0 to 63, in <NR1> format.

**\*WAI**

The \*WAI (the wait to continue) command makes the 4349B wait until all previously sent commands are completed.



## Status Reporting Structure

This section provides information about the status reporting structure for Service Request functions which correspond to SCPI.

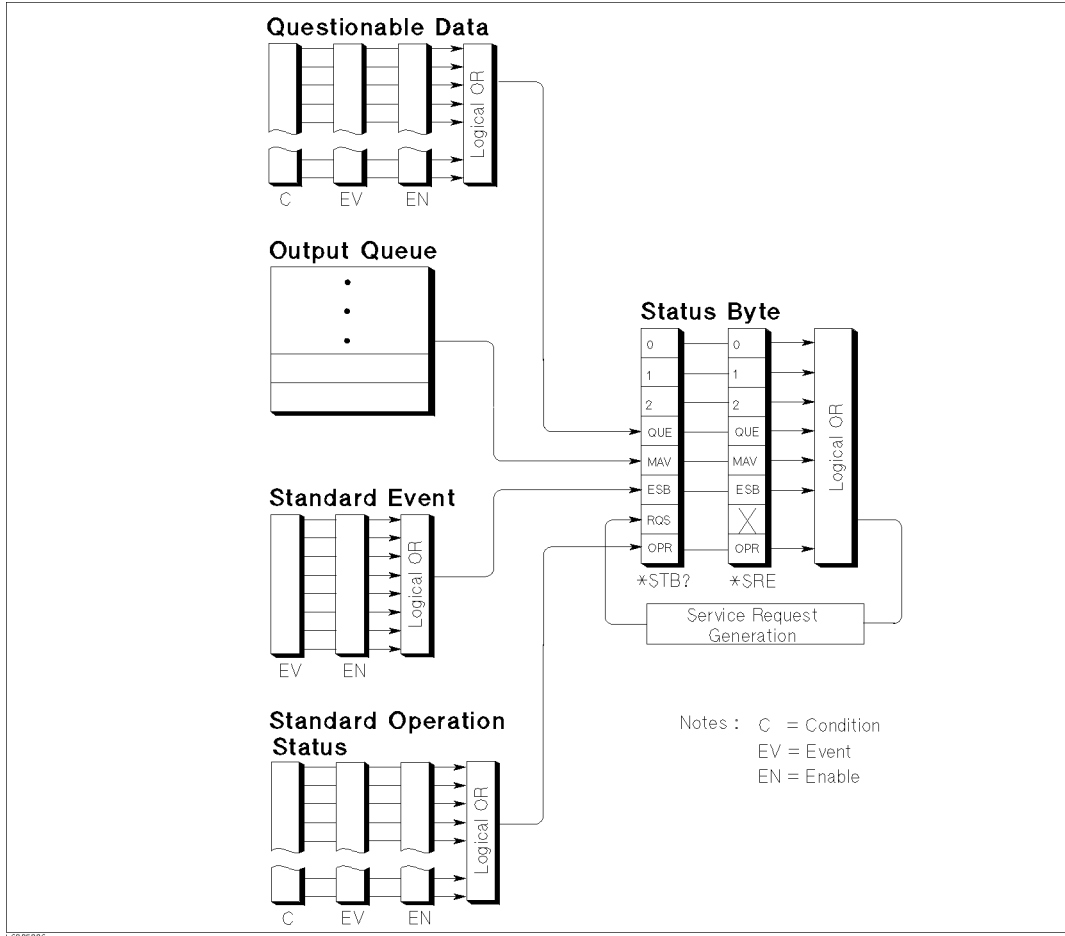

Figure 5-2. Status Reporting Structure

### Service Request (SRQ)

The 4349B can send an SRQ (Service Request) control signal when it requires the controller to perform a task. When the 4349B generates an SRQ, it also sets Bit 6 of the status byte, RQS (Request Service) bit. Service Request Enable Register allows an application programmer to select which summary messages in the status byte register may cause service requests. (Illustrated in Figure 5-3.)

## Status Byte Register

The status byte register is composed of eight bits that summarize the overlaying status data structure.

The status byte can be read using either `*STB?` or `SPOLL`, which return a decimal expression of the contents of the register (equal to sum of the total bit weights of all the bit set to “1”). For more information, see “To Report the Instrument’s Status” in Chapter 4.

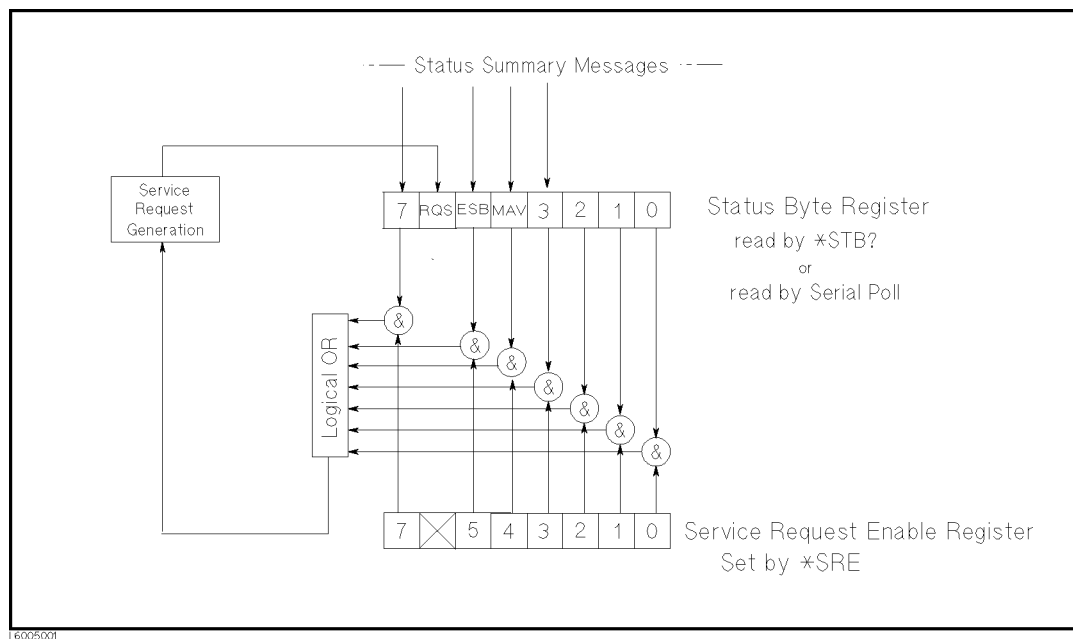

**Figure 5-3. Status byte Register**

Bits are set to “1” and reset to “0”.

**Table 5-2. Status Byte Assignments**

Bit No.	Bit Weight	Description
7	128	Operation Status Register Summary Bit
6	64	Request Service Bit—This bit is set when the any enabled bit of the status byte has been set, which indicates the 4349B has at least one reason for requesting service. <code>SPOLL</code> resets this bit.
5	32	Standard Event Status Register Summary Bit
4	16	MAV (Message Available) Bit—This bit is set whenever the 4349B has data available in Output Queue, and reset when available data is read.
3	8	Questionable Status Register Summary Bit
2-0		always 0 (zero)

### Standard Event Status Register

The Standard Event Status Register is frequently used and is one of the simplest. You can program it using GPIB common commands, \*ESE and \*ESR?. Refer to \*ESE command and \*ESR? command in “GPIB Commands”.

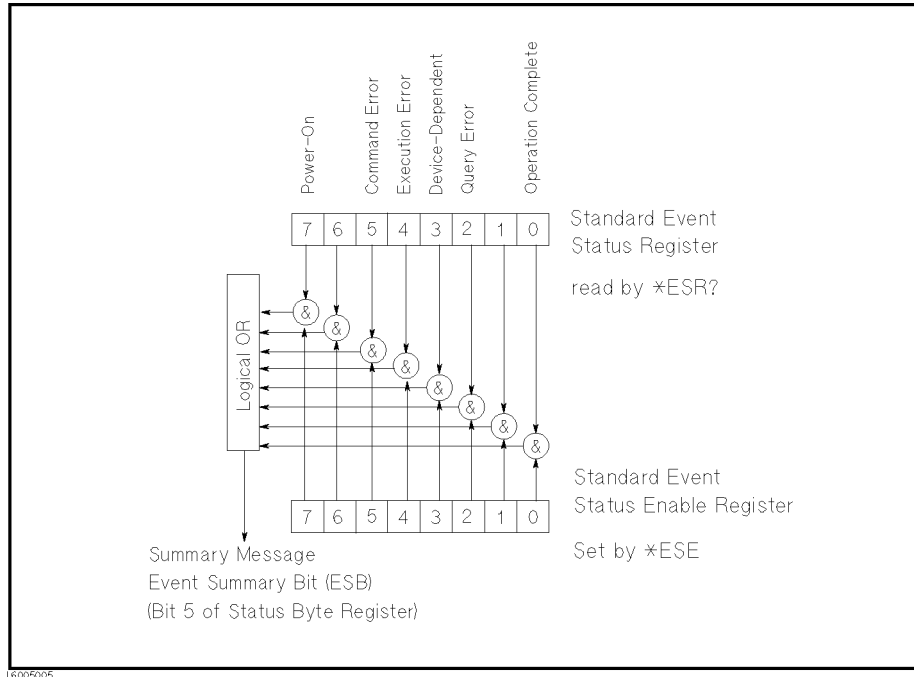

Figure 5-4. Standard Event Status Register

Table 5-3. Standard Event Status Register Assignments

Bit No.	Bit Weight	Description
7	128	Power-On Bit—This bit is set when the 4349B has been turned OFF and then ON since the last time this register was read.
6		always 0 (zero)
5	32	Command Error Bit—This bit is set if the following the command errors occur. <ul style="list-style-type: none"> <li>•An IEEE 488.2 syntax error occurred.</li> <li>•The 4349B received a Group Execute Trigger (GET) inside a program message.</li> </ul>
4	16	Execution Error Bit—This bit is set when a parameter of a GPIB command was outside of its legal input range or is otherwise inconsistent with the 4349B’s capabilities.
3	8	Device-Dependent Error Bit—This bit is set when so many errors have been occurred that the error queue is full.
2	4	Query Error Bit—This bit is set to “1” when reading data from the output buffer and no data was present, or when the data was lost.
1		always 0 (zero)
0	1	Operation Complete Bit—This bit is set when the 4349B has completed all selected pending operations before sending the *OPC command.

## Standard Operation Status Group

The 4349B provides two standard operation status groups—operation status register group and questionable status register group—which can be accessed using STATus subsystem commands. (Refer to STATus subsystem in “GPIB Commands”.) If you are beginner, you will rarely need to use this group. The individual bit assignment of these registers are given “Operation Status Register” and “Questionable Status Register” later in this section.

Each group includes a condition register, an event register, and an enable register.(Illustrated in Figure 5-5.)

The condition register reflects the internal states of 4349B. So each time the 4349B’s condition is changed, its condition bit is changed from “0” to “1”, or from “1” to “0”.

The event register’s bit corresponds to a condition register’s. The transition filter reports to the event register that an event (a bit changed from “1” to “0”) has taken place in the condition register.

The enable register enables the corresponding bit in the event register to set the status summary bit, bit 7, or bit 3 of the status byte.

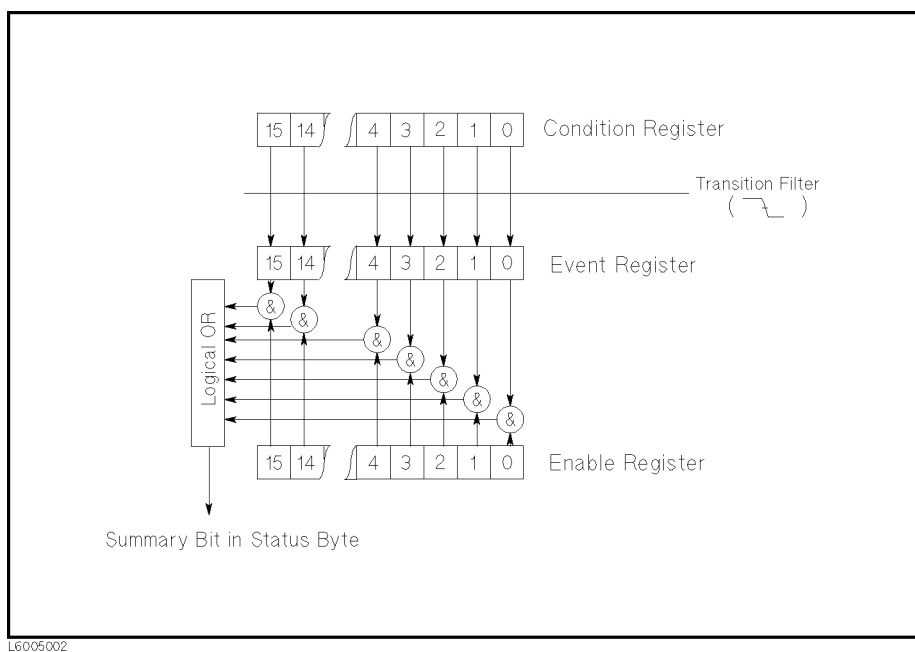

Figure 5-5. Standard Operation Status Group Structure

## 4349B

### Operation Status Register

The Operational Status Register group provides information about the state of the 4349B measurement system.

**Table 5-4. Operation Status Register Assignments**

Bit No.	Bit Weight	Description
9-15		always 0
8	256	DBUF is full.
7	128	Correcting—The 4349B is currently performing a correction.
6		Always 0
5	32	Waiting for Trigger—The 4349B is in a “waiting for trigger” state of the trigger model.
4	16	Measuring—The 4349B is actively measuring.
3		Always 0
2	4	Ranging—The 4349B is currently changing its range.
1	2	Settling—The 4349B is waiting for signals it controls to stabilize enough to begin measurement.
0		Always 0

### Questionable Status Register

The Questionable Status Register group provides information about the quality of 4349B output and measurement data.

The 4349B has no operation to report an event to the questionable status register, whose bits are always 0.

**Table 5-5. Questionable Status Register Assignments**

Bit No.	Bit Weight	Description
15-0		Always 0

## Trigger System

This section provides information about the trigger system of the 4349B. SCPI defines the common trigger model for several types of instruments. The trigger system allows you to have detailed control of the measurement process.

The description of the following information requires more technical expertise than most other topics covered in this chapter. But you can avoid the need to learn the information in this section about using the INITiate commands for making measurements.

### 4349B Trigger System Configuration

The trigger system synchronizes the 4349B measurement with specified events. An event includes GPIB trigger commands or an input trigger pulse input through the External Trigger connector. The Trigger system also allows specifying the number of times to repeat measurement and the delays between measurements.

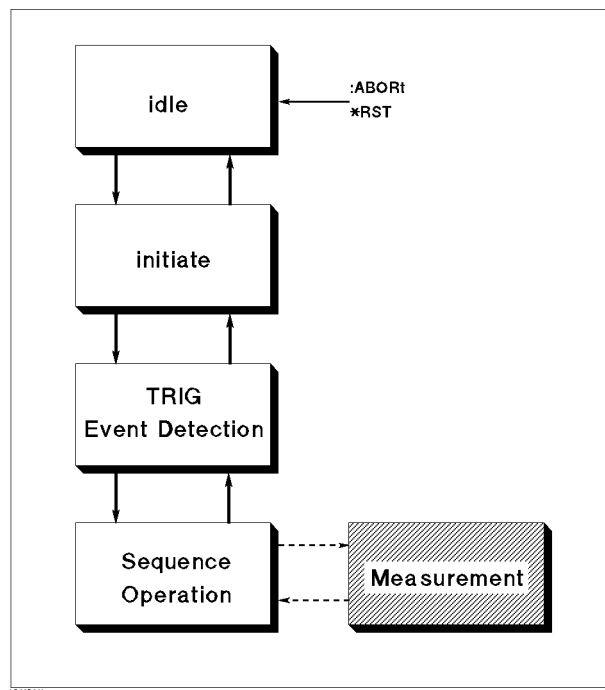

Figure 5-6. Trigger System Configuration

Figure 5-6 shows configuration of the 4349B trigger system. Each undashed block is called a **trigger state**. The 4349B moves between adjacent trigger states depending on its conditions. Power ON state is called **idle** state. You can force the 4349B to the idle state using the :ABORt or \*RST commands. The **initiate** and **TRIGger Event Detection** state causes the 4349B program to branch when specified conditions are met or not. The **Sequence Operation** state signals the instrument hardware to take measurement and listens for the signal that indicates the measurement has been taken.

#### Idle State

The trigger system remains in the idle state until it is initiated by INITiate:IMMediate or INITiate:CONTinuous ON. Once one of these conditions is satisfied, the trigger system exits downward to the **initiate state**. Note that \*RST sets INITiate:CONTinuous OFF.

## 4349B

### Initiate State

If the trigger system is on a downward path, it travels directly through the initiate state without restrictions. If the trigger system is on an upward path, and `INITiate:CONTinuous` is ON, then it exits downward to an event detection state. If the trigger system is on an upward path and `INITiate:CONTinuous` is OFF, then it exits upward to the idle state.

### Event Detection State

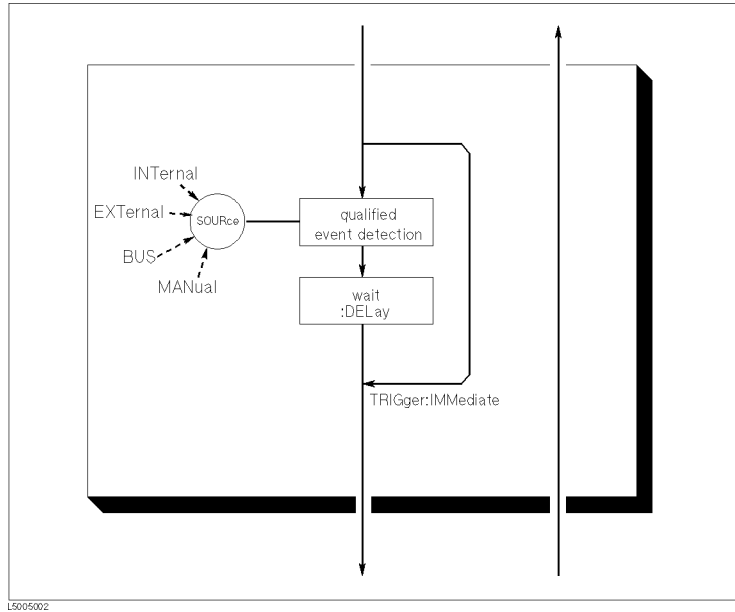

Figure 5-7. Inside an Event Detection State

**SOURCE** The `:TRIGger:SOURce` command specifies which particular input can generate the event required to continue the downward path. If the source chosen is a non-analog signal such as `BUS`, then no further qualifications are required to generate an event. However, if an `INTernal` or `EXTernal` analog signal is chosen, additional qualifications may apply.

**DELay** The `:TRIGger:DELay` command allows you to specify a time delay after the trigger signal is detected. For example, you may want to delay acquiring data until 5 milliseconds after the positive edge to allow the measured signal to settle. Sending `*RST` sets `DELay` to zero.

**IMMediate** The `:TRIGger:IMMediate` command bypasses event detection, `DELay` qualifications one time. The upward path through the event detection state contains only one condition. If the condition is satisfied, the trigger system exits upward.

### Sequence Operation State

The downward entrance to the sequence operation state forces the 4349B to start a measurement. An upward exit is not allowed until the measurement is complete.

## Data Transfer Format

### AScii

Numeric data is transferred as ASCII byte in <NR1>(integer), <NR2>(fixed point), or <NR3>(floating point) format, as appropriate. The numbers are separated by commas as specified in the IEEE 488.2 standard.

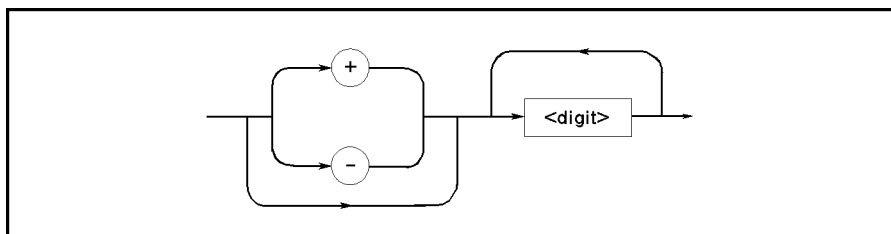

Figure 5-8. NR1 Format

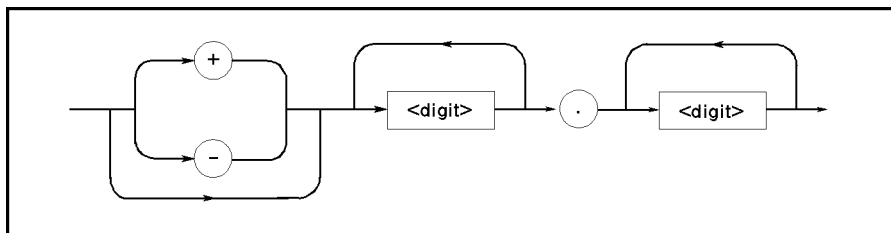

Figure 5-9. NR2 Format

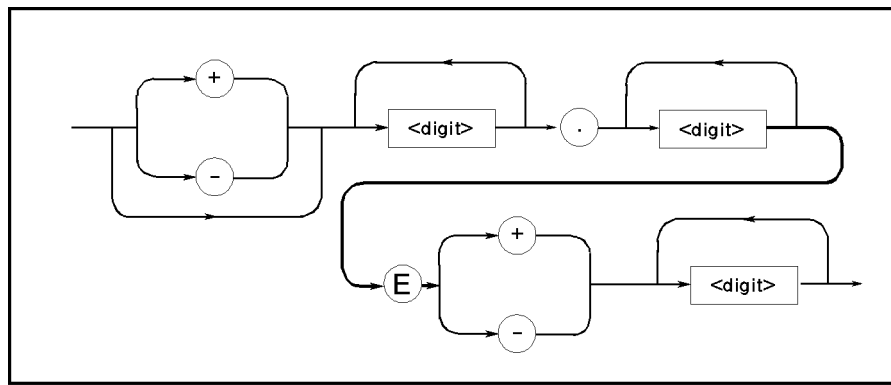

Figure 5-10. NR3 Format

For example, valid expressions for “1000” are,

1000	<NR1> format
1000.0	<NR2> format
+1.00000E+3	<NR3> format



**REAL**

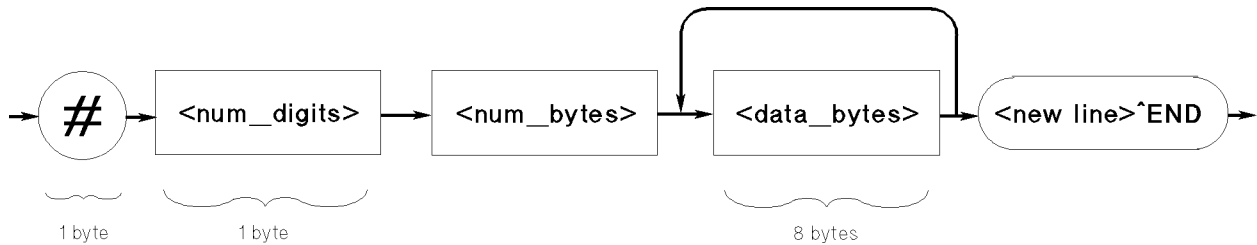

**Figure 5-11. Real Data Format**

This data field is initiated by a unique code, the number sign (#). The second byte, “<num\_digit>” designates the number of the bytes for the “<num\_bytes>”. “<num\_bytes>” designates “<data\_bytes>” length. “<new line>^END” is the response message terminator.

“<data\_bytes>” contains the data in the IEEE 754 floating point numbers of 64-bits. This is the same data format used by the HP technical computers, such as the HP 9000 series 200/300 computers.

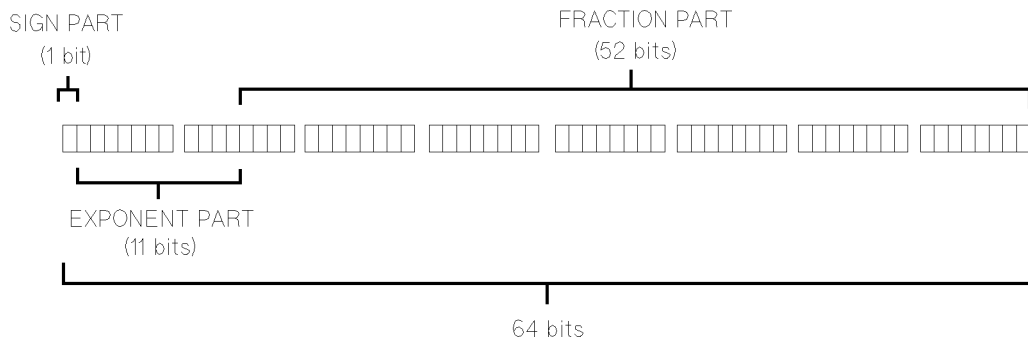

The real number RN represented in floating point format are provided by following formula:

- When  $0 < e < 1111111111$  (2047)
 
$$RN = (-1)^S \times 2^{(EXP-1023)} \times (1 + f/2^{52})$$
- When  $e = 0$ 

$$RN = (-1)^S \times 2^{-1022} \times (f/2^{52})$$
- When  $e = 0, f = 0$ 

$$RN = 0$$

Where,

- s value of sign part (binary)
- e value of exponential part (binary)
- EXP decimal expression of exponential part
- f decimal expression of fractional part



## Application Measurement

---

### Introduction

This chapter provides actual measurement examples and note on measuring insulation resistance of capacitors.

#### Warning



The measurement system using the 4349B and the external voltage source may output dangerous voltage. To prevent an electrical shock, observe the following safety precautions.

- Agilent Technologies recommends you to attach the safety interlock function to the measurement system so that the operators can not touch the parts where dangerous voltage may appear. If not possible, warn the operators and the workers around the measurement system not to touch the parts.
- Use the parts with the safety function to prevent an electrical shock caused by the insulation breakdown, even if dangerous voltage does not appear on the parts directly.
- Turn OFF the output of the external voltage source and discharge the remanent charge of the DUT thoroughly, before touching the measurement system or the DUT where the dangerous voltage may appear.
- Use the power cord shipped with the 4349B and provide an uninterruptible safety earth ground to the instrument.
- Do not apply a dc voltage exceeding  $\pm 50$  V or  $\pm 50$  mA to the INPUT terminals.

Agilent Technologies warrants the 4349B and its accessories provided by Agilent Technologies. Agilent Technologies does not warrant any accidents caused by trouble in an external voltage source or the measurement system.

#### Caution



Do *not* apply a dc voltage exceeding  $\pm 50$  V or  $\pm 50$  mA to the INPUT terminals, or the 4349B's input circuits will be destroyed. Connect a current limiting resistor to avoid the over current when a shorted device is connected.

Refer to “ Installation” in Chapter 2 for details.

## High Throughput Measurement

This section shows the high throughput measurement example of the capacitors insulation resistance test using the 4349B, an external voltage source, and a handler.

1. Set up the measurement systems. Figure 6-3 shows the typical system. Refer to “ Installation” in Chapter 2 for information on setting up the system.

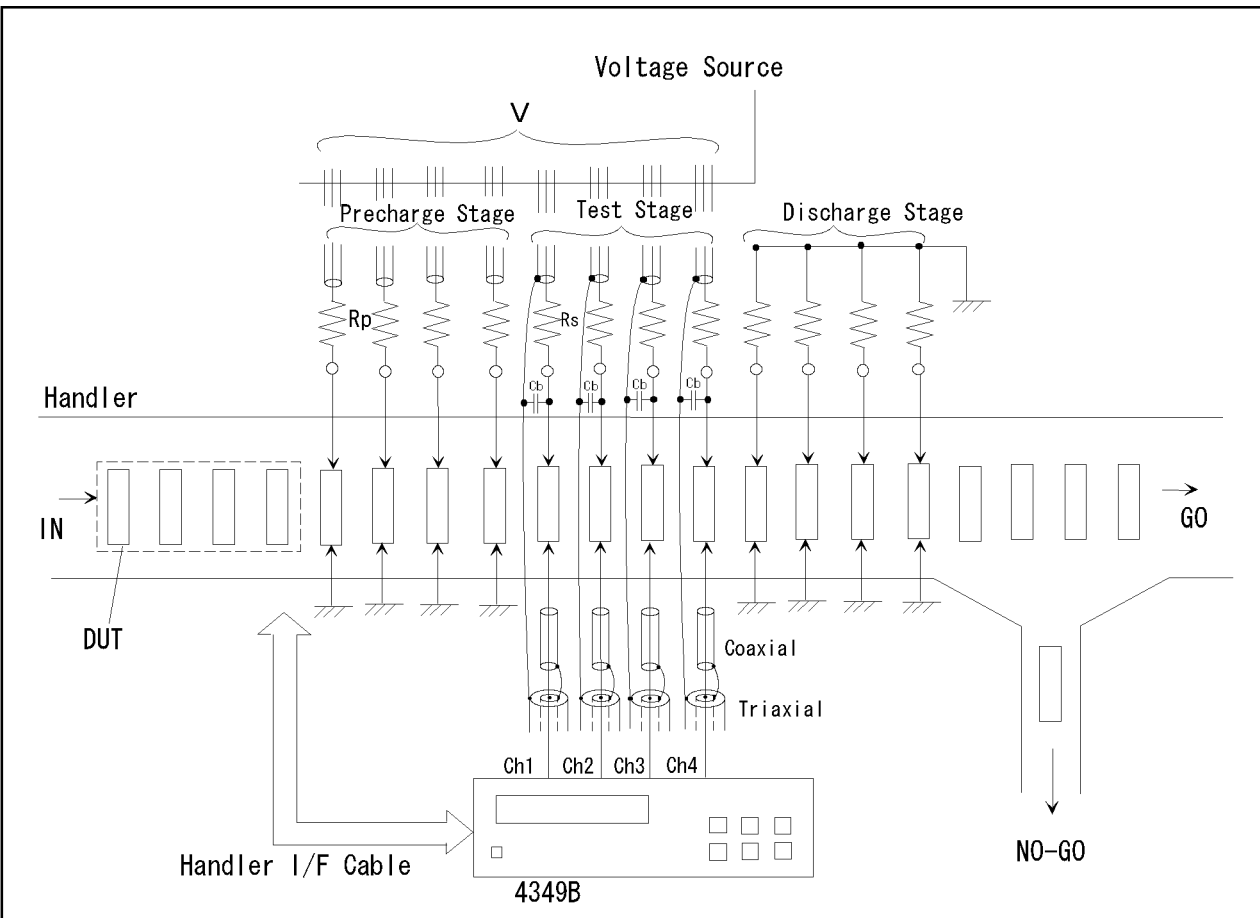

LB0J6106

Figure 6-1. High Throughput Measurement System

2. Enter and run the following sample program.

```

10  OPTION BASE 1
20  DIM St(4,50),Dat(4,50),Comp(4,50)
30  Hp_ib=7
40  ASSIGN @Hp4349 TO 717
50  ASSIGN @Binary TO 717;FORMAT OFF
60  !
70  OUTPUT @Hp4349;"*RST"
80  OUTPUT @Hp4349;"*CLS"
90  !
100 OUTPUT @Hp4349;" :SENS:FUNC 'RES' "
```

## 4349B

```

110 OUTPUT @Hp4349;":SOUR:VOLT1 100"
120 OUTPUT @Hp4349;":SOUR:VOLT2 100"
130 OUTPUT @Hp4349;":SOUR:VOLT3 100"
140 OUTPUT @Hp4349;":SOUR:VOLT4 100"
150 OUTPUT @Hp4349;":CURR:APER 0.03"
160 OUTPUT @Hp4349;":SENS:CURR:RANG1:AUTO OFF"
170 OUTPUT @Hp4349;":SENS:CURR:RANG1 1E-10"
180 OUTPUT @Hp4349;":SENS:CURR:RANG2 1E-10"
190 OUTPUT @Hp4349;":SENS:CURR:RANG3 1E-10"
200 OUTPUT @Hp4349;":SENS:CURR:RANG4 1E-10"
210 !
220 DISP "Open the test leads, then press the 'Continue'."
230 PAUSE
240 DISP "OPEN Correction"
250 OUTPUT @Hp4349;":SENS:CORR:COLL OFFS"
260 OUTPUT @Hp4349;":*OPC?"
270 ENTER @Hp4349;A
280 DISP "Connect DUT, then press the 'Continue'."
290 PAUSE
300 DISP
310 !
320 OUTPUT @Hp4349;":CALC1:LIM:LOW 1E12;UPP 1E13"
330 OUTPUT @Hp4349;":CALC2:LIM:LOW 1E12;UPP 1E13"
340 OUTPUT @Hp4349;":CALC3:LIM:LOW 1E12;UPP 1E13"
350 OUTPUT @Hp4349;":CALC4:LIM:LOW 1E12;UPP 1E13"
360 OUTPUT @Hp4349;":CALC1:LIM:STAT ON"
370 OUTPUT @Hp4349;":DISP:ENAB OFF"
380 OUTPUT @Hp4349;":RES:CONT:VER ON"
390 OUTPUT @Hp4349;":TRIG:SOUR EXT"
400 OUTPUT @Hp4349;":FORM REAL"
410 !
420 OUTPUT @Hp4349;":DATA:POIN DBUF,50"
430 OUTPUT @Hp4349;":DATA:FEED DBUF,'SENS'"
440 OUTPUT @Hp4349;":DATA:FEED:CONT DBUF,ALW"
450 !
460 OUTPUT @Hp4349;":STAT:OPER:ENAB ";DVAL("0000000100000000",2)
470 OUTPUT @Hp4349;":*SRE ";DVAL("11000000",2)
480 OUTPUT @Hp4349;":INIT:CONT ON"
490 !
500 ! Triggering
510 !
520 ON INTR Hp_ib GOTO Buffer_full
530 ENABLE INTR Hp_ib;2
540 LOOP
550 END LOOP
560 !
570 Buffer_full:OFF INTR
580 DISP "Buffer full."
590 OUTPUT @Hp4349;":DATA? DBUF"
600 ENTER @Binary USING "#,6A";A$
610 FOR I=1 TO 50
620     FOR J=1 TO 4
630         ENTER @Binary;St(J,I),Dat(J,I),Comp(J,I)
640     NEXT J
650 NEXT I

```

```

660  ENTER @Binary USING "#,A";A$
670  !
680  FOR I=1 TO 50
690    PRINT I,Dat(1,I),Dat(2,I),Dat(3,I),Dat(4,I)
700  NEXT I
710  END

```

**Figure 6-2. High Throughput Measurement Sample Program**

Lines 70 and 80	Resets the 4349B and clears the status byte register.
Line 100	Selects the resistance measurement mode.
Lines 110 and 120	Enters the voltage value of 100 V for channels 1 to 4.
Line 150	Sets the measurement time mode to LONG.
Lines 160 to 200	Sets the measurement range to 100 pA for channels 1 to 4.
Lines 220 to 300	Performs an OPEN correction, and prompts the operator to connect the DUT.
Lines 320 to 350	Sets the comparator limit values for the channel 1 to 4; the lower limit to $1 \times 10^{12} \Omega$ and the upper limit to the $1 \times 10^{13}$ ohm;.
Line 360	Enables the comparator function.
Line 370	Clears the LCD display.
Line 380	Enables the contact check function.
Line 390	Sets the trigger source mode to External.
Line 400	Sets the data transfer format to the 64-bit real transfer format.
Lines 420 to 440	Sets the size of the data buffer to 50, sets up to feed the measurement data to the data buffer, and sets up to feed data into the data buffers whenever new data is available.
Lines 460 and 480	Enables the DBUF full bits of the operation status register, and the operation status register summary bit of the status byte register.
Line 500	Triggers the measurement from an external trigger source.
Lines 520 to 550	Waits until the data buffers are full.
Lines 590 to 660	Retrieves the measurement data held in DBUF.
Lines 680 to 700	Prints the measurement data.

## Multi Test Voltages Measurement

For the reliable test of ceramic capacitors, the insulation resistance measurement at the low voltage and the high voltage is required. This section shows the multi test voltages measurement example of the capacitors insulation resistance using the 4349B (channels 1 and 2), an external voltage source, and a handler.

1. Set up the measurement systems. Figure 6-3 shows the typical system. Refer to “ Installation” in Chapter 2 for information on setting up the system.

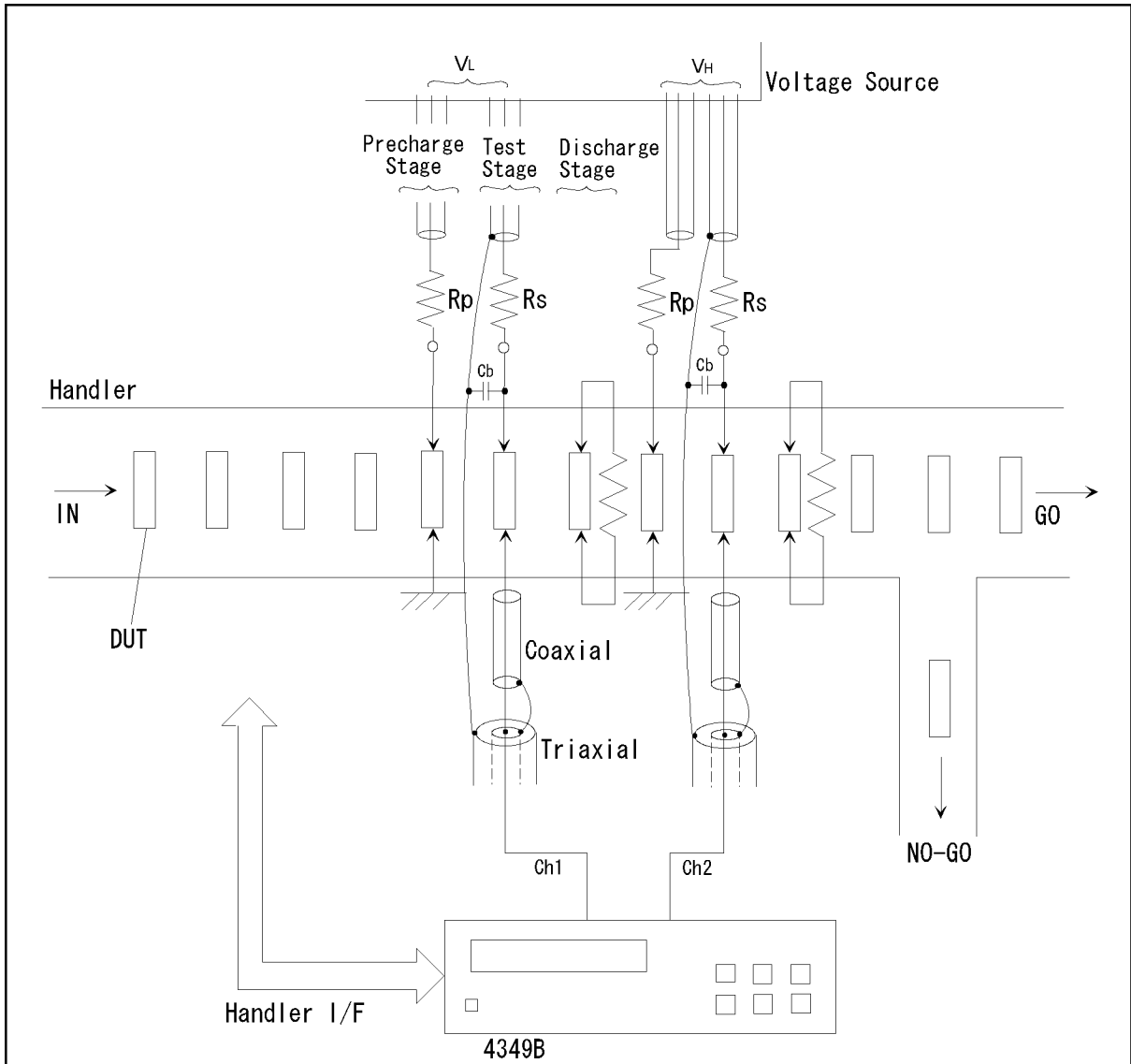

LBOJ6104

Figure 6-3. Multi Test Voltage Measurement System

2. Enter and run the following sample program.

```

10  OPTION BASE 1
20  DIM St(4,50),Dat(4,50),Comp(4,50)
30  Hp_ib=7
40  ASSIGN @Hp4349 TO 717
50  ASSIGN @Binary TO 717;FORMAT OFF
60  !
70  OUTPUT @Hp4349;"*RST"
80  OUTPUT @Hp4349;"*CLS"
90  !
100 OUTPUT @Hp4349;":SENS:FUNC 'RES'"
110 OUTPUT @Hp4349;":SOUR:VOLT1 1"
120 OUTPUT @Hp4349;":SOUR:VOLT2 100"
130 OUTPUT @Hp4349;":CURR:APER 0.03"
140 OUTPUT @Hp4349;":SENS:CURR:RANG1:AUTO OFF"
150 OUTPUT @Hp4349;":SENS:CURR:RANG1 1E-10"
160 OUTPUT @Hp4349;":SENS:CURR:RANG2 1E-10"
170 !
180 DISP "Open the test leads, then press the 'Continue'."
190 PAUSE
200 DISP "OPEN Correction"
210 OUTPUT @Hp4349;":SENS:CORR:COLL OFFS"
220 OUTPUT @Hp4349;"*OPC?"
230 ENTER @Hp4349;A
240 DISP "Connect DUT, then press the 'Continue'."
250 PAUSE
260 DISP
270 !
280 OUTPUT @Hp4349;":CALC1:LIM:LOW 1E12;UPP 1E13"
290 OUTPUT @Hp4349;":CALC2:LIM:LOW 1E12;UPP 1E13"
300 OUTPUT @Hp4349;":CALC1:LIM:STAT ON"
310 OUTPUT @Hp4349;":DISP:ENAB OFF"
320 OUTPUT @Hp4349;":RES:CONT:VER ON"
330 OUTPUT @Hp4349;":TRIG:SOUR EXT"
340 OUTPUT @Hp4349;":FORM REAL"
350 !
360 OUTPUT @Hp4349;":DATA:POIN DBUF,50"
370 OUTPUT @Hp4349;":DATA:FEED DBUF,'SENS'"
380 OUTPUT @Hp4349;":DATA:FEED:CONT DBUF,ALW"
390 !
400 OUTPUT @Hp4349;":STAT:OPER:ENAB ";DVAL("0000000100000000",2)
410 OUTPUT @Hp4349;"*SRE ";DVAL("11000000",2)
420 OUTPUT @Hp4349;":INIT:CONT ON"
430 !
440 ! Triggering
450 !
460 ON INTR Hp_ib GOTO Buffer_full
470 ENABLE INTR Hp_ib;2
480 LOOP
490 END LOOP
500 !
510 Buffer_full:OFF INTR
520 DISP "Buffer full."

```



## 4349B

```
530  OUTPUT @Hp4349;":DATA? DBUF"
540  ENTER @Binary USING "#,6A";A$
550  FOR I=1 TO 50
560    FOR J=1 TO 4
570      ENTER @Binary;St(J,I),Dat(J,I),Comp(J,I)
580    NEXT J
590  NEXT I
600  ENTER @Binary USING "#,A";A$
610  !
620  FOR I=1 TO 50
630    PRINT Dat(1,I),Dat(2,I)
640  NEXT I
650  END
```

**Figure 6-4. Multi Test Voltage Measurement Sample Program**

Lines 70 and 80	Resets the 4349B and clears the status byte register.
Line 100	Selects the resistance measurement mode.
Lines 110 and 120	Enters the voltage value of 1 V for channel 1, and 100 V for channel 2.
Line 130	Sets the measurement time mode to LONG.
Lines 140 to 160	Sets the measurement range to 100 pA for channel 1 and channel 2.
Lines 180 to 260	Performs an OPEN correction, and prompts the operator to connect the DUT.
Lines 280 and 290	Sets the comparator limit values for channel 1 and channel 2; the lower limit to $1 \times 10^{12} \Omega$ and the upper limit to the $1 \times 10^{13}$ ohm;.
Line 300	Enables the comparator function.
Line 310	Clears the LCD display.
Line 320	Enables the contact check function.
Line 330	Sets the trigger source mode to External.
Line 340	Sets the data transfer format to the 64-bit real transfer format.
Lines 360 to 380	Sets the size of the data buffer to 50, sets up to feed the measurement data to the data buffer, and sets up to feed data into the data buffers whenever new data is available.
Lines 400 and 420	Enables the DBUF full bits of the operation status register, and the operation status register summary bit of the status byte register.
Line 440	Triggers the measurement from an external trigger source.
Lines 460 to 490	Waits until the data buffers are full.
Lines 530 to 600	Retrieves the measurement data held in DBUF.
Lines 620 to 640	Prints the measurement data.

---

## Note on Measuring Insulation Resistance of Capacitors

This section provides information on how to measure the insulation resistance of capacitors using the 4349B and an external DC voltage source. It covers the following subjects:

- The external DC voltage source.
- How to select the optimum measurement range.
- Additional errors caused by the external DC voltage source.
- How to reduce the measurement error.

### The External DC Voltage Source

When measuring a capacitor's leakage current (insulation resistance), the DC voltage source's noise passes through the capacitor and flows into the ammeter. If the noise level is too high, the current measurement accuracy is degraded. To avoid this problem, use a low noise external voltage source.

### How to Select the Optimum Measurement Range

The useable measurement range is restricted by the DUT's capacitance value. It is important to consider not only the DC current measurement value but also the DUT's capacitance value when selecting the measurement range. Select the optimum measurement range as follows:

1. Calculate the DC current measurement value ( $I_m$ ) from the DUT's (capacitor) resistance ( $R_{dut}$ ) and the test voltage ( $V_s$ ) as  $I_m = V_s / R_{dut}$ .
2. Select the lowest range that can measure the current value calculated in step 1 using Table 6-1.
3. If the DUT's capacitance value is within the Measurable Capacitance of the range selected in step 2, you can use that range for measuring the DUT.

If the DUT's capacitance value is higher than the Measurable Capacitance of the range selected in step 2, change the measurement range to a higher range (or select a slower measurement speed) until the DUT's capacitance value is within the Measurable Capacitance.

Table 6-1. Measurable DC Current and Capacitance in Each Range

Measurement Range	Measurement Speed	Current Measurement Range	Measurable Capacitance
100 pA	10 ms	—	—
	30 ms	1 pA to 145 pA	$\leq 1$ nF
	100 ms	1.4 pA to 145 pA	$\leq 10$ nF
	400 ms	1.4 pA to 145 pA	$\leq 10$ nF
1 nA	10 ms	10 pA to 1.45 nA	$\leq 1$ nF
	30 ms	2 pA to 1.45 nA	$\leq 10$ nF
	100 ms	5 pA to 1.45 nA	$\leq 100$ nF
	400 ms	5 pA to 1.45 nA	$\leq 100$ nF
10 nA	10 ms	30 pA to 14.5 nA	$\leq 10$ nF
	30 ms	11 pA to 14.5 nA	$\leq 100$ nF
	100 ms	41 pA to 14.5 nA	$\leq 1$ $\mu$ F
	400 ms	41 pA to 14.5 nA	$\leq 1$ $\mu$ F
100 nA	10 ms	200 pA to 145 nA	$\leq 100$ nF
	30 ms	100 pA to 145 nA	$\leq 1$ $\mu$ F
	100 ms	400 pA to 145 nA	$\leq 10$ $\mu$ F
	400 ms	400 pA to 145 nA	$\leq 10$ $\mu$ F
1 $\mu$ A	10 ms	2 nA to 1.45 $\mu$ A	$\leq 1$ $\mu$ F
	30 ms	1 nA to 1.45 $\mu$ A	$\leq 10$ $\mu$ F
	100 ms	4 nA to 1.45 nA	$\leq 100$ $\mu$ F
	400 ms	4 nA to 1.45 nA	$\leq 100$ $\mu$ F
10 $\mu$ A	10 ms	20 nA to 14.5 $\mu$ A	$\leq 10$ $\mu$ F
	30 ms	10 nA to 14.5 $\mu$ A	$\leq 100$ $\mu$ F
	100 ms	—	—
	400 ms	—	—
100 $\mu$ A	10 ms	120 nA to 100 $\mu$ A	$\leq 100$ $\mu$ F
	30 ms	—	—
	100 ms	—	—
	400 ms	—	—

## Additional Error Due to Voltage Source Noise

The error caused by the DC voltage source's noise appears as a measurement value fluctuation. Figure 6-5 shows an estimation of the additional error caused by the DC voltage source's noise under the following conditions:

External DC voltage output : 100 V

4349B Measurement Speed : 30 ms

DC voltage source performance :

Ripple	$5 \mu\text{Vrms}(@50 \text{ Hz})$
Wide band noise	$1 \mu\text{Vrms}/\sqrt{\text{Hz}}(@50 \text{ Hz})$
Switching noise	$< 10 \text{ mVrms}(@100 \text{ Hz})$

**Note** The DC voltage source's output resistance is assumed to be  $0 \Omega$  in this example.

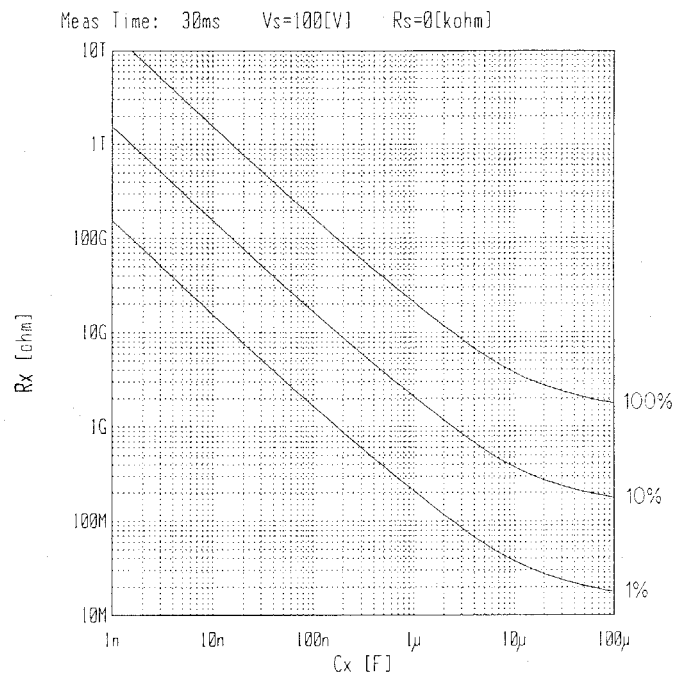

**Figure 6-5. Additional Error Due to Voltage Source Noise**

For example, when measuring a capacitor of  $2 \text{ G}\Omega$  resistance and  $1 \mu\text{F}$  capacitance, the leakage current ( $50 \text{ nA} = 100 \text{ V}/2 \text{ G}\Omega$ ) can be measured within 10% additional error. That is, the measurement value will fluctuate from  $45 \text{ nA}$  to  $55 \text{ nA}$  (or  $1.82 \text{ G}\Omega$  to  $2.22 \text{ G}\Omega$ ).

Figure 6-5 shows the measurement error due to the external DC voltage source only. To estimate the total system measurement error, it is also necessary to include the 4349B's measurement accuracy in addition to the error shown in Figure 6-5.

## How to Reduce the Measurement Error

The measurement error due to the DC voltage source's noise can be reduced by connecting a resistor in series with the DUT(capacitor).

Figure 6-6 shows the DC resistance and capacitance value that can be measured within 10% additional error when connecting a series resistor (1 k $\Omega$ , 5 k $\Omega$ , 10 k $\Omega$ , 50 k $\Omega$ , and 100 k $\Omega$ ). The external DC voltage source used in this example is the same as that of Figure 6-5.

For example, in the case of measuring a 10  $\mu$ F capacitor's resistance, the maximum resistance that can be measured within 10% error is

- about 200 M $\Omega$  without a series resistor,
- about 1.8 G $\Omega$  with a 100 k $\Omega$  series resistor.

As shown in Figure 6-6, the additional error due to the DC voltage source's noise can be reduced by connecting a series resistor, plus you can expand the measurable resistance/capacitance range. However, it must be noted that the required charging time for the DUT becomes longer if you connect a series resistor.

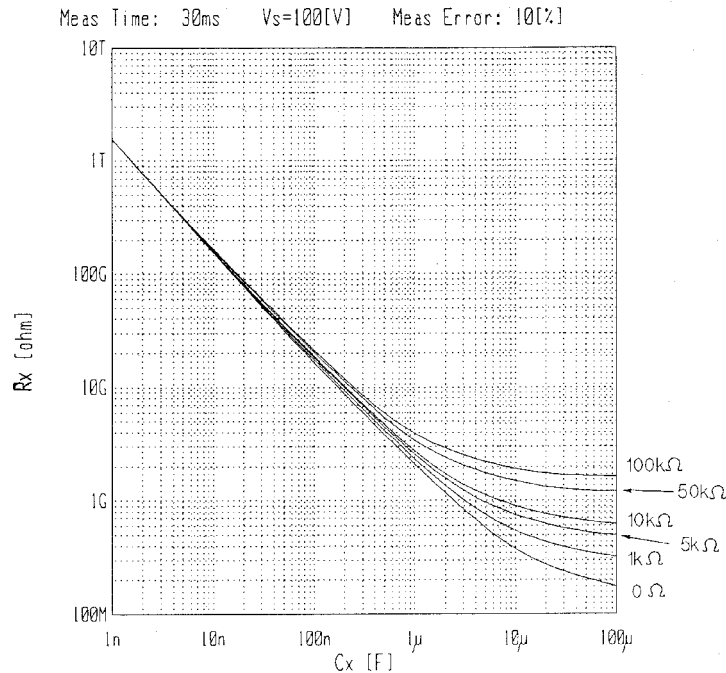

**Figure 6-6. 10% Additional Error**

## Precharge Time and Wait Time

When setting up the system for measuring the insulation resistance of capacitors, consider the precharge time and the wait time.

### Note



The precharge time of an ideal capacitor is described in this section. Generally, you should consider characteristics of a dielectric for the estimation of the actual precharge time.

#### ■ Precharge time

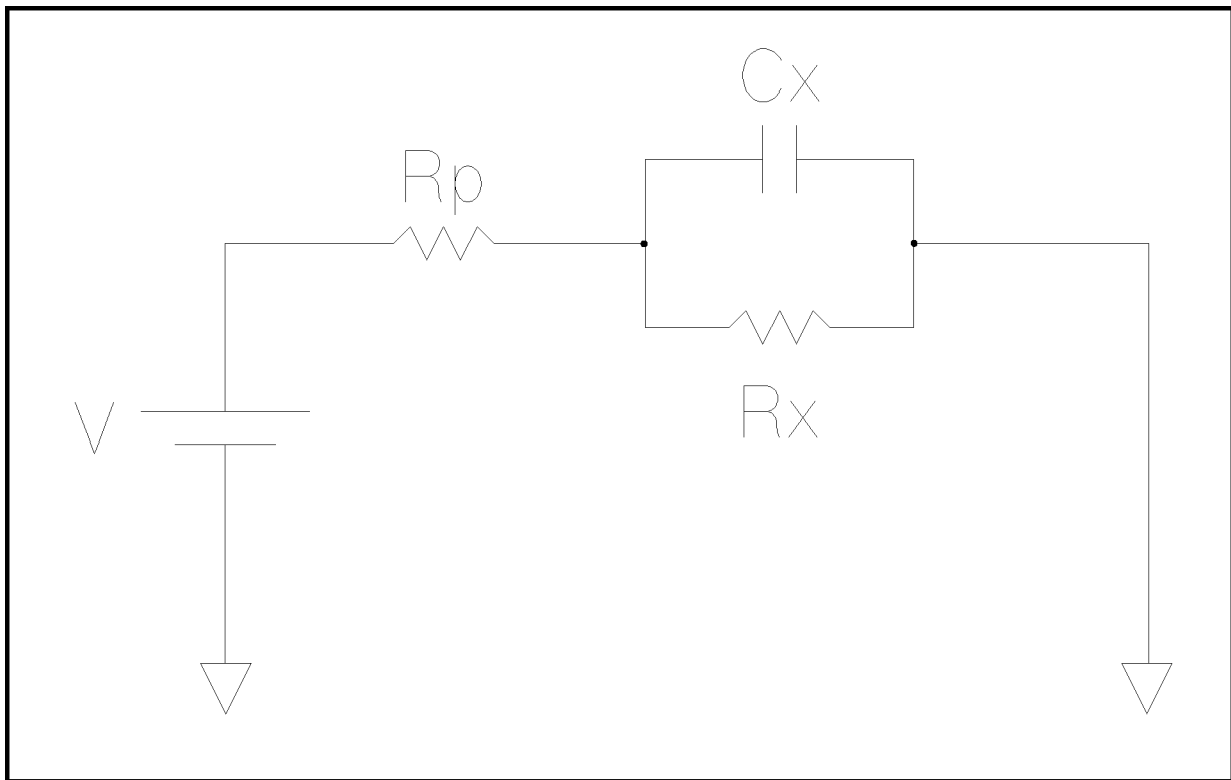

L6006002

**Figure 6-7. Precharge Time**

When the capacitor is charged through precharge resistor  $R_p$ , the precharge time  $t_p$  is calculated as follows (where,  $R_x \gg R_p$ ):

$$t_p = -C_x \times R_p \times \ln K$$

where,  $C_x$  : Capacitance value [F]

$K$  : (Test voltage – Charge voltage) / Test voltage

For example, when  $R_p$  is 1 k $\Omega$  ( $=10^3 \Omega$ ),  $C_x$  is 1  $\mu\text{F}$  ( $=10^{-6}$  F), and  $K$  is 0.1, the precharge time is,

$$\begin{aligned} t_p &= -10^{-6} \times 10^3 \times \ln 0.1 \\ &= 2.3[\text{ms}] \end{aligned}$$

In this example, one precharge stage is enough because  $t_p$  is less than the measurement time.

## 4349B

### ■ Wait Time

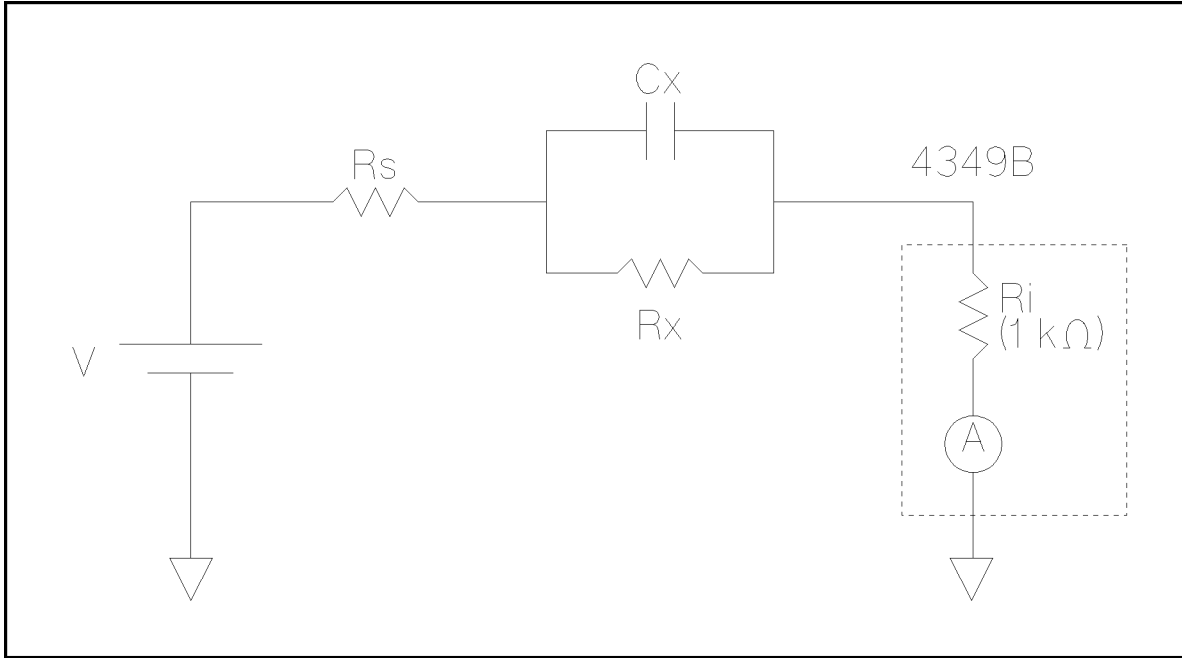

LB006003

**Figure 6-8. Wait Time**

When the test voltage is different from the precharge voltage, a wait time is required regardless of performance of the high resistance meter. The wait time  $t_w$  is calculated as follows:

$$t_w = -C_x \times (R_s + R_i) \times \ln\left(\frac{X}{100} \times \frac{R_s + R_i}{R_x} \times \frac{1}{K}\right)$$

where,  $R_s$  : source resistance [ $\Omega$ ],  
 $R_i$  : input resistance [ $\Omega$ ],  
 $X$  : measurement error [%],  
 $K$  : (Test voltage – Charge voltage) / Test voltage

For example, when  $R_s$  is 1 k $\Omega$  ( $=10^3 \Omega$ ),  $C_x$  : 1  $\mu\text{F}$  ( $=10^{-6} \text{ F}$ ),  $R_x$  : 1 G $\Omega$  ( $=10^9 \Omega$ ),  $X$  is 10%, and  $K$  is 0.1, the wait time is,

$$\begin{aligned} t_w &= -10^{-6} \times (10^3 + 10^3) \times \ln\left(\frac{10}{100} \times \frac{10^3 + 10^3}{10^9} \times \frac{1}{0.1}\right) \\ &= 26.2[\text{ms}] \end{aligned}$$





## Measurement Basics

---

### Introduction

This chapter provides information to help you work more effectively.

---

### Insulation Resistance Measurement

#### Residual Charge Effect

Once a high resistance insulation material has been charged with a voltage, the material will continue to have a residual voltage across it for a while after the charging voltage is removed. So, when you want to measure high resistance materials after they have been charged once, wait long enough for the residual voltage to discharge or the measurement value will be incorrect. How long you must wait depends on the characteristics of the material, the charge voltage level, and the voltage level to which the material must discharge to before starting the measurement.

#### Absorption Phenomena

When a high insulation resistance material is charged with a voltage for a long time, the resistance value of the material will increase. So record the time from the start of the pre-charge to the start of the measurement when measuring and comparing samples of a material. The pre-charge time should be consistent from sample to sample.

#### Voltage Coefficient and Temperature Coefficient

The resistance value of an insulation material is measurement voltage dependent: the insulation resistance of most insulation materials increases, as the measurement voltage is increased.

The resistance value of the insulation material is dependent on the ambient temperature. For the best measurement accuracy, measure the DUT while it is in a constant temperature test chamber.

Record the measurement voltage and the ambient temperature at which the measurement is made.

## Shielding

The variation in total current as seen by the measurement circuit can be caused by power-line pickup, adjacent fields of excessive strength, flexing the test leads beyond reasonable limits, or while changing the position of the leads relative to their surroundings. Most noise problems of this type are transient, and contribute more inconvenience than error. Any suitable shielded enclosure will suffice to reduce unwanted pick-up. Connect the shield to guard (ground). If using the sensitive measurement ranges, lead movement or operator proximity will affect the stability of the measurement readings, stationary leads and shielding are recommended.

# General Information

---

## Introduction

This chapter provides the following general information for the 4349B:

- Specifications
- Supplemental Performance Characteristics

---

## Specifications

### Measurement Parameters

R (dc resistance), I (dc current)

---

#### Note



The 4349B does not contain a test voltage source. An external voltage source for resistance measurements must be supplied by the user. The 4349B calculates the resistance using current (I) measurement data and the test voltage data entered into memory by the user.

---

### Measurement Conditions

- DC Test Voltage Range
  - 0 to 5000 V in 0.1 V steps (data entry only)
- Number of Test Channels
  - 4 channels (Option 001: 2 channels)
  - On being triggered the 4349B simultaneously measures each channel.
- Input Resistance
  - 1 k $\Omega$   $\pm$  5%
- Input Offset Voltage Accuracy
  - $\pm$  2.5 mV
- Ranging
  - Auto and Hold (manual)
- Trigger
  - Mode
    - Internal, Manual, External, and Bus
  - Delay Time
    - 0 to 9.999 s in 0.001 s steps
- Test Cable Length
  - 2 meters maximum
- Measurement Time Mode
  - 10 ms, 30 ms, 100 ms, and 400 ms
- Averaging
  - 1 to 256

**4349B**

**Measurement Range**

R:  $1 \times 10^3$  to  $1 \times 10^{15} \Omega$

I: 1 pA to 100  $\mu$ A

**Measurement Accuracy**

The following conditions must be met:

- 1. Warm up time:  $\geq 30$  min
- 2. Ambient temperature:  $23 \pm 5 \text{ }^\circ\text{C}$
- 3. Open correction has been performed.

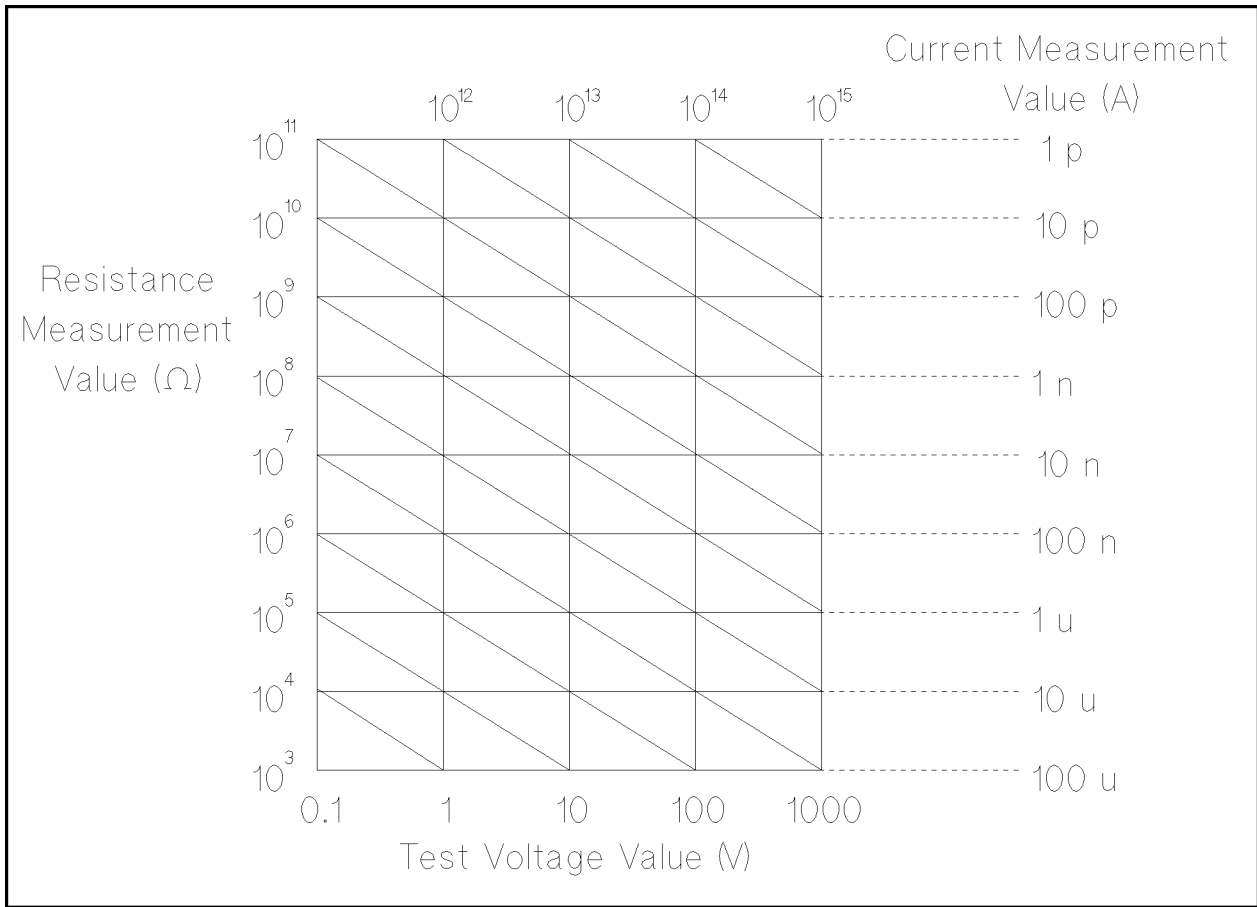

L6008002

**Figure 8-1. Resistance to Current Conversion Diagram**

Table 8-1. Measurement Accuracy

Range	Measurement Time Mode	Resistance Measurement <sup>1,2</sup> ( $\pm$ % of Readings)	Current Measurement <sup>1,3</sup> ( $\pm$ % of Readings)
100 pA	10 ms	—	—
	30 ms	$4.4 + \frac{100V_o + 1.0 \times 10^{-10} R_m}{V_s} + A_v$ $(4.4 + \frac{100V_o + 1.1 \times 10^{-10} R_m}{V_s} + A_v)^4$	$2.57 + \frac{1.0 \times 10^{-10}}{I_m}$ $(2.57 + \frac{1.1 \times 10^{-10}}{I_m})^4$
	100 ms	$4.4 + \frac{100V_o + 1.4 \times 10^{-10} R_m}{V_s} + A_v$ $(4.4 + \frac{100V_o + 1.5 \times 10^{-10} R_m}{V_s} + A_v)^4$	$2.57 + \frac{1.4 \times 10^{-10}}{I_m}$ $(2.57 + \frac{1.5 \times 10^{-10}}{I_m})^4$
	400 ms	$4.4 + \frac{100V_o + 1.4 \times 10^{-10} R_m}{V_s} + A_v$ $(4.4 + \frac{100V_o + 1.5 \times 10^{-10} R_m}{V_s} + A_v)^4$	$2.57 + \frac{1.4 \times 10^{-10}}{I_m}$ $(2.57 + \frac{1.5 \times 10^{-10}}{I_m})^4$
1 nA	10 ms	$4.4 + \frac{100V_o + 1.0 \times 10^{-10} R_m}{V_s} + A_v$	$2.57 + \frac{1.0 \times 10^{-10}}{I_m}$
	30 ms	$4.4 + \frac{100V_o + 2.0 \times 10^{-10} R_m}{V_s} + A_v$	$2.57 + \frac{2.0 \times 10^{-10}}{I_m}$
	100 ms	$4.4 + \frac{100V_o + 5.0 \times 10^{-10} R_m}{V_s} + A_v$	$2.57 + \frac{5.0 \times 10^{-10}}{I_m}$
	400 ms	$4.4 + \frac{100V_o + 5.0 \times 10^{-10} R_m}{V_s} + A_v$	$2.57 + \frac{5.0 \times 10^{-10}}{I_m}$
10 nA	10 ms	$2.6 + \frac{100V_o + 3.0 \times 10^{-9} R_m}{V_s} + A_v$	$2 + \frac{3.0 \times 10^{-9}}{I_m}$
	30 ms	$2.6 + \frac{100V_o + 1.1 \times 10^{-9} R_m}{V_s} + A_v$	$2 + \frac{1.1 \times 10^{-9}}{I_m}$
	100 ms	$2.6 + \frac{100V_o + 4.1 \times 10^{-9} R_m}{V_s} + A_v$	$2 + \frac{4.1 \times 10^{-9}}{I_m}$
	400 ms	$2.6 + \frac{100V_o + 4.1 \times 10^{-9} R_m}{V_s} + A_v$	$2 + \frac{4.1 \times 10^{-9}}{I_m}$
100 nA	10 ms	$2 + \frac{100V_o + 2 \times 10^{-8} R_m}{V_s} + A_v$	$2 + \frac{2 \times 10^{-8}}{I_m}$
	30 ms	$2 + \frac{100V_o + 1 \times 10^{-8} R_m}{V_s} + A_v$	$2 + \frac{1 \times 10^{-8}}{I_m}$
	100 ms	$2 + \frac{100V_o + 4 \times 10^{-8} R_m}{V_s} + A_v$	$2 + \frac{4 \times 10^{-8}}{I_m}$
	400 ms	$2 + \frac{100V_o + 4 \times 10^{-8} R_m}{V_s} + A_v$	$2 + \frac{4 \times 10^{-8}}{I_m}$
1 $\mu$ A	10 ms	$2 + \frac{100V_o + 2 \times 10^{-7} R_m}{V_s} + A_v$	$2 + \frac{2 \times 10^{-7}}{I_m}$
	30 ms	$2 + \frac{100V_o + 1 \times 10^{-7} R_m}{V_s} + A_v$	$2 + \frac{1 \times 10^{-7}}{I_m}$
	100 ms	$2 + \frac{100V_o + 4 \times 10^{-7} R_m}{V_s} + A_v$	$2 + \frac{4 \times 10^{-7}}{I_m}$
	400 ms	$2 + \frac{100V_o + 4 \times 10^{-7} R_m}{V_s} + A_v$	$2 + \frac{4 \times 10^{-7}}{I_m}$
10 $\mu$ A	10 ms	$2 + \frac{100V_o + 2 \times 10^{-6} R_m}{V_s} + A_v$	$2 + \frac{2 \times 10^{-6}}{I_m}$
	30 ms	$2 + \frac{100V_o + 1 \times 10^{-6} R_m}{V_s} + A_v$	$2 + \frac{1 \times 10^{-6}}{I_m}$
	100 ms	—	—
	400 ms	—	—
100 $\mu$ A	10 ms	$2 + \frac{100V_o + 1.2 \times 10^{-5} R_m}{V_s} + A_v$	$2 + \frac{1.2 \times 10^{-5}}{I_m}$
	30 ms	—	—
	100 ms	—	—
	400 ms	—	—

1 Multiply the basic accuracy by the following temperature (T) indicated error, when the temperature range of 0 to 45°C.

18°C  $\leq$  T  $\leq$  28°C:  $\times 1$

8°C  $\leq$  T < 18°C or 28°C < T  $\leq$  38°C:  $\times 2$

0°C  $\leq$  T < 8°C or 38°C < T  $\leq$  45°C:  $\times 4$

2 Rm: Measured value [ $\Omega$ ]

Vs: Voltage setting of the voltage source [V], Av: Voltage accuracy of the voltage source [%]

Vo: Input offset voltage of the 4349B ( $= \pm 2.5$  mV) + Offset voltage of the voltage source [V]

3 Im: Measured value [A]

4 When the test cable length is 1.5 to 2m

#### 8-4 General Information

## 4349B

### Measurement Support Functions

- Display

40-digits × 2-lines LCD display. Capable of displaying: measurement values, comparator/contact check decisions, control settings, self test messages, and annunciators, annunciator labels.

- Open Correction

Eliminates measurement errors due to the leakage in the test cable/test fixture.

- Comparator

HIGH/IN/LOW for the measurement parameter of each test channel

- Contact Check

Contact failure between the test fixture and device can be detected.

- GPIB Interface

All control settings, measurement values, self-test results, and comparator information.

- Handler Interface

All outputs signals are negative logic, opto-isolated open collector outputs

Output Signals Include:

HIGH/IN/LOW and no contact for each channel, index, end-of-measurement, and alarm

Input Signals Include:

Keylock and external trigger

- Save/Recall

Ten instrument setups can be saved/recalled from the internal non-volatile memory.

- Continuous Memory Capability

If the instrument is turned OFF, or if a power failure occurs, the instrument settings are automatically saved.

- Key Lock

Disables key input from the front panel.

## General

### ■ Power Requirements

100/120/220/240 V  $\pm 10\%$ , 47 to 66 Hz  
45 VA max

### ■ Operating Temperature, Humidity, and Altitude

0 to 45 °C,  $\leq 90\%$  RH @ 40 °C, 0 to 2000 meters  
Condensation must be avoided.

### ■ Storage Temperature, Humidity, and Altitude

-40 to 70 °,  $\leq 95\%$  RH @ 65 °, 0 to 4572 meters  
Condensation must be avoided.

### ■ EMC

Complies with CISPR 11 (1990) / EN 55011 (1991) : Group 1, Class A.

Complies with EN 61000-3-3 (1995) / IEC 1000-3-3 (1994)

Complies with EN 50082-1 (1992) / IEC 801-2 (1991) : 4 kV CD, 8 kV AD.

Complies with EN 50082-1 (1992) / IEC 801-3 (1984) : 3 V/m.

Complies with EN 50082-1 (1992) / IEC 801-4 (1988) : 0.5 kV Signal Lines, 1 kV Power Lines.

This ISM device complies with Canadian ICES-001.

Cet appareil ISM est conforme à la norme NMB-001 du Canada.

### ■ Dimensions

approximately 320 (W) by 100 (H) by 450 (D) mm

### ■ Weight

approximately 6.5 kg



## Supplemental Performance Characteristics

The supplemental performance characteristics are listed below. These characteristics are not specifications but are typical characteristics included as additional information for the operator.

### Typical Measurement Accuracy

#### Resistance measurement

Range	Measurement Time Mode	Measurement Accuracy <sup>1</sup> ±(% of Readings)
100 pA	10 ms	—
	30 ms	$2.6 + \frac{100V_o + 1.0 \times 10^{-10} R_m}{V_s} + A_v$
1 nA	10 ms	$2.6 + \frac{100V_o + 1.0 \times 10^{-10} R_m}{V_s} + A_v$
	30 ms	$2.6 + \frac{100V_o + 2.0 \times 10^{-10} R_m}{V_s} + A_v$
10 nA	10 ms	$2.0 + \frac{100V_o + 3.0 \times 10^{-9} R_m}{V_s} + A_v$
	30 ms	$2.0 + \frac{100V_o + 1.1 \times 10^{-9} R_m}{V_s} + A_v$

<sup>1</sup> R<sub>m</sub>: Measured value [Ω]

V<sub>s</sub>: Voltage setting [V]

V<sub>o</sub>: Offset voltage [V]

A<sub>v</sub>: Voltage accuracy [%]

(V<sub>s</sub>, V<sub>o</sub>, and A<sub>v</sub> are characteristics of the external voltage source.)

#### Current Measurement

Range	Measurement Time Mode	S/N (% of Readings)	Temperature Coefficient (@ 23 ± 5 °C) ±(% of Readings + % of Range)
100 pA	30 ms	0.08	0.12 + 0.420
1 nA	10 ms	0.08	0.12 + 0.060
	30 ms	0.02	0.10 + 0.045
10 nA	10 ms	0.07	0.12 + 0.020
	30 ms	0.03	0.10 + 0.015
1 μA	10 ms	0.06	0.12 + 0.020
	30 ms	0.03	0.10 + 0.010
10 μA	10 ms	0.06	0.12 + 0.020
	30 ms	0.03	0.10 + 0.010
100 μA	10 ms	0.04	0.10 + 0.010

## Measurable Capacitance Range

**Table 8-2.**  
**Measurable Current Range and Measurable Capacitance Range**

Range	Measurement Time	Current measurement range	Measurable Capacitance Range
100 pA	10 ms	—	—
	30 ms	1 pA to 145 pA	$\leq 1$ nF
	100 ms	1.4 pA to 145 pA	$\leq 10$ nF
	400 ms	1.4 pA to 145 pA	$\leq 10$ nF
1 nA	10 ms	10 pA ~ 1.45 nA	$\leq 1$ nF
	30 ms	2 pA to 1.45 nA	$\leq 10$ nF
	100 ms	5 pA to 1.45 nA	$\leq 100$ nF
	400 ms	5 pA to 1.45 nA	$\leq 100$ nF
10 nA	10 ms	30 pA to 14.5 nA	$\leq 10$ nF
	30 ms	11 pA to 14.5 nA	$\leq 100$ nF
	100 ms	41 pA to 14.5 nA	$\leq 1$ $\mu$ F
	400 ms	41 pA to 14.5 nA	$\leq 1$ $\mu$ F
100 nA	10 ms	200 pA to 145 nA	$\leq 100$ nF
	30 ms	100 pA to 145 nA	$\leq 1$ $\mu$ F
	100 ms	400 pA to 145 nA	$\leq 10$ $\mu$ F
	400 ms	400 pA to 145 nA	$\leq 10$ $\mu$ F
1 $\mu$ A	10 ms	2 nA to 1.45 $\mu$ A	$\leq 1$ $\mu$ F
	30 ms	1 nA to 1.45 $\mu$ A	$\leq 10$ $\mu$ F
	100 ms	4 nA to 1.45 nA	$\leq 100$ $\mu$ F
	400 ms	4 nA to 1.45 nA	$\leq 100$ $\mu$ F
10 $\mu$ A	10 ms	20 nA to 14.5 $\mu$ A	$\leq 10$ $\mu$ F
	30 ms	10 nA to 14.5 $\mu$ A	$\leq 100$ $\mu$ F
	100 ms	—	—
	400 ms	—	—
100 $\mu$ A	10 ms	120 nA to 100 $\mu$ A	$\leq 100$ $\mu$ F
	30 ms	—	—
	100 ms	—	—
	400 ms	—	—

**Current Measurement Range** shows the range where the 4349B's specified accuracy is applied. This range is applicable for a pure resistor (non-capacitive device) measurement.

**Measurable Capacitance Range** shows the capacitance range that can be measured in each of the 4349B's measurement ranges.

### Additional Error Due To the Voltage Source Noise

In the case of capacitor leakage current measurements, the DC voltage source noise affects on the measurement accuracy. The additional measurement error due to the DC voltage source noise depends on the DUT's capacitance  $C_x$  and resistance  $R_x$ . Figure 8-2 to Figure 8-5 show estimations of the additional error when using the DC voltage source that has the following specifications:

External DC Voltage Source Performance

- Ripple  $5 \mu\text{Vrms}(@50 \text{ Hz})$
- Wide band noise  $1 \mu\text{Vrms}/\sqrt{\text{Hz}}(@50 \text{ Hz})$
- Switching noise  $10 \text{ mVrms}(@100 \text{ Hz})$

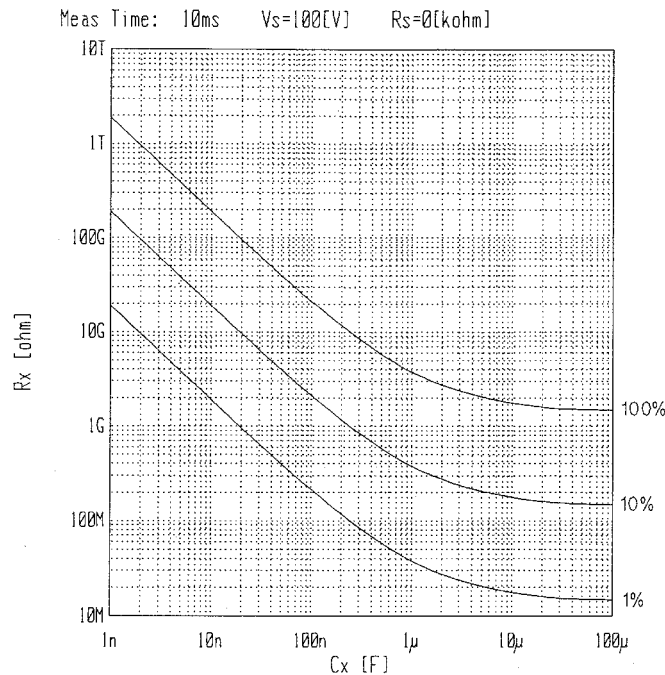

Figure 8-2. Current Measurement Additional Error (Measurement Time:10 msec)

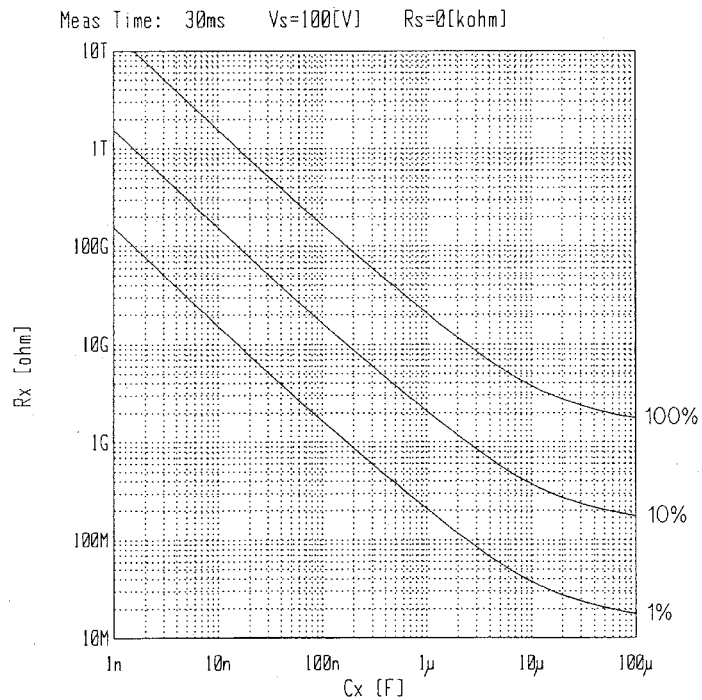

Figure 8-3. Current Measurement Additional Error (Measurement Time:30 msec)

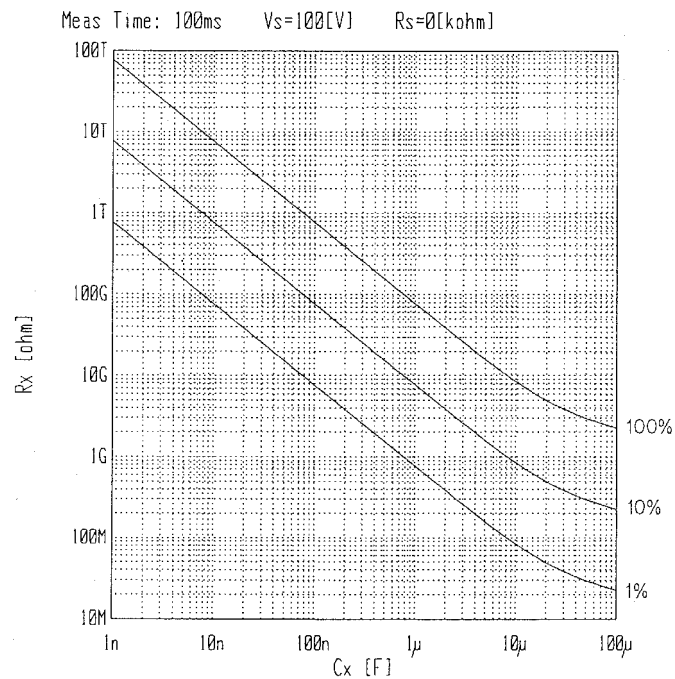

Figure 8-4. Current Measurement Additional Error (Measurement Time:100 msec)

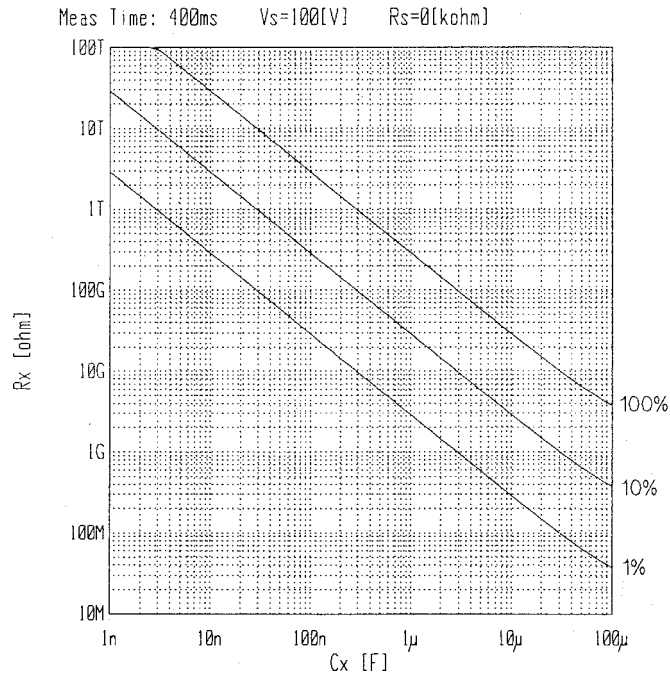

Figure 8-5. Current Measurement Additional Error (Measurement Time:400 msec)

## Additional Error Reduction by Connecting a Series Resistor

The additional error due to the DC voltage source noise can be reduced by connecting a series resistor. Figure 8-6 to Figure 8-9 show esminations of 10% additional error when the 0  $\Omega$  (no series resistor), 5 k $\Omega$ , 10 k $\Omega$ , 50 k $\Omega$ , and 100 k $\Omega$  series resistor is connected.

DC voltage source performance

Ripple	5 $\mu$ Vrms(@50 Hz)
Wide band noise	1 $\mu$ Vrms/ $\sqrt{\text{Hz}}$ (@50 Hz)
Switching noise	10 mVrms(@100 Hz)

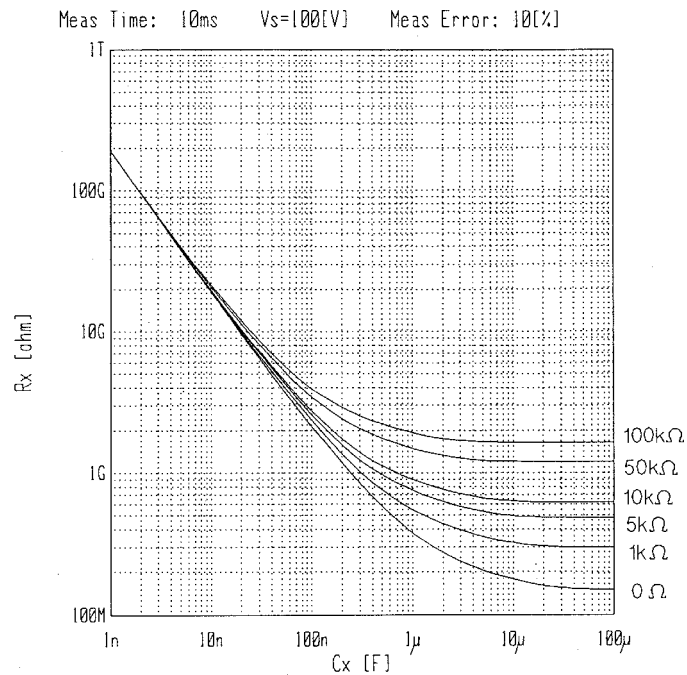

**Figure 8-6. 10 % Additional Error (Measurement Time: 10 msec)**

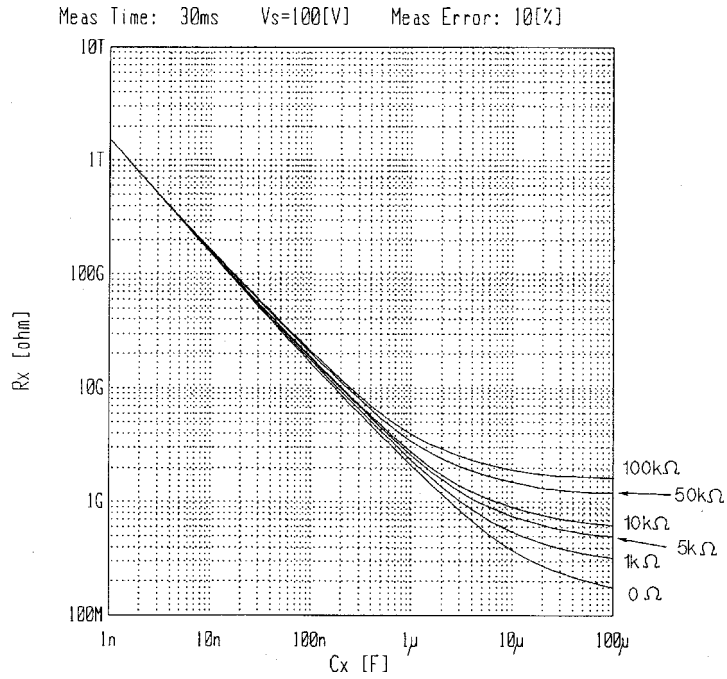

Figure 8-7. 10 % Additional Error (Measurement Time: 30 msec)

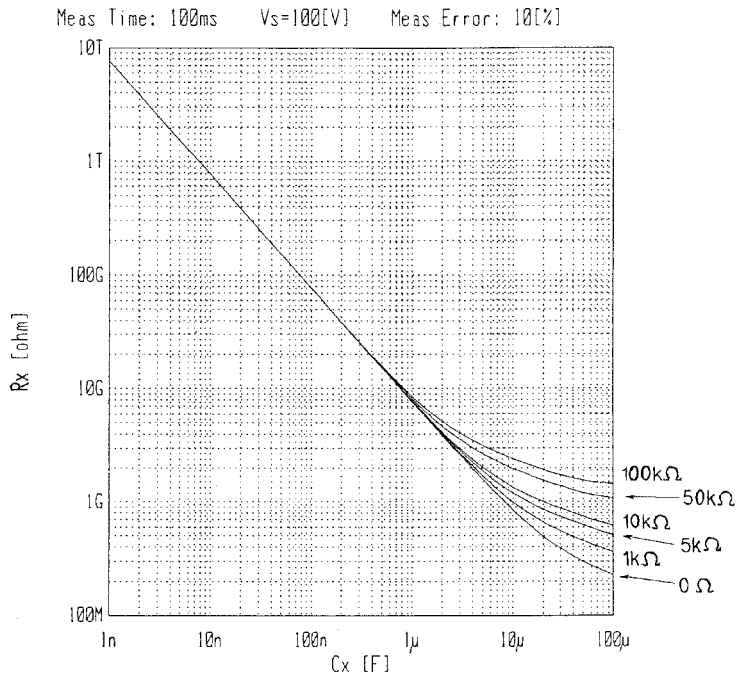
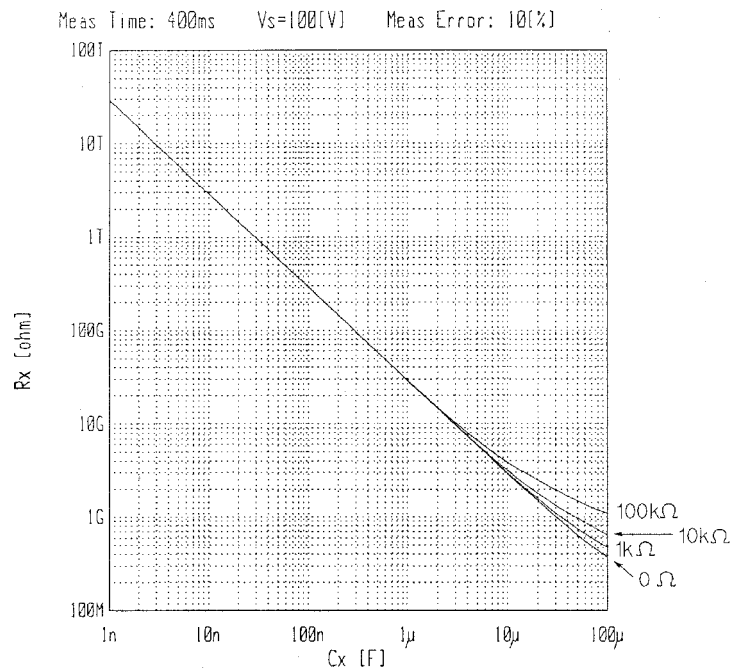

Figure 8-8. 10 % Additional Error (Measurement Time: 100 msec)



**Figure 8-9. 10 % Additional Error (Measurement Time: 400 msec)**



## 4349B

### Measurement Time

The total measurement time is (Actual measurement time + Display time + Data transfer time).

#### ■ Actual measurement time (Typical data)

Measurement time mode	Analog measurement (ms) <sup>1,2</sup>	Digital measurement(ms)	Total(ms) <sup>1,3</sup>
10 ms	7(9)	2.5	9.5(11.5)
30 ms	25.5(27.5)	2.5	28(30)
100 ms	95.5(97.5)	2.5	98(100)
400 ms	394.5(396.5)	2.5	397(399)

1 Numbers of parenthesis indicate the measurement times when the contact check is ON.

2 Analog measurement time indicates the time interval from a trigger command to INDEX signal output at the handler interface port (@ Hold range mode, Display OFF).

3 Total time indicates the time interval from a trigger to EOM signal output at the handler interface port (@ Hold range mode, Display OFF).

#### ■ Display time (Typical data)

Display mode	Display time
Measurement data Comparator results	5 ms (at 100 ms intervals)
Display OFF	0 s

#### ■ Data transfer time (Typical data)

Data transfer format	Resistance data	Current data
ASCII	13 ms	12.5 ms
Real	7.5 ms	7 ms

Data transfer format (When using Data Buffer)	Resistance data (50 data)	Current data (50 data)
ASCII	660 ms	650 ms
Real	320 ms	300 ms

\* Data transfer time depends on the controller type. Data transfer time shown above is typical data when using HP 9000 series 300, model 360.

### Consumption Memory Duration

72 hours (@ 23 ±5°C)

## Contact Check Effective Range

- Available DUT type: Capacitive DUT only
- Contact check effective range: The DUT's capacitance  $C_d$  must meet the following equation.

$$C_d \geq C_x + C_{res} \times 0.05$$

where,  $C_x$  is the capacitance value obtained by :SENSE:CORR:DATA{1|2|3|4}? SCAPacitance command when the test cable/test fixture is connected to the 4349B.

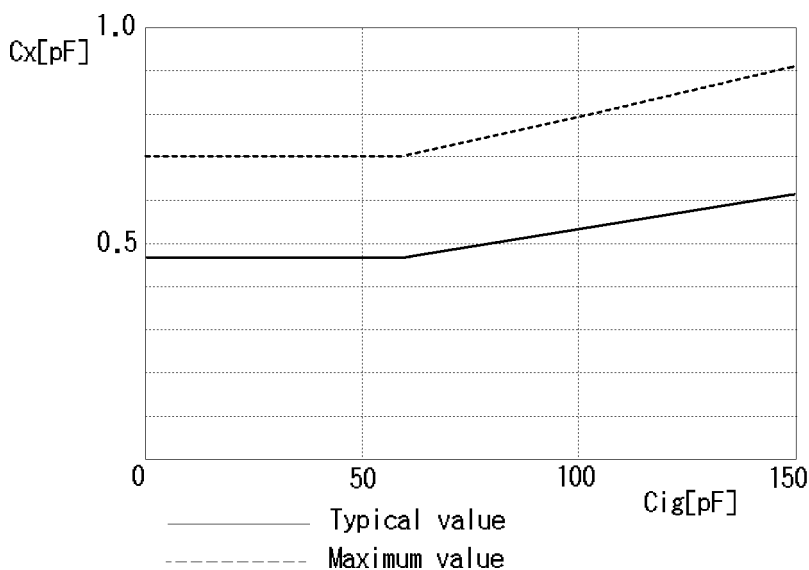

**Figure 8-10. Relation Between  $C_x$  and Cable Capacitance  $C_{ig}$**

The cable capacitance  $C_{ig}$  shows the capacitance between the center conductor and the inner shield of the triaxial cable. The 16117E's capacitance is about 40 pF/meter. The cable capacitance is in proportion to the cable length.

The following is the sample program to obtain  $C_{res}$  of each channel. It is necessary to perform the OPEN correction before reading  $C_{res}$ .

```
OUTPUT 717 ; "CORR:COLL:ACQ OFFS"    ! Perform OPEN correction
wait 5
OUTPUT 717 ; "CORR:DATA1? SCAP;DATA2? SCAP;DATA3? SCAP;DATA4? SCAP"
ENTER 717 ; Scap1,Scap2,Scap3,Scap4
```

## Maintenance

### Introduction

This chapter provides information on how to maintain the 4349B. The 4349B maintenance consists of performance tests and functional tests.

### Test Equipment

Table 9-1 lists the recommended equipment for performing 4349B maintenance. A DC voltmeter and a DC power supply are required to obtain the reference voltage. The voltage calibrators listed in Table 9-2 can be used as a substitute for them.

#### Note



The reference DC voltage is required to test the 4349B current measurement accuracy and resistance measurement accuracy. To obtain the reference voltage, the DC power supply requires the DC voltmeter which monitors the power supply output voltage, because the voltage accuracy of the power supply is not good enough for the performance tests. On the other hand the voltage calibrators require no DC voltmeter because of their much greater accuracy.

**Table 9-1. Required Equipment**

Equipment	Requirements	Recommended Model	Qty.	Use <sup>1</sup>
DC Voltmeter	Voltage Range: 1 V to 100 V Accuracy: <math>\pm 0.1\%</math>	3458A	1	P
DC Power Supply	Voltage Range: 1 V to 100 V	6634A	1	P
RC Box	No substitute	16340A	1	P
SMU Test Adapter	No substitute	PN 04145-65001	1	F
Adapter	Triaxial Tee	PN 1250-1551	1	P
Cable	Dual Banana-BNC(m) Cable	PN 11001-60001	1	P
	61 cm BNC(m)-BNC(m) Cable	PN 8120-1839	1	F
Handler Interface Tester	No Substitute	PN 04339-65007	1	F

<sup>1</sup> P: Performance Tests, F: Functional Tests

**Table 9-2. Substitute Equipment for Reference Voltage**

Model Number
3245A w/ Opt 002
DATRON 4000
DATRON 4000A
DATRON 4200
DATRON 4700
DATRON 4707
DATRON 4708
FRUKE 5700

---

## Performance Tests

### Introduction

This section provides the test procedures used to verify that the 4349B's specifications listed in Chapter 8, General Information, of this manual are met. All tests can be performed without access to the interior of the instrument. The performance tests can also be used to perform incoming inspection, and to verify that the 4349B meets its performance specifications after troubleshooting or adjustment. If the performance tests indicate that the 4349B is NOT operating within the specified limits, check your test setup, then proceed with troubleshooting if necessary.

---

**Note** Allow the 4349B to warm up for at least 30 minutes before you execute any of the performance tests.



---

**Note** Perform all performance tests in ambient conditions of  $23^{\circ}\text{C} \pm 5^{\circ}\text{C}$ ,  $\leq 70\%$  RH.



---

### Test Equipment

Table 9-1 lists the test equipment required to perform the tests described in this section. Use only calibrated test instruments when performance testing the 4349B. Equipment which equals or surpasses the key required specifications of the recommended equipment may be used as a substitute.

### Calculation Sheet

The calculation sheet is used as an aid for recording raw measurement data, and for calculating the performance test results.

The performance test procedure gives the test sequence for performing a test, the complete set of measurement data are recorded on the calculation sheet, the results are calculated using the equations given on the calculation sheet, and the results are transcribed to the performance test record.

The procedure for using the calculation sheet is:

1. Photo copy the calculation sheet.
2. Follow the performance test procedure and record the measurement value(s), the 4349B's reading, etc., into the specified column on the calculation sheet.
3. Calculate the test result using the appropriate equation given on the calculation sheet, and record the test result into the Test Result column of the performance test record.

### Performance Test Record

Record the performance test results in the test record at the end of this chapter (Photocopy the test record and use the photocopy). The test record lists all test specifications, their acceptable limits, and measurement uncertainties for the recommended test equipment. Test results recorded during incoming inspection can be used for comparison purposes during periodic maintenance, troubleshooting, and after repair or adjustment.

### Calibration Cycle

The 4349B requires periodic performance tests. The frequency of performance testing depends on the operating and environmental conditions under which the 4349B is used. Verify the 4349B's performance at least once a year, using the performance tests described in this section.

## 4349B

### Ammeter Offset Voltage and Input Resistance Test

The 4349B's ammeter offset voltage and input resistance are measured.

#### Specifications

Ammeter Offset Voltage:  $\leq 2.5$  mV

Ammeter Input Resistance:  $1\text{ k}\Omega \pm 5\%$





#### Test Equipment

Description	Recommended Model
Multimeter	3458A
System DC Power Supply	6634A <sup>1</sup>
RC Box	16340A
Triaxial Tee Adapter	PN 1250-1551
Dual Banana-BNC(m) Cable	PN 11001-60001

<sup>1</sup> The DC voltage calibrator listed in Table 9-2 can be used as a substitute.

#### Procedure

##### Ammeter Offset Voltage Test.

1. Reset the 4349B using the following procedure.
  - a. Press   to display the system reset menu.
  - b. Select Yes using  or  and press .
2. Set up the equipment as shown in Figure 9-1.

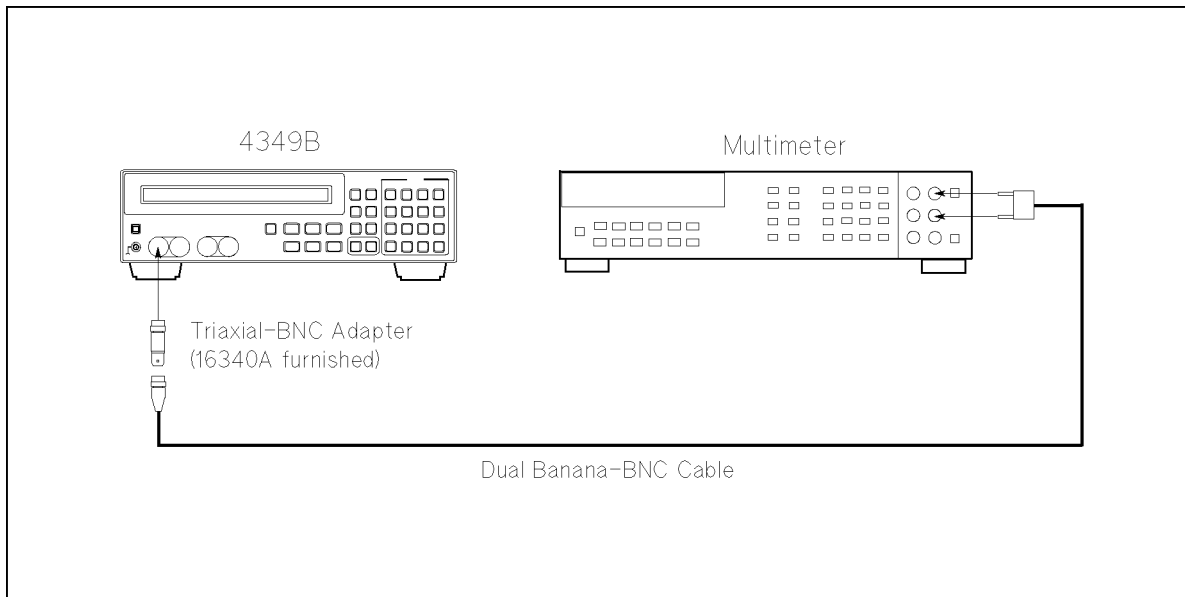

Figure 9-1. Ammeter Offset Voltage Test Setup

3. Press the 3458A Multimeter's **DCV** to set the measurement mode to DC voltage.
4. Press **Meas Time** three times to set the measurement time to 10 ms. The measurement time setting is indicated by the **Meas Time** annunciator(▼).
5. Press **Delay Trig Mode** to set the trigger mode to Manual. Trigger mode is indicated by the **Trigger** annunciator(▼).
6. Set the measurement range to 100  $\mu\text{A}$  using the following procedure.
  - a. Press **Range Setup** to display the measurement range setup menu.
  - b. Select 100  $\mu\text{A}$  using **↓** or **↑** and press **Enter**.
7. Record the multimeter reading into the performance test record.
8. Press **Ch** to select channel 2.
9. Connect the multimeter input to the 4349B's channel 2 input instead of the channel 1 input.
10. Test channel 2 using the steps 6 to 7.
11. Test channel 3 and channel 4 using the same procedure. If the 4349B is equipped with Option 001 (Two Test Channels), skip this step.

#### Ammeter Input Resistance Test.

12. Record the 16340A RC Box's  $10^4 \Omega$  calibration value and the ammeter offset voltage test result on the calculation sheet.
13. Set up the equipment as shown in Figure 9-2. If the DC Voltage Calibrator listed in Table 9-2 is available, setup the equipment as shown in Figure 9-3.

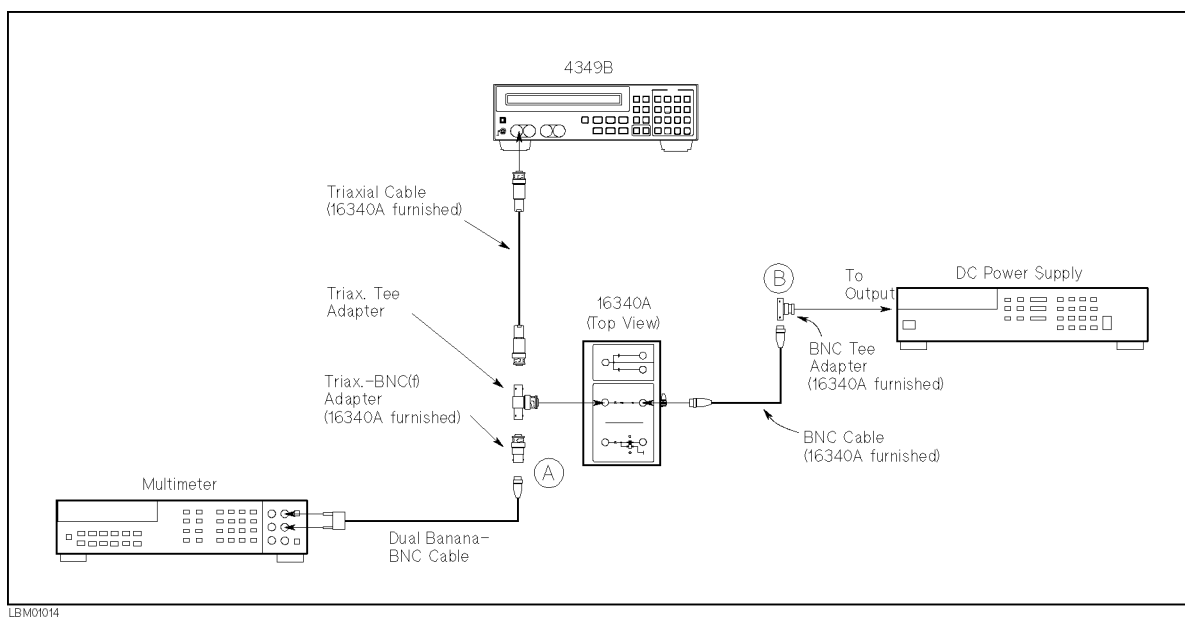
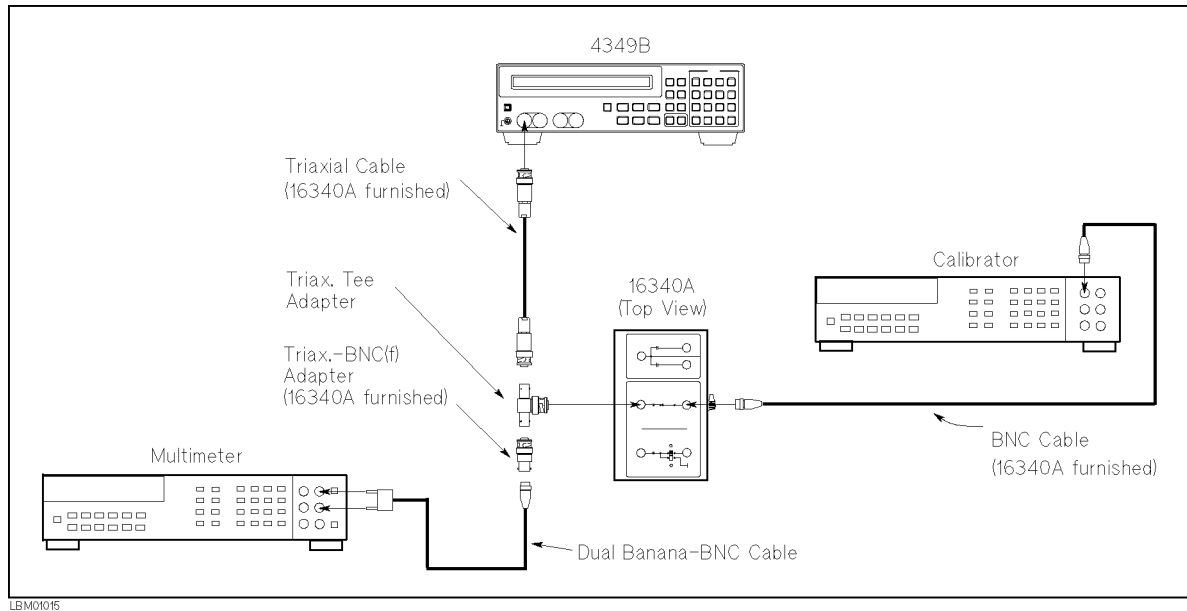

Figure 9-2. Ammeter Input Resistance Test Setup Using DC Power Supply



**Figure 9-3. Ammeter Input Resistance Test Setup Using DC Voltage Calibrator**

14. Set the RC Box resistor to  $10^4 \Omega$ .
15. Set the DC power supply (voltage calibrator) to 1 V.
16. Record the multimeter reading on the calculation sheet on the L Voltage line.
17. Disconnect the Dual Banana-BNC(m) cable from Ⓐ of Figure 9-2, and connect it to Ⓑ. If the voltage calibrator is used, skip this step.
18. Record the multimeter reading (voltage calibrator setting) on the calculation sheet on the H Voltage line.
19. Calculate the test result according to the calculation sheet, and record the result into the performance test record.
20. Remove the triaxial cable from the 4349B's channel 1 input and connect it to channel 2 input.
21. Test channel 2 using the steps 13 to 19.
22. Test channel 3 and channel 4 using the same procedure. If the 4349B is equipped with Option 001 (Two Test Channels), skip this step.

## Current Measurement Accuracy Test

The 4349B measures the current through the calibrated RC Box, and its readings are compared with the current values calculated from the RC Box's calibrated value and the voltage across the RC Box.

### Specification











Basic Measurement Accuracy:  $\pm 2\%$  (See Chapter 8 General Information for details.)

### Test Equipment

Description	Recommended Model
Multimeter	3458A <sup>1</sup>
System DC Power Supply	6634A <sup>1</sup>
RC Box	16340A
Dual Banana-BNC(m) Cable	PN 11001-60001

<sup>1</sup> The DC voltage calibrator listed in Table 9-2 can be used as a substitute.

### Procedure

- Record the 16340A RC Box calibration values into the calculation sheet.
- Reset the 4349B using the following procedure.
  - Press   to display the system reset menu.
  - Select Yes using  or  and press .
- Set the measurement parameter to current (I).
  - Press .
  - Select I using  or  and press .
- Press  to set the trigger mode to Manual. The trigger mode is indicated by the **Trigger** annunciator(▼).
- Set up the equipment as shown in Figure 9-4.

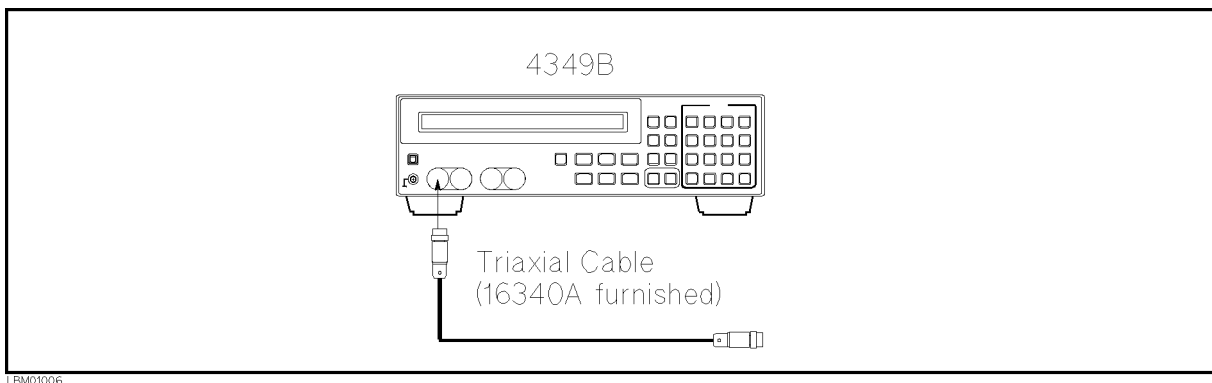

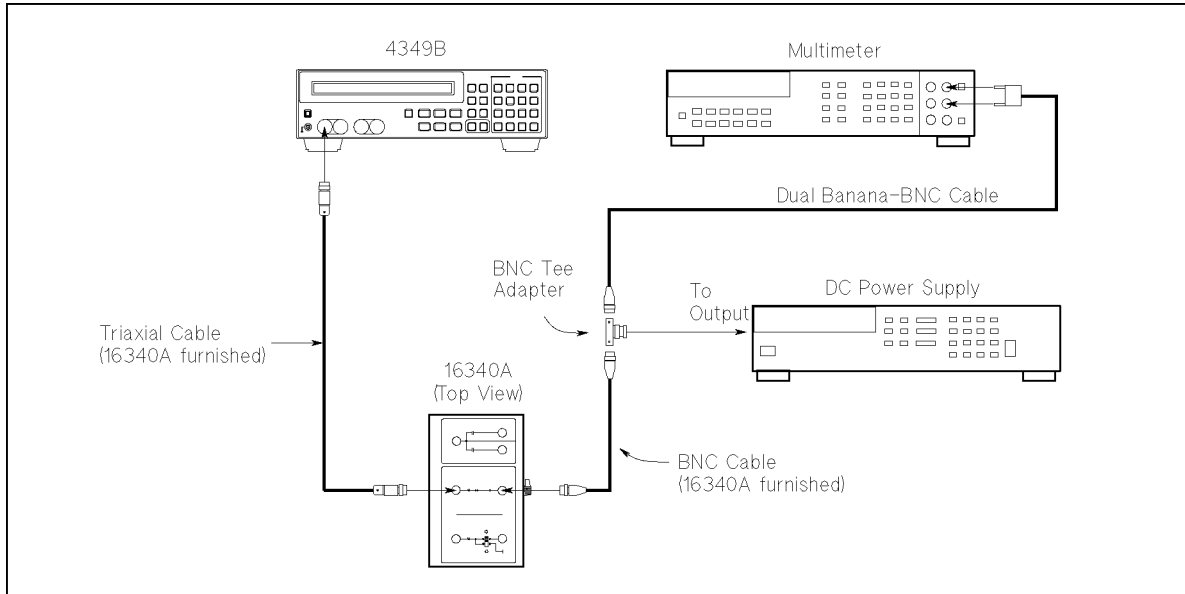

Figure 9-4. Current Measurement Accuracy Test Setup



## 4349B

- Press   to perform the OPEN correction.
- Set up the equipment as shown in Figure 9-5. If the DC Voltage Calibrator listed in Table 9-2 is available, setup the equipment as shown in Figure 9-6.



**Figure 9-5. Current Measurement Accuracy Test Setup Using DC Power Supply**

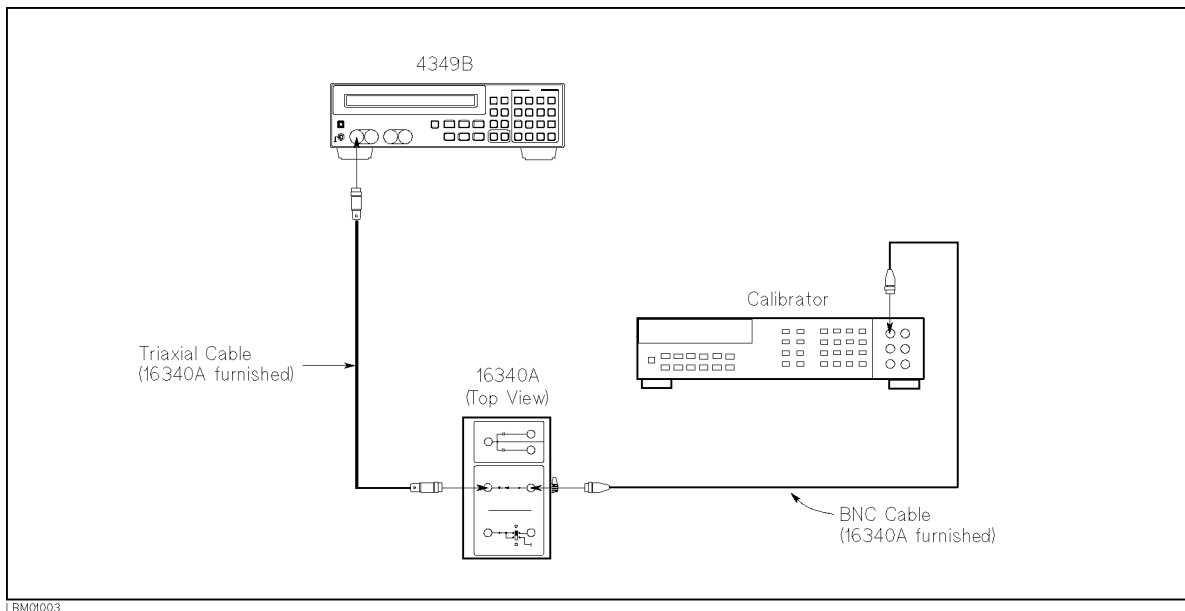

**Figure 9-6. Current Measurement Accuracy Test Setup Using DC Voltage Calibrator**

8. Press the 3458A Multimeter's **DCV** to set the measurement mode to DC voltage. If the voltage calibrator is used, skip this step.
9. Set the RC Box resistor to  $10^{10} \Omega$ .
10. Set the DC power supply (voltage calibrator) to 1 V.
11. Press **Trig** to start measurement.
12. Record the multimeter reading (voltage calibrator setting) on the calculation sheet on the Multimeter Reading line.
13. Record the 4349B reading on the calculation sheet on the 4349B Reading line.
14. Set the DC power supply (voltage calibrator) to 0 V.
15. Calculate the test result according to the calculation sheet, and record the result into the performance test record.
16. Perform this test for all settings listed in Table 9-3. The DC power supply (voltage calibrator) must be set to 0 V after each test. The measurement time is changed by using **Meas Time**. The measurement time setting is indicated by the **Meas Time** annunciator( $\blacktriangledown$ ).

**Table 9-3. Current Measurement Accuracy Test Settings**

Test Current	Resistor Setting	Voltage Setting	Measurement Time
100 pA	$10^{10} \Omega$	1 V	30 ms
100 pA	$10^{10} \Omega$	1 V	100 ms
100 pA	$10^{10} \Omega$	1 V	400 ms
1 nA	$10^9 \Omega$	1 V	400 ms
1 nA	$10^9 \Omega$	1 V	30 ms
10 nA	$10^8 \Omega$	1 V	30 ms
100 nA	$10^7 \Omega$	1 V	30 ms
1 $\mu$ A	$10^6 \Omega$	1 V	30 ms
10 $\mu$ A	$10^5 \Omega$	1 V	30 ms
100 $\mu$ A	$10^5 \Omega$	10 V	10 ms

17. Press **Ch** to select channel 2.
18. Test channel 2 using the steps 5 to 16.
19. Test channel 3 and channel 4 using the same procedure. If the 4349B is equipped with Option 001 (Two Test Channels), skip this step.

## 4349B

### Resistance Measurement Accuracy Test

The 4349B measures calibrated RC Box with an external DC voltage source, and its readings are compared with the RC Box's calibration values.

#### Specification







Basic Measurement Accuracy:  $\pm 2 \%$  (See Chapter 8 General Information for details.)

#### Test Equipment

Description	Recommended Model
Multimeter	3458A <sup>1</sup>
System DC Power Supply	6634A <sup>1</sup>
RC Box	16340A
Dual Banana-BNC(m) Cable	PN 11001-60001

<sup>1</sup> The DC voltage calibrator listed in Table 9-2 can be used as a substitute.

#### Procedure

1. Record the 16340A RC Box calibration values into the calculation sheet.
2. Reset the 4349B using the following procedure.
  - a. Press   to display the system reset settings.
  - b. Select Yes using  or  and press .
3. Press  three times to set the measurement time to 10 ms. The measurement time setting is indicated by the **Meas Time** annunciator(▼).
4. Press  to set the trigger mode to Manual. The trigger mode is indicated by the **Trigger** annunciator(▼).
5. Set up the equipment as shown in Figure 9-7.

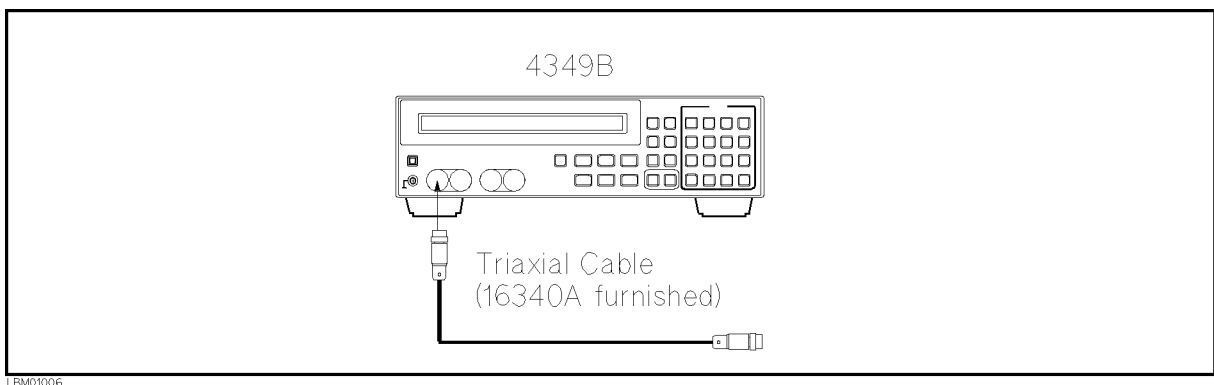

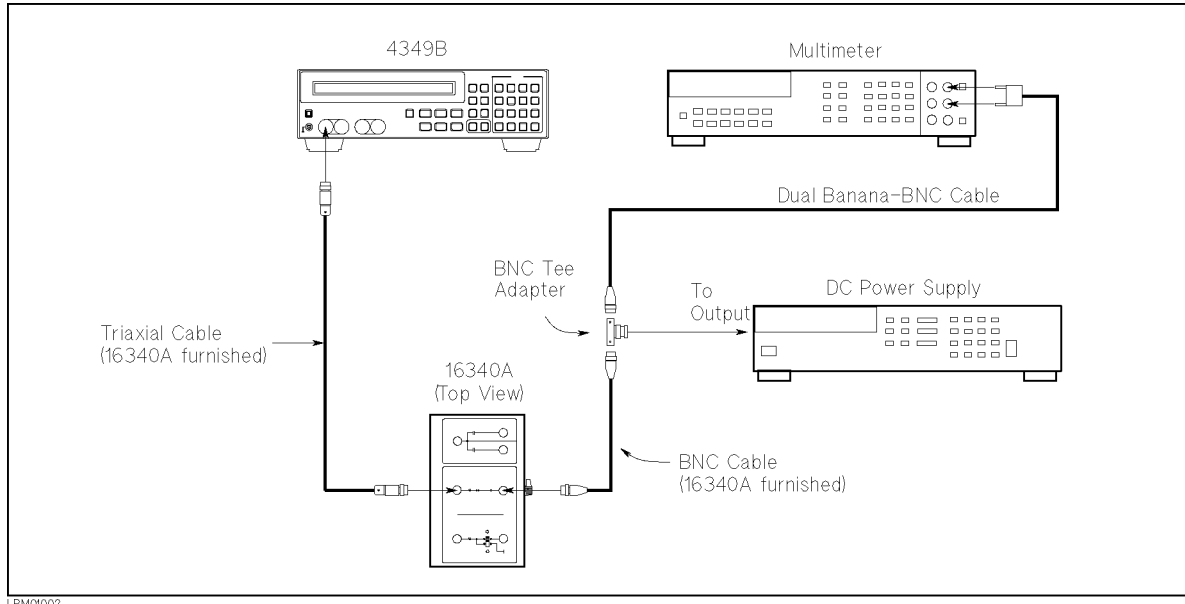
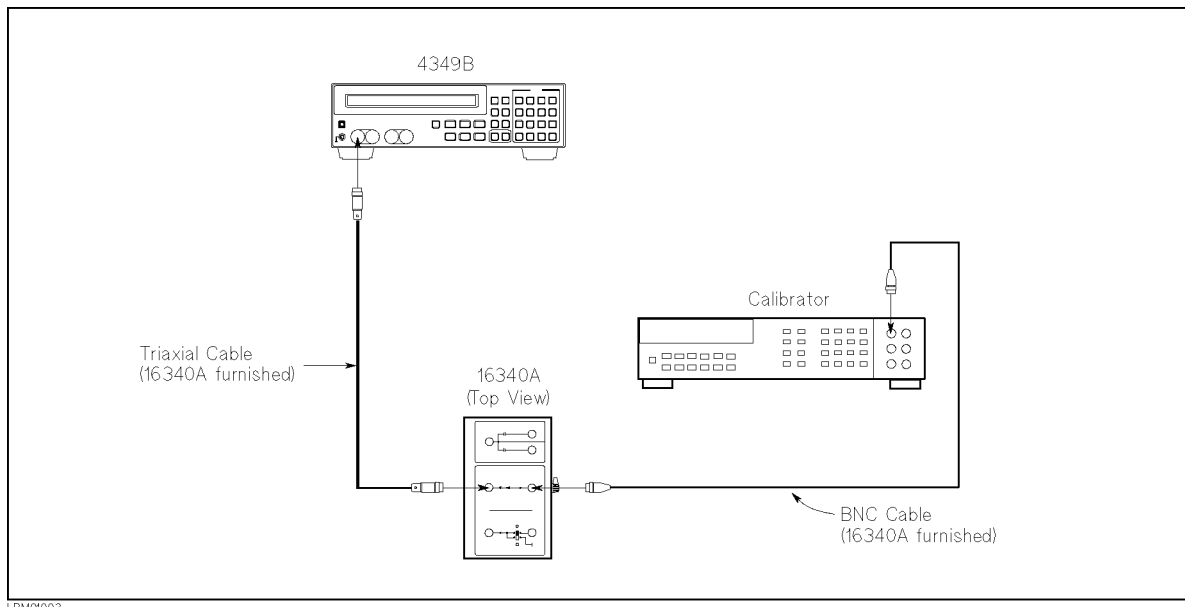

Figure 9-7. Resistance Measurement Accuracy Test Setup

6. Press   to perform the OPEN correction.
7. Set up the equipment as shown in Figure 9-8. If the DC Voltage Calibrator listed in Table 9-2 is available, setup the equipment as shown in Figure 9-9.



**Figure 9-8. Resistance Measurement Accuracy Test Setup Using DC Power Supply**



**Figure 9-9. Resistance Measurement Accuracy Test Setup Using DC Voltage Calibrator**

## 4349B

8. Press the 3458A Multimeter's **DCV** to set the measurement mode to DC voltage. If the voltage calibrator is used, skip this step.
9. Set the RC Box resistor to  $10^6 \Omega$ .
10. Set the DC power supply (Voltage Calibrator) to 100 V.
11. Enter the multimeter reading (voltage calibrator setting) into the 4349B using the following procedure.
  - a. Press **Voltage Entry** to display the voltage setting menu.
  - b. Enter the desired voltage using the numeric keys, and press **Enter**.
  - c. Confirm that the desired voltage is displayed.
12. Press **Trig** to start measurement.
13. Record the 4349B reading on the calculation sheet.
14. Set the DC power supply (voltage calibrator) to 0 V.
15. Calculate the test result according to the calculation sheet, and record the result into the performance test record.
16. Perform this test for all settings listed in Table 9-4. The DC power supply (voltage calibrator) must be set to 0 V after each test. In the test for  $10^{11}$  resistor, connect the triaxial cable and BNC cable to the  $10^{11}$  terminals and set the  $10^{11}$  switch to the BNC connector position.

**Table 9-4. Resistance Measurement Accuracy Test Settings**

<b>Resistor Setting</b>	<b>Voltage Setting</b>	<b>Measurement Time</b>
$10^6$	100 V	10 ms
$10^7$	100 V	30 ms
$10^8$	100 V	30 ms
$10^8$	100 V	400 ms
$10^9$	100 V	30 ms
$10^{10}$	100 V	30 ms
$10^{11}$	100 V	30 ms
$10^{11}$	100 V	10 ms
$10^{11}$	10 V	30 ms

17. Press **Ch** to select channel 2.
18. Test channel 2 using the steps 4 to 16.
19. Test channel 3 and channel 4 using the same procedure. If the 4349B is equipped with Option 001 (Two Test Channels), skip this step.

## Calculation Sheet

### Ammeter Input Resistance Test (Channel 1)

$10^4 \Omega$ Calibration Value [a]	Offset Voltage [b]	L Voltage [c]	H Voltage [d]	Test Result Equation
_____ $\times 10^4 \Omega$	_____ mV	_____ mV	_____ mV	$1 \text{ k}\Omega - a \times (c-b) \div (d-c)$

### Ammeter Input Resistance Test (Channel 2)

$10^4 \Omega$ Calibration Value [a]	Offset Voltage [b]	L Voltage [c]	H Voltage [d]	Test Result Equation
_____ $\times 10^4 \Omega$	_____ mV	_____ mV	_____ mV	$1 \text{ k}\Omega - a \times (c-b) \div (d-c)$

### Ammeter Input Resistance Test (Channel 3)

$10^4 \Omega$ Calibration Value [a]	Offset Voltage [b]	L Voltage [c]	H Voltage [d]	Test Result Equation
_____ $\times 10^4 \Omega$	_____ mV	_____ mV	_____ mV	$1 \text{ k}\Omega - a \times (c-b) \div (d-c)$

### Ammeter Input Resistance Test (Channel 4)

$10^4 \Omega$ Calibration Value [a]	Offset Voltage [b]	L Voltage [c]	H Voltage [d]	Test Result Equation
_____ $\times 10^4 \Omega$	_____ mV	_____ mV	_____ mV	$1 \text{ k}\Omega - a \times (c-b) \div (d-c)$

### RC Box Calibration Values

This table is used in the Current Measurement Accuracy Test and the Resistance Measurement Accuracy Test.

Resistor Setting	Resistor Calibration Value	Reference Designation
$10^{11} \Omega$	_____ $\times 10^{11} \Omega$	cv1
$10^{10} \Omega$	_____ $\times 10^{10} \Omega$	cv2
$10^9 \Omega$	_____ $\times 10^9 \Omega$	cv3
$10^8 \Omega$	_____ $\times 10^8 \Omega$	cv4
$10^7 \Omega$	_____ $\times 10^7 \Omega$	cv5
$10^6 \Omega$	_____ $\times 10^6 \Omega$	cv6
$10^5 \Omega$	_____ $\times 10^5 \Omega$	cv7

**4349B**

**Current Measurement Accuracy Test (Channel 1)**

Test Current	Resistor Setting	Voltage Setting	Measurement Time	Multimeter Reading [a]	4349B Reading [b]	Test Result Equation <sup>1</sup>
100 pA	10 <sup>10</sup> Ω	1 V	30 ms	_____ V	_____ pA	b - a ÷ cv2
100 pA	10 <sup>10</sup> Ω	1 V	100 ms	_____ V	_____ pA	b - a ÷ cv2
100 pA	10 <sup>10</sup> Ω	1 V	400 ms	_____ V	_____ pA	b - a ÷ cv2
1 nA	10 <sup>9</sup> Ω	1 V	400 ms	_____ V	_____ nA	b - a ÷ cv3
1 nA	10 <sup>9</sup> Ω	1 V	30 ms	_____ V	_____ nA	b - a ÷ cv3
10 nA	10 <sup>8</sup> Ω	1 V	30 ms	_____ V	_____ nA	b - a ÷ cv4
100 nA	10 <sup>7</sup> Ω	1 V	30 ms	_____ V	_____ nA	b - a ÷ cv5
1 μA	10 <sup>6</sup> Ω	1 V	30 ms	_____ V	_____ μA	b - a ÷ cv6
10 μA	10 <sup>5</sup> Ω	1 V	30 ms	_____ V	_____ μA	b - a ÷ (cv7+1 kΩ)
100 μA	10 <sup>5</sup> Ω	10 V	10 ms	_____ V	_____ μA	b - a ÷ (cv7+1 kΩ)

1 1 kΩ is the input impedance of the 4349B's ammeter.

**Current Measurement Accuracy Test (Channel 2)**

Test Current	Resistor Setting	Voltage Setting	Measurement Time	Multimeter Reading [a]	4349B Reading [b]	Test Result Equation <sup>1</sup>
100 pA	10 <sup>10</sup> Ω	1 V	30 ms	_____ V	_____ pA	b - a ÷ cv2
100 pA	10 <sup>10</sup> Ω	1 V	100 ms	_____ V	_____ pA	b - a ÷ cv2
100 pA	10 <sup>10</sup> Ω	1 V	400 ms	_____ V	_____ pA	b - a ÷ cv2
1 nA	10 <sup>9</sup> Ω	1 V	400 ms	_____ V	_____ nA	b - a ÷ cv3
1 nA	10 <sup>9</sup> Ω	1 V	30 ms	_____ V	_____ nA	b - a ÷ cv3
10 nA	10 <sup>8</sup> Ω	1 V	30 ms	_____ V	_____ nA	b - a ÷ cv4
100 nA	10 <sup>7</sup> Ω	1 V	30 ms	_____ V	_____ nA	b - a ÷ cv5
1 μA	10 <sup>6</sup> Ω	1 V	30 ms	_____ V	_____ μA	b - a ÷ cv6
10 μA	10 <sup>5</sup> Ω	1 V	30 ms	_____ V	_____ μA	b - a ÷ (cv7+1 kΩ)
100 μA	10 <sup>5</sup> Ω	10 V	10 ms	_____ V	_____ μA	b - a ÷ (cv7+1 kΩ)

1 1 kΩ is the input impedance of the 4349B's ammeter.

### Current Measurement Accuracy Test (Channel 3)

Test Current	Resistor Setting	Voltage Setting	Measurement Time	Multimeter Reading [a]	4349B Reading [b]	Test Result Equation <sup>1</sup>
100 pA	10 <sup>10</sup> Ω	1 V	30 ms	_____ V	_____ pA	$b - a \div cv2$
100 pA	10 <sup>10</sup> Ω	1 V	100 ms	_____ V	_____ pA	$b - a \div cv2$
100 pA	10 <sup>10</sup> Ω	1 V	400 ms	_____ V	_____ pA	$b - a \div cv2$
1 nA	10 <sup>9</sup> Ω	1 V	400 ms	_____ V	_____ nA	$b - a \div cv3$
1 nA	10 <sup>9</sup> Ω	1 V	30 ms	_____ V	_____ nA	$b - a \div cv3$
10 nA	10 <sup>8</sup> Ω	1 V	30 ms	_____ V	_____ nA	$b - a \div cv4$
100 nA	10 <sup>7</sup> Ω	1 V	30 ms	_____ V	_____ nA	$b - a \div cv5$
1 μA	10 <sup>6</sup> Ω	1 V	30 ms	_____ V	_____ μA	$b - a \div cv6$
10 μA	10 <sup>5</sup> Ω	1 V	30 ms	_____ V	_____ μA	$b - a \div (cv7+1 \text{ k}\Omega)$
100 μA	10 <sup>5</sup> Ω	10 V	10 ms	_____ V	_____ μA	$b - a \div (cv7+1 \text{ k}\Omega)$

<sup>1</sup> 1 kΩ is the input impedance of the 4349B's ammeter.

### Current Measurement Accuracy Test (Channel 4)

Test Current	Resistor Setting	Voltage Setting	Measurement Time	Multimeter Reading [a]	4349B Reading [b]	Test Result Equation <sup>1</sup>
100 pA	10 <sup>10</sup> Ω	1 V	30 ms	_____ V	_____ pA	$b - a \div cv2$
100 pA	10 <sup>10</sup> Ω	1 V	100 ms	_____ V	_____ pA	$b - a \div cv2$
100 pA	10 <sup>10</sup> Ω	1 V	400 ms	_____ V	_____ pA	$b - a \div cv2$
1 nA	10 <sup>9</sup> Ω	1 V	400 ms	_____ V	_____ nA	$b - a \div cv3$
1 nA	10 <sup>9</sup> Ω	1 V	30 ms	_____ V	_____ nA	$b - a \div cv3$
10 nA	10 <sup>8</sup> Ω	1 V	30 ms	_____ V	_____ nA	$b - a \div cv4$
100 nA	10 <sup>7</sup> Ω	1 V	30 ms	_____ V	_____ nA	$b - a \div cv5$
1 μA	10 <sup>6</sup> Ω	1 V	30 ms	_____ V	_____ μA	$b - a \div cv6$
10 μA	10 <sup>5</sup> Ω	1 V	30 ms	_____ V	_____ μA	$b - a \div (cv7+1 \text{ k}\Omega)$
100 μA	10 <sup>5</sup> Ω	10 V	10 ms	_____ V	_____ μA	$b - a \div (cv7+1 \text{ k}\Omega)$

<sup>1</sup> 1 kΩ is the input impedance of the 4349B's ammeter.



**4349B****Resistance Measurement Accuracy Test (Channel 1)**

<b>Resistor Setting</b>	<b>Voltage Setting</b>	<b>Measurement Time</b>	<b>4349B Reading [a]</b>	<b>Test Result Equation</b>
$10^6 \Omega$	100 V	10 ms	_____ $10^6 \Omega$	a – cv6
$10^7 \Omega$	100 V	30 ms	_____ $10^7 \Omega$	a – cv5
$10^8 \Omega$	100 V	30 ms	_____ $10^8 \Omega$	a – cv4
$10^8 \Omega$	100 V	400 ms	_____ $10^8 \Omega$	a – cv4
$10^9 \Omega$	100 V	30 ms	_____ $10^9 \Omega$	a – cv3
$10^{10} \Omega$	100 V	30 ms	_____ $10^{10} \Omega$	a – cv2
$10^{11} \Omega$	100 V	30 ms	_____ $10^{11} \Omega$	a – cv1
$10^{11} \Omega$	100 V	10 ms	_____ $10^{11} \Omega$	a – cv1
$10^{11} \Omega$	10 V	30 ms	_____ $10^{11} \Omega$	a – cv1

**Resistance Measurement Accuracy Test (Channel 2)**

<b>Resistor Setting</b>	<b>Voltage Setting</b>	<b>Measurement Time</b>	<b>4349B Reading [a]</b>	<b>Test Result Equation</b>
$10^6 \Omega$	100 V	10 ms	_____ $10^6 \Omega$	a – cv6
$10^7 \Omega$	100 V	30 ms	_____ $10^7 \Omega$	a – cv5
$10^8 \Omega$	100 V	30 ms	_____ $10^8 \Omega$	a – cv4
$10^8 \Omega$	100 V	400 ms	_____ $10^8 \Omega$	a – cv4
$10^9 \Omega$	100 V	30 ms	_____ $10^9 \Omega$	a – cv3
$10^{10} \Omega$	100 V	30 ms	_____ $10^{10} \Omega$	a – cv2
$10^{11} \Omega$	100 V	30 ms	_____ $10^{11} \Omega$	a – cv1
$10^{11} \Omega$	100 V	10 ms	_____ $10^{11} \Omega$	a – cv1
$10^{11} \Omega$	10 V	30 ms	_____ $10^{11} \Omega$	a – cv1

**Resistance Measurement Accuracy Test (Channel 3)**

Resistor Setting	Voltage Setting	Measurement Time	4349B Reading [a]	Test Result Equation
$10^6 \Omega$	100 V	10 ms	_____ $10^6 \Omega$	a – cv6
$10^7 \Omega$	100 V	30 ms	_____ $10^7 \Omega$	a – cv5
$10^8 \Omega$	100 V	30 ms	_____ $10^8 \Omega$	a – cv4
$10^8 \Omega$	100 V	400 ms	_____ $10^8 \Omega$	a – cv4
$10^9 \Omega$	100 V	30 ms	_____ $10^9 \Omega$	a – cv3
$10^{10} \Omega$	100 V	30 ms	_____ $10^{10} \Omega$	a – cv2
$10^{11} \Omega$	100 V	30 ms	_____ $10^{11} \Omega$	a – cv1
$10^{11} \Omega$	100 V	10 ms	_____ $10^{11} \Omega$	a – cv1
$10^{11} \Omega$	10 V	30 ms	_____ $10^{11} \Omega$	a – cv1

**Resistance Measurement Accuracy Test (Channel 4)**

Resistor Setting	Voltage Setting	Measurement Time	4349B Reading [a]	Test Result Equation
$10^6 \Omega$	100 V	10 ms	_____ $10^6 \Omega$	a – cv6
$10^7 \Omega$	100 V	30 ms	_____ $10^7 \Omega$	a – cv5
$10^8 \Omega$	100 V	30 ms	_____ $10^8 \Omega$	a – cv4
$10^8 \Omega$	100 V	400 ms	_____ $10^8 \Omega$	a – cv4
$10^9 \Omega$	100 V	30 ms	_____ $10^9 \Omega$	a – cv3
$10^{10} \Omega$	100 V	30 ms	_____ $10^{10} \Omega$	a – cv2
$10^{11} \Omega$	100 V	30 ms	_____ $10^{11} \Omega$	a – cv1
$10^{11} \Omega$	100 V	10 ms	_____ $10^{11} \Omega$	a – cv1
$10^{11} \Omega$	10 V	30 ms	_____ $10^{11} \Omega$	a – cv1

**4349B**

**Performance Test Record**

4349B High Resistance Meter

Serial No.: \_\_\_\_\_

Date: \_\_\_\_\_

Temperature: \_\_\_\_\_

Tested by: \_\_\_\_\_

Humidity: \_\_\_\_\_

**Ammeter Offset Voltage and Input Resistance Test (Channel 1)****Ammeter Offset Voltage Test**

Test Limits	Test Result	Measurement Uncertainty
$\pm 2.5$ mV	_____ mV	$\pm 0.0015$ mV

**Ammeter Input Resistance Test**

Test Limits	Test Result <sup>1</sup>	Measurement Uncertainty
$\pm 50$ $\Omega$	_____ $\Omega$	$\pm 0.52$ $\Omega$

<sup>1</sup> Test Result = Typical Value of 1 k $\Omega$  – Measured Value

**Current Measurement Accuracy Test (Channel 1)**

Test Current	Test Limits	Measurement Time	Test Result <sup>1</sup>	Measurement Uncertainty
100 pA	$\pm 3.57$ pA	30 ms	_____ pA	$\pm 0.56$ pA
100 pA	$\pm 3.97$ pA	100 ms	_____ pA	$\pm 0.56$ pA
100 pA	$\pm 3.97$ pA	400 ms	_____ pA	$\pm 0.56$ pA
1 nA	$\pm 0.0307$ nA	400 ms	_____ nA	$\pm 0.0016$ nA
1 nA	$\pm 0.0277$ nA	30 ms	_____ nA	$\pm 0.0016$ nA
10 nA	$\pm 0.211$ nA	30 ms	_____ nA	$\pm 0.011$ nA
100 nA	$\pm 2.10$ nA	30 ms	_____ nA	$\pm 0.10$ nA
1 $\mu$ A	$\pm 0.0210$ $\mu$ A	30 ms	_____ $\mu$ A	$\pm 0.0011$ $\mu$ A
10 $\mu$ A	$\pm 0.210$ $\mu$ A	30 ms	_____ $\mu$ A	$\pm 0.007$ $\mu$ A
100 $\mu$ A	$\pm 2.12$ $\mu$ A	10 ms	_____ $\mu$ A	$\pm 0.07$ $\mu$ A

<sup>1</sup> Test Result = 4349B Reading – (Multimeter Reading  $\div$  Resistor Calibration Value)

**Resistance Measurement Accuracy Test (Channel 1)**

Resistor Setting	Voltage Setting	Measurement Time	Test Limits	Test Result <sup>1</sup>	Measurement Uncertainty
$10^6$ $\Omega$	100 V	10 ms	$\pm 0.0212 \times 10^6$ $\Omega$	_____ $\times 10^6$ $\Omega$	$\pm 0.0005 \times 10^6$ $\Omega$
$10^7$ $\Omega$	100 V	30 ms	$\pm 0.0210 \times 10^7$ $\Omega$	_____ $\times 10^7$ $\Omega$	$\pm 0.0011 \times 10^7$ $\Omega$
$10^8$ $\Omega$	100 V	30 ms	$\pm 0.0210 \times 10^8$ $\Omega$	_____ $\times 10^8$ $\Omega$	$\pm 0.0011 \times 10^8$ $\Omega$
$10^8$ $\Omega$	100 V	400 ms	$\pm 0.0240 \times 10^8$ $\Omega$	_____ $\times 10^8$ $\Omega$	$\pm 0.0011 \times 10^8$ $\Omega$
$10^9$ $\Omega$	100 V	30 ms	$\pm 0.0210 \times 10^9$ $\Omega$	_____ $\times 10^9$ $\Omega$	$\pm 0.0016 \times 10^9$ $\Omega$
$10^{10}$ $\Omega$	100 V	30 ms	$\pm 0.0271 \times 10^{10}$ $\Omega$	_____ $\times 10^{10}$ $\Omega$	$\pm 0.0056 \times 10^{10}$ $\Omega$
$10^{11}$ $\Omega$	100 V	30 ms	$\pm 0.0460 \times 10^{11}$ $\Omega$	_____ $\times 10^{11}$ $\Omega$	$\pm 0.011 \times 10^{11}$ $\Omega$
$10^{11}$ $\Omega$	100 V	10 ms	$\pm 0.0540 \times 10^{11}$ $\Omega$	_____ $\times 10^{11}$ $\Omega$	$\pm 0.011 \times 10^{11}$ $\Omega$
$10^{11}$ $\Omega$	10 V	30 ms	$\pm 0.0543 \times 10^{11}$ $\Omega$	_____ $\times 10^{11}$ $\Omega$	$\pm 0.011 \times 10^{11}$ $\Omega$

<sup>1</sup> Test Result = 4349B Reading – Resistor Calibration Value

**4349B**

**Ammeter Offset Voltage and Input Resistance Test (Channel 2)**

**Ammeter Offset Voltage Test**

<b>Test Limits</b>	<b>Test Result</b>	<b>Measurement Uncertainty</b>
±2.5 mV	_____ mV	±0.0015 mV

**Ammeter Input Resistance Test**

<b>Test Limits</b>	<b>Test Result<sup>1</sup></b>	<b>Measurement Uncertainty</b>
± 50 Ω	_____ Ω	±0.52 Ω

<sup>1</sup> Test Result = Typical Value of 1 kΩ – Measured Value

**Current Measurement Accuracy Test (Channel 2)**

<b>Test Current</b>	<b>Test Limits</b>	<b>Measurement Time</b>	<b>Test Result<sup>1</sup></b>	<b>Measurement Uncertainty</b>
100 pA	±3.57 pA	30 ms	_____ pA	±0.56 pA
100 pA	±3.97 pA	100 ms	_____ pA	±0.56 pA
100 pA	±3.97 pA	400 ms	_____ pA	±0.56 pA
1 nA	±0.0307 nA	400 ms	_____ nA	±0.0016 nA
1 nA	±0.0277 nA	30 ms	_____ nA	±0.0016 nA
10 nA	±0.211 nA	30 ms	_____ nA	±0.011 nA
100 nA	±2.10 nA	30 ms	_____ nA	±0.10 nA
1 μA	±0.0210 μA	30 ms	_____ μA	±0.0011 μA
10 μA	±0.210 μA	30 ms	_____ μA	±0.007 μA
100 μA	±2.12 μA	10 ms	_____ μA	±0.07 μA

<sup>1</sup> Test Result = 4349B Reading – (Multimeter Reading ÷ Resistor Calibration Value)

**Resistance Measurement Accuracy Test (Channel 2)**

<b>Resistor Setting</b>	<b>Voltage Setting</b>	<b>Measurement Time</b>	<b>Test Limits</b>	<b>Test Result<sup>1</sup></b>	<b>Measurement Uncertainty</b>
10 <sup>6</sup> Ω	100 V	10 ms	±0.0212 × 10 <sup>6</sup> Ω	_____ × 10 <sup>6</sup> Ω	±0.0005 × 10 <sup>6</sup> Ω
10 <sup>7</sup> Ω	100 V	30 ms	±0.0210 × 10 <sup>7</sup> Ω	_____ × 10 <sup>7</sup> Ω	±0.0011 × 10 <sup>7</sup> Ω
10 <sup>8</sup> Ω	100 V	30 ms	±0.0210 × 10 <sup>8</sup> Ω	_____ × 10 <sup>8</sup> Ω	±0.0011 × 10 <sup>8</sup> Ω
10 <sup>8</sup> Ω	100 V	400 ms	±0.0240 × 10 <sup>8</sup> Ω	_____ × 10 <sup>8</sup> Ω	±0.0011 × 10 <sup>8</sup> Ω
10 <sup>9</sup> Ω	100 V	30 ms	±0.0210 × 10 <sup>9</sup> Ω	_____ × 10 <sup>9</sup> Ω	±0.0016 × 10 <sup>9</sup> Ω
10 <sup>10</sup> Ω	100 V	30 ms	±0.0271 × 10 <sup>10</sup> Ω	_____ × 10 <sup>10</sup> Ω	±0.0056 × 10 <sup>10</sup> Ω
10 <sup>11</sup> Ω	100 V	30 ms	±0.0460 × 10 <sup>11</sup> Ω	_____ × 10 <sup>11</sup> Ω	±0.011 × 10 <sup>11</sup> Ω
10 <sup>11</sup> Ω	100 V	10 ms	±0.0540 × 10 <sup>11</sup> Ω	_____ × 10 <sup>11</sup> Ω	±0.011 × 10 <sup>11</sup> Ω
10 <sup>11</sup> Ω	10 V	30 ms	±0.0543 × 10 <sup>11</sup> Ω	_____ × 10 <sup>11</sup> Ω	±0.011 × 10 <sup>11</sup> Ω

<sup>1</sup> Test Result = 4349B Reading – Resistor Calibration Value

**Ammeter Offset Voltage and Input Resistance Test (Channel 3)****Ammeter Offset Voltage Test**

Test Limits	Test Result	Measurement Uncertainty
$\pm 2.5$ mV	_____ mV	$\pm 0.0015$ mV

**Ammeter Input Resistance Test**

Test Limits	Test Result <sup>1</sup>	Measurement Uncertainty
$\pm 50$ $\Omega$	_____ $\Omega$	$\pm 0.52$ $\Omega$

<sup>1</sup> Test Result = Typical Value of 1 k $\Omega$  – Measured Value

**Current Measurement Accuracy Test (Channel 3)**

Test Current	Test Limits	Measurement Time	Test Result <sup>1</sup>	Measurement Uncertainty
100 pA	$\pm 3.57$ pA	30 ms	_____ pA	$\pm 0.56$ pA
100 pA	$\pm 3.97$ pA	100 ms	_____ pA	$\pm 0.56$ pA
100 pA	$\pm 3.97$ pA	400 ms	_____ pA	$\pm 0.56$ pA
1 nA	$\pm 0.0307$ nA	400 ms	_____ nA	$\pm 0.0016$ nA
1 nA	$\pm 0.0277$ nA	30 ms	_____ nA	$\pm 0.0016$ nA
10 nA	$\pm 0.211$ nA	30 ms	_____ nA	$\pm 0.011$ nA
100 nA	$\pm 2.10$ nA	30 ms	_____ nA	$\pm 0.10$ nA
1 $\mu$ A	$\pm 0.0210$ $\mu$ A	30 ms	_____ $\mu$ A	$\pm 0.0011$ $\mu$ A
10 $\mu$ A	$\pm 0.210$ $\mu$ A	30 ms	_____ $\mu$ A	$\pm 0.007$ $\mu$ A
100 $\mu$ A	$\pm 2.12$ $\mu$ A	10 ms	_____ $\mu$ A	$\pm 0.07$ $\mu$ A

<sup>1</sup> Test Result = 4349B Reading – (Multimeter Reading  $\div$  Resistor Calibration Value)

**Resistance Measurement Accuracy Test (Channel 3)**

Resistor Setting	Voltage Setting	Measurement Time	Test Limits	Test Result <sup>1</sup>	Measurement Uncertainty
$10^6$ $\Omega$	100 V	10 ms	$\pm 0.0212 \times 10^6$ $\Omega$	_____ $\times 10^6$ $\Omega$	$\pm 0.0005 \times 10^6$ $\Omega$
$10^7$ $\Omega$	100 V	30 ms	$\pm 0.0210 \times 10^7$ $\Omega$	_____ $\times 10^7$ $\Omega$	$\pm 0.0011 \times 10^7$ $\Omega$
$10^8$ $\Omega$	100 V	30 ms	$\pm 0.0210 \times 10^8$ $\Omega$	_____ $\times 10^8$ $\Omega$	$\pm 0.0011 \times 10^8$ $\Omega$
$10^8$ $\Omega$	100 V	400 ms	$\pm 0.0240 \times 10^8$ $\Omega$	_____ $\times 10^8$ $\Omega$	$\pm 0.0011 \times 10^8$ $\Omega$
$10^9$ $\Omega$	100 V	30 ms	$\pm 0.0210 \times 10^9$ $\Omega$	_____ $\times 10^9$ $\Omega$	$\pm 0.0016 \times 10^9$ $\Omega$
$10^{10}$ $\Omega$	100 V	30 ms	$\pm 0.0271 \times 10^{10}$ $\Omega$	_____ $\times 10^{10}$ $\Omega$	$\pm 0.0056 \times 10^{10}$ $\Omega$
$10^{11}$ $\Omega$	100 V	30 ms	$\pm 0.0460 \times 10^{11}$ $\Omega$	_____ $\times 10^{11}$ $\Omega$	$\pm 0.011 \times 10^{11}$ $\Omega$
$10^{11}$ $\Omega$	100 V	10 ms	$\pm 0.0540 \times 10^{11}$ $\Omega$	_____ $\times 10^{11}$ $\Omega$	$\pm 0.011 \times 10^{11}$ $\Omega$
$10^{11}$ $\Omega$	10 V	30 ms	$\pm 0.0543 \times 10^{11}$ $\Omega$	_____ $\times 10^{11}$ $\Omega$	$\pm 0.011 \times 10^{11}$ $\Omega$

<sup>1</sup> Test Result = 4349B Reading – Resistor Calibration Value

**4349B**

**Ammeter Offset Voltage and Input Resistance Test (Channel 4)**

**Ammeter Offset Voltage Test**

<b>Test Limits</b>	<b>Test Result</b>	<b>Measurement Uncertainty</b>
±2.5 mV	_____ mV	±0.0015 mV

**Ammeter Input Resistance Test**

<b>Test Limits</b>	<b>Test Result<sup>1</sup></b>	<b>Measurement Uncertainty</b>
± 50 Ω	_____ Ω	±0.52 Ω

<sup>1</sup> Test Result = Typical Value of 1 kΩ – Measured Value

**Current Measurement Accuracy Test (Channel 4)**

<b>Test Current</b>	<b>Test Limits</b>	<b>Measurement Time</b>	<b>Test Result<sup>1</sup></b>	<b>Measurement Uncertainty</b>
100 pA	±3.57 pA	30 ms	_____ pA	±0.56 pA
100 pA	±3.97 pA	100 ms	_____ pA	±0.56 pA
100 pA	±3.97 pA	400 ms	_____ pA	±0.56 pA
1 nA	±0.0307 nA	400 ms	_____ nA	±0.0016 nA
1 nA	±0.0277 nA	30 ms	_____ nA	±0.0016 nA
10 nA	±0.211 nA	30 ms	_____ nA	±0.011 nA
100 nA	±2.10 nA	30 ms	_____ nA	±0.10 nA
1 μA	±0.0210 μA	30 ms	_____ μA	±0.0011 μA
10 μA	±0.210 μA	30 ms	_____ μA	±0.007 μA
100 μA	±2.12 μA	10 ms	_____ μA	±0.07 μA

<sup>1</sup> Test Result = 4349B Reading – (Multimeter Reading ÷ Resistor Calibration Value)

**Resistance Measurement Accuracy Test (Channel 4)**

<b>Resistor Setting</b>	<b>Voltage Setting</b>	<b>Measurement Time</b>	<b>Test Limits</b>	<b>Test Result<sup>1</sup></b>	<b>Measurement Uncertainty</b>
10 <sup>6</sup> Ω	100 V	10 ms	±0.0212 × 10 <sup>6</sup> Ω	_____ × 10 <sup>6</sup> Ω	±0.0005 × 10 <sup>6</sup> Ω
10 <sup>7</sup> Ω	100 V	30 ms	±0.0210 × 10 <sup>7</sup> Ω	_____ × 10 <sup>7</sup> Ω	±0.0011 × 10 <sup>7</sup> Ω
10 <sup>8</sup> Ω	100 V	30 ms	±0.0210 × 10 <sup>8</sup> Ω	_____ × 10 <sup>8</sup> Ω	±0.0011 × 10 <sup>8</sup> Ω
10 <sup>8</sup> Ω	100 V	400 ms	±0.0240 × 10 <sup>8</sup> Ω	_____ × 10 <sup>8</sup> Ω	±0.0011 × 10 <sup>8</sup> Ω
10 <sup>9</sup> Ω	100 V	30 ms	±0.0210 × 10 <sup>9</sup> Ω	_____ × 10 <sup>9</sup> Ω	±0.0016 × 10 <sup>9</sup> Ω
10 <sup>10</sup> Ω	100 V	30 ms	±0.0271 × 10 <sup>10</sup> Ω	_____ × 10 <sup>10</sup> Ω	±0.0056 × 10 <sup>10</sup> Ω
10 <sup>11</sup> Ω	100 V	30 ms	±0.0460 × 10 <sup>11</sup> Ω	_____ × 10 <sup>11</sup> Ω	±0.011 × 10 <sup>11</sup> Ω
10 <sup>11</sup> Ω	100 V	10 ms	±0.0540 × 10 <sup>11</sup> Ω	_____ × 10 <sup>11</sup> Ω	±0.011 × 10 <sup>11</sup> Ω
10 <sup>11</sup> Ω	10 V	30 ms	±0.0543 × 10 <sup>11</sup> Ω	_____ × 10 <sup>11</sup> Ω	±0.011 × 10 <sup>11</sup> Ω

<sup>1</sup> Test Result = 4349B Reading – Resistor Calibration Value

## Functional Test

### Introduction

This section provides the test procedures used to verify that the 4349B performs its designed functions. The functional tests can be used for post repair function verification.

### Test Equipment

Table 9-1 lists the test equipment required to perform the tests described in this section. Equipment which equals or surpasses the key required specifications of the recommended equipment may be used.



## 4349B

### Handler Interface Functional Test

The 4349B's handler interface function is tested using the built-in selftest and the handler interface tester.

#### Test Equipment

Description	Recommended Model
Handler Interface Tester	04339-65007

#### Procedure

##### Initial Setup.

1. Turn the 4349B OFF.
2. Set the LED\_PW switch on the Handler Interface Tester to *OFF*, and set the IN1, IN2, IN3, and IN4 switches to *0*.
3. Set up the equipment as shown in Figure 9-10

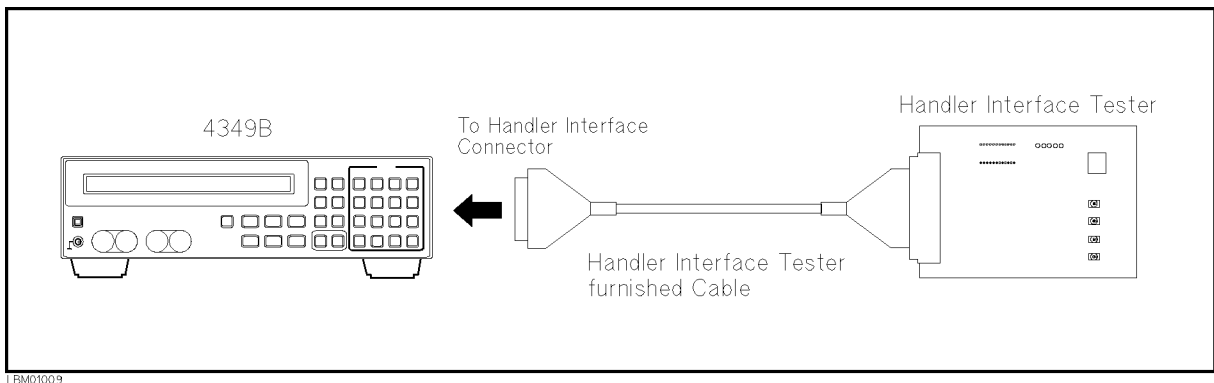







Figure 9-10. Handler Interface Functional Test Setup





4. Turn the 4349B ON.
5. Reset the 4349B using the following procedure.
  - a. Press   to display the system reset settings.
  - b. Select Yes using  or  and press .

##### Key Lock Function Test.









6. Set the IN4 switch on the Handler Interface Tester to *1*.
7. Confirm that the all keys on the 4349B's front panel are locked out.
8. Set the IN4 switch on the Handler Interface Tester to *0*.

##### External Trigger Function Test.

9. Press  to set the trigger mode to External.

10. Set the measurement parameter to current (I).
  - a. Press  .
  - b. Select I using  or  and press  .
11. Press the *IN5* switch on the Handler Interface Tester, and confirm that the 4349B is triggered.

**Handler Interface Output Test.**

12. Start the handler interface output test with the following procedure.
  - a. Press   to display the configuration setting menu.
  - b. Select Svc using  or  and press  .
  - c. Select HNDL using  or  and press  .
13. Set the *LED\_PW* switch on the Handler Interface Tester to *ON*.

**Caution**  Don't set the *LED\_PW* switch to *ON*, except when doing the handler interface output test. The LEDs may cause the 4349B to shut-down during normal operation.

14. Confirm that the LEDs on the Handler Interface Tester light in the order shown in Figure 9-11, in accordance with the 4349B display.

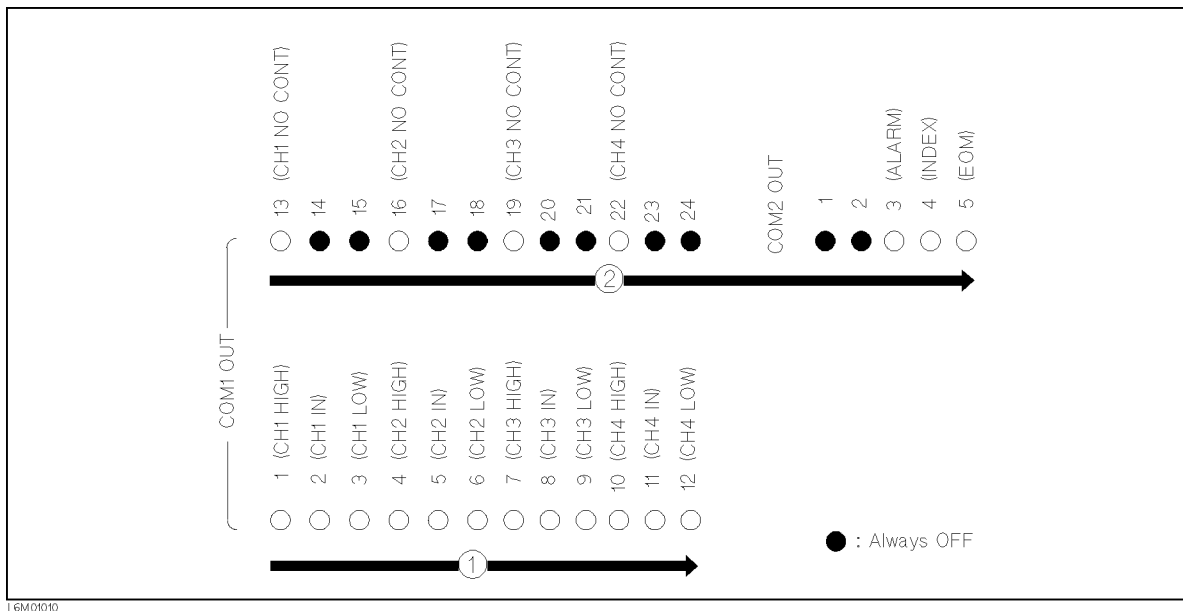

**Figure 9-11. Handler interface Output Order**

15. Set the *LED\_PW* switch on the Handler Interface Tester to OFF.
16. Press  twice to exit from the test mode.

## 4349B





### Contact Check Functional Test

The 4349B's contact check function is confirmed.

#### Test Equipment

Description	Recommended Model
SMU Test Adapter	PN 04145-65001
BNC(m)-BNC(m) Adapter	PN 1250-0216

#### Procedure

1. Reset the 4349B with the following procedure.
  - a. Press   to display the system reset settings.
  - b. Select Yes using  or  and press .
2. Set up the equipment as shown in Figure 9-12.

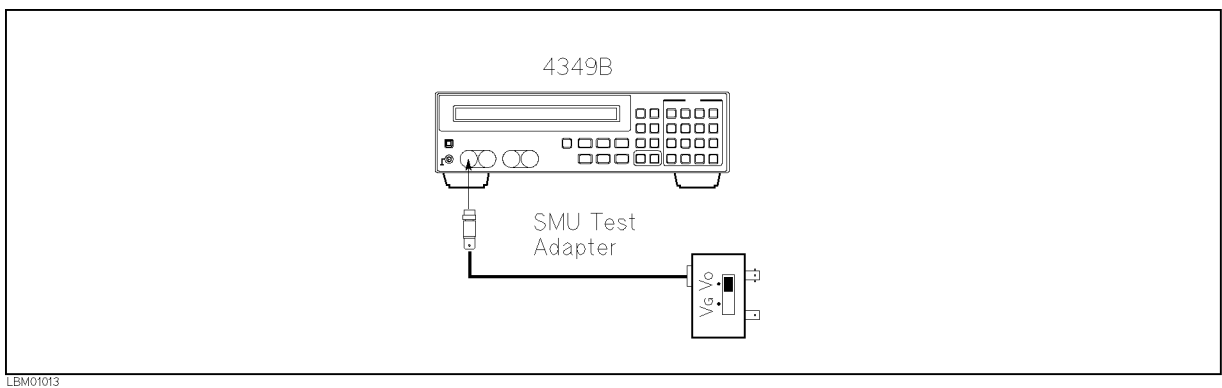















Figure 9-12. Contact Check Functional Test Setup

3. Set the SMU Test Adapter switch to  $V_o$  position.
4. Set the measurement range to  $10 \mu\text{A}$  with the following procedure.
  - a. Press  to display the measurement range setup menu.
  - b. Select  $10 \mu\text{A}$  using  or  and press .
5. Set the measurement parameter to current (I).
  - a. Press .
  - b. Select I using  or  and press .
6. Press   to perform the OPEN correction.

7. Press   and select ON/OFF, ON to turn the contact check function ON.
8. Confirm that the 4349B displays *N.C.* (No Contact).
9. Connect the BNC(m)-BNC(m) adapter to the MONITOR terminal of the SMU Test Adapter.
10. Confirm that the *N.C.* disappears and the 4349B displays the measurement value.
11. Press  to change channel, and test the other channels using the steps 2 to 10.

## Manual Changes

---

### Introduction

This appendix contains the information required to adapt this manual to earlier versions or configurations of the 4349B than the current printing date of this manual. The information in this manual applies directly to the 4349B serial number prefix listed on the title page of this manual.

### Manual Changes

To adapt this manual to your 4349B, see Table A-1 and Table A-2, and make all the manual changes listed opposite your instrument's serial number and firmware version.

Instruments manufactured after the printing of this manual may be different from those documented in this manual. Later instrument versions will be documented in a manual changes supplement that will accompany the manual shipped with that instrument. If your instrument's serial number or ROM version is not listed on the title page of this manual, in Table A-1, or Table A-2, make changes according to the *yellow MANUAL CHANGES* supplement.

In additions to information on changes, the supplement may contain information for correcting errors (Errata) in the manual. To keep this manual as current and accurate as possible, Agilent Technologies recommends that you periodically request the latest *MANUAL CHANGES* supplement.

For information concerning serial number prefixes not listed on the title page or in the *MANUAL CHANGE* supplement, contact the nearest Agilent Technologies office.

To confirm the ROM version, turn ON the power for the 4349B or execute \*IDN? on the external controller.

**Table A-1. Manual Changes by Serial Number**

Serial Prefix or Number	Make Manual Changes

**Table A-2. Manual Changes by ROM Version**

Version	Make Manual Changes
1.00	Change 1, Change 2
1.01, 1.02, 1.03	Change 2

---

## Serial Number

Agilent Technologies uses a two-part, ten-character serial number that is stamped on the serial number plate (see Figure A-1) attached to the rear panel. The first five characters are the serial prefix and the last five digits are the suffix.









**Figure A-1. Serial Number Plate**

---

## Change 1

Delete the following function.

- Limit Value Reading function (   LimitC)
- Offset Setting function (   ofsEnt)
- DUT Capacitance Reading function (   MeasC)

Delete the following GPIB command.

- :SENSe:CONtact:DATA{1|2|3|4}?
- :SENSe:CONtact:LIMit{1|2|3|4}?
- :SENSe:CONtact:OFFSet{1|2|3|4}

## Change 2

Change Table C-1 and Table C-2 to Table A-3 and Table A-4 respectively.

**Table A-3. OVLD/N.C. Operations (Meas. parameter: R)**

	Display		Handler Output	GPIB Output <sup>1</sup>	Solutions
	Data Mode	Comprtr Mode			
OVLD (Overload)	OVLD	LOW	/LO1-4	<stat1-4> <sup>2</sup> : 1 <data1-4>: 9.9E37 <comp1-4> <sup>3</sup> : 4	Select an appropriate measurement range.
N.C. (No-Contact)	N.C.	N.C.	/NO CONTACT1-4	<stat1-4> <sup>2</sup> : 2 <data1-4>: 9.9E37 <comp1-4> <sup>3</sup> : 8	Cancel the bad contact between DUT and contact-pin.
OVLD & N.C.	N.C.	N.C.	/NO CONTACT1-4	<stat1-4> <sup>2</sup> : 3 <data1-4>: 9.9E37 <comp1-4> <sup>3</sup> : 8	Select an appropriate measurement range. Cancel the bad contact between DUT and contact-pin.

1 Refer to :FETCh? in Chapter 5

2 Measurement status (0:Normal, 1:Overload, 2:No-Contact)

3 Comparison result (1:In, 2:High, 4:Low, 8:No-Contact)

**Table A-4. OVLD/N.C. Operations(Meas. parameter: I)**

	Display		Handler Output	GPIB Output <sup>1</sup>	Solutions
	Data Mode	Comprtr Mode			
OVLD (Overload)	OVLD	HIGH	/HI1-4	<stat1-4> <sup>2</sup> : 1 <data1-4>: 9.9E37 <comp1-4> <sup>3</sup> : 2	Select an appropriate measurement range.
N.C. (No-Contact)	N.C.	N.C.	/NO CONTACT1-4	<stat1-4> <sup>2</sup> : 2 <data1-4>: 9.9E37 <comp1-4> <sup>3</sup> : 8	Cancel the bad contact between DUT and contact-pin.
OVLD & N.C.	N.C.	N.C.	/NO CONTACT1-4	<stat1-4> <sup>2</sup> : 3 <data1-4>: 9.9E37 <comp1-4> <sup>3</sup> : 8	Select an appropriate measurement range. Cancel the bad contact between DUT and contact-pin.

1 Refer to :FETCh? in Chapter 5

2 Measurement status (0:Normal, 1:Overload, 2:No-Contact)

3 Comparison result (1:In, 2:High, 4:Low, 8:No-Contact)



## Handler Interface Installation

---

### Introduction

Before using the handler interface, connect the pull-up resistors to enable the output signals and set the dip switch to select the voltage level for the input signals.

---

### Electrical Characteristics

#### Output Signals

Each DC output is isolated using open collector output opto-isolators. The output voltage of each line is enabled by putting pull-up resistors on the main board, and by connecting the pull-up resistors to an externally applied DC voltage.

The electrical circuits of the DC isolated outputs are divided into two groups to be able to separate power supplies (refer to Table B-1).

A simplified diagram of the output signals is shown in Figure B-1 for comparison signals and Figure B-2 for control signals.

**Table B-1. Handler Output Electrical Characteristics**

Output Signals	Voltage Output Rating		Maximum Current	External Voltage/ Circuit Common
	Low	High		
<b>Comparison Signals</b> /HI1 to /HI4 /IN1 to /IN4 /LO1 to /LO4 /NO CONTACT1 to /NO CONTACT4	≤ 0.5 V	5 to 24 V	6 mA	EXT DCV1 COM1
<b>Control Signals</b> /ALARM /INDEX /EOM	≤ 0.5 V	5 to 15 V	5 mA	EXT DCV2 COM2

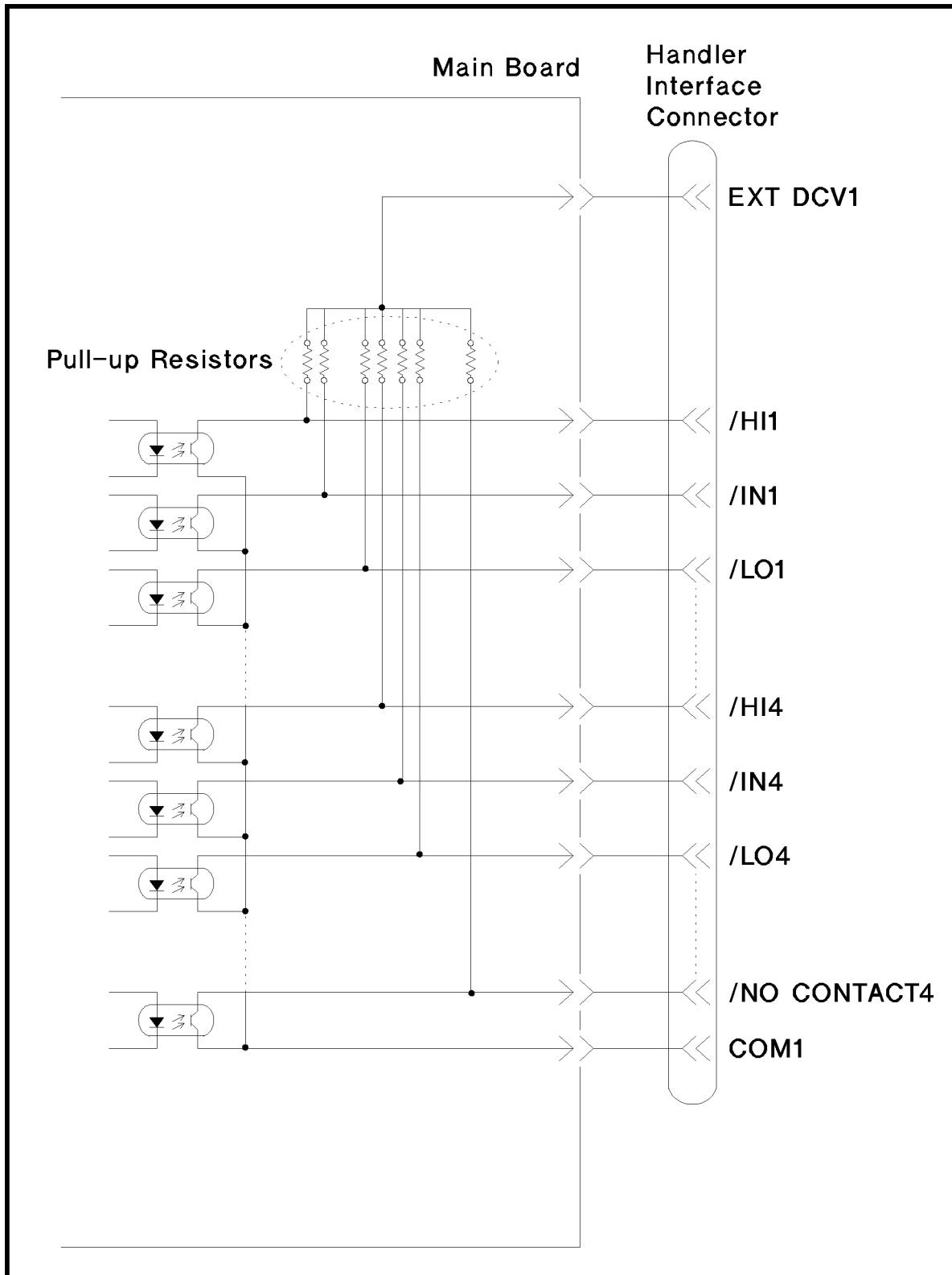

L600B001

**Figure B-1. Handler Interface Comparison Output Signals Diagram**

## B-2 Handler Interface Installation

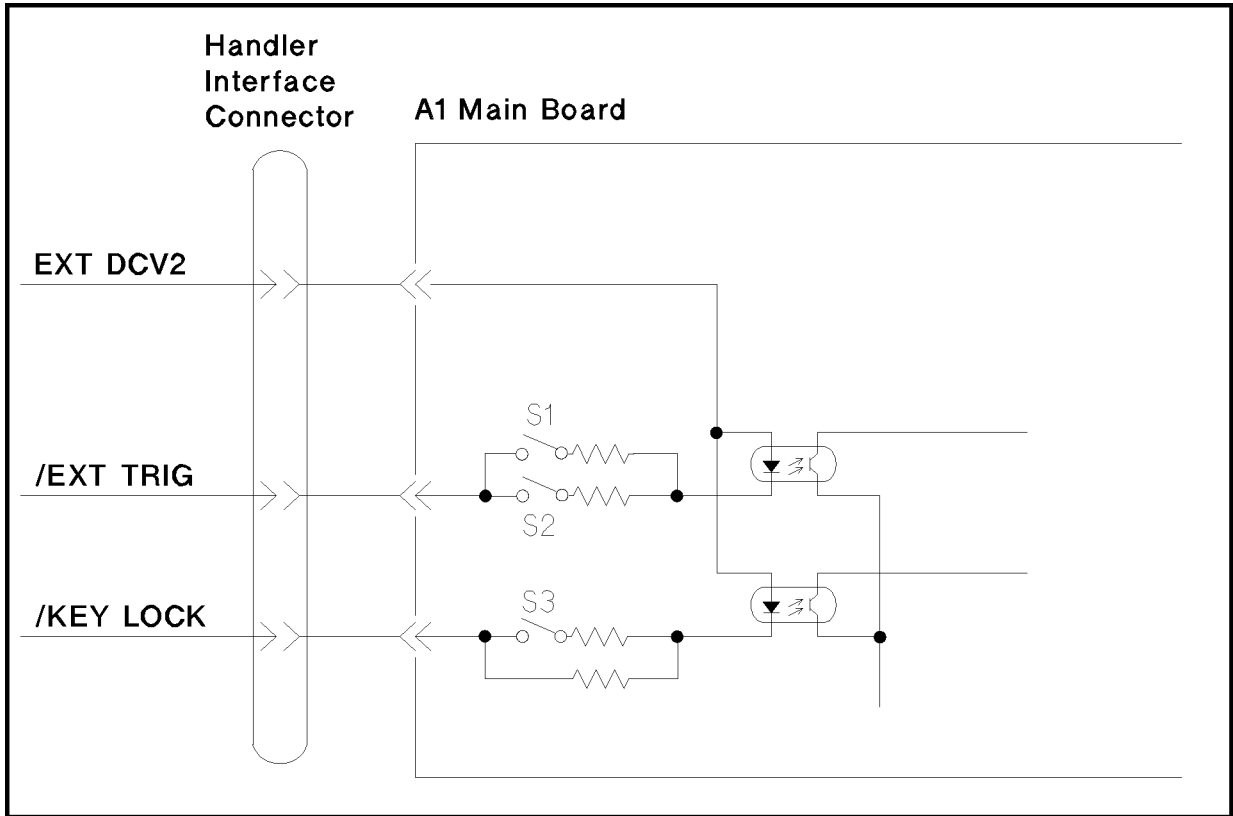

L600B002

**Figure B-2. Handler Interface Control Output Signals Diagram**

**Input Signals**

The DC isolated input signals are connected to the cathodes of the LEDs in the opto-isolators. The anodes of the LEDs are powered by an external voltage source (EXT DCV2).

The OFF state voltage (high level) of the DC isolated input signals depends on the pull-up voltage powered by an external voltage source (EXT DCV2). (The input current is restricted by using a switch on the main board.)

The electrical characteristics of the input signals are listed in Table B-2. A diagram for the input signals is shown in Figure B-3.

**Table B-2. Handler Input Electrical Characteristics**

Signal	Input Voltage		Input Current (Low) Pull-up Voltage			Circuit Common
	Low	High	5 V	12 V	15 V	
/EXT TRIG	≤ 1 V	5 to 15 V	8.7 mA	10.5 mA	13.5 mA	COM2
/KEY LOCK	≤ 1 V	5 to 15 V	7.7 mA	10.8 mA	13.6 mA	COM2

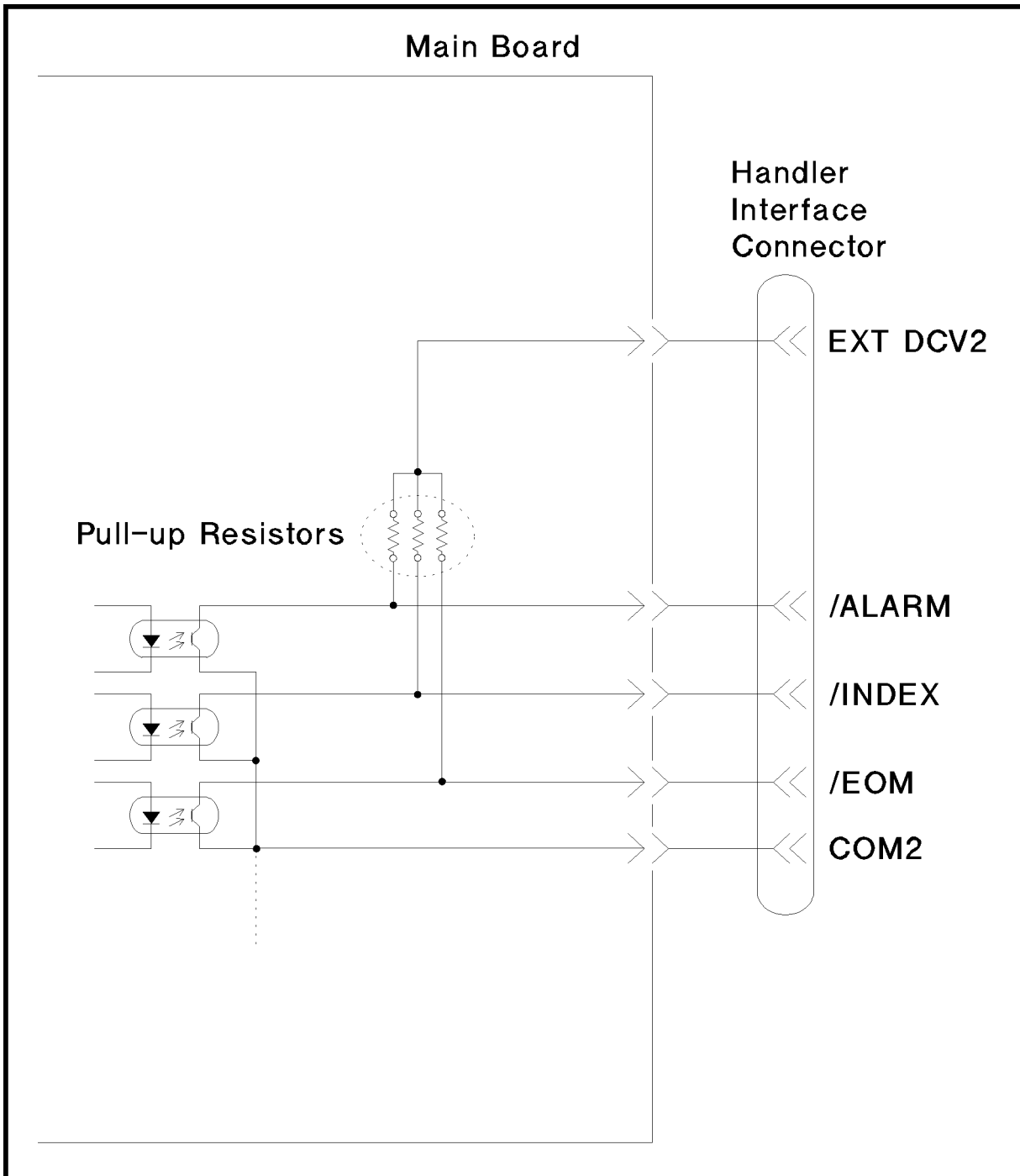

L600B003

Figure B-3. Handler Interface Input Signal Diagram

---

## Setting Up the Handler Interface Board

This section describes how to connect pull-up resistors to enable the output signals, and how to set the dip switch to select voltage levels for the input signals. These procedures must be done before using the handler interface.

---

**Caution**      SUSCEPTIBLE TO DAMAGE FROM ESD.



Perform the following procedures only at a static-safe workstation and wear a grounding strap.

---

**Caution**      Be careful not to short the circuit when performing the following procedures. For example:



- Solder cleanly and carefully.
- Guard against hair or dust getting on the circuit.
- Do *not* damage the boards, wires, or parts on the board.

---

## Tools and Fasteners

The 4349B mechanical components are secured using metric threaded fasteners. Many fasteners in the 4349B may appear to be Phillips type, but they are Pozidrive type fasteners. To avoid damaging them, use only Pozidrive screwdrivers to remove or tighten pozidrive type fasteners.

### Procedure

1. Disconnect the power cable from the 4349B and allow enough time (10 minutes) for the internal capacitors to discharge.

---

**Warning**      **Dangerous energy and voltage levels exist within the 4349B when it is in operation and just after it is powered down. Allow 10 minutes for the 4349B's internal capacitors to discharge before starting to work on it.**



2. Remove the two screws which fasten the cover to the chassis rear panel.
3. Slide the cover toward the rear while holding the front panel bezel.

The following figure shows the location of the A1 main board and the A2 CPU board.

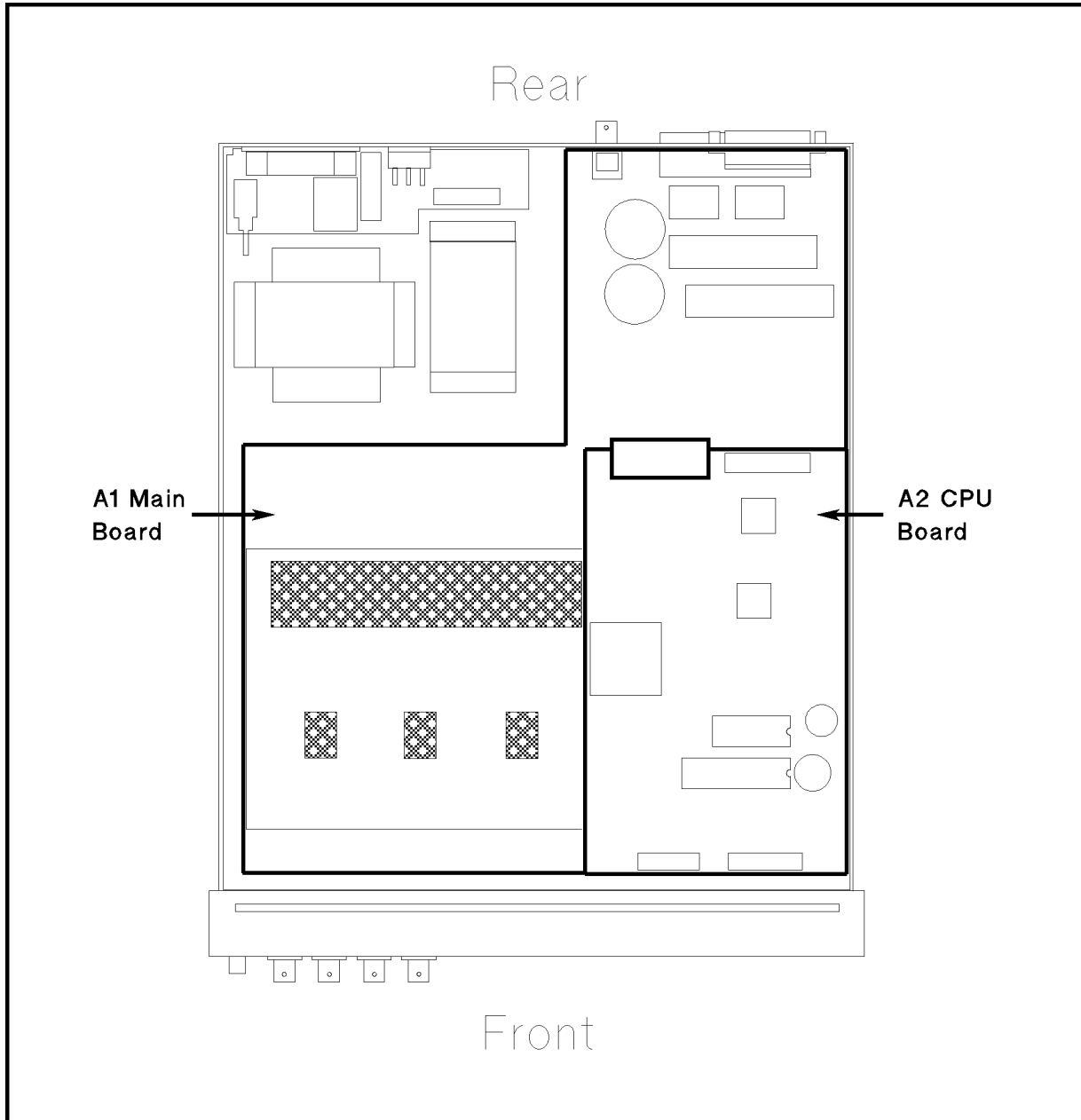

L600B005

4. Remove the A2 CPU board assembly.
  - a. Disconnect two flatcables which connect the A2 board to the keyboard assembly and the LCD assembly.
  - b. Remove the four screws that secure the A2 board to the stud.
  - c. Disconnect the flatcable which connects the A2 board to the A1 main board on the bottom.
  - d. Remove the A2 board from the chassis.

## 4349B

5. Remove the A1 main board assembly.
  - a. Disconnect the following cable assemblies from the A1 board.
    - i. Four (or two for Option 001) cables connected to the UNKNOWN connectors.
    - ii. The cable assembly from the transformer.
    - iii. Two cable assemblies from the dc-dc converter.
  - b. Remove the four studs that secure the A1 board to the chassis by rotating them using a flat blade screwdriver.
  - c. Remove the screws that secure the A1 board to the chassis.
  - d. Remove the A1 board from the chassis.

Figure B-4 shows the location of the sockets for the pull-up resistors (J13 and J19) and the switch for EXT DCV2 voltage setting (SW1). Table B-3 lists the location of the pull-up resistors.

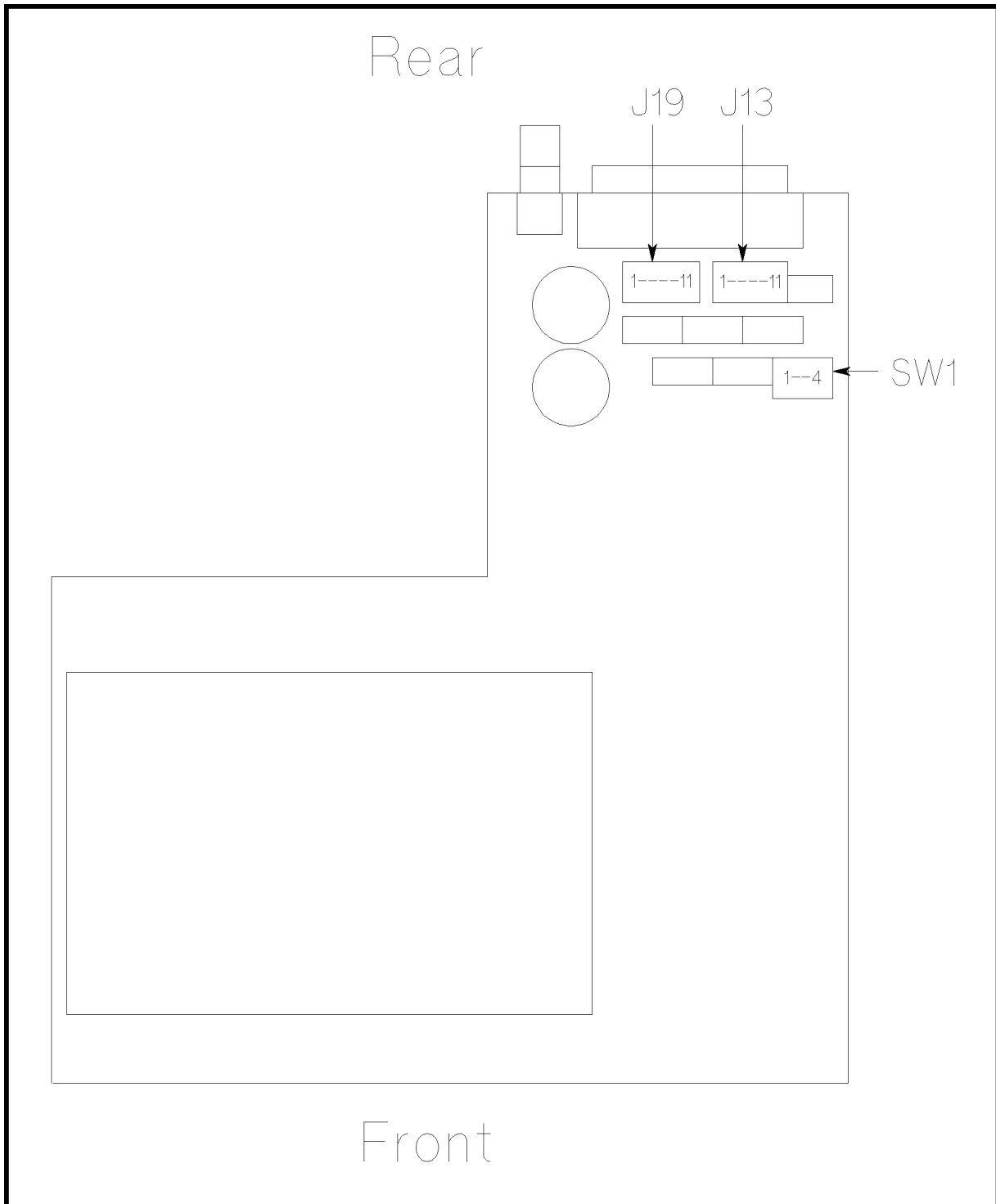

L600B004

Figure B-4. A1 Main Board



**Table B-3. Pull-up Resistor Locations**

Socket No.	J19		J13	
	Signal Name	Signal Type	Signal Name	Signal Type
1	/IN1	Comparison Signal (5 to 24 V)	/NO CONTACT3	Comparison Signal (5 to 24 V)
2	/HI1		/IN4	
3	/LO1		/HI4	
4	/NO CONTACT1		/LO4	
5	/IN2		/NO CONTACT4	
6	/HI2		/ALARM	Control Signal (5 to 15 V)
7	/LO2		/INDEX	
8	/NO CONTACT3		/EOM	
9	/IN3			
10	/HI3			
11	/LO3			

6. Mount the pull-up resistors for the comparison output signals. (Refer to Figure B-4 and Table B-3 for the location of the pull-up resistors for the comparison output signals.) Use the following equation to determine the value of the pull-up resistors (R).

$$R \text{ [k}\Omega] \simeq V_p \text{ [V]} / 3$$

where,  $V_p$  is the pull-up voltage.

The typical pull-up resistor values are:

Pull-up Voltage	Pull-up Resistor Agilent Part Number
5 V	0757-0278 (1.78 k $\Omega$ )
12 V	0757-0279 (3.16 k $\Omega$ )
24 V	0757-0441 (8.25 k $\Omega$ )

7. Mount the pull-up resistors for the control output signals. (Refer to Figure B-4 and Table B-3 for the location of the pull-up resistors for the control output signals.) Use the following equation to determine the value of the pull-up resistors (R).

$$R \text{ [k}\Omega] \simeq V_p \text{ [V]} / 2.5$$

where,  $V_p$  is the pull-up voltage.

The typical pull-up resistor values are:

<b>Pull-up Voltage</b>	<b>Pull-up Resistor Agilent Part Number</b>
5 V	0757-0278 (1.78 k $\Omega$ )
9 V	0757-0279 (3.16 k $\Omega$ )
12 V	0698-3154 (4.22 k $\Omega$ )
15 V	0757-0438 (5.11 k $\Omega$ )

<b>EXT DCV2</b>	<b>EXT TRIG</b>		<b>KEY LOCK</b>
	<b>SW1-1</b>	<b>SW1-2</b>	<b>SW1-3</b>
5 to 6 V	Close	Close	Close
6 to 9 V	Close	Open	Close
9 to 15 V	Open	Close	Open

8. Reinstall the A1 main board, the A2 board, and the cover.

## Overload/No-Contact Operations

Table C-1 shows the summary of operations when the 4349B detects OVLD (Overload), or N.C. (No-Contact). (Measurement parameter: R)

**Table C-1. OVLD/N.C. Operations (Meas. parameter: R)**

	Display		Handler Output	GPIB Output <sup>1</sup>	Solutions
	Data Mode	Comprtr Mode			
OVLD (Overload)	OVLD	LOW	/LO1-4	<stat1-4> <sup>2</sup> : 1 <data1-4>: 9.9E37 <comp1-4> <sup>3</sup> : 4	Select an appropriate measurement range.
N.C. (No-Contact)	N.C.	N.C.	/NO CONTACT1-4	<stat1-4> <sup>2</sup> : 2 <data1-4>: 9.9E37 <comp1-4> <sup>3</sup> : 8	Cancel the bad contact between DUT and contact-pin.
OVLD & N.C.	OVLD	LOW	/LO1-4 & /NO CONTACT1-4	<stat1-4> <sup>2</sup> : 3 <data1-4>: 9.9E37 <comp1-4> <sup>3</sup> : 12	Select an appropriate measurement range. Cancel the bad contact between DUT and contact-pin.

1 Refer to :FETCh? in Chapter 5

2 Measurement status (0:Normal, 1:Overload, 2:No-Contact)

3 Comparison result (1:In, 2:High, 4:Low, 8:No-Contact)

### Note



When OVLD and N.C. are detected at the same time, <stat> and <comp> of the GPIB output are the sum of the numbers which show each phenomenon. Therefore the value of <stat> is 1(OVLD)+2(N.C.)=3, the value of <comp> is 4(Low)+8(N.C.)=12.

When the measurement parameter is I, High or Low status in the operation of handler/GPIB output and display is reversed as shown in Table C-2.

Table C-2. OVLD/N.C. Operations(Meas. parameter: I)

	Display		Handler Output	GPIB Output <sup>1</sup>	Solutions
	Data Mode	Comprtr Mode			
OVLD (Overload)	OVLD	HIGH	/HI1-4	<stat1-4> <sup>2</sup> : 1 <data1-4>: 9.9E37 <comp1-4> <sup>3</sup> : 2	Select an appropriate measurement range.
N.C. (No-Contact)	N.C.	N.C.	/NO CONTACT1-4	<stat1-4> <sup>2</sup> : 2 <data1-4>: 9.9E37 <comp1-4> <sup>3</sup> : 8	Cancel the bad contact between DUT and contact-pin.
OVLD & N.C.	OVLD	HIGH	/HI1-4 & /NO CONTACT1-4	<stat1-4> <sup>2</sup> : 3 <data1-4>: 9.9E37 <comp1-4> <sup>3</sup> : 10	Select an appropriate measurement range. Cancel the bad contact between DUT and contact-pin.

<sup>1</sup> Refer to :FETCh? in Chapter 5

<sup>2</sup> Measurement status (0:Normal, 1:Overload, 2:No-Contact)

<sup>3</sup> Comparison result (1:In, 2:High, 4:Low, 8:No-Contact)

## **Error Messages**

---

This section lists the messages that are displayed on the 4349B's LCD display or transmitted by the instrument over GPIB, in numerical order.

---

## Instrument Errors

### 11 ADC FAILURE

The A/D conversion failed. The 4349B stops operation and asserts the /ALARM signal on the handler interface. Contact your nearest Agilent Technologies office.

### 12 ROM TEST FAILED

The ROM failed. When this error occurs during power-on test, the 4349B stops operation and asserts the /ALARM signal on the handler interface. When this error occurs during self-test, the 4349B continues operation and asserts the /ALARM signal. Contact your nearest Agilent Technologies office.

### 13 RAM TEST FAILED

The RAM failed. The 4349B stops operation and asserts the /ALARM signal on the handler interface. Contact your nearest Agilent Technologies office.

### 14 EEPROM R/W FAILED

The EEPROM read/write test failed. The 4349B stops operation and asserts the /ALARM signal on the handler interface. Contact your nearest Agilent Technologies office.

### 15 USER DATA LOST

Correction data and instrument settings saved in EEPROM have been lost. When this error occurs during power-on test, the 4349B sets the data in the EEPROM to the factory default settings, continues operation, and does not assert the /ALARM signal on the handler interface. When this error occurs during self-test, the 4349B continues the operation and asserts the /ALARM signal. Contact your nearest Agilent Technologies office.

### 16 PREV. SETTING LOST

Instrument settings in the backup memory have been lost. The instrument keeps instrument settings in backup memory for 72 hours after being turned OFF. When this error occurs during power-on test, the 4349B continues operation and does not assert the /ALARM signal on the handler interface. When this error occurs during self-test, the 4349B stops operation and asserts the /ALARM signal.

### 17 SAVE FAILED

The instrument setting cannot be saved for some reason. (If the error is detected in the EEPROM, error 14 is displayed.) The 4349B continues operation and does not assert the /ALARM signal on the handler interface.

### 18 RECALL FAILED

No instrument setting saved in the EEPROM. (If the error is detected in the EEPROM, error 14 is displayed.) The 4349B continues operation and does not assert the /ALARM signal on the handler interface.

### 19 PRINTER NO RESPONSE

Check the following items:

- Check that the printer is turned on.
- Check that the GPIB cable is connected between the printer and the instrument.

## 4349B

- Check that the printer is set to “Listen Always.”

### 20 A1 BD TEST FAILED

The A1 board failed. When this error occurs during power-on test, the 4349B stops operation and asserts the /ALARM signal on the handler interface. When this error occurs during self-test, the 4349B continues operation and assert the /ALARM signal. Contact your nearest Agilent Technologies office.

### 21 LOCKOUT BY HANDLER

Front panel key input is disabled by the handler. The front panel key input cannot be enabled by the front panel keys or by GPIB commands when disabled by the handler.

### 31 to 34 CH1(, CH2, CH3, or CH4) HIGH LEAKAGE

When the OPEN correction is performed, the leakage current is too high (100 pA or above, –100 pA or below). Check that nothing is connected to the test lead.

### 35 to 38 CH1(, CH2, CH3, or CH4) HIGH STRAY C

When the OPEN correction is performed, the stray capacitance is too high(75 pF or above); for example, when you connect a coaxial test lead to a triaxial test lead, the coaxial cable is too long.

---

## GPIB Errors

### -100 Command error

This is a generic syntax error that the 4349B cannot detect more specific errors. This code indicates only that a command error, as defined in IEEE 488.2, 11.5.1.1.4, has occurred.

### -101 Invalid character

A syntax element contains a character which is invalid for that type; for example, a header containing an ampersand, SENSE&.

### -102 Syntax error

An unrecognized command or data type was encountered; for example, a string was received when the 4349B was not expecting to receive a string.

### -103 Invalid separator

The syntax analyzer was expecting a separator and encountered an illegal character; for example, the semicolon was omitted after a program message unit, \*RST:TRIG.

### -104 Data type error

The syntax analyzer recognized an unallowed data element; for example, numeric or string data was expected but block data was encountered.

**-105 GET not allowed**

A Group Execute Trigger (GET) was received within a program message (see IEEE 488.2, 7.7).

**-108 Parameter not allowed**

More parameters were received than expected for the header; for example, the AVER command only accepts one parameter, so receiving AVER is not allowed.

**-109 Missing parameter**

Fewer parameters were received than required for the header; for example, the AVER command requires one parameter, so receiving only AVER is not allowed.

**-112 Program mnemonic too long**

The header contains more than twelve characters (see IEEE 488.2, 7.6.1.4.1).

**-113 Undefined header**

The header is syntactically correct, but it is undefined for the 4349B; for example, \*XYZ is not defined for the 4349B.

**-121 Invalid character in number**

An invalid character for the data type being parsed was encountered; for example, an alpha character in a decimal numeric or a “9” in octal data.

**-123 Exponent too large**

The magnitude of the exponent was larger than 32000 (see IEEE 488.2, 7.7.2.4.1).

**-124 Too many digits**

The mantissa of a decimal numeric data element contains more than 255 digits excluding leading zeros (see IEEE 488.2, 7.7.2.4.1).

**-128 Numeric data not allowed**

Legal numeric data element was received, but the 4349B does not accept it in this position for a header.

**-131 Invalid suffix**

The suffix does not follow the syntax described in IEEE 488.2, 7.7.3.2, or the suffix is inappropriate for the 4349B.

**-138 Suffix not allowed**

A suffix was encountered after a numeric element which does not allow suffixes.

**-140 Character data error**

This error, as well as errors –141 through –148, are generated when analyzing the syntax of a character data element. This particular error message is used if the 4349B cannot detect a more specific error.



## **4349B**

### **-141 Invalid character data**

Either the character data element contains an invalid character or the particular element received is not valid for the header.

### **-144 Character data too long**

The character data element contains more than twelve characters (see IEEE 488.2, 7.7.1.4).

### **-148 Character data not allowed**

A legal character data element was encountered that's prohibited by the 4349B.

### **-150 String data error**

This error, as well as errors –151 and –158, are generated when analyzing the syntax of a string data element. This particular error message is used if the 4349B cannot detect a more specific error.

### **-151 Invalid string data**

A string data element was expected, but was invalid for some reason (see IEEE 488.2, 7.7.5.2); for example, an END message was received before the terminal quote character.

### **-158 String data not allowed**

A string data element was encountered but was not allowed by the 4349B at this point in the syntax analysis process.

### **-160 Block data error**

This error, as well as errors –161 and –168, are generated when analyzing the syntax of a block data element. This particular error message is used if the 4349B cannot detect a more specific error.

### **-161 Invalid block data**

A block data element was expected, but was invalid for some reason (see IEEE 488.2, 7.7.6.2); for example, an END message was received before the length was satisfied.

### **-168 Block data not allowed**

A legal block data element was encountered but was not allowed by the 4349B at this point in the syntax analysis process.

### **-170 Expression error**

This error, as well as errors –171 and –178, are generated when analyzing the syntax of an expression data element. This particular error message is used if the 4349B cannot detect a more specific error.

### **-171 Invalid expression**

The expression data element was invalid (see IEEE 488.2, 7.7.7.2); for example, unmatched parentheses or an illegal character.

**-178 Expression data not allowed**

A legal expression data was encountered but was not allowed by the 4349B at this point in the syntax analysis process.

**-200 Execution errors**

This is the generic syntax error that the 4349B cannot detect more specific errors. This code indicates only that an execution error as defined in IEEE 488.2, 11.5.1.1.5 has occurred.

**-211 Trigger ignored**

A GET, \*TRG, or triggering signal was received and recognized by the 4349B but was ignored because of 4349B timing considerations; for example, the 4349B was not ready to respond.

**-213 Init ignored**

A request for a measurement initiation was ignored as another measurement was already in progress.

**-221 Settings conflict**

A legal program data element was parsed but could not be executed due to the current device state (see IEEE 488.2, 6.4.5.3 and 11.5.1.1.5).

**-222 Data out of range**

A legal program data element was parsed but could not be executed because the interpreted value was outside the legal range as defined by the 4349B (see IEEE 488.2, 11.5.1.1.5).

**-223 Too much data**

A legal program data element of block, expression, or string type was received that contained more data than the 4349B could handle due to memory or related device-specific requirements.

**-230 Data corrupt or stale**

Possibly invalid data; new reading started but not completed since last access.

**-241 Hardware missing**

A legal program command or query could not be executed because of missing 4349B hardware; for example, an option was not installed.

**-310 System error**

Some error, termed "system error" by the 4349B, has occurred.

**-311 Memory error**

An error was detected in the 4349B's memory.

**-313 Calibration memory lost**

The nonvolatile calibration data has been lost. When this error occurs during power-on test, the 4349B stops operation and asserts the /ALARM signal on the handler interface. When this error occurs during self-test, the 4349B continues operation and asserts the /ALARM signal. Contact your nearest Agilent Technologies office.

## **4349B**

### **-350 Queue overflow**

A specific code entered into the queue in lieu of the code that caused the error. This code indicates that there is no room in the queue and an error occurred but was not recorded.

### **-400 Query errors**

This is the generic query error that the 4349B cannot detect more specific errors. This code indicates only that a query error as defined in IEEE 488.2, 11.5.1.1.7 and 6.3 has occurred.

### **-410 Query INTERRUPTED**

A condition causing an interrupted query error occurred (see IEEE 488.1, 6.3.2.3); for example, a query followed by DAB or GET before a response was completely sent.

### **-420 Query UNTERMINATED**

A condition causing an unterminated query error occurred (see IEEE 488.2, 6.3.2); for example, the 4349B was addressed to talk and an incomplete program message was received.

### **-430 Query DEADLOCKED**

A condition causing an deadlocked query error occurred (see IEEE 488.2, 6.3.1.7); for example, both input buffer and output buffer are full and the 4349B cannot continue.

### **-440 Query UNTERMINATED after indefinite response**

A query was received in the same program message after an query requesting an indefinite response was executed (see IEEE 488.2, 6.5.7.5.7).



# Index

---

## A

ABORt, 4-10, 5-9  
Adrs key , 3-6  
ammeter offset voltage and input resistance  
test , 9-3  
annunciator, 3-2  
application measurement, 6-1  
arrow key, 3-7  
ASCII, 5-18, 5-40  
Auto/Hold key , 3-5  
Auto range, 3-5  
    GPIB command, 5-23  
:AVERage:COUNT  
    SENSe, 5-20  
Average key , 3-4  
:AVERage[:STATe]  
    SENSe, 5-20  
averaging rate, 3-4  
    GPIB command, 5-20  
    how to set, 2-7, 4-7

## B

backup memory, 3-3  
:BEEPer  
    SYSTem, 5-27  
beeper, 3-11  
    GPIB command, 5-10, 5-27  
    how to set, 2-10, 4-7  
:BEEPer:CONDition  
    CALCulate{1|2|3|4}:LIMit, 5-10  
:BEEPer[:STATe]  
    CALCulate{1|2|3|4}:LIMit, 5-10  
Bk Sp key , 3-8  
BLUE shift Key , 3-7  
<Boolean>, 5-6  
bus trigger mode, 3-6, 4-11  
    GPIB command, 5-29

## C

:CALCulate{1|2|3|4}:LIMit:BEEPer:COND,  
    4-8, 5-10  
:CALCulate{1|2|3|4}:LIMit:BEEPer[:STATe],  
    4-8, 5-10  
:CALCulate{1|2|3|4}:LIMit:CLEAr, 4-8,  
    5-11

:CALCulate{1|2|3|4}:LIMit:LOWer[:DATA],  
    4-8, 5-11  
:CALCulate{1|2|3|4}:LIMit:LOWer:STATe,  
    4-8, 5-11  
:CALCulate{1|2|3|4}:LIMit:UPPer[:DATA],  
    4-8, 5-12  
:CALCulate{1|2|3|4}:LIMit:UPPer:STATe,  
    4-8, 5-12  
:CALCulate{1|2|3|4}:PATH?, 4-8, 5-12  
CALCulate subsystem, 5-10  
calculation sheet , 9-12  
channel, 3-3  
    how to select, 2-6  
Ch key, 3-4  
cleaning , 1-8  
:CLEAr  
    CALCulate{1|2|3|4}:LIMit, 5-11  
\*CLS, 4-13, 5-30  
Command Error (CME) Bit, 5-35  
comparator  
    GPIB command, 5-10  
    how to use, 2-12, 4-8  
    limit, 3-5  
    on/off, 3-8  
Comparator key, 3-8  
Comparator Limit key , 3-5  
Config key , 3-11  
contact check, 3-9  
    how to perform, 4-7  
    how to set, 2-8  
contact check , 5-21  
Contact Check Fail, C-1  
contact check functional test , 9-25  
:CONtact:DATA{1|2|3|4}?  
    SENSe, 5-21  
:CONtact:LIMit{1|2|3|4}?  
    SENSe, 5-21  
:CONtact:OFFSet{1|2|3|4}  
    SENSe, 5-22  
:CONtact:VERify  
    SENSe, 5-22  
Cont Chk key, 3-9  
:CONTinuous  
    INITiate, 5-19  
controller, 3-18  
:CORRection:COLLect[:ACQuire]

- SENSe, 5-20
- :CORRection:DATA{1|2|3|4}?
- SENSe, 5-21
- :CORRection[:STATe]
- SENSe, 5-21
- :CURRent:APERture
- SENSe, 5-22
- current measurement accuracy test , 9-6
- :CURRent:RANGe{1|2|3|4}:AUTO
- SENSe, 5-23
- :CURRent:RANGe{1|2|3|4}[:UPPer]
- SENSe, 5-23

## D

- DATA, 5-13
- [:DATA]?
- DATA, 5-13
- data buffer, 4-12, 5-13
- :DATA[:DATA]?, 4-12, 5-13
- :DATA:FEED, 4-12, 5-14
- :DATA:FEED:CONTRol, 4-12, 5-14
- <data\_handle>, 5-6, 5-14
- :DATA:POINts, 4-12, 5-14
- DATA subsystem, 5-13
- DBUF, 5-13
- :DELay
- TRIGger, 5-29
- Delay key , 3-7
- Device-Dependent Error Bit, 5-35
- :DIGit
- DISPlay:WINDow:TEXT1, 5-16
- display digits, 2-14
- :DISPlay:ENABLe, 4-8
- display mode, 2-13, 2-14, 3-5
- GPIB command, 5-15
- DISPlay subsystem, 5-15
- :DISPlay:WINDow{1|2|3|4}[:STATe], 4-8, 5-15
- :DISPlay:WINDow{1|2|3|4}:TEXT1:DIGit, 5-16
- :DISPlay:WINDow{1|2|3|4}:TEXT1:PAGE, 4-8, 5-15
- :DISPlay:WINDow{1|2|3|4}:TEXT2:PAGE, 5-16
- Disp Mode key , 3-5

## E

- E key , 3-8
- Enter key , 3-8
- :ERRor?
- SYSTem, 5-27
- error queue, 5-35
- \*ESE, 4-13, 5-30
- \*ESE?, 4-13, 5-30
- \*ESR?, 4-13, 5-30

- Execution Error Bit, 5-35
- External Trigger input, 3-12
- external trigger mode, 2-12, 3-6, 4-11
- GPIB command, 5-29
- external voltage source, 2-2

## F

- :FEED
- DATA, 5-14
- :FEED:CONTRol
- DATA, 5-14
- FETCh?, 4-10, 5-17
- :FORMat, 4-12, 5-18
- FORMat subsystem, 5-18
- :FUNCTion
- SENSe, 5-23

## G

- GET, 4-10
- GPIB address, 3-6
- how to set, 2-15
- GPIB interface, 3-18
- Group Execution Trigger, 4-10

## H

- handler interface, 3-14
- handler interface functional test , 9-23
- high throughput measurement, 6-2
- Hold range, 3-5

## I

- idle state, 5-38
- \*IDN?, 5-30
- IEEE 754 Floating Point Format, 5-41
- :IMMediate
- INITiate, 5-19
- SOURce:VOLTage, 5-24
- SYSTem:BEEPPer, 5-27
- TRIGger, 5-29
- :INITiate:CONTinuous, 4-10, 5-19
- :INITiate[:IMMediate], 4-10, 5-19
- initiate state, 5-39
- INITiate subsystem, 5-19
- installation, 2-3
- internal trigger mode, 2-12, 3-6, 4-10
- GPIB command, 5-29

## K

- key lock, 2-15, 3-9, 4-7
- GPIB command, 5-27
- Key Lock key , 3-9
- :KLOCK
- SYSTem, 5-27

## L

- Lcl key , 3-6
- :LFrequency
  - SYSTEM, 5-27
- :LIMit:BEEPer:CONDition
  - CALCulate{1|2|3|4}, 5-10
- :LIMit:BEEPer[:STATe]
  - CALCulate{1|2|3|4}, 5-10
- :LIMit:CLEar
  - CALCulate{1|2|3|4}, 5-11
- :LIMit:LOWer[:DATA]
  - CALCulate{1|2|3|4}, 5-11
- :LIMit:LOWer:STATe
  - CALCulate{1|2|3|4}, 5-11
- :LIMit:STATe
  - CALCulate{1|2|3|4}, 5-11
- :LIMit:UPPer[:DATA]
  - CALCulate{1|2|3|4}, 5-12
- :LIMit:UPPer:STATe
  - CALCulate{1|2|3|4}, 5-12
- LINE frequency, 1-12, 3-11
  - GPIB command, 5-27
  - how to set, 4-5
- LINE Fuse Holder , 3-13
- LINE switch, 3-3
- LINE Voltage Selector , 3-13
- listener, 3-18
- local mode, 2-15, 3-6
- :LOWer[:DATA]
  - CALCulate{1|2|3|4}:LIMit, 5-11
- \*LRN?, 4-9, 5-30

## M

- manual changes, A-1
- manual trigger mode, 2-12, 3-6, 4-10
  - GPIB command, 5-29
- MAV (Message Available) Bit, 5-34
- Max key , 3-8
- Meas Prmtr key , 3-4
- Meas Time key , 3-4
- measurement parameter, 3-4
  - GPIB command, 5-23
  - how to select, 2-5, 4-5
- measurement range, 3-5
  - GPIB command, 5-23
  - how to select, 2-6, 4-6
- Measurement Settings, 2-14, 3-4
- measurement time mode, 3-4
  - GPIB command, 5-22
  - how to select, 2-7
  - how to set, 4-6
- Min key , 3-8
- multi test voltages measurement, 6-5

## N

- N.C., C-1
- <numeric\_value>, 5-6

## O

- \*OPC, 4-8, 5-30
- \*OPC?, 4-8, 5-31
- OPEN correction, 3-9
  - GPIB command, 5-20, 5-21
  - how to perform, 2-5, 4-5
- OPEN correction data, 5-21
- Open key , 3-9
- Operation Complete Bit, 5-35
- Operation Status Register, 5-37
- \*OPT?, 5-31
- OVER LOAD, C-1
- OVLd, C-1

## P

- :PAGE
  - DISPLAY:WINDow:TEXT1, 5-15
  - DISPLAY:WINDow:TEXT2, 5-16
- performance test record , 9-17
- :POINts
  - DATA, 5-14
- power cable , 1-9
- Power Cord Receptacle , 3-13
- :PRESet
  - STATus, 5-26
  - SYSTEM, 5-28

## Q

- Query Error Bit, 5-35
- Questionable Status Register, 5-37

## R

- \*RCL, 4-9, 5-31
- Rcl key, 3-7
- real data format, 4-12, 5-18, 5-41
- recall, 3-7
  - instrument settings, 2-11
- reset, 3-10
  - GPIB command, 5-28, 5-31
  - how to, 2-5, 4-5
- Reset key , 3-10
- resistance measurement accuracy test , 9-9
- RQS (Request Service) Bit, 5-34
- \*RST, 4-5, 5-31

## S

- sample program, 6-1
- \*SAV, 4-9, 5-31
- save, 3-7
  - instrument settings, 2-11
- Save key, 3-7

self-test, 3-11  
 GPIB command, 5-32  
 how to perform, 2-16, 4-13  
 :SENSe:AVERage:COUnT, 4-7, 5-20  
 :SENSe:AVERage[:STATe], 4-7, 5-20  
 :SENSe:CORREction:COLLect, 4-5, 5-20  
 :SENSe:CORREction:DATA{1|2|3|4}?, 5-21  
 :SENSe:CORREction[:STATe], 4-5, 5-21  
 :SENSe:CURRent:APERture, 4-6, 5-22  
 :SENSe:CURRent:RANGe{1|2|3|4}:AUTO,  
 4-6, 5-23  
 :SENSe:CURRent:RANGe{1|2|3|4}[:UPPer],  
 4-6, 5-23  
 :SENSe:FUNCTion, 4-5, 5-23  
 :SENSe:RESistance:CONtact:VERify, 4-7  
 SENSe subsystem, 5-20  
 <sensor\_function>, 5-6, 5-23  
 serial number, A-2  
 Service Request Enable Register, 5-33  
 Service Request (SRQ), 5-33  
 Show Setting Key, 3-4  
 :SOURce  
 TRIGger, 5-29  
 SOURce subsystem, 5-24  
 :SOURce:VOLTage{1|2|3|4}, 4-6, 5-24  
 specifications, 8-2  
 SPOLL, 4-13  
 \*SRE, 4-13, 5-31  
 \*SRE?, 4-13, 5-31  
 SRQ, 5-33  
 Standard Event Status Register, 5-35  
 Standard Event Status Register Summary  
 Bit, 5-34  
 Standard Operation Status Group, 5-36  
 status, 5-33  
 how to report, 4-13  
 Status Byte Register, 5-34  
 :STATus:OPERation:CONDition?, 4-13,  
 5-25  
 :STATus:OPERation:ENABle, 4-13, 5-25  
 :STATus:OPERation[:EVENT]?, 4-13, 5-25  
 :STATus:PRESet, 4-13, 5-26  
 :STATus:QUESTionable:CONDition?, 5-26  
 :STATus:QUESTionable:ENABle, 4-13, 5-26  
 :STATus:QUESTionable[:EVENT]?, 4-13,  
 5-26  
 STATus subsystem, 5-25  
 \*STB?, 4-13, 5-32  
 stray capacitance, 5-21

suffix, 5-7  
 supplemental performance characteristics,  
 8-7  
 :SYSTem:BEEPer[:IMMediate], 4-7, 5-27  
 :SYSTem:BEEPer:STATe, 4-7, 5-27  
 :SYSTem:ERRor?, 5-27  
 :SYSTem:KLOCK, 4-7, 5-27  
 :SYSTem:LFRequency, 4-5, 5-27  
 :SYSTem:PRESet, 4-5, 5-28  
 SYSTem subsystem, 5-27

## T

talker, 3-18  
 talk only mode, 2-15, 3-6  
 Test Equipment , 9-1  
 test leads, 2-2  
 \*TRG, 4-10, 5-32  
 trigger  
 how to, 2-12, 4-10  
 :TRIGger:DELay, 4-7, 5-29  
 trigger delay time, 3-7  
 GPIB command, 5-29  
 how to set, 2-7, 4-7  
 :TRIGger[:IMMediate], 4-10, 5-29  
 trigger mode, 3-6  
 GPIB command, 5-29  
 :TRIGger:SOURce, 4-10  
 TRIGger subsystem, 5-29  
 Trig key , 3-6  
 Trig Mode key , 3-6  
 \*TST?, 4-13, 5-32

## U

:UPPer[:DATA]  
 CALCulate{1|2|3|4}:LIMit, 5-12

## V

:VERSion?  
 SYSTem, 5-28  
 :VOLTage{1|2|3|4}  
 SOURce, 5-24  
 Voltage Entry key, 3-4  
 voltage value, 3-4  
 GPIB command, 5-24  
 how to enter, 2-6, 4-6

## W

\*WAI, 4-8, 5-32



## REGIONAL SALES AND SUPPORT OFFICES

*For more information about Agilent Technologies test and measurement products, applications, services, and for a current sales office listing, visit our web site: <http://www.agilent.com/find/tmdir>. You can also contact one of the following centers and ask for a test and measurement sales representative.* 11/29/99

### **United States:**

Agilent Technologies  
Test and Measurement Call Center  
P.O.Box 4026  
Englewood, CO 80155-4026  
(tel) 1 800 452 4844

(fax) (61 3) 9272 0749  
(tel) 0 800 738 378 (New Zealand)  
(fax) (64 4) 802 6881

### **Canada:**

Agilent Technologies Canada Inc.  
5150 Spectrum Way  
Mississauga, Ontario  
L4W 5G1  
(tel) 1 877 894 4414

### **Asia Pacific:**

Agilent Technologies  
24/F, Cityplaza One, 1111 King's Road,  
Taikoo Shing, Hong Kong  
(tel) (852)-3197-7777  
(fax) (852)-2506-9284

### **Europe:**

Agilent Technologies  
Test & Measurement  
European Marketing Organization  
P.O.Box 999  
1180 AZ Amstelveen  
The Netherlands  
(tel) (31 20) 547 9999

### **Japan:**

Agilent Technologies Japan Ltd.  
Call Center  
9-1, Takakura-Cho, Hachioji-Shi,  
Tokyo 192-8510, Japan  
(tel) (81) 426 56 7832  
(fax) (81) 426 56 7840

### **Latin America:**

Agilent Technologies  
Latin American Region Headquarters  
5200 Blue Lagoon Drive, Suite #950  
Miami, Florida 33126  
U.S.A.  
(tel) (305) 267 4245  
(fax) (305) 267 4286

### **Australia/New Zealand:**

Agilent Technologies Australia Pty Ltd  
347 Burwood Highway  
Forest Hill, Victoria 3131  
(tel) 1-800 629 485 (Australia)