

DECLARATION OF CONFORMITY

According to ISO/IEC Guide 22 and CEN/CENELEC EN 45014

Manufacturer's Name: Agilent Technologies Japan, Ltd.

Manufacturer's Address: 1-3-2, Murotani, Nishi-ku, Kobe-shi,
Hyogo, 651-2241 Japan

Declares, that the product:

Product Name: High Resistance Meter

Model Number: 4339B

Product Options: This declaration covers all options of the above product

Conforms with the following product standards:

EMC:	Standard	Limit
	IEC 61326-1:1997 +A1:1998 / EN 61326-1:1997 +A1:1998	
	CISPR 11:1997 / EN 55011:1998 / AS/NZS 2064.1/2	Group 1, Class A ^[1]
	IEC 61000-4-2:1995 / EN 61000-4-2:1995 +A1:1998	4 kV CD, 4 kV AD
	IEC 61000-4-3:1995 / EN 61000-4-3:1996 +A1:1998	3 V/m 80% AM 80 - 1000 MHz
	IEC 61000-4-4:1995 / EN 61000-4-4:1995	0.5 kV signal lines, 1 kV power lines
	IEC 61000-4-5:1995 / EN 61000-4-5:1995	0.5 kV line-line, 1 kV line-ground
	IEC 61000-4-6:1996 / EN 61000-4-6:1996	3 V 80% AM 0.15 - 80 MHz
	IEC 61000-4-11:1994 / EN 61000-4-11:1994	1 cycle, 100%
	Canada: ICES-001	
Safety:	IEC 61010-1:1990 +A1:1992 +A2:1995 / EN 61010-1:1993 +A2:1995	
	CAN / CSA C22.2 No. 1010.1-92	

Conformity / Supplementary Information:

The product herewith complies with the requirements of the Low Voltage Directive 73/23/EEC and the EMC Directive 89/336/EEC (including 93/68/EEC) and carries the CE-marking accordingly (European Union).

LEDs in this product are Class 1 in accordance with EN 60825-1:1994.

^[1] The product was tested in a typical configuration with Agilent Technologies test systems.

Kobe, Japan Dec. 15, 2000
Date

Name Koichi Yanagawa / Quality Engineering Manager

For further information, please contact your local Agilent Technologies sales office, agent or distributor.

Safety Summary

When you notice any of the unusual conditions listed below, immediately terminate operation and disconnect the power cable.

Contact your local Agilent Technologies sales representative or authorized service company for repair of the instrument. If you continue to operate without repairing the instrument, there is a potential fire or shock hazard for the operator.

- Instrument operates abnormally.
- Instrument emits abnormal noise, smell, smoke or a spark-like light during the operation.
- Instrument generates high temperature or electrical shock during operation.
- Power cable, plug, or receptacle on instrument is damaged.
- Foreign substance or liquid has fallen into the instrument.

WARNING

HIGH VOLTAGE SHOCK HAZARD (MAX. 1000 Vdc)

The HP 4339B High Resistance Meter forces dangerous voltage up to 1000 Vdc on the UNKNOWN terminals, or the electrodes of the accessory (the HP 16008B Resistivity Cell, the HP 16339A Test Fixture, or the HP 16117B,C Test Leads) which is connected to the HP 4339B. (When the High Voltage indicator on the front panel is ON, the HP 4339B outputs dangerous voltage more than 42 Vdc.) To prevent an electrical shock, observe the following safety precautions.

- Operate the HP 4339B and the accessories following the description on their Operation (and Service) Manuals, especially for the description written in the Warnings.
- Do not touch the UNKNOWN terminal or the electrode, when the V Output indicator on the front panel is ON, that is, when the HP 4339B forces voltage.
- Perform the operation tests of the interlock function and the High Voltage indicator at least once a day, before using the HP 4339B. Refer to "Checking Procedure" in chapter 3 of the Operation and Service Manual of the each accessory for the operation tests procedures.
- Warn workers around the HP 4339B about dangerous conditions.

警告

高電圧感電注意 (最大 1000 Vdc)

HP 4339B ハイ・レジスタンス・メータは、UNKNOWN 端子、または、HP 4339B に接続されたアクセサリ (HP 16008B レジスティビティ・セル、HP 16339A テスト・フィクスチャ、または、HP 16117B,C テスト・リード) の電極に危険電圧 (最大 1000 Vdc) を出力することがあります。この危険電圧による感電を避けるために、下記の事項を必ず実施してください。

- HP 4339B を操作するときには、必ずマニュアルの記述に従ってください。特に、「警告」に書かれていることは必ず守ってください。
- 電圧出力中 (フロント・パネルの V Output インディケータの点灯中) は、UNKNOWN 端子、または、アクセサリの電極に触れないでください。
- 測定に使用するアクセサリを使って、測定開始前に、Interlock 機能、High Voltage インディケータの動作テストを行ってください。(1日1回以上) 手順は、各アクセサリの Operation and Service Manual の3章の"Checking Procedure"項を参照してください。
- 周囲の他の作業者に対しても、危険電圧を出力することがあることを知らせ、UNKNOWN 端子、または、アクセサリの電極に触れないように注意してください。

AVVERTENZA

PERICOLO DI SCOSSA AD ALTA TENSIONE (MAX. 1000 Vdc)

L'ohmmetro HP 4339B emette pericolosi livelli di tensione che possono raggiungere i 1000 Vdc sui terminali UNKNOWN, o sugli elettrodi degli impianti di prova o cavi di prova (Cella di resistività HP 16008B, Impianto di prova HP 16339A, o Cavi di prova C HP 16117B) che sono collegati all'HP 4339B. (Quando l'indicatore High Voltage sul pannello anteriore è attivato (ON), l'HP 4339B emette tensione elettrica pericolosa (più di 42 Vdc)) Per prevenire una scossa elettrica, osservare le seguenti precauzioni di sicurezza.

- Usare l'HP 4339B e gli accessori secondo le istruzioni dei rispettivi Manuali d'istruzione (e Servizio), specialmente le istruzioni date nelle "Avvertenze"
- Non toccare i terminali UNKNOWN o gli elettrodi quando l'indicatore V Output o il pannello anteriore sono attivati (ON): cioè quando della tensione viene applicata all'uscita dell'HP 4339B.
- Eseguire le prove di funzionamento della funzione Interlock e dell'indicatore High Voltage almeno una volta al giorno, prima di usare l'HP 4339B. Fare riferimento al "Checking Procedure" al capitolo 3 dell'Operation and Service Manual dell'accessorio che si sta usando per le procedure della prova di funzionamento.
- Informare gli operatori che si occupano dell'HP 4339B, delle condizioni di pericolo esistenti e riferire loro ciò che è possibile fare e ciò che non lo è!

WARNUNG

LEBENSGEFÄHRLICHE HOCHSPANNUNG (MAX. 1000 V DC)



Der Hochspannungsmesser HP 4339B gibt gefährliche Hochspannung von bis zu 1000 V Gleichstrom an den Klemmen UNKNOWN oder zu den Elektroden von Testvorrichtungen oder Testleitungen aus (HP 16008B spezifische Widerstandszelle, HP 16339A Testvorrichtung oder HP 16117B, C Testleitungen), die an den HP 4339B angeschlossen sind. (Wenn die High Voltage an der Vorderseite leuchtet, gibt der HP 4339B gefährliche Spannung von mehr als 42 V Gleichstrom aus.) Um elektrische Schläge zu verhindern, immer folgende Vorsichtsmaßnahmen beachten.

- Den HP 4339B und die Zubehörteile immer entsprechend den Anweisungen in der Bedienungs- und Wartungsanleitung befolgen, und insbesondere immer die unter "Warnung" gegebenen Anweisungen befolgen.
- Niemals die Klemmen UNKNOWN oder die Elektroden berühren, wenn die Anzeige V Output an der Vorderseite leuchtet, d.h. wenn eine Spannung am Ausgang des HP 4339B anliegt.
- Die Betriebstests der Interlock-Funktion und die Anzeige High Voltage mindestens einmal täglich durchführen, bevor der HP 4339B verwendet wird. Durchführung des Betriebstests siehe "Checking procedure" in Kapitel 3 der Operation and Service Manual des verwendeten Zubehörs.
- Immer in der Nähe des HP 4339B arbeitende Personen warnen, daß eine Gefahrenquelle existiert, und Anweisungen zum richtigen Verhalten geben!



When you turn on the 4339B for the first time, confirm the power line frequency is set correctly.

1. Press  . The following menu is displayed.



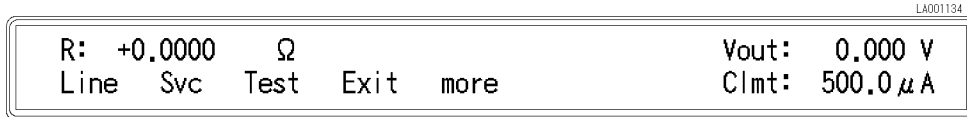

2. Press  until “more” blinks, and press .



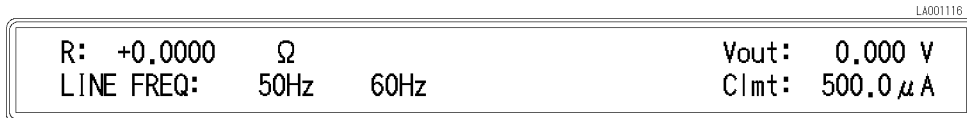

3. Press  until “Line” blinks, and press .



A blinking item means that it is currently selected.

4. If the setting does not match the power line frequency, press  to toggle the setting between “50 Hz” and “60 Hz”. Then press .

5. Press  until “Exit” blinks, and press  to exit this menu.

The power line frequency setting is stored and is not changed after reset or power-off. Once you set it, you do not need to set the line frequency again as long as the same power line frequency is being used.

Agilent 4339B High Resistance Meter

Operation Manual

SERIAL NUMBERS

This manual applies directly to instruments with serial number prefix JP1KD, or firmware revision 1.04. For additional important information about serial numbers, read “Serial Number” in Appendix A.



Agilent Technologies

Agilent Part No. 04339-90060
Printed in Japan March 2003

Ninth Edition

Notice

The information contained in this document is subject to change without notice.

This document contains proprietary information that is protected by copyright. All rights are reserved. No part of this document may be photocopied, reproduced, or translated to another language without the prior written consent of the Agilent Technologies.

Agilent Technologies Japan, Ltd.
Component Test PGU-Kobe
1-3-2, Murotani, Nishi-ku, Kobe-shi,
Hyogo, 651-2241 Japan

Manual Printing History

March 1996	First Edition (part number: 04339-90010)
December 1996	Second Edition (part number: 04339-90020)
June 1998	Third Edition (part number: 04339-90030)
August 1998	Fourth Edition (part number: 04339-90040)
July 1999	Fifth Edition (part number: 04339-90050)
March 2000	Sixth Edition (part number: 04339-90050)
January 2001	Seventh Edition (part number: 04339-90050)
September 2002	Eighth Edition (part number: 04339-90050)
March 2003	Ninth Edition (part number: 04339-90060)

Safety Summary

The following general safety precautions must be observed during all phases of operation, service, and repair of this instrument. Failure to comply with these precautions or with specific **WARNINGS** elsewhere in this manual may impair the protection provided by the equipment. In addition it violates safety standards of design, manufacture, and intended use of the instrument.

The Agilent Technologies assumes no liability for the customer's failure to comply with these requirements.

Note



4339B is designed for use in INSTALLATION CATEGORY II according to IEC 61010-1 and POLLUTION DEGREE 1 according to IEC 61010-1 and IEC 60664-1. 4339B is an INDOOR USE product.

Note



LEDs in 4339B are Class 1 in accordance with IEC60825-1.
CLASS 1 LED PRODUCT

Ground The Instrument

To avoid electric shock hazard, the instrument chassis and cabinet must be connected to a safety earth ground by the supplied power cable with earth blade.

DO NOT Operate In An Explosive Atmosphere

Do not operate the instrument in the presence of flammable gasses or fumes. Operation of any electrical instrument in such an environment constitutes a definite safety hazard.

Keep Away From Live Circuits

Operating personnel must not remove instrument covers. Component replacement and internal adjustments must be made by qualified maintenance personnel. Do not replace components with the power cable connected. Under certain conditions, dangerous voltages may exist even with the power cable removed. To avoid injuries, always disconnect power and discharge circuits before touching them.

DO NOT Service Or Adjust Alone

Do not attempt internal service or adjustment unless another person, capable of rendering first aid and resuscitation, is present.

DO NOT Substitute Parts Or Modify Instrument

Because of the danger of introducing additional hazards, do not install substitute parts or perform unauthorized modifications to the instrument. Return the instrument to a Agilent Technologies Sales and Service Office for service and repair to ensure that safety features are maintained.

Dangerous Procedure Warnings

Warnings , such as the example below, precede potentially dangerous procedures throughout this manual. Instructions contained in the warnings must be followed.

Warning



Dangerous voltages, capable of causing death, are present in this instrument. Use extreme caution when handling, testing, and adjusting this instrument.

Certification

Agilent Technologies certifies that this product met its published specifications at the time of shipment from the factory. Agilent Technologies further certifies that its calibration measurements are traceable to the United States National Institute of Standards and Technology, to the extent allowed by the Institution's calibration facility, or to the calibration facilities of other International Standards Organization members.

Warranty

This Agilent Technologies instrument product is warranted against defects in material and workmanship for a period of one year from the date of shipment, except that in the case of certain components listed in *General Information* of this manual, the warranty shall be for the specified period. During the warranty period, Agilent Technologies will, at its option, either repair or replace products that prove to be defective.

For warranty service or repair, this product must be returned to a service facility designated by Agilent Technologies. Buyer shall prepay shipping charges to Agilent Technologies and Agilent Technologies shall pay shipping charges to return the product to Buyer. However, Buyer shall pay all shipping charges, duties, and taxes for products returned to Agilent Technologies from another country.

Agilent Technologies warrants that its software and firmware designated by Agilent Technologies for use with an instrument will execute its programming instruction when properly installed on that instrument. Agilent Technologies does not warrant that the operation of the instrument, or software, or firmware will be uninterrupted or error free.

Limitation Of Warranty

The foregoing warranty shall not apply to defects resulting from improper or inadequate maintenance by Buyer, Buyer-supplied software or interfacing, unauthorized modification or misuse, operation outside the environmental specifications for the product, or improper site preparation or maintenance.

No other warranty is expressed or implied. Agilent Technologies specifically disclaims the implied warranties of merchantability and fitness for a particular purpose.

Exclusive Remedies

The remedies provided herein are buyer's sole and exclusive remedies. Agilent Technologies shall not be liable for any direct, indirect, special, incidental, or consequential damages, whether based on contract, tort, or any other legal theory.

Assistance

Product maintenance agreements and other customer assistance agreements are available for Agilent Technologies products.

For any assistance, contact your nearest Agilent Technologies Sales and Service Office. Addresses are provided at the back of this manual.

Safety Symbols

General definitions of safety symbols used on equipment or in manuals are listed below.



Instruction manual symbol: the product is marked with this symbol when it is necessary for the user to refer to the instruction manual.



Alternating current.



Direct current.



On (Supply).



Off (Supply).

Warning



This **Warning** sign denotes a hazard. It calls attention to a procedure, practice, condition or the like, which, if not correctly performed or adhered to, could result in injury or death to personnel.

Caution



This **Caution** sign denotes a hazard. It calls attention to a procedure, practice, condition or the like, which, if not correctly performed or adhered to, could result in damage to or destruction of part or all of the product.

Note



Note denotes important information. It calls attention to a procedure, practice, condition or the like, which is essential to highlight.



Affixed to product containing static sensitive devices use anti-static handling procedures to prevent electrostatic discharge damage to component.



Caution, risk of electric shock : Terminals which may be supplied from the interior of the equipment at a voltage exceeding 1 kV, or allow connection to a voltage exceeding 1 kV are marked with this symbol.

4339B

Herstellerbescheinigung

GERSCHEMISSION

LpA < 70 dB
am Arbeitsplatz
normaler Betrieb
nach DIN 45635 T. 19

Manufacturer's Declaration

ACOUSTIC NOISE EMISSION

LpA < 70 dB
operator position
normal operation
per ISO 7779

Contents of this Manual

Chapter 1

Provides the product overview and basic measurement procedure. First time users of the 4339B should read this chapter first.

Chapter 2

Shows how to operate the 4339B from its front panel. Refer to this chapter when you wish to learn about operations using the front panel keys.

Chapter 3

Describes all functions of this instrument. Refer to this chapter when you wish to learn about the functions of the front and rear panel keys and terminals.

Chapter 4

Shows how to remotely operate the 4339B. Refer to this chapter when you wish to learn about the procedures for remotely operating the 4339B via the GPIB.

Chapter 5

Contains complete information on remotely operating the 4339B via the GPIB. Refer to this chapter when you wish to learn about the GPIB commands, status reporting mechanism, trigger system, and data transmission format.

Chapter 6

Provides a measurement example using the 4339B.

Chapter 7

Provides information for effective operations.

Chapter 8

Provides specifications, reference data, and other general information.

Chapter 9

Describes how to verify the specifications.

4339B

Appendix A

Contains information on using the 4339Bs which were manufactured before this manual was printed.

Appendix B





Contains information which is required for using the handler interface. Before using the handler interface, read this appendix and set the handler interface input/output signal.

Appendix C

The summary of operations when the 4339B detects OVL (Overload), Over-Current (exceeding current limit), or N.C. (No-Contact).

Contents

1. Getting Started



























Introduction	1-1
Overview	1-2
Features	1-2
Accessories Available	1-3
Front Panel	1-4
Display	1-6
Rear Panel	1-7
Initial Inspection	1-8
Providing clearance to dissipate heat at installation site	1-8
Instruction for Cleaning	1-9
Power Cable	1-10
Preparation for Use	1-12
Power Requirements	1-12
 Fuse	1-12
 Turning ON the 4339B	1-13
Power-On Self Test	1-14
Using Front Panel Keys	1-15
Direct Execution Type Keys	1-15
Toggle Type Keys	1-15
Selection Type Keys	1-15
Value Setup Type Keys	1-16
Value Setup Using Numeric Keys	1-16
Value Setup Using Maximum and Minimum Keys	1-17
Value Setup Using Down and Up Arrow Keys	1-17
Value Change Using Back Space Key	1-17
Basic Operation	1-18
 Connecting Test Fixture	1-19
Floating DUT Measurement	1-19
Grounded DUT Measurement	1-19
Resetting 4339B	1-20
Performing Calibration	1-20
Setting Test Voltage	1-21
 Performing OPEN Correction	1-22
Selecting Measurement Parameter	1-23
Selecting Measurement Range	1-23
Auto Range mode	1-23
Hold Range mode	1-23
Changing the Range in Hold Range mode	1-23
 Applying Test Voltage	1-24























 Turning OFF Test Voltage	1-24
--	------



2. Operating the 4339B

Introduction	2-1
Measurement Configuration	2-2
Selecting the Measurement Time Mode	2-2
Setting the Averaging Rate	2-2
Setting the Trigger Delay Time	2-2
Setting the Parameters for Resistivity Measurement	2-3
Entering Thickness of the DUT	2-3
Setting the Electrode Size	2-3
Making a Measurement	2-5
Triggering a Measurement	2-5
Using the Comparator Function	2-5
Displaying Deviation Data	2-7
Setting the Reference Value	2-7
Selecting the Deviation Display Mode	2-8
Using the Measurement Sequence Function	2-9
Selecting the Measurement Sequence Mode	2-9
Setting the Measurement Sequence Mode Parameters	2-9
Setting Time Display Function	2-10
 Starting Measurement Sequence	2-11
Aborting Measurement Sequence	2-11
Setting Contact Check	2-12
Reading the Limit Data of Contact Check Function	2-13
Reading the Capacitance Data at DUT Measurement	2-13
Setting Current Limit	2-14
Setting Current Monitor	2-14
Setting Beeper Mode	2-14
Setting Display Mode and Display Format	2-16
Changing Measurement Settings Display Mode	2-17
Saving and Recalling Instrument Settings	2-18
Locking Out the Front Panel Keys	2-18
Selecting Local Mode	2-18
Setting the GPIB Address	2-19
Printing Measurement Data	2-19
Setting the Offset-Error Canceling Function	2-19
Testing the 4339B	2-20
Performing a Self-Test	2-20
Testing the Front Panel Key's Functionality	2-21
If You Have a Problem	2-22
If the Display is Blank and the 4339B Appears Dead	2-22
If an Error Message is Displayed	2-22
If the 4339B does not Accept Any Key Input	2-22
If the Indicated Value is not Stable	2-22
If You Find Yourself Lost When Operating the 4339B	2-22

3. Function Reference

Introduction		3-1
Front Panel		3-2
Display		3-2
LINE Switch		3-3
Interlock Connector		3-3
 UNKNOWN Terminals		3-4
 High Voltage Indicator		3-4
 V Output Key 		3-4
V Output Indicator		3-5
Source Voltage key 		3-5
Current Limit Key 		3-5
Measurement Time key 		3-5
Average key 		3-5
Measurement Sequence Mode Key 		3-6
Single Mode		3-6
Continuous mode		3-6
Program Key 		3-7
Time Display Function		3-8
Measurement Parameter Key 		3-8
Electrode Size Key 		3-8
Show Setting Key 		3-10
Current Monitor Key 		3-10
Auto/Hold Range Key 		3-10
Range Setup Key 		3-10
 Trigger Key 		3-11
Sequence Abort Key 		3-11
Local Key 		3-11
Address Key 		3-11
Trigger Mode Key 		3-12
Delay Key 		3-12
Recall Key 		3-12
Save Key 		3-12
Comparator Limit Keys 		3-12
Left/Down and Right/Up Arrow Keys 		3-13
0, . . . , 9, .(point), -(minus) Keys		3-13
Shift Key		3-13
Exponential Key		3-13

Back Space Key 	3-13
Enter Key 	3-13
Minimum Key  Min 	3-13
Maximum Key  Max 	3-13
Open Key  Open 	3-14
Calibration Key  Cal 	3-14
Comparator On/Off Key  Comprtr 	3-14
Contact Check Key  Cont Chk 	3-15
Display Mode Key  Disp Mode 	3-16
Key Lock Key  Key Lock 	3-16
Reset Key  Reset 	3-17
Configuration Key  Config 	3-18
Rear Panel	3-20
External Trigger	3-20
LINE Fuse Holder	3-21
LINE Voltage Selector	3-21
Power Cord Receptacle	3-21
Power Cord	3-21
Serial Number Plate	3-21
Handler Interface	3-22
Specifications	3-22
GPIB Interface	3-25
Theory of Operation	3-26
Overall Measurement Theory	3-26
Overall Block Diagram	3-27
Grounded and Ungrounded DUT Measurement Configuration	3-28
4. Remote Operation	
Introduction	4-1
Getting Started	4-2
Input/Output Statements	4-2
Reading the GPIB Address	4-2
Sending a Remote Command	4-2
Returning to Local Mode	4-2
Query Commands	4-3
Getting Data from the 4339B	4-3
To Control the 4339B from an External Computer	4-4
To Set Up the 4339B	4-5
To Reset the 4339B	4-5
To Set the Power LINE Frequency	4-5
To Select the Measurement Parameter	4-5
To Set the Test Voltage	4-5
 To Apply the Test Voltage	4-6
To Set the Current Limit	4-6
To Select Measurement Time Mode	4-6
To Perform Calibration	4-6
To Perform OPEN Correction	4-7
To Select the Measurement Range	4-7





To Set the Averaging Rate	4-7
To Set Trigger Delay Time	4-7
To Set the Parameters for Resistivity Measurements	4-8
To Set Beeper Mode	4-8
To Lock Out the Front Panel Keys	4-8
To Check Contact Integrity at the Test Fixture	4-8
To Use the Comparator Function	4-9
To Display a Deviation Measurement	4-9
To Set the Offset-Error Canceling Function	4-9
To Wait Until Previously Sent Commands are Completed	4-9
To Get the Current Instrument Settings	4-10
To Save and Recall Instrument Settings	4-10
To Trigger a Measurement	4-11
Waiting For Completion Of Measurement (detecting completion of measurement)	4-12
Sample program	4-13
Reading Out Measured Result	4-14
Reading out measured result using *TRG command	4-15
Reading out measured result using :FETC? command	4-19
Data Retrieval	4-23
To Retrieve Data Efficiently	4-24
To Use Data Buffer	4-24
 To Perform a Measurement Sequence	4-25
Other Features	4-26
To Test the 4339B	4-26
To Read the Error Queue	4-26
To Report the Instrument's Status	4-26
 Sample Program	4-28
If You Have a Problem	4-30
If the 4339B Hangs Up When You Send the ABORt Command	4-30

5. GPIB Reference

Introduction	5-1
GPIB Commands	5-1
Common Commands	5-1
Subsystem Commands	5-1
Sybsystem Command Tree	5-1
Program Message Syntax	5-2
Command Abbreviations	5-2
Case	5-3
Program Message Terminator	5-3
Common Command Syntax	5-3
Subsystem Command Syntax	5-3
Parameters	5-3
Parameter Types	5-3
Multiple Messages	5-4
Query and Response Message Syntax	5-5
Command Reference	5-6
Notations	5-6
ABORt Command	5-7
:ABORt	5-7
ARM Subsystem	5-8
:ARM[:SEquence1][:LAYer]:DELay <numeric_value> [MS S]	5-9
:ARM[:SEquence1][:LAYer]:SOURce {BUS EXTernal MANual IMMediate}	5-9

CALCulate Subsystem	5-10
:CALCulate1:FORMat { REAL SRESistivity VRESistivity }	5-11
:CALCulate1:LIMit:BEEPer:CONDition { PASS FAIL }	5-11
:CALCulate1:LIMit:BEEPer[:STATe] { ON OFF 1 0 }	5-11
:CALCulate1:LIMit:CLEar	5-11
:CALCulate1:LIMit:FAIL?	5-12
:CALCulate1:LIMit:LOWer[:DATA] <numeric_value>	5-12
:CALCulate1:LIMit:LOWer:STATe { ON OFF 1 0 }	5-12
:CALCulate1:LIMit:STATe { ON OFF 1 0 }	5-12
:CALCulate1:LIMit:UPPer[:DATA] <numeric_value>	5-12
:CALCulate1:LIMit:UPPer:STATe { ON OFF 1 0 }	5-12
:CALCulate1:MATH:EXPRession:CATalog?	5-13
:CALCulate1:MATH:EXPRession:NAME { DEV PCNT }	5-13
:CALCulate1:MATH:STATe { ON OFF 1 0 }	5-13
:CALCulate1:PATH?	5-13
:CALCulate1:RESistivity:EARea <numeric_value >	5-13
:CALCulate1:RESistivity:EPERimeter <numeric_value >	5-13
:CALCulate1:RESistivity:GLENght <numeric_value >	5-14
:CALCulate1:RESistivity:STHickness <numeric_value >	5-14
:CALCulate2:MATH:STATe {ON OFF 1 0}	5-14
:CALCulate3:FORMat {SEC TPCNT}	5-14
:CALCulate3:MATH:STATe {ON OFF 1 0}	5-14
:CALCulate3:DIREction {UP DOWN}	5-14
:CALCulate3:BEEPer {ON OFF 1 0}	5-15
CALibration Subsystem	5-16
:CALibration[:ALL]?	5-16
:CALibration:AUTO {ON OFF 1 0}	5-16
DATA Subsystem	5-17
:DATA[:DATA] REF,<numeric_value>	5-17
:DATA[:DATA]? DBUF	5-17
:DATA[:DATA]? IMON	5-18
:DATA[:DATA]? TMON	5-18
:DATA:FEED DBUF,<data_handle>	5-18
:DATA:FEED:CONTrol DBUF,{ ALWays NEVer }	5-18
:DATA:POINts DBUF,<numeric_value>	5-18
DISPlay Subsystem	5-19
:DISPlay[:WINDow][:STATe] {ON OFF 1 0}	5-19
:DISPlay[:WINDow]:TEXT1:DIGit {3 4 5}	5-19
:DISPlay[:WINDow]:TEXT1:PAGE {1 2}	5-19
:DISPlay[:WINDow]:TEXT1:PREFix {ON OFF 1 0}	5-19
:DISPlay[:WINDow]:TEXT2:PAGE {1 2 3 4 5 6}	5-20
FETCh? Query	5-21
:FETCh?	5-21
FORMat Subsystem	5-22
:FORMat[:DATA] { ASCii REAL[,64] }	5-22
INITiate Subsystem	5-23
:INITiate[:IMMediate]	5-23
:INITiate:CONTinuous { ON OFF 1 0 }	5-23
 OUTPut Subsystem	5-24
:OUTPut[:STATe] { ON OFF 1 0 }	5-24
SENSe Subsystem	5-25
[:SENSe]:AVERage:COUNt <numeric_value>	5-25
[:SENSe]:AVERage[:STATe] { ON OFF 1 0 }	5-25
[:SENSe]:CONTact:DATA?	5-26

[:SENSe]:CONtact:LIMit?	5-26
[:SENSe]:CONtact:OFFSet <numeric_value>	5-26
[:SENSe]:CONtact:VERify { ON OFF 1 0 }	5-26
[:SENSe]:CORRection:COLLect[:ACQuire] OFFset	5-26
[:SENSe]:CORRection:DATA? { OFFSet SCAPacitance }	5-27
[:SENSe]:CORRection[:STATe] { ON OFF 1 0 }	5-27
[:SENSe]:CURRent:APERture <numeric_value>[MS S]	5-27
[:SENSe]:CURRent:RANGe:AUTO { ON OFF 1 0 }	5-27
[:SENSe]:CURRent:RANGe[:UPPer] <numeric_value>[PA NA UA MA A]	5-27
[:SENSe]:FUNctIon <sensor_function>	5-28
SOURce Subsystem	5-29
:SOURce:CURRent:LIMit[:AMPLitude] <numeric_value> [MA A]	5-29
:SOURce:VOLtAge[:LEVel][:IMMediate][:AMPLitude] <numeric_value>[V KV]	5-29
STATus Subsystem	5-30
:STATus:OPERation:CONDition?	5-30
:STATus:OPERation:ENABle <numeric_value>	5-30
:STATus:OPERation[:EVENT]?	5-30
:STATus:PRESet	5-30
:STATus:QUESTionable:CONDition?	5-30
:STATus:QUESTionable:ENABle <numeric_value>	5-31
:STATus:QUESTionable[:EVENT]?	5-31
SYSTem Subsystem	5-32
:SYSTem:BEEPer[:IMMediate]	5-32
:SYSTem:BEEPer:STATe { ON OFF 1 0 }	5-32
:SYSTem:ERRor?	5-32
:SYSTem:KLOCK { ON OFF 1 0 }	5-32
:SYSTem:LFRequency <numeric_value>	5-32
:SYSTem:PRESet	5-33
:SYSTem:VERSion?	5-33
TRIGger Subsystem	5-34
:TRIGger[:SEQuence1]:COUNT <numeric_value>	5-34
:TRIGger[:SEQuence1]:DELay <numeric_value>[MS S]	5-34
:TRIGger[:SEQuence1][:IMMediate]	5-34
:TRIGger[:SEQuence1]:SOURce { BUS EXTernal INTernal MANual TIMER}	5-35
:TRIGger[:SEQuence1]:TIMer <numeric_value>[MS S]	5-36
Common Commands	5-37
*CLS	5-37
*ESE <numeric_value>	5-37
*ESE?	5-37
*ESR?	5-37
*IDN?	5-37
*LRN?	5-37
*OPC	5-37
*RCL <numeric_value>	5-38
*RST	5-38
*SAV <numeric_value>	5-38
*SRE <numeric_value>	5-38
*STB?	5-38
 *TRG	5-38
*TST?	5-39
*WAI	5-39
Status Reporting Structure	5-40
Service Request (SRQ)	5-40
Status Byte Register	5-41

Standard Event Status Register	5-42
Standard Operation Status Group	5-43
Operation Status Register	5-44
Questionable Status Register	5-44
Trigger System	5-45
4339B Trigger System Configuration	5-45
Idle State	5-46
Initiate State	5-46
ARM Event Detection State	5-46
TRIG Event Detection State	5-47
Sequence Operation State	5-47
Data Transfer Format	5-48
ASCII	5-48
REAL	5-49
Command Summary	5-50
6. Application Measurement	
Introduction	6-1
 Measuring Insulation Resistance of Capacitors	6-2
 Measuring Resistivity of Insulation Materials	6-5
 Measuring Insulation Resistance Time Characteristics of Electro-Mechanical Components	6-9
7. Measurement Basics	
Introduction	7-1
Insulation Resistance Measurement	7-2
Residual Charge Effect	7-2
Absorption Phenomena	7-2
Voltage Coefficient and Temperature Coefficient	7-2
Shielding	7-2
Resistivity	7-3
Volume Resistivity	7-3
Surface Resistivity	7-4
 High Capacitance DUT Measurement	7-5
8. Specifications	
Specifications	8-2
Measurement Parameters	8-2
Measurement Conditions	8-2
DC Test Voltage (Vs)	8-2
Ammeter	8-2
Test Cable Length	8-2
Measurement Time Mode	8-2
Ranging	8-2
Averaging	8-2
Trigger Mode	8-3
Trigger Delay Time	8-3
Measurement Range	8-3
Measurement Accuracy	8-4
Measurement Support Functions	8-6

Display	8-6
Correction	8-6
Test Sequence Program:	8-6
Mathematical Functions	8-6
Comparator	8-6
Contact Check	8-6
GPIB Interface	8-6
Handler Interface	8-6
Save/Recall	8-6
Continuous Memory Capability	8-7
Key Lock	8-7
General	8-7
Power Requirements	8-7
Operating Temperature, Humidity, and Altitude	8-7
Storage Temperature, Humidity, and Altitude	8-7
EMC	8-7
Safety	8-7
Dimensions	8-7
Weight	8-7
Supplemental Performance Characteristics	8-8
Typical Measurement Accuracy	8-8
Measurement Time	8-8
DC Test Voltage Settling	8-9
DC Test Voltage Output Resistance	8-9
Continuous Memory Duration	8-9

9. Maintenance

Introduction	9-1
Test Equipment	9-1
Performance Tests	9-2
Introduction	9-2
Test Equipment	9-2
Calculation Sheet	9-2
Performance Test Record	9-3
Calibration Cycle	9-3
⚠ Source Voltage Accuracy Test	9-4
Specification	9-4
Test Equipment	9-4
Procedure	9-4
Ammeter Offset Voltage and Input Resistance Test	9-6
Specification	9-6
Test Equipment	9-6
Procedure	9-6
Ammeter Offset Voltage Test	9-6
Ammeter Input Resistance Test	9-7
Current Measurement Accuracy Test	9-8
Specification	9-8
Test Equipment	9-8
Procedure	9-8
⚠ Resistance Measurement Accuracy Test	9-12
Specification	9-12
Test Equipment	9-12
Procedure	9-12

Resistance Measurement Accuracy Test (Floating Device)	9-12
Resistance Measurement Accuracy Test (Grounded Device)	9-15
Calculation Sheet	9-17
Source Voltage Accuracy Test	9-17
Ammeter Input Resistance Test	9-17
RC Box Calibration Values	9-17
Current Measurement Accuracy Test	9-18
Resistance Measurement Accuracy Test	9-18
Performance Test Record	9-19
Source Voltage Accuracy Test	9-19
Ammeter Offset Voltage and Input Resistance Test	9-19
Current Measurement Accuracy Test	9-20
Resistance Measurement Accuracy Test	9-20
Functional Test	9-21
Introduction	9-21
Test Equipment	9-21
Handler Interface Functional Test	9-22
Test Equipment	9-22
Procedure	9-22
Initial Setup	9-22
Key Lock Function Test	9-22
External Trigger Function Test	9-22
Handler Interface Output Test	9-23
Contact Check Functional Test	9-24
Test Equipment	9-24
Procedure	9-24

A. Manual Changes

Introduction	A-1
Manual Changes	A-1
Serial Number	A-2
Change 1	A-3
Change 2	A-3

B. Handler Interface Installation

Electrical Characteristics	B-1
Output Signals	B-1
Input Signals	B-4
Setting Up the Handler Interface Board	B-5
Tools and Fasteners	B-5
Procedure	B-5

C. Overload/Over-Current/No-Contact Operations

Messages

Out of Range	Messages-2
Warning	Messages-2
Instrument Errors	Messages-2
GPIB Errors	Messages-4

Index

Figures

1-1. Power Cable Supplied	1-11
1-2. Floating DUT Measurement Configuration	1-19
1-3. Grounded DUT Measurement Configuration	1-19
3-1. Front Panel	3-2
3-2. Sequence Mode	3-6
3-3. Offset-Error Canceling Timing Chart	3-18
3-4. Rear Panel	3-20
3-5. Required External Trigger Pulse Specification	3-20
3-6. Pin Assignment for Handler Interface Connector	3-22
3-7. Timing Diagram	3-24
3-8. Simplified Model of Impedance Measurement	3-26
3-9. 4339B Overall Block Diagram	3-27
3-10. Ungrounded and Grounded DUT Measurement	3-28
4-1. Simple Program Example	4-4
4-2. SRQ generation sequence (when measurement finishes)	4-12
4-3. Detecting the completion of measurement using SRQ	4-13
4-4. Reading out the measured result in ASCII transfer format by using the *TRG command	4-16
4-5. Reading out the measured result in binary transfer format using *TRG command	4-18
4-6. Reading out the measured result in ASCII transfer format using the :FETC? command	4-20
4-7. Reading out measured result in binary transfer format using :FETC? command	4-22
4-8. Sample Program	4-29
5-1. Proper Use of the Colon and Semicolon	5-2
5-2. Status Reporting Structure	5-40
5-3. Status byte Register	5-41
5-4. Standard Event Status Register	5-42
5-5. Standard Operation Status Group Structure	5-43
5-6. Trigger System Configuration	5-45
5-7. Inside an ARM Event Detection State	5-46
5-8. Inside a TRIG Event Detection State	5-47
5-9. NR1 Format	5-48
5-10. NR2 Format	5-48
5-11. NR3 Format	5-48
5-12. Real Data Format	5-49
6-1. Measurement Configuration	6-2
6-2. Chip Capacitor Binding	6-3
6-3. Measurement Configuration	6-5
6-4. Resistivity Cell Setup	6-6
6-5. Measurement Configuration	6-9
6-6. Clipping Opened Switch	6-10
6-7. Printed Results	6-11
7-1. Volume Resistivity	7-3
7-2. Surface Resistivity	7-4
7-3. Capacitance Measurement Configuration	7-7
9-1. Source Voltage Accuracy Test Setup	9-4

9-2. Ammeter Offset Voltage Test Setup	9-6
9-3. RC Box Connection	9-7
9-4. Current Measurement Accuracy Test Setup	9-9
9-5. RC Box Connection	9-10
9-6. Resistance Measurement Accuracy Test Setup (Floating)	9-13
9-7. RC Box Connection (Floating)	9-14
9-8. RC Box Connection for $10^{11} \Omega$ Resistor	9-14
9-9. Resistance Measurement Accuracy Test Setup (Grounded)	9-15
9-10. RC Box Connection (Grounded)	9-16
9-11. Handler Interface Functional Test Setup	9-22
9-12. Handler Interface Output Order	9-23
9-13. Contact Check Functional Test Setup	9-24
9-14. Contact Check Functional Test Setup	9-25
A-1. Serial Number Plate	A-2
B-1. Handler Interface Comparison Output Signals Diagram	B-2
B-2. Handler Interface Control Output Signals Diagram	B-3
B-3. Handler Interface Input Signal Diagram	B-4
B-4. Top View of 4339B with Cover Removed	B-6
B-5. A1 Main Board	B-8

Tables

1-1. Power Voltage Selector Setting	1-12
2-1. Value a	2-12
2-2. Value b	2-13
3-1. Interlock Condition for 16008B and 16339A	3-3
3-2. Interlock Condition for 16117B Low Noise Test Leads	3-3
3-3. Reset Settings	3-17
3-4. Contact Assignment for Comparator Function	3-23
3-5. GPIB Interface Capability	3-25
5-1. Selection of ARM Source and Trigger Source	5-35
5-2. Status Byte Assignments	5-41
5-3. Standard Event Status Register Assignments	5-42
5-4. Operation Status Condition Register Assignments	5-44
5-5. Operation Status Event Register Assignments	5-44
5-6. Common Commands	5-50
5-7. Subsystem Commands	5-50
7-1. Maximum Measurable Capacitance	7-5
7-2. Limit Output Resistance for Each Range	7-5
7-3. Appropriate Output Resistance for Range	7-6
8-1. Measurement Accuracy	8-4
9-1. Required Equipment	9-1
9-2. Source Voltage Accuracy Test Settings	9-5
9-3. Current Measurement Accuracy Test Settings	9-11
9-4. Resistance Measurement Accuracy Test Settings	9-15
9-5. Resistance Measurement Accuracy Test Settings (Grounded)	9-16
A-1. Manual Changes by Serial Number	A-1
A-2. Manual Changes by ROM Version	A-1
A-3. OVLN/Over-Current/N.C. Operations (Meas. parameter: R)	A-3
A-4. OVLN/Over-Current/N.C. Operations (Meas. parameter: I)	A-4
B-1. Handler Output Electrical Characteristics	B-1
B-2. Handler Input Electrical Characteristics	B-4
B-3. Pull-up Resistor Location	B-9
C-1. OVLN/Over-Current/N.C. Operations (Meas. parameter: R)	C-1
C-2. OVLN/Over-Current/N.C. Operations (Meas. parameter: I)	C-2

Getting Started

Introduction

This chapter provides information to get you started using your 4339B High Resistance Meter. This chapter discusses the following topics:

- Overview
- Initial Inspection
- Ventilation Requirements
- Instruction for Cleaning
- Power Cable
- Preparation for Use
- Using the Front-Panel Keys
- Basic Operation

Overview

The 4339B High Resistance Meter is designed for measuring very high resistance and related parameters of insulation materials, electronic components, and electro-mechanical components.

Features

- Measurement Parameters:
 - Resistance (R)
 - Volume Resistivity (ρ_v)
 - Surface Resistivity (ρ_s)
 - Current (I)
- Test Voltage : 0.1 to 1000 Vdc
- R Measurement Range: 10^3 to $1.6 \times 10^{16} \Omega$
- Basic Accuracy: 0.6 %
- High speed contact check
- Built-in comparator
- Interface: GPIB and handler interfaces

The 4339B's measurement range is from $1.0 \times 10^3 \Omega$ to $1.6 \times 10^{16} \Omega$. This wide range allows accurate high resistance measurements of capacitors, relays, switches, connectors, materials, cables, and PC boards.

The 4339B has the capability to measure grounded DUTs (Device Under Test), which gives you the ability to measure and evaluate devices such as PC board patterns.

The 16008B resistivity cell and the 16339A component test fixture are designed for stable and safe measurements of materials or components.

The Measurement Sequence Program function allows you to control a series of resistance measurements in a sequence (charge-measure-discharge). You can set the charge time, measurement interval time, and the number of measurements in a sequence from the front panel.

Surface resistivity (ρ_s) and volume resistivity (ρ_v) are calculated automatically and the result is displayed.

Accessories Available

The following accessories are available for the 4339B:

- 16339A** Component Test Fixture: For lead, chip, or other types of components.
- 16008B** Resistivity Cell: For resistivity measurement of solid sheet materials. Two optional electrode sizes can be ordered in addition to the installed standard 50 mm diameter electrode.
- Option 001: Add 26/78mm diameter electrodes
 - Option 002: Add 26mm diameter electrode
 - Option 003: Add 78mm diameter electrode
- 16117B** Low Noise Test Leads (1 m) : Alligator clip leads.
- 16117C** Low Noise Test Leads (1 m) : A Set of male-male triaxial and BNC cables, and an interlock cable. Female-triaxial and Female BNC connectors are also included.
- 16118A** Tweezer Test Fixture: For chip components.
- 16064B** LED display/trigger box : Displays comparator status and allows manual triggering.

Front Panel

This section gives a guided tour of the front panel. For a detailed description of each key's function, refer to Chapter 3.

Each description starting with (Shift) is the secondary function of the key, which is available by pressing the blue shift key (refer to "Shift Key").

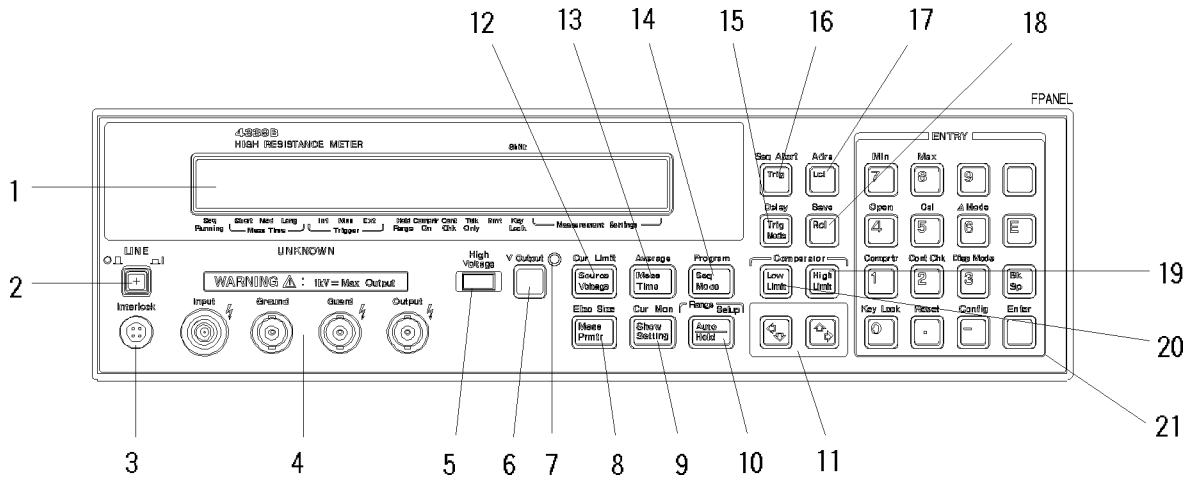

1. **Display** displays measurement results, instrument states, and error messages.
2. **LINE Switch** turns the 4339B ON and OFF.
3. **Interlock Connector** provides safety from high voltages and identifies which test fixture is connected.
4. **UNKNOWN Terminal** is the connection port of the test fixture.
5. **High Voltage Indicator** indicates that the 4339B is outputting dangerous voltage levels up to 1000 Vdc.
6. **Voltage Output Key** applies test voltage to DUT.
7. **Voltage Output Indicator** indicates when voltage is applied at Output terminal.
8. **Measurement Parameter Key** selects the measurement parameter.
(Shift) **Electrode Size Key** defines the size of the test fixture electrode.
9. **Show Setting Key** selects the mode of the Measurement Settings display on the right side of the LCD display.
(Shift) **Current Monitor Key** sets the current monitor.
10. **Auto/Hold Key** toggles the measurement range mode between Auto and Hold.
(Shift) **Range Setup Key** selects the measurement range.
11. **Left/Down and Right/Up Arrow Keys** increases or decreases the setting value.
12. **Source Voltage Key** sets the value of the applied voltage.
(Shift) **Current Limit Key** sets the limit value of the current through the DUT.
13. **Measurement Time Key** selects measurement time mode of Short, Medium, or Long.
(Shift) **Average key** sets the averaging rate.
14. **Measurement Sequence Mode Key** selects the measurement sequence mode.
(Shift) **Program Key** sets the measurement sequence.

1-4 Getting Started

15. **Trigger Mode Key** selects the trigger source from Internal, Manual, or External.
(Shift) **Delay Key** sets the trigger delay time.
16. **Trigger Key** triggers a measurement in the Manual trigger mode.
(Shift) **Sequence Abort Key** cancels a measurement sequence.
17. **Local Key** cancels the GPIB remote state.
(Shift) **Address Key** sets the GPIB address.
18. **Recall Key** recalls instrument state data from the internal memory.
(Shift) **Save Key** stores instrument state data to the internal memory.
19. **High Limit Key** sets the upper limit value for the comparator function.
20. **Low Limit Key** sets the lower limit values for the comparator function.

21. Entry Keys

- **7 Key** / (Shift) **Minimum Key** inputs the minimum value for a setting operation.
- **8 Key** / (Shift) **Maximum Key** enters the maximum value for a setting operation.
- **9 Key**
- **Shift Key** activates the secondary functions printed above the front-panel keys.



Note



In this manual, the blue Shift key is expressed as , even though the top of the key is not labeled with the word “blue”.

- **4 Key** / (Shift) **Open Key** executes an OPEN correction.
- **5 Key** / (Shift) **Calibration Key** executes the calibration function.
- **6 Key** / (Shift) **Δ Mode Key** selects the deviation measurement mode, and sets the nominal value used in the deviation measurement.
- **Exponential Key** allows input of exponent value.
- **1 Key** / (Shift) **Comprtr Key** toggles the comparator function ON or OFF.
- **2 Key** / (Shift) **Contact Check Key** toggles the contact check function ON or OFF.
- **3 Key** / (Shift) **Display Mode Key** selects the display mode and display format.
- **Back Space Key** erases the last character entered.
- **0 Key** / (Shift) **Key Lock Key** toggles to disable and enable the front panel key input.
- **.** (point) **Key** / (Shift) **Reset Key** resets the 4339B to its default state.
- **-** (minus) **Key** / (Shift) **Configuration Key** sets the offset-error canceling, beeper setting, and the power line frequency, and executes the internal test.
- **Enter Key** enters the input value to the 4339B.

Display

This section gives a guided tour of the display panel. For more detailed description of each item, refer to Chapter 3.

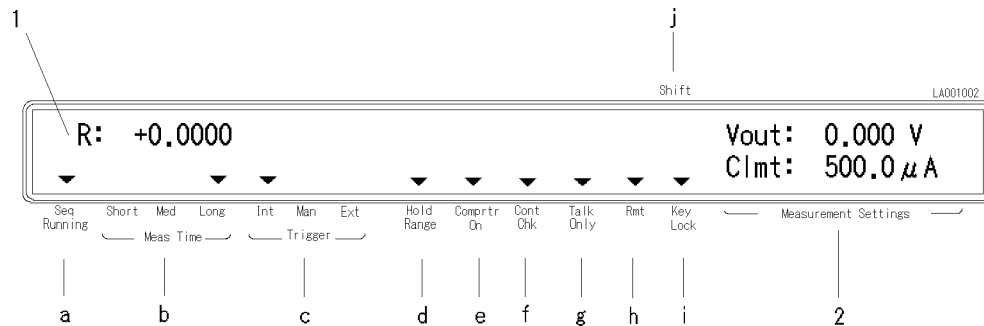

1. **Measurement Result Display Area** displays measurement result and instrument messages.
2. **Measurement Setting Display Area** displays instrument settings.
3. **Annunciator** indicates other instrument settings. Annunciator labels are as follows:
 - a. **Sequence Running** indicates a measurement sequence is running.
 - b. **Measurement Time** shows measurement time Short, Medium, or Long.
 - c. **Trigger** indicates trigger mode is Internal (Int), Manual (Man), or External (Ext).
 - d. **Hold Range** indicates measurement range is in hold mode. In Auto mode, the annunciator is not displayed.
 - e. **Comparator On** indicates the comparator function is ON.
 - f. **Contact Check On** indicates the contact check function is ON.
 - g. **Talk Only** indicates the GPIB state is Talk Only.
 - h. **Remote** indicates the GPIB state is remote.
 - i. **Key Lock** indicates the 4339B's front-panel keys are disabled.
 - j. **Shift** indicates that the shift toggle is activated.

Rear Panel

This section gives a tour of the rear panel. For a more detailed description of each item, refer to Chapter 3.

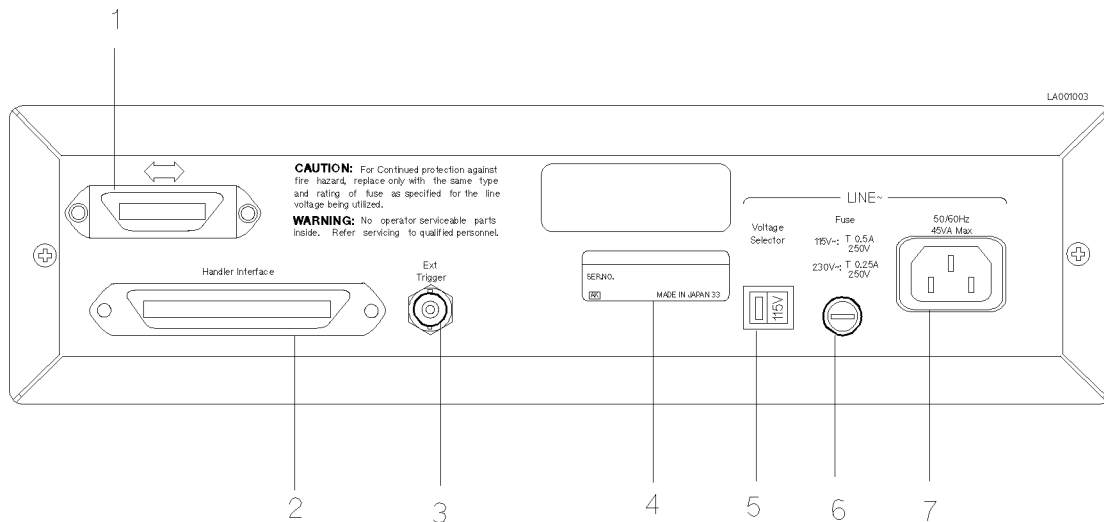

1. **GPIB Interface** is used for controlling the 4339B from an external controller using GPIB commands.
2. **Handler Interface** is used to synchronize timing with an external handler.
3. **Ext Trigger Terminal** is used to trigger a measurement using an external signal.
4. **Serial Number Plate** gives the instrument's manufacturing information.
5. **Line Voltage Selector Switch** is used to set the voltage to that of the AC power source.
6. **Line Fuse Holder**
7. **Power Cord Receptacle**

Initial Inspection

Warning



To avoid hazardous electrical shock, do not turn on the 4339B when there are signs of shipping damage to any portion of the outer enclosure (for example, covers, panel, or display)

Inspect the shipping container for damage. If the shipping container or cushioning material is damaged, it should be kept until the contents of the shipment have been checked for completeness and the 4339B has been checked mechanically and electrically. The contents of the shipment should be as follows:

- 4339B High Resistance Meter
- Power cable
- Shunt connector
The Agilent part number is 04339-60003
- Operation Manual (Option ABA, This book)
- User's Guide
- CD-ROM (Manual)

If the contents are incomplete, if there is mechanical damage or defect, or if the analyzer does not pass the power-on selftests, notify the nearest Agilent Technologies office. If the shipping container is damaged, or the cushioning material shows signs of unusual stress, notify the carrier as well as the Agilent Technologies office. Keep the shipping materials for the carrier's inspection.

Providing clearance to dissipate heat at installation site

To ensure the specifications and measurement accuracy of the product, you must keep ambient temperature around the product within the specified range by providing appropriate cooling clearance around the product or, for the rackmount type, by forcefully air-cooling inside the rack housing. For information on ambient temperature to satisfy the specifications and measurement accuracy of the product, refer to Chapter 8, Specifications.

When the ambient temperature around the product is kept within the temperature range of the operating environment specification (refer to "General" in Chapter 8), the product conforms to the requirements of the safety standard. Furthermore, under that temperature environment, it has been confirmed that the product still conforms to the requirements of the safety standard when it is enclosed with cooling clearance as follows:

	Conditions
Rear	250 mm
Side	100 mm

Instruction for Cleaning

For cleaning, wipe with soft cloth that is soaked with water and wrung tightly without undue pressure.

Power Cable

In accordance with international safety standards, this instrument is equipped with a three-wire power cable. When connected to an appropriate ac power outlet, this cable grounds the instrument frame. The type of power cable shipped with each instrument depends on the country of destination. Refer to Figure 1-1 for the part numbers of the power cables available.

Warning

For protection from electrical shock, the power cable ground must not be defeated. The power plug must be plugged into an outlet that provides a protective earth ground connection.



<p>OPTION 900</p>  <p>Plug : BS 1363A, 250V Cable : 8120-1351</p>	<p>OPTION 901</p>  <p>Plug : NZSS 198/AS C112, 250V Cable : 8120-1369</p>
<p>OPTION 902</p>  <p>Plug : CEE-VII, 250V Cable : 8120-1689</p>	<p>OPTION 903</p>  <p>Plug : NEMA 5-15P, 125V, 15A Cable : 8120-1378</p>
<p>OPTION 904</p>  <p>Plug : NEMA 6-15P, 250V, 15A Cable : 8120-0698</p>	<p>OPTION 906</p>  <p>Plug : SEV 1011.1959-24507 Type 12, 250V Cable : 8120-2104</p>
<p>OPTION 912</p>  <p>Plug : DHCR 107, 220V Cable : 8120-2956</p>	<p>OPTION 917</p>  <p>Plug : SABS 164, 250V Cable : 8120-4211</p>
<p>OPTION 918</p>  <p>Plug : JIS C 8303, 125V, 15A Cable : 8120-4753</p>	<p>OPTION 920</p> 
<p>OPTION 921</p> 	<p>OPTION 922</p>  <p>Plug : GB 1002, 250V Cable : 8120-8376</p>
<p>NOTE: Each option number includes a 'family' of cords and connectors of various materials and plug body configurations (straight, 90° etc.).</p>	

Figure 1-1. Power Cable Supplied

Preparation for Use

Before you use the 4339B, you must set it to match the available power line voltage and frequency.

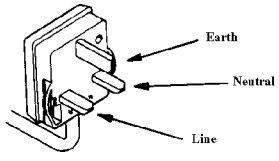
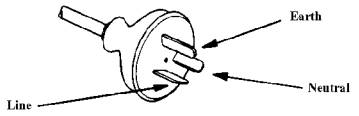
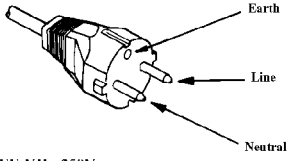
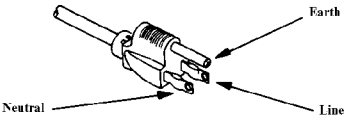
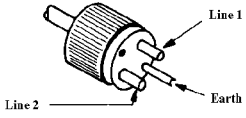
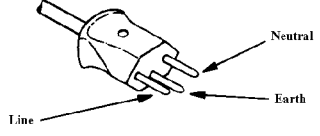
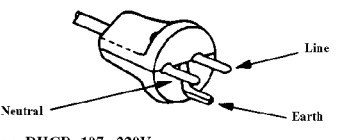
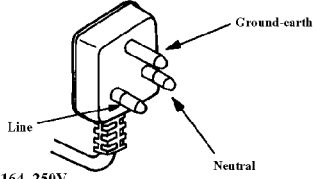
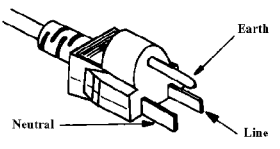
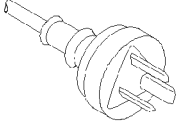
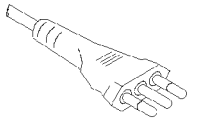
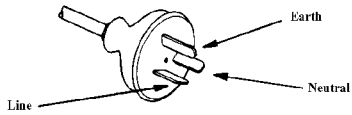
- Set power line voltage—refer to “Power Requirements”.
- Set power line frequency—refer to “ Turning ON the 4339B”

Power Requirements

The 4339B requires a following power source:



Line Voltage : 100 / 120 / 220 / 240 V ac ($\pm 10\%$)

Line Frequency : 47 to 66 Hz

Power Consumption : 45 VA maximum

Confirm that the LINE Voltage Selector on the rear panel is set to match the power line voltage before plugging in the 4339B. Refer to Table 1-1.

Table 1-1. Power Voltage Selector Setting

Voltage Selector	Line Voltage	Required Fuse
	100V/120Vac($\pm 10\%$)	UL/CSA type, Time delay 0.5A 250V (Agilent part number 2110-0202)
	220V/240Vac($\pm 10\%$)	UL/CSA type, Time delay 0.25A 250V (Agilent part number 2110-0201)

To change the LINE voltage setting of the 4339B:

1. Confirm power cable is disconnected.
2. Slide the LINE Voltage selector on the rear panel to match the ac line voltage. (refer to Table 1-1.)

Fuse

Use the fuse shown in Table 1-1. If you require the fuse, contact the nearest Agilent Technologies sales office.

The fuse can be replaced by turning the fuse holder counterclockwise until the fuse holder pops out with a minus screw driver. For the fuse holder location, see “Rear Panel” in this chapter.

Turning ON the 4339B

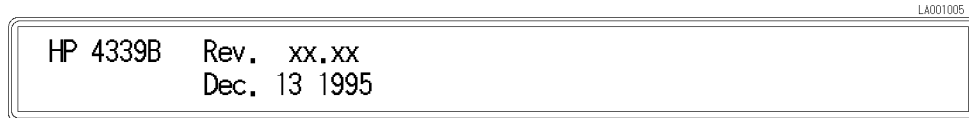

1. Connect the power cable to Power Cord Receptacle on the rear panel.
2. Push the LINE switch in. The 4339B will emit a beep and start the self test.
(If any message is displayed, refer to the “Messages” in the back of this manual.) The 4339B will be ready for operation after a message similar to the one shown in the following figure is displayed.



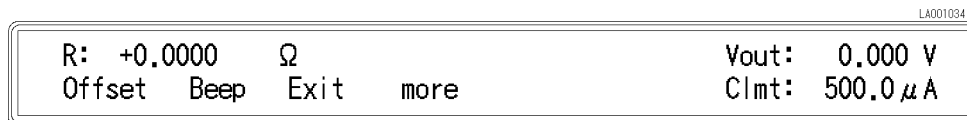

3. When you turn on the 4339B for the first time, confirm the power line frequency is set correctly.

- a. Press  . The following menu is displayed.



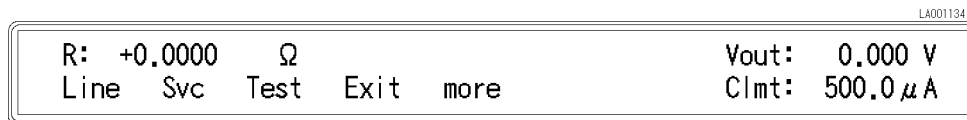



- b. Press  until more blinks, and press .

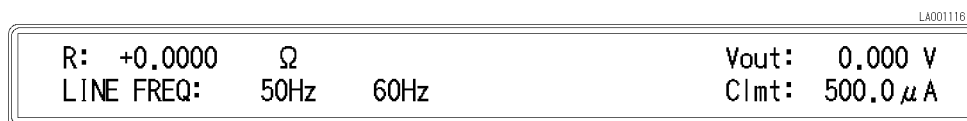

- c. Press  until Line blinks, and press .







A blinking item means that it is currently selected.

- d. If the setting does not match the power line frequency, press  to toggle the setting between 50 Hz and 60 Hz. Then press .
- e. Press  until Exit blinks, and press  to exit this menu.

The power line frequency setting is stored and is not changed after reset or power-off. Once you set it, you do not need to set the line frequency again as long as the same power line frequency is being used.

Power-On Self Test

When turned on, the 4339B performs self test which checks basic operation of the analog and digital circuits, display, LED, and Beeper. If an error is detected, an error message will be displayed on the LCD. For more information, refer to “Configuration Key   ” in Chapter 3.

Warning  **Before turning the 4339B OFF, the High Voltage indicator must be OFF. When the High Voltage indicator is ON, wait until the High Voltage indicator is OFF. (When both the High Voltage indicator and the V Output indicator are ON, turn OFF the V Output first by pressing  .)**

Using Front Panel Keys

The 4339B has three types of keys as follows:

- Direct Execution Type Keys
- Toggle Type Keys
- Selection Type Keys
- Value Setup Type Keys



Note



If you want to exit an operation and go back to the measurement mode, press  several times until you are back to the measurement mode.

Direct Execution Type Keys

Pressing a direct execution key performs the pressed key's function immediately. For example,



press   and the 4339B's front panel keys are locked out immediately.

Toggle Type Keys

Pressing a toggle type key will switch the setting. An annunciator(▼) indicates the current setting. For example,

Press  and the **Meas Time** annunciator(▼) moves to the next measurement time mode.



Selection Type Keys

Pressing a selection type key will display a menu or choice available for that key. The blinking item is the one currently selected. By using   or the selection key itself, the item selected can be changed.



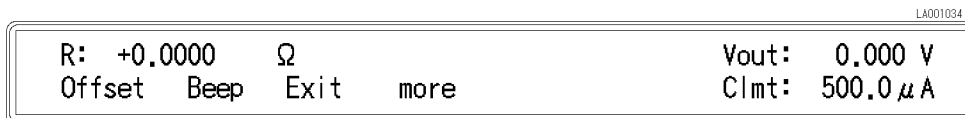

For example,

1. Press  . Exit is blinking.

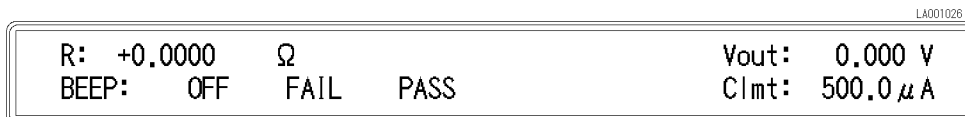

2. Press  or  until Beep blinks, and press . The beeper setup menu is displayed.



3. Press  or  to select the beeper mode. Press  to select the blinking item and go back to the previous menu display.
4. Select Exit and press  to exit the menu.

Value Setup Type Keys

Pressing a value setup type key will display the parameter entry display and prompt you to enter a value.

For example, pressing  displays,

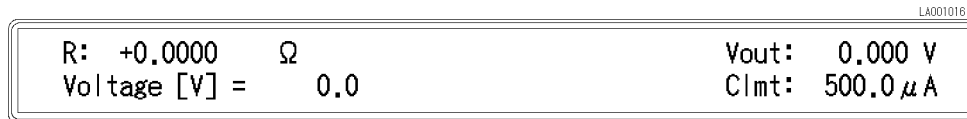

The displayed value can be entered/changed by using one of the following:

Numeric Keys

Maximum and Minimum Keys

Down and Up Arrow Keys

Back Space Key

Value Setup Using Numeric Keys

Some commands use numeric parameters. Fore example, to set the test voltage value to 100 V,

1. Press    .

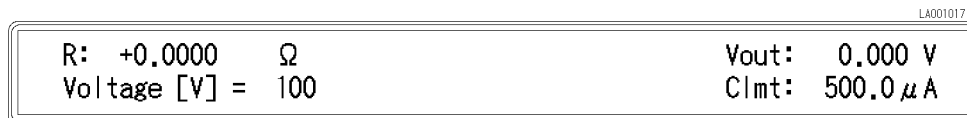

2. Press .

You can also enter numeric parameters using exponential notation.

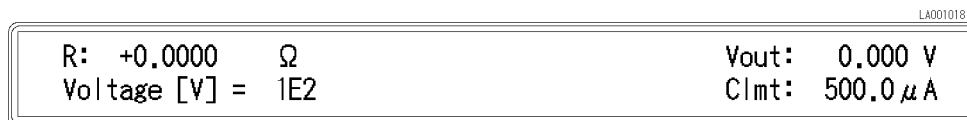

1. Press    .



2. Press .

Note



Before you press , the previous setting is still the current setting, even if the displayed value has changed. If you press a key other than one of the keys in the ENTRY block before pressing , the setting will not change and the displayed value will be discarded.

Value Setup Using Maximum and Minimum Keys

These keys enter the maximum and minimum numeric value in place of having to use the numeric keys. For example,

1. Press    .

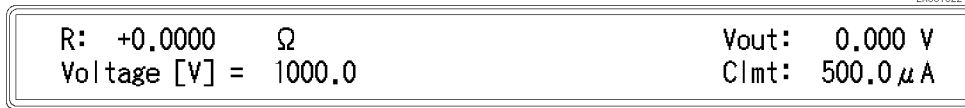

The maximum value of source voltage, 1000 V is displayed.

2. Press   .

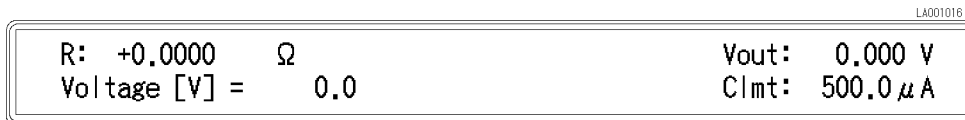





The minimum value of source voltage, 0.0 V is displayed.

3. Press  .





Value Setup Using Down and Up Arrow Keys

Increases or decreases the numeric entry. For example,

1. Press   to select current limit menu.
2. Press  or  several times and confirm that the value changes.

Value Change Using Back Space Key

Erases the last character entered. For example,

1. Press  to select the source voltage menu.
2. Press     .

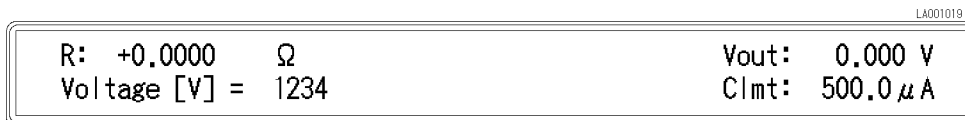

3. Press  and the last character entered, 4, is erased.



Basic Operation

This section provides the basic measurement procedure for the 4339B. Follow the instructions and become familiar with the 4339B's operation.

- Connecting Test Fixture
- Resetting 4339B
- Performing Calibration
- Performing OPEN Correction
- Selecting Measurement Parameter
- Setting Test Voltage
- Selecting Measurement Range
- Applying Test Voltage
- Turning OFF the Test Voltage



Note

If you have any problems while performing the procedures, refer to “If You Have a Problem” in Chapter 2.



Connecting Test Fixture

The 4339B has the capability to measure either floating or grounded DUTs. The measurement configuration is different for floating and grounded DUT measurements, and a Shunt connector is used to change the measurement configuration. Refer to the *Operation and Service Manual* of the test fixture for more information on how to connect it.

Warning  Do *NOT* touch the UNKNOWN terminals or the electrodes of the accessory. When the High Voltage indicator is ON, the 4339B outputs dangerous voltage level up to 1000 Vdc. Before handling the 4339B or the accessory, turn OFF the test voltage by pressing  and confirm that the High Voltage indicator is OFF.

Floating DUT Measurement

To measure a floating DUT, connect the DUT and shunt connector as shown below:

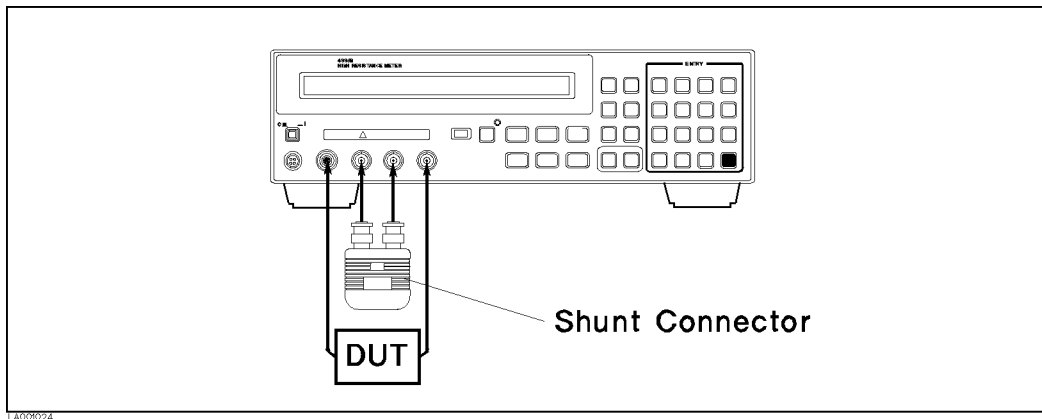

Figure 1-2. Floating DUT Measurement Configuration

Grounded DUT Measurement

To measure a grounded DUT, connect the DUT and shunt connector as shown below:

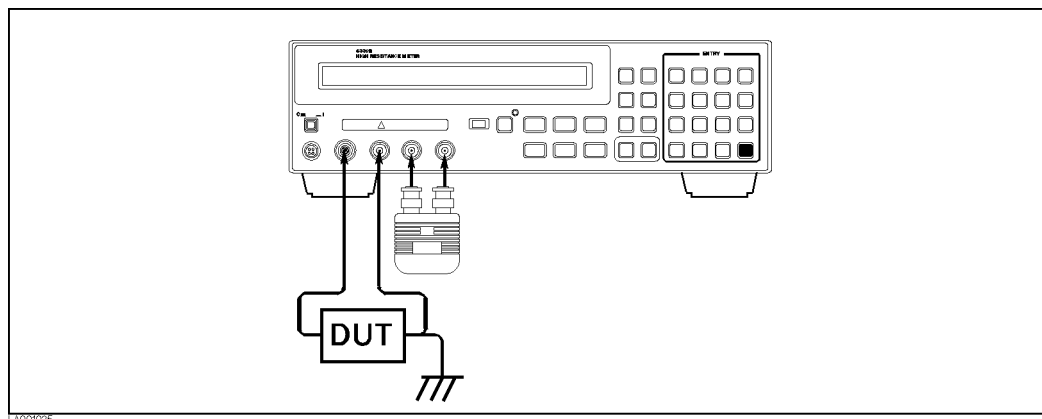

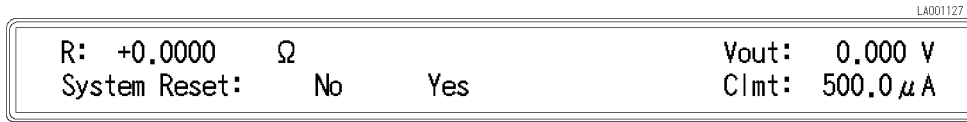



Figure 1-3. Grounded DUT Measurement Configuration



Resetting 4339B

Resetting the 4339B changes its settings to their default state.

1. Press   to select the reset menu.





2. Press  to select **Yes** (**Yes** is blinking), and press .



For more information about the default state of the 4339B, refer to “Reset Key   ” in Chapter 3.

Performing Calibration

Calibration cancels measurement errors due to environmental temperature change.

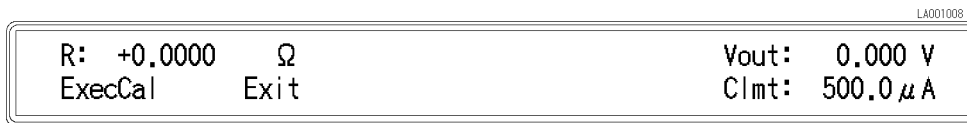
1. Press  . The 4339B displays the calibration menu.



2. Press  or  until **ExecCal** blinks, and press . The calibration is performed with the message "Calibration".
3. When the calibration is finished, the 4339B displays the message **Calibration Complete** and returns to the normal measurement display.

Note If any error message is displayed, refer to “If You Have a Problem” in Chapter 2.



Setting Test Voltage

The 4339B has an internal DC voltage source. To set voltage level of this source:

1. Press  to display the voltage setup menu.

LA001016



R: +0.0000 Ω	Vout: 0.000 V
Voltage [V] = 0.0	Clmt: 500.0 μ A

2. Enter the value using the numeric keys, and press  .

Performing OPEN Correction

The OPEN correction function cancels measurement errors caused by residuals and stray capacitance of the test fixture, and stores data for the contact check function.

1. Separate each electrode of the test fixture, confirming that nothing is connected to the electrodes. For details about fixture operation, refer to each fixture's *Operation and Service Manual*.
2. Press . A source voltage is applied to the test fixture, and the V Output indicator will turn ON.



Warning  Pressing  may cause the 4339B to output dangerous voltage, up to 1000 Vdc. Do *NOT* touch the UNKNOWN terminals or the electrodes of the fixture when the V Output indicator is ON.



3. Press  . The OPEN correction menu appears.

LA001010

R: +1.3542E+14 Ω	Vout: 100.0 V
OpenMeas MeasVal Exit	Clmt: 500.0 μA

4. Press  or  until OpenMeas blinks. Then press . The 4339B performs the OPEN correction with the message "Open Correction".

When the OPEN measurement is completed, the 4339B displays the end message "Correction Complete", and returns to the measurement display.

Note  If any error message is displayed, confirm that the test fixture electrodes are completely separated.

5. Press . The source voltage is turned OFF, and the V Output indicator will be OFF.

After the OPEN correction is completed, you can connect the DUT to the test fixture.

If you want to see the OPEN measurement value, select "MeasVal" in the OPEN correction menu. The OPEN measurement value will be displayed as follows:

LA001111

R: +0.0000 Ω	Vout: 100.0 V
Open Val = +738.44 fA	Clmt: 500.0 μA

Selecting Measurement Parameter



The 4339B has four measurement parameters.

- DC resistance: R
- DC current: I
- Surface Resistivity: Rs
- Volume Resistivity: Rv

Select the measurement parameter as follows:

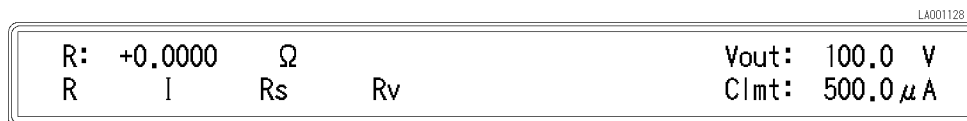
1. Press . The following menu appears.



2. Press  or  until your desired parameter blinks. Then press  to select the parameter.

Note



If the 16008B resistivity cell is connected to the 4339B, to change volume and surface resistivity, switch the volume/surface selector on the resistivity cell.

Selecting Measurement Range

The 4339B has two measurement range modes, Auto and Hold. The Auto mode changes the measurement range automatically to fit the measured value. The Hold mode fixes the measurement range.



Auto Range mode

1. Press  and the **Hold Range** annunciator(▼) will turn OFF.



Hold Range mode

Press  and the **Hold Range** annunciator(▼) will turn ON.

Changing the Range in Hold Range mode

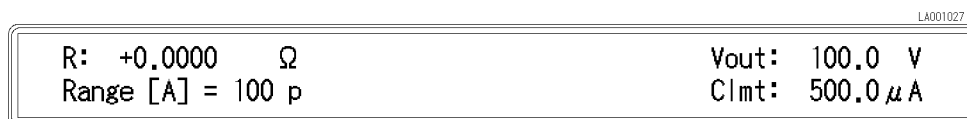
1. Press   to display the measurement range menu.





2. Press  or  until the desired range is displayed. Or, input the current value to be measured, and let the 4339B select the optimum measurement range setting.
3. press  .

Applying Test Voltage

Press  .

The source voltage specified using the  key is applied immediately, and the V Output indicator turns ON.

The displayed value is the valid measurement result when the applied source voltage is applied.

Warning  Pressing  may output dangerous voltage level up to 1000 Vdc. Do *NOT* touch the UNKNOWN terminals or the electrodes of the fixture when the V Output indicator is ON.



Turning OFF Test Voltage

Press  .

The V Output indicator will turn OFF.

Warning  If the High Voltage Indicator turns ON after turning OFF the test voltage, the DUT is still charged. This happens especially for capacitive DUTs. Do *NOT* handle the DUT while the High Voltage Indicator is turned ON. When the charge on the DUT discharges to a safe level (less than 42 V), the High Voltage indicator will turn OFF.



Operating the 4339B

Introduction

This chapter provides step-by-step instructions for using the 4339B High Resistance Meter.

It includes the following sections:

- Measurement Configuration
- Making a Measurement
- Testing the 4339B
- If You Have a Problem

Refer to Chapter 3 for the description of each front panel key function.

Measurement Configuration

This section discusses the 4339B's general configuration topics that apply to all measurement functions.

Selecting the Measurement Time Mode

The current measurement time mode setting (Short, Medium or Long) is indicated by the annunciator(▼). To select the measurement time mode:

Press  until the measurement time mode is set to the desired mode.

Setting the Averaging Rate

To set the averaging time:

1. Press  .

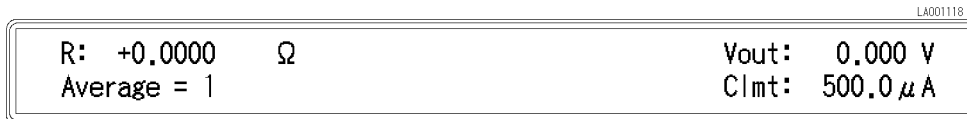

2. Enter the desired value using the numeric keys.

3. Press  to set the value and to exit.

Setting the Trigger Delay Time

To set the trigger delay time:

1. Press  .

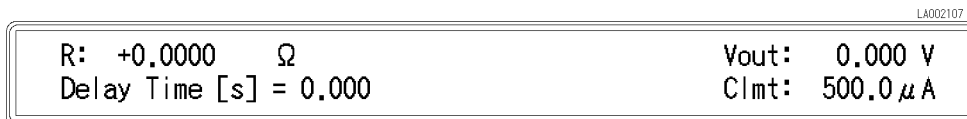



2. Enter the desired value using the numeric keys.

3. Press  to set the value and to exit.

Setting the Parameters for Resistivity Measurement

To set the parameters to calculate the resistivities (DUT thickness, Electrode Size) or to show the current settings:

1. Press  . The resistivity parameter setup main menu is displayed.

LA002006

R: +0.0000 Ω	Vout: 0.000 V
Thickness Rescell Exit	Clmt: 500.0 μ A





Entering Thickness of the DUT

To enter the thickness of the DUT or to show the current setting:

2. Select Thickness using  or  and press .

LA002007

R: +0.0000 Ω	Vout: 0.000 V
Thickness [mm] = 2.0000	Clmt: 500.0 μ A

3. Enter the desired value, or leave the current setting. Press .
4. To exit, select Exit using  or  and press . Or proceed to setting Electrode Size.

Setting the Electrode Size



To set the electrode size or to show the current setting:

5. Select ResCell using  or . The following menu is displayed.

LA002008

R: +0.0000 Ω	Vout: 0.000 V
26 50 76 User Exit	Clmt: 500.0 μ A



When You Use the 16008B Resistivity Cell:

- a. Select the electrode size that you want to use (26mm, 50mm, or 76mm) using  or , and press . For example, when you select 50mm, the following menu is displayed.

LA002009

R: +0.0000 Ω	Vout: 0.000 V
D: 50mm - 70mm B = 0.0000	Clmt: 500.0 μ A



Where, 50mm is the main electrode diameter, 70mm is the guard ring diameter, and B is the effective surface coefficient which is the fraction of the gap width to be added to the diameter of the electrode.

- b. To change B value, enter the desired new value and press . Or leave the current setting and press  to exit.

When You Use Your Own Resistivity Cell:

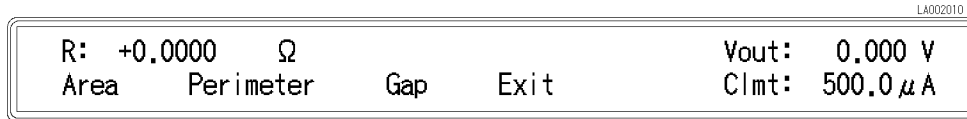

- a. Select User using  or  and press .



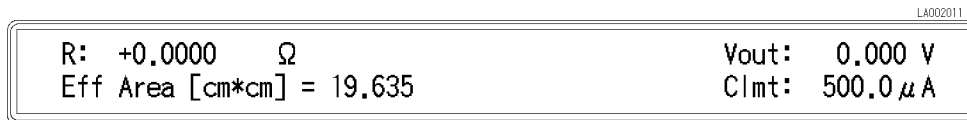

- b. To set the effective area value, select Area using  or  and press .



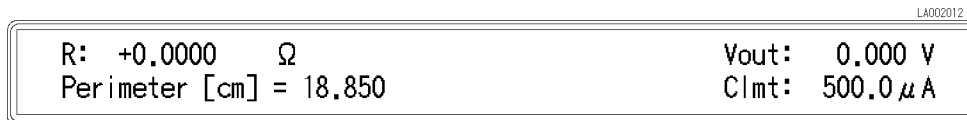

Enter the value using the numeric keys, and press  to enter the value and to exit.

- c. To set the effective perimeter value, select Perimeter using  or  and press .



Enter the value using the numeric keys, and press  to enter the value and to exit.

- d. To set the gap value, select Gap using  or  and press .

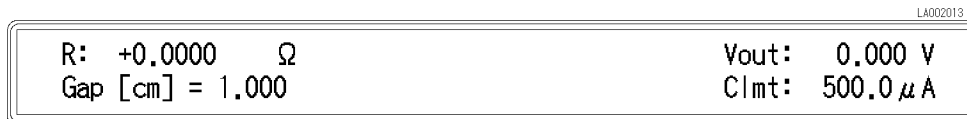

Enter the value using the numeric keys, and press  to enter the value and to exit.

- e. To exit, select Exit using  or  and press .

6. Select Exit using  or  and press  to exit the resistivity parameter setup main menu.

Making a Measurement

Triggering a Measurement

The 4339B has four trigger source modes: Internal, Manual, External, or Bus. The **Trigger** annunciator(▼) shows which trigger source is selected.

Note





When the bus trigger mode is selected, none of the **Trigger** annunciators(▼) are ON. The bus trigger mode can be set by GPIB commands only.

■ To Trigger Internally

1. Press  until the **Int** trigger annunciator(▼) is ON.

■ To Trigger Manually

1. Press  until the **Man** trigger annunciator(▼) is ON.
2. Press  to trigger a measurement.

■ To Trigger Externally

1. Connect an external trigger source to the Ext Trigger terminal on the 4339B's rear panel.
2. Press  until the **Ext** trigger annunciator(▼) is ON.
3. Apply a TTL level trigger signal to trigger a measurement. (Refer to “External Trigger” in Chapter 3 for trigger spec's.)

Using the Comparator Function

The comparator function can be used to sort DUTs based on their parameter values. The **Comprtr On** annunciator(▼) indicates whether the comparator function is set to ON or OFF.

■ To set the limit values:

1. Press  .

LA002014

R: +0.0000 Ω	Vout: 100.0 V
Low Limit = -9.9000E+37	Clmt: 500.0 μ A

2. Enter the lower limit value using the numeric keys, and press  .



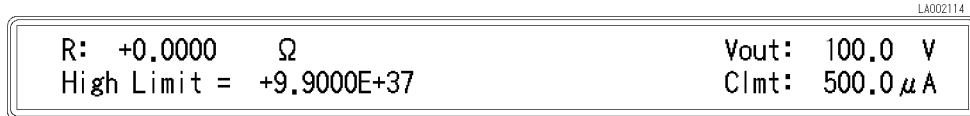

3. Press  .



4. Enter the upper limit value using the numeric keys, and press  .

Note





When you want to set the limits only for the lower (or upper) limit, set the upper (lower) limit value to the maximum (minimum) value by using   ( ) in the limit value entry menu.

■ To start sorting:

Press    .

■ To display the sorting results:

Press    . The following menu appears.

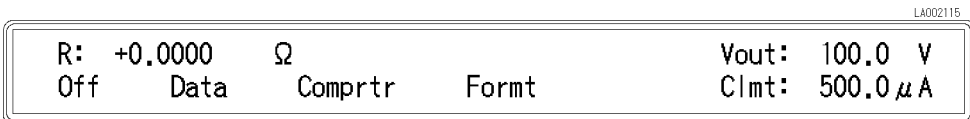

Select Comprtr using  or  and press  .

The Comparison Display mode shows the comparison results (HIGH, LOW, or IN):

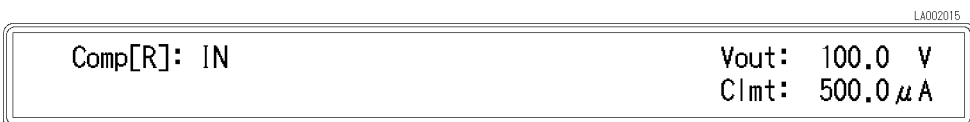

■ To stop sorting:



Press    .

Displaying Deviation Data

The Δ before the measurement parameter on the LCD display indicates that the displayed value for the parameter is a deviation value.

Setting the Reference Value

A reference value is needed for a deviation measurement. To set the reference value or to show the current setting:

1. Press  . The following menu appears.



2. Select Δ RefEnt using  or  and press .

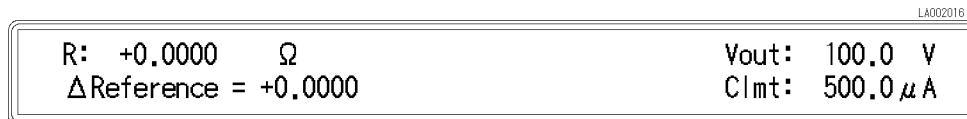

- To set the reference value by entering a value:

Enter the value using the numeric keys, and press .

- To set the reference value by measuring a reference DUT:

- a. Connect the reference DUT to the test fixture, and press  to apply the voltage.

- b. Press  regardless of the trigger mode. The 4339B will measure the reference DUT.



- c. Press  to set the measurement result as the reference value.

- To exit without changing the value, just press .

After the reference value is entered, the 4339B returns to the menu of step-1.

Selecting the Deviation Display Mode

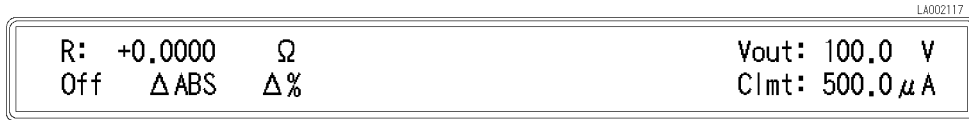

To select the deviation display mode:

3. Select ModeSet using  or  and press . The following menu appears.



- The ΔABS mode displays the difference between the measured value and the reference value.

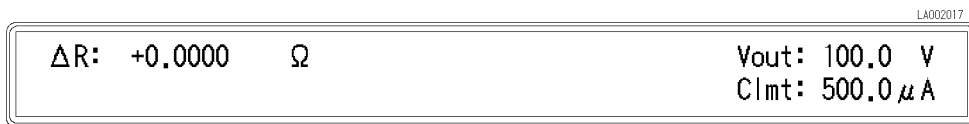

To select the ΔABS mode:

Select ΔABS using  or  and press .





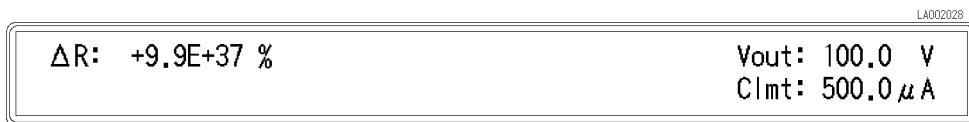

- The Δ% mode displays the the difference between the measured value and the reference value as a percentage of the reference value.

To select the Δ% mode:

Select Δ% using  or  and press .



- To turn OFF the deviation display mode, select Off and press .

4. The 4339B returns to the menu of step-1. Select Exit using  or  and press  to exit the menu.

Using the Measurement Sequence Function

The measurement sequence function allows you to control a series of measurements in a sequence. Refer to “Measurement Sequence Mode Key ” in Chapter 3 for the details of the measurement sequence function.

Selecting the Measurement Sequence Mode

The 4339B has two sequence modes: the (**Single**) mode and the (**Continuous**) mode. The current sequence mode setting can be displayed in the Measurement Settings area of the LCD display. See “Changing Measurement Settings Display Mode”.

To select the sequence mode:

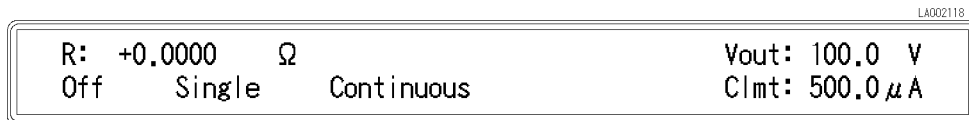

Press , and the following menu appears.



Select **Single** or **Continuous** using   (or ) , and press  .

If you want to turn OFF the measurement sequence function, select **Off**.

Setting the Measurement Sequence Mode Parameters

1. Press   . The sequence parameter setup menu is displayed.

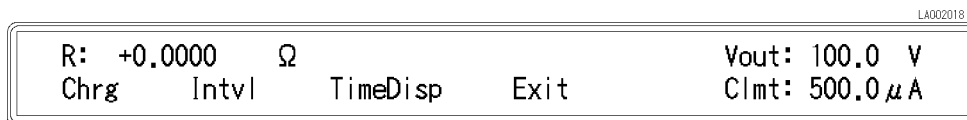

■ To Set Charge Time

To set the voltage charge time:

1. Select **Chrg** using  or  and press  .

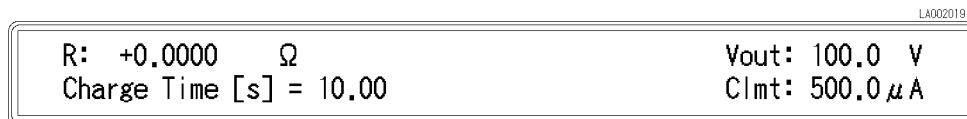

2. Enter the charge time using the numeric keys, and press  .

■ To Set Interval Time and Number of Repetitions

To set the measurement interval time and the number of measurement points (equivalent to Memory Size) used in the continuous mode:

1. Select Intvl using  or  and press  .



2. Enter the interval time using the numeric keys, and press  .

Then the Memory Size entry menu appears.

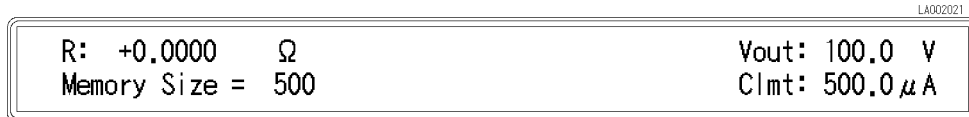

3. Enter the number of measurement points, and press  .

The current setting of the charge time, interval time, and memory size can be displayed in the Measurement Settings area of the LCD display. See “Changing Measurement Settings Display Mode”.

Setting Time Display Function

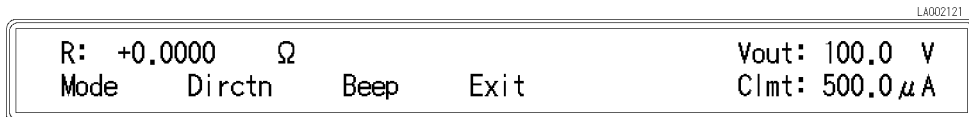

To display the elapsed time during the measurement sequence is running:

1. Select TimeDisp using  or  and press  .

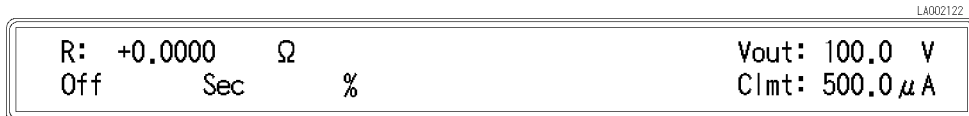

2. Select Mode using  or  and press  .









3. Select the display mode (Sec or %) using   , and press  .

If you select Off, the time display function is turned OFF.

4. Select Directn using  or  and press  .



5. Select Up (Count up mode) or Down (Count down mode) using   , and press  .
6. If you want make the 4339B to emit a beep when the measurement sequence is furnished, select Beep using  or  and press  .



LA002124

R: +0.0000 Ω	Vout: 100.0 V
Beep: Off On	Clmt: 500.0 μ A

Then select On using  or  and press  .

Starting Measurement Sequence

Press  . The measurement sequence is started and the **Seq Running** annunciator(∇) turns ON.



Warning  Pressing  may cause the 4339B to output dangerous voltage levels up to 1000 Vdc. Do *NOT* touch the UNKNOWN terminals or the electrodes of the accessory, when the V output indicator is ON.

When the time display function is ON, the elapsed time "T:" is displayed as follows:

LA002313

R: +1.2345E+09 Ω	T: 55 s	Vout: 100.0 V
		Clmt: 500.0 μ A

Aborting Measurement Sequence

Press   . The measurement sequence is aborted and the **Seq Running** annunciator turns OFF.

Setting Contact Check



The **Cont Chk** annunciator(▼) indicates the current contact check status.

Note Before performing the contact check, perform an OPEN correction to measure the reference values for the contact check. Refer to “  Performing OPEN Correction” in Chapter 1.



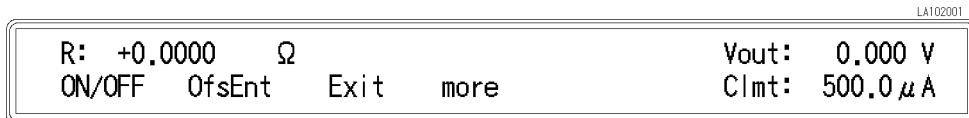

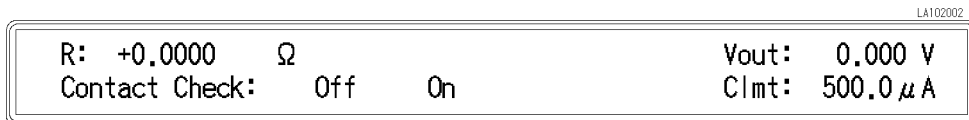

To enable or disable the contact check function:

1. Press   .



2. Select ON/OFF using  or  and press  to select.



3. Select On or Off using  or  , and press  to exit to the previous display.
4. Select Exit using  or  , and press  to exit.
5. The **Cont Chk** annunciator(▼) turns ON if the contact check function is enabled.

In the case of the contact check function is enabled, N.C. (No-Contact) will be displayed when the contacts between dut and fixture are open.

The capacitance of the dut should be shown below to operate the contact check function properly.

$$C_{dut} > C_s * 0.05 + a$$

Where:

- C_{dut}* Capacitance of dut
- C_s* Stray capacitance at open measurement (Value returned from the GPIB command: SENS:CORR:DATA? SCAP)
- a* Value shown in Table 2-1

Table 2-1. Value a

Measurement Range	Measurement Time Mode		
	Short	Medium	Long
100 pA	—	0.5 pF	0.5 pF
1 nA	0.5 pF	0.5 pF	0.5 pF
10 nA	0.5 pF	0.5 pF	0.7 pF
100 nA	0.7 pF	0.7 pF	1 pF
1 μA	1 pF	1 pF	1 pF
10 μA	1 pF	1 pF	1 pF
100 μA	1 pF	—	—

Contact check compares a measured capacitance data of dut with a limit data. Interpretation of the limit data and the measured capacitance data of the dut are shown below.

Reading the Limit Data of Contact Check Function

1. Press   .

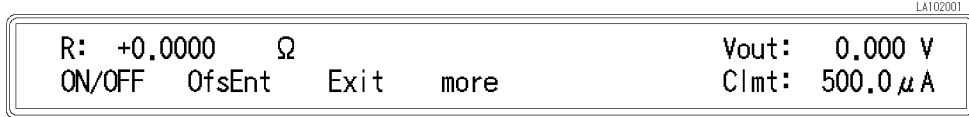

2. Select more using  or  , then press  .



3. Select LimitC using  or  , then press  .

4. The limit value is displayed.

The limit data (*Limit*) is calculated by the following equation.

$$Limit = C_s * 1.035 + b + Offset$$

Where:

C_s Stray capacitance at open measurement (Value returned from the GPIB command: SENS:CORR:DATA? SCAP)

b Value shown in Table 2-2

Offset Data entered by OfsEnt



OfsEnt is set to '0'(default) in normal measurement. In case of a parallel capacitor measurement, OfsEnt will be set to the capacitance of the parallel capacitor.

Table 2-2. Value b



Measurement Range	Measurement Time Mode		
	Short	Medium	Long
100 pA	—	0.4 pF	0.4 pF
1 nA	0.4 pF	0.4 pF	0.4 pF
10 nA	0.4 pF	0.4 pF	0.5 pF
100 nA	0.5 pF	0.5 pF	0.7 pF
1 μA	0.7 pF	0.7 pF	0.7 pF
10 μA	0.7 pF	0.7 pF	0.7 pF
100 μA	0.7 pF	—	—

Reading the Capacitance Data at DUT Measurement

1. Press   .

2. Select more using  or  , then press  .



3. Select MeasC using  or , then press .
4. The capacitance value at measured DUT is displayed.
The condition of N.C.(No Connection) is shown below.

$$MeasC < Limit$$

Where

MeasC Data displayed in MeasC
Limit Data displayed in Limit

Setting Current Limit

To set the current limit:

1. Press  .

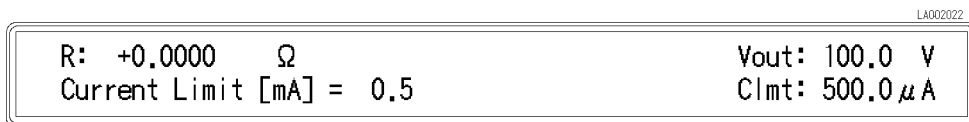



2. Enter the value using the numeric keys, and press .

Setting Current Monitor

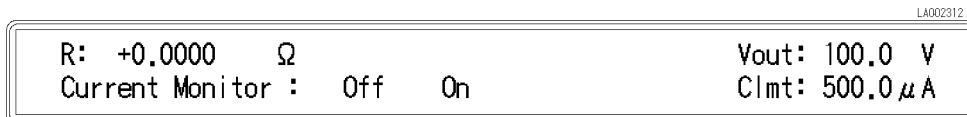
To turn ON the current monitor, press  . The following menu is displayed.



Select On using  or  and press .

The current monitor value is displayed in the **Measurement Settings** area. See “Changing Measurement Settings Display Mode”.

Setting Beeper Mode

To set the beeper mode for comparator result reporting; OFF (not beeping), FAIL (beeping when the comparator result is HIGH or LOW), or PASS (beeping when the comparator result is IN):

1. Press  .



LA001234

R: +0.0000 Ω	Vout: 100.0 V
Offset Beep Exit more	Clmt: 500.0 μ A

2. Select Beep using  or  and press .





L0002008

R: +0.0000 Ω	Vout: 100.0 V
Beep: Off Fail Pass	Clmt: 500.0 μ A

3. Select the desired Beep mode using  or , and press .

4. To exit, select Exit using  or  and press .



Setting Display Mode and Display Format

If you press  ^{Disp Mode}, the display mode selection menu appears. Select the desired mode using  or  and press  (Data: displays the measurement data, Comprtr: displays the comparator results, Off: turns the display OFF).

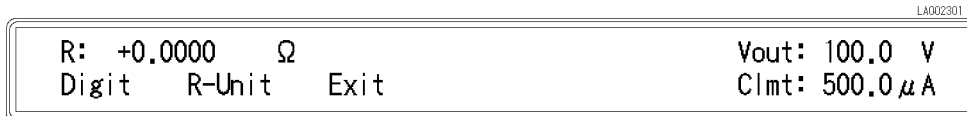

If you select **Fmt**, the measurement data display format menu appears.



If you select **Digit**, the display digits selection menu appears. Select the desired display digits using  or , and press .

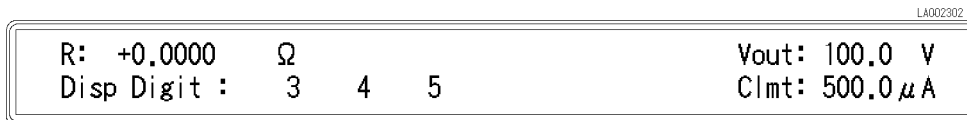

If you select **R-Unit**, the following menu appears.

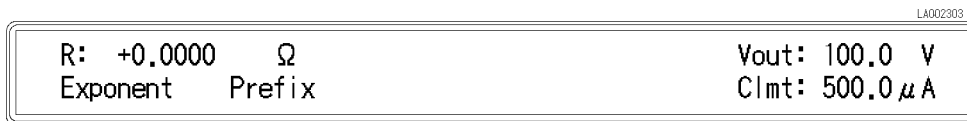

You can select the display format in this menu. Each mode displays the measurement data as follows:

Exponent mode:

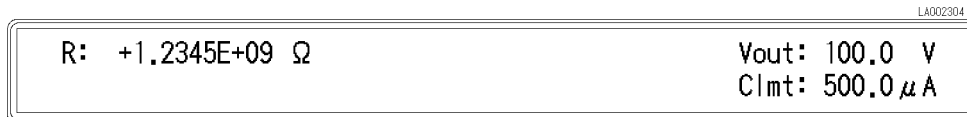

Prefix mode:

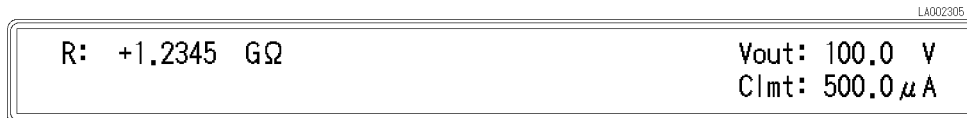

Changing Measurement Settings Display Mode

Each time  is pressed, the current settings of the 4339B are displayed one after another on the right side of the LCD display. The information displayed and the order of display is as follows:

1. Test voltage setting Vout and Current limit Clmt

LA002306

R: +1.2345 GΩ	Vout: 100.0 V
	Clmt: 500.0 μA

2. Averaging rate AVG and Trigger delay time DLY

LA002307

R: +1.2345 GΩ	AVG : 1
	DLY : 0.500s

3. Sequence mode SEQ and Charge time CHRG

LA002308

R: +1.2345 GΩ	SEQ : CONT
	CHRG: 10.00s

4. Sequence interval time INTV and Memory size MEM

LA002309

R: +1.2345 GΩ	INTV: 5.000s
	MEM : 100

5. Comparator limits Hi, Lo

LA002310

R: +1.2345 GΩ	Hi : +5.00E+12
	Lo : +1.00E+12

6. Test voltage setting Vout and Current monitor value Imon

LA002311

R: +1.2345 GΩ	Vout : 100.0 V
	Imon : 52.43 pA

Saving and Recalling Instrument Settings

The 4339B can save and recall the instrument's settings into non-volatile memory (EEPROM).

- To save the current settings:

1. Press   .

2. Enter the register number (0 to 9) into which you want to save the settings.

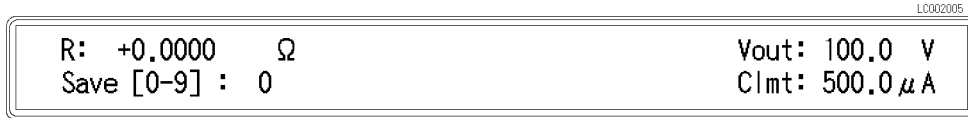

3. Press  to save.

Note Record the register number you used for future reference.



- To recall a setting.

1. Press  .

2. Enter the register number (0 to 9) from which you want to recall the settings.

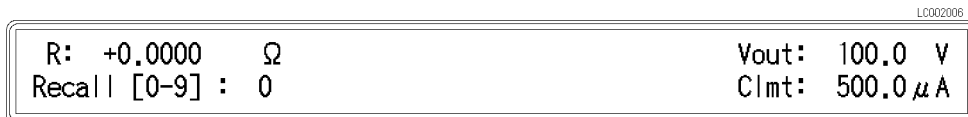

3. Press  to recall.

Locking Out the Front Panel Keys

To lockout the keys:

Press   .

To unlock the keys:

Press   again.

Selecting Local Mode

To return the 4339B to local mode from GPIB remote mode:

Press  .

Setting the GPIB Address

1. Press   .



2. Enter the desired value, then press  to set the value and to exit.

When you just want to see the current setting, press .

Printing Measurement Data

The 4339B can print measurement data to an GPIB compatible printer without using an external controller. To do so, you must:

1. Set the printer to listen-always mode. (Consult the printer manual for instructions.)
2. Connect the printer to the 4339B's GPIB port.
3. Turn the printer ON.
4. Set the 4339B's GPIB address to 31 (talk only mode).

Press    **3**  **1** .

The printer will automatically begin printing the measurement data.

5. To stop printing, change the 4339B's GPIB address to an address other than 31 (for example, 17, which is the default setting).

Press    **1**  **7** .

Setting the Offset-Error Canceling Function



The offset-error calibration function cancels the offset error due to the temperature change, when the measurement range is 100 pA or 1 nA and the measurement time mode is Long. To turn the offset-error canceling function ON or OFF:

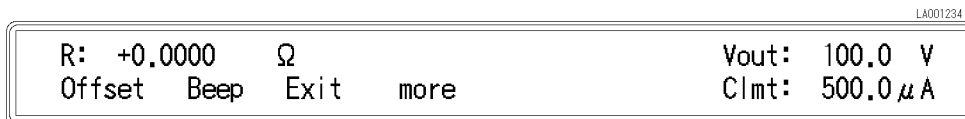

1. Press  .

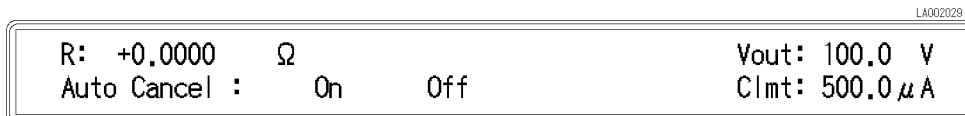

2. Select **Offset** using  or  and press .



3. To select the offset-error canceling function **On** or **Off**, use  or  and press .

4. Select **Exit** using  or  and press  to exit.

Testing the 4339B

Performing a Self-Test

The 4339B has a self-test function to check its basic performance.

1. Press  .





LA001034

R: +0.0000 Ω	Vout: 0.000 V
Offset Beep Exit more	Clmt: 500.0 μ A

2. Select more using  or  and press .

LA001134









R: +0.0000 Ω	Vout: 0.000 V
Line Svc Test Exit more	Clmt: 500.0 μ A

3. Select Test using  or  and press  to execute the self test. If any error message is displayed, refer to “Error Messages.”
4. Select Exit and press  to exit.





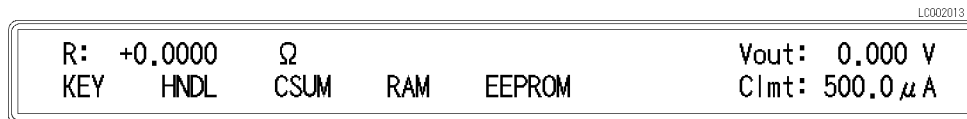

Testing the Front Panel Key's Functionality

The 4339B has a service function to test the functionality of the front panel keys which this section describes.

(There are another service functions which test the handler interface – refer to Chapter 9, and the ROM, RAM, and EEPROM – for use by service personnel only.)

1. Press  .
2. Select **more** using  or  and press .
3. Select **SVC** using  or  and press .



4. Select **KEY** using  or  and press .
 5. Press the front panel key that you want to test.
For example, if you want to test , just press .
- When the key functions properly, **KEY CODE:5 TRIGGER** is displayed, otherwise, there will be no such display, and the key is not functioning correctly. Contact your nearest Agilent Technologies office.
6. To exit the front panel key test, press  twice.
 7. Then select **Exit** and press  to exit.

If You Have a Problem

If the Display is Blank and the 4339B Appears Dead

If the display is blank, and even the annunciators are not ON:

- Check the fuse.



If an Error Message is Displayed

- Refer to “Messages.”

If the 4339B does not Accept Any Key Input

- Check whether the **Rmt** annunciator(▼) is ON.
 - Check whether the external controller is disabling all the front-panel controls using the LOCAL LOCKOUT command.

If so, send the LOCAL command from the external controller.



- Press  .
- Check whether the **Key Lock** annunciator(▼) is ON.
 - Check whether the handler or the 16064B LED display/trigger box is connected to the 4339B and it locks out the keys.
 - If so, unlock the keys from the handler or the 16064B.
- Press   .

If the Indicated Value is not Stable

- Shield the DUT to reduce the unwanted noise and the effect of operator proximity. For example, use the 16339A Component Test Fixture.
- Do not move the test leads while measuring. Changing the position of the test leads may cause noise inside the test leads.
- Position the 4339B on a stable place, where it will not be affected by vibration. Vibrating the 4339B may cause noise inside the 4339B.
- Measurement value could vary in the case of faulty powre line frequency settings. Refer to the “ Turning ON the 4339B” in Chapter 1 to set the powre line frequency.

If You Find Yourself Lost When Operating the 4339B

Press  until the 4339B returns to the measurement mode.

Or press   to return to the default settings.

Function Reference

Introduction

This chapter provides information on all the 4339B's functions.

- Front Panel
- Rear Panel
- Theory of Operation

Front Panel

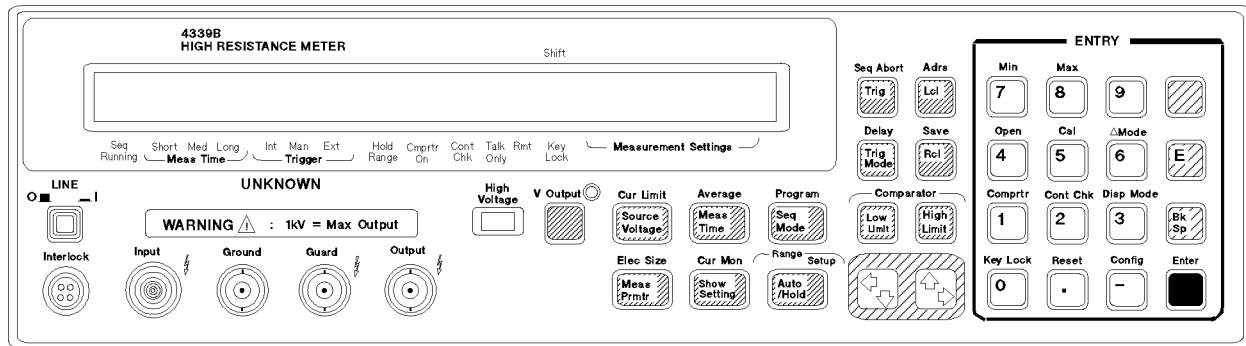



Figure 3-1. Front Panel

Note



In this manual, the blue shift key is expressed as , even though the top of the key is not labeled with the word “blue”.

Display

The display serves two functions — character display and annunciator display.

The character display shows the measurement result, instrument setting information, and instrument messages. The 4339B has four measurement display modes. For details about the display modes, refer to “Display Mode Key  ”.



Some of the instrument’s current settings are displayed in the **Measurement Settings** area.

The annunciator (▼) points to the currently selected instrument settings. The annunciator labels are as follows:

- Seq Running** (Sequence Running) Indicates the measurement sequence is running.
- Meas Time** (Measurement Time) Indicates measurement time mode — Short, Medium, or Long.
- Trigger** Indicates the trigger mode setting: Internal (Int), Manual (Man), or External (Ext).
- Hold Range** Indicates the measurement range mode. when this annunciator is not lit, the 4339B is in the Auto range mode.
- Comprtr On** (Comparator On) Indicates the comparator function is ON.
- Cont Chk** (Contact Check On) Indicates the contact check function is ON.
- Talk Only** (Addressed) Indicates that the 4339B is in the Talk Only mode.
- Rmt** (Remote) Indicates that the 4339B is in the GPIB remote mode or the talk only mode.
- Key Lock** Indicates the 4339B’s front panel keys are locked out.
- Shift** Indicates that the  is pressed. (Shift is active.)

LINE Switch

The LINE Switch turns the 4339B ON or OFF. In the 1 (ON) position power is applied and all operating voltages are applied to the instrument. In the 0 (OFF) position no power is applied and no operating voltages are applied to the instrument.

The 4339B's settings are held in backup memory for about 72 hours after power is turned OFF. Refer to "Reset Key  

Note  V Output ON /OFF state is not saved, and the 4339B sets the V Output to OFF at power-on.

Note  If you turn the 4339B OFF and then quickly ON again, it can cause an error and the 4339B may not work normally. To prevent this, wait for at least 1 second before turning ON again.

Interlock Connector

The 4339B's Interlock Connector provides safety from high voltages and identifies which test fixture is connected. It enables  which applies the test voltage to the test fixture, according to the following two tables.

Table 3-1. Interlock Condition for 16008B and 16339A

Interlock Connector	Interlock Switch ¹	Source Voltage
Not connected	—	Disabled
Connected	Open	Disabled
Connected	Closed	Enabled

¹ The condition whether the test fixture's cover is open or closed.

Table 3-2. Interlock Condition for 16117B Low Noise Test Leads



Interlock Connector	Source Voltage
Not connected	Disabled
Connected	Enabled ¹

¹ The available current limit setting is 0.5 mA only.

UNKNOWN Terminals

These are terminals used to connect the test fixture or test leads for measuring a DUT.

Input	Is connected to the DUT. The connector type is triaxial, which is configured as a center conductor, an inner shield, and an outer shield. The outer shield is connected to ground, and shields the test signal from noise. The inner shield, to which nothing is connected, guards the very low current signal, and cuts the leakage current of the contact check signal. The center conductor provides the test signal path.
Ground	Is connected to chassis ground. The connector type is a high-voltage BNC.
Guard	Is connected to an ammeter, which is isolated from Ground. This terminal is used to setup floating DUT measurements, or the grounded DUT measurements. For details, refer to “Grounded and Ungrounded DUT Measurement Configuration” at later in this chapter. The connector type is high-voltage BNC.
Output	Applies the source voltage. The connector type is a high-voltage BNC.

Warning  **Do NOT touch the UNKNOWN terminals or the electrodes of the accessory, when the High Voltage indicator is ON, because the 4339B outputs dangerous voltage level up to 1000 Vdc. Before handling the 4339B or the accessory, turn OFF the test voltage pressing  and confirm that the V Output indicator is OFF.**



High Voltage Indicator

The High Voltage indicator shows that the 4339B is outputting dangerous voltage levels up to 1000 Vdc. When this indicator turns ON, be extremely careful treating the UNKNOWN terminal and test fixture. Even when the V Output Indicator turns OFF, the High Voltage Indicator stays ON until the DUT's Charged voltage drops to a safe level.

Warning  **Do NOT touch the UNKNOWN terminals or the electrodes of the accessory, when the High Voltage indicator is ON.**

V Output Key

The V output key is used to apply the test voltage to the DUT or to discharge the DUT. When the test voltage is applied, the V output indicator will turn ON.

Warning  **Pressing  may cause the 4339B to output dangerous voltage levels up to 1000 Vdc. Do NOT touch the UNKNOWN terminals or the electrodes of the accessory when the V Output indicator is ON.**

Even when the V output key is turned OFF, a charge will remain on the DUT, especially when the DUT is a capacitor. If the DUT is charged to a dangerous voltage, the high voltage indicator will stay ON. After the measurement, handle the DUT only after the high voltage indicator turns OFF and the DUT has had enough time to fully discharge.

V Output Indicator

The V output indicator indicates that the test voltage is applied to the DUT.

Source Voltage key

The source voltage key sets the test voltage value from 0 to 1000 V. Resolution of the test voltage is as follows:

Voltage Range	Resolution
$0\text{ V} \leq \text{Test Voltage} \leq 200\text{ V}$	0.1 V
$200\text{ V} < \text{Test Voltage} \leq 1000\text{ V}$	1 V

Current Limit Key

The current limit key sets the limitation value of current flowing through the DUT. The 4339B adjusts the test voltage so that the current flowing through the DUT does not exceed the current limit value. While the current limit is active and the source output is decreased, the 4339B displays “OVER CURRENT”. The current limitation feature protects the DUT from destruction due to high current flow. Current limits can be set to the following values:

- 0.5 mA (default)
- 1 mA
- 2 mA (at test voltage 0 to 500 V only)
- 5 mA (at test voltage 0 to 250 V only)
- 10 mA (at test voltage 0 to 100 V only)

Note When the 16117B Low Noise Test Leads are used, the available current limit setting is 0.5 mA only.



Measurement Time key

The measurement time key sets measurement time mode: Short, Medium(Med), or Long. A longer measurement time produces a more accurate measurement result. The current measurement time mode setting is indicated by the **Meas Time** annunciator(▼). The default setting is Medium.

Average key

The average key sets the measurement averaging rate. The 4339B automatically averages the measurement results by this rate. The averaging rate can be set as an integer from 1 to 256. The default setting is 1.

Measurement Sequence Mode Key 

The Measurement Sequence Mode key toggles the measurement sequence mode ON and OFF. This feature provides an automatic measurement process. The 4339B has two sequence modes: the single mode and the continuous mode.

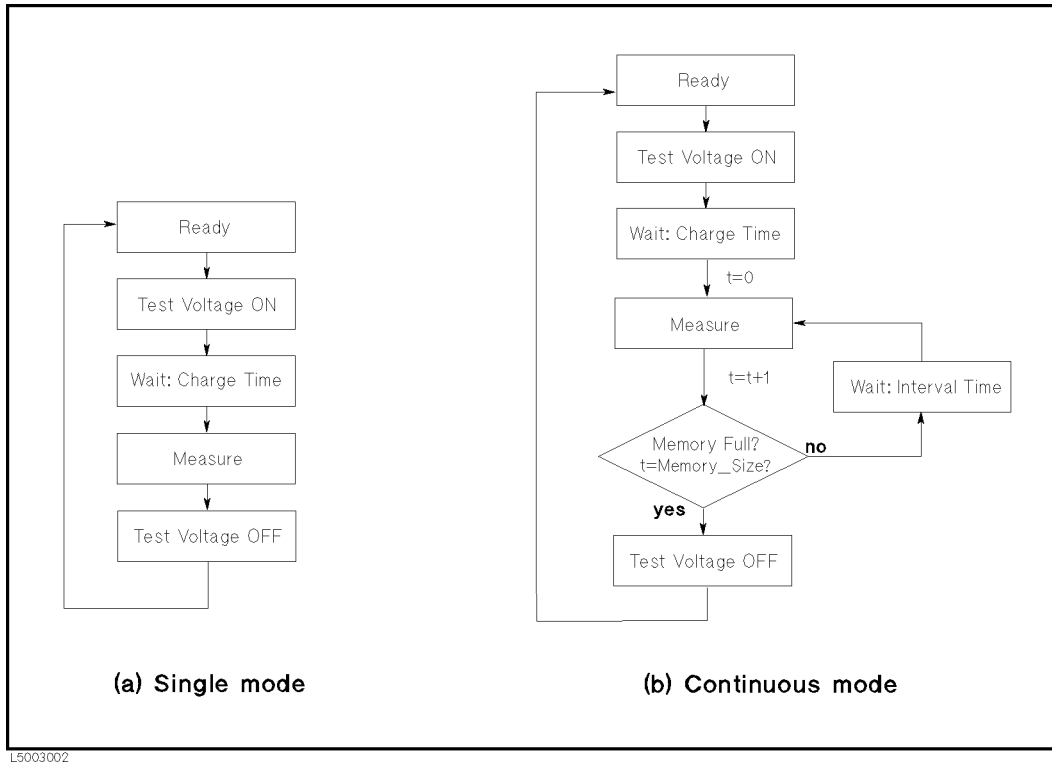



Figure 3-2. Sequence Mode

Single Mode





Figure 3-2(a) shows a measurement sequence in the Single mode. The single mode is appropriate for measuring a DUT when the operator defines the charge time (for example, 1 minute). The single mode is performed as follows:

1. At the Ready state, pressing  starts the measurement sequence, and the test voltage is turned ON.
2. The 4339B waits for the defined **Charge Time** while the applied voltage is charging the DUT.
3. After that, the 4339B measures the charged DUT.
4. At the end of the measurement sequence, the 4339B turns the test voltage OFF, and returns to the Ready state.

Continuous mode

Figure 3-2(b) shows a measurement sequence in the Continuous mode. The continuous mode is appropriate for measuring time related characteristics. The continuous mode is performed as follows:

1. At the Ready state, pressing  starts a measurement sequence, and the test voltage is turned ON.
2. The 4339B waits for the defined **Charge Time** while the applied voltage is charging the DUT.
3. After that, the 4339B repeats measuring the DUT as many times as is defined by the **Memory Size** with a defined **Interval Time** between measurements. The measurement data is displayed on the LCD display after each measurement, and all measurement data is stored in the data buffer, which can be accessed using GPIB commands (refer to “DATA Subsystem” in Chapter 5).
4. After all measurements are completed, the 4339B turns the test voltage OFF, and returns to the Ready state.

The user definable parameters **Charge Time**, **Interval Time**, and **Memory Size**, are set using the program key ( ). For details, refer to “Program Key   ”.

When the sequence is running, the **Seq Running** annunciator() turns ON.

Program Key  

The program key sets the parameters for a measurement sequence. For details about the measurement sequence, refer to “Measurement Sequence Mode Key  ”. You can setup the measurement sequence parameters in the following menu:

Chrg The Charging time of voltage. The range and resolution are as follows:

Range	Resolution
0 s ≤ Charge Time < 10 s	1 ms
10 s ≤ Charge Time < 100 s	10 ms
100 s ≤ Charge Time ≤ 999 s	100 ms

The default setting is 0 ms.

Intvl This menu is for setting the Interval Time and the Memory Size. These parameters are used only in the Continuous mode.

Interval Time

The range and resolution are as follows:

Range	Resolution
10 ms ≤ Interval Time < 10 s	1 ms
10 s ≤ Interval Time < 100 s	10 ms
100 s ≤ Interval Time ≤ 999 s	100 ms

The default setting is 1 s.

Memory Size

This parameter is the number of measurement points which will be stored. Available memory sizes are 1 to 500. The default memory size is 500.

Time Display Function

The time display function displays the elapsed time during the measurement sequence is running. The following menu appears when **TimeDisp** is selected:

- **Mode** — sets the time display mode.
 - Sec** Displays the elapsed time in seconds.
 - %** Displays the number of measurement completed points (in Count up mode) or remaining measurement points (in Count down mode) as a percentage of the total number of measurement points.
 - Off** Turns OFF the time display function.
- **Directn** — Sets the timer direction to **Up** (Count up mode) or **Down** (Count down mode).
- **Beep** — Turn ON/OFF the beep which is emitted twice when the sequence program is completed.
- **Exit** — Exits the menu.

Note The accuracy of displayed time is not guaranteed.



Measurement Parameter Key

The Measurement Parameter key selects the measurement parameter for the 4339B from the following choices:

- R** Resistance
- I** Current — When measuring in the grounded DUT configuration, the measured current value is displayed as a negative value with the minus (–) sign.
- Rs** (ρ_s) Surface Resistivity
- Rv** (ρ_v) Volume Resistivity

The currently selected parameter is displayed on the left edge of the display. The default setting is R (Resistance).

Electrode Size Key

The Electrodes Size key is used to enter the thickness of the DUT, the electrode's size, and the effective area coefficient of the test fixture. These values are the factors used to calculate the volume or surface resistivity. Parameters are as follows:

- Thickness** Enters the DUT's thickness, which is equal to the distance between the electrodes. Available values are 0.01 mm to 20 mm in 0.1 mm resolution. The default setting is 2.0 mm.
- Rescell** Defines the electrode's size and the effective area coefficient of the test fixture.
 - **26mm, 50mm, and 76mm** : Select the electrode diameter (**D**₁) size when using the 16008B Resistivity Cell. The guard ring diameter size (**D**₂) is automatically selected according to the **D**₁ value. The effective area coefficient (**B**) is the fraction of the gap width to be added to the diameter of the electrodes. The **B** value is usually specified by the standard that you use. (For example: 1 for ASTM D 257; 0 for JIS K 6911).

Parameter	Description	Available Value		
D₁	Main electrode diameter	26 mm ¹	50 mm ¹	76 mm ¹
D₂	Guard ring diameter	38 mm ¹	70 mm ¹	88 mm ¹
B	Effective area coefficient	0 ≤ B ≤ 1 (0.0001 resolution)		

¹ These parameter's values are fixed and cannot be changed.

Surface resistivity (ρ_s) and volume resistivity (ρ_v) are calculated using the following equation:

$$\rho_s = \frac{\pi(D_2 + D_1)}{(D_2 - D_1)} \times R_s [\Omega]$$

$$\rho_v = \frac{\pi \times \left(D_1 + \frac{B(D_2 - D_1)}{2} \right)^2}{4t} \times \frac{R_v}{10} [\Omega \cdot cm]$$

Where,

R_s : Surface resistance (Measured value)

R_v : Volume resistance (Measured value)

t : DUT's thickness (Entered as Thickness)

- **User** Defines the electrode's parameters when using your own test fixture.

Parameter	Description	Available Value
Area	Effective area	0 cm ² ≤ AREA ≤ 9999.9 cm ² (5-digit number, default is 19.635 cm)
Perimeter	Effective perimeter	0 cm ≤ PERIMETER ≤ 999.99 cm (5-digit number, default is 18.850 cm)
Gap	Gap	0.001 cm ≤ GAP ≤ 99.99 cm (4-digit number, default is 1 cm)

Surface resistivity (ρ_s) and volume resistivity (ρ_v) are calculated using the following equation:

$$\rho_s = \frac{PERIMETER}{GAP} \times R_s [\Omega]$$

$$\rho_v = \frac{AREA}{t} \times \frac{R_v}{10} [\Omega \cdot cm]$$

Where,

R_s : Surface resistance

R_v : Volume resistance

t : DUT's thickness (entered as THICKNESS)

Note



The effective area coefficient B can be set only with front panel keys. It is impossible to enter the B value using GPIB commands.

Show Setting Key

The Show Setting Key changes the mode of the Measurement Settings display on the right side of the LCD display. Each time  is pressed, the display mode is changed as follows:

1. Test voltage setting(**Vout**) and Current limit(**Clmt**)
2. Averaging rate(**AVG**) and Trigger delay time(**DLY**)
3. Measurement sequence mode(**SNGL**, **CONT** or **OFF**) and charge time(**CHRG**)
4. Interval time(**INTV**) and Memory size(**MEM**) of the measurement sequence
5. Comparator limits(**Hi** and **Lo**)
6. Test voltage setting and Current monitor value(**Imon**)

Current Monitor Key

The Current Monitor Key is for setting the current monitor function.

The current monitor function displays the current measurement value on the right side of the LCD display (**Measurement Settings** area), as shown in “Show Setting Key ”. This function is useful for checking the current value when the measurement parameter is set to R, Rs or Rv.

Auto/Hold Range Key

The Auto/Hold range key toggles the measurement ranging mode between Auto and Hold. In the Auto mode, the 4339B selects the optimum measurement range automatically within 5 measurement cycles. In the Hold mode, the 4339B measurement range is fixed at the range you select. The **Hold Range** annunciator(**▼**) indicates the current mode.

Range Setup Key



The Range Setup key sets the measurement range. The available measurement range settings are:

- 100 pA (available when the measurement time mode is Medium or Long)
- 1 nA
- 10 nA
- 100 nA
- 1 μ A
- 10 μ A
- 100 μ A (available when the measurement time mode is Short)

Each measurement range can measure a value up to 1.1 times of the range setup value. “OVLD”(Over Load) is displayed instead of the measurement data when the measured value is out of the measurable range.

Trigger Key

The trigger key triggers a measurement when the 4339B is in the Manual trigger mode. Refer to “Trigger Mode Key  ” for more information.

Warning  **When the measurement sequence mode is ON, pressing  may cause the 4339B to output dangerous voltage levels up to 1000 Vdc. Do *NOT* touch the UNKNOWN terminals or the electrodes of the accessory when the V Output indicator is ON.**

Sequence Abort Key

The Sequence Abort key aborts the running measurement sequence program.

Local Key

The Local key returns the 4339B to local (front-panel) operation from GPIB remote (computer controlled) operation. The Local key is the only active front-panel key while the 4339B is in GPIB remote mode. When the 4339B is remote state, the **Rmt** annunciator(▼) will be displayed.

Address Key

The Address key sets the 4339B’s GPIB address. The available GPIB address is any integer number from 0 to 30, and address 31 is the Talk Only mode in which the 4339B only outputs data through GPIB interface.

Resetting or powering off doesn’t affect the 4339B’s address setting.

- <stat> Measured Status
 - 0 : Normal
 - 1 : Overload
 - 2 : No-Contact
 - 4 : Over voltage (exceeding ccurrent limit)
- <data> Measured data
- <comp> Comparison result (no output when the comparator function is OFF)
 - 1 : IN
 - 2 : HIGH
 - 4 : LOW
 - 8 : No-Contact

System reset or power-on don’t affect the address setting.

Trigger Mode Key 

The Trigger Mode key selects the trigger source. The available trigger sources are as follows:

- Int** (Internal) Trigger Mode. The 4339B is triggered automatically and continuously. (Default)
- Man** (Manual) The 4339B is triggered when  is pressed.
- Ext** (External) The 4339B is triggered by a pulse input through the External Trigger terminal or the handler interface. Refer to “External Trigger”.
- Bus** (Available only in GPIB remote mode.) The 4339B is triggered by the GET or *TRG command through the GPIB.



Delay Key  

The Delay key sets a lag time between event and the start of the actual measurement. The available trigger delay time value is 0 to 9.999 s.

Note The trigger delay time value is invalid when you perform the measurement sequence.



Recall Key  

The Recall key is used to recall instrument settings saved in non-volatile memory (EEPROM) (see “Save Key   ”). You must enter register number, 0 to 9, from which to recall the settings. If the register selected is empty, the error message “RECALL FAILED” is displayed.

Save Key  





The Save key stores the instrument’s current settings into non-volatile memory (EEPROM). Saved settings are the same as the items stored into backup memory in Table 3-3. Up to 10 sets of instrument settings can be saved. You must enter the register number , 0 to 9, to assign the register into which the settings will be saved.

Caution The 4339B overwrites the instrument’s settings into the assigned register without warning. If settings are already stored in the assigned register, they will be lost.



Comparator Limit Keys  

The comparator limit keys set the comparator high and low limit values which decide the comparator’s PASS or FAIL response. Note that the comparator function compares the displayed value with the limit values.

You cannot set each limit value to OFF using the front-panel keys, but you can by using GPIB commands. (Refer to “CALCulate Subsystem” in Chapter 5 To get around this front-panel key restriction, use the Minimum ( ) or Maximum ( ) keys instead.

Left/Down and Right/Up Arrow Keys

These keys serve the following functions:

- When you enter a value for the value setup keys, these keys increase or decrease the setting value.
- When you select an item for the selection keys, these keys are user to activate the item (the selected item blinks).

0, . . . , 9, .(point), –(minus) Keys . . .

These keys are used to enter numeric data into the 4339B. Pressing  terminates numeric data input.

Shift Key

The blue Shift key activates the secondary function printed above the keys.

The Shift key toggle is cleared by a single execution of a shifted function or by pressing the Shift key again. The **Shift** annunciator(▼) is displayed when the Shift key is toggled to active mode.

Exponential Key

The Exponential key is used to enter an exponential value.

Back Space Key

The Back Space key deletes a single preceding character of an input value.

Enter Key

The Enter key terminates data input or setting.

Minimum Key



The Minimum key enters the minimum value during a parameter setting operation.

Maximum Key

The Maximum key enters the maximum value during a parameter setting operation.

Open Key  

The Open key is execute the OPEN correction measurement to obtain the OPEN correction data. The 4339B uses this data to cancel the leakage of the test fixture and to obtain the limit value for the contact check function. The correction data is stored in non-volatile memory (EEPROM). See “  Performing OPEN Correction” in Chapter 1 for more information.



If   is pressed, the following OPEN correction menu is displayed.



- OpenMeas** Peroforms the OPEN correction.
- MeasVal** Displays the OPEN correction data (OPEN measurement value).
- Exit** Exits the menu.

At reset, the correction data is cleared.

Calibration Key  

The Calibration key executes the calibration function. Calibration cancels the internal offset error and the proportional error of the 4339B due to environmental temperature changes. The calibration data are stored in backup memory. Refer to “Performing Calibration” in Chapter 1 for more information.

At reset   , the calibration data is cleared.

Comparator On/Off Key  

The Comparator On/Off key toggles the comparator ON and OFF. The comparator determines the measurement result (displayed value) is within the upper and lower limits set by the Comparator Limit key. When the comparator is ON, the **Comptr On** annunciator(▼) will be displayed. The comparator will yield one of the following results:

- HIGH** Greater than upper limit
- IN** Between the upper limit and lower limit
- LOW** Less than lower limit
- N.C.** (no-contact) Contact check failed (at contact check ON state)



In addition, these results are transmitted to the following destinations:

Destination	Condition
Display	HIGH, IN, LOW, N.C.
Handler Interface	HIGH, IN, LOW, N.C.
Beeper	HIGH, LOW, N.C. (when beeper mode is fail), or IN (when beeper mode is pass)

Contact Check Key

The Contact Check key toggles the contact check function ON and OFF. This function monitors whether the DUT is properly connected to the test fixture or test leads.

When the contact check fails,

- N.C. (No-Contact) will be displayed on the LCD display.
- The measurement status of the GPIB output data is set to 2 (No-Contact). Refer to “Address Key   ” for the GPIB output data.
- The /NO CONTACT pin of the handler interface is asserted. Refer to “Handler Interface” for the pin assignment of the handler interface.
- The measurement is still performed, and the measurement result is outputted to the GPIB interface and the handler interface.

The decision limit value of the contact is obtained during the OPEN correction. When the OPEN correction is performed, unconnected capacitance is measured and stored. The 4339B compares this value with the DUT’s capacitance.

The **Cont Chk** annunciator(▼) is displayed when the contact check function is ON. The default setting is OFF.

Display Mode Key



The Display Mode key selects the display mode from the following choices:

- Data** Displays the measurement result. (default)
When the contact check function is ON and the contact check has failed, N.C. (no-contact) will be displayed instead of the measurement data.
- Comprtr** (When comparator function is ON,) Displays the result of the comparison as HIGH (greater than upper limit), IN (Passed), and LOW (less than lower limit), or N.C. (contact check failed).
(When comparator function is OFF,) Always displays OFF.
- Off** Turns the display OFF.
(Used, for example, in GPIB remote mode.)

If you select **Format**, the following display format setup menu appears.

- Digit** Sets the display digits of the measurement data to 3, 4 or 5.
- R-Unit** Selects the measurement data display mode from the Exponent mode and the Prefix mode. (See “Setting Display Mode and Display Format” in Chapter 2.)
- Exit** Exits the menu.

Key Lock Key

The key lock key locks out all front panel key inputs except for this key. To cancel the key lock condition, press   again. The key lock state is indicated by the annunciator.

Reset Key

The Reset key resets all instrument settings and correction data to the default values.

The 4339B can also be reset by sending GPIB commands :SYST:PRES and *RST, with the same results, except in a couple of cases. The following table lists the difference among the results of pressing the Reset key and sending the :SYST:PRES and *RST command, and also lists where the settings are stored in.

Data stored in back-up memory is held for about 72 hours after powering OFF. The items saved by the Save key or recalled by the recall key are the same as those stored in the back-up memory. Data stored in EEPROM is not affected by powering OFF.

Table 3-3. Reset Settings

Item	Reset key	SYST:PRES ¹	*RST ¹	Stored in
Test voltage output state	OFF	←	←	None
Test voltage level	0 V	←	←	Back-up memory
Current limit	0.5 mA	←	←	Back-up memory
Measurement parameter	R	←	←	Back-up memory
Thickness of DUT	2 mm	←	←	Back-up memory
Electrode size (<i>DI</i>)	50 mm	←	←	Back-up memory
Electrode size (<i>AREA</i>)	19.635 mm ²	←	←	Back-up memory
Electrode size (<i>PERIMETER</i>)	18.850 cm	←	←	Back-up memory
Electrode size (<i>GAP</i>)	1.000 cm	←	←	Back-up memory
Effective area coefficient (<i>B</i>)	0	←	←	Back-up memory
Deviation measurement	OFF	←	←	Back-up memory
Deviation reference value	Cleared	←	←	Back-up memory
Measurement range mode	Auto	←	←	Back-up memory
Measurement range	(Auto)	←	←	Back-up memory
Measurement time mode	Medium	←	←	Back-up memory
Averaging rate	1	←	←	Back-up memory
Trigger mode	Internal	←	←	Back-up memory
Trigger delay time	0 s	←	←	Back-up memory
Contact Check ON/OFF state	OFF	←	←	Back-up memory
LimitC value	0	←	←	Back-up memory
Offset value	0	←	←	Back-up memory
Comparator ON/OFF state	OFF	←	←	Back-up memory
Comparator limits	MAX/MIN	←	←	Back-up memory
Program sequence running	Aborted	←	←	None
Program sequence	OFF	←	←	Back-up memory
Change time	0 s	←	←	Back-up memory
Interval time	1 s	←	←	Back-up memory
Memory size	500	←	←	Back-up memory
Display mode	Measured Display	←	←	Back-up memory
Correction ON/OFF state	ON	←	OFF	None
Correction data	Cleared	←	←	EEPROM
Offset-Error Canceling	OFF	←	←	EEPROM

¹ “←” indicates the value is the same as what is indicated to the left.

Table 3-3. Reset Settings (continued)

Item	Reset key	SYST:PRES ¹	*RST ¹	Stored in
Beep ON/OFF state	ON	←	←	EEPROM
Beep mode	FAIL mode	←	←	EEPROM
Data transfer format	ASCII	←	←	EEPROM
Power line frequency	No effect	←	←	EEPROM
GPIB Address	No effect	←	←	EEPROM
Key lock	N/A	No effect	OFF	None
:INT:CONT	ON	←	OFF	None

Configuration Key  

The Configuration key allows you to set the offset-error canceling, the beep mode, and the power line frequency, and to run the self-test.

Offset Sets the offset-error canceling ON or OFF. This function automatically cancels the offset error due to the temperature change every 30 seconds, when the measurement range is 100 pA or 1 nA, and the measurement time mode is the Long mode. When this function is set to OFF, the offset error may increase a little. The default setting is OFF.

The following figure shows the measurement timing diagram when the offset-error canceling is set to ON.

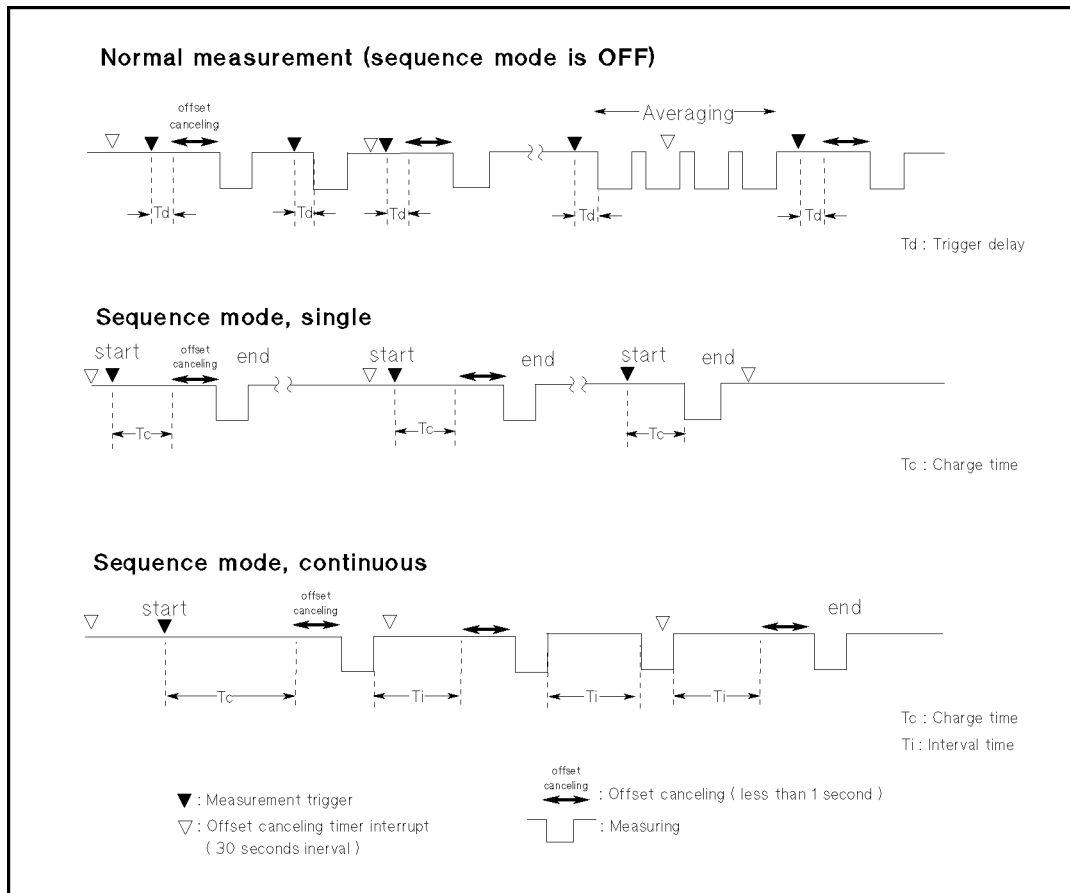

Figure 3-3. Offset-Error Canceling Timing Chart

- Beep** Comparison results output to the beeper are classified into following modes:
- OFF** Does not emit a beep (no output to beeper).
 - PASS** Emits a beep when the comparison result is IN.
 - FAIL** Emits a beep when the comparison result is HIGH, LOW or N.C.. (default)

Note

In the OFF mode, the 4339B does *not* emit a beep when a system error or operation error occurs.

more Displays other items of this menu.

- **Line** — Available power LINE frequency selections are 50 Hz and 60 Hz.
- **Svc** — There are five service functions.
 - KEY** Tests the front-panel keys.
 - HNDL** Tests the handler output signal.
 - CSUM** Runs the ROM check sum program.
 - RAM** Tests RAM (the read-write test). After the test, the 4339B resets the instrument's settings.
 - EEPROM** Tests EEPROM. The data stored in EEPROM is not affected when no error is detected. If errors are detected, the 4339B clears the data and restores the default data.
- **TEST (Self-test)** — The self-test tests the 4339B's basic performance and displays the results as the sum of error codes of each existing error.

The 4339B also executes its self-test when it is turned ON (power-on test). The settings of the 4339B are not affected by the self-test, except when errors occur.

Item	Result	Error Code
1. Beeper	beep once	-
2. Display	display all digits and segments	-
3. RAM	display error message if an error occurs ¹	1
4. EPROM	display error message if an error occurs ¹	2
5. Calibration data (EEPROM)	display error message if an error occurs ¹	4
6. User's data (EEPROM)	display error message if an error occurs ²	8
7. AD converter	display error message if an error occurs ¹	16
8. Backup RAM	display error message if an error occurs ²	32

¹ During the power-on test, the 4339B stops operation if an error occurs.

² During the power-on test, the 4339B uses default values and continues the test.

Exit Returns to measurement.

Rear Panel

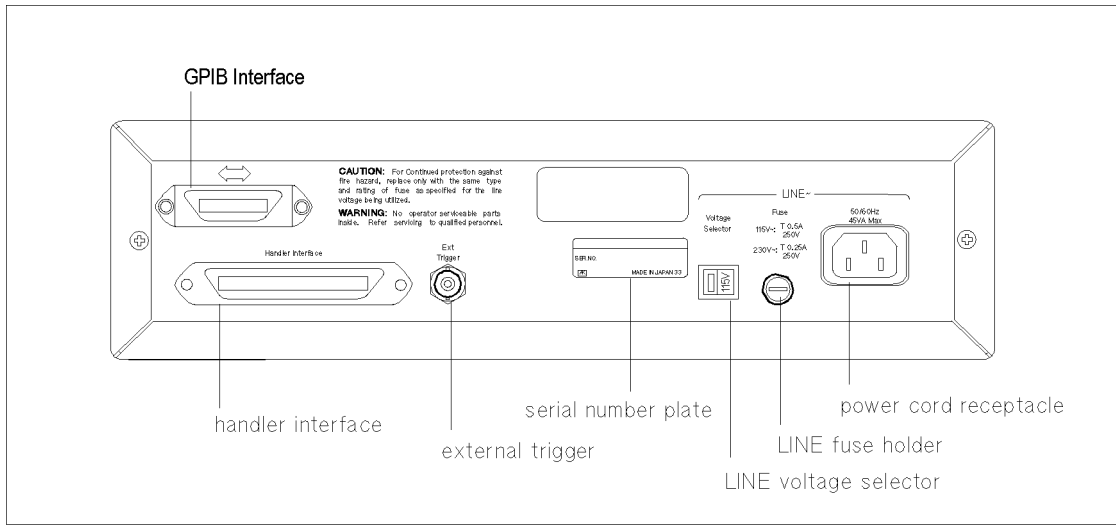

Figure 3-4. Rear Panel

External Trigger

The Ext (External) Trigger terminal is used to trigger the 4339B by inputting a positive-going TTL pulse, when the 4339B is set to external trigger mode. Figure 3-5 shows the specifications required for the TTL pulse.

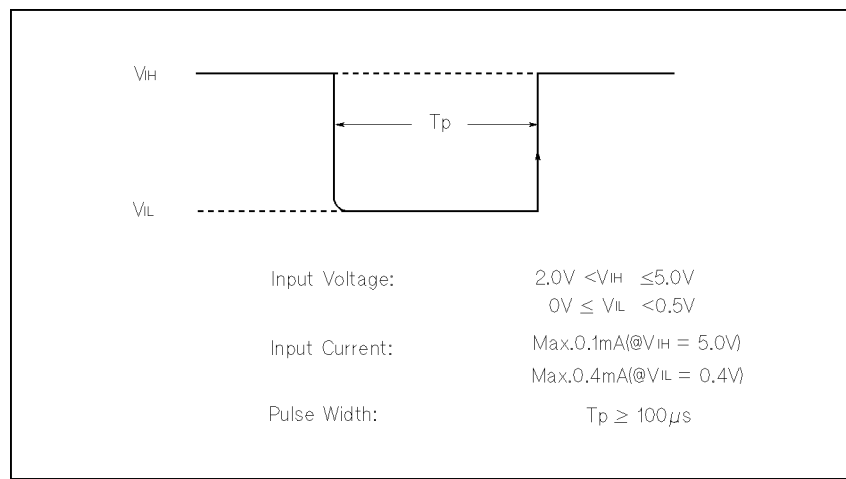

Figure 3-5. Required External Trigger Pulse Specification

LINE Fuse Holder

The 4339B's line fuse is selected depending on the LINE Voltage selection. Refer to Table 1-1.

LINE Voltage Selector

The Line Voltage Selector is used to match the 4339B to the power line voltage being used. Refer to Table 1-1.

Power Cord Receptacle

The Power Cord Receptacle is used to plug in the power cord.

Power Cord

The 4339B is equipped with a three-conductor power cord that, when plugged into the appropriate AC power receptacle, grounds the instrument. The offset pin on the power cord is the safety ground.

Serial Number Plate

The serial number plate provides manufacturing information about the 4339B. For details, see "Serial Number" in Appendix A.

Handler Interface

Handler interface is used to synchronize timing with an external handler.

Before using the handler interface, you must connect pull-up resistors to enable the output signals and set the dip switch to select the voltage level to match the input signals. Refer to Appendix B for these procedures.

Specifications

- **Output signal** : Negative TRUE, open collector, opto-isolated

Decision Output:

Primary parameter Comparator High, In, Low
 Secondary parameter Comparator High, In, Low
 DUT and test electrode's contact failed.

Index: Analog measurement complete

Measurement complete: Full measurement complete

Alarm: Notification that a momentary power failure was detected or the error occurs.

- **Input Signal** : Opto-isolated

Keylock: Front panel keyboard lockout

External Trigger: Pulse width $\geq 1 \mu s$

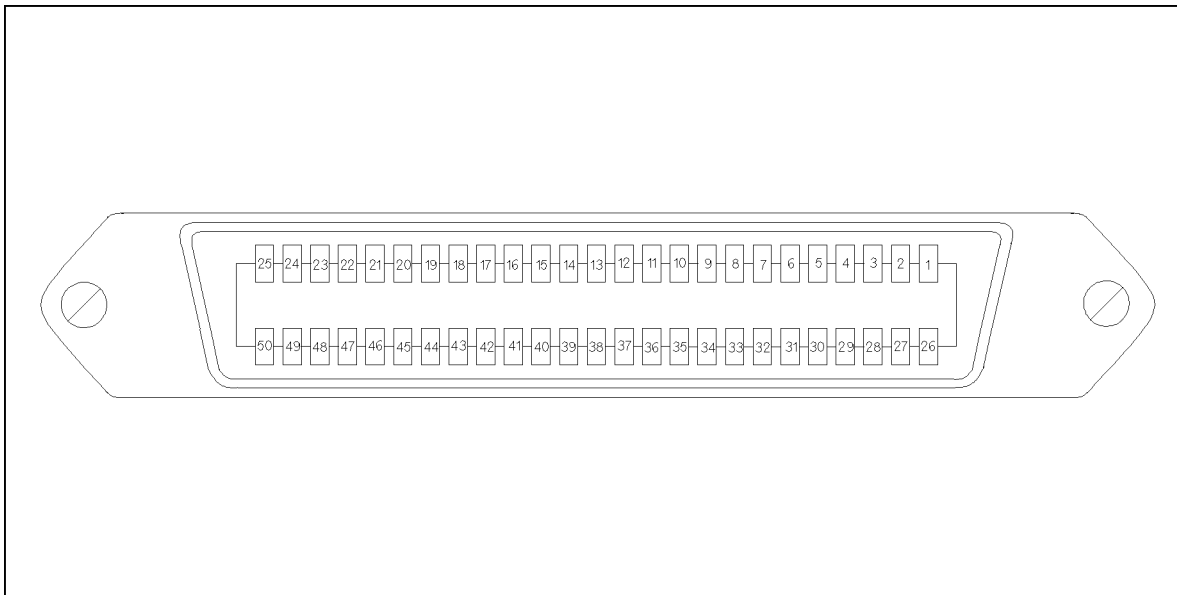

Figure 3-6. Pin Assignment for Handler Interface Connector

Table 3-4. Contact Assignment for Comparator Function

Pin No.	Signal Name ¹	Description
1 2	EXT DCV1 EXT DCV1	External DC Voltage 1: DC voltage supply pins for DC isolated open collector outputs (/HI, /IN/, /LO/, /NO CONTACT). Maximum voltage is +24 V, minimum +5
17	/HV OFF	Voltage Source OFF: When this line is asserted, output of the voltage source is disabled.
18	/KEY LOCK	Key Lock: When this line is asserted, all of the 4339B's front panel key functions are disabled.
19	/EXT TRIG	External Trigger: 4339B is triggered on the rising edge of a pulse applied to this pin when the trigger mode is set to the External. ²
20 21	EXT DCV2 EXT DCV2	External DC voltage 2: DC voltage supply pins for DC Isolated inputs (/EXT TRIG, /KEY LOCK, /HV OFF) and DC Isolated outputs (/INDEX, /EOM, /NOT READY, /ALARM). Maximum voltage is +15 V, minimum +5 V
24 25	+5 V +5 V	Internal voltage supply (max. output 0.1 A): Exceeding 0.1 A will cause the internal voltage output and the output signals to go to zero.
26 27	COM1 COM1	Common for EXT DCV1
28	/HI	This signal is asserted, when the comparison result is High. ³
29	/IN	This signal is asserted, when the comparison result is In. ³
30	/LO	This signal is asserted, when the comparison result is Low. ³
37	/NO CONTACT	This signal is asserted, when the contact check failed. ³
41	/NOT READY	Not ready: This signal is asserted when the current flowing through the DUT exceeds the current limit.
42	/ALARM	Alarm: This signal is asserted when a power failure occurs or the error (E11, E12, E13, E14, E15, E20 or E-313) occurs.
43	/INDEX	Index: This signal is asserted when an analog measurement is complete and the 4339B is ready for the next DUT to be connected to the UNKNOWN terminals. The measurement data, however, is not valid until /EOM is asserted.
44	/EOM	End of Measurement: This signal is asserted when the measurement data and comparison results are valid.
45 46	COM2 COM2	Common for EXT DCV2
49 50	GND GND	Ground tied to chassis.

1 The / (slash) means that the signal is asserted when low.

2 If an error occurs and the 4339B stops operation, the 4339B will not trigger a measurement after receiving the /EXT TRIG signal.

3 If an error occurs and the 4339B stops operation, these lines maintain the condition just before the error occurred.

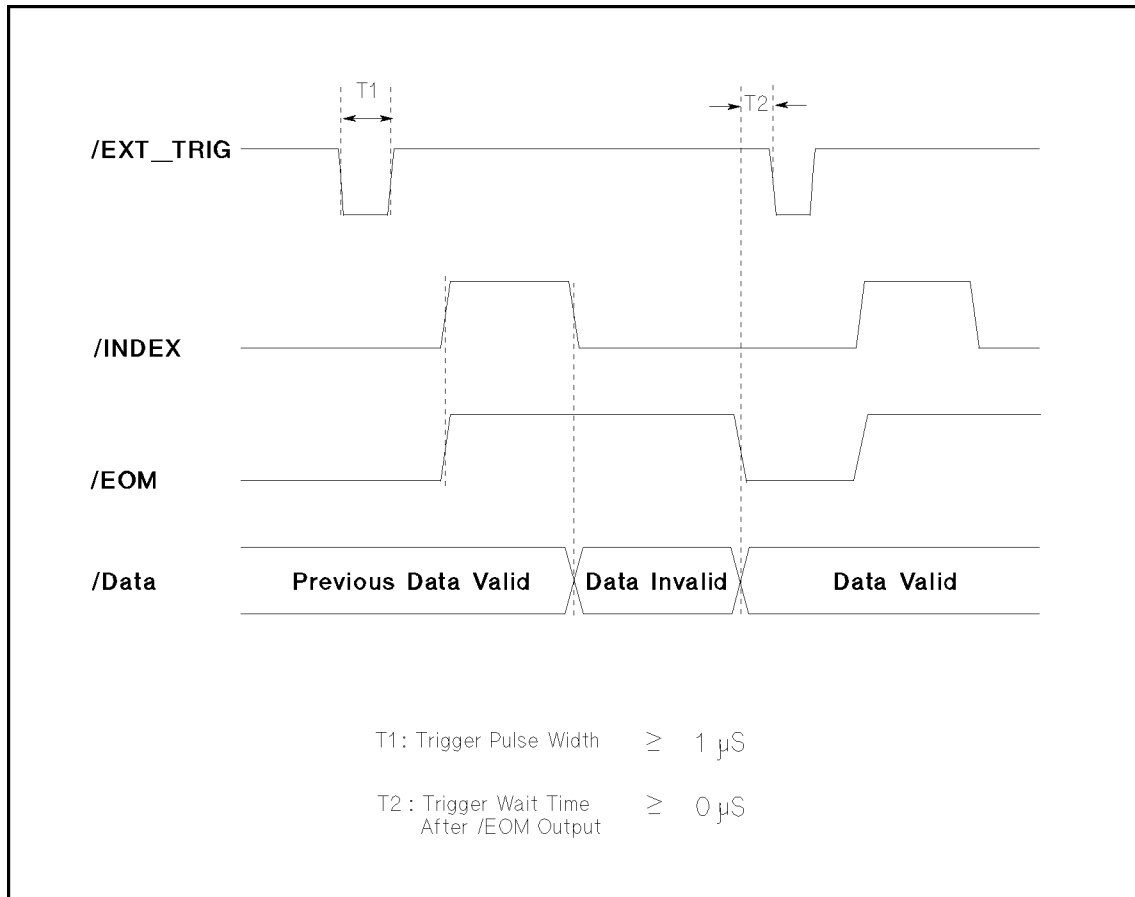

L6003004

Figure 3-7. Timing Diagram

Note



This timing diagram is also applied when the contact check fails, because the measurement is performed and the measurement result is output, even if the contact check fails.

Note



All the output signals are available only when the comparator function is ON.

GPIB Interface

The GPIB Interface is used for remote control of the 4339B using the General Purpose Interface Bus (GPIB).

GPIB is a standard for interfacing instruments to computers, and supports for IEEE 488.1 , IEC-625 , IEEE 488.2 , and JIS-C1901 . GPIB allows instruments to be controlled by an external computer which sends commands or instructions to and receives data from the instrument.

With the GPIB system, many different types of devices including instruments, computers, plotters and printers can be connected in parallel. When configuring an GPIB system, the following restrictions must be adhered to:

- The length of cable between one device and another must be less than or equal to four meters. The total length of cable in one bus system must be less than or equal to two meters times the number of devices connected on the bus (the GPIB controller counts as one device) and must not exceed 20 meters.
- A maximum of 15 devices can be connected on one bus system.
- There are no restrictions on how the cables are connected together. However, it is recommended that no more than four piggyback connectors be stacked together on any one device, or else the resulting structure could exert enough force on the connector mounting to damage it.

Every GPIB device has its own unique identification address. The available GPIB addresses are integer numbers from 0 to 30. Every device on an GPIB bus must have a unique address.

Table 3-5 lists the 4339B's GPIB capability and functions. These functions provide the means for an instrument to receive, process, and transmit commands, data, and status over the GPIB bus.

Table 3-5. GPIB Interface Capability

Code	Function
SH1	Complete source handshake capability
AH1	Complete acceptor handshake capability
T5	Basic talker; serial poll; Unaddressed if MLA; Talk-Only
L4	Basic listener; Unaddressed if MTA; no Listen Only
SR1	Service request capability
RL1	Remote/Local capability
DC1	Device clear capability
DT1	Device trigger capability
C0	No controller capability
E1	Drivers are open-collector

Theory of Operation

This section provides the 4339B's theory of operation.

In "Overall Measurement Theory" and "Overall Block Diagram", we will discuss the measurement theory with the ungrounded DUT measurement configuration. These descriptions can also be applied to the measurement of a grounded DUT, considering the test signal flow shown in Figure 3-10 (b).

Overall Measurement Theory

The 4339B measures the Device Under Test (DUT) resistance in the following manner.

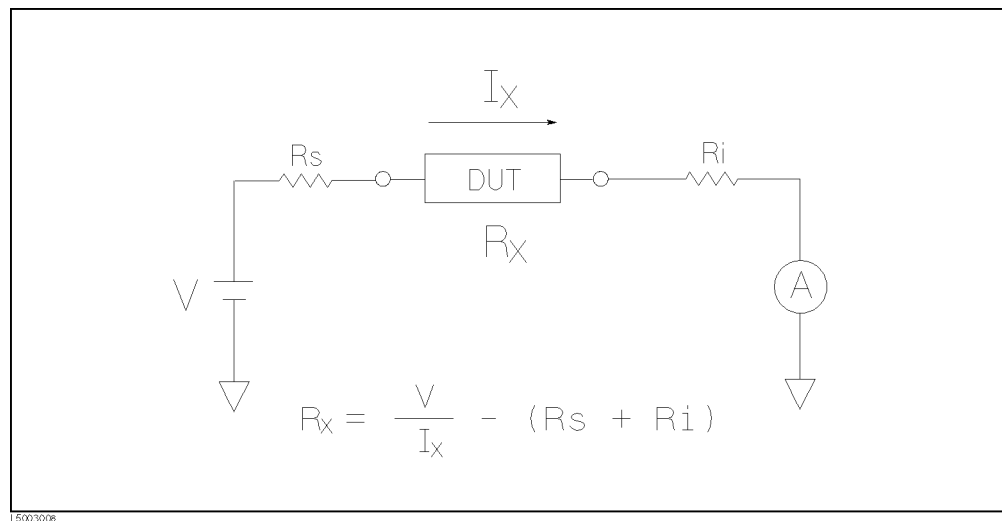

Figure 3-8. Simplified Model of Impedance Measurement

Figure 3-8 shows a simplified model of the 4339B measuring a DUT. In the Figure 3-8, the DUT is connected in series with a test voltage source, V , and an ammeter, A . R_s is the 4339B's source resistance ($R_s = 1k\Omega$) and R_i is the input resistance ($R_i = 1k\Omega$).

In the resistance measurement mode (the measurement parameter is R), the 4339B displays the "derived" DUT resistance, R_x . In other words, if the ammeter measures I_x when the source voltage is V , the 4339B displays the DUT resistance R_x , calculated using the following equation:

$$R_x = \frac{V}{I_x} - (R_s + R_i)$$

In the current measurement mode (the measurement parameter is I), the 4339B measures the actual current value, I_x , which flows through the DUT, and displays the value for the measurement result. For example, if R_x is $100k\Omega$, and V is $1V$, the measurement result will be $9.8\mu A$ ($\frac{1V}{100k+2k}$). If you measure a DUT whose resistance value is lower, the 4339B's source resistance, R_s , and input resistance, R_i , affect the measurement current value, I_x , more.

Overall Block Diagram

Figure 3-9 shows the overall block diagram of the 4339B.

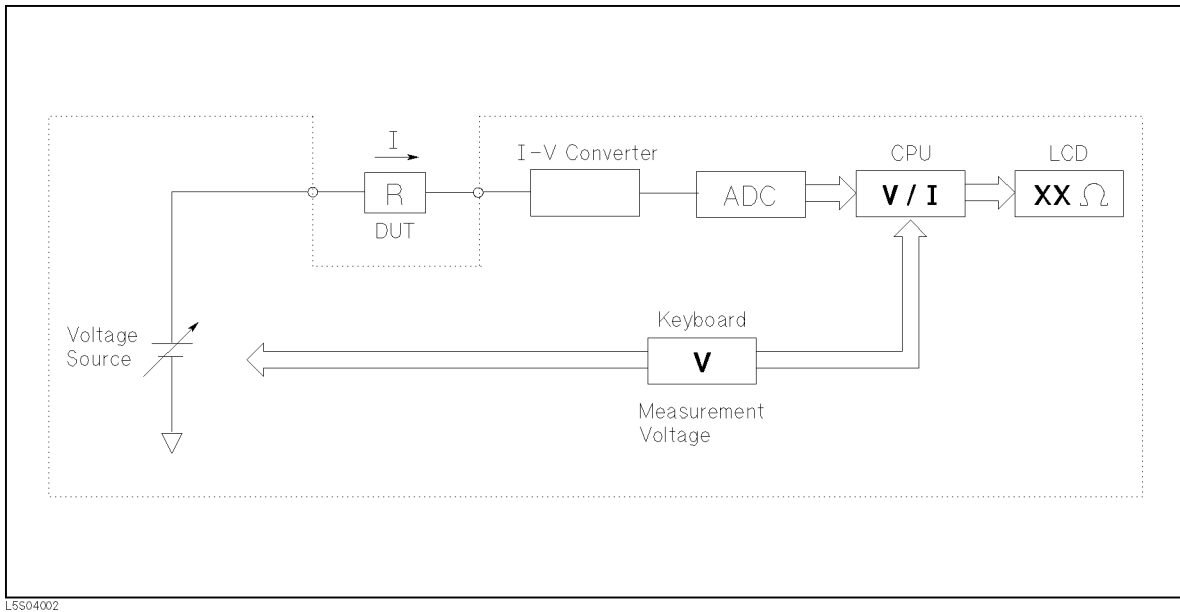

Figure 3-9. 4339B Overall Block Diagram

The voltage source applies a dc voltage which is set by the keyboard or by an GPIB command. The I-V converter, which is directly connected to the input, converts the current into a voltage ramp, of which the slope is proportional to the input current. The CPU calculates the current from the voltage ramp slope, then calculates the DUT's resistance by dividing the source voltage by the current.

Grounded and Ungrounded DUT Measurement Configuration

The 4339B has the capability to measure both grounded and ungrounded DUTs.

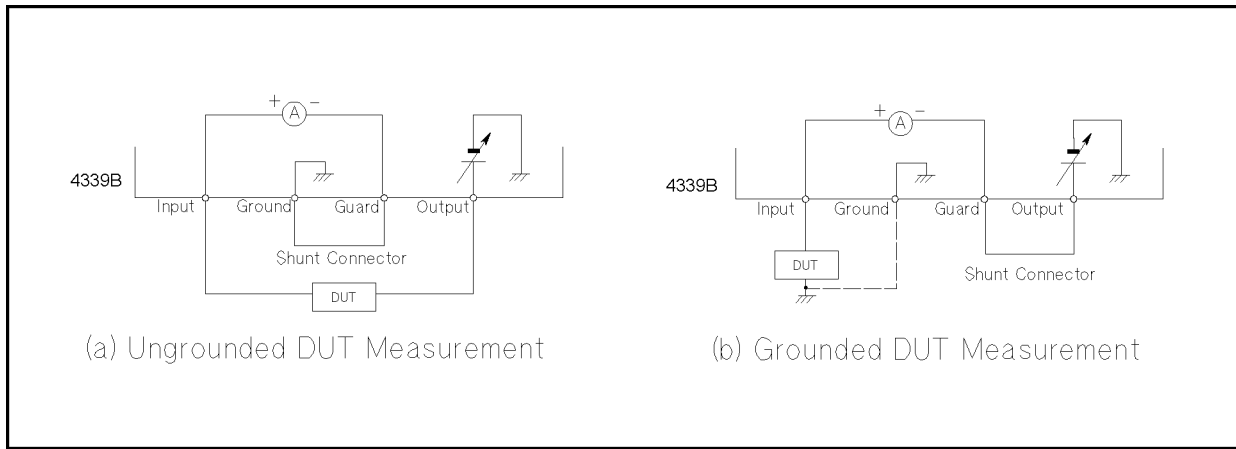

Figure 3-10. Ungrounded and Grounded DUT Measurement

In Figure 3-10 (a), the Ground and the Guard terminal are connected by a shut connector. The Input terminal is connected to one side of the DUT, while the other side of the DUT is connected to the Output terminal. In this configuration, the Output terminal supplies the test voltage to the DUT, and the test current through the DUT is input to the 4339B through the Input terminal, which is connected to the ammeter circuit.

In Figure 3-10 (b), the Guard and Output terminals are connected by the shut connector, and the Input terminal is connected to the grounded DUT. The Output terminal supplies the test voltage to the DUT (through the ammeter circuit).

When you measure the grounded DUT, the Ground terminal may be left open, however, for more precise measurement, the Ground terminal and the DUT's ground should be connected to each other as a common ground.

Note



The 4339B's ammeter measures the test current as a positive value when current flows from the Input terminal to the Guard terminal. So, an ungrounded DUT measurement results in a positive current value, and a grounded DUT measurement results in a negative current value. (Resistance, R , is always a positive value.)

Remote Operation

Introduction

This chapter provides step-by-step instructions for controlling the 4339B using GPIB remote mode. The examples in this manual use the HP 9000 series 200 or 300 BASIC language. This chapter covers the following:

- Getting started
- Setting up the 4339B
- Triggering a measurement
- Retrieving measurement data
- Other features
- If you have a problem

Refer to Chapter 5 for the description of each GPIB command.

Note



In this chapter, all commands are spelled in abbreviated (short) form. Refer to “Command Abbreviations” in Chapter 5 for more information.

Note



This chapter is not intended to teach BASIC programming language or the Standard Commands for Programmable Instruments (SCPI) programming, or to discuss GPIB theory; refer to the following documents which are better suited for these tasks.

For more information concerning BASIC, refer to the manual set for the BASIC version being used:

BASIC Programming Techniques
BASIC Language Reference

For more information concerning SCPI, refer to the following:

Beginner’s Guide to SCPI

For more information concerning GPIB operation, refer to the following:

BASIC Interfacing Techniques
Tutorial Description of the General Purpose Interface Bus
Condensed Description of the General Purpose Interface Bus

Getting Started

This section will teach you the basics of operating the 4339B in GPIB remote mode (from now on referred to as remote). This includes reading the GPIB address, sending commands to the 4339B, and retrieving data from the 4339B.

Input/Output Statements

The statements used to operate the 4339B in remote depend on the computer and the programming language being used. In particular, you need to know the statements the language uses to input and output information. The input statements for the HP 9000 series 200 or 300 BASIC language are:

ENTER or TRANSFER

The output statement is:

OUTPUT

Read your computer manuals to find out which statements you need to use.

Reading the GPIB Address

Before you can operate the 4339B in remote, you need to know its GPIB address (factory setting=17). To check the address, press  . A typical display is:

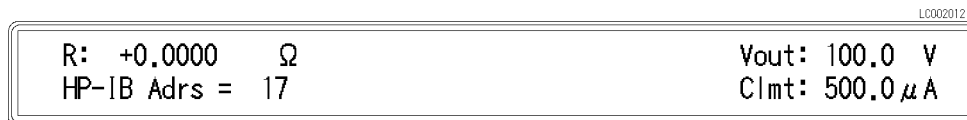

The displayed response is the device address. When sending a remote command, you append this address to the GPIB interface's select code (normally 7). For example, if the select code is 7 and the device address is 17, the appended combination is 717.

Every device on the GPIB bus must have a unique address. You can assign new GPIB addresses.



Sending a Remote Command

To send a remote command to the 4339B, combine the computer's output statement with the GPIB select code, the device address, and finally the 4339B command. For example, to reset the 4339B, send:

```
OUTPUT 717;"*RST"
```

Notice that the display's **Rmt** annunciator(▼) turns ON. This means the 4339B is in the remote mode.

Returning to Local Mode

When you press a key on the 4339B's keyboard while operating in remote, the 4339B does not respond. This is because in remote (as indicated by the display's **Rmt** annunciator) the 4339B ignores all front panel inputs except the  key. To return the 4339B to the Local mode, press the .

Query Commands

There are several commands in the alphabetic command directory that end with a question mark. These commands are called query commands because each returns a response to a particular question.

In addition to the queries described above, you can create others by appending a question mark to most commands.

Getting Data from the 4339B

The 4339B can output readings and responses to query commands. As an example, have the 4339B generate a response to a query command by sending:

```
OUTPUT 717;"*IDN?"
```

When you send a query from remote, the 4339B does not display the response as it would if you executed the command from its front panel. Instead, the 4339B sends the response to its output buffer. The output buffer is a register that holds a query response or data for a single measurement until it is read by the computer or replaced by new information. Use the computer's input statement to get the response from the output buffer. For example, the following program reads the response (4339B) and prints it.

```
10 ENTER 717;A$  
20 PRINT A$  
30 END
```

To Control the 4339B from an External Computer

Most measurements can be modeled by the following simple four step sequence:

1. Set up the instrument.

Typically, you begin the setup step by sending the *RST command to set the instrument to its default settings. Next, if you need values different from the default settings, change the settings one by one as required.

2. Trigger the measurement.

The trigger may be generated automatically by steps taken in your setup commands, or you may send an explicit trigger command. To select the trigger source, send the :TRIG:SOUR command with the trigger source parameter. When you select BUS as the trigger source, sending *TRG triggers a measurement and retrieves the measurement data.

3. Retrieving the data.

4. Turn OFF the test voltage and end the measurement.

Figure 4-1 shows a simple resistance measurement program.

```

:
! Step 1                               Resetting
OUTPUT 717;"*RST"
OUTPUT 717;" :INIT:CONT ON"           Initializing trigger system
OUTPUT 717;" :FUNC 'RES'"             Resistance measurement
OUTPUT 717;" :SOUR:VOLT 10"           Test voltage: 10 V
OUTPUT 717;" :OUTP ON"                 Applying test voltage
OUTPUT 717;" :TRIG:SOUR BUS"          Trigger source: Bus
! Step 2                               Triggering
OUTPUT 717;"*TRG"
! Step 3                               Retrieving the data
ENTER 717;R_value
! Step 4                               Turning OFF test voltage
OUTPUT 717;" :OUTP OFF"
:

```

Figure 4-1. Simple Program Example

The following sections describes how to perform specific tasks.

To Set Up the 4339B

To Reset the 4339B

The following commands reset the 4339B:

- *RST
- :SYST:PRES

Note



The *RST command also initiates the trigger system also and places trigger sequence in the IDLE state. Refer to “Trigger System” in Chapter 5 for more information.

For example,

```
OUTPUT 717;"*RST"
```

To Set the Power LINE Frequency

The following command sets the power line frequency:

- SYST:LFR

For example, to set the LINE frequency to 50 Hz,

```
OUTPUT 717;":SYST:LFR 50"
```

To Select the Measurement Parameter

The following commands select the measurement parameter:

- :SENS:FUNC
- :CALC:FORM

To select Resistance,

```
OUTPUT 717;":SENS:FUNC 'RES' "
```

To select Volume Resistivity,

```
OUTPUT 717;":SENS:FUNC 'RES' "
OUTPUT 717;":CALC:FORM VRES"
```

To select Surface Resistivity,

```
OUTPUT 717;":SENS:FUNC 'RES' "
OUTPUT 717;":CALC:FORM SRES"
```

To select Current,

```
OUTPUT 717;":SENS:FUNC 'CURR' "
```

To Set the Test Voltage

The following command sets the test voltage:

- :SOUR:VOLT

For example, to set 10 V as the test voltage,

```
OUTPUT 717;":SOUR:VOLT 10"
```

**To Apply the Test Voltage**

The following commands apply the test voltage:

■ :OUTP

For example,

```
OUTPUT 717;":OUTP ON"
:
OUTPUT 717;":OUTP OFF"
```



Warning Sending :OUTP command may cause the 4339B to output a dangerous voltage levels up to 1000 Vdc. Do *NOT* touch the UNKNOWN terminals or the electrodes of the accessory, when the V Output indicator is ON.

**To Set the Current Limit**

The following command sets the current limit value:

■ :SOUR:CURRE:LIM

For example, to set 0.5 mA as the current limit value,

■ OUTPUT 717;":SOUR:CURRE:LIM 0.5MA"

To Select Measurement Time Mode

The following command selects the measurement time mode:

■ :SENS:CURRE:APER

To set the measurement time mode to SHORT:

```
OUTPUT 717;":SENS:CURRE:APER 0.01"
```

To set the measurement time mode to MEDIUM:

```
OUTPUT 717;":SENS:CURRE:APER 0.03"
```

To set the measurement time mode to LONG:

```
OUTPUT 717;":SENS:CURRE:APER 0.39"
```

To Perform Calibration

The following command calibrates the 4339B:

■ :CAL?

For example,

```
:
OUTPUT 717;":CAL?"
ENTER 717;A
IF A<>0 THEN
  PRINT "Error:",A
  PAUSE
END IF
:
```

To Perform OPEN Correction

The following command performs an OPEN correction:

■ :SENS:CORR:COLL OFFS

For example,

```

:
DISP "Connect the test fixture without a DUT, then press 'Continue'."
PAUSE                               Current measurement
OUTPUT 717;":SENS:FUNC 'CURR'"
OUTPUT 717;":SENS:CURR:APER 0.39"   Measurement time mode: Long
OUTPUT 717;":SOUR:VOLT 10"         Test voltage: 10 V
OUTPUT 717;":OUTP ON"              Applying test voltage
REPEAT                               Retrieving the data
  OUTPUT 717;":FETC?"
  ENTER 717;S,D                     Wait until current is within 0.5 pA
UNTIL ABS(D)<5.E-13
OUTPUT 717;":SENS:CORR:COLL OFFS"   Performing OPEN correction
OUTPUT 717;":*OPC?"                Wait until OPEN correction ends
ENTER 717;A                          Turning OFF test voltage
OUTPUT 717;":OUTP OFF"
:

```

To Select the Measurement Range

The following commands select the measurement range:

■ :SENS:CURR:RANG

■ :SENS:CURR:RANG:AUTO

For example, to select the Auto range mode,

```
OUTPUT 717;":SENS:CURR:RANG:AUTO ON"
```

For example, to select the 1 nA range,

```
OUTPUT 717;":CURR:RANG:AUTO OFF"
OUTPUT 717;":CURR:RANG 1E-9"
```

To Set the Averaging Rate

The following commands set the averaging rate:

■ :SENS:AVER

■ :SENS:AVER:COUN

For example, to set the averaging rate to 4,

```
OUTPUT 717;":AVER:COUN 4"
```

To Set Trigger Delay Time

The following command sets the trigger delay time:

■ :TRIG:DEL

For example, to set the trigger delay time to 10 ms,

```
OUTPUT 717;":TRIG:DEL 1E-2"
```

To Set the Parameters for Resistivity Measurements

The following commands set the parameters for resistivity measurements:

- :CALC:RES:STH
- :CALC:RES:EPER
- :CALC:RES:GLEN
- :CALC:RES:EAR

For example, to measure the volume resistivity, when the thickness of DUT is 2 mm, and when you use the ϕ 50 mm electrode and 70 mm guard ring of the 16008B Resistivity Cell, that is,

Thickness is 0.002 m

Effective Area is $0.0019635 (= \pi \times (0.05/2)^2) \text{ m}^2$

Effective Perimeter is $0.1885 (= \pi \times (0.05+0.07)/2) \text{ m}$

Gap is $0.01 (= (0.07-0.05)/2) \text{ m}$.

```
OUTPUT 717;":SENS:FUNC 'RES'"
OUTPUT 717;":CALC:FORM VRES"
!
OUTPUT 717;":CALC:RES:STH 0.002"
OUTPUT 717;":CALC:RES:EAR 0.0019635"
OUTPUT 717;":CALC:RES:EPER 0.1885"
OUTPUT 717;":CALC:RES:GLEN 0.01"
```

To Set Beeper Mode

The following commands set the beeper mode:

- :SYST:BEEP
- :SYST:BEEP:STAT
- :CALC1:LIM:BEEP
- :CALC1:LIM:BEEP:COND

For example, to set the beeper mode to emit a beep when comparison result is PASS.

```
OUTPUT 717;":CALC1:LIM:BEEP:COND PASS"
```

To Lock Out the Front Panel Keys

The following command locks out the front panel keys:

- :SYST:KLOC

For example, to lock out the front panel keys,

```
OUTPUT 717;":SYST:KLOC ON"
```

To Check Contact Integrity at the Test Fixture

The following command checks contacts at the test fixture:

- :SENS:CONT:VER

For example, to enable the contact check function,

```
OUTPUT 717;":SENS:CONT:VER ON"
```

To Use the Comparator Function

The following commands control the comparator function:

- :CALC:LIM:CLE
- :CALC:LIM:FAIL?
- :CALC:LIM:LOW
- :CALC:LIM:LOW:STAT
- :CALC:LIM:UPP
- :CALC:LIM:UPP:STAT
- :CALC:LIM:STAT

For example, to set the limit values and to enable the comparator function,

```

:
OUTPUT 717;":CALC:LIM:LOW 1E10"
OUTPUT 717;":CALC:LIM:UPP 1E11"
OUTPUT 717;":CALC:LIM:STAT ON"
OUTPUT 717;":FETC?"
ENTER 717;S,D,C
:

```

To Display a Deviation Measurement

The following commands display deviation results:

- :DATA
- :CALC:MATH:EXPR:NAME
- :CALC:MATH:EXPR:CAT?
- :CALC:MATH:STAT

For example, to set the reference value using a measurement value and to calculate the absolute deviation value,

```

:
OUTPUT 717;":FETC?"
ENTER 717;s,d
OUTPUT 717;":DATA REF,";d
OUTPUT 717;":CALC:MATH:EXPR:NAME DEV"
OUTPUT 717;":CALC:MATH:STAT ON"
:

```

To Set the Offset-Error Canceling Function

The following command set the offset-error canceling function ON or OFF:

- :CAL:AUTO

For example, to select the offset-error canceling function OFF,

```
OUTPUT 717;":CAL:AUTO OFF"
```

To Wait Until Previously Sent Commands are Completed

The following commands make the 4339B wait until the previously sent commands are completed:

- *OPC
- *OPC?
- *WAI

For example, to wait until the OPEN correction is completed,

```
OUTPUT 717;":SENS:CORR:COLL STAN1"   Perform OPEN correction
OUTPUT 717;"*OPC?"                   Wait for OPEN correction completed
ENTER 717;A
```

To Get the Current Instrument Settings

The following command gets the current instrument settings:

- *LRN?

For example,

```
DIM A$[1000]
:
OUTPUT 717;"*LRN?"
ENTER 717;A$
PRINT A$
```

To Save and Recall Instrument Settings

The following commands save and recall instrument settings:

- *SAV
- *RCL

To save the instrument settings to register no. 1,

```
OUTPUT 717;"*SAV 1"
```

To recall the instrument settings from register no. 1,

```
OUTPUT 717;"*RCL 1"
```

To Trigger a Measurement

The following commands are used to trigger measurements from an external controller and to handle the 4339B's trigger system. Refer to "Trigger System" in Chapter 5 for the information about the 4339B's trigger system.

- :TRIG
- :TRIG:SOUR
- :INIT
- :INIT:CONT
- :ABOR
- *TRG
- :FETC?
- Group Execution Trigger (GET)

Follow the procedure below to perform successive measurements automatically (initial setup).

1. Set the trigger mode to the internal trigger with the **:TRIG:SOUR** command.
2. If the trigger system has not started up (in the idle state), use the **:INIT:CONT** command to turn ON the continuous activation of the trigger system.

Two methods to perform a measurement at your desired time:

Triggering the instrument at your desired time

1. Use the **:TRIG:SOUR** command to set the trigger mode to the GPIB mode.
2. If the trigger system has not started up (in the idle state), use the **:INIT:CONT** command to turn ON the continuous activation of the trigger system.
3. Trigger the instrument at your desired time. An external controller can trigger the instrument with one of the following two commands:

Command	Query response	Applicable trigger mode
*TRG	Yes (The measured result is read out.)	GPIB trigger
:TRIG	No	All

4. To repeat measurement, repeat Step 3.

Starting up the trigger system at your desired time

1. If the trigger system has started up (in a state other than the idle state), use the **:INIT:CONT** command to turn OFF the continuous activation of the trigger system and then use the **:ABOR** command to stop the trigger system.
2. Set the trigger mode to the internal trigger with the **:TRIG:SOUR** command.
3. Start up the trigger system with the **:INIT** command at your desired time. The instrument will be automatically triggered by the internal trigger and measurement will be performed once.
4. To repeat measurement, repeat Step 3.

Waiting For Completion Of Measurement (detecting completion of measurement)

You can detect the status of the 4339B by using the status register, as described in this section. For information on the entire status report system (for example, information on each bit of the status register), refer to Chapter 5, “GPIB Reference.”

The measurement state is indicated by the operation status register (refer to Table 5-5). An SRQ (service request) is useful for detecting the completion of measurement in your program by using the information indicated by this register.

To detect the completion of measurement using SRQ, use the following commands.

- *SRE
- :STAT:OPER:ENAB

The procedure is given below.

1. Make the setup so that the 4339B generates an SRQ if bit 4 of the operation status event register is set to 1.
2. Trigger the instrument to start a measurement.
3. Perform interrupt handling in the program when the SRQ occurs.

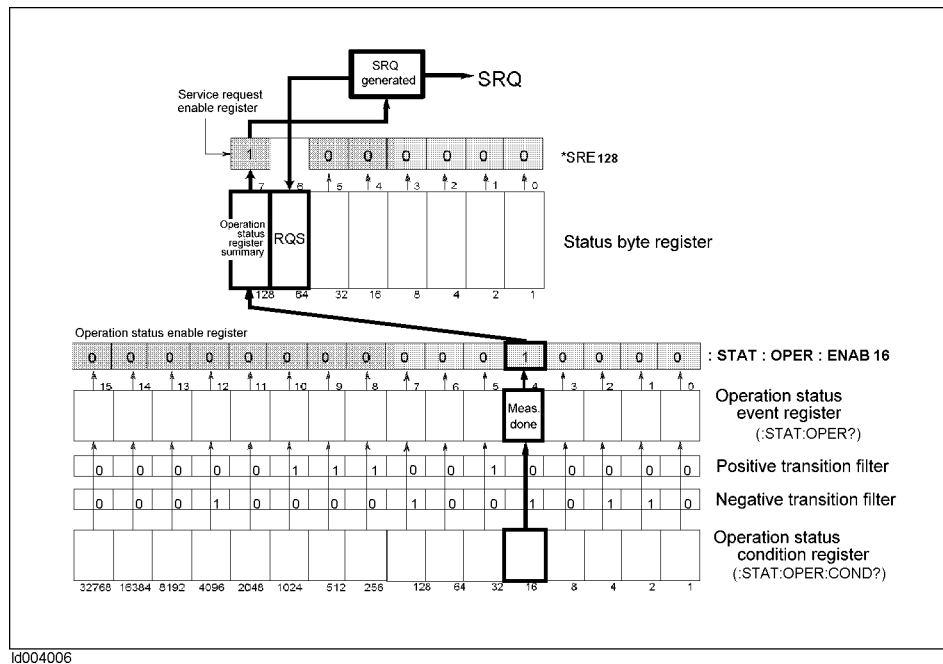

Figure 4-2. SRQ generation sequence (when measurement finishes)

4339B Waiting For Completion Of Measurement (detecting completion of measurement)

Sample program

Figure 4-3 shows a sample program to detect the completion of measurement using an SRQ.

This program stops the trigger system, sets up SRQ, and then starts up the trigger system once. When an SRQ of the completion of the measurement occurs, it displays a "Measurement Complete" message and finishes.

The program is detailed below.

Line 20	Sets the GPIB address.
Lines 40 to 60	Stops the trigger system and sets the trigger mode to the internal trigger.
Lines 80 to 90	Enables bit 4 of the operation status event register and enables bit 7 of the status byte register.
Lines 100 to 120	Clears the status byte register and operation status event register.
Lines 140 to 150	Sets the branch destination of the SRQ interrupt and enables the SRQ interrupt.
Lines 160 to 180	Starts up the trigger system once to start the measurement and waits for the completion of the measurement.
Line 230	Displays "Measurement Complete" message.

```
10 DIM Buff$(9)
20 ASSIGN @Agt4339b TO 717
30 !
40 OUTPUT @Agt4339b ; " : INIT:CONT OFF"
50 OUTPUT @Agt4339b ; " : ABOR"
60 OUTPUT @Agt4339b ; " : TRIG:SOUR INT"
70 !
80 OUTPUT @Agt4339b ; " : STAT:OPER:ENAB 16"
90 OUTPUT @Agt4339b ; " * SRE 128"
100 OUTPUT @Agt4339b ; " * CLS"
110 OUTPUT @Agt4339b ; " * OPC?"
120 ENTER @Agt4339b ; Buff$
130 !
140 ON INTR 7 GOTO Meas_end
150 ENABLE INTR 7 ; 2
160 OUTPUT @Agt4339b ; " : INIT"
170 PRINT "Waiting . . ."
180 Meas_wait : GOTO Meas_wait
190 Meas_end : OFF INTR 7
200 PRINT "Measurement Complete"
210 END
```

Figure 4-3. Detecting the completion of measurement using SRQ

Reading Out Measured Result

This section describes how to read out the measured result.

You can read out the measured result in two ways: reading out data for each measurement or reading out data of several measurements in batch.

The three commands shown in the table below can be used to read out the measured data for each measurement.

	Available trigger mode	Readout procedure
Using the *TRG command	GPIB trigger (Bus)	Executing *TRG ↓ Readout
Using the :FETC? command	All	Triggering the instrument ↓ Executing :FETC? ↓ Readout

When you want to read out the data of several measurements in batch, use the data buffer.

Note

The TRIGGER command of HT BASIC has the same function as the ***TRG** command.



Reading out measured result using *TRG command

This command actually performs two tasks: it triggers the instrument and returns the results. It is useful, for example, when you want to retrieve measurement results immediately after triggering the instrument from an external controller.

The readout procedure using the *TRG command is described below.

1. Use the **:TRIG:SOUR** command to set up the trigger mode to the GPIB trigger (Bus).
2. Execute the ***TRG** command.
3. Read out the measured result. To repeat the measurement, repeat Steps 2 and 3.
Figure 4-4 and Figure 4-5 show sample programs using the ***TRG** command. Figure 4-4 is for the ASCII transfer format and Figure 4-5 is for the binary transfer format.

These programs read out the measurement status, measured parameter result, and comparator sorting result (when the comparator function is ON) and then display this information.

The program of Figure 4-4 is detailed below.

Line 60	Sets the GPIB address.
Line 70	Sets the data transfer format to the ASCII format.
Lines 90 to 100	Turns ON the trigger system continuous startup and sets the trigger mode to the GPIB trigger.
Lines 120 to 130	Reads out the ON/OFF state of the comparator function and assigns it to the Comp_flag variable.
Lines 170 to 210	After the trigger system state transitions to the trigger wait state, triggers the instrument.
Line 230	If the Comp_flag value is 1 (the comparator function is ON), reads out the measurement status, measured parameter result, and comparator sorting result.
Line 250	If the Comp_flag value is not 1 (the comparator function is OFF), reads out the measurement status and measured parameter result.
Lines 300 to 310	Displays the measurement status and measured parameter result.
Line 330	If the Comp_flag value is 1 (the comparator function is ON), displays the comparator sorting result.
Line 350	If the Comp_flag value is not 1 (the comparator function is OFF), displays "Comparator : OFF."

```

10    DIM Buff$ [9]
20    REAL Para
30    INTEGER Meas_stat, Comp
40    INTEGER Comp_flag, Cond_reg
50    !
60    ASSIGN @Agt4339b TO 717
70    OUTPUT @Agt4339b ; " : FORM ASC"
80    !
90    OUTPUT @Agt4339b ; " : INIT:CONT ON"
100   OUTPUT @Agt4339b ; " : TRIG:SOUR BUS"
110   !
120   OUTPUT @Agt4339b ; " : CALC : LIM : STAT?"
130   ENTER @Agt4339b ; Comp_flag
140   !
150   ! Triggering and data read
160   !
170   REPEAT
180     OUTPUT @Agt4339b ; " : STAT : OPER : COND?"
190     ENTER @Agt4339b ; Cond_reg
200   UNTIL BIT(Cond_reg,5)
210   OUTPUT @Agt4339b ; " *TRG"
220   IF Comp_flag=1 THEN
230     ENTER @Agt4339b ; Meas_stat, Para, Comp
240   ELSE
250     ENTER @Agt4339b ; Meas_stat, Para
260   END IF
270   !
280   ! Display results
290   !
300   PRINT USING "15A, X, D"; "Meas . status  : ", Meas_stat
310   PRINT USING "15A, X, SD . 5DE"; "Parameter : ", Para
320   IF Comp_flag=1 THEN
330     PRINT USING "15A, X, K"; "Comparator  : ", Comp
340   ELSE
350     PRINT USING "19A "; "Comparator  : OFF"
360   END IF
370   END

```

Figure 4-4.

Reading out the measured result in ASCII transfer format by using the *TRG command

The program of Figure 4-5 is detailed below.

Lines 50 to 60	Sets the GPIB address.
Line 70	Sets the data transfer format to the binary format.
Lines 90 to 100	Turns ON the trigger system continuous startup and sets the trigger mode to the GPIB trigger.
Lines 120 to 130	Reads out the ON/OFF state of the comparator function and assigns it to the Comp_flag variable.
Lines 170 to 210	After the trigger system state transitions to the trigger wait state, triggers the instrument.
Lines 220 to 250	Reads out the header part.
Line 270	If the Comp_flag value is 1 (the comparator function is ON), reads out the measurement status, measured parameter result and comparator sorting result.

Note

Binary data must be read out without formatting. Therefore, use an I/O path (@Binary) set up for such readout. This is also applicable to Line 290.



Line 290	If the Comp_flag value is not 1 (the comparator function is OFF), reads out the measurement status and measured parameter result.
Line 310	Reads out the message terminator at the end of the data.
Lines 350 to 360	Displays the measurement status and measured parameter result.
Line 380	If the Comp_flag value is 1 (the comparator function is ON), displays the comparator sorting result.
Line 400	If the Comp_flag value is not 1 (the comparator function is OFF), displays "Comparator : OFF."

```

10   DIM Buff$ [9], Digit$ [1], Read_form$ [9], Num_of_byte$ [9]
20   REAL Para
30   REAL Meas_stat, Comp
40   INTEGER Comp_flag, Cond_reg
50   ASSIGN @Binary TO 717 ; FORMAT OFF
60   ASSIGN @Agt4339b TO 717
70   OUTPUT @Agt4339b ; " : FORM REAL"
80   !
90   OUTPUT @Agt4339b ; " : INIT : CONT ON"
100  OUTPUT @Agt4339b ; " : TRIG : SOUR BUS"
110  !
120  OUTPUT @Agt4339b ; " : CALC : LIM : STAT?"
130  ENTER @Agt4339b ; Comp_flag
140  !
150  ! Triggering and data read
160  !
170  REPEAT
180    OUTPUT @Agt4339b ; " : STAT:OPER:COND?"
190    ENTER @Agt4339b ; Cond_reg
200  UNTIL BIT(Cond_reg, 5)
210  OUTPUT @Agt4339b ; " *TRG"
220  ENTER @Agt4339b USING "#, A" ; Buff$
230  ENTER @Agt4339b USING "#, A" ; Digit$
240  Read_form$="#, "&Digit$& "A"
250  ENTER @Agt4339b USING Read_form$ ; Num_of_byte$
260  IF Comp_flag=1 THEN
270    ENTER @Binary ; Meas_stat, Para, Comp
280  ELSE
290    ENTER @Binary ; Meas_stat, Para
300  END IF
310  ENTER @Agt4339b USING "#, A" ; Buff$
320  !
330  ! Display results
340  !
350  PRINT USING "15A, X, D" ; "Meas . status : ", Meas_stat
360  PRINT USING "15A, X, SD . 5DE" ; "Parameter : ", Para
370  IF Comp_flag=1 THEN
380    PRINT USING "15A, X, K" ; "Comparator  : ", Comp
390  ELSE
400    PRINT USING "19A" ; "Comparator  : OFF"
410  END IF
420  END

```

Figure 4-5.

Reading out the measured result in binary transfer format using *TRG command

Reading out measured result using :FETC? command

You can use this readout method when you want to trigger the instrument from any source other than an external controller or when you want to perform a process that is between triggering the instrument and reading out the measured result.

The readout procedure using the **:FETC?** command is described below.

1. Set up the trigger mode as necessary.
2. Trigger the instrument by using the method for the trigger mode.

Note

To trigger the instrument from an external controller in this procedure, use the **:TRIG** command.



3. Execute the **:FETC?** command at the completion of the measurement.
4. Read out the measured result. To repeat the measurement, repeat Steps 2 to 4.

Figure 4-6 and Figure 4-7 show sample programs using the **:FETC?** command. Figure 4-6 is for the ASCII transfer format and Figure 4-7 is for the binary transfer format.

These programs, when an external trigger is inputted and the measurement finishes, read out the measurement status, measured parameter result, and comparator sorting result (when the comparator function is ON) and display them.

The program of Figure 4-6 is detailed below.

Line 60	Sets the GPIB address.
Line 70	Sets the data transfer format to the ASCII format.
Lines 90 to 100	Turns ON the trigger system continuous startup and sets the trigger mode to the external trigger.
Lines 120 to 130	Reads out the ON/OFF state of the comparator function and assigns it into the Comp_flag variable.
Lines 170 to 210	Makes the setup generate an SRQ when measurement finishes and clears the status byte register and operation status event register.
Lines 250 to 260	Sets the branch destination of the SRQ interrupt and enables the SRQ interrupt.
Lines 270 to 280	Displays the message to prompt the user to input an external trigger and then waits until the external trigger is inputted and the measurement finishes.
Line 300	Executes the measured result readout command (:FETC?).
Line 320	If the Comp_flag value is 1 (the comparator function is ON), reads out the measurement status, measured parameter result and comparator sorting result.
Line 340	If the Comp_flag value is not 1 (the comparator function is OFF), reads out the measurement status and measured parameter result.
Lines 390 to 400	Displays the measurement status and measured parameter result.
Line 420	If the Comp_flag value is 1 (the comparator function is ON), displays the comparator sorting result.
Line 440	If the Comp_flag value is not 1 (the comparator function is OFF), displays "Comparator : OFF."

```

10    DIM Buff$ [9]
20    REAL Para
30    INTEGER Meas_stat,Comp
40    INTEGER Comp_flag
50    !
60    ASSIGN @Agt4339b TO 717
70    OUTPUT @Agt4339b ; " : FORM ASC"
80    !
90    OUTPUT @Agt4339b ; " : INIT : CONT ON"
100   OUTPUT @Agt4339b ; " : TRIG : SOUR EXT"
110   !
120   OUTPUT @Agt4339b ; " : CALC : LIM : STAT?"
130   ENTER @Agt4339b ; Comp_flag
140   !
150   ! SRQ setting
160   !
170   OUTPUT @Agt4339b ; " : STAT : OPER : ENAB 16"
180   OUTPUT @Agt4339b ; " *SRE 128"
190   OUTPUT @Agt4339b ; " *CLS"
200   OUTPUT @Agt4339b ; " *OPC?"
210   ENTER @Agt4339b ; Buff$
220   !
230   ! Triggering and data read
240   !
250   ON INTR 7 GOTO Meas_end
260   ENABLE INTR 7 ; 2
270   PRINT "Waiting for External Trigger!"
280   Meas_wait : GOTO Meas_wait
290   Meas_end : OFF INTR 7
300   OUTPUT @Agt4339b ; " : FETC?"
310   IF Comp_flag=1 THEN
320     ENTER @Agt4339b ; Meas_stat, Para, Comp
330   ELSE
340     ENTER @Agt4339b ; Meas_stat, Para
350   END IF
360   !
370   ! Display results
380   !
390   PRINT USING "15A, X, D" ; "Meas. status : " , Meas_stat
400   PRINT USING "15A, X, SD . 5DE" ; "Parameter : " , Para
410   IF Comp_flag=1 THEN
420     PRINT USING "15A, X, K" ; "Comparator : " , Comp
430   ELSE
440     PRINT USING "19A" ; "Comparator : OFF"
450   END IF
460   END

```

Figure 4-6.

Reading out the measured result in ASCII transfer format using the :FETC? command

The program of Figure 4-7 is detailed below.

Lines 50 to 60	Sets the GPIB address.
Line 70	Sets the data transfer format to the binary format.
Lines 90 to 100	Turns ON the trigger system continuous startup and sets the trigger mode to the external trigger.
Lines 120 to 130	Reads out the ON/OFF state of the comparator function and assigns it to the Comp_flag variable.
Lines 170 to 210	Makes the setup generate an SRQ when measurement finishes and clears the status byte register and operation status event register.
Lines 250 to 260	Sets the branch destination of the SRQ interrupt and enables the SRQ interrupt.
Lines 270 to 280	Displays the message to prompt the user to input an external trigger and then waits until the external trigger is inputted and the measurement finishes.
Line 300	Executes the measured result readout command (:FETC?).
Lines 310 to 340	Reads out the header part.
Line 360	If the Comp_flag value is 1 (the comparator function is ON), reads out the measurement status measured parameter result and comparator sorting result.

Note

Binary data must be read out without formatting. Therefore, use an I/O path (@Binary) set up as such for readout. This is also applicable to Line 380.



Line 380	If the Comp_flag value is not 1 (the comparator function is OFF), reads out the measurement status and measured parameter result.
Line 400	Reads out the message terminator at the end of the data.
Lines 440 to 450	Displays the measurement status and measured primary parameter result.
Line 470	If the Comp_flag value is 1 (the comparator function is ON), displays the comparator sorting result.
Line 490	If the Comp_flag value is not 1 (the comparator function is OFF), displays "Comparator : OFF."

```

10   DIM Buff$ [9] , Digit$ [1] , Read_form$ [9] , Num_of_byte$ [9]
20   REAL Para
30   REAL Meas_stat, Comp
40   INTEGER Comp_flag
50   ASSIGN @Binary TO 717 ; FORMAT OFF
60   ASSIGN @Agt4339b TO 717
70   OUTPUT @Agt4339b ; " : FORM REAL"
80   !
90   OUTPUT @Agt4339b ; " : INIT:CONT ON"
100  OUTPUT @Agt4339b ; " : TRIG:SOUR EXT"
110  !
120  OUTPUT @Agt4339b ; " : CALC : LIM : STAT?"
130  ENTER @Agt4339b ; Comp_flag
140  !
150  ! SRQ setting
160  !
170  OUTPUT @Agt4339b ; " : STAT : OPER : ENAB 16"
180  OUTPUT @Agt4339b ; " *SRE 128"
190  OUTPUT @Agt4339b ; " *CLS"
200  OUTPUT @Agt4339b ; " *OPC?"
210  ENTER @Agt4339b ; Buff$
220  !
230  ! Triggering and data read
240  !
250  ON INTR 7 GOTO Meas_end
260  ENABLE INTR 7 ; 2
270  PRINT "Waiting for External Trigger!"
280  Meas_wait: GOTO Meas_wait
290  Meas_end: OFF INTR 7
300  OUTPUT @Agt4339b ; " : FETC?"
310  ENTER @Agt4339b USING "# , A" ; Buff$
320  ENTER @Agt4339b USING "# , A" ; Digit$
330  Read_form$="# , " &Digit$&"A"
340  ENTER @Agt4339b USING Read_form$ ; Num_of_byte$
350  IF Comp_flag=1 THEN
360     ENTER @Binary ; Meas_stat, Para, Comp
370  ELSE
380     ENTER @Binary ; Meas_stat, Para
390  END IF
400  ENTER @Agt4339b USING "# , A" ; Buff$
410  !
420  ! Display results
430  !
440  PRINT USING "15A, X, D" ; "Meas . status : " , Meas_stat
450  PRINT USING "15A, X, SD . 5DE" ; "Parameter : " , Para
460  IF Comp_flag=1 THEN
470     PRINT USING "15A, X, K" ; "Comparator : " , Comp
480  ELSE
490     PRINT USING "19A" ; "Comparator : OFF"
500  END IF
510  END

```

Figure 4-7.

Reading out measured result in binary transfer format using :FETC? command

Data Retrieval

After triggering, the output format is,

<stat>,*<data>*,*<comp>*

Where,

<stat> Measurement status

- 0 : Normal
- 1 : Overload
- 2 : No-Contact
- 4 : Over current (exceeding current limit)

<data> Measurement data

<comp> Comparison result (no output when the comparator function is OFF)

- 1 : In
- 2 : High
- 4 : Low
- 8 : No-Contact

To Retrieve Data Efficiently

The basic procedure to retrieve measurement data is described in “To Trigger a Measurement”. This section describes how to retrieve the measurement data efficiently.

To Use Data Buffer

You can use the data buffer to temporarily store the results of several measurements and then later read out these results in batch.

The following commands use the data buffer function:

- :DATA:POIN
- :DATA:FEED
- :DATA:FEED:CONT
- :DATA?

For example,

```
:
OPTION BASE 1
DIM D(1500)
:
OUTPUT 717;":TRIG:SOUR BUS"
!
OUTPUT 717;":DATA:POIN DBUF,500"
OUTPUT 717;":DATA:FEED DBUF,'CALC'"
OUTPUT 717;":DATA:FEED:CONT DBUF,ALW"
!
FOR I=1 TO 500
  OUTPUT 717;":TRIG"
NEXT I
!
OUTPUT 717;":DATA? DBUF"
ENTER 717;D(*)
PRINT D(*)
:
```

To Perform a Measurement Sequence

The following commands perform the sequence measurement:

- : ARM: SOUR
- : ARM: DEL
- : TRIG: SOUR
- : TRIG: TIM
- : TRIG: COUN

Warning  When the 4339B is in the sequence measurement mode, triggering a measurement may output a dangerous voltage levels up to 1000 Vdc. Do *not* touch the UNKNOWN terminals or the electrodes of the accessory, when the V output indicator is ON.



- To perform the single measurement sequence:

```

:
OUTPUT 717;":SOUR:VOLT 10"      Test Voltage: 10 V
OUTPUT 717;":ARM:SOUR BUS"      Measurement Sequence: ON, Trigger Source: Bus
OUTPUT 717;":ARM:DEL 60"        Charge time: 60 s
OUTPUT 717;":TRIG:SOUR INT"     Single mode
OUTPUT 717;":INIT:CONT ON"
OUTPUT 717;"*TRG"
ENTER 717;S,D
PRINT S,D
:

```

- To perform the continuous measurement sequence:

```

OPTION BASE 1
DIM D(20)
:
OUTPUT 717;":SOUR:VOLT 10"      Test Voltage: 10 V
OUTPUT 717;":ARM:SOUR BUS"      Measurement sequence: ON, Trigger Source: Bus
OUTPUT 717;":ARM:DEL 60"        Charge time: 60 s
OUTPUT 717;":TRIG:SOUR TIM"     Continuous mode
OUTPUT 717;":TRIG:TIM 30"       Interval time: 30 s
OUTPUT 717;":TRIG:COUN 10"      Memory size: 10
OUTPUT 717;":INIT:CONT ON"
OUTPUT 717;"*TRG"
ENTER 717;D(*)
PRINT D(*)
:

```

Other Features

To Test the 4339B

The following command runs the 4339B's internal self test:

- *TST?

For example,

```

:
OUTPUT 717;"*TST?"
ENTER 717;A
IF A<>0 THEN PRINT "Self Test: Error"
IF BIT(A,0) THEN PRINT "RAM Test Error"
IF BIT(A,1) THEN PRINT "EPROM Test Error"
IF BIT(A,2) THEN PRINT "Calibration Data Test Error"
IF BIT(A,3) THEN PRINT "User's Data Test Error"
IF BIT(A,4) THEN PRINT "A/D Converter Test Error"
IF BIT(A,5) THEN PRINT "Backup Memory Test Error"
:

```

To Read the Error Queue

The following command returns the number and message of the existing error in the error queue.

- :SYST:ERR?

For example,

```

:
DIM Err$(50)
:
REPEAT
OUTPUT 717;" :SYST:ERR?"
ENTER 717;Errnum,Err$
PRINT Errnum,Err$
UNTIL Errnum=0
:

```

To Report the Instrument's Status

The following commands report the instrument's status:

- *CLS
- *ESE
- *ESR?
- *SRE
- *STB?
- :STAT:OPER?
- :STAT:OPER:COND?
- :STAT:OPER:ENAB
- :STAT:QUES?
- :STAT:QUES:COND?
- :STAT:QUES:ENAB
- :STAT:PRES
- HP BASIC SPOLL command

For example, to detect the measurement completion:

```

OUTPUT 717;":SYST:OPER:ENAB 16"  Enable Measurement bit of Operation Status Register
OUTPUT 717;"*SRE 128"           Enable Operation Status Register Summary bit
REPEAT                           Wait until the Operation Status Register Summary
  A=SPOLL(717)                   bit is set
UNTIL BIT(A,7)

```

For example, to generate an interrupt when an error occurs in the 4339B:

```

:
DIM Err$(50)
!
:
OUTPUT 717;"*CLS"                Clears status byte register
OUTPUT 717;"*ESE 48"            Sets Command Error Bit and Execution Error Bit
OUTPUT 717;"*SRE 32"           Sets Standard Event Status Register Summary Bit
!
ON INTR 7 GOSUB Err_report      Tells where to branch to when interrupted
ENABLE INTR 7;2                 Enable an interrupt from GPIB interface
!
:
LOOP
:
END LOOP
STOP
!
Err_report:!
Stat=SPOLL(717)                 Clears the SRQ bit
OUTPUT 717;"*ESR?"             Asks contents of the Standard Event Status Register
ENTER 717;Estat
PRINT "Syntax Error detected."
!
OUTPUT 717;":SYST:ERR?"        Asks to output error number and message
ENTER 717;Err,Err$
PRINT Err,Err$
!
ENABLE INTR 7
RETURN
END

```

Sample Program

The following sample program measures resistivity of insulation film using the 16008B Resistivity Cell with $\phi 50$ mm main electrode.

Warning  Do *NOT* touch the UNKNOWN terminals or the electrodes of the accessory, when the High Voltage indicator is ON, the 4339B outputs dangerous voltage levels up to 1000 Vdc. Before handling the 4339B or the accessory, confirm that the High Voltage indicator is OFF.



```

10  ASSIGN @Hp4339 TO 717
20  !
30  OUTPUT @Hp4339;"*RST;*CLS"
40  OUTPUT @Hp4339;" :INIT:CONT ON"
50  !
60  DISP "Calibration"
70  OUTPUT @Hp4339;" :CAL?"
80  ENTER @Hp4339;A
90  DISP
100 IF A<>0 THEN
110   PRINT "Error:",A
120   PAUSE
130 END IF
140 !
150 DISP "Separate each electrode and close the top cover,
then press 'Continue'."
160 PAUSE
170 DISP "OPEN Correction"
180 OUTPUT @Hp4339;" :SENS:FUNC 'CURR'"
185 OUTPUT @Hp4339;" :SENS:CURR:APER 0.39'"
190 OUTPUT @Hp4339;" :SOUR:VOLT 500"
200 OUTPUT @Hp4339;" :OUTP ON"
210 REPEAT
220   OUTPUT @Hp4339;"FETC?"
230   ENTER @Hp4339;S,D
240 UNTIL ABS(D)<5.E-13
250 OUTPUT @Hp4339;" :SENS:CORR:COLL OFFS"
260 OUTPUT @Hp4339;"*OPC?"
270 ENTER @Hp4339;A
280 OUTPUT @Hp4339;" :OUTP OFF"
290 DISP "Confirm that the High Voltage indicator is OFF,
then press 'Continue'."
300 PAUSE
310 DISP "Place DUT and close the top cover, then press
'Continue'."
320 PAUSE
330 DISP
340 !
350 OUTPUT @Hp4339;" :ARM:SOUR BUS"
360 OUTPUT @Hp4339;" :ARM:DEL 60"
370 OUTPUT @Hp4339;" :TRIG:SOUR INT"
380 !
390 OUTPUT @Hp4339;" :CALC:RES:STH 0.002"

```



```

400 OUTPUT @Hp4339;":CALC:RES:EAR 0.0019635"
410 OUTPUT @Hp4339;":CALC:RES:EPER 0.18850"
420 OUTPUT @Hp4339;":CALC:RES:GLEN 0.01"
430 !
440 OUTPUT @Hp4339;":SENS:FUNC 'RES'"
450 DISP "Turn the Volume/Surface selector to 'Volume'."
460 PAUSE
470 DISP
480 OUTPUT @Hp4339;":CALC:FORM VRES"
490 OUTPUT @Hp4339;":*TRG"
500 ENTER @Hp4339;S,D
510 PRINT "Volume Resistivity:",D;"[OHMcM]","Status: ";S
520 !
530 DISP "Turn the Volume/Surface selector to 'Surface'."
540 PAUSE
550 DISP
560 OUTPUT @Hp4339;":CALC:FORM SRES"
570 OUTPUT @Hp4339;":*TRG"
580 ENTER @Hp4339;S,D
590 PRINT "Surface Resistivity:",D;"[OHM]","Status: ";S
600 END

```

Figure 4-8. Sample Program

Lines 30 and 40	Presets the 4339B, clears the status byte register, and sets the trigger system being continuously initiated.
Lines 60 to 130	Performs calibration. If any error occurs during calibration, check what error occurs and stop the program.
Lines 150 to 330	Performs an OPEN correction: 1. Selects the Current measurement mode. 2. Selects the Long measurement time mode. 3. Apply the test voltage, 500 V. 4. Wait until the current has stabled to within 0.5 pA. 5. Performs an OPEN correction.
Lines 350 to 370	Sets the sequence measurement parameter: Measurement sequence mode: Single mode Charge time: 60 s Trigger source: Bus
Line 390	Sets the DUT thickness to 2 mm.
Lines 400 to 420	Sets the resistivity cell parameters for $\phi 50$ mm main electrode: Effective area: $19.635 (= \pi \times (5.0/2)^2)$ cm ² Effective perimeter: $18.850 (= \pi \times (5.0 + 7.0)/2)$ cm Gap: 1 cm
Lines 440 to 510	Measures the volume resistivity.
Lines 530 to 590	Measures the surface resistivity.

If You Have a Problem

Check all GPIB addresses and connections; most GPIB problems are caused by an incorrect address or bad or loose GPIB cables.

If the 4339B Hangs Up When You Send the ABORt Command

- Send the device clear command to the 4339B:

For example,

```
CLEAR(717)
```

GPIB Reference

Introduction

This chapter provides the information needed to control the 4339B through the GPIB interface in the GPIB Remote mode.

- GPIB Command Reference
- Status Reporting
- Trigger System
- Data Transfer Format

GPIB Commands

The 4339B's GPIB commands are compatible with the Standard Commands for Programmable Instruments (ACPI). SCPI is the instrument command language for controlling instruments that go beyond IEEE 488.2 standard to address a wide variety of instrument functions in standard manner.

Commands can be separated into two groups: common commands and subsystem commands.

Common Commands

Common commands are generally not measurement related, but are used to manage macros, status registers, synchronization, and data storage. All common commands begin with an asterisk (*). Common commands are defined in the IEEE 488.2 standard.

Subsystem Commands

Subsystem commands include all measurement functions and some general purpose functions. Each subsystem is a set of commands that roughly corresponds to a functional block inside the instrument.

Subsystem commands have a hierarchical structure, called a **command tree**, which consists of several key words separated by a colon between each word.

Subsystem Command Tree

The top of the subsystem command tree is called the **root command**, or simply the **root**. To reach low-level commands, you must specify a particular **path** (like DOS file directory path). After power ON or after *RST, the current path is set to the root. The path settings are changed as follows:

Message Terminator A message terminator, such as the <new line> character, sets the current path to the root.

Colon (:) When a colon is placed between two command mnemonics, the colon moves the current path down one level on the command tree. When the colon is the first character of a command, it specifies the following command mnemonic is a root-level command.

Semicolon (;) A semicolon separates two commands in the same message without changing the current path.

Figure 5-1 shows examples of how to use the colon and semicolon to navigate efficiently through the command tree.

Common commands, such as *RST, are not part of any subsystem. The 4339B interprets them in the same way, regardless of the current path setting.

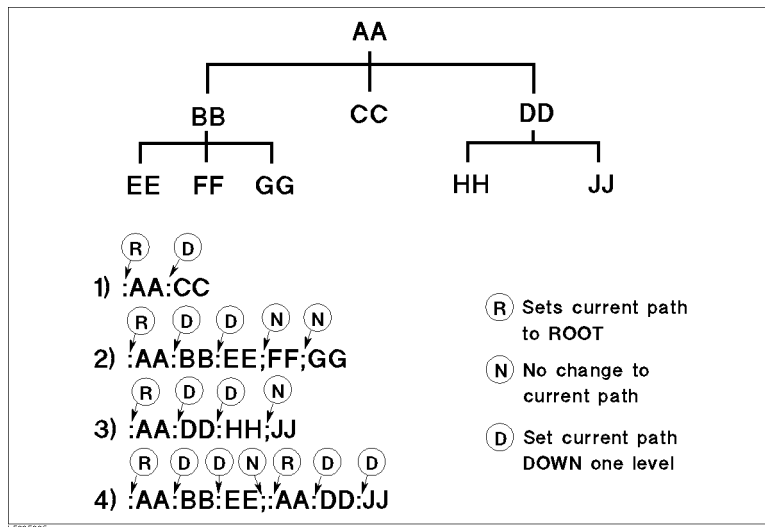

Figure 5-1. Proper Use of the Colon and Semicolon

Program Message Syntax

This section provides the construction of SCPI program message. A program message is the message that you send from a computer to an instrument. Program messages consist of commands combined with appropriate punctuation and program message terminators.

Command Abbreviations

Many commands have a long and a short form. In this manual, all commands are spelled out in a longer form. The Short form is obtained by deleting the lower case letters.

For example, the short form of **:INITiate** is **:INIT** and the long form of it is **:INITIATE**. (SCPI does not accept anything in between, such as **:INITIA.**)

Case

Letter cases (upper and lower) are ignored.

Program Message Terminator

Program message must be ended with one of the three **program message terminators**, <new line>, <^END>, or <new line><^END>. <^END> means that End Of Identify (EOI) is asserted on the GPIB interface at the same time the preceding data byte is sent. For example, the HP BASIC OUTPUT statement is automatically sent after the last data byte. If you are using a PC, you can usually configure your system to send whatever terminator you specify.

Common Command Syntax

Common commands do not have a hierarchical structure. They can be sent as follows:

```
*CLS
```

Subsystem Command Syntax

Subsystem commands consist of the mnemonic (keyword) separated by colons. For example, the command form of CONTInuous under INITiate subsystem is constructed as follows:

```
:INITiate:CONTInuous
```

Parameters

There must be a <space> between the last command mnemonic and the first parameter in a subsystem command.

```
:SYSTem:LFRequency□parameter
```

□ means a space (ASCII character (decimal 32)) is inserted here.

If you send more than one parameter with a single command, each parameter must be separated by a comma.

Parameter Types

SCPI defines different data formats for use in program messages and query responses. The 4339B accepts commands and parameters in various formats and responds to a particular query in a predefined and fixed format. Each command reference contains information about the parameter types available for the individual commands.

<numeric_value> Is used in both common commands and subsystem commands.
<numeric_value> represents a numeric parameter as follows:

100	no decimal point required
100.	fractional digits optional
-1.23, +235	leading signs allowed
4.56e□3	space allowed after e in exponential
-7.89E-01	use either E or e in exponential
.5	digits left of decimal point optional

The 4339B setting programmed with a numeric parameter can assume a finite number of values, so the 4339B automatically rounds off the parameter. For example, the 4339B has a programmable line frequency of 50 or 60 Hz. If you specified 50.1, it would be rounded off to 50.

The subsystem commands use extended numeric parameters. Extended numeric parameters accept all numeric parameter values and other special values, for instance, MAXimum, MINimum or UP, DOWN. The special values available are described in the command's reference description.

Query response of *<numeric_value>* is always a numeric value in *<NR1>* (integer) or *<NR3>* (floating point) format.

- **Suffix** When a command has specified suffix, the suffix multiplier and suffix units can be used with parameters as follows. (The suffix multiplier must be used with the suffix unit.):

Voltage : V (V; default), KV (kV)
 Current: PA (pA), NA (nA), UA (μ A), MA (mA), A (A; default)
 Time: MS (ms), S (s; default)

The suffix is optional and can be omitted.

<Boolean>

Represents a single binary condition that is either ON or OFF. *<Boolean>* allows the following parameters:

ON, OFF in a program message.
 1, 0 in a program message and query response.

<sensor_function> and *<data_handle>*

Are string parameters which contain ASCII characters. A string must begin with a single quote(ASCII 39 decimal) or a double quote (ASCII 34 decimal) and end with the same character, a single or double quote. The quote to mark the beginning and end of the string is called the delimiter. You can include the delimiter as part of the string by typing it twice without any characters in between.

Example of *<sensor_function>* "RES",
 OUTPUT @Meter;" :SENS:FUNC 'RES'" *using single quote*
 OUTPUT @Meter;" :FSENS:FUNC ""RES"" *using double quote*

A query response is the string in between double quote delimiters.

Multiple Messages

To send more than one command in the same message, you must separate them with a semicolon:

```
*CLS; :INIT
```

Query and Response Message Syntax

All subsystem commands can be queried except for the commands described as “no query” in the command reference. To send a query message, add a question mark, ? after the last command mnemonic.

```
:AVER:COUN?
```

A response message may contain both commas and semicolons as separators. When a single query command returns multiple values, a comma is used to separate each data item. When multiple queries are sent in the same message, the group of data items corresponding to each query are separated by a semicolon. For example, the fictitious query :QUERY1?;QUERY2? might return a response message of:

```
<data1>,<data1>;<data2>,<data2>
```

After the message, Note that <new line><^END> is always sent as a response message terminator.

Command Reference

Notations

In this chapter, each subsystem is documented using the tabular format instead of the command tree as follows. The following conventions and definitions are used to describe GPIB operation.

COMMAND	PARAMETER
FORMat	{ASCIi REAL[,64]}
[:DATA]	
COMMAND	PARAMETER
INITiate	<Boolean>
:CONTinuous	
[:IMMediate]	

Commands closest to the root-level are at the top of the table. Lower nodes in the hierarchy are indented one position to the right.

If a command requires one or more parameters, the parameter names are listed adjacent to the command.

The lower case parts are optional.

< > Angular brackets enclose words or characters that are used to symbolize a program code parameter or an GPIB command.

[] Square brackets indicate that the enclosed items are optional.

{ } When several items are enclosed by braces, one and only one of these elements may be selected. A vertical bar can be read as “or” and is used to separate alternative parameter options.

- For example, the :FORMat[:DATA] command can be

```
:FORMAT:DATA
:FORM:DATA
:FORMAT
```

- For example, the {ASCIi|REAL[,64]} parameter can be

```
ASCIi
ASC
REAL,64
REAL
```

ABORt Command

:ABORt

Resets the trigger system and places all trigger sequences in Idle state. Any actions related to the trigger system that are in progress, such as acquiring a measurement, are aborted immediately. The execution of an :ABORt command will set any pending operation flag to FALSE, for example flags that were set by the initiation of the trigger system. Refer to “Trigger System”.

Unlike *RST, :ABORt does not alter the settings programmed by other commands. (No query)

Note



After the :FETCh? query, the *TRG command, or the TRIGGER BASIC command, the :ABORt command will cause the GPIB bus to hang up. To avoid this, clear the GPIB bus by sending the BASIC command CLEAR(*address*) before sending the :ABORt command.

ARM Subsystem

The 4339B has the measurement sequence feature which provides a measurement sequence (charging DUT, and then measuring it several time with interval) by a single operation – triggering a measurement. The ARM subsystem controls the sequence measurement feature, working with the TRIGger subsystem.

The purpose of the ARM subsystem is to qualify an ARMinG sequence, before enabling the TRIGger system, to charge the DUT before measuring it.

For details about the ARM-TRIGger system model, see “Trigger System”.

COMMAND	PARAMETER
ARM	
[:SEquence1]	
[:LAYer]	
:DELay	<numeric_value>[MS S]
:SOURce	{BUS EXTernal MANual IMMediate}

:ARM[:SEquence1][:LAYer]:DELay <numeric_value> [MS|S]

Sets the DUT charging time before a DUT is measured. The charge time defines the waiting time when the 4339B triggered a measurement to when the measurement will actually start. The test voltage is applied during this time.

<numeric_value> is,

Range	Resolution
$0 \text{ s} \leq \text{Charge Time} < 10 \text{ s}$	1 ms
$10 \text{ s} \leq \text{Charge Time} < 100 \text{ s}$	10 ms
$100 \text{ s} \leq \text{Charge Time} \leq 999 \text{ s}$	100 ms

:ARM[:SEquence1][:LAYer]:SOURce {BUS|EXTernal|MANual|IMMediate}

Sets the sequence measurement mode to ON or OFF, and selects the source for the ARM event detector. When the ARM event is detected, the 4339B enables the output test voltage and applies the test voltage to DUT. After charge-time wait, 4339B move from the ARM event detection state to the TRIG event detection state.

When BUS, EXTernal, or MANual is selected as the ARM source, the 4339B automatically enables the test voltage output at the time an ARM event is detected, and applies the test voltage to the DUT. After the measurement, the 4339B automatically turns OFF the test voltage output. When IMMEDIATE is selected, the ARM event has no effect on test voltage output enabling or disabling, you must control test voltage output.

Only one trigger source can be specified at a time for a given event detector. The available trigger sources are:

Parameter	Measurement Sequence	Trigger Source
BUS	ON	GET or *TRG commands
EXTernal		An external trigger signal from external trigger terminal
MANual		The front-panel  key.
IMMediate	OFF	No waiting for a ARM event to occur. (The 4339B immediately advances to the TRIG event detection state.)

Query response format is BUS, MAN, INT, or IMM.

CALCulate Subsystem

The CALCulate subsystem controls measurement data processing listed below.

1. To select measurement parameter (CALCulate1:FORMat subsystem with CALCulate:RESistivity subsystem)
2. To control the deviation measurement mode (CALCulate1:MATH subsystem)
3. To control the comparator function (CALCulate1:LIMit subsystem)
4. To control the current monitor function (CALCulate2 subsystem)
5. To control the time display function (CALCulate3 subsystem)

The 4339B performs data processing in the order it is listed.

The CALCulate subsystem is logically between the SENSE subsystem and data output to either the bus or the display, and works with the SENSE subsystem, the DATA subsystem, and FETCH? query.

COMMAND	PARAMETER
CALCulate1	
:FORMat	{REAL SRESistivity VRESistivity}
:LIMit	
:BEEPer	
:CONDition	{FAIL PASS}
[:STATe]	<Boolean>
:CLEar	
:FAIL?	
:LOWer	
[:DATA]	<numeric_value>
:STATe	<Boolean>
:STATe	<Boolean>
:UPPer	
[:DATA]	<numeric_value>
:STATe	<Boolean>
:MATH	
:EXPRession	
:CATalog?	
:NAME	{DEV PCNT}
:STATe	<Boolean>
:PATH?	
:RESistivity	
:EARea	<numeric_value>
:EPERimeter	<numeric_value>
:GLENght	<numeric_value>
:STHickness	<numeric_value>
CALCulate2	
:MATH	
:STATe	<Boolean>
CALCulate3	
:FORMat	{SEC TPCNT}
:MATH	
:STATe	<Boolean>
:DIREction	{UP DOWN}
:BEEPer	<Boolean>

:CALCulate1:FORMat { REAL | SRESistivity | VRESistivity }

Specifies or queries the post-processing of measurement data, which is measured using the *<sensor_function>* specified by the [SENSe]:FUNction command. The definition of the SENSE subsystem parameters are as follows:

<i><sensor_function></i> of [:SENSe]:FUNction	CALCulate1:FORMat	Parameter
"CURRent:DC"	REAL	current: I [A]
"RESistance[:DC]"	REAL	resistance: R [Ω]
	SRESistivity	surface resistivity: $\frac{P \times R}{g}$ [Ω]
	VRESistivity	volume resistivity: $\frac{A}{t} \times R$ [$\Omega \times cm$]

Where,

Parameter	Description	Command
P [m]	Effective perimeter	CALCulate1:RESistivity:EPERimeter
g [m]	Gap between main electrode and guard electrode (ring)	CALCulate:RESistivity:GLENgth
A [m ²]	Effective area	CALCulate1:RESistivity:EAREa
t [m]	Thickness of sample	CALCulate1:RESistivity:STHickness

Query response is REAL, SRES, or VRES.

:CALCulate1:LIMit:BEEPer:CONDition { PASS | FAIL }

Defines comparator output to beeper.

FAIL a beep is emitted when the comparison result is FAIL (High, Low or No-contact).
PASS a beep is emitted when the comparison result is PASS (In).

This command is effective when SYSTem:BEEPer:STATe and CALCulate1:LIMit:BEEPer:STATe commands are set to ON.

Query response is FAIL or PASS.

:CALCulate1:LIMit:BEEPer[:STATe] { ON | OFF | 1 | 0 }

Sets or queries if comparator output to beeper is enabled.

ON or 1 Enables the comparator output to beeper as defined by :CALCulate1:LIMit:BEEPer:CONDition command.
OFF or 0 Disables comparator output to beeper.

When you enable the beep function, :SYSTem:BEEPer:STATe command is automatically set to ON.

Query response is 1 or 0.

:CALCulate1:LIMit:CLEar

Clears the data which is reported by CALCulate1:LIMit:FAIL? command. (no query)

:CALCulate1:LIMit:FAIL?

Returns the comparison result. (Query only)

Query response is 1 or 0.

Where,

1 Comparison result is FAIL.
0 Comparison result is PASS.

:CALCulate1:LIMit:LOWer[:DATA] <numeric_value>

Sets or queries lower limit data.

<numeric_value> is,

numeric Real. Range is -9.9×10^{37} to 9.9×10^{37} .

Query response is a numeric value in <NR3> format.

:CALCulate1:LIMit:LOWer:STATe { ON | OFF | 1 | 0 }

Sets or queries if the lower test limit is enabled.

ON or 1 Enables the lower limit.
OFF or 0 Disables the lower limit.

Query response is 1 or 0.

:CALCulate1:LIMit:STATe { ON | OFF | 1 | 0 }

Sets or queries if the limit test is enabled.

Where,

ON or 1 Sets the comparison function to ON.
OFF or 0 Sets the comparison function to OFF.

Query response is 1 or 0.

:CALCulate1:LIMit:UPPer[:DATA] <numeric_value>

Sets or queries the upper test limit data.

<numeric_value> is,

numeric -9.9×10^{37} to 9.9×10^{37}

A query response is a numeric value in <NR3> format.

:CALCulate1:LIMit:UPPer:STATe { ON | OFF | 1 | 0 }

Sets or queries if the upper test limit is enabled.

Where,

ON or 1 Disables the upper limit.
OFF or 0 Enables the upper limit.

Query response is 1 or 0.

:CALCulate1:MATH:EXPRession:CATalog?

Returns available parameters which are used with CALCulate1:MATH:EXPRession:NAME command. (query only)

For more information, see CALCulate1:MATH:EXPRession:NAME command.

Query response is {DEV|PCNT}.

:CALCulate1:MATH:EXPRession:NAME { DEV | PCNT }

Defines or queries the expression used for deviation measurement, which is enabled by CALCulate1:MATH:STATe. The reference value can be defined using the DATA[:DATA] command.

DEV	Absolute value of deviation
PCNT	Percentage of deviation

:CALCulate1:MATH:STATe { ON | OFF | 1 | 0 }

Sets or queries if math processing defined by :CALCulate1:MATH:EXPRession:NAME is enabled or not.

ON, 1	Enables math processing.
OFF, 0	Disables math processing.

Query response is 1 or 0.

:CALCulate1:PATH?

Returns the order in which the CALCulate subsystem commands are to be performed. (Query only)

The 4339B always processes measured data in order of :CALCulate1:FORMat subsystem, :CALCulate1:MATH subsystem, and :CALCulate1:LIMit subsystem.

Query response is always FORM,MATH,LIM.

:CALCulate1:RESistivity:EARea <numeric_value >

Specifies or queries the effective area of the main electrode for the resistivity measurement.

<numeric_value> is,

numeric 0 to 0.99999 (m²)

Query response is a numeric value in <NR3> format.

:CALCulate1:RESistivity:EPERimeter <numeric_value >

Specifies or queries the effective perimeter of the electrode for the resistivity measurement.

<numeric_value> is,

numeric 0 to 9.9999 (m)

Query response is a numeric value in <NR3> format.

:CALCulate1:RESistivity:GLENght <numeric_value >

Specifies or queries the distance between the main electrode and guard electrode (ring) for the resistivity measurement.

<numeric_value> is,

numeric 0.00001 to 0.9999 (m)

Query response is a numeric value in <NR3> format.

:CALCulate1:RESistivity:STHickness <numeric_value >

Specifies or queries the thickness of the sample for the resistivity measurement.

<numeric_value> is,

numeric 0.00001 to 0.02 (m)

Query response format is a numeric value in <NR3>.

:CALCulate2:MATH:STATe {ON|OFF|1|0}

Sets or queries if the current monitor function is enabled.

ON, 1 Sets the current monitor function to ON.
OFF, 0 Sets the current monitor function to OFF.

Query response is 1 or 0.

:CALCulate3:FORMat {SEC|TPCNT}

Sets or queries the time display mode of the measurement sequence program.

SEC displays in seconds.
TPCNT displays in %.

Query response is SEC or TPCNT.

:CALCulate3:MATH:STATe {ON|OFF|1|0}

Sets or queries if the time display function of the measurement sequence program is enabled.

ON, 1 Sets the time display function to ON.
OFF, 0 Sets the time display function to OFF.

Query response is 1 or 0.

:CALCulate3:DIREction {UP|DOWN}

Sets or queries the timer direction (Count up, or Count down) of the time display function.

UP Count up mode
DOWN Count down mode

Query response is UP or DOWN.

:CALCulate3:BEEPer {ON|OFF|1|0}

Sets or queries if the beeper of the measurement sequence program is enabled.

ON, 1 Two beeps are emitted when the sequence program is completed.
OFF, 0 No beep is emitted.

Query response is 1 or 0.

Note

- "1" of CALCulate1 can be omitted.
 - "2", "3" of CALCulate2, CALCulate3 cannot be omitted. The short must be CALC2, CALC3.
-

CALibration Subsystem

COMMAND	PARAMETER
CALibration	
[:ALL]?	
:AUTO	<Boolean>

:CALibration[:ALL]?

Performs a calibration, and then returns an error code. The error code is referred to “Messages” at the back of this manual (An error code of “0” indicates no failure).

:CALibration:AUTO {ON|OFF|1|0}

Sets or queries if the offset-error canceling function is enabled. The offset-error calibration function cancels the offset error due to the temperature change, when the measurement range is 100 pA or 1 nA and the measurement time mode is Long.

ON, 1 enables offset-error canceling
OFF, 0 disables offset-error canceling

Query response is 1 or 0

DATA Subsystem

The DATA subsystem is used to store data to the 4339B's data buffer and to read data in the data buffer.

COMMAND	PARAMETER
DATA	
[:DATA]	REF,<numeric_value>
[:DATA]?	DBUF, IMON, TMON
:FEED	DBUF,<data_handle>
:CONTrol	DBUF,{ALWays NEVer}
:POINts	DBUF,<numeric_value>

:DATA[:DATA] REF,<numeric_value>

Enters or queries the reference value for the deviation measurement, which is controlled by :CALCulate:MATH subsystem commands.

<numeric_value> is,

numeric -9.9×10^{37} to 9.9×10^{37}

The query form requires parameter REF, such as :DATA[:DATA]?REF. Query response is a numeric value in <NR3> format.

:DATA[:DATA]? DBUF

Returns the data in data buffer, DBUF, according to the format determined by the FORMat subsystem commands. (query only)

This query needs parameter DBUF which is the name of the data buffer to read.

Query response is, <set1>,<set2>, ... <setn>

Where,

<set1> : Data set of the first measurement point
 <set2> : Data set of the second measurement point
 ⋮
 <setn> : Data set of the last measurement point (*n* is specified using DATA:POINts DBUF command)

Each data set consists of the following data: <stat>,<data>,<comp>

Where,

<stat> Measured status
 0 : Normal
 1 : Overload
 2 : No-contact
 4 : Over-current (exceeding current limit)
 <data> Measured data
 <comp> Comparison result
 0 : Comparator off
 1 : In
 2 : High
 4 : Low
 8 : No-contact

:DATA[:DATA]? IMON

Returns the current monitor value.

This query needs parameter **IMON** which is the name of the data buffer to read.

Query response is a numeric value in <NR2> format.

:DATA[:DATA]? TMON

Returns the timer data of the measurement sequence program (in seconds, or in %) when the time display function is ON.

This query needs parameter **TMON** which is the name of the data buffer to read.

Query response is a numeric value in <NR2> format.

:DATA:FEED DBUF,<data_handle>

Sets or queries which data is fed into the data buffer.

<data_handle> is,

"CALCulate" set to feed the data specified **CALCulate:FORMat** command into the data buffer.

""(null string) set not to feed data into data buffer

The query form requires parameter **DBUF**, such as **DATA:FEED? DBUF**. Query response is "CALC" or null string.

:DATA:FEED:CONTRol DBUF,{ ALWAYS | NEVER }

Sets or queries whether data is fed into data buffer or not. The data fed into the data buffer by this command is specified by **:DATA:FEED DBUF** command. This command has no effect when **:DATA:FEED DBUF** is set to ""(null string).

Where,

ALWays Feeds data into data buffer, whenever new data is available

NEVer No data is fed into data buffer

The query form requires parameter **DBUF**, such as **DATA:FEED:CONT? DBUF**. Query response is **ALW** or **NEV**.

:DATA:POINts DBUF,<numeric_value>

Sets or queries the size of data buffer, **DBUF**. You can store as many measurement point data sets into **DBUF** as defined by this command.

<numeric_value> is,

numeric 1 to 500

The query form requires parameter **DBUF**, such as **:DATA:POINts? DBUF**. Query response is a numeric value in <NR1>.

DISPlay Subsystem

COMMAND	PARAMETER
DISPlay	
[:WINDow]	
[:STATe]	<Boolean>
:TEXT1	
:DIGit	{3 4 5}
:PAGE	{1 2 3}
:PREFix	<Boolean>
:TEXT2	
:PAGE	{1 2 3 4 5 6}

:DISPlay[:WINDow][:STATe] {ON|OFF|1|0}

Sets the display ON or OFF, or queries whether the display is set to ON or OFF.

Where,

ON or 1 Sets the display ON.
 OFF or 0 Sets the display OFF (blank).

Query response is 1 or 0.

:DISPlay[:WINDow]:TEXT1:DIGit {3|4|5}

Sets or queries the display digits of the measurement data.

3 3 digits display mode
 4 4 digits display mode
 5 5 digits display mode

Query response is 3, 4, or 5.

:DISPlay[:WINDow]:TEXT1:PAGE {1|2}

Sets or queries the display mode.

1 Measure Display
 2 Comparison Display

Query response is 1 or 2.

:DISPlay[:WINDow]:TEXT1:PREFix {ON|OFF|1|0}

Sets or queries the measurement data display format (R-Unit).

ON, 1 displays in Prefix mode.
 OFF, 0 displays in Exponent mode.

Query response is 1 or 0.

:DISPlay[:WINDow]:TEXT2:PAGE {1|2|3|4|5|6}

Sets or queries the Measurement Settings display mode.

- 1 Test voltage and Current limit
- 2 Averaging rate and Trigger delay time
- 3 Sequence mode and charge time
- 4 Sequence interval time and Memory size
- 5 Comparator limits
- 6 Test voltage and Current monitor value

Query response is 1,2,3,4,5, or 6.

Note "1" of :TEXT1 can be omitted, but "2" of :TEXT2 cannot be omitted.



FETCh? Query

:FETCh?

Retrieves a measurement value taken using the INITiate subsystem commands and places the measurement data into the 4339B's output buffer. (Query only)

Query response format is,

<stat>,*<data>*,*<comp>*

Where,

<stat> measurement status

- 0 : Normal
- 1 : Overload
- 2 : No-Contact
- 4 : Over-Current (exceeding current limit)

<data> Measurement data

<comp> Comparison result (no output when the comparator function is OFF)

- 1 : In
- 2 : High
- 4 : Low
- 8 : No-Contact

Data format is specified by the FORMat[:DATA] command.

FORMat Subsystem

COMMAND	PARAMETER
FORMat [:DATA]	{ASCII REAL[,64]}

:FORMat[:DATA] { ASCII | REAL[,64] }

Sets the data format for transferring numeric and array information.

ASCII Sets the data transfer format to ASCII.

REAL[,64] Sets the data transfer format to IEEE 754 floating point numbers of the specified length of 64-bit.

For details on data transfer formats, see “Data Transfer Format”.

Query response is ASCII or REAL,64.

INITiate Subsystem

The INITiate subsystem controls the initiation of the trigger system. All trigger sequences are initiated as a group. The detailed description of the trigger system is given in “Trigger System”.

COMMAND	PARAMETER
INITiate	
:CONTinuous	<Boolean>
[:IMMEDIATE]	

:INITiate[:IMMEDIATE]

Causes all sequences to exit Idle state and enter Initiate state. Then the trigger system initiates and completes one full trigger cycle. Finally, on completion, the system returns to IDLE state. (No query)

If the 4339B is not in Idle state or if :INITiate:CONTinuous is set to ON, an :INITiate:IMMEDIATE command has no effect on the trigger system and an error –213 is generated.

:INITiate:CONTinuous { ON | OFF | 1 | 0 }

Sets or queries whether the trigger system is continuously initiated or not.

OFF or 0 Does not initiate the trigger system continuously.
ON or 1 Initiates the trigger system continuously.

Query response is 0 or 1.

OUTPut Subsystem

The OUTPut subsystem controls the voltage source.

COMMAND	PARAMETER
OUTPut [:STATe]	<Boolean>

:OUTPut[:STATe] { ON | OFF | 1 | 0 }

Controls or queries whether the source voltage is ON or OFF.

ON or 1 Turns the source voltage ON.

OFF or 0 Turns the source voltage OFF.

Query response is 1 or 0.

Warning  **Sending :OUTPut[:STATe] { ON | 1 } may cause the 4339B to output dangerous voltage levels up to 1000 Vdc. Do *NOT* touch the UNKNOWN terminals or the electrodes of the accessory, when the V Output indicator is ON.**



SENSE Subsystem

COMMAND	PARAMETER
[SENSE]	
:AVERAGE	
:COUNT	<numeric_value>
[:STATE]	<Boolean>
:CORRECTION	
:COLLECT	
[:ACQUIRE]	OFFSET
:DATA?	OFFSET, SCAPACITANCE
[:STATE]	<Boolean>
:CURRENT	
:APERTURE	<numeric_value>[MS S]
:RANGE	
:AUTO	<Boolean>
[:UPPER]	<numeric_value>[PA NA UA A]
:FUNCTION	<sensor_function>
:CONTACT	
:DATA?	
:LIMIT?	
:OFFSET	<numeric_value>[PF F]
:VERIFY	<Boolean>

[:SENSE]:AVERAGE:COUNT <numeric_value>

Sets or queries the averaging rate.

<numeric_value> is,

numeric 1 to 256

Query response format is a numeric value in <NR1> format.

[:SENSE]:AVERAGE[:STATE] { **ON** | **OFF** | **1** | **0** }

Sets or queries if the averaging function is enabled.

Where,

ON or 1 Enables averaging.

OFF or 0 Disables averaging.

Query response is 1 or 0.

[[:SENSe]:CONtact:DATA?

Returns the capacitance data at dut measurement. The contact check function uses this capacitance data. Refer to “Reading the Limit Data of Contact Check Function” in Chapter 2 for detail. (query only)

Query response is a numeric value in <NR3> format.

The data is incorrect if the measurement range was changed after dut measurement.

Note The accuracy of the capacitance data is not guaranteed.

**[[:SENSe]:CONtact:LIMit?**

Returns the contact check limit data. Refer to “Reading the Limit Data of Contact Check Function” in Chapter 2 for detail. (query only)

Query response is a numeric value in <NR3> format.

[[:SENSe]:CONtact:OFFSet <numeric_value>

Set or queries an offset of contact check limit data.

<numeric_value> is,

numeric 0 to 75 [pF]

[[:SENSe]:CONtact:VERify { ON | OFF | 1 | 0 }

Sets or queries if the contact check function is enabled.

Where,

ON or 1 Enables the contact check function.

OFF or 0 Disables the contact check function.

The reference data for the contact check is obtained by an OPEN correction. An OPEN correction is required before the contact check turns on.

Query response is 1 or 0.

[[:SENSe]:CORRection:COLLect[:ACQuire] OFFset

Measures and stores the OPEN correction data. (No query)

This command sets [SENSe:] :CORRection[:STATe] ON, which enables the correction function.

[[:SENSE]:CORREction:DATA? { OFFSet | SCAPacitance }

Returns the OPEN correction data (DC current measurement value) or capacitance measurement data obtained by performing the OPEN correction. The capacitance measurement data is used for the contact check function.(Query only)

OFFSet Returns the open correction data.

SCAPacitance Returns the capacitance measurement data.

Query response is a numeric value in <NR3> format.

Note The capacitance measurement data is typical data, and it is not guaranteed.

**[[:SENSE]:CORREction[:STATe] { ON | OFF | 1 | 0 }**

Sets or queries if the OPEN correction function is enabled.

Where,

ON or 1 Enables the correction function.

OFF or 0 Disables the correction function.

[[:SENSE]:CURRent:APERture <numeric_value> [MS|S]

Sets or queries the measurement time mode: Short(=0.01 s), Medium(=0.03 s), Long(=0.39 s).

<numeric_value> is,

numeric 0.01, 0.03, or 0.39 (s)

Query response is a numeric value in <NR2> format.

[[:SENSE]:CURRent:RANGe:AUTO { ON | OFF | 1 | 0 }

Sets or queries if the Auto range measurement mode is enabled.

Where,

ON or 1 Auto range mode

OFF or 0 Hold range mode

Query response is 1 or 0.

[[:SENSE]:CURRent:RANGe[:UPPer] <numeric_value> [PA|NA|UA|MA|A]

Selects or queries the measurement range. Available measurement ranges are 100 pA, 1 nA, 10 nA, 100 nA, 1 μ A, 10 μ A, and 100 μ A.

<numeric_value> is,

numeric 100 pA (available when the measurement time mode is Medium or Long), 1 nA, 10 nA, 100 nA, 1 μ A, 10 μ A, 100 μ A (available when the measurement time mode is Short)

UP moves to upper range.

DOWN moves to lower range.

Query response is a numeric value in <NR3> format.

[[:SENSe]:FUNction *<sensor_function>*

Sets or queries the measurement parameter. When an *RST command is executed, this is set to "RESistance[:DC]".

<sensor_function> is

'CURRent[:DC]' Current measurement

'RESistance[:DC]' Resistance measurement

To measure surface or volume resistivity, calculate the value using the :CLACulate:FORMat command.

Query response is "CURR" or "RES".

SOURCE Subsystem

COMMAND	PARAMETER
SOURCE	
:CURRENT	
:LIMIT	<numeric_value> [MA A]
:VOLTAGE	
:LEVEL	
:IMMEDIATE	
:AMPLITUDE	<numeric_value> [V KV]

:SOURCE:CURRENT:LIMIT[:AMPLITUDE] <numeric_value> [MA|A]

Sets or queries the current limit value.

<numeric_value> is,

numeric 0.5 mA(default), 1 mA, 2 mA(at test voltage 0 to 500 V only), 5 mA(at test voltage 0 to 250 V only), 10 mA(at test voltage 0 to 100 V only)

Query response is a numeric value, in <NR2> format.

:SOURCE:VOLTAGE[:LEVEL][:IMMEDIATE][:AMPLITUDE]

<numeric_value> [V|KV]

Sets or queries the source voltage value.

<numeric_value> is,

numeric 0.0 to 1000.0 (V)

Resolution of the test voltage is as follows:

Voltage Range	Resolution
0 V ≤ Test Voltage ≤ 200 V	0.1 V
200 V < Test Voltage ≤ 1000 V	1 V

Query response is a numeric value in <NR2> format.

STaTus Subsystem

The STaTus subsystem commands control the Operation Status and Questionable Status registers in the status-reporting structures (See “Status Reporting Structure”).

COMMAND	PARAMETER
STaTus	
:OPERation	
:CONDition?	
:ENABle	<numeric_value>
[:EVENTt]?	
:PRESet	
:QUEStionable	
:CONDition?	
:ENABle	<numeric_value>
[:EVENTt]?	

:STaTus:OPERation:CONDition?

Returns the contents of the condition register of the Operation Status Register group. Reading the condition register does not clear it. (Query only)

Query response is a numeric value in <NR1> format.

:STaTus:OPERation:ENABle <numeric_value>

Sets the enable register of the Operation Status Register group.

<numeric_value> is,

numeric Decimal expression of the contents of the register

Query response is a numeric value in <NR1> format.

:STaTus:OPERation[:EVENTt]?

Returns the contents of the event register of the Operation Status Register group. Reading the event register clears it. (Query only)

Query response is a numeric value in <NR1> format.

:STaTus:PRESet

Clears the Operation Status and Questionable Status register groups. Both the event and enable registers are cleared. (no query)

:STaTus:QUEStionable:CONDition?

Returns the contents of the condition register of the Standard Questionable Status Register group. (Query only)

Query response is always 0, because the 4339B has no operation to report the event to the Questionable Status condition register.

:STATus:QUESTionable:ENABle <*numeric_value*>

Sets or queries the enable register of the Questionable Status Register group.

<*numeric_value*> is,

numeric Decimal expression of the contents of the register.

The 4339B has no operation to report the event to the Questionable Status Condition Register.

Query response is a numeric value in <NR1> format.

:STATus:QUESTionable[:EVENT]?

Returns the contents of the event register of the Questionable Status Register group. (query only)

Query response is always 0, because the 4339B has no operation to report the event to the Questionable Status Event Register.

SYSTem Subsystem

The SYSTem subsystem reports the SCPI version and error, sets the beeper, disables front-panel key input, and sets the line frequency.

COMMAND	PARAMETER
SYSTem	
:BEEPer	
[:IMMediate]	
:STATe	<Boolean>
:ERRor?	
:KLOCK	<Boolean>
:LFRequency	<numeric_value>
:PRESet	
:VERSion?	

:SYSTem:BEEPer[:IMMediate]

Produces a beep immediately. (no query)

:SYSTem:BEEPer:STATe { ON | OFF | 1 | 0 }

Sets or queries if the beeper is enabled.

Where,

ON or 1 Disables all beeper functions, including the error beep.
 OFF or 0 Enables the beeper.

Query response is 1 or 0.

:SYSTem:ERRor?

Returns the number and Message of the existing error numbers in the 4339B's error queue. (Query only)

Query response is a numeric number in <NR1> format and a string parameter.

:SYSTem:KLOCK { ON | OFF | 1 | 0 }

Sets or queries whether the front-panel keys of the 4339B are locked. .

OFF or 0 Locks the front-panel keys.
 ON or 1 Does not lock the front-panel keys.

Query response is 0 or 1.

:SYSTem:LFRequency <numeric_value>

Sets or queries the 4339B's operating power line frequency.

<numeric_value> is,

numeric 50 or 60 (Hz)

Query response is a numeric value in <NR3> format.

:SYSTem:PRESet

Resets the 4339B to its default states. (No query) The default states are given in Table 3-3.

:SYSTem:VERSion?

Returns the value corresponding to SCPI version to which the instrument complies. (Query only)

Query response is YYYY.V.

Where,

YYYY	Year-version
V	Revision number for the year

TRIGger Subsystem

The TRIGger subsystem controls the measurement trigger function. For a detailed description about the trigger sequence controlled by the TRIGger subsystem, see “TRIG Event Detection State” in “Trigger System”, later in this chapter.

COMMAND	PARAMETER
TRIGger	
[:SEquence1]	
:COUNT	<numeric_value>
:DELay	<numeric_value>[MS S]
[:IMMediate]	
:SOURce	{BUS EXTernal INTernal MANual TIMER}
:TIMer	<numeric_value>[MS S]

:TRIGger[:SEquence1]:COUNT <numeric_value>

Sets or queries the size of memory when performing a Continuous measurement sequence.

<numeric_value> is,

numeric 1 to 500

Query response is a numeric value in <NR1> format.

:TRIGger[:SEquence1]:DELay <numeric_value>[MS|S]

Sets or queries the trigger delay time.

<numeric_value> is,

numeric 0.000 to 9.999 [s]

Resolution of the trigger delay time is 1 ms.

Query response is a numeric value in <NR3> format.

:TRIGger[:SEquence1][:IMMediate]



Causes the trigger to execute a measurement, regardless of the trigger state. (No query)

:TRIGger[:SEquence1]:SOURce {BUS|EXTeRnal|INTeRnal|MANual|TIMer}

Sets or queries a trigger source. Only one source can be specified at a time.

The TRIGger[:SEquence1]:SOURce command works with the ARM[:SEquence1][:LAYer]:SOURce command and controls the measurement sequence mode. The selections of the TRIGger:SOURce and ARM:SOURce is shown in Table 5-1.

Table 5-1. Selection of ARM Source and Trigger Source

ARM:SOUR ¹	TRIG:SOUR	Measurement Sequence	Trigger Source
IMMediate	BUS	OFF	GET or a *TRG command
	EXTeRnal		An external signal from the external trigger terminal
	INTeRnal		An internal signal
	MANual		 key
	TIMer	Not Available ²	
BUS	BUS EXTeRnal MANual	Not Available ³	
	INTeRnal	Single	GET or *TRG command
	TIMer	Continuous	
EXTeRnal	BUS EXTeRnal MANual	Not Available ³	
	INTeRnal	Single	An external trigger signal from the external trigger terminal
	TIMer	Continuous	
MANual	BUS EXTeRnal MANual	Not Available ³	
	INTeRnal	Single	 key
	TIMer	Continuous	

1 For details on ARM:SOURce, see ARM[:SEquence1][:LAYer] command.

2 If you select this TRIGger:SOURce, the 4339B automatically sets ARM:SOURce to BUS.

3 If you select these TRIGger:SOURce, the 4339B automatically sets ARM:SOURce to IMMediate.

Query response is BUS, EXT, INT, MAN, or TIM.

:TRIGger[:SEQuence1]:TIMer <numeric_value> [MS|S]

Sets the period of the internal periodic signal source.

<numeric_value> is,

numeric 10 ms to 999 s

The range and resolution are as follows:

Range	Resolution
10 ms ≤ Interval Time < 10 s	1 ms
10 s ≤ Interval Time < 100 s	10 ms
100 s ≤ Interval Time ≤ 999 s	100 ms

Query response is a numerical value in <NR3> format.

When the *RST command is executes, period is sets as follows.

Measurement time mode	Period
SHORT	10 ms
MED	30 ms
LONG	400 ms

Common Commands

***CLS**

Clears the the Operation Status Event Register, and the Standard Event Status Register. (No query)

***ESE** <numeric_value>

Sets or queries the bits of the Standard Event Status Enable Register.

<numeric_value> is,

numeric A decimal expression of the contents of the Standard Event Status Enable Register

Query response is a numeric value in <NR1> format.

***ESE?**

Queries the contents of the Standard Event Status Enable Register.

Query response is a numeric value in <NR1> format.

***ESR?**

Queries the contents of the Standard Event Status Register. (Query only)

Query response is a numeric value in <NR1> format.

***IDN?**

Queries an identification string which consists of four fields separated by commas. (Query only)

Query response is <Field 1>,<Field 2>,<Field 3>,<Field 4>.

Where,

Field 1: Manufacturer (always AGILENT TECHNOLOGIES)

Field 2: Model number (always 4339A)

Field 3: Serial number in Agilent format (like 2419J00100)

Field 4: Firmware version number (like 01.00)

***LRN?**

Returns a sequence of commands that defines the 4339B's current state. (Query only)

***OPC**

Tells the 4339B to set bit 0 (OPC bit) in the Standard Event Status Register when it completes all pending operations.

*0PC? tells the 4339B to place an ASCII character 1 into the Output Queue when it completes all pending operations.

*RCL <numeric_value>

Recalls the instrument state previously stored in the specified register number. The 4339B has 10 available storage registers. (No query)

<numeric_value> is,

numeric 0 to 9

*RST

Returns the 4339B to its default state and sets the following commands.

```
INITiate:CONTinuous OFF
[SENSe:]CORRection[:STATe] OFF
SYSTem:KLOCk OFF
```

(No query)

*SAV <numeric_value>

Saves the instrument state in the specified register number. The 4339B has 10 available storage registers. (No query)

<numeric_value> is,

numeric 0 to 9

*SRE <numeric_value>

Sets the bits of the Status Byte Enable Register.

<numeric_value> is,

numeric decimal expression of the contents of the Statue Byte Enable Register (Bit 6 must be always 0)

Query response is a numeric value in <NR1> format.

*STB?

Queries the contents of the Status Byte Register. (Query only)

Query response is a numeric value in <NR1> format.



*TRG

Triggers the 4339B when BUS is selected as the ARM source. (No query)

Warning



When the 4339B is in the sequence measurement mode, sending *TRG may cause the 4339B to output dangerous voltage levels up to 1000 Vdc. Do NOT touch the UNKNOWN terminals or the electrodes of the accessory, when the V Output indicator is ON.

***TST?**

Executes an internal self-test and returns the test result as the sum of the error codes of all existing errors. If there is no error the 4339B returns a 0.

Test Item	Error Code
1. RAM	1
2. EPROM	2
3. Calibration data (EEPROM)	4
4. User's data (EEPROM)	8
5. AD converter	16
6. Backup RAM	32

Query response is a numeric value in <NR1> format.

***WAI**

Makes the 4339B wait until all previously sent commands are completed. (No query)

Status Reporting Structure

This section provides information about the status reporting structure for Service Request functions which correspond to SCPI.

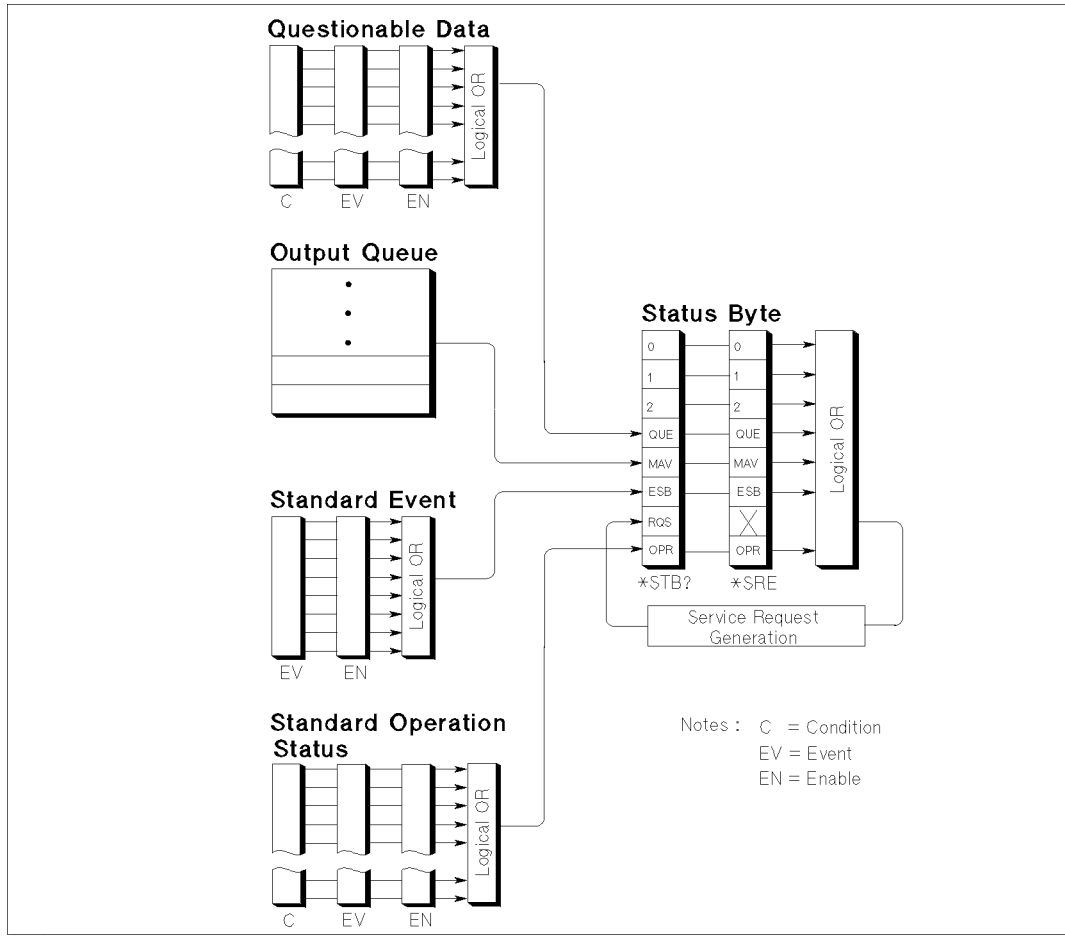

Figure 5-2. Status Reporting Structure

Service Request (SRQ)

The 4339B can send an SRQ (Service Request) control signal when it requires the controller to perform a task. When the 4339B generates an SRQ, it also sets Bit 6 of the Status Byte Register, RQS (Request Service) bit. Service Request Enable Register allows an application programmer to select which summary messages in the Status Byte Register may cause service requests. (Illustrated in Figure 5-3.)

Status Byte Register

The Status Byte Register is composed of eight bits that summarize an overlaying status data structure.

The Status Byte Register can be read using either *STB? or SP0LL, which return a decimal expression of the contents of the register (equal to the sum of the total bit weights of all the bits set to “1”).

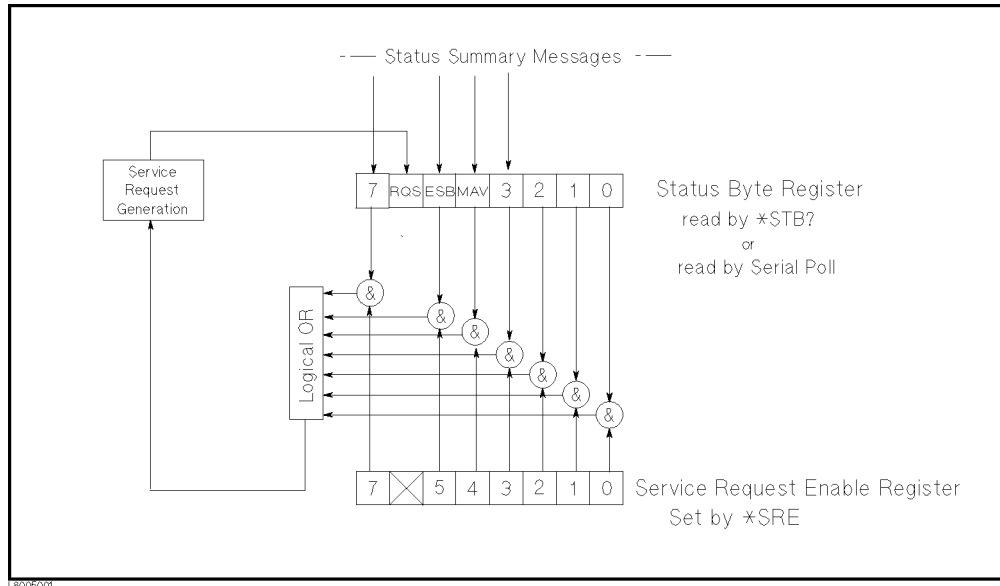

Figure 5-3. Status byte Register

Table 5-2. Status Byte Assignments

Bit No.	Bit Weight	Description
7	128	Operation Status Register Summary Bit
6	64	Request Service Bit — This bit is set when any enabled bit of the Status Byte Register has been set, which indicates 4339B has at least one reason for requesting service. SP0LL resets this bit.
5	32	Standard Event Status Register Summary Bit
4	16	Message Available Bit — This bit is set whenever the 4339B has data available in the Output Queue, and is reset when the available data is read.
3	8	Questionable Status Register Summary Bit
2-0		always 0 (zero)

Standard Event Status Register

The Standard Event Status Register is frequently used and is one of the simplest. You can program it using GPIB common commands, *ESE and *ESR?. Refer to *ESE command and *ESR? command in “Command Reference”.

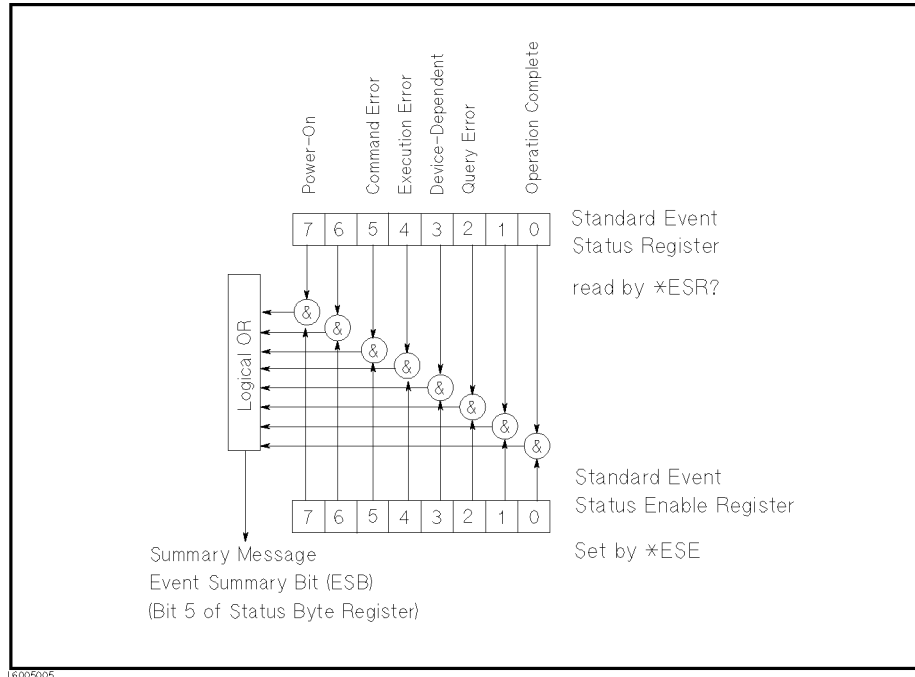

Figure 5-4. Standard Event Status Register

Table 5-3. Standard Event Status Register Assignments

Bit No.	Bit Weight	Description
7	128	Power-On Bit — This bit is set when the 4339B has been turned OFF and then ON since the last time this register was read.
6		always 0 (zero)
5	32	Command Error Bit — This bit is set if the following command errors occur. <ul style="list-style-type: none"> • An IEEE 488.2 syntax error occurred. • The 4339B received a Group Execute Trigger (GET) inside a program message.
4	16	Execution Error Bit — This bit is set when a parameter of a GPIB command was outside of its legal input range or was otherwise inconsistent with the 4339B’s capabilities.
3	8	Device-Dependent Error Bit — This bit is set when so many errors have occurred that the error queue is full.
2	4	Query Error Bit — This bit is set when reading data from the output buffer and no data was present, or when the data was lost.
1		always 0 (zero)
0	1	Operation Complete Bit — This bit is set when the 4339B has completed all selected pending operations before sending the *OPC command.

Standard Operation Status Group

The 4339B provides two Standard Operation Status groups — Operation Status Register group and Questionable Status Register group — which can be accessed using the STATus subsystem commands. (Refer to STATus subsystem in “Command Reference”.) This group is used in advanced programming. The individual bit assignment of these registers are given in “Operation Status Register” and “Questionable Status Register” later in this section.

Each group includes a condition register, an event register, and an enable register. (Illustrated in Figure 5-5.)

The condition register reflects the internal states of the 4339B. So each time the 4339B’s condition is changed, its condition bit is changed from “0” to “1”, or from “1” to “0”.

The event register’s bits correspond to the condition register’s bits. A transition filter reports an event to the event register, when a condition register bit changes from “1” to “0” for all bits, except for bit no. 8 and 9. For bit no.’s 8 and 9, reporting occurs when a condition register bit changes from “0” to “1”.

Note After the event register’s bits are set to 1, the bits are kept at 1 before reading or clearing them.



The enable register enables the corresponding bit in the event register to set the status summary bit, bit 7 or bit 3, of the Status Byte Register.

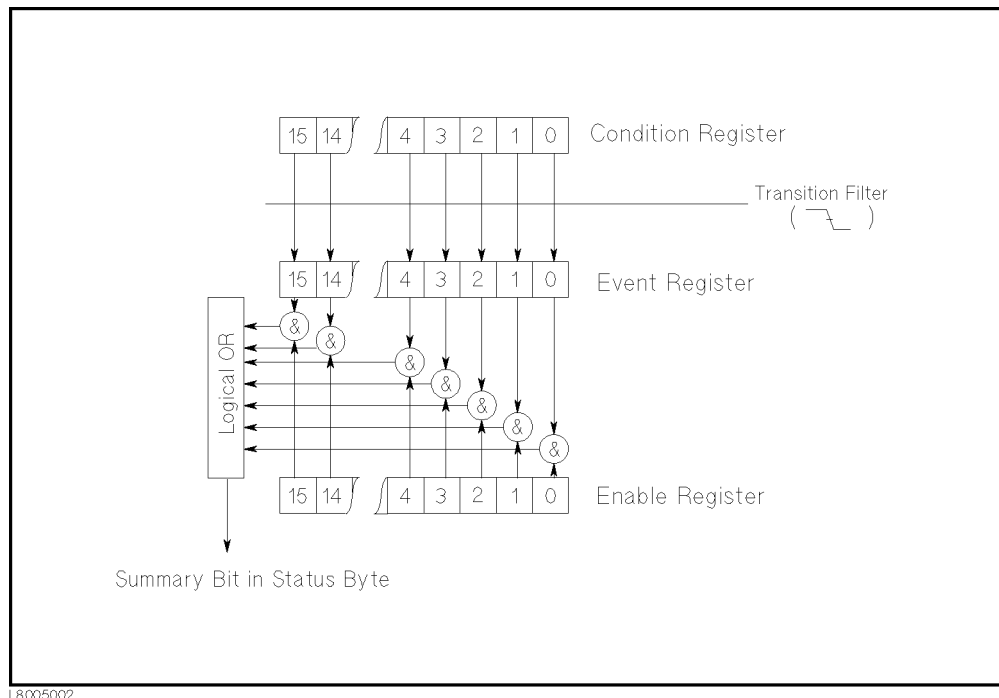

Figure 5-5. Standard Operation Status Group Structure

Operation Status Register

The Operational Status Register group provides information about the state of the 4339B measurement system.

Table 5-4. Operation Status Condition Register Assignments

Bit No.	Bit Weight	Description
9-15		Always 0
8	256	DBUF is full – this bit is set when DBUF is full.
7	128	Correcting – This bit is set when the correction data measurement is in progress.
6	64	Waiting for ARM – This bit is set when the 4339B is in the ARM Event Detection State of the trigger system.
5	32	Waiting for Trigger – This bit is set when the 4339B is in the TRIG Event Detection State of the trigger system.
4	16	Measuring – This bit is set when the 4339B is actively measuring.
3		Always 0 (zero)
2	4	Ranging – This bit is set when the 4339B is currently changing its measurement range.
1	2	Settling – This bit is set when the 4339B is waiting for signals it controls to stabilize enough to begin a measurement.
0	1	Calibrating – This bit is set when the 4339B is currently performing a calibration.

Table 5-5. Operation Status Event Register Assignments

Bit No.	Bit Weight	Description
9-15		Always 0 (zero)
8	256	This bit is set when DBUF has become full.
7	128	This bit is set when the correction data measurement has completed.
6	64	This bit is set when the 4339B has been in the ARM Event Detection State of the trigger system.
5	32	This bit has been set when the 4339B has been in the TRIG Event Detection State of the trigger system.
4	16	This bit is set when the measurement has completed.
3		Always 0 (zero)
2	4	This bit is set when the ranging has been completed.
1	2	This bit is set when the settling has completed.
0	1	This bit is set when the calibration has completed.

Questionable Status Register

The 4339B has no operation to report the event to the Questionable Status Register group, all of whose bits are always 0. This register is available to keep consistency with other SCPI compatible instruments.

Trigger System

This section provides information about the trigger system of the 4339B. SCPI defines a common trigger model for several types of instruments. The trigger system allows you to have specific control of your measurements.

Information on the trigger system requires more technical expertise than most other topics covered in this chapter. But you can avoid having to learn the information in this section by using the `:INITiate` commands to make your measurements.

4339B Trigger System Configuration

The trigger system synchronizes the 4339B measurement with specified events. Events include GPIB trigger command or input pulse on Ext Trigger terminal. The trigger system also allows you to specify the number of times to repeat a measurement and the delays between measurements.

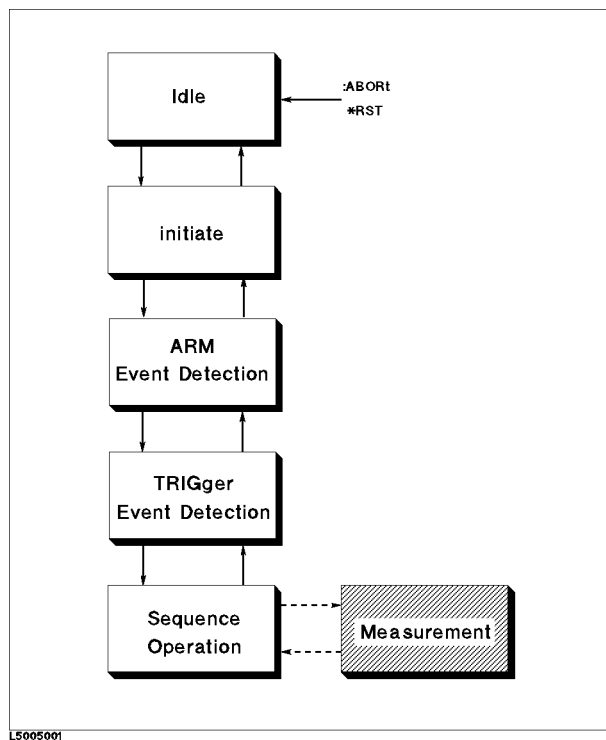

Figure 5-6. Trigger System Configuration

Figure 5-6 shows the configuration of the 4339B trigger system. Each block is a **trigger state**. The 4339B moves between adjacent states depending on its conditions. The power ON state is called the **Idle** state. You can force the 4339B to the idle state using the `:ABORT` or `*RST` command. The **Initiate**, **ARM Event Detection**, and **Trigger Event Detection** states branch to the next state when the 4339B satisfies the specified conditions. The **Sequence Operation** state signals the instrument hardware to take a measurement and waits for a signal indicating that the measurement has been taken.

Idle State

The trigger system remains in the idle state until it is initiated by :INITiate[:IMMediate] or :INITiate:CONTinuous ON commands. Once one of these conditions is satisfied, the trigger system exits downward to the initiate state. Note that *RST sets INITiate:CONTinuous OFF.

Initiate State

If the trigger system is on a downward path, it travels directly through the initiate state without restrictions. If the trigger system is on an upward path, and :INITiate:CONTinuous is ON, then it exits downward to an Trigger Event Detection state. If the trigger system is on an upward path and :INITiate:CONTinuous OFF, then it exits upward to the Idle state.

ARM Event Detection State

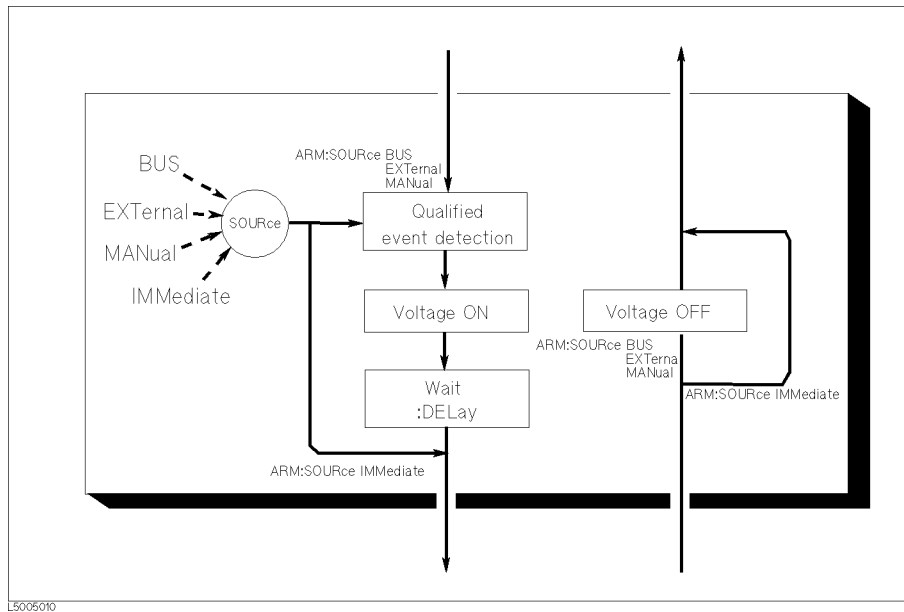

Figure 5-7. Inside an ARM Event Detection State

SOURce The :ARM[:SEQuence1][:LAYer]:SOURce command selects an ARM event source. When the SOURce is set to BUS, EXTERNAL, or MANUAL, the 4339B waits for the ARM event detection, and moves its state downward through “Voltage ON” and “Wait” state. When the SOURce is set to IMMEDIATE, the 4339B immediately exits the ARM event detection state, without waiting the ARM event, and bypasses the “Voltage ON” and “Wait” states.

DELay The :ARM[:SEQuence1][:LAYer]:DELay command specifies a time duration between the recognition of an event and the downward exit. Sending an *RST command sets DELay to zero.

On the downward path, all the conditions for ARM must be satisfied before the TRIG events can be sensed.

TRIG Event Detection State

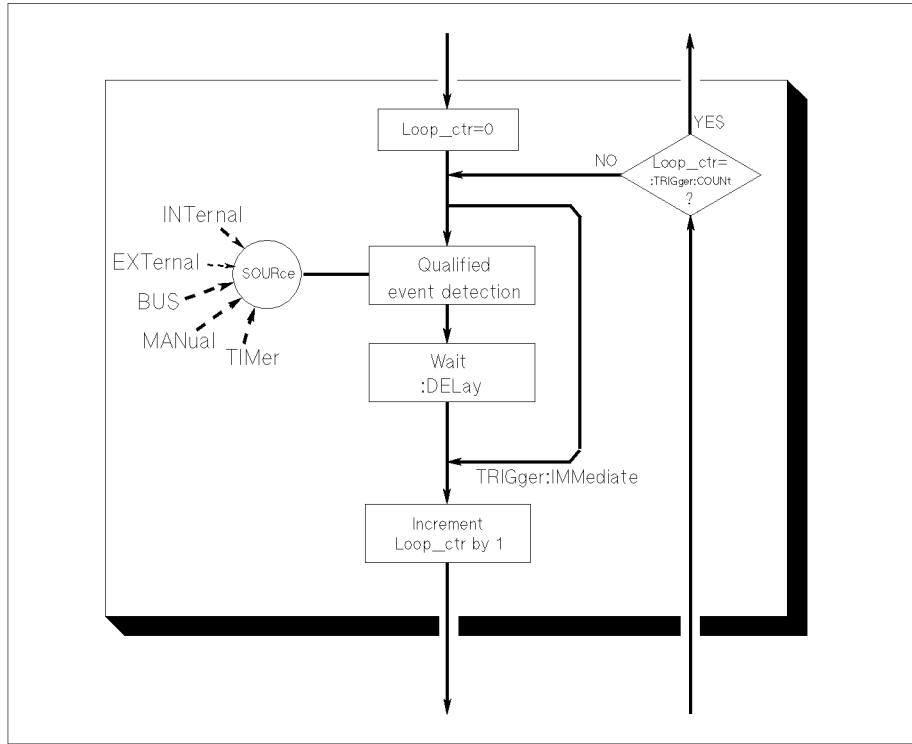

L5005002

Figure 5-8. Inside a TRIG Event Detection State

- SOURCE** The :TRIGger[:SEquence1]:SOURCE command specifies which particular input can generate the event required to continue the downward path.
- DELay** The :TRIGger[:SEquence1]:DELay command specifies a time duration between the recognition of an event and the downward exit. Sending an *RST command sets DELay to zero.
- IMMediate** The :TRIGger[:SEquence1]:IMMediate command bypasses the event detection, DELay qualifications one time.
- COUNT** The :TRIGger[:SEquence1]:COUNT command controls the trigger system on an upward path through an TRIG Event Detection state. COUNT specifies how many downward exits must occur before an upward exit is allowed. Sending *RST sets COUNT to 1.

Sequence Operation State

The downward entrance to the sequence operation state forces the 4339B to start a measurement. An upward exit is not allowed until the measurement is complete.

Data Transfer Format

AScii

Numeric data is transferred as ASCII bytes in <NR1> (integer), <NR2> (fixed point) or <NR3> (floating point) formats, as appropriate. The numbers are separated by commas as specified in IEEE 488.2.

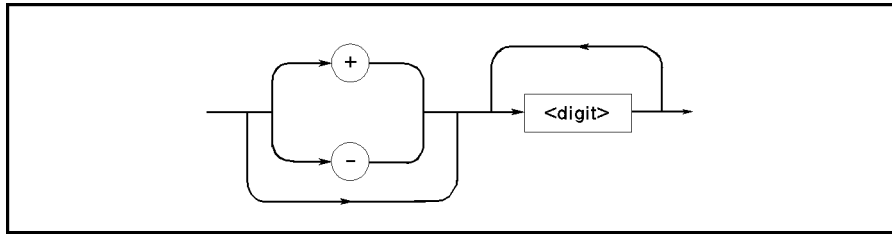

Figure 5-9. NR1 Format

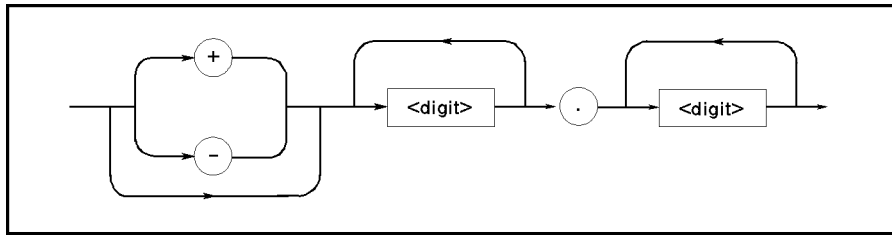

Figure 5-10. NR2 Format

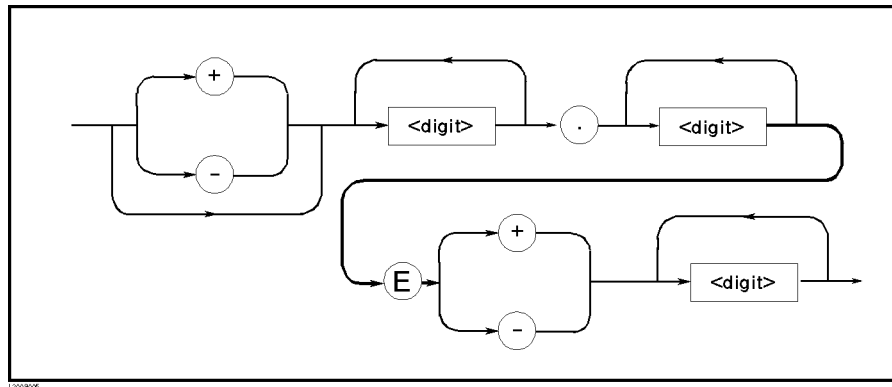

Figure 5-11. NR3 Format

For example, expressions for “1000” are,

+1000	<NR1> format
+1000.0	<NR2> format
+1.00000E+03	<NR3> format

REAL

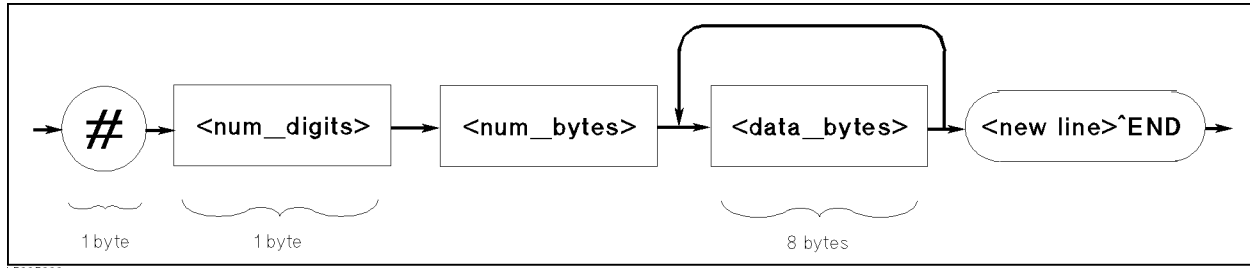

Figure 5-12. Real Data Format

This data field is initiated by a unique code, the number sign (#). The second byte, “<num_digit>” designates the number of the bytes for the “<num_bytes>”. “<num_bytes>” designates “<data_bytes>” length. “<new line>^END ” is the response message terminator.

“<data_bytes>” contains the data in IEEE 754 floating point numbers of 64-bits. This is the same data format used by the HP Technical computers, such as the HP 9000 series 200/300 computers.

Bit No.	7	6	5	4	3	2	1	0
First byte sent	S	E ₁₀	E ₉	E ₈	E ₇	E ₆	E ₅	E ₄
Second byte sent	E ₃	E ₂	E ₁	E ₀	F ₅₁	F ₅₀	F ₄₉	F ₄₈
⋮	⋮	⋮	⋮	⋮	⋮	⋮	⋮	⋮
Eighth (last) byte sent	F ₇	F ₆	F ₅	F ₄	F ₃	F ₂	F ₁	F ₀

Where,

- S : Value of sign part (binary)
- E_n : Value of exponential part (binary)
- F_n : Value of fractional part (binary)
- EXP : Decimal expression of exponential part
- f : Decimal expression of fractional part

The real number RN represented in floating point format is provided by the following formula:

- When $0 < EXP < 2047$ (1111111111₂)

$$RN = (-1)^S \times 2^{(EXP-1023)} \times (1 + f/2^{52})$$

- When $EXP = 0$

$$RN = (-1)^S \times 2^{-1022} \times (f/2^{52})$$

- When $EXP = 0, f = 0$

$$RN = 0$$

For example,

$$\begin{aligned}
 S &= 1 \\
 EXP &= 1023 \text{ (011111111111}_2\text{)} \\
 f &= 2^{51} \text{ (1000 00000000 00000000 00000000 00000000 00000000 00000000}_2\text{)} \\
 RN &= (-1)^1 \times 2^{(1023-1023)} \times (1 + 2^{51}/2^{52}) \\
 &= -1 \times 1 \times 1.5 \\
 &= -1.5
 \end{aligned}$$

Command Summary

Table 5-6. Common Commands

Command	Parameter	Note	Command	Parameter	Note
*CLS		[no query]	*RST		[no query]
*ESE	<numeric_value>		*SAV	<numeric_value>	[no query]
*ESR?		[query only]	*SRE	<numeric_value>	
*IDN?		[query only]	*STB?		[query only]
*LRN?		[query only]	*TRG		[no query]
*OPC			*TST?		[query only]
*RCL	<numeric_value>	[no query]	*WAI		[no query]

Table 5-7. Subsystem Commands

Command	Parameter	Note
ABORt		[no query]
ARM		
	[SEquence1]	
	[:LAYer]	
	:DELay	<numeric_value>[MS S]
	:SOURce	{BUS EXTernal MANual IMMediate}
CALCulate1		
	:FORMat	{REAL SRESistivity VRESistivity}
	:LIMit	
	:BEEPer	
	:CONDition	{FAIL PASS}
	[:STATe]	<Boolean>
	:CLEar	[no query]
	:FAIL?	[query only]
	:LOWer	
	[:DATA]	<numeric_value>
	:STATe	<Boolean>
	:STATe	<Boolean>
	:UPPer	
	[:DATA]	<numeric_value>
	:STATe	<Boolean>
:MATH		
	:EXPReSSion	
	:CATalog?	[query only]
	:NAME	{DEV PCNT}
	:STATe	<Boolean>
:PATH?		[query only]
:RESistivity		
	:EAREa	<numeric_value>
	:EPERimeter	<numeric_value>
	:GLENgtH	<numeric_value>
	:STHickness	<numeric_value>
CALCulate2		
	:MATH	
	:STATe	<Boolean>
CALCulate3		
	:BEEPer	<Boolean>
	:DIREction	{UP DOWN}
	:FORMat	{SEC TPCNT}
	:MATH	
	:STATe	<Boolean>
CALibration		
	[:ALL]?	[query only]
	:AUTO	<Boolean>

Table 5-7. Subsystem Commands (continued)

Command	Parameter	Note
DATA		
[:DATA]	REF,<numeric_value>	
[:DATA]?	DBUF,IMON,TMON	[query only]
:FEED	DBUF,<data_handle>	
:CONTRol	DBUF,{ALWays NEVer}	
:POINts	DBUF,<numeric_value>	
DISPlay		
[:WINDow]		
[:STATe]	<Boolean>	
:TEXT1		
:DIgit	<numeric_value>	
:PAGE	<numeric_value>	
:PREFix	<Boolean>	
:TEXT2		
:PAGE	<numeric_value>	
FETCh?		[query only]
FORMat		
[:DATA]	{ASCIi REAL[,64]}	
INITiate		
:CONTinuous	<Boolean>	[no query]
:IMMEdiate		[no query]
OUTPut		
[:STATe]	<Boolean>	
[SENSe]		
:AVERAge		
:COUNT	<numeric_value>	
[:STATe]	<Boolean>	
:CORRection		
:COLLect		
[:ACQuire]	OFFSet	[no query]
:DATA?	{OFFSet SCAPacitance}	[no query]
[:STATe]	<Boolean>	
:CURRent		
:APERture	<numeric_value>[MS S]	
:RANGe		
:AUTo	<Boolean>	
[:UPPer]	<numeric_value>[PA MA UA A]	
:FUNCTion	<sensor_function>	
:CONtact		
:DATA?		[query only]
:LIM?		[query only]
:OFFSet	<numeric_value>[PF F]	
:VERify	<Boolean>	
SOURce		
:CURRent		
:LIMit		
[:AMPLitude]	<numeric_value>[MA A]	
:VOLTage		
[:LEVel]		
[:IMMEdiate]		
[:AMPLitude]	<numeric_value>[KV V]	
STATus		
:OPERation		
:CONDition?		[query only]
:ENABle	<numeric_value>	
[:EVENT]?		[query only]
:PRESet		
:QUESTionable		
:CONDition?		[query only]
:ENABle	<numeric_value>	
[:EVENT]?		[query only]

Table 5-7. Subsystem Commands (continued)

Command	Parameter	Note
SYSTem		
:BEEPer		
[:IMMEDIATE]		
:STATe	<Boolean>	
:ERRor?		[query only]
:KLOCK	<Boolean>	
:LFRequency	<numeric_value>	
:PRESet		
:VERSion?		[query only]
TRIGger		
[:SEQUENCE1]		
:COUNT	<numeric_value>	
:DELay	<numeric_value>[MS S]	
[:IMMEDIATE]		
:SOURce	{BUS EXTERNAL MANUAL INTERNAL TIMER}	
:TIMER	<numeric_value>[MS S]	

Application Measurement



Introduction

This chapter provides actual measurement examples for various types of devices. The measurement examples are:

- Measuring Insulation Resistance of Capacitors
- Measuring Resistivity of Insulation Materials
- Measuring Insulation Resistance of Electro-Mechanical Components

Measuring Insulation Resistance of Capacitors

This example shows insulation resistance measurement of a chip capacitor after it has been charged for 1 minute using the 16339A Component Test Fixture with the SMD module.

Warning  Do *NOT* touch the UNKNOWN terminals or the electrodes of the accessory, when the High Voltage indicator is ON, the 4339B outputs dangerous voltage levels up to 1000 Vdc. Before handling the 4339B or the accessory, turn OFF the test voltage pressing  and confirm that the High Voltage indicator is OFF.

1. Connect the shunt connector and the 16339A to the 4339B. (For the 16339A, use the Chip Component Module Configuration as shown in the *16339A Operation and Service Manual*).

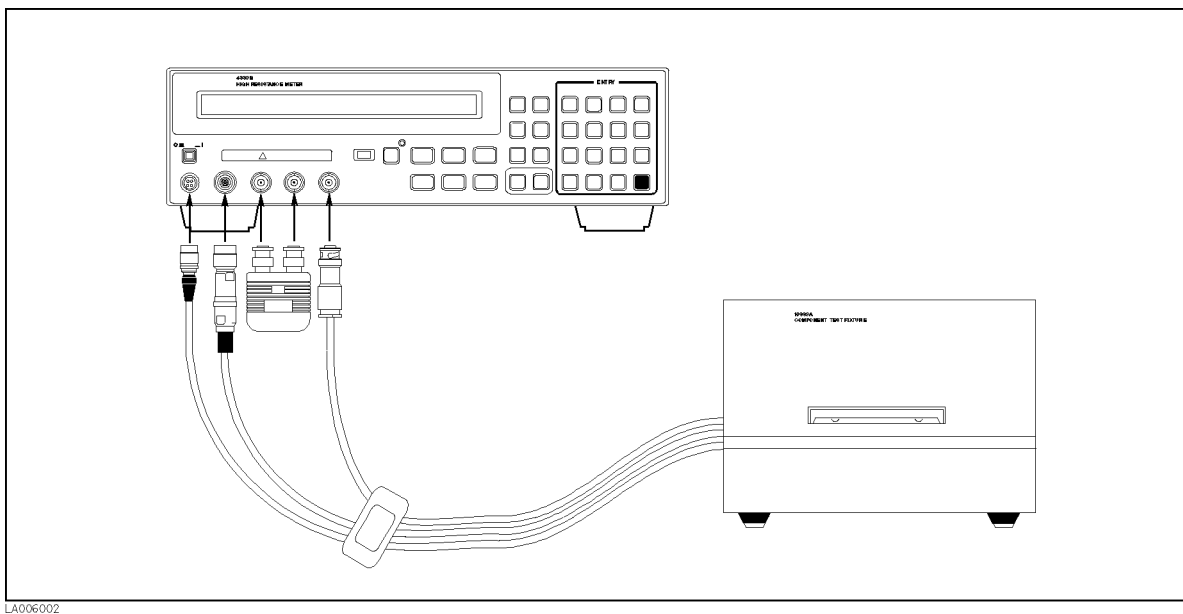

























Figure 6-1. Measurement Configuration

2. Set the SMD module to the 16339A, and connect the High terminals and the Low terminals respectively using the miniature banana cables.
3. Reset the 4339B.
Press   to display the reset menu. Select Yes using  or  and press .
4. Set the test voltage value.
Press . Enter the voltage value, for example 100 (V), and press .
5. Perform the calibration.
Press  . Select ExecCal using  or  and press .

6. Perform the OPEN correction.
 - a. Remove the DUT if connected, and set the SMD module's electrode contact spacing the same as the DUT's length, tightening the screw to hold this interval between the electrodes.
 - b. Close the top cover.
 - c. Select the Current measurement mode.

Press  to display the measurement parameter selection menu. Select I using  or  and press .
 - d. Apply the source voltage by pressing .
 - e. Wait until the current has stabilized to within 0.5 pA. (Displayed I values do not change by more than 0.5 pA.)
 - f. Press   to display the OPEN correction menu.
 - g. Select OpenMeas using  or  and press .
 - h. After the OPEN correction is finished, press  to turn the source voltage OFF.
7. Clip the capacitor to the 16339A (see Figure 6-2), and close the top cover.

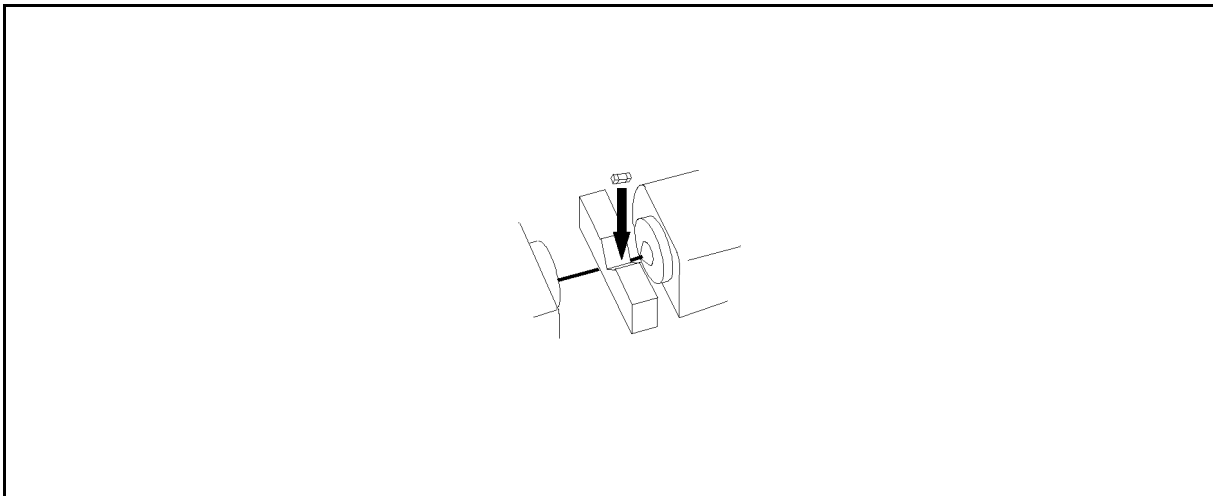











Figure 6-2. Chip Capacitor Binding





8. Select Resistance as the measurement parameter.

Press  to display the measurement parameter selection menu. Select R using  or  and press .

9. Set the measurement sequence configuration.



Press  . Select **Chrg** using  or  and press . Enter the charge time, for example 60 (s). Press  twice.

10. Select the single mode as the measurement sequence mode.

Press . Select **Single** using  or  and press .

11. Start the measurement sequence.

Press . The **Seq Running** annunciator(▼) is turned ON, and the 4339B applies the test voltage across the capacitor for 60 seconds.

Note If you want to abort the measurement sequence, press  .



When the sequence measurement is finished, the annunciator is turned OFF and the measurement result is displayed.

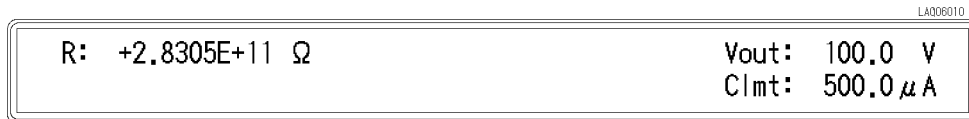



12. To exit the measurement sequence,



Press . Select **Off** using  or  and press .

13. Wait until the High Voltage indicator is OFF. Then remove the DUT from the test fixture.

Measuring Resistivity of Insulation Materials

This section provides measurement example of resistivity of insulation film using the 16008B Resistivity Cell with the $\phi 50$ main electrode.

Warning  **Do NOT touch the UNKNOWN terminals or the electrodes of the accessory, when the High Voltage indicator is ON, the 4339B outputs dangerous voltage levels up to 1000 Vdc. Before handling the 4339B or the accessory, turn OFF the test voltage pressing  and confirm that the High Voltage indicator is OFF.**

Note  The thickness of the DUT should be measured accurately because thickness data is used to calculate volume resistivity. (see “Electrode Size Key  ” in Chapter 3) To reduce the reading error when you measure a thickness using a micrometer, you should average the thickness values measured at several points in the measurement area and then use this average value to obtain the dielectric constant.

1. Connect the shunt connector and the 16008B to the 4339B as shown below.

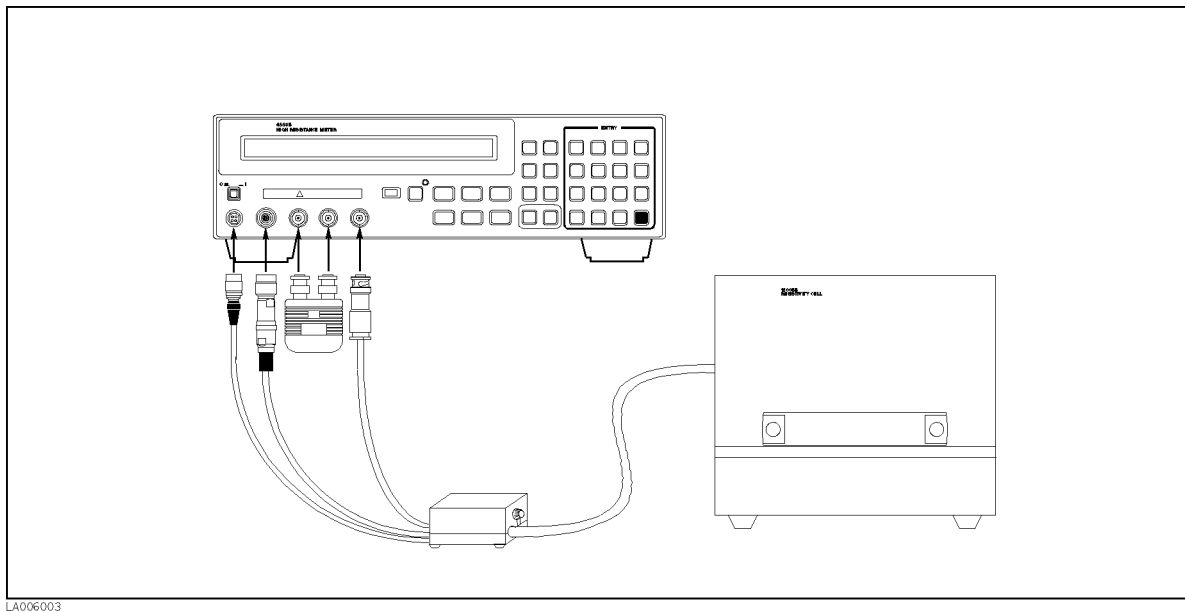









Figure 6-3. Measurement Configuration





2. Reset the 4339B

Press   to display the reset menu. Select Yes using  or  and press .

3. Set the source voltage value.





Press . Enter the voltage value, for example 500 (V), and press .

4. Perform calibration.

Press   . Select ExecCal using  or  and press  .



5. Perform the OPEN correction.

- a. Turn the load knob counterclockwise until the upper electrode does not move.
- b. Close the top cover.
- c. Select the Current measurement mode.

Press  to display the measurement parameter selection menu. Select I using  or  and press  .

d. Apply the source voltage by pressing  .

e. Wait until the current has stabled to within 0.5 pA. (Displayed I value do not change by more than 0.5 pA.)

f. Press   to display the OPEN correction menu.

g. Select OpenMeas using  or  and press  .

h. After the OPEN correction is finished, press  to turn the source voltage OFF.

6. Place the DUT on the electrode of resistivity cell. Set the upper electrode into position.

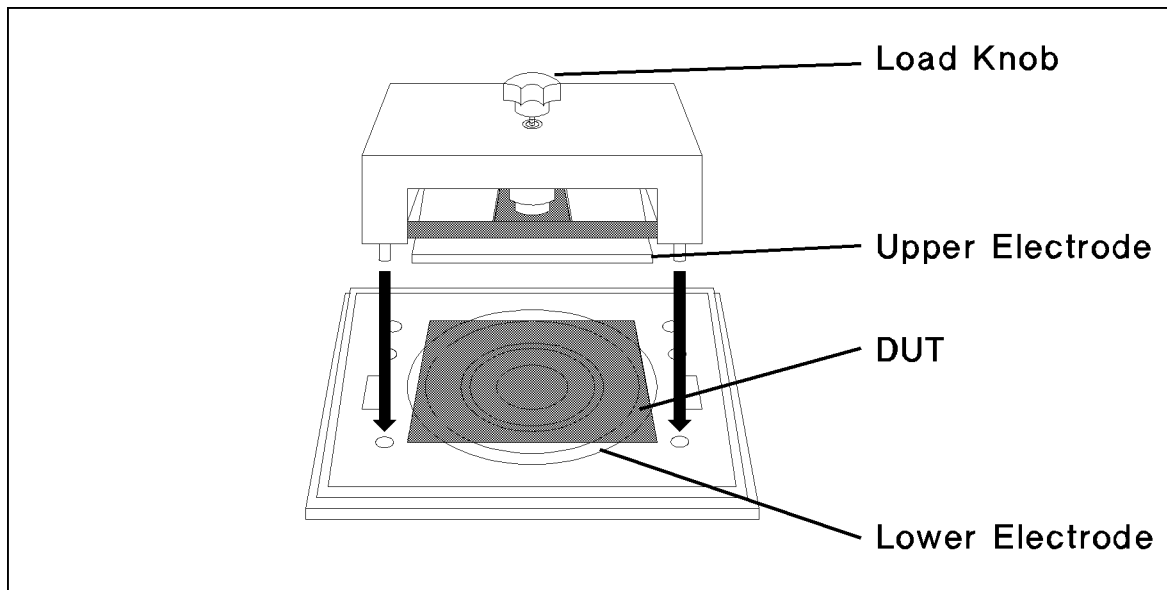

Figure 6-4. Resistivity Cell Setup

7. Turn the load knob to apply pressure by the upper and lower electrodes on the DUT, and then close the top cover.





Turning load knob applies load pressure on the DUT of up to approximately 10 kg. If you do not need to apply a specific pressure, DUT must at least firmly held by the upper and lower electrodes.

8. Set the resistivity cell parameter

- a. Press  .







- b. Enter DUT thickness.

Select Thickness using  or  and press . Enter the thickness value, for example 0.13 (mm), and press .

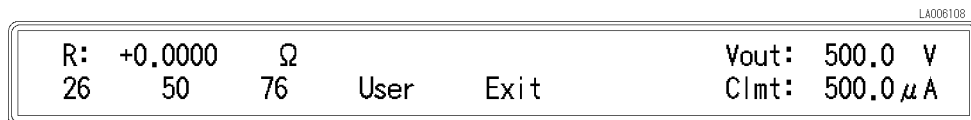
- c. Select the resistivity cell size.

Select ResCell using  or  and press .







Select 50 (mm) using  or , and press  twice.

- d. Select Exit and press  to exit.





9. Set the measurement sequence configuration.

Press  . Select Charge and press . Enter the charge time, for example 60 (s), and press  twice.

10. Select the single mode as the measurement sequence mode.

Press . Select Single using  or  and press .



11. Measuring the volume resistivity.

- a. Turn the Volume/Surface selector of the 16008B to “Volume”.
- b. Press . Select Rv using  or  and press .
- c. Press .

This starts the volume resistivity measurement sequence. Measured volume resistivity value will be displayed after 60 seconds charge time.



Note

If you want to abort the measurement sequence, press  .





12. Measuring surface resistivity.

- a. Turn the Volume/Surface selector to “Surface”.
The 4339B id automatically set to Rs measurement mode.
- b. Press .

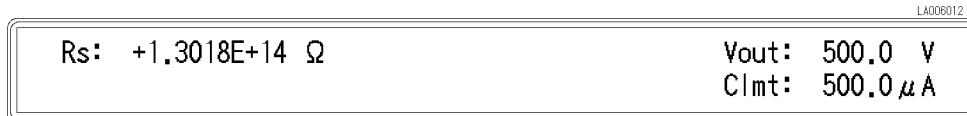
This starts the surface resistivity measurement sequence. Measured surface resistivity value will be displayed after 60 seconds charge time.



Note

If you want to abort the measurement sequence, press  .



13. To exit the measurement sequence,

- Press . Select Off using  or  and press .

14. Wait until the High Voltage indicator is OFF. Then remove the DUT from the test fixture.

⚠ Measuring Insulation Resistance Time Characteristics of Electro-Mechanical Components

This section provides an example of measuring electro-mechanical components like switches, connectors, or relays. This example measures insulation resistance (IR) time characteristics of opened switch contacts using the continuous measurement sequence mode, to obtain time characteristics.

In this example, we measure the insulation resistance of opened switch DUT, and print measurement data to printer. We take a measurement every 10 seconds for 10 minutes after a charge time of 60 seconds.

Warning ⚠ **Do NOT touch the UNKNOWN terminals or the electrodes of the accessory, when the High Voltage indicator is ON, the 4339B outputs dangerous voltage levels up to 1000 Vdc. Before handling the 4339B or the accessory, turn OFF the test voltage pressing  and confirm that the High Voltage indicator is OFF.**

1. Connect the shunt connector and the 16339A to the 4339B, and connect the printer using an GPIB cable. (For the 16339A, use the Alligator Clip and Flat Table Configuration as shown in the *16339A Operation and Service Manual*.)

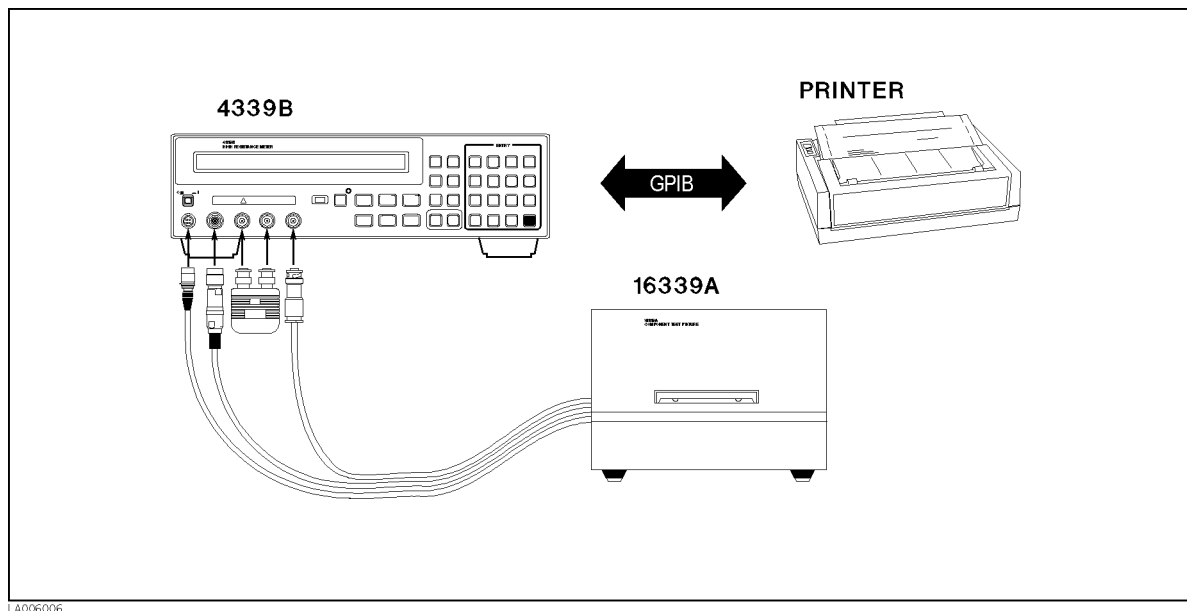













Figure 6-5. Measurement Configuration

2. Set the printer to the Listen Always mode.
3. Reset the 4339B
Press   to display the reset menu. Select Yes using  or  and press .
4. Set the test voltage value.
Press . Enter the voltage value, for example 500 (V), Press .

5. Perform the calibration.

Press   . Select ExecCal using  or  and press  .

6. Perform the OPEN correction.

a. Remove the alligator clips and banana cables from the INPUT terminal.



b. Close the top cover.

c. Select the current measurement mode.

Pressing  . Select I using  or  and press  .

d. Apply test voltage by pressing  .

e. Wait until the current has stabled to within 0.5 pA. (Displayed I value do not change by more than 0.5 pA.)

f. Press   to display the OPEN correction menu.

g. Select OpenMeas using  or  and press  .

h. After the OPEN correction is finished, press  to turn the source voltage OFF.

7. Connect the electrodes of the *opened* switch DUT with alligator clips as shown below. Close the cover of the 16339A.

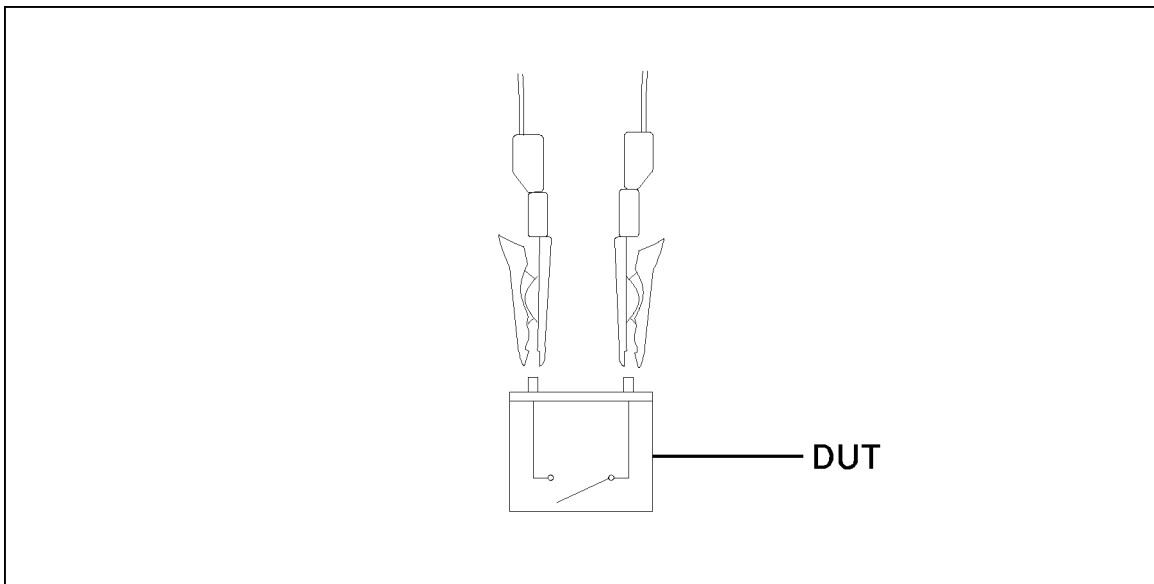

L5006001

Figure 6-6. Clipping Opened Switch

8. Select Resistance as the measurement parameter.

Press  . Select R using  or  and press  .

4339B**Measuring Insulation Resistance Time Characteristics**

9. Set sequence mode parameters.

Press  .

a. Set the charge time.





Select Chrg. Enter the charge time value, in this example 60 (s). Press .

b. Set the interval time and memory size.



Select Intvl. Enter the interval time value, in this example 10 (s). Press .

Then enter the number of measurements (equivalent to the memory size), in this example 60. Press .

c. Select the continuous mode as the measurement sequence mode.

Press . Select Continuous using  or  and press .

10. Set the 4339B to Talk Only mode.

Press   and enter 31. Press .



11. Start the measurement sequence.

Press . The printer begins printing data.

```
+0,+6.51404E+10,+0
+0,+6.63321E+10,+0
+0,+6.45753E+10,+0
⋮
```

Figure 6-7. Printed Results

Note

If you want to abort the measurement sequence, press  .



12. When the measurement sequence is completed, change the GPIB address to an address other than 31.

13. Wait until the High Voltage indicator is OFF. Then remove the DUT from the test fixture.

Measurement Basics

Introduction

This chapter provides information that will help you to work with your 4339B more effectively.

- Insulation Resistance Measurement
- Resistivity
- High capacitance DUT Measurement

Insulation Resistance Measurement

Residual Charge Effect

Once a high resistance insulation material is charged with a voltage, a residual voltage will still remain on the material for a while after the charging voltage is removed. When you want to measure a high resistance material after charging and measuring it once, you must wait long enough to discharge the voltage across DUT from the previous measurement before making another measurement, or the measurement value may be incorrect.

Absorption Phenomena

When a high resistance insulation material remains charged with a voltage for a long time, its resistance value will increase. So record the time from which the charge was applied to the DUT to the start of the measurement.

Voltage Coefficient and Temperature Coefficient

The resistance value of an insulation material depends on the measurement voltage: the resistance value of most insulation materials will increase as the measurement voltage increases.

The resistance of an insulation material depends on its temperature. To measure accurately, place the DUT into an environmental test chamber to keep the DUT's temperature at a constant known level when making a measurement.

Record the measurement voltage and temperature when making a measurement.

Shielding

Variation in total current seen by the measurement circuit can be caused by power-line noise pickup, adjacent electro-magnetic fields of excessive strength, flexing the test leads beyond reasonable limits, or by changing the position of the leads relative to their surroundings. Most noise problems of this type are transient, and contribute more inconvenience than error. Any suitable enclosure will suffice to reduce unwanted noise pick-up. Connect the shield to the guard (ground). When using sensitive measurement ranges, lead movement or operator proximity will affect the stability of the measurement. Stationary leads and shielding are recommended.

Resistivity

Volume Resistivity

In general, volume resistivity is defined as the resistance per unit volume.

$$\rho_v = \frac{Area}{t} R_v \times \frac{1}{10}$$

where,

ρ_v	Volume resistivity [Ω -cm]
$Area$	Effective area [mm^2]
t	Thickness of the sample [mm]
R_v	Measured volume resistance [Ω]

When the 16008B Resistivity Cell is used, the above equation becomes:

$$\rho_v = \frac{\pi \times \left(D_1 + \frac{B(D_2 - D_1)}{2} \right)^2}{4t} \times R_v \times \frac{1}{10}$$

Where,

D_1	Main electrode diameter [mm]
D_2	Guard electrode diameter [mm]
B	Effective area coefficient

B is the fraction of the gap width to be added to the diameter of the circular electrodes or to the dimensions of rectangular or cylindrical electrodes. The value is usually specified by the standard that you use. (For example: 1 for ASTM D 257; 0 for JIS K6911).

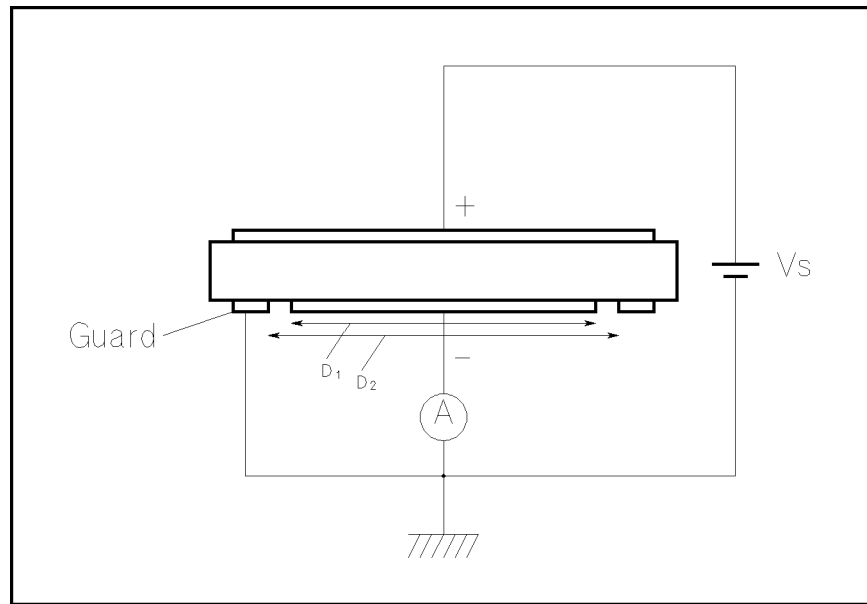

Figure 7-1. Volume Resistivity

Surface Resistivity

Surface Resistivity is defined as resistance per unit surface area. Similar to volume resistivity, surface resistivity is the resistance of a square of a material whose side length is 1 m, (one square meter). Surface resistivity is given as:

$$\rho_s = \frac{Perimeter}{Gap} R_s$$

where,

- ρ_s Surface resistivity [Ω]
- Perimeter* Effective perimeter [mm]
- Gap* Gap between main and guard electrodes [mm]
- R_s Measured surface resistance [Ω]

When the 16008B Resistivity Cell is used, the equations above become:

$$\rho_s = \frac{\pi(D_1 + D_2)}{D_2 - D_1} R_s$$

- D_1 Main electrode diameter [mm]
- D_2 Guard electrode diameter [mm]

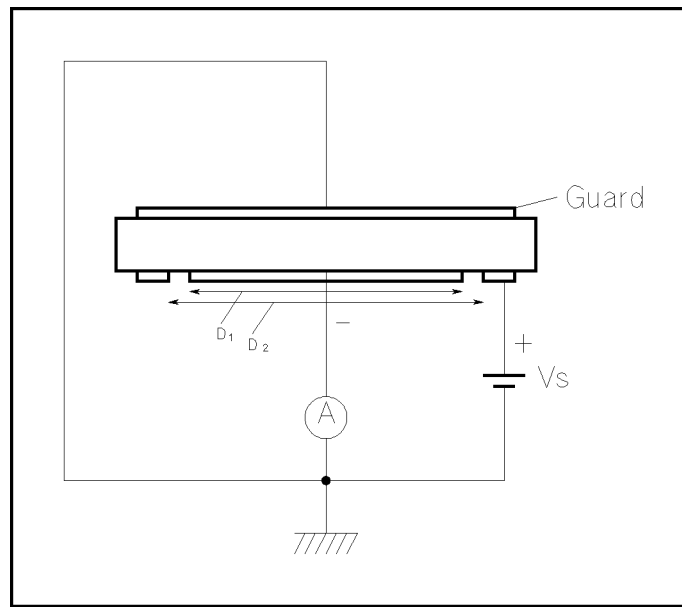

Figure 7-2. Surface Resistivity

High Capacitance DUT Measurement

When the 4339B measures a DUT that has high capacitance, AC noise creates major instability factors in the measurement because capacitance is sensitive to AC noise. If you want to measure the resistance of a high-capacitance DUT maintaining more than 10 % of S/N (Signal/Noise) ratio, the maximum capacitance of the DUT's for each measurement range are listed in Table 7-1.

Table 7-1. Maximum Measurable Capacitance

Measurement Range	Measurement Time		
	Short	Medium	Long
100 pA	—	1 nF	10 nF
1 nA	1 nF	10 nF	100 nF
10 nA	10 nF	100 nF	1 μ F
100 nA	100 nF	1 μ F	10 μ F
1 μ A	1 μ F	10 μ F	100 μ F
10 μ A	10 μ F	100 μ F	1 mF
100 μ A	100 μ F	—	—

To measure a DUT with even higher capacitance, connect a resistor in series with DUT to reduce the measurement flicker. The 16339A Component Test Fixture with its exchangeable output resistors is an ideal solution for this application. The 16339A has four output resistor (100 k Ω , 1 M Ω , 10 M Ω , and 100 M Ω). Ideally, a higher series resistance enables more stable measurement. However, there are limitations to these resistances of each measurement range, as listed in Table 7-2.

Table 7-2. Limit Output Resistance for Each Range

Measurement Range	Output Resistor
100 pA	100 M Ω
1 nA	10 M Ω
10 nA	1 M Ω
\geq 100 nA	100 k Ω

In addition, Table 7-3 shows the appropriate resistor for each range and measurement time mode.

Table 7-3. Appropriate Output Resistance for Range

Measurement Range	Measurement Time Mode		
	Short	Medium	Long
100 pA	—	10 MΩ (100 MΩ ¹)	10 MΩ(100 MΩ ¹)
1 nA	10 MΩ	1 MΩ	1 MΩ
10 nA	1 MΩ	100 kΩ	100 kΩ
100 nA	100 kΩ	(100 kΩ) ²	(100 kΩ) ²
1 μA	(100 kΩ) ²	Short Bar ³	Short Bar ³
10 μA	Short Bar ³	Short Bar ³	Short Bar ³
100 μA	Short Bar ³	—	—

1 100 MΩ resistor is effective for measuring current less than 10 pA in 100 pA range.

2 Using 100 kΩ resistor is recommended, but the response will become slow.

3 4339B's internal input and output resistance are sufficient, so an extra resistor in series is not necessary, in this range and mode.

Note



Using a high resistance in series with the DUT causes the charging time constant to increase, thereby increasing the necessary measurement time.

Warning



Do NOT touch the electrode and UNKNOWN connector while the High Voltage indicator is lit which shows the 4339B's output is a high voltage levels up to 1000 Vdc maximum. You must operate after turning off the voltage source output and you have confirmed the high voltage indicator is turned off.

Figure 7-3 shows the measurement configuration for this application.

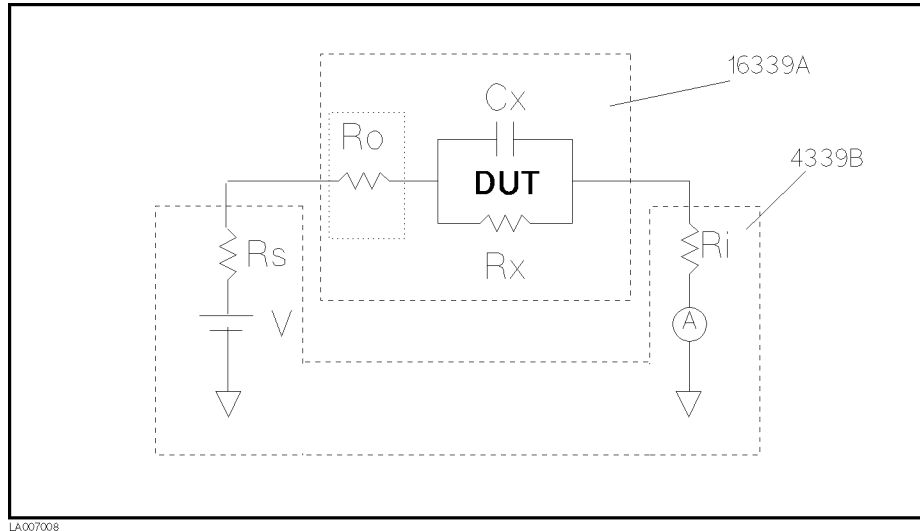

Figure 7-3. Capacitance Measurement Configuration

Where,

- R_s Output Resistance of the 4339B
- R_x Parallel resistance of the DUT
- C_x Parallel capacitance of the DUT
- R_i Input resistance of the 4339B
- R_o Additional Series Output Resistance of the 16339A

Necessary charging time is approximately led by following equation.

$$t_c = -\tau \times \ln\left(\frac{X}{100} \times \frac{R_s + R_i + R_o}{R_x}\right)$$

Where,

- t_c : Charge time [s]
- X : Measurement Error [%]
- $\tau = C_x \times (R_s + R_i + R_o)$

Generally, when measuring these types of DUT's as described in this section, you should expect a charging time of more than 10 or 20 times τ .

Note



The charge time of an ideal capacitor is shown in this section. Generally, you should consider characteristics of a dielectric for the estimation of the actual charge time.

Note



When the additional series resistor value is too high, its resistance can not be disregarded and it causes additional measurement error.

Specifications

This chapter contains a list of specifications for reference and performance verifications. When shipped from the factory, the 4339B meets the specifications listed in this chapter.

This chapter also includes supplemental characteristics. These characteristics are not specifications but are typical characteristics included as supplemental information for the operator.

Specifications

These specifications are the performance standards or limits against which the instrument is tested. When shipped from the factory, the 4339B meets the specifications listed in this section. The specification test procedures are covered in Chapter 9.

Measurement Parameters

R (dc resistance), I (dc current), ρ_s (surface resistivity), ρ_v (volume resistivity)

Measurement Conditions

DC Test Voltage (Vs)

■ Range

0 to 1000 V, 0.1 V steps for $V_s \leq 200$ V or 1.0 V steps for $V_s > 200$ V

■ Accuracy

$\pm (0.16\% + 100 \text{ mV})$ for $V_s \leq 200$ V

$\pm (0.16\% + 500 \text{ mV})$ for $V_s > 200$ V

■ Maximum Current

10 mA for $V_s \leq 100$ V

5 mA for $V_s \leq 250$ V

2 mA for $V_s \leq 500$ V

1 mA for $V_s > 500$ V

■ Current Compliance Setting

0.5 mA, 1 mA, 2 mA, 5 mA, 10 mA

Ammeter

■ Input Resistance

1 k Ω \pm 5%

■ Input Offset Voltage

$\leq \pm 500 \mu\text{V}$

Test Cable Length

2 meters maximum

Measurement Time Mode

Short, Medium, and Long

Ranging

Auto and Hold (manual)

Averaging

1 to 256

4339B

Specifications

Trigger Mode

Internal, Manual, External, and Bus

Trigger Delay Time

0 to 9.999 seconds in 0.001 seconds steps

Measurement Range

- **R:** 1×10^3 to $1.6 \times 10^{16} \Omega$
- **I:** 60 fA to 100 μ A

Measurement Accuracy

The following conditions must be met for measurement accuracy to apply:

1. Warm up time: ≥ 30 min
2. Ambient temperature: 23 ± 5 °C
3. Offset-error canceling is ON.
4. OPEN correction has been performed.
5. Self calibration has been performed.

Table 8-1. Measurement Accuracy

Range	Measurement Time Mode	Resistance Measurement ^{1,2,3} ±(% of Readings)	Current Measurement ^{2,3,4} ±(% of Readings)
100 pA	Short	—	—
	Medium	$4.4 + \left(\frac{100V_o + 100 \times 10^{-12} R_m}{V_s}\right)$ [$4.4 + \left(\frac{100V_o + 110 \times 10^{-12} R_m}{V_s}\right)$] ⁵	$2.57 + \left(\frac{100 \times 10^{-12}}{I_m}\right)$ [$2.57 + \left(\frac{110 \times 10^{-12}}{I_m}\right)$] ⁵
	Long ⁶	$4.4 + \left(\frac{100V_o + 6 \times 10^{-12} R_m}{V_s}\right)$ ⁷ [$4.4 + \left(\frac{100V_o + 5 \times 10^{-11} R_m}{V_s}\right)$] ^{7, 8} [$4.4 + \left(\frac{100V_o + 8 \times 10^{-12} R_m}{V_s}\right)$] ^{5, 7}	$2.57 + \left(\frac{6 \times 10^{-12}}{I_m}\right)$ ⁷ [$2.57 + \left(\frac{5 \times 10^{-11}}{I_m}\right)$] ^{7, 8} [$2.57 + \left(\frac{8 \times 10^{-12}}{I_m}\right)$] ^{5, 7}
1 nA	Short	$4.4 + \left(\frac{100V_o + 100 \times 10^{-11} R_m}{V_s}\right)$	$1.12 + \left(\frac{100 \times 10^{-11}}{I_m}\right)$
	Medium	$4.4 + \left(\frac{100V_o + 20 \times 10^{-11} R_m}{V_s}\right)$	$1 + \left(\frac{20 \times 10^{-11}}{I_m}\right)$
	Long	$4.4 + \left(\frac{100V_o + 3 \times 10^{-11} R_m}{V_s}\right)$ ⁷ [$4.4 + \left(\frac{100V_o + 5 \times 10^{-11} R_m}{V_s}\right)$] ^{7, 8}	$0.91 + \left(\frac{3 \times 10^{-11}}{I_m}\right)$ ⁷ [$0.91 + \left(\frac{5 \times 10^{-11}}{I_m}\right)$] ^{7, 8}

- 1 Rm: Measured resistance value [Ω].
 Vs: Voltage setting [V].
 Vo: 0.1 [V] (Vs ≤ 200 V) or 0.5 [V] (Vs > 200 V)
- 2 When the temperature (T) range is 20±5°C.
 Multiply both the first term and the second term (the value in parenthesis) by the following error factors when the measurement time mode is set to SHORT or MEDIUM, or multiply only the first term by one of the following error factors when the measurement time mode is set to LONG,
 8 ≤ T < 18 °C, or 28 < T ≤ 38 °C : ×2
 0 ≤ T < 8 °C, or 38 < T ≤ 45 °C : ×4
 Multiply the second term (the value in parenthesis) by the following error factors when the measurement time mode is set to LONG,
 8 ≤ T < 18 °C, or 28 < T ≤ 38 °C : ×5
 0 ≤ T < 8 °C, or 38 < T ≤ 45 °C : ×25
- 3 When measuring a grounded DUT, multiply the second term (the value in parenthesis) by one of the following error factors according to the measurement time mode:
 SHORT : ×2
 MEDIUM : ×1.5
 LONG : ×1.25
- 4 Im: Measured current value [A]
- 5 When the test cable length is 1.5 to 2 m.
- 6 After 1 second from range changing.
- 7 When the contact check function is ON, multiply the second term (the value in parenthesis) by 1.5.
- 8 When the Offset-Error Canceling is OFF.

Table 8-1. Measurement Accuracy (continued)

Range	Measurement Time Mode	Resistance Measurement ^{1,2,3} ±(% of Readings)	Current Measurement ^{2,3,4} ±(% of Readings)
10 nA	Short	$2.6 + \left(\frac{100V_o + 20 \times 10^{-10} R_m}{V_s}\right)$	$0.67 + \left(\frac{20 \times 10^{-10}}{I_m}\right)$
	Medium	$2.6 + \left(\frac{100V_o + 7 \times 10^{-10} R_m}{V_s}\right)$	$0.6 + \left(\frac{7 \times 10^{-10}}{I_m}\right)$
	Long	$2.6 + \left(\frac{100V_o + 2.5 \times 10^{-10} R_m}{V_s}\right)^7$	$0.6 + \left(\frac{2.5 \times 10^{-10}}{I_m}\right)^7$
100 nA	Short	$0.8 + \left(\frac{100V_o + 13 \times 10^{-9} R_m}{V_s}\right)$	$0.62 + \left(\frac{13 \times 10^{-9}}{I_m}\right)$
	Medium	$0.8 + \left(\frac{100V_o + 6.5 \times 10^{-9} R_m}{V_s}\right)$	$0.5 + \left(\frac{6.5 \times 10^{-9}}{I_m}\right)$
	Long	$0.8 + \left(\frac{100V_o + 2.5 \times 10^{-9} R_m}{V_s}\right)^7$	$0.5 + \left(\frac{2.5 \times 10^{-9}}{I_m}\right)^7$
1 μ A	Short	$0.77 + \left(\frac{100V_o + 13 \times 10^{-8} R_m}{V_s}\right)$	$0.61 + \left(\frac{13 \times 10^{-8}}{I_m}\right)$
	Medium	$0.65 + \left(\frac{100V_o + 6.5 \times 10^{-8} R_m}{V_s}\right)$	$0.49 + \left(\frac{6.5 \times 10^{-8}}{I_m}\right)$
	Long	$0.6 + \left(\frac{100V_o + 2.5 \times 10^{-8} R_m}{V_s}\right)^7$	$0.4 + \left(\frac{2.5 \times 10^{-8}}{I_m}\right)^7$
10 μ A	Short	$0.7 + \left(\frac{100V_o + 13 \times 10^{-7} R_m}{V_s}\right)$	$0.54 + \left(\frac{13 \times 10^{-7}}{I_m}\right)$
	Medium	$0.58 + \left(\frac{100V_o + 6.5 \times 10^{-7} R_m}{V_s}\right)$	$0.42 + \left(\frac{6.5 \times 10^{-7}}{I_m}\right)$
	Long	$0.5 + \left(\frac{100V_o + 2.5 \times 10^{-7} R_m}{V_s}\right)^7$	$0.33 + \left(\frac{2.5 \times 10^{-7}}{I_m}\right)^7$
100 μ A	Short	$0.68 + \left(\frac{100V_o + 7.5 \times 10^{-6} R_m}{V_s}\right)$	$0.52 + \left(\frac{7.5 \times 10^{-6}}{I_m}\right)$
	Medium	—	—
	Long	—	—

Measurement Support Functions

Display

40-digit × 2-lines LCD display. Capable of displaying: measurement values, comparator/contact check decisions, comparator limits, control settings, self test messages, and annunciators

Correction

■ OPEN correction

Eliminates measurement errors due to stray capacitance in the test cable and residual resistance in the test fixture.

■ Self calibration:

Calibrates the instrument offset errors due to the change of ambient temperature.

Test Sequence Program:

Controls a series of measurements (charge-measure-discharge). Charge time, measurement interval time, and the number of measurements can be programmed.

Mathematical Functions

The deviation and the percent deviation of measurement values from a programmable reference value can be displayed.

Comparator

HIGH/IN/LOW for the measurement parameter.

Contact Check

Contact failure between the test fixture and device can be detected.

Available DUT type: Capacitive DUT only

GPIB Interface

All control settings, measurement values, self-test results, and comparator information can be controlled or monitored via GPIB.

Handler Interface

All output signals are negative logic, opto-isolated, open collector outputs.

■ Output Signals Include:

HIGH/IN/LOW and no contact, index, end-of-measurement, and alarm.

■ Input Signals Include:

High voltage OFF, keylock, and External trigger

Save/Recall

Ten instrument setups can be saved and recalled from the internal non-volatile memory.

Continuous Memory Capability

If the instrument is turned OFF, or if a power failure occurs, the instrument settings are automatically saved.

Key Lock

Disables key input from the front panel.

General**Power Requirements**

100/120/220/240 V $\pm 10\%$, 47 to 66 Hz
45 VA max

Operating Temperature, Humidity, and Altitude

0 to 45 °C, $\leq 95\%$ RH @ 40 °C, 0 to 2000 meters

Condensation must be avoided.

Storage Temperature, Humidity, and Altitude

-40 °C to 70 °C, $\leq 95\%$ RH @ 40 °C, 0 to 4572 meters

Condensation must be avoided.

EMC

Complies with CISPR 11 (1990) / EN 55011 (1991) : Group 1, Class A.

Complies with EN 61000-3-3 (1995) / IEC 1000-3-3 (1994)

Complies with EN 50082-1 (1992) / IEC 801-2 (1991) : 4 kV CD, 8 kV AD.

Complies with EN 50082-1 (1992) / IEC 801-3 (1984) : 3 V/m.

Complies with EN 50082-1 (1992) / IEC 801-4 (1988) : 0.5 kV Signal Lines, 1 kV Power Lines.

This ISM device complies with Canadian ICES-001.

Cet appareil ISM est conforme à la norme NMB-001 du Canada.

Safety

Complies with EN 61010-1 (1993) + A2 / IEC 61010-1 (1990) + A1,A2-Pollution Degree 1

Dimensions

approximately 320 (W) by 100 (H) by 450 (D) mm

Weight

approximately 6.5 kg

Supplemental Performance Characteristics

The supplemental performance characteristics are listed below. These characteristics are not specifications but are typical characteristics included as additional information for the operator.

Typical Measurement Accuracy

Range	Resistance Measurement (± % of Readings) ¹	Current Measurement (± % of Readings) ²
100 pA	$0.86 + \left(\frac{100V_o + 6 \times 10^{-12} R_m}{V_s}\right)$	$0.7 + \left(\frac{6 \times 10^{-12}}{I_m}\right)$
1 nA	$0.74 + \left(\frac{100V_o + 3 \times 10^{-11} R_m}{V_s}\right)$	$0.58 + \left(\frac{3 \times 10^{-11}}{I_m}\right)$
10 nA	$0.56 + \left(\frac{100V_o + 2.5 \times 10^{-10} R_m}{V_s}\right)$	$0.4 + \left(\frac{2.5 \times 10^{-10}}{I_m}\right)$
100 nA	$0.53 + \left(\frac{100V_o + 2.5 \times 10^{-9} R_m}{V_s}\right)$	$0.37 + \left(\frac{2.5 \times 10^{-9}}{I_m}\right)$
1 μA	$0.53 + \left(\frac{100V_o + 2.5 \times 10^{-8} R_m}{V_s}\right)$	$0.37 + \left(\frac{2.5 \times 10^{-8}}{I_m}\right)$

1 R_m: Measured resistance value [Ω]

V_s: Voltage setting [V]

V_o: 0.1 [V] (V_s ≤ 200 V) or 0.5 [V] (V_s > 200 V)

2 I_m: Measured current value [A]

Measurement Time

The following table lists some typical measurement times.

Measurement Time Mode	Analog Measurement ¹ [ms]	Digital Computation [ms]	Total ^{1,2} [ms]
Short	8.5 (10.5)	1.5	10 (12)
Medium	28.5 (30.5)	1.5	30 (32)
Long	385 (387)	5	390 (392)

1 Numbers in parenthesis indicate the measurement times when a contact check is performed.

2 Time interval from a trigger command to EOM (end of measurement) signal output at the handler interface port.
(ranging: hold, display mode: off)

DC Test Voltage Settling

Slew rate until the output voltage reaches 90 % of the set voltage (Set V) is,

$$V'/t' = 10 \text{ V/ms}$$

Where V' and t' is shown in the following figure.

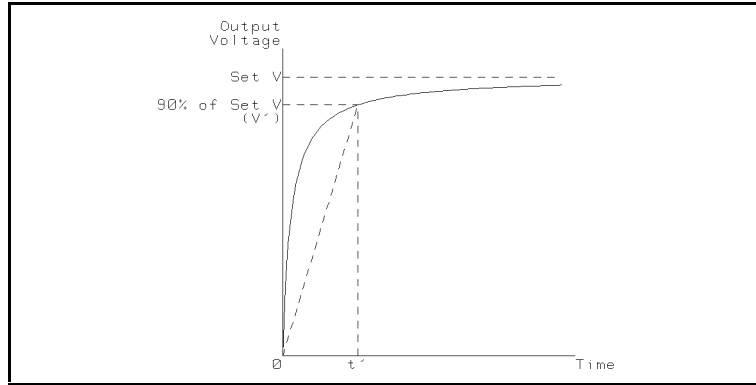
**DC Test Voltage Output Resistance**

1 k Ω \pm 10%

Continuous Memory Duration

72 hours (@ 23 \pm 5 °C)

Maintenance

Introduction

This chapter provides information on how to maintain the 4339B. 4339B maintenance consists of performance tests and functional tests.

Test Equipment

Table 9-1 lists the recommended equipment for performing 4339B maintenance.

Table 9-1. Required Equipment

Equipment	Requirements	Recommended Model	Qty.	Use ¹
DC Voltmeter	Voltage Range: 0 V to 1000 V Accuracy: < 0.04%	3458A	1	P
RC Box	No substitute	16340A	1	P, F
RC Box Adapter	No substitute	PN 04339-65005	1	P, F
V Measurement Adapter	No Substitute	PN 04339-65006	1	P
Cable	Banana-Banana Jumper	11058A	1	P
Cable	Dual Banana-BNC(m) Cable	PN 11001-60001	1	P
Handler Interface Tester	No Substitute	PN 04339-65007	1	F

¹ P: Performance Tests, F: Functional Tests

Performance Tests

Introduction

This section provides the test procedures used to verify that the 4339B's specifications listed in Chapter 8, General Information, of this manual are met. All tests can be performed without access to the interior of the instrument. The performance tests can also be used to perform incoming inspection, and to verify that the 4339B meets its performance specifications after troubleshooting or adjustment. If the performance tests indicate that the 4339B is NOT operating within the specified limits, check your test setup, then proceed with troubleshooting if necessary.

Note

Allow the 4339B to warm up for at least 30 minutes before you execute any of the performance tests.

Note

Perform all performance tests in ambient conditions of $23^{\circ}\text{C} \pm 5^{\circ}\text{C}$, $\leq 70\%$ RH.

Test Equipment

Table 9-1 lists the test equipment required to perform the tests described in this section. Use only calibrated test instruments when performance testing the 4339B. Equipment which equals or surpasses the key required specifications of the recommended equipment may be used as a substitute.

Calculation Sheet

The calculation sheet is used as an aid for recording raw measurement data, and for calculating the performance test results.

The performance test procedure gives the test sequence for performing a test. The complete set of measurement data is recorded on the calculation sheet. The results are calculated using the equations given on the calculation sheet, and the results are transcribed to the performance test record.

The procedure for using the calculation sheet is:

1. Photocopy the calculation sheet.
2. Follow the performance test procedure and record the measurement value(s), the 4339B's reading, etc., into the specified column on the calculation sheet.
3. Calculate the test result using the appropriate equation given on the calculation sheet, and record the test result into the Test Result column of the performance test record.

Performance Test Record

Record the performance test results in the test record at the end of this chapter (Photocopy the test record and use the photocopy). The test record lists all test specifications, their acceptable limits, and measurement uncertainties for the recommended test equipment. Test results recorded during incoming inspection can be used for comparison purposes during periodic maintenance, troubleshooting, and after repair or adjustment.

Calibration Cycle

The 4339B requires periodic performance tests. The frequency of performance testing depends on the operating and environmental conditions under which the 4339B is used. Verify the 4339B's performance at least once a year, using the performance tests described in this section.

Source Voltage Accuracy Test

The 4339B's source voltage is measured with a DC voltmeter.

Specification

Source Voltage (Vs) Accuracy: $\pm (0.16 \% + 100 \text{ mV}) (Vs \leq 200 \text{ V})$
 $\pm (0.16 \% + 500 \text{ mV}) (Vs > 200 \text{ V})$





Test Equipment

Description	Recommended Model
Multimeter	3458A
V Measurement Adapter	PN 04339-65006
Banana-Banana Jumper	11508A

Procedure

Warning  When the High Voltage indicator is lit, the 4339B outputs high voltages of up to 1000 Vdc maximum.



1. Reset the 4339B using the following procedure:
 - a. Press   to display the system reset menu.
 - b. Select Yes using  or  and press .
2. Set up the equipment as shown in Figure 9-1.

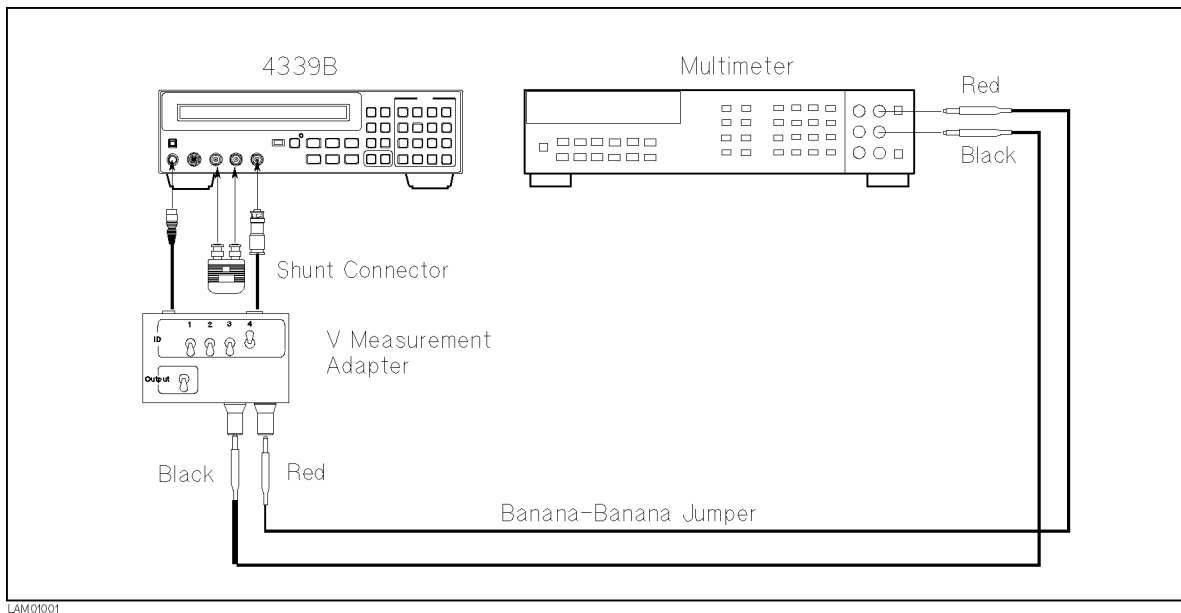

Figure 9-1. Source Voltage Accuracy Test Setup

3. Press the 3458A Multimeter's **DCV** to set the measurement mode to DC voltage.
4. Set the V Measurement Adapter's ID switches and Output switch as follows:

Switch	Setting
ID1	0
ID2	0
ID3	0
ID4	1
Output	Enable





5. On the 4339B, press  to turn the source voltage ON. (V Output indicator turns ON.)
6. Record the multimeter reading on the calculation sheet. (Initial output voltage setting is 0 V.)
7. Press  to turn the source voltage OFF. (V Output indicator turns OFF.)
8. Calculate the test result according to the calculation sheet, and record the result into the performance test record.
9. Perform this test for all the voltage settings listed in Table 9-2. The source voltage must be turned OFF after each test. The source voltage can be changed using the following procedure:
 - a. Press  to display the source voltage setup menu.
 - b. Use the numeric keys to enter a desired voltage, and press  .
 - c. The desired voltage will be displayed.

Table 9-2. Source Voltage Accuracy Test Settings

Source Voltage Setting
0 V
10 V
25 V
50 V
100 V
200 V
201 V
250 V
500 V
1000 V

Ammeter Offset Voltage and Input Resistance Test

The 4339B's ammeter offset voltage and input resistance are measured.

Specification

Ammeter Offset Voltage: $\leq 0.5 \text{ mV}$





Ammeter Input Resistance: $1 \text{ k}\Omega \pm 5\%$

Test Equipment

Description	Recommended Model
Multimeter	3458A
RC Box Adapter	PN 04339-65005
Dual Banana-BNC(m) Cable	PN 11001-60001

Procedure

Ammeter Offset Voltage Test.

1. Reset the 4339B using the following procedure:
 - a. Press   to display the system reset menu.
 - b. Select Yes using  or  and press .
2. Set up the equipment as shown in Figure 9-2.

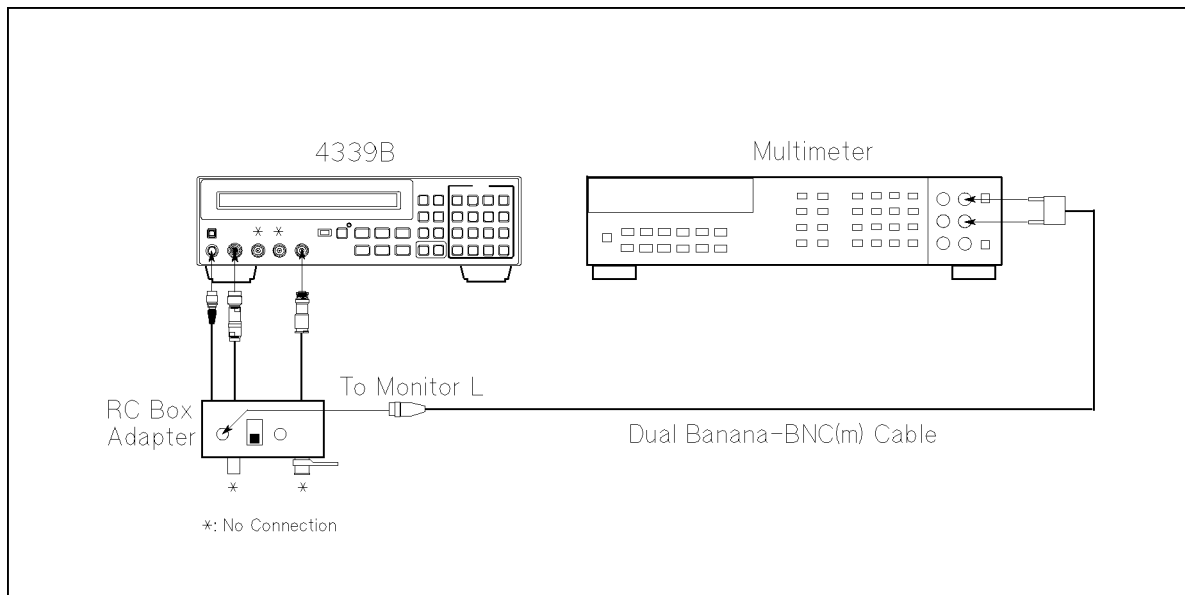









Figure 9-2. Ammeter Offset Voltage Test Setup

3. Set the RC Box Adapter switch to the *F* position.
4. Press the 3458A Multimeter's  to set the measurement mode to DC voltage.

5. Press the 4339B's  to set the measurement time to SHORT. The current measurement time setting is indicated by the **Meas Time** annunciator(▼).
6. Set the measurement range to 100 μA using the following procedure:
 - a. Press   to display the measurement range setup menu.
 - b. Press  until 100 μA appears, and press .
7. Press  to set the trigger mode to Manual. The current trigger mode setting is indicated by the **Trigger** annunciator(▼).
8. Record the multimeter reading into the performance test record. Do not change the equipment setup for the following ammeter input resistance test.

Ammeter Input Resistance Test.

9. Record the 16340A RC Box's $10^4 \Omega$ calibration value and the ammeter offset voltage test result on the calculation sheet.
10. Connect the RC Box to the RC Box adapter as shown in Figure 9-3.

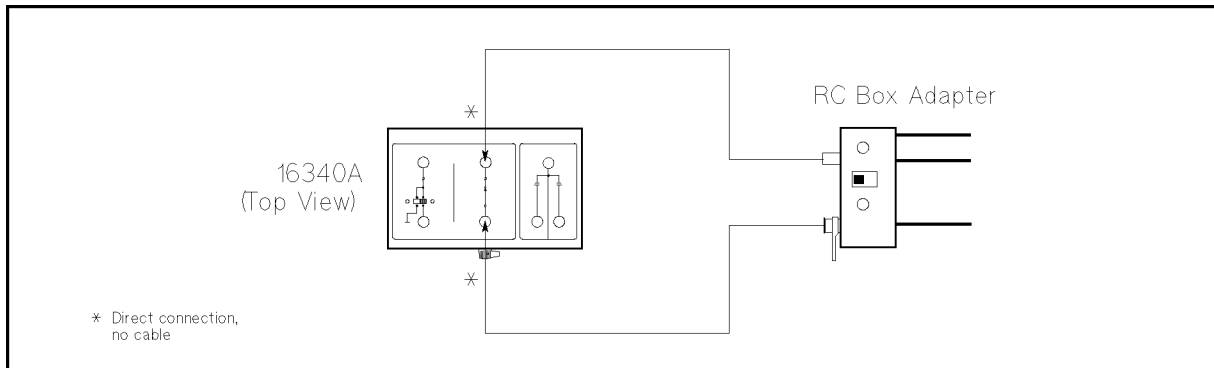





Figure 9-3. RC Box Connection

11. Set the RC Box resistor to $10^4 \Omega$.
12. Set the source voltage to 1 V using the following procedure:
 - a. Press  to display the source voltage setup menu.
 - b. Press   to set the source voltage to 1 V.
 - c. Confirm that + 1 V is displayed on the right side of the LCD.
13. Press  to turn the source voltage ON. (V Output indicator turns ON.)
14. Record the multimeter reading on the calculation sheet on the L Voltage line.
15. Disconnect the Dual Banana-BNC(m) cable from the Monitor L terminal and connect it to the Monitor H terminal.
16. Record the multimeter reading on the calculation sheet on the H Voltage line.
17. Calculate the test result according to the calculation sheet, and record the result into the performance test record.

Current Measurement Accuracy Test

The 4339B measures the current through the calibrated RC Box, and the measured values are compared with the current values calculated from the RC box's calibration value and the voltage across the standard.















Specification

Basic Measurement Accuracy: $\pm 0.4\%$ (See Chapter 8 General Information for details.)

Test Equipment

Description	Recommended Model
Multimeter	3458A
RC Box	16340A
RC Box Adapter	PN 04339-65005
Dual Banana-BNC(m) Cable	PN 11001-60001

Procedure

1. Record the 16340A RC Box calibration values on the calculation sheet.
2. Reset the 4339B using the following procedure:
 - a. Press   to display the system reset menu.
 - b. Select Yes using  or  and press .
3. Set the Offset-error Canceling to ON using the following procedure:
 - a. Press   to display the configuration setting menu.
 - b. Select Offset using  or  and press .
 - c. Select On using  or  and press .
 - d. Select Exit and press  to exit the configuration setting menu.
4. Set up the equipment as shown in Figure 9-4.

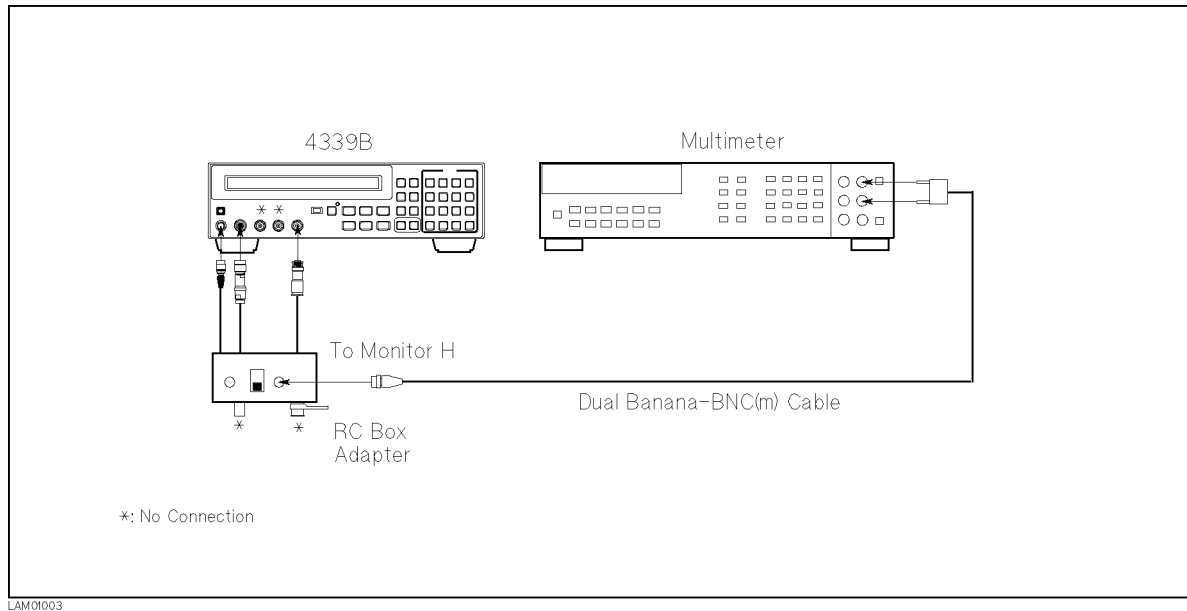

Figure 9-4. Current Measurement Accuracy Test Setup

5. Set the RC Box Adapter switch to the *F* position.
6. Press the 3458A Multimeter's **DCV** to set the measurement mode to DC voltage.
7. Press **Cal** **5** . Select **ExecCal** and press **Enter** to perform the calibration.
8. Set the source voltage to 10 V using the following procedure:
 - a. Press **Source Voltage** to display the source voltage setup menu.
 - b. Press **Comprtr** **1** **0** **Enter** to set the source voltage to 10 V.
 - c. Confirm that +10 V is displayed on the right side of the LCD.
9. Press **V Output** to turn the source voltage ON. (V Output indicator turns ON.)
10. Press **Open** **4** . Select **OpenMeas** and press **Enter** to perform the OPEN correction.
11. Press **V Output** to turn the source voltage OFF. (V Output indicator turns OFF.)
12. Connect the RC Box to the RC Box Adapter as shown in Figure 9-5.

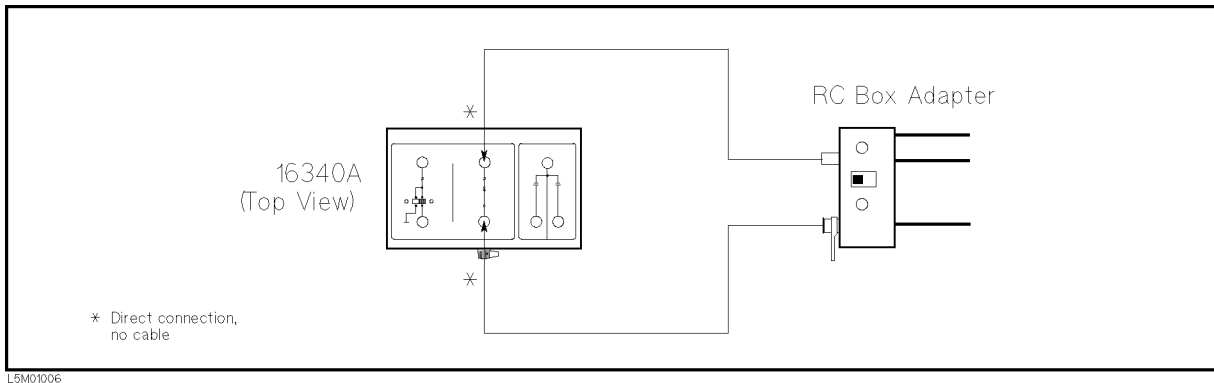

Figure 9-5. RC Box Connection

13. Press . Select I and press to set the measurement parameter to current (I).
14. Press to set the measurement time to LONG. The current measurement time setting is indicated by the **Meas Time** annunciator(▼).
15. Press to set the trigger mode to Manual. The current trigger mode setting is indicated by the **Trigger** annunciator(▼).
16. Set the RC Box resistor to $10^{10} \Omega$.
17. Set the source voltage to 1 V using the following procedure:
 - a. Press to display the source voltage setup menu.
 - b. Press to set the source voltage to 1 V.
 - c. Confirm that + 1 V is displayed on the right side of the LCD.
18. Press to turn the source voltage ON. (V Output indicator turns ON.)
19. Press to measure.
20. Record the multimeter reading on the calculation sheet on the Multimeter Reading line.
21. Record the 4339B reading on the calculation sheet on the 4339B Reading line.
22. Press to turn the source voltage OFF. (V Output indicator turns OFF.)
23. Calculate the test result according to the calculation sheet, and record the result into the performance test record.
24. Perform this test for all settings listed in Table 9-3. The source voltage must be turned OFF after each test.

Table 9-3. Current Measurement Accuracy Test Settings

Test Current	Resistor Setting	Voltage Setting	Measurement Time
100 pA	$10^{10} \Omega$	1 V	LONG
1 nA	$10^9 \Omega$	1 V	LONG
10 nA	$10^8 \Omega$	1 V	LONG
100 nA	$10^7 \Omega$	1 V	LONG
1 μ A	$10^6 \Omega$	1 V	LONG
10 μ A	$10^5 \Omega$	1 V	LONG
100 μ A	$10^5 \Omega$	10 V	SHORT

Resistance Measurement Accuracy Test

The 4339B measures the resistance values of the calibrated RC Box, and these measurements are compared with the RC Box's calibration values.

Specification

Basic Measurement Accuracy: $\pm 0.6\%$ (See Chapter 8 General Information for details.)

Test Equipment















	Description	Recommended Model
	RC Box	16340A
	RC Box Adapter	PN 04339-65005

Procedure

Warning  When the High Voltage indicator is lit, the 4339B outputs high voltages of up to 1000 Vdc maximum.



Resistance Measurement Accuracy Test (Floating Device).

1. Record the 16340A RC Box calibration values into the Calculation Sheet.
2. Reset the 4339B using the following procedure:
 - a. Press   to display the system reset menu.
 - b. Select Yes using  or  and press .
3. Set the Offset-error Canceling to ON using the following procedure:
 - a. Press   to display the configuration setting menu.
 - b. Select Offset using  or  and press .
 - c. Select On using  or  and press .
 - d. Select Exit and press  to exit the configuration setting menu.
4. Set up the equipment as shown in Figure 9-6.

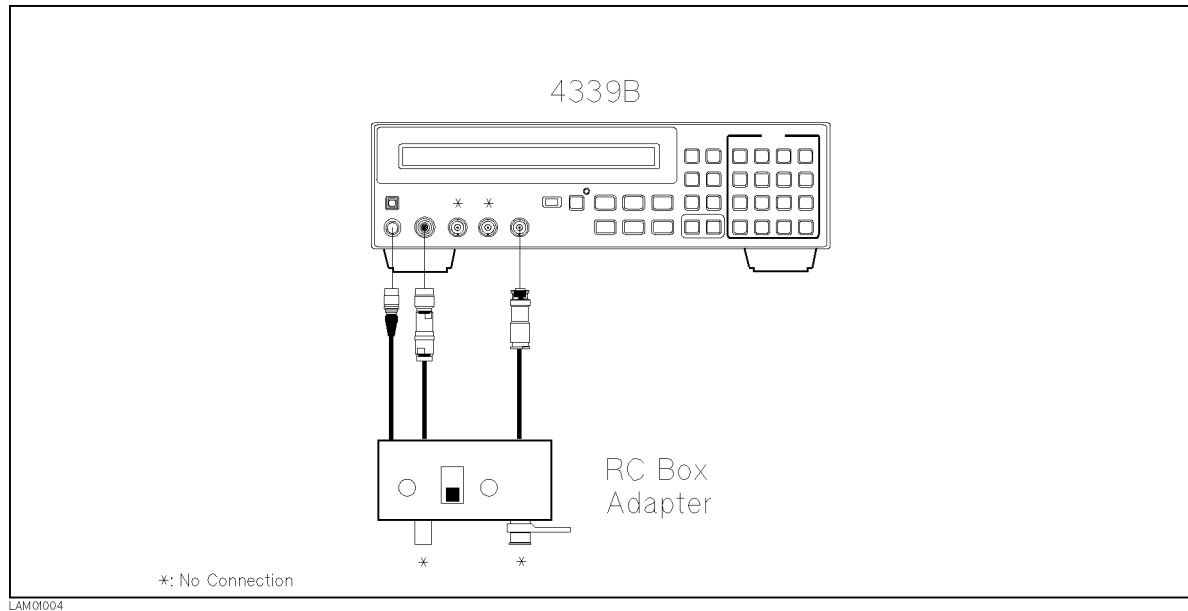















Figure 9-6. Resistance Measurement Accuracy Test Setup (Floating)

5. Set the RC Box Adapter switch to the *F* position.
6. Press  . Select ExecCal and press  to perform the calibration.
7. Set the source voltage to 100 V using the following procedure:
 - a. Press  to display the source voltage setup menu.
 - b. Press     to set the source voltage to 100 V.
 - c. Confirm that + 100 V is displayed on the right side of the LCD.
8. Press  to turn the source voltage ON. (V Output indicator turns ON.)
9. Press  . Select OpenMeas and press  to perform the OPEN correction.
10. Press  to turn the source voltage OFF. (V Output indicator turns OFF.)
11. Connect the RC Box to the RC Box Adapter as shown in Figure 9-7

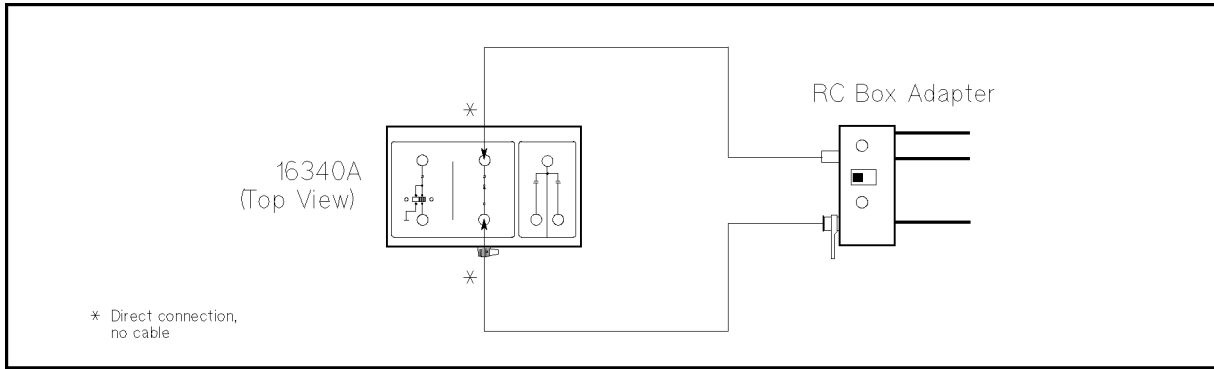







Figure 9-7. RC Box Connection (Floating)

12. Press  to set the measurement time to SHORT. The current measurement time setting is indicated by the **Meas Time** annunciator(▼).
13. Press  to set the trigger mode to Manual. The current trigger mode setting is indicated by the **Trigger** annunciator(▼).
14. Set the RC Box resistor to $10^6 \Omega$.
15. Press  to turn the source voltage ON. (V Output indicator lights.)
16. Press  to measure.
17. Record the 4339B reading on the calculation sheet.
18. Press  to turn the source voltage OFF. (V Output indicator turns OFF.)
19. Calculate the test result according to the calculation sheet, and record the result into the performance test record.
20. Perform the test for all settings listed in Table 9-4. The source voltage must be turned OFF after each test. In the test for the $10^{11} \Omega$ resistor, connect the RC Box Adapter to the 10^{11} terminals and set the 10^{11} switch to the BNC connector position as shown in Figure 9-8.

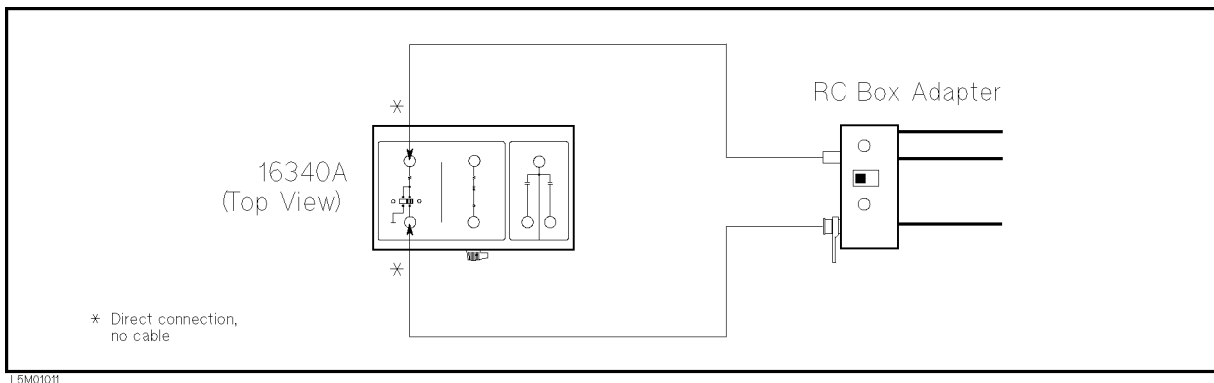

Figure 9-8. RC Box Connection for $10^{11} \Omega$ Resistor





Table 9-4. Resistance Measurement Accuracy Test Settings



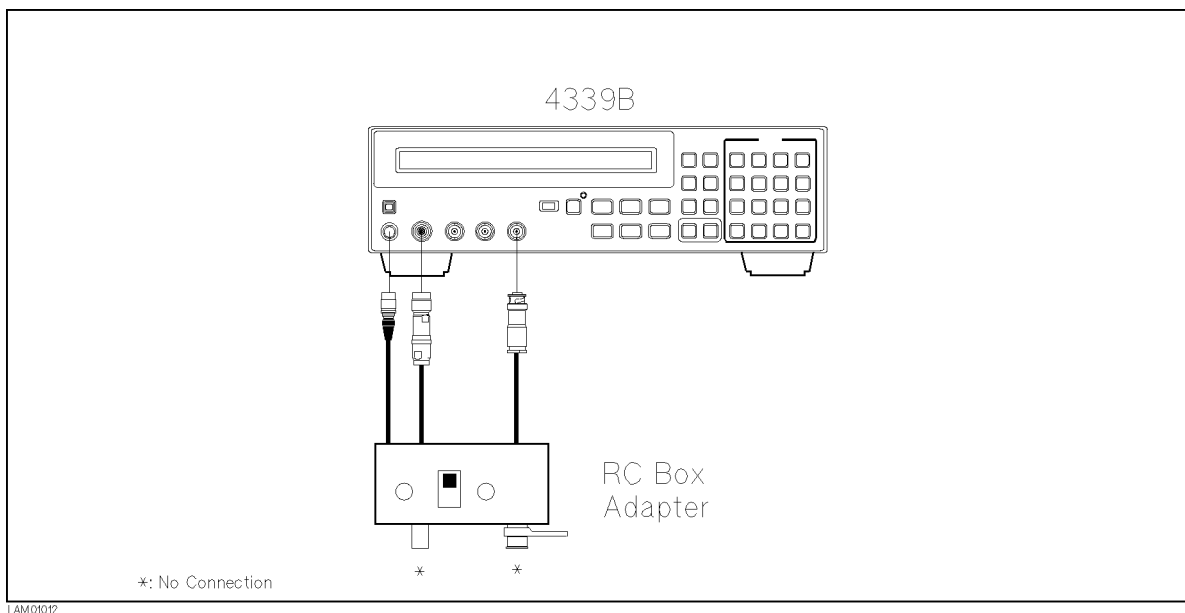

Resistor Setting	Voltage Setting	Measurement Time
$10^6 \Omega$	100 V	Short
$10^7 \Omega$	100 V	Long
$10^8 \Omega$	100 V	Long
$10^9 \Omega$	100 V	Long
$10^{10} \Omega$	100 V	Long
$10^{11} \Omega$	100 V	Long
$10^{11} \Omega$	100 V	Short
$10^{11} \Omega$	10 V	Long

Resistance Measurement Accuracy Test (Grounded Device).

21. Set up the equipment as shown in Figure 9-9.

**Figure 9-9. Resistance Measurement Accuracy Test Setup (Grounded)**

22. Set the RC Box Adapter switch to the *G* position.
23. Set the source voltage to 100 V using the following procedure:
- Press  to display the source voltage setting.
 - Press     to set the source voltage to 100 V.
 - Confirm that + 100 V is displayed on the right side of the LCD.

24. Press  to turn the source voltage ON. (V Output indicator turns ON.)
25. Press  . Select OpenMeas and press  to perform the OPEN correction.
26. Press  to turn the source voltage OFF. (V Output indicator turns OFF.)
27. Connect the RC Box to the RC Box Adapter as shown in Figure 9-10.

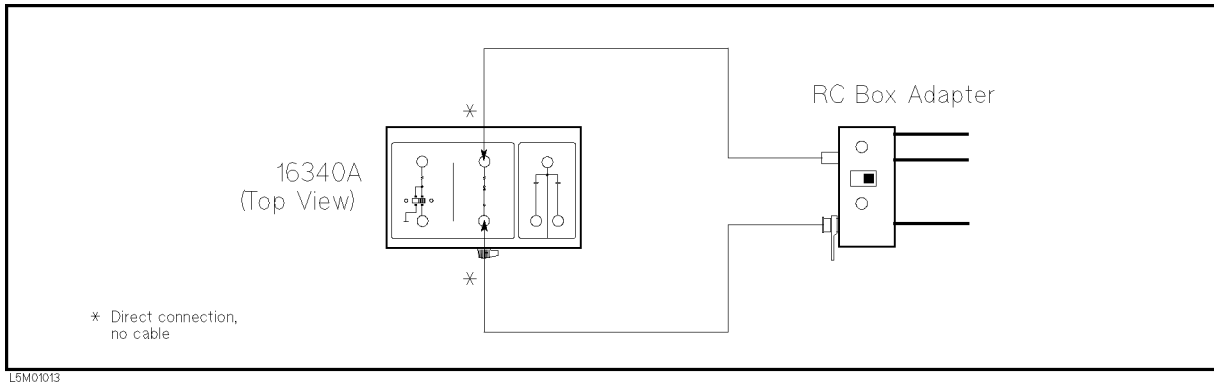





Figure 9-10. RC Box Connection (Grounded)

28. Set the RC Box resistor to $10^7 \Omega$.
29. Press  to turn the source voltage ON. (V Output indicator turns ON.)
30. Press  to measure.
31. Record the 4339B reading on the calculation sheet.
32. Press  to turn the source voltage OFF. (V Output indicator turns OFF.)
33. Calculate the test result according to the calculation sheet, and record the result into the performance test record.
34. Perform this test for all settings listed in Table 9-5. The source voltage must be turned OFF after each test.

**Table 9-5.
Resistance Measurement Accuracy Test Settings (Grounded)**

Resistor Setting	Voltage Setting
$10^7 \Omega$	100 V
$10^{11} \Omega$	10 V

Calculation Sheet

Source Voltage Accuracy Test

Source Voltage Setting	Multimeter Reading [a]	Test Result Equation
0 V	_____ V	a
10 V	_____ V	$a - 10.000 \text{ V}$
25 V	_____ V	$a - 25.000 \text{ V}$
50 V	_____ V	$a - 50.000 \text{ V}$
100 V	_____ V	$a - 100.00 \text{ V}$
200 V	_____ V	$a - 200.00 \text{ V}$
201 V	_____ V	$a - 201.00 \text{ V}$
250 V	_____ V	$a - 250.00 \text{ V}$
500 V	_____ V	$a - 500.00 \text{ V}$
1000 V	_____ V	$a - 1000.0 \text{ V}$

Ammeter Input Resistance Test

$10^4 \Omega$ Calibration Value [a]	Offset Voltage [b]	L Voltage [c]	H Voltage [d]	Test Result Equation
_____ $\times 10^4 \Omega$	_____ mV	_____ mV	_____ mV	$1 \text{ k}\Omega - a \times (c - b) \div (d - c)$

RC Box Calibration Values

This table is used in the Current Measurement Accuracy Test and the Resistance Measurement Accuracy Test.

Resistor Setting	Resistor Calibration Value	Reference Designation
$10^{11} \Omega$	_____ $\times 10^{11} \Omega$	cv1
$10^{10} \Omega$	_____ $\times 10^{10} \Omega$	cv2
$10^9 \Omega$	_____ $\times 10^9 \Omega$	cv3
$10^8 \Omega$	_____ $\times 10^8 \Omega$	cv4
$10^7 \Omega$	_____ $\times 10^7 \Omega$	cv5
$10^6 \Omega$	_____ $\times 10^6 \Omega$	cv6
$10^5 \Omega$	_____ $\times 10^5 \Omega$	cv7

Current Measurement Accuracy Test

Test Current	Resistor Setting	Voltage Setting	Multimeter Reading [a]	4339B Reading [b]	Test Result Equation ¹
100 pA	10 ¹⁰ Ω	1 V	_____ V	_____ pA	b – a ÷ cv2
1 nA	10 ⁹ Ω	1 V	_____ V	_____ nA	b – a ÷ cv3
10 nA	10 ⁸ Ω	1 V	_____ V	_____ nA	b – a ÷ cv4
100 nA	10 ⁷ Ω	1 V	_____ V	_____ nA	b – a ÷ cv5
1 μA	10 ⁶ Ω	1 V	_____ V	_____ μA	b – a ÷ (cv6+1 kΩ)
10 μA	10 ⁵ Ω	1 V	_____ V	_____ μA	b – a ÷ (cv7+1 kΩ)
100 μA	10 ⁵ Ω	10 V	_____ V	_____ μA	b – a ÷ (cv7+1 kΩ)

¹ 1 kΩ in the test result equation is the input resistance of the 4339B's ammeter.

Resistance Measurement Accuracy Test

Resistance Measurement Accuracy Test (Floating Device)

Resistor Setting	Voltage Setting	Measurement Time	4339B Reading [a]	Test Result Equation
10 ⁶ Ω	100 V	Short	_____ × 10 ⁶ Ω	a – cv6
10 ⁷ Ω	100 V	Long	_____ × 10 ⁷ Ω	a – cv5
10 ⁸ Ω	100 V	Long	_____ × 10 ⁸ Ω	a – cv4
10 ⁹ Ω	100 V	Long	_____ × 10 ⁹ Ω	a – cv3
10 ¹⁰ Ω	100 V	Long	_____ × 10 ¹⁰ Ω	a – cv2
10 ¹¹ Ω	100 V	Long	_____ × 10 ¹¹ Ω	a – cv1
10 ¹¹ Ω	100 V	Short	_____ × 10 ¹¹ Ω	a – cv1
10 ¹¹ Ω	10 V	Long	_____ × 10 ¹¹ Ω	a – cv1

Resistance Measurement Accuracy Test (Grounded Device)

Resistor Setting	Voltage Setting	4339B Reading [a]	Test Result Equation
10 ⁷ Ω	100 V	_____ × 10 ⁷ Ω	a – cv5
10 ¹¹ Ω	10 V	_____ × 10 ¹¹ Ω	a – cv1

Performance Test Record

Agilent Technologies 4339B High Resistance Meter

Serial No.: _____

Date: _____

Temperature: _____

Tested by: _____

Humidity: _____

Source Voltage Accuracy Test

Source Voltage Setting	Test Limits	Test Result ¹	Measurement Uncertainty
0 V	±0.10 V	_____ V	± 0.000002 V
10 V	±0.12 V	_____ V	± 0.00018 V
25 V	±0.14 V	_____ V	± 0.00073 V
50 V	±0.18 V	_____ V	± 0.00073 V
100 V	±0.26 V	_____ V	± 0.0022 V
200 V	±0.42 V	_____ V	± 0.0043 V
201 V	±0.82 V	_____ V	± 0.0043 V
250 V	±0.90 V	_____ V	± 0.0028 V
500 V	±1.3 V	_____ V	± 0.0086 V
1000 V	±2.1 V	_____ V	± 0.011 V

¹ Test Result = Measured Value – Setting Value

Ammeter Offset Voltage and Input Resistance Test

Ammeter Offset Voltage Test

Test Limits	Test Result	Measurement Uncertainty
±0.5 mV	_____ mV	±0.0015 mV

Ammeter Input Resistance Test

Test Limits	Test Result ¹	Measurement Uncertainty
± 50 Ω	_____ Ω	±0.52 Ω

¹ Test Result = Typical Value of 1 kΩ – Measured Value

Current Measurement Accuracy Test

Test Current	Test Limits	Measurement Time	Test Result ¹	Measurement Uncertainty
100 pA	±2.6 pA	Long	_____ pA	±0.56 pA
1 nA	±0.0094 nA	Long	_____ nA	±0.0016 nA
10 nA	±0.063 nA	Long	_____ nA	±0.011 nA
100 nA	±0.53 nA	Long	_____ nA	±0.10 nA
1 μA	±0.0043 μA	Long	_____ μA	±0.0005 μA
10 μA	±0.036 μA	Long	_____ μA	±0.007 μA
100 μA	±0.60 μA	Short	_____ μA	±0.07 μA

¹ Test Result = 4339B Reading – (Multimeter Reading ÷ Resistor Calibration Value)

Resistance Measurement Accuracy Test

Resistance Measurement Accuracy Test (Floating Device)

Resistor Setting	Voltage Setting	Measurement Time	Test Limits	Test Result ¹	Measurement Uncertainty
10 ⁶ Ω	100 V	Short	±0.0086 × 10 ⁶ Ω	_____ × 10 ⁶ Ω	±0.0010 × 10 ⁶ Ω
10 ⁷ Ω	100 V	Long	±0.0063 × 10 ⁷ Ω	_____ × 10 ⁷ Ω	±0.0010 × 10 ⁷ Ω
10 ⁸ Ω	100 V	Long	±0.0073 × 10 ⁸ Ω	_____ × 10 ⁸ Ω	±0.0011 × 10 ⁸ Ω
10 ⁹ Ω	100 V	Long	±0.0093 × 10 ⁹ Ω	_____ × 10 ⁹ Ω	±0.0016 × 10 ⁹ Ω
10 ¹⁰ Ω	100 V	Long	±0.0273 × 10 ¹⁰ Ω	_____ × 10 ¹⁰ Ω	±0.0056 × 10 ¹⁰ Ω
10 ¹¹ Ω	100 V	Long	±0.0453 × 10 ¹¹ Ω	_____ × 10 ¹¹ Ω	±0.010 × 10 ¹¹ Ω
10 ¹¹ Ω	100 V	Short	±0.0550 × 10 ¹¹ Ω	_____ × 10 ¹¹ Ω	±0.010 × 10 ¹¹ Ω
10 ¹¹ Ω	10 V	Long	±0.0546 × 10 ¹¹ Ω	_____ × 10 ¹¹ Ω	±0.010 × 10 ¹¹ Ω

¹ Test Result = 4339B Reading – Resistor Calibration Value

Resistance Measurement Accuracy Test (Grounded Device)

Resistor Setting	Voltage Setting	Test Limits	Test Result ¹	Measurement Uncertainty
10 ⁷ Ω	100 V	±0.0065 × 10 ⁷ Ω	_____ × 10 ⁷ Ω	±0.0010 × 10 ⁷ Ω
10 ¹¹ Ω	10 V	±0.0573 × 10 ¹¹ Ω	_____ × 10 ¹¹ Ω	±0.010 × 10 ¹¹ Ω

¹ Test Result = 4339B Reading – Resistor Calibration Value

Functional Test

Introduction

This section provides the test procedures used to verify that the 4339B performs its designed functions. The functional tests can be used for post-repair function verification.

Test Equipment

Table 9-1 lists the test equipment required to perform the tests described in this section. Equipment which equals or surpasses the key required specifications of the recommended equipment may be used.

Handler Interface Functional Test

The 4339B's handler interface function is tested using the built-in selftest and the handler interface tester.

Test Equipment

Description	Recommended Model
Handler Interface Tester	04339-65007

Procedure

Initial Setup.

1. Turn the 4339B OFF.
2. Set the LED_PW switch on the Handler Interface Tester to *OFF*, and set the IN1, IN2, IN3, and IN4 switches to 0.
3. Set up the equipment as shown in Figure 9-11

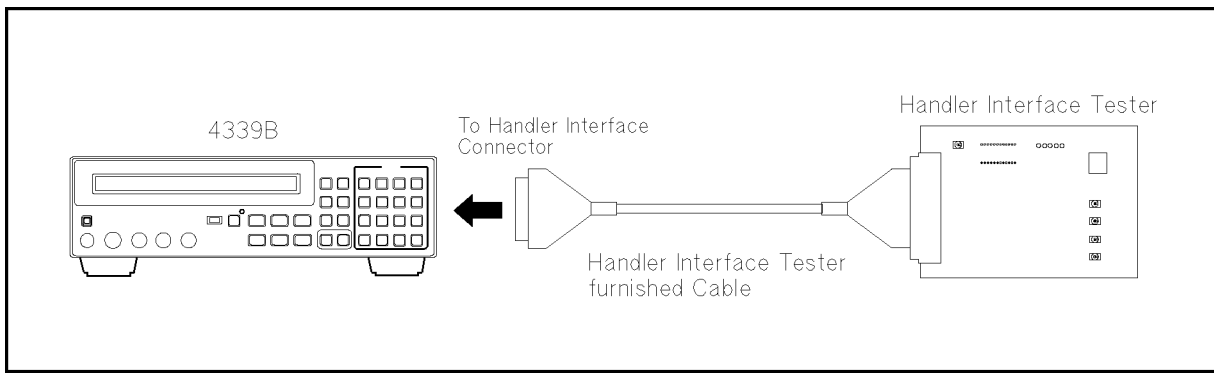









Figure 9-11. Handler Interface Functional Test Setup

4. Turn the 4339B ON.
5. Reset the 4339B using the following procedure.
 - a. Press   to display the system reset menu.
 - b. Select Yes using  or  and press .

Key Lock Function Test.

6. Set the IN4 switch on the Handler Interface Tester to 1.
7. Confirm that the all keys on the 4339B's front panel are locked out.
8. Set the IN4 switch on the Handler Interface Tester to 0.











External Trigger Function Test.

9. Press  to set the trigger mode to External.
10. Press  and select I to set the measurement mode to current (I).

11. Press the *IN5* switch on the Handler Interface Tester, and confirm that the 4339B is triggered.

Handler Interface Output Test.

12. Start the handler interface output test using the following procedure:

- a. Press   to display the configuration setting menu.
- b. Select more using  or  and press .
- c. Select Svc using  or  and press .
- d. Select HNDL using  or  and press .

13. Set the *LED_PW* switch on the Handler Interface Tester to *ON*.

Caution



Do not set the *LED_PW* switch to *ON*, except when doing the handler interface output test. The LEDs may cause the 4339B to shut-down during normal operation.

14. Confirm that the LEDs on the Handler Interface Tester light in the order shown in Figure 9-12, in accordance with the 4339B display.

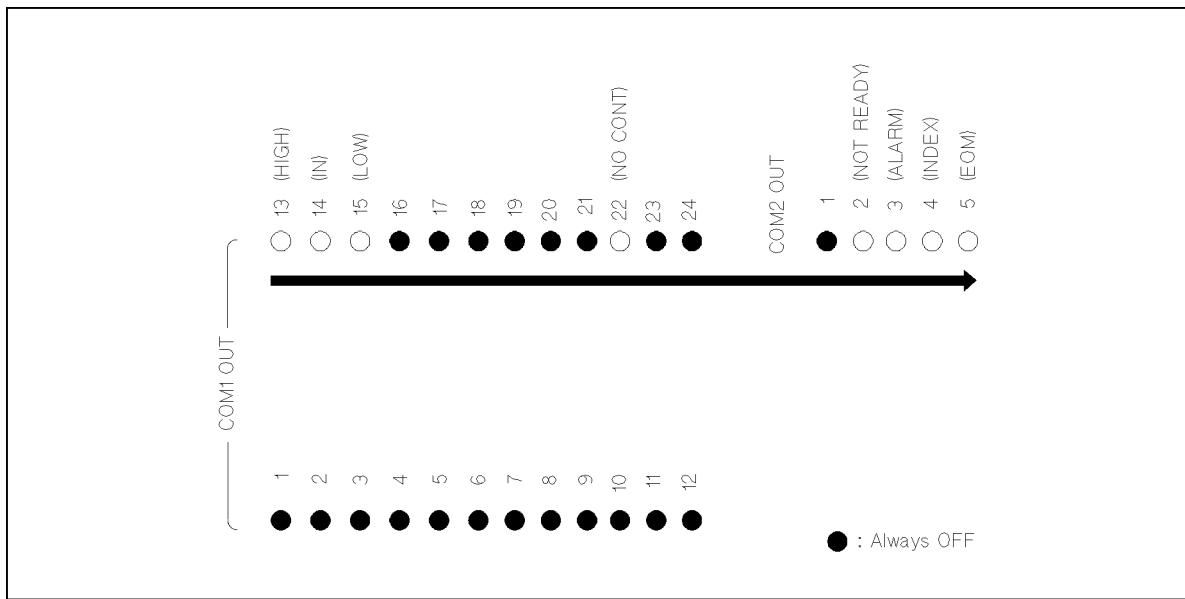



Figure 9-12. Handler Interface Output Order

15. Set the *LED_PW* switch on the Handler Interface Tester to OFF.

16. Press  twice to exit from the test mode.





Contact Check Functional Test

The 4339B's contact check function is confirmed.

Test Equipment

Description	Recommended Model
RC Box	16340A
RC Box Adapter	04339-65005

Procedure

1. Reset the 4339B using the following procedure:
 - a. Press   to display the system reset menu.
 - b. Select Yes using  or  and press .
2. Set up the equipment as shown in Figure 9-13.

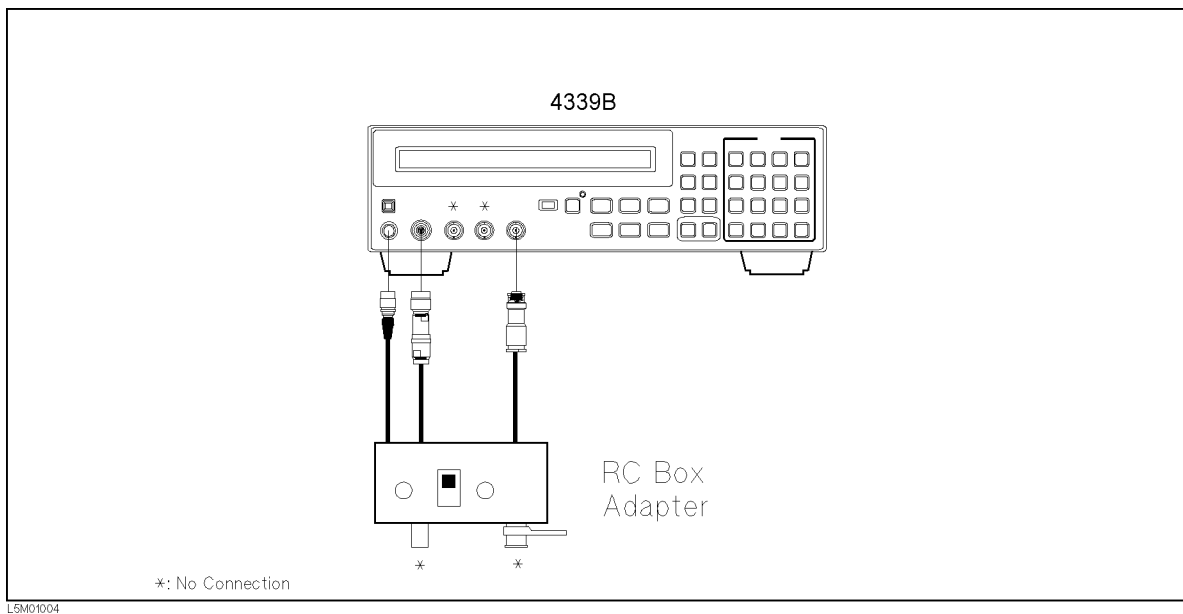











Figure 9-13. Contact Check Functional Test Setup

3. Set the RC Box Adapter switch to the *G* position.
4. Set the measurement range to 10 μ A using the following procedure:
 - a. Press   to display the measurement range setup menu.
 - b. Press  until 10 μ A appears, and press .
5. Press  . Select 0penMeas and press  to perform the OPEN correction.

6. Press   and select ON/OFF to turn the contact check function ON.
7. Confirm that the 4339B displays *N.C.* (No Contact).
8. Set the 16340A RC Box resistor to $10^4 \Omega$.
9. Connect the RC Box to the RC Box Adapter as shown in Figure 9-14.

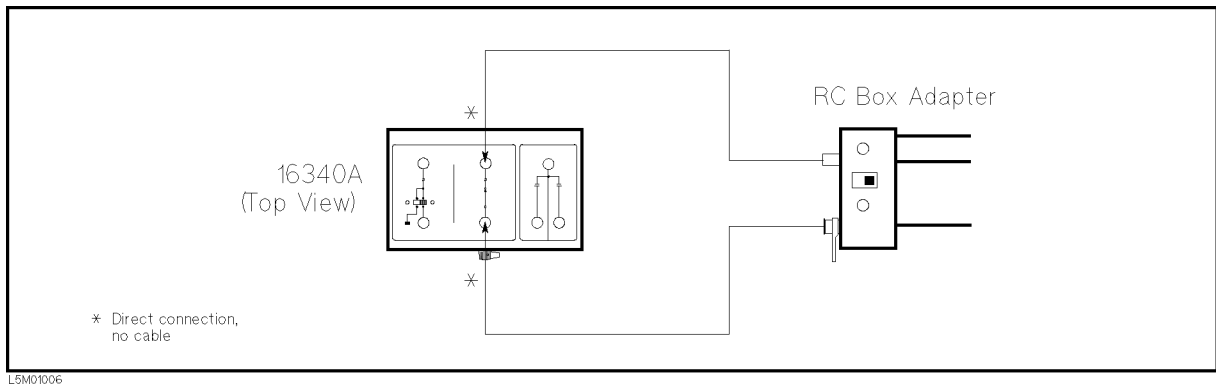

Figure 9-14. Contact Check Functional Test Setup

10. Confirm that the *N.C.* disappears and the 4339B displays the resistance measurement value.

Manual Changes

Introduction

This appendix contains the information required to adapt this manual to earlier versions or configurations of the 4339B than the current printing date of this manual. The information in this manual applies directly to the 4339B serial number prefix listed on the title page of this manual.

Manual Changes

To adapt this manual to your 4339B, see Table A-1 and Table A-2, and make all the manual changes listed opposite your instrument's serial number and firmware version.

Instruments manufactured after the printing of this manual may be different from those documented in this manual. Later instrument versions will be documented in a manual changes supplement that will accompany the manual shipped with that instrument. If your instrument's serial number or ROM version is not listed on the title page of this manual, in Table A-1, or Table A-2, make changes according to the *yellow MANUAL CHANGES* supplement.

In additions to information on changes, the supplement may contain information for correcting errors (Errata) in the manual. To keep this manual as current and accurate as possible, Agilent Technologies recommends that you periodically request the latest *MANUAL CHANGES* supplement.

For information concerning serial number prefixes not listed on the title page or in the *MANUAL CHANGE* supplement, contact the nearest Agilent Technologies office.

To confirm the ROM version, turn ON the power for the 4339B or execute *IDN? on the external controller.

Table A-1. Manual Changes by Serial Number

Serial Prefix or Number	Make Manual Changes

Table A-2. Manual Changes by ROM Version

Version	Make Manual Changes
1.00	Change 1, Change 2
1.01, 1.02, 1.03	Change 2

Serial Number







Agilent Technologies uses a two-part, ten-character serial number that is stamped on the serial number plate (see Figure A-1) attached to the rear panel. The first five characters are the serial prefix and the last five digits are the suffix.



Figure A-1. Serial Number Plate

Change 1

Delete the following function.

- Limit Value Reading function (  LimitC)
- Offset Setting function (  OfSEnt)
- Dut Capacitance Reading function (  MeasC)

Delete the following GPIB command.

- :SENSe:CONtAct:DATA?
- :SENSe:CONtAct:LIMit?
- :SENSe:CONtAct:OFFSet

Change 2

Change Table C-1 and Table C-2 to Table A-3 and Table A-4 respectively.

Table A-3. OVLD/Over-Current/N.C. Operations (Meas. parameter: R)

	Display		Handler Output	GPIB Output ¹	Solutions
	Data Mode	Comprtr Mode			
OVLD (Overload)	OVLD	LOW	/LO	<stat> ² : 1 <data>: 9.9E37 <comp> ³ : 4	Select an appropriate measurement range.
Over-Current	OV CURR	LOW	/LO & /NOT READY	<stat> ² : 4 <data>: 9.9E37 <comp> ³ : 4	Reduce the source voltage. Check whether a short circuit is occurred.
N.C. (No-Contact)	N.C.	N.C.	/NO CONTACT	<stat> ² : 2 <data>: 9.9E37 <comp> ³ : 8	Cancel the bad contact between DUT and contact-pin.
OVLD & N.C.	N.C.	N.C.	/LO	<stat> ² : 3 <data>: 9.9E37 <comp> ³ : 4	Select an appropriate measurement range. Cancel the bad contact between DUT and contact-pin.
OVLD & Over-Current	OV CURR	LOW	/LO & /NOT READY	<stat> ² : 5 <data>: 9.9E37 <comp> ³ : 4	Select an appropriate measurement range. Reduce the source voltage. Check whether a short circuit is occurred.

1 Refer to :FETCh? in Chapter 5

2 Measurement status (0:Normal, 1:Overload, 2:No-Contact, 4:Over-Current)

3 Comparison result (1:In, 2:High, 4:Low, 8:No-Contact)

Table A-4. OVLD/Over-Current/N.C. Operations(Meas. parameter: I)

	Display		Handler Output	GPIB Output ¹	Solutions
	Data Mode	Comprtr Mode			
OVLD (Overload)	OVLD	HIGH	/HI	<stat> ² : 1 <data>: 9.9E37 <comp> ³ : 2	Select an appropriate measurement range.
Over-Current	OV CURR	HIGH	/HI & /NOT READY	<stat> ² : 4 <data>: 9.9E37 <comp> ³ : 2	Reduce the source voltage. Check whether a short circuit is occurred.
N.C. (No-Contact)	N.C.	N.C.	/NO CONTACT	<stat> ² : 2 <data>: 9.9E37 <comp> ³ : 8	Cancel the bad contact between DUT and contact-pin.
OVLD & N.C.	N.C.	N.C.	/HI	<stat> ² : 3 <data>: 9.9E37 <comp> ³ : 2	Select an appropriate measurement range. Cancel the bad contact between DUT and contact-pin.
OVLD & Over-Current	OV CURR	HIGH	/HI & /NOT READY	<stat> ² : 5 <data>: 9.9E37 <comp> ³ : 2	Select an appropriate measurement range. Reduce the source voltage. Check whether a short circuit is occurred.

¹ Refer to :FETCh? in Chapter 5

² Measurement status (0:Normal, 1:Overload, 2:No-Contact, 4:Over-Current)

³ Comparison result (1:In, 2:High, 4:Low, 8:No-Contact)

Handler Interface Installation

This appendix provides the electrical characteristics of the handler interface signals, and how to set up the handler interface board.

Electrical Characteristics

Output Signals

Each DC output is isolated using open collector output opto-isolators. The output voltage of each line is enabled by putting pull-up resistors on the main board, and by connecting the pull-up resistors to an externally applied DC voltage.

The electrical circuits of the DC isolated outputs are divided into two groups to be able to separate power supplies (refer to Table B-1).

A simplified diagrams of the output signals is shown in Figure B-1 for comparison signals and Figure B-2 for control signals.

Table B-1. Handler Output Electrical Characteristics

Output Signals	Voltage Output Rating		Maximum Current	External Voltage/Circuit Common
	Low	High		
Comparison Signals /HI /IN /LO /NO CONTACT	≤ 0.5 V	5 to 24 V	6 mA	EXT DCV1 COM1
Control Signals /ALARM /INDEX /EOM /NOT READY	≤ 0.5 V	5 to 15 V	6 mA	EXT DCV2 COM2

Note



The pull-up resistors in Figure B-1 and Figure B-2 are *not* mounted when 4339B is shipped from the factory. Before using the handler interface, mount the pull-up resistors.

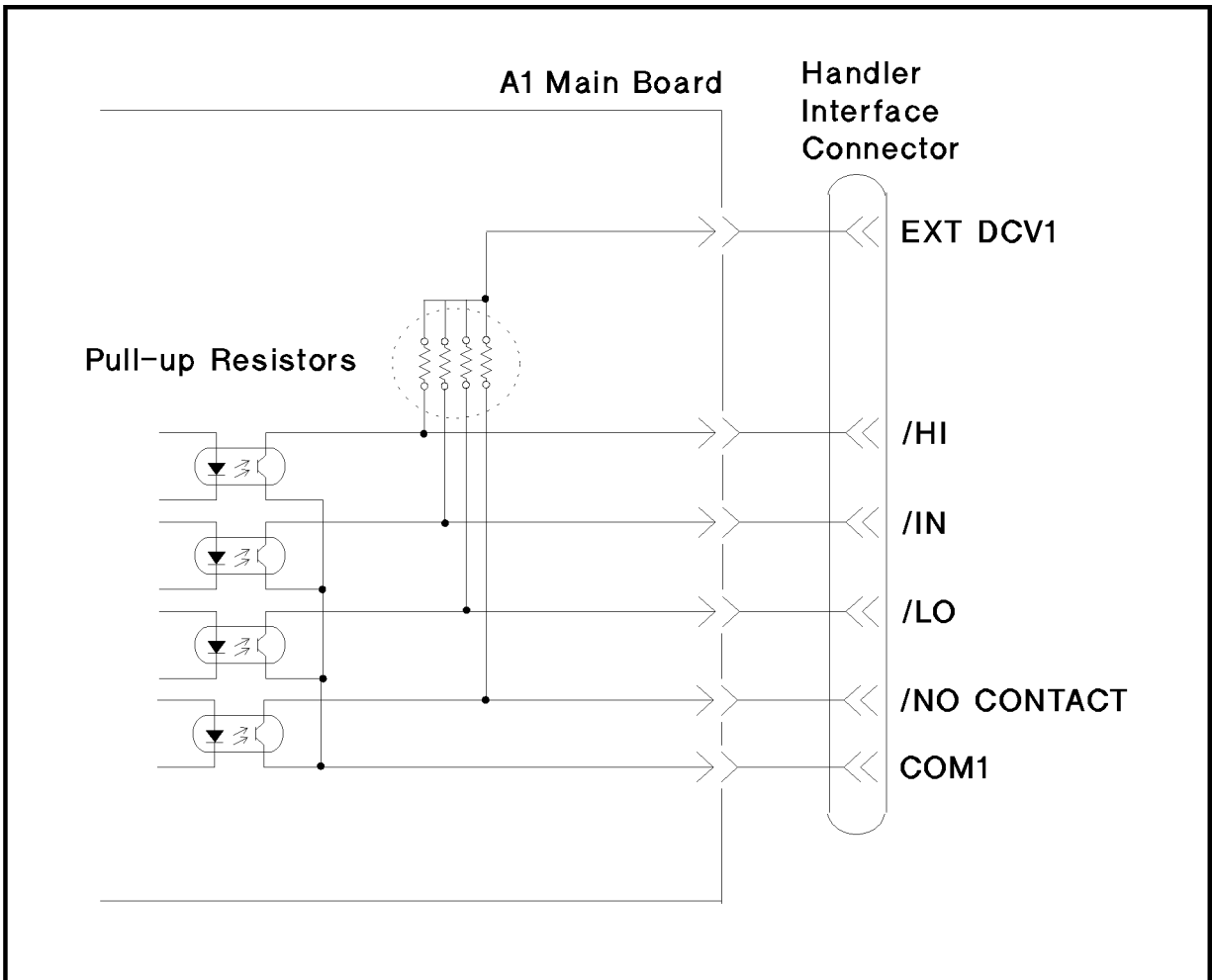

L500B001

Figure B-1. Handler Interface Comparison Output Signals Diagram

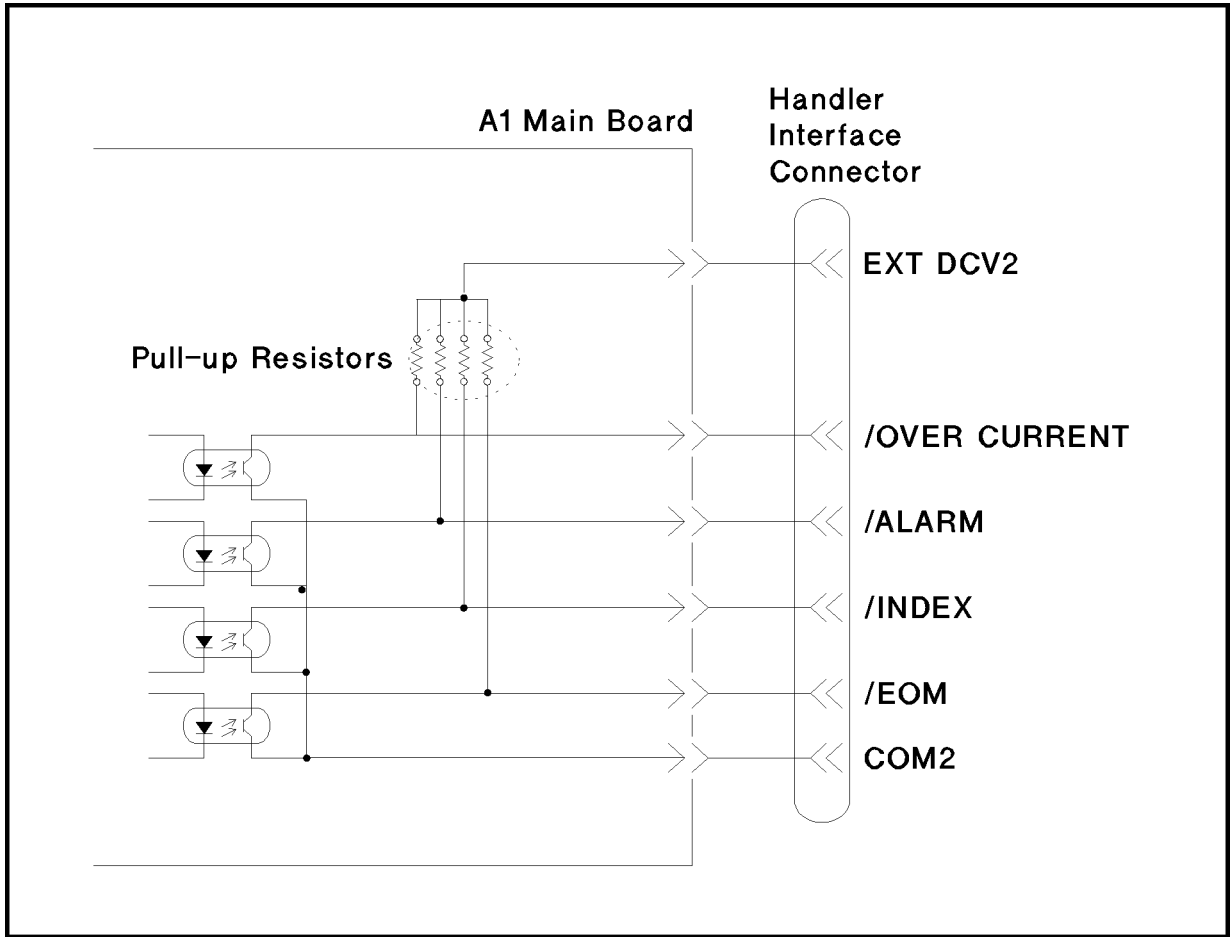

L500B003

Figure B-2. Handler Interface Control Output Signals Diagram

Input Signals

The DC isolated input signals are connected to the cathodes of the LEDs in the opto-isolators. The anodes of the LED's are powered by an external voltage source (EXT DCV2).

The OFF state voltage (high level) of the DC isolated input signals depends on the pull-up voltage powered by an external; voltage source (EXT DCV2). (The input current is restricted by using a switch on the main board.)

The electrical characteristics of the input signals are listed in Table B-2. A diagram for the input signals is shown in Figure B-3.

Table B-2. Handler Input Electrical Characteristics

Signal	Input Voltage		Input Current (Low) Pull-up Voltage			Circuit Common
	Low	High	5 V	12 V	15 V	
/EXT TRIG	≤ 1 V	5 to 15 V	11.1 mA	10.5 mA	13.5 mA	COM2
/KEY LOCK	≤ 1 V	5 to 15 V	5.2 mA	14.5 mA	18.5 mA	COM2
/HV OFF	≤ 1 V	5 to 15 V	11.1 mA	10.5 mA	13.5 mA	COM2

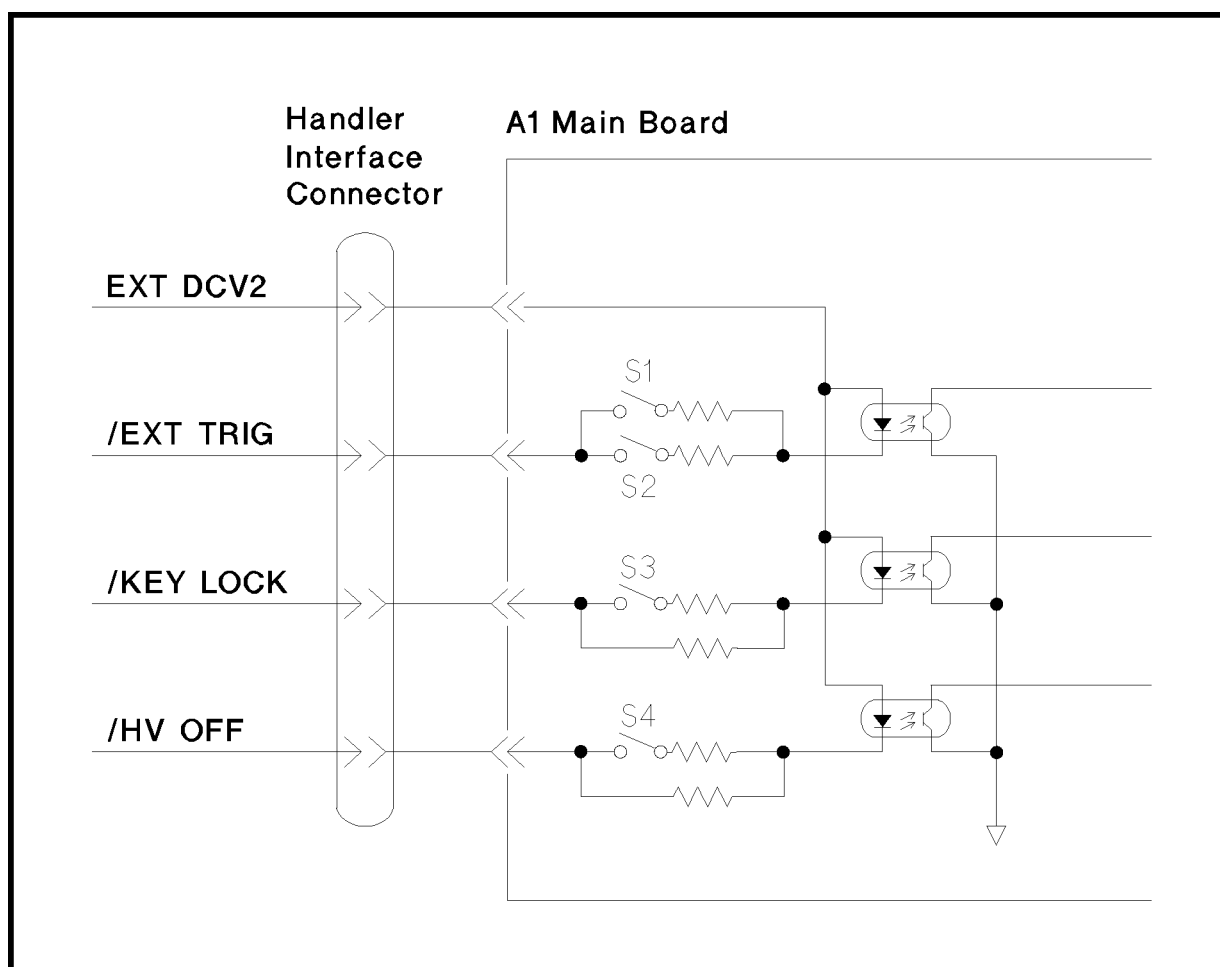

L500B002

Figure B-3. Handler Interface Input Signal Diagram

B-4 Handler Interface Installation

Setting Up the Handler Interface Board

Caution SUSCEPTIBLE TO DAMAGE FROM ESD.



Perform the following procedures only at a static-safe workstation and wear a grounding strap.

Caution Be careful not to short the circuit when performing the following procedures. For example:



- Solder cleanly and carefully.
 - Guard against hair or dust getting on the circuit.
 - Do *not* damage the boards, wires, or parts on the board.
-

Tools and Fasteners

The 4339B mechanical components are secured using metric threaded fasteners. Many fasteners in the 4339B may appear to be Phillips type, but they are Pozidrive type fasteners. To avoid damaging them, use only Pozidrive screwdrivers to remove or tighten pozidrive type fasteners.

Procedure

1. Disconnect the power cable from the 4339B and allow enough time (10 minutes) for the internal capacitors to discharge.
-

Warning **Dangerous energy and voltage levels exist within the 4339B when it is in operation and just after it is powered down. Allow 10 minutes for the 4339B's internal capacitors to discharge before starting to work on it.**



2. Remove the two screws which fasten the cover to the chassis rear panel.
 3. Slide the cover toward the rear while holding the front panel bezel.
-

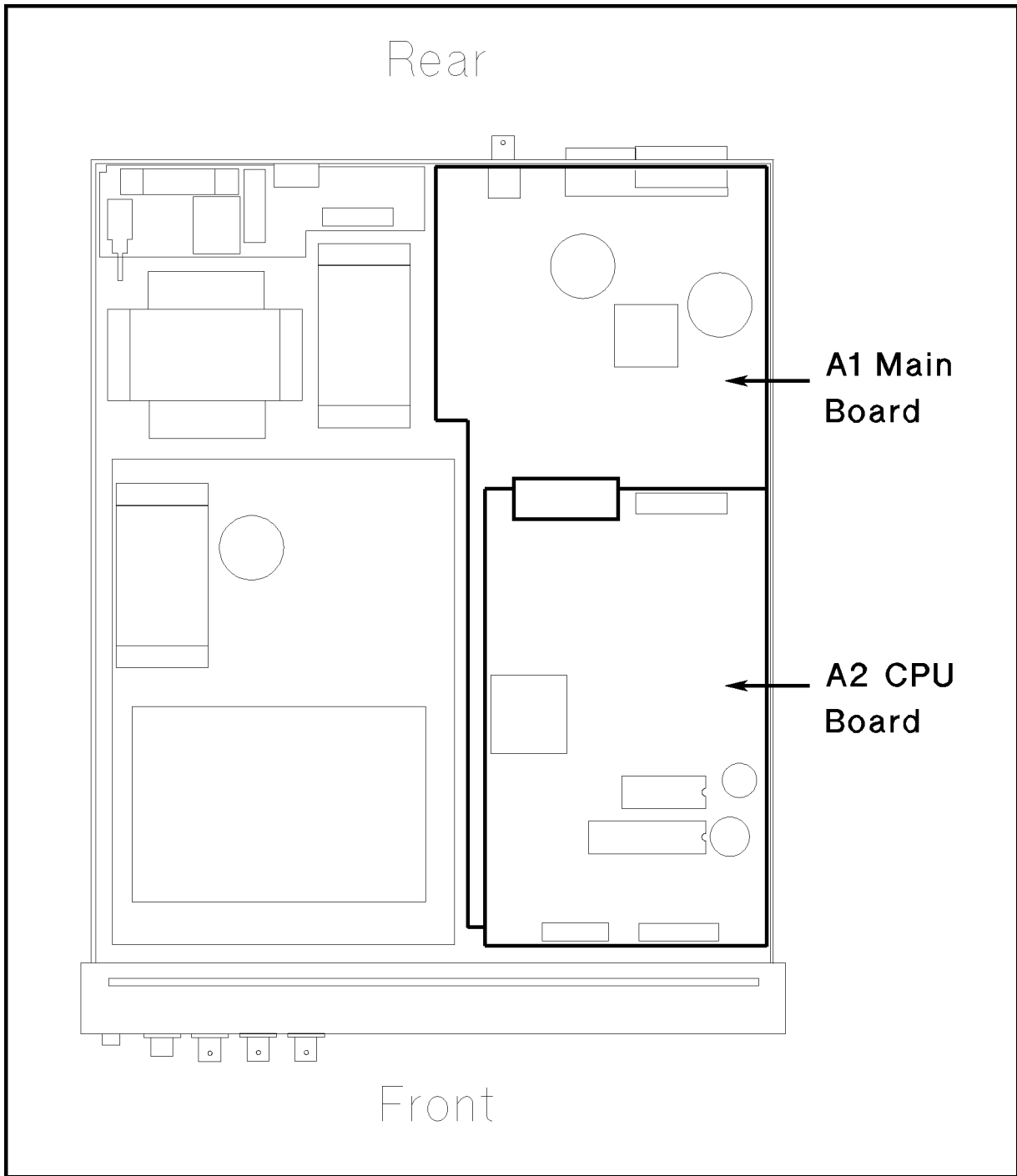

L500B005

Figure B-4. Top View of 4339B with Cover Removed

4. Remove the A2 CPU board assembly.
 - a. Disconnect the four flatcable assemblies from the A2 board.
 - b. Remove the four screws that secure the A1 board to the stud.
 - c. Remove the A2 board from the chassis.

5. Remove the A1 board assembly.
 - a. Disconnect the following cable assemblies from the A1 board.
 - i. Four cable assemblies form the front panel
 - ii. The cable assembly from the transformer
 - iii. Two cable assemblies form the DC-DC Converter
 - b. Disconnect the four optical fiber cables which are connected to the A# Ammeter Board Assembly
 - c. Disconnect the four optical fiber cables form the A3 Ammeter Board Assembly

Caution

To avoid damaging the optical fiber cable by bending or other mechanical stress, remove all the fiber cables form the 4339B when replacing either the A1 board or the A3 board.

- d. Remove the cable clamp on the shield case that surrounds the A3 board.
- e. Remove the nut that fastens the Ext Trigger connector on the rear panel.
- f. Remove the screw that secures the A1 board to the chassis side.
- g. Remove the four studs, that secure the A1 assembly to the chassis, by rotating the studs with a flat-bladed screwdriver.
- h. Remove the three screws that secure the A1 assembly to the chassis
- i. Remove the A1 assembly form the chassis

Figure B-5 shows the location of the sockets in which the pull-up resistors (J11) and the switch with which to select the voltage value of EXT DCV2. Table B-3 lists the socket numbers for each control signal and comparison signal.

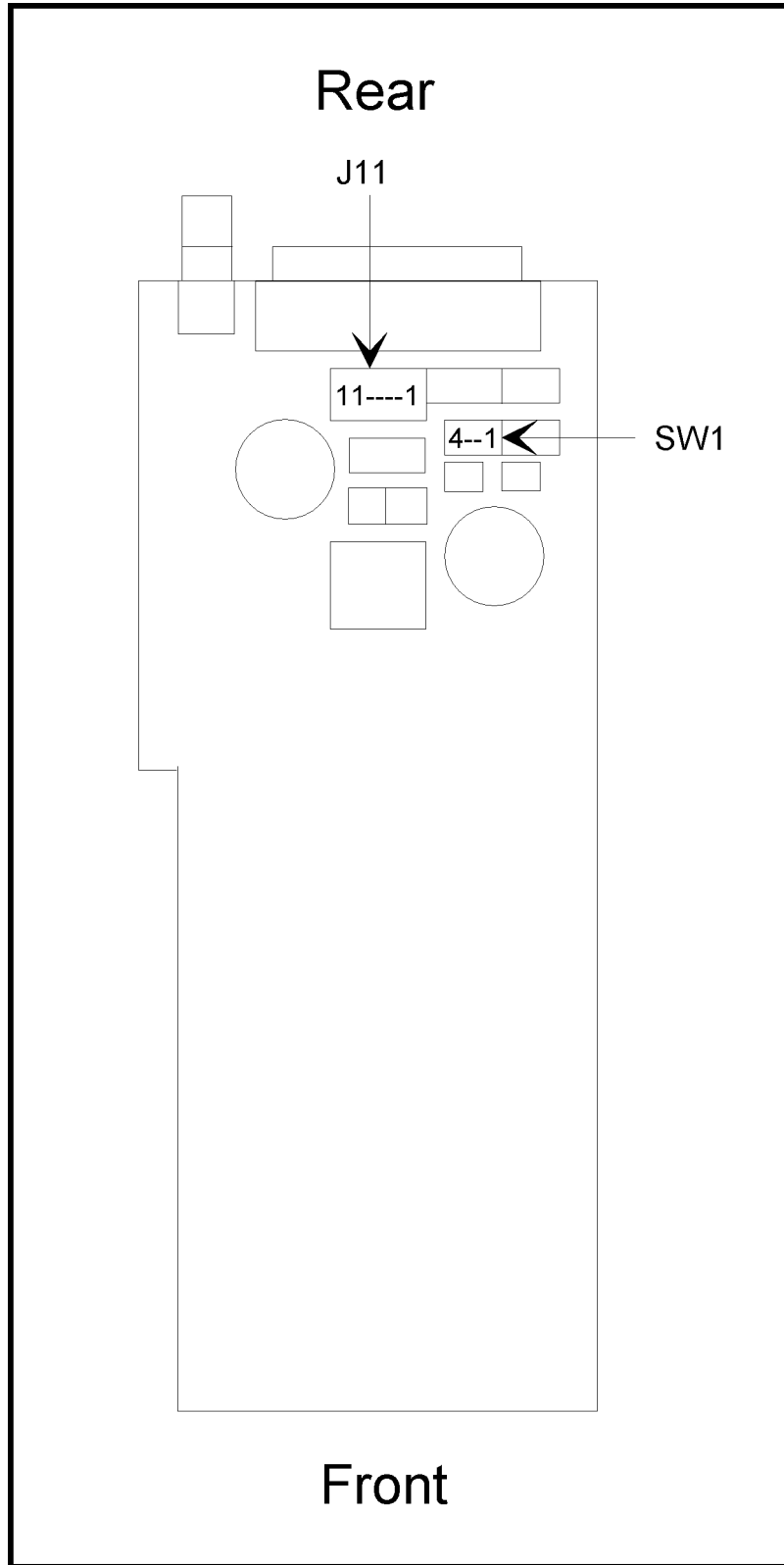

LA000B01

Figure B-5. A1 Main Board

Table B-3. Pull-up Resistor Location

Socket No.	Signal Name	Signal Type	
J11-1	/INDEX	Control Signal (5 to 15 V)	
J11-2	/EOM		
J11-3	/ALARM		
J11-4	/NOT READY		
J11-5	/NO CONTACT		Comparison Signal (5 to 24 V)
J11-6	/LO		
J11-7	/HI		
J11-8	/IN		
J11-9	Not Used		
J11-10			
J11-11			

6. Mount the pull-up resistors for the comparison output signals. (Refer to Figure B-5 and Table B-3 for the location of the pull-up resistors for the comparison output signals.) Use the following equation to determine the value of the pull-up resistors (R).

$$R \text{ [k}\Omega\text{]} \simeq V_p \text{ [V]} / 3$$

where, V_p is the pull-up voltage.

The typical pull-up resistor values are:

Pull-up Voltage	Pull-up Resistor Agilent Part Number
5 V	0757-0278 (1.78 k Ω)
12 V	0757-0279 (3.16 k Ω)
24 V	0757-0441 (8.25 k Ω)

7. Mount the pull-up resistors for the control output signals. (Refer to Figure B-5 and Table B-3 for the location of the pull-up resistors for the control output signals.) Use the following equation to determine the value of the pull-up resistors (R).

$$R \text{ [k}\Omega\text{]} \simeq V_p \text{ [V]} / 2.5$$

where, V_p is the pull-up voltage.

The typical pull-up resistor values are:

Pull-up Voltage	Pull-up Resistor Agilent Part Number
5 V	0757-0278 (1.78 k Ω)
9 V	0757-0279 (3.16 k Ω)
12 V	0698-3154 (4.22 k Ω)
15 V	0757-0438 (5.11 k Ω)

8. Set SW1 according to the voltage value of EXT DCV2.

EXT DCV2	EXT TRIG		KEY LOCK	HV OFF
	SW1-1	SW1-2	SW1-3	SW1-4
5 to 6 V	Close	Close	Close	Close
6 to 9 V	Close	Open	Close	Close
9 to 15 V	Open	Close	Open	Open

9. Reinstall the A1 main board, the A2 board, and the cover.

Overload/Over-Current/No-Contact Operations

Table C-1 shows the summary of operations when the 4339B detects OVLD (Overload), Over-Current (exceeding current limit), or N.C. (No-Contact). (Measurement parameter: R)

Table C-1. OVLD/Over-Current/N.C. Operations (Meas. parameter: R)

	Display		Handler Output	GPIB Output ¹	Solutions
	Data Mode	Comprtr Mode			
OVLD (Overload)	OVLD	LOW	/LO	<stat> ² : 1 <data>: 9.9E37 <comp> ³ : 4	Select an appropriate measurement range.
Over-Current	OV CURR	LOW	/LO & /NOT READY	<stat> ² : 4 <data>: 9.9E37 <comp> ³ : 4	Reduce the source voltage. Check whether a short circuit is occurred.
N.C. (No-Contact)	N.C.	N.C.	/NO CONTACT	<stat> ² : 2 <data>: 9.9E37 <comp> ³ : 8	Cancel the bad contact between DUT and contact-pin.
OVLD & N.C.	OVLD	LOW	/LO & /NO CONTACT	<stat> ² : 3 <data>: 9.9E37 <comp> ³ : 12	Select an appropriate measurement range. Cancel the bad contact between DUT and contact-pin.
OVLD & Over-Current	OV CURR	LOW	/LO & /NOT READY	<stat> ² : 5 <data>: 9.9E37 <comp> ³ : 4	Select an appropriate measurement range. Reduce the source voltage. Check whether a short circuit is occurred.

1 Refer to :FETCh? in Chapter 5

2 Measurement status (0:Normal, 1:Overload, 2:No-Contact, 4:Over-Current)

3 Comparison result (1:In, 2:High, 4:Low, 8:No-Contact)

Note



When two or more phenomena are detected at the same time, <stat> and <comp> of the GPIB output are the sum of the numbers which show each phenomenon. For example, when OVLD and N.C. are detected at the same time, the value of <stat> is 1(OVLD)+2(N.C.)=3, the value of <comp> is 4(Low)+8(N.C.)=12.

When the measurement parameter is I, High or Low status in the operation of handler/GPIB output and display is reversed as shown in Table C-2.

Table C-2. OVLD/Over-Current/N.C. Operations(Meas. parameter: I)

	Display		Handler Output	GPIB Output ¹	Solutions
	Data Mode	Comprtr Mode			
OVLD (Overload)	OVLD	HIGH	/HI	<stat> ² : 1 <data>: 9.9E37 <comp> ³ : 2	Select an appropriate measurement range.
Over-Current	OV CURR	HIGH	/HI & /NOT READY	<stat> ² : 4 <data>: 9.9E37 <comp> ³ : 2	Reduce the source voltage. Check whether a short circuit is occurred.
N.C. (No-Contact)	N.C.	N.C.	/NO CONTACT	<stat> ² : 2 <data>: 9.9E37 <comp> ³ : 8	Cancel the bad contact between DUT and contact-pin.
OVLD & N.C.	OVLD	HIGH	/HI & /NO CONTACT	<stat> ² : 3 <data>: 9.9E37 <comp> ³ : 10	Select an appropriate measurement range. Cancel the bad contact between DUT and contact-pin.
OVLD & Over-Current	OV CURR	HIGH	/HI & /NOT READY	<stat> ² : 5 <data>: 9.9E37 <comp> ³ : 2	Select an appropriate measurement range. Reduce the source voltage. Check whether a short circuit is occurred.

1 Refer to :FETCh? in Chapter 5

2 Measurement status (0:Normal, 1:Overload, 2:No-Contact, 4:Over-Current)

3 Comparison result (1:In, 2:High, 4:Low, 8:No-Contact)

Error Messages

This section lists the messages that are displayed on the 4339B's LCD display or transmitted by the instrument over GPIB, in numerical order.

Out of Range

OVER CURRENT

The current limit is working and the source output is reduced. Lower the test voltage value, or raise the current limit value.

OVLD

The measured value is out of the measurable range. Change the measurement range appropriately, or use the Auto range mode.

Warning

WARNING: FIXTURE LEAKAGE

When an OPEN correction is performed, the leakage current is high but it is less than the correction limit. (The measured leakage current is more than about 10 pA and less than about 10 μ A.) So you may not be able to measure lower values accuracy.

Instrument Errors

11 ADC FAILURE

The A/D conversion failed. The 4339B stops operation and asserts the /ALARM signal on the handler interface. Contact your nearest Agilent Technologies office.

12 ROM TEST FAILED

The ROM failed. When this error occurs during power-on test, the 4339B stops operation and asserts the /ALARM signal on the handler interface. When this error occurs during self-test, the 4339B continues operation and asserts the /ALARM signal. Contact your nearest Agilent Technologies office.

13 RAM TEST FAILED

The RAM failed. The 4339B stops operation and asserts the /ALARM signal on the handler interface. Contact your nearest Agilent Technologies office.

14 EEPROM R/W FAILED

The EEPROM read/write test failed. The 4339B stops operation and asserts the /ALARM signal on the handler interface. Contact your nearest Agilent Technologies office.

15 USER DATA LOST

Correction data and instrument settings saved in EEPROM have been lost. When this error occurs during power-on test, the 4339B sets the data in the EEPROM to the factory default settings, continues operation, and does not assert the /ALARM signal on the handler interface. When this error occurs during self-test, the 4339B continues the operation and asserts the /ALARM signal. Contact your nearest Agilent Technologies office.

16 PREV. SETTING LOST

Instrument settings in the backup memory have been lost. The instrument keeps instrument settings in backup memory for 72 hours after being turned OFF. When this error occurs during power-on test, the 4339B continues operation and does not assert the /ALARM signal on the handler interface. When this error occurs during self-test, the 4339B stops operation and asserts the /ALARM signal.

17 SAVE FAILED

The instrument setting was not be saved. (If the error is detected in the EEPROM, error 14 is displayed.) The 4339B continues operation and does not assert the /ALARM signal on the handler interface.

18 RECALL FAILED

No instrument setting saved in the EEPROM. (If the error is detected in the EEPROM, error 14 is displayed.) The 4339B continues operation and does not assert the /ALARM signal on the handler interface.

19 PRINTER NO RESPONSE

Check the following items:

- Check that the printer is turned on.
- Check that the GPIB cable is connected between the printer and the instrument.
- Check that the printer is set to "Listen Always."

The 4339B continues operation and does not assert the /ALARM signal on the handler interface.

20 A1 BD TEST FAILED

The A1 board failed. When this error occurs during power-on test, the 4339B stops operation and asserts the /ALARM signal on the handler interface. When this error occurs during self-test, the 4339B continues operation and asserts the /ALARM signal. Contact your nearest Agilent Technologies office.

21 LOCKOUT BY HANDLER

Front panel key input is disabled by the handler. The front panel key input cannot be enabled by the front panel keys or by GPIB commands when disabled by the handler. The 4339B continues operation and does not assert the /ALARM signal on the handler interface.

31 A3 BD TEST FAILED

The A3 board failed. Contact your nearest Agilent Technologies office.

32 HIGH LEAKAGE

When an OPEN correction is performed, the leakage current is too high (11 μA or above, -11 μA or below). Check that nothing is connected to the test lead.

33 HIGH STRAY C

When an OPEN correction is performed, the stray capacitance is too high (75 pF or above); for example, when you connect a coaxial test lead to a triaxial test lead, the coaxial cable is too long.

34 HIGH OFFSET LEAKAGE

When the calibration or the offset-error canceling is performed, the offset-error is too high. Contact your nearest Agilent Technologies office.

35 FIXTURE UNKNOWN

An unknown test fixture or test leads is connected to the Interlock connector; for example, when you connect the 16117C Test Leads to the 4339B, the wiring of the interlock cable is mistaken.

36 INTERLOCK OPEN

Nothing is connected to the Interlock connector or the test fixture's cover is opened.

GPIB Errors

-100 Command error

This is a generic syntax error that the 4339B cannot detect more specific errors. This code indicates only that a command error, as defined in IEEE 488.2, 11.5.1.1.4, has occurred.

-101 Invalid character

A syntax element contains a character which is invalid for that type; for example, a header containing an ampersand, SENSE&.

-102 Syntax error

An unrecognized command or data type was encountered; for example, a string was received when the 4339B was not expecting to receive a string.

-103 Invalid separator

The syntax analyzer was expecting a separator and encountered an illegal character; for example, the semicolon was omitted after a program message unit, *RST:TRIG.

-104 Data type error

The syntax analyzer recognized an unallowed data element; for example, numeric or string data was expected but block data was encountered.

-105 GET not allowed

A Group Execute Trigger (GET) was received within a program message (see IEEE 488.2, 7.7).

-108 Parameter not allowed

More parameters were received than expected for the header; for example, the [:SENSe]:AVERage:COUNt command only accepts one parameter, so receiving :AVER:COUN 2,4 is not allowed.

-109 Missing parameter

Fewer parameters were received than required for the header; for example, the [:SENSe]:AVERag:COUNT command requires one parameter, so receiving only :AVER:COUN is not allowed.

-112 Program mnemonic too long

The header contains more than twelve characters (see IEEE 488.2, 7.6.1.4.1).

-113 Undefined header

The header is syntactically correct, but it is undefined for the 4339B; for example, *XYZ is not defined for the 4339B.

-121 Invalid character in number

An invalid character for the data type being analyzed syntax parsed was encountered; for example, an alpha character in a decimal numeric or a “9” in octal data.

-123 Exponent too large

The magnitude of the exponent was larger than 32000 (see IEEE 488.2, 7.7.2.4.1).

-124 Too many digits

The mantissa of a decimal numeric data element contains more than 255 digits excluding leading zeros (see IEEE 488.2, 7.7.2.4.1).

-128 Numeric data not allowed

Legal numeric data element was received, but the 4339B does not accept it in this position for a header.

-131 Invalid suffix

The suffix does not follow the syntax described in IEEE 488.2, 7.7.3.2, or the suffix is inappropriate for the 4339B.

-138 Suffix not allowed

A suffix was encountered after a numeric element which does not allow suffixes.

-140 Character data error

This error, as well as errors –141 through –148, are generated when analyzing the syntax of a character data element. This particular error message is used if the 4339B cannot detect a more specific error.

-141 Invalid character data

Either the character data element contains an invalid character or the particular element received is not valid for the header.

-144 Character data too long

The character data element contains more than twelve characters (see IEEE 488.2, 7.7.1.4).

-148 Character data not allowed

A legal character data element was encountered that's prohibited by the 4339B.

-150 String data error

This error, as well as errors –151 and –158, are generated when analyzing the syntax of a string data element. This particular error message is used if the 4339B cannot detect a more specific error.

-151 Invalid string data

A string data element was expected, but was invalid for some reason (see IEEE 488.2, 7.7.5.2); for example, an END message was received before the terminal quote character.

-158 String data not allowed

A string data element was encountered but was not allowed by the 4339B at this point in the syntax analysis process.

-160 Block data error

This error, as well as errors –161 and –168, are generated when analyzing the syntax of a block data element. This particular error message is used if the 4339B cannot detect a more specific error.

-161 Invalid block data

A block data element was expected, but was invalid for some reason (see IEEE 488.2, 7.7.6.2); for example, an END message was received before the length was satisfied.

-168 Block data not allowed

A legal block data element was encountered but was not allowed by the 4339B at this point in the syntax analysis process.

-170 Expression error

This error, as well as errors –171 and –178, are generated when analyzing the syntax of an expression data element. This particular error message is used if the 4339B cannot detect a more specific error.

-171 Invalid expression

The expression data element was invalid (see IEEE 488.2, 7.7.7.2); for example, unmatched parentheses or an illegal character.

-178 Expression data not allowed

A legal expression data was encountered but was not allowed by the 4339B at this point in the syntax analysis process.

-200 Execution errors

This is the generic syntax error that the 4339B cannot detect more specific errors. This code indicates only that an execution error as defined in IEEE 488.2, 11.5.1.1.5 has occurred.

-211 Trigger ignored

A GET, *TRG, or triggering signal was received and recognized by the 4339B but was ignored because of 4339B timing considerations; for example, the 4339B was not ready to respond.

-213 Init ignored

A request for a measurement initiation was ignored as another measurement was already in progress.

-221 Settings conflict

A legal program data element was analyzed syntax but could not be executed due to the current device state (see IEEE 488.2, 6.4.5.3 and 11.5.1.1.5).

-222 Data out of range

A legal program data element was analyzed syntax but could not be executed because the interpreted value was outside the legal range as defined by the 4339B (see IEEE 488.2, 11.5.1.1.5).

-223 Too much data

A legal program data element of block, expression, or string type was received that contained more data than the 4339B could handle due to memory or related device-specific requirements.

-230 Data corrupt or stale

Possibly invalid data; new reading started but not completed since last access.

-241 Hardware missing

A legal program command or query could not be executed because of missing 4339B hardware; for example, an option was not installed.

-310 System error

Some error, termed "system error" by the 4339B, has occurred.

-311 Memory error

An error was detected in the 4339B's memory.

-313 Calibration memory lost

The nonvolatile calibration data has been lost. When this error occurs during power-on test, the 4339B stops operation and asserts the /ALARM signal on the handler interface. When this error occurs during self-test, the 4339B continues operation and asserts the /ALARM signal. Contact your nearest Agilent Technologies office.

-350 Queue overflow

A specific code entered into the queue in lieu of the code that caused the error. This code indicates that there is no room in the queue and an error occurred but was not recorded.

-400 Query errors

This is the generic query error that the 4339B cannot detect more specific errors. This code indicates only that a query error as defined in IEEE 488.2, 11.5.1.1.7 and 6.3 has occurred.

-410 Query INTERRUPTED

A condition causing an interrupted query error occurred (see IEEE 488.2, 6.3.2.3); for example, a query followed by DAB or GET before a response was completely sent.

-420 Query UNTERMINATED

A condition causing an unterminated query error occurred (see IEEE 488.2, 6.3.2.2); for example, the 4339B was addressed to talk and an incomplete program message was received by the controller.

-430 Query DEADLOCKED

A condition causing a deadlocked query error occurred (see IEEE 488.2, 6.3.1.7); for example, both input buffer and output buffer are full and the 4339B cannot continue.

-440 Query UNTERMINATED after indefinite response

A query was received in the same program message after an query requesting an indefinite response was executed (see IEEE 488.2, 6.5.7.5).

Index

A

- :ABORt, 5-7
- ABORt, 4-11
- ABORt command, 5-7
- Adrs key, 3-11
- [:ALL?]
 - CALibration, 5-16
- ammeter offset voltage and input resistance test , 9-6
- annunciator, 3-2
- ARM, 5-46
 - DELay, 5-46
 - SOURce, 5-46
- ARM event detection state, 5-46
- :ARM[:SEQuence1][:LAYer]:DELay, 4-25
- :ARM[:SEQuence1][:LAYer]:SOURce, 4-25
- ARM subsystem , 5-8
- Arrow key, 3-13
- ASCII, 5-22, 5-48
- :AUTO
 - CALibration, 5-16
 - SENSe:CURRent:RANGe, 5-27
- Auto/Hold key , 3-10
- Auto range, 3-10
- :AVERAge:COUNT
 - SENSe, 5-25
- Average key , 3-5
- :AVERAge[:STATe]
 - SENSe, 5-25
- averaging rate, 3-5
 - GPIB command, 5-25
 - how to set, 2-2, 4-7

B

- backup memory, 3-3
- :BEEPer
 - CALCulate1:LIMit, 5-11
- beeper, 3-19
 - GPIB command, 5-11
 - how to set, 2-14, 4-8
- BEEPer
 - CALCulate3, 5-15
- :BEEPer[:IMMEDIATE]
 - SYSTEM, 5-32
- :BEEPer:STATe
 - SYSTEM, 5-32

- :BEEPer[:STATe]
 - CALCulate1:LIMit, 5-11
- Bk Sp key, 3-13
- BLUE shift key , 3-13
- <Boolean>, 5-4
- bus trigger mode, 3-12

C

- :CALCulate:FORMat, 4-5
- :CALCulate:LIMit:BEEPer[:CONDition], 4-8
- :CALCulate:LIMit:BEEPer[:STATe], 4-8
- :CALCulate:LIMit:CLEar, 4-9
- :CALCulate:LIMit:FAIL?, 4-9
- :CALCulate:LIMit:LOWer[:DATA], 4-9
- :CALCulate:LIMit:LOWer:STATe, 4-9
- :CALCulate:LIMit:STATe, 4-9
- :CALCulate:LIMit:UPPER[:DATA], 4-9
- :CALCulate:LIMit:UPPER:STATe, 4-9
- :CALCulate:MATH:EXPRession:CATALog?, 4-9
- :CALCulate:MATH:EXPRession:NAME, 4-9
- :CALCulate:MATH:STATe, 4-9
- :CALCulate:RESistivity:EAREa, 4-8
- :CALCulate:RESistivity:EPERimeter, 4-8
- :CALCulate:RESistivity:GLENgth, 4-8
- :CALCulate:RESistivity:STHickness, 4-8
- CALCulate subsystem , 5-10
- calculation sheet , 9-17
- calibration, 3-14
 - GPIB command, 5-16
 - how to perform, 1-20
- :CALibration[:ALL]?, 4-6
- :Calibration:AUTO, 4-9
- CALibration subsystem , 5-16
- Cal key , 3-14
- charge time
 - how to set, 2-9
- cleaning , 1-9
- :CLEar
 - CALCulate1:LIMit, 5-11
- *CLS, 4-26, 5-37
- Command Error (CME) Bit, 5-42
- common command , 5-37
- comparator
 - GPIB command, 5-11

- how to use, 2-5, 4-9
- limit, 3-12
- on/off, 3-14
- Config key , 3-18
- contact check, 3-15
 - how to perform, 4-8
 - how to set, 2-12
- contact check , 5-26
- Contact Check Fail, C-1
- contact check functional test , 9-24
- :CONtAct:DATA?
 - SENSe, 5-26
- :CONtAct:LIMit?
 - SENSe, 5-26
- :CONtAct:OFFSet
 - SENSe, 5-26
- :CONtAct:VERify
 - SENSe, 5-26
- Cont Chk key , 3-15
- :CONTRol
 - DATA:FEED, 5-18
- :CORRection:COLLect[:ACQuire]
 - SENSe, 5-26
- :CORRection:DATA?
 - SENSe, 5-27
- :CORRection[:STATe]
 - SENSe, 5-27
- :COUNt
 - SENSe:AVERage, 5-25
 - TRIGger[:SEQuence1], 5-34
- Cur Limit key , 3-5
- :CURRent:APERture
 - SENSe, 5-27
- current limit, 3-5
 - how to set, 2-14
- :CURRent:LIMit[:AMPLitude]
 - SOURce, 5-29
- current measurement accuracy test , 9-8
- current monitor
 - GPIB command, 5-14
 - how to set, 2-14
- Current Monitor Key, 3-10
- :CURRent:RANGe:AUTO
 - SENSe, 5-27
- :CURRent:RANGe[:UPPer]
 - SENSe, 5-27

D

- :DATA
 - DATA, 5-17
- :DATA?
 - DATA, 5-17, 5-18
- data buffer, 4-24
- :DATA[:DATA], 4-9
- :DATA[:DATA]?, 4-24

Index-2

- :DATA:FEED, 4-24
- :DATA:FEED:CONTRol, 4-24
- <data_handle>, 5-4
- :DATA:POINts, 4-24
- DATA subsystem , 5-17
- data transfer format, 5-48
 - ASCII, 5-48
 - REAL, 5-49
- DBUF , 5-17
- :DELay
 - ARM, 5-9
 - TRIGger[:SEQuence1], 5-34
- Delay key, 3-12
- deviation measurement, 4-9
 - GPIB command, 5-13
 - how to display, 2-7, 2-8
- Device-Dependent Error Bit, 5-42
- :DIGit
 - DISPlay[:WINDow]:TEXT1, 5-19
- :DIREction
 - CALCulate3, 5-14
- Display , 3-2
- display digits
 - GPIB command, 5-19
 - how to select, 2-16
- display mode, 2-6, 2-16, 3-16
 - GPIB command, 5-19
- DISPlay subsystem , 5-19
- Disp Mode key , 3-16

E

- E key , 3-13
- Elec Size key , 3-8
- electrode size
 - how to set, 2-3
- Enter key , 3-13
- :EPERimeter
 - CALCulate1:RESistivity, 5-13
- :ERRor?
 - SYSTEM, 5-32
- *ESE, 4-26, 5-37
- *ESE?, 5-37
- *ESR?, 4-26, 5-37
- Execution Error Bit, 5-42
- external trigger input, 3-20
- external trigger mode, 2-5, 3-12

F

- :FAIL?
 - CALCulate1:LIMit, 5-12
- :FEED
 - DATA, 5-18
- :FEED:CONTRol
 - DATA, 5-18
- FETCh?, 4-11, 5-21

:FORMat
 CALCulate1, 5-11
 CALCulate3, 5-14
:FORMat[:DATA], 5-22
FORMat subsystem, 5-22
front panel, 3-2
:FUNCTion
 SENSE, 5-28

G

GET, 4-11
:GLENGth
 CALCulate1:RESistivity, 5-14
GPIB address, 3-11
 how to set, 2-19
group execution trigger, 4-11

H

handler interface functional test , 9-22
High Voltage indicator , 3-4
Hold range, 3-10

I

Idle state, 5-46
*IDN?, 5-37
IEEE 754 floating point format, 5-22, 5-49
IMON, 5-18
:INITiate:CONTinuous, 4-11, 5-23
:INITiate[:IMMediate], 4-11, 5-23
Initiate state, 5-46
INITiate subsystem , 5-23
insulation resistance measurement, 7-2
interlock connector, 3-3
internal trigger mode, 2-5, 3-12
interval time
 how to set, 2-10

K

key lock, 2-18, 3-16, 4-8
 GPIB command, 5-32
Key Lock key, 3-16
:KLOCK
 SYSTEM, 5-32

L

Lcl key, 3-11
:LFRequency
 SYSTEM, 5-32
:LIMit[:AMPLitude]
 SOURCE:CURRent, 5-29
:LIMit:BEEPer:CONDition
 CALCulate1, 5-11
:LIMit:BEEPer[:STATe]
 CALCulate1, 5-11
:LIMit:CLEar

 CALCulate1, 5-11
:LIMit:FAIL?
 CALCulate1, 5-12
Limit key, 3-12
:LIMit:LOWer[:DATA]
 CALCulate1, 5-12
:LIMit:LOWer:STATe
 CALCulate1, 5-12
:LIMit:STATe
 CALCulate1, 5-12
:LIMit:UPPer[:DATA]
 CALCulate1, 5-12
:LIMit:UPPer:STATe
 CALCulate1, 5-12
LINE frequency, 3-19
 GPIB command, 5-32
 how to set, 1-13, 4-5
LINE Fuse Holder , 3-21
LINE Input Receptacle , 3-21
LINE switch , 3-3
LINE voltage selector, 3-21
 How to select, 1-12
local mode, 2-18, 3-11
:LOWer
 CALCulate1:LIMit, 5-12
*LRN?, 4-10, 5-37

M

manual changes, A-1
manual trigger mode, 2-5, 3-12
:MATH
 CALCulate1, 5-13
 CALCulate2, 5-14
 CALCulate3, 5-14
:MATH:EXPRession:CATalog?
 CALCulate1, 5-13
:MATH:EXPRession:NAME
 CALCulate1, 5-13
:MATH:STATe
 CALCulate1, 5-13
MAV (Message Available) Bit, 5-41
Max key , 3-13
Meas Prmtr key , 3-8
Meas Time key , 3-5
measurement parameter, 3-8
 GPIB command, 5-11
 How to select, 1-23
measurement range, 3-10
 GPIB command, 5-27
 how to select, 1-23, 4-7
measurement sequence mode
 how to select, 2-9
Measurement Settings display
 GPIB command, 5-20
 how to set, 2-17

measurement time mode, 3-5
 GPIB command, 5-27
 how to select, 2-2, 4-6
Min key , 3-13

N

N.C., C-1
<NR1> format, 5-48
<NR2> format, 5-48
<NR3> format, 5-48
number of repetitions
 how to set, 2-10
<numeric_value>, 5-3

O

offset-error canceling
 how to set, 2-19
Offset-error canceling, 3-18
On/Off key , 3-14
*OPC, 5-37
OPEN correction, 3-14
 GPIB command, 5-27
 how to perform, 1-22, 4-7
Open key , 3-14
Operation Complete Bit, 5-42
operation status register, 5-44
OUTPut, 4-6, 5-24
OUTPut subsystem , 5-24
OV CURR, C-1
Overall Block Diagram, 3-27
Overall Measurement Theory, 3-26
OVER CURRENT, 3-5
OVER CURRENT, C-1
Over Load, 3-10
OVER LOAD, C-1
OVLd, 3-10
OVLd, C-1

P

:PAGE
 DISPlay[:WINDow]:TEXT1, 5-19
 DISPlay[:WINDow]:TEXT2, 5-20
:PATH?
 CALCulate1, 5-13
performance test record , 9-19
:POINTs
 DATA, 5-18
power cable , 1-10
power cord selection , 3-21
:PREFIX
 DISPlay[:WINDow]:TEXT1, 5-19
:PRESet
 SYSTem, 5-33
Program key , 3-7

Q

Query, 5-5
Query Error Bit, 5-42
questionable status register, 5-44

R

:RANGe
 SENSE:CURRent, 5-27
Range Setup key, 3-10
:RANGe[:UPPer]
 SENSE:CURRent, 5-27
*RCL, 4-10, 5-38
Rcl key , 3-12
REAL, 5-22, 5-49
recall, 3-12
 instrument settings, 2-18
reference value
 how to set, 2-7
reset, 3-17
 how to, 1-20, 4-5
Reset key, 3-17
resistance measurement accuracy test , 9-12
resistivity, 7-3
:RESistivity:EARea
 CALCulate1, 5-13
:RESistivity:EPERimeter
 CALCulate1, 5-13
:RESistivity:GLENgth
 CALCulate1, 5-14
resistivity measurement
 how to set parameters for, 2-3
resistivity measurement parameters
 how to set, 4-8
:RESistivity:STHickness
 CALCulate1, 5-14
RQS (Request Service) Bit, 5-41
*RST, 4-5, 5-38

S

sample program, 4-28
*SAV, 4-10, 5-38
save, 3-12
 instrument settings, 2-18
Save key , 3-12
self-test, 3-19
 GPIB command, 5-39
 how to perform, 2-20, 4-26
:SENSE:AVERage:COUNT, 4-7
:SENSE:AVERage[:STATe], 4-7
:SENSE:CONtact:VERify, 4-8
:SENSE:CORRection:COLlect OFFSet, 4-7
:SENSE:CURRent:APERture, 4-6
:SENSE:CURRent:RANGe:AUTO, 4-7
:SENSE:CURRent:RANGe[:UPPer], 4-7
:SENSE:FUNcTion, 4-5

SENSE subsystem , 5-25
 <sensor_function>, 5-28
 <sensor_function>, 5-4
 Seq Abort key , 3-11
 Seq Mode key, 3-6
 :SEQUENCE1
 ARM, 5-9
 [:SEQUENCE1]:COUNT
 TRIGGER, 5-34
 [:SEQUENCE1]:DELAY
 TRIGGER, 5-34
 [:SEQUENCE1][:IMMEDIATE]
 TRIGGER, 5-34
 [:SEQUENCE1][:LAYER]:DELAY
 ARM, 5-9
 [:SEQUENCE1][:LAYER]:SOURCE
 ARM, 5-9
 [:SEQUENCE1]:SOURCE
 TRIGGER, 5-35
 [:SEQUENCE1]:TIMER
 TRIGGER, 5-36
 Sequence operation state, 5-47
 serial number, A-2
 Service Request Enable Register, 5-40
 Service Request (SRQ), 5-40
 Show Setting Key, 3-10
 :SOURCE
 ARM, 5-9
 TRIGGER, 5-35
 SOURCE subsystem , 5-29
 :SOURCE:VOLTAGE, 4-5
 source voltage. *See* test voltage
 source voltage accuracy test , 9-4
 Source Voltage key , 3-5
 Specifications, 8-2
 SPOLL, 4-26
 *SRE, 4-26, 5-38
 standard event status register, 5-42
 :STAT, 5-30
 :STATe
 CALCULATE1:LIMIT, 5-12
 DISPLAY[:WINDOW], 5-19
 OUTPUT, 5-24
 SENSE:CORRECTION, 5-27
 status, 5-40
 how to report, 4-26
 status byte register, 5-41
 :STATUS:OPERATION:CONDITION?, 4-26,
 5-30
 :STATUS:OPERATION:ENABLE, 4-26, 5-30
 :STATUS:OPERATION[:EVENT]?, 4-26, 5-30
 :STATUS:PRESET, 4-26, 5-30
 :STATUS:QUESTIONABLE:CONDITION?, 4-26,
 5-30
 :STATUS:QUESTIONABLE:ENABLE, 4-26, 5-31

:STATUS:QUESTIONABLE[:EVENT]?, 4-26,
 5-31
 STATUS subsystem, 5-30
 *STB?, 4-26, 5-38
 :STHICKNESS
 CALCULATE1:RESISTIVITY, 5-14
 supplemental performance characteristics,
 8-8
 surface resistivity, 7-4
 :SYSTEM:BEEPER[:IMMEDIATE], 4-8
 :SYSTEM:BEEPER:STATE, 4-8
 :SYSTEM:KLOCK, 4-8
 :SYSTEM:LFFREQUENCY, 4-5
 :SYSTEM:PRESET, 4-5
 SYST:ERR?, 4-26

T

talk only mode, 2-19
 test equipment , 9-1
 test voltage, 3-5
 how to apply, 1-24, 4-6
 how to set, 1-21, 4-5
 Theory of Operation , 3-26
 thickness
 how to enter, 2-3
 time display function, 3-8
 GPIB command, 5-14
 how to set, 2-10
 :TIMER
 TRIGGER[:SEQUENCE1], 5-36
 TMON, 5-18
 *TRG, 4-11, 5-38
 TRIG, 5-47
 COUNT, 5-47
 DELAY, 5-47
 IMMEDIATE, 5-47
 SOURCE, 5-47
 TRIG event detection state, 5-47
 trigger, 3-11
 how to, 2-5
 how to trigger, 4-11
 TRIGGER, 5-34
 TRIGGER, 4-11
 trigger delay time, 3-12
 GPIB command, 5-34
 how to set, 2-2, 4-7
 :TRIGGER[:SEQUENCE1]:COUNT, 4-25
 :TRIGGER[:SEQUENCE1][:IMMEDIATE], 4-11
 :TRIGGER[:SEQUENCE1]:SOURCE, 4-11, 4-25
 :TRIGGER[:SEQUENCE1]:TIMER, 4-25
 :TRIGGER[:SEQUENCE1]:DELAY, 4-7
 TRIGGER subsystem , 5-34
 trigger system , 5-45
 Trig key , 3-11
 Trig Mode key, 3-12

*TST?, 4-26, 5-39

U

UNKNOWN terminals , 3-4

:UPPer

 CALCulate1:LIMit, 5-12

V

:VERSion?

 SYSTem, 5-33

:VOLTage

 SOURce, 5-29

volume resistivity, 7-3

V Output indicator , 3-5

V Output key , 3-4

W

*WAI, 5-39

REGIONAL SALES AND SUPPORT OFFICES

For more information about Agilent Technologies test and measurement products, applications, services, and for a current sales office listing, visit our web site: <http://www.agilent.com/find/tmdir>. You can also contact one of the following centers and ask for a test and measurement sales representative. 11/29/99

United States:

Agilent Technologies
Test and Measurement Call Center
P.O.Box 4026
Englewood, CO 80155-4026
(tel) 1 800 452 4844

(fax) (61 3) 9272 0749
(tel) 0 800 738 378 (New Zealand)
(fax) (64 4) 802 6881

Canada:

Agilent Technologies Canada Inc.
5150 Spectrum Way
Mississauga, Ontario
L4W 5G1
(tel) 1 877 894 4414

Asia Pacific:

Agilent Technologies
24/F, Cityplaza One, 1111 King's Road,
Taikoo Shing, Hong Kong
(tel) (852)-3197-7777
(fax) (852)-2506-9284

Europe:

Agilent Technologies
Test & Measurement
European Marketing Organization
P.O.Box 999
1180 AZ Amstelveen
The Netherlands
(tel) (31 20) 547 9999

Japan:

Agilent Technologies Japan Ltd.
Call Center
9-1, Takakura-Cho, Hachioji-Shi,
Tokyo 192-8510, Japan
(tel) (81) 426 56 7832
(fax) (81) 426 56 7840

Latin America:

Agilent Technologies
Latin American Region Headquarters
5200 Blue Lagoon Drive, Suite #950
Miami, Florida 33126
U.S.A.
(tel) (305) 267 4245
(fax) (305) 267 4286

Australia/New Zealand:

Agilent Technologies Australia Pty Ltd
347 Burwood Highway
Forest Hill, Victoria 3131
(tel) 1-800 629 485 (Australia)