

DECLARATION OF CONFORMITY

According to ISO/IEC Guide 22 and CEN/CENELEC EN 45014

Manufacturer's Name: Agilent Technologies Japan, Ltd.
Manufacturer's Address: 1-3-2, Murotani, Nishi-ku, Kobe-shi,
Hyogo, 651-2241 Japan

Declares, that the product:

Product Name: 40 Hz - 110 MHz Precision Impedance Analyzer
Model Number: 4294A
Product Options: This declaration covers all options of the above product

Conforms with the following product standards:

EMC:	Standard	Limit
	IEC 61326-1:1997 +A1:1998 / EN 61326-1:1997 +A1:1998	
	CISPR 11:1997 / EN 55011:1998 / AS/NZS 2064.1/2	Group 1, Class A ^[1]
	IEC 61000-4-2:1995 / EN 61000-4-2:1995 +A1:1998	4 kV CD, 4 kV AD
	IEC 61000-4-3:1995 / EN 61000-4-3:1996 +A1:1998	3 V/m 80% AM 80 - 1000 MHz
	IEC 61000-4-4:1995 / EN 61000-4-4:1995	0.5 kV signal lines, 1 kV power lines
	IEC 61000-4-5:1995 / EN 61000-4-5:1995	0.5 kV line-line, 1 kV line-ground
	IEC 61000-4-6:1996 / EN 61000-4-6:1996	3 V 80% AM 0.15 - 80 MHz
	IEC 61000-4-11:1994 / EN 61000-4-11:1994	1 cycle, 100%
	Canada: ICES-001	
Safety:	IEC 61010-1:1990 +A1:1992 +A2:1995 / EN 61010-1:1993 +A2:1995	
	CAN / CSA C22.2 No. 1010.1-92	

Conformity / Supplementary Information:

The product herewith complies with the requirements of the Low Voltage Directive 73/23/EEC and the EMC Directive 89/336/EEC (including 93/68/EEC) and carries the CE-marking accordingly (European Union).

LEDs in this product are Class 1 in accordance with EN 60825-1:1994.

^[1] The product was tested in a typical configuration with Agilent Technologies test systems.

Kobe, Japan Dec. 15, 2000
Date

Name Koichi Yanagawa / Quality Engineering Manager

For further information, please contact your local Agilent Technologies sales office, agent or distributor.

Safety Summary

When you notice any of the unusual conditions listed below, immediately terminate operation and disconnect the power cable.

Contact your local Agilent Technologies sales representative or authorized service company for repair of the instrument. If you continue to operate without repairing the instrument, there is a potential fire or shock hazard for the operator.

- Instrument operates abnormally.
- Instrument emits abnormal noise, smell, smoke or a spark-like light during the operation.
- Instrument generates high temperature or electrical shock during operation.
- Power cable, plug, or receptacle on instrument is damaged.
- Foreign substance or liquid has fallen into the instrument.

Herstellerbescheinigung

GERÄUSCHEMISSION

LpA < 70 dB
am Arbeitsplatz
normaler Betrieb
nach DIN 45635 T. 19

Manufacturer's Declaration

ACOUSTIC NOISE EMISSION

LpA < 70 dB
operator position
normal operation
per ISO 7779

Caution



Do not exceed the operating input power, voltage, and current level and signal type appropriate for the instrument being used, refer to your instrument's Function Reference.



Electrostatic discharge(ESD) can damage the highly sensitive microcircuits in your instrument. ESD damage is most likely to occur as the test fixtures are being connected or disconnected. Protect them from ESD damage by wearing a grounding strap that provides a high resistance path to ground. Alternatively, ground yourself to discharge any static charge built-up by touching the outer shell of any grounded instrument chassis before touching the test port connectors..

Agilent 4294A Precision Impedance Analyzer

Operation Manual

Seventh Edition

FIRMWARE REVISIONS

This manual applies directly to instruments that have the firmware revision 1.1x.
For additional information about firmware revisions, see Appendix A.



Agilent Technologies

Part No. 04294-90060

February 2003

Printed in: Japan

Notices

The information contained in this document is subject to change without notice.

This document contains proprietary information that is protected by copyright. All rights are reserved. No part of this document may be photocopied, reproduced, or translated into another language without the prior written consent of Agilent Technologies.

Agilent Technologies Japan, Ltd.

Kobe Instrument Division

1-3-2, Murotani, Nishi-Ku, Kobe-shi, Hyogo, 651-2241 Japan

© Copyright 1999, 2001, 2002, 2003 Agilent Technologies Japan, Ltd.

Manual Printing History

The manual's printing date and part number indicate its current edition. The printing date changes when a new edition is printed. (Minor corrections and updates incorporated in reprints do not necessitate a new printing date.) The manual part number changes when extensive technical changes are incorporated.

April 1999	First Edition
May 1999	Second Edition
December 1999	Third Edition
January 2001	Fourth Edition
March 2002	Fifth Edition
November 2002	Sixth Edition
February 2003	Seventh Edition

Safety Summary

The following general safety precautions must be observed during all phases of operation, service, and repair of this instrument. Failure to comply with these precautions or with specific WARNINGS elsewhere in this manual may impair the protection provided by the equipment. Such noncompliance would also violate safety standards of design, manufacture, and intended use of the instrument.

The Agilent Technologies assumes no liability for the customer's failure to comply with these requirements.

NOTE

The Agilent 4294A complies with INSTALLATION CATEGORY II and POLLUTION DEGREE 2 in IEC61010-1. The Agilent 4294A is an INDOOR USE product.

NOTE

LEDs in the Agilent 4294A are Class 1 in accordance with IEC60825-1, CLASS 1 LED PRODUCT.

- **Ground the Instrument**

To avoid electric shock, the instrument chassis and cabinet must be grounded with the supplied power cable's grounding prong.
- **DO NOT Operate in an Explosive Atmosphere**

Do not operate the instrument in the presence of inflammable gasses or fumes. Operation of any electrical instrument in such an environment clearly constitutes a safety hazard.
- **Keep Away from Live Circuits**

Operators must not remove instrument covers. Component replacement and internal adjustments must be made by qualified maintenance personnel. Do not replace components with the power cable connected. Under certain conditions, dangerous voltage levels may exist even with the power cable removed. To avoid injuries, always disconnect the power and discharge circuits before touching them.
- **DO NOT Service or Adjust Alone**

Do not attempt internal service or adjustment unless another person, capable of rendering first aid and resuscitation, is present.
- **DO NOT Substitute Parts or Modify the Instrument**

To avoid the danger of introducing additional hazards, do not install substitute parts or perform unauthorized modifications to the instrument. Return the instrument to an Agilent Technologies Sales and Service Office for service and repair to ensure that safety features are maintained in operational condition.
- **Dangerous Procedure Warnings**

Warnings, such as the example below, precede potentially dangerous procedures throughout this manual. Instructions contained in the warnings must be followed.

WARNING

Dangerous voltage levels, capable of causing death, are present in this instrument. Use extreme caution when handling, testing, or adjusting this instrument.

Safety Symbols

General definitions of safety symbols used on the instrument or in manuals are listed below.



Instruction Manual symbol: the product is marked with this symbol when it is necessary for the user to refer to the instrument manual.



Alternating current.



Direct current.



On (Supply).



Off (Supply).



In-position of push-button switch.



Out-position of push-button switch.



Frame (or chassis) terminal. A connection to the frame (chassis) of the equipment, which normally includes all exposed metal structure.

WARNING

This warning sign denotes a hazard. It calls attention to a procedure, practice, or condition that, if not correctly performed or adhered to, could result in injury or death to personnel.

CAUTION

This Caution sign denotes a hazard. It calls attention to a procedure, practice, or condition that, if not correctly performed or adhered to, could result in damage to or destruction of part or all of the product.

NOTE

This Note sign denotes important information. It calls attention to a procedure, practice, or condition that is essential for the user to understand.

Certification

Agilent Technologies certifies that this product met its published specifications at the time of shipment from the factory. Agilent Technologies further certifies that its calibration measurements are traceable to the United States National Institute of Standards and Technology, to the extent allowed by the Institution's calibration facility or by the calibration facilities of other International Standards Organization members.

Warranty

This Agilent Technologies instrument product is warranted against defects in material and workmanship for a period corresponding to the individual warranty periods of its component products. Instruments are warranted for a period of one year. Fixtures and adapters are warranted for a period of 90 days. During the warranty period, Agilent Technologies will, at its option, either repair or replace products that prove to be defective.

For warranty service or repair, this product must be returned to a service facility designated by Agilent Technologies. Buyer shall prepay shipping charges to Agilent Technologies and Agilent Technologies shall pay shipping charges to return the product to Buyer. However, Buyer shall pay all shipping charges, duties, and taxes for products returned to Agilent Technologies from another country.

Agilent Technologies warrants that its software and firmware designated by Agilent Technologies for use with an instrument will execute its programming instruction when properly installed on that instrument. Agilent Technologies does not warrant that the operation of the instrument, or software, or firmware will be uninterrupted or error free.

Limitation of Warranty

The foregoing warranty shall not apply to defects resulting from improper or inadequate maintenance by Buyer, Buyer-supplied software or interfacing, unauthorized modification or misuse, operation outside the environmental specifications for the product, or improper site preparation or maintenance.

IMPORTANT

No other warranty is expressed or implied. Agilent Technologies specifically disclaims the implied warranties of merchantability and fitness for a particular purpose.

Exclusive Remedies

The remedies provided herein are Buyer's sole and exclusive remedies. Agilent Technologies shall not be liable for any direct, indirect, special, incidental, or consequential damages, whether based on contract, tort, or any other legal theory.

Assistance

Product maintenance agreements and other customer assistance agreements are available for Agilent Technologies products.

For any assistance, contact your nearest Agilent Technologies Sales and Service Office. Addresses are provided at the back of this manual.

Typeface Conventions

Bold	Boldface type is used when a term is defined. For example: icons are symbols.
<i>Italic</i>	Italic type is used for emphasis and for titles of manuals and other publications.
[Hardkey]	Indicates a hardkey labeled "Hardkey."
Softkey	Indicates a softkey labeled "Softkey."
[Hardkey] - Softkey1 - Softkey2	Indicates keystrokes [Hardkey] - Softkey1 - Softkey2.

Agilent 4294A Documentation Map

The following manuals are available for the Agilent 4294A.

- **Operation Manual (Agilent P/N: 04294-900x0)**

Most of the basic information necessary for using the Agilent 4294A is provided in this manual. It describes installation, preparation, measurement operation including calibration, performances (specifications), key definitions, and error messages. For GP-IB programming, see the *Programming Manual* together with *HP Instrument BASIC User's Handbook*.

- ***Programming Manual (Agilent P/N: 04294-900x1)***

The *Programming Manual* shows how to write and use BASIC program to control the Agilent 4294A and describes how HP Instrument BASIC works with the analyzer.

- ***HP Instrument BASIC User's Handbook (Agilent P/N: E2083-90005)***

The *HP Instrument BASIC User's Handbook* introduces you to the HP Instrument BASIC programming language, provides some helpful hints on getting the most use from it, and includes a general programming reference. It is divided into three books: *HP Instrument BASIC Programming Techniques*, *HP Instrument BASIC Interface Techniques*, and *HP Instrument BASIC Language Reference*.

- ***Service Manual (Agilent P/N: 04294-90100, Option 0BW only)***

This manual explains how to adjust and repair the Agilent 4294A and how to carry out performance tests. This manual is attached when Option 0BW is ordered.

NOTE

The number of “x” in the part number of each manual (Agilent P/N), 0 for the first edition, is incremented by 1 each time a revision is made.

1. Installation

Incoming Inspection 18

Precautions to Take Before Setting Up the Power Supply 20

 Setting Up and Replacing the Fuse 20

 Power Source Requirements 20

Power Cable 21

Connecting the BNC Adapter (for Option 1D5 Only). 23

Using the LAN Port 24

Connecting the Supplied Keyboard 25

Using a Rackmount Kit. 26

 Option 1CN Handle Kit. 26

 Option 1CM Rackmount Kit. 27

 Option 1CP Rackmount & Handle Kit 27

Environmental Requirements 28

Providing clearance to dissipate heat at installation site. 28

Instructions for Cleaning 28

2. Learning Operation Basics

Required Equipment 30

Preparing for a Measurement 31

 Connect the Agilent 16047E Test Fixture 31

 Turn ON the Power 32

 Set the Adapter Type to “NONE” 32

Specifying Measurement Conditions 33

 Initialize the Agilent 4294A to the Preset State 33

 Select $|Z|-\theta$ as the Measurement Parameter 33

 Select Frequency as the Sweep Parameter 33

 Select Logarithmic Sweep as the Sweep Type 33

 Set the Sweep Start Value to 100 Hz. 34

 Set the Sweep Stop Value to 100 MHz 34

 Set the Measurement Bandwidth to 2 34

Fixture Compensation. 35

 Perform Fixture Compensation for the Open Circuit State. 35

 Perform Fixture Compensation for the Short Circuit State. 35

Carrying Out Measurement and Viewing Results 37

 Connect the DUT 37

 Apply the Logarithmic Format to the Vertical Axis for $|Z|$ 38

 Apply the Linear Format to the Vertical Axis for θ 38

 Display the Measured $|Z|$ and θ Values in Parallel 39

 Auto-scale the $|Z|$ Trace. 40

 Auto-scale the θ Trace. 40

Results of Analysis 42

 Determine the Self-resonance Frequency and Resonant Impedance 42

3. Front/Rear Panel and LCD Display

Front Panel 44

 Hardkeys 44

 1. ACTIVE TRACE block 45

2. MEASUREMENT Block	45
3. STIMULUS Block	46
4. ENTRY Block	46
5. MARKER Block	47
6. INSTRUMENT STATE Block	47
7. Softkeys	48
8. Color LCD Display	48
9. Power Switch	48
 10. UNKNOWN Terminals	49
11. Built-in 3.5 Inch Floppy Disk Drive	49
Rear Panel	50
1. External Reference Input Connector	50
2. High Stability Frequency Reference (Option 1D5 Only)	50
3. External Trigger Input	51
4. LAN Port	51
5. Internal Reference Output	51
6. External Program RUN/CONT Input	51
7. 8-bit I/O Port	51
8. Time Base Adjuster (for Option 1D5)	51
9. Mini-DIN Keyboard Port	51
10. 24-bit I/O Port	52
11. Printer Port	52
12. External Monitor Terminal	52
13. GPIB Connector	52
14. Inlet (with a fuse box)	52
Items Displayed on the LCD	53
1. Measurement Parameter Fields	53
2. Scale/Reference Fields	53
3. Marker Measurement Parameter Value Fields	53
4. Menu Title Field	53
5. Softkey Label Area	54
6. Sweep Parameter Reading Fields	55
7. Marker Status Fields	55
8. Marker Statistics/Trace Bandwidth Analysis Fields	56
9. Limit Line Test Fields	56
10. HP Instrument Basic Status Indicator	56
11. dc Voltage/Current Bias Monitor Field	56
12. Sweep Stop/Span Value Field	57
13. Test Signal Current Level Monitor Field	57
14. Test Signal Level/CW Frequency Setting Field	57
15. Test Signal Voltage Level Monitor Field	57
16. Sweep Start/Center Value Field	57
17. Instrument Status Area	57
18. Equivalent Circuit Parameters Field	60
19. External Reference Input Status Field	60
20. Parameter Setting/Instrument Message Field	60
21. Title Field	61

4. Preparation of Measurement Accessories

Selecting Accessories for Measurement	64
Connecting the Accessories	66
Adapter Setting	67
Adapter Selection	68
Adapter Setup	69
Adapter Setup Procedure for the 16048G and 16048H	70
Adapter Setup Procedure for the 16334A	72
Adapter Setup Procedure for the 16451B	73
Adapter Setup Procedure for the 42942A	74
Adapter Setup Procedure for the 42941A	78
5. Setting Measurement Conditions	
Putting the Agilent 4294A into the Preset State (Presetting)	82
Selecting Trace (Active Trace)	83
Selecting Sweep Parameter	84
Selecting Linear, Log, or List Sweep	87
Setting Sweep Range	89
Setting by start and stop values	89
Setting by center and span values	89
Setting sweep range with marker	90
Using Time as Sweep Parameter (Zero Span Sweep)	94
Setting Number of Points (NOP)	97
Selecting Sweep Direction	99
Manual Sweep (Measurement at a Specified Point)	100
Setting Time Delay for Measurement	102
Setting with sweep time	102
Setting with time delay at measurement point	102
Setting with sweep time delay	103
Setting Fixed Frequency (CW Frequency)	104
Setting Oscillator Level	105
Selecting Unit for Oscillator Level (Voltage or Current)	106
Setting and Applying dc Bias	107
1. Selecting dc bias mode	107
2. Setting fixed dc bias level	107
3. Setting limits for dc voltage	108
4. Setting dc bias range to 1 mA	108
5. Turning dc bias ON or OFF	109
6. Optimizing dc bias range	109
Selecting a Method to Start Measurement (Trigger Source)	111
Selecting Sweep Trigger/Measurement Point Trigger	112
Selecting Polarity of External Trigger Input Signal	113
Specifying Sweep Times and Stopping Sweep	114
Single sweep	114
Sweep by specified times	114
Sweep with unlimited times (continuous sweep)	115
Stopping sweep	115
Sweeping Multiple Sweep Ranges with Different Conditions in a Single Action (List Sweep)	116
Preparing list sweep table	118
Selecting the list sweep as the sweep type	124

Setting the Horizontal Axis of the Graph for the List Sweep	124
Setting Measurement Accuracy, Stability, and Time	126
Setting measurement bandwidth	126
Averaging between sweeps (sweep-to-sweep averaging)	126
Averaging for each measurement point (point averaging)	127
6. Calibration	
Selecting Appropriate Calibration Method	130
A. Calibration When Using Direct Connection Type Test Fixture	133
B. Calibration for Four-Terminal Pair, 1-m Extension	135
Fixture Compensation When the 16451B is Used	136
C. Calibration for Four-Terminal Pair, 2-m Extension	137
D. Calibration When an Exclusive Fixture is Connected to the 42942A	139
E. Calibration When the 7-mm Port of the 42942A is Extended	141
F. Calibration When a Probe Adapter is Connected to the 42941A	143
G. Calibration When the 3.5-mm Port of the 42941A is Extended	145
User Calibration	147
User Calibration Procedure	147
Turning User Calibration On/Off	148
Defining Standard Values for User Calibration	148
Port Extension Compensation	150
Fixture Compensation	151
Fixture compensation procedure	151
Turning the fixture compensation on or off	153
Defining the standard values for fixture compensation	153
Selecting Calibration/Compensation Data Points	155
List of fixed calibration/compensation frequency points	156
7. Setting Up the Display of Measurement Results	
Selecting the Measurement Parameters	158
Selecting the Graph Axis Format	160
When Using Cartesian Coordinates	160
When Using Complex Parameters (COMPLEX Z-Y)	162
Auto-scaling the Trace	164
Manual Scale Setting (for measurements other than COMPLEX Z-Y)	166
Scaling the Trace Based on the Reference Line and Resolution per Division	166
Scaling the Trace Based on the Top and Bottom Values	169
Manually Scaling the Active Trace for a COMPLEX Z-Y Graph	172
Scaling the Active Trace for a Complex Plane	172
Scaling the Active Trace for a Polar Chart	175
Selecting the Target Trace Type (Data or Memory)	177
Enabling or Disabling Coupled Scaling Mode	178
Trace-based Comparison and Calculation	179
Identifying Differences between Data and Memory Traces through Comparison or Calculation	179
Subtracting an Offset Value	184
Superimposing Multiple Traces	185
Comparing traces using the list sweep function	186
Monitoring the Test Signal Level (AC)	189

Monitoring the Test Signal Level on a Real-time Basis	189
Using the Marker Feature to Determine the Test Signal Level	190
Monitoring the dc Bias Level	193
Monitoring the dc Bias Level on a Real-time Basis	193
Using the Marker Feature to Determine the dc Bias Level	194
Selecting the Phase Unit	197
Displaying Phase Values without Wrapping at $\pm 180^\circ$	198
Hiding the Non-active Trace	199
Splitting the Graph	200
Configuring the Screen Assignments for HP Instrument BASIC	202
Adding a Title to the Measurement Screen	205
Customizing Intensity and Color Settings for Screen Display	207
Setting the Foreground Intensity	207
Adjusting the Background Intensity	207
Customizing the Color of Each Screen Item	208
Resetting All Items to Factory Default Colors	210

8. Analysis and Processing of Result

Specify the sweep parameter value and read the value on the trace	212
Listing data at several points on the trace	214
Displaying several marker positions using softkey labels	214
Listing the marker positions with the marker list function	215
Reading the difference from the reference point on the screen (delta marker)	217
Placing the delta marker on the reference point with the main marker	217
Moving the delta marker alone to place it at a reference point	218
Displaying the main/sub-marker and reading the difference from the reference point	219
Reading actual measurement points only/reading interpolated values between measurement points	222
Search the maximum/minimum measurements	223
Search the point of target measurement	225
Search the maximum/minimum peak	228
Define the Peak	232
Definition of peak polarity	232
Define peak sharpness	233
Define peak sharpness using a peak on the trace	233
Automatically performing search for each sweep (search tracking)	235
Analyze trace bandwidth	236
Definitions of parameters in the trace bandwidth analysis	236
Define the cutoff point in trace bandwidth analysis	238
Setting the delta marker in the trace bandwidth analysis	239
Implement trace bandwidth analysis	240
Set the marker separately for either trace A or B	243
Selecting target trace (data or memory) for marker analysis	244
Selecting the sweep parameter value of the marker display as time from start or relaxation time	245
Clearing (turning off) the marker from the screen	247
Turning off the sub-markers	247
Turning off the delta marker	247
Turning off all (main/sub/delta) markers at one time	248
Calculate the equivalent circuit parameter and simulate the frequency characteristics	249
Calculate the equivalent circuit parameter based on the measurement result	249

Simulate the frequency characteristics based on the equivalent circuit parameter	252
Calculating the mean value, standard deviation, and peak-to-peak of the trace	254
Set a limit to the trace and make pass/fail evaluation	256
Set the limit line	256
Conduct the limit line test	262
Move the limit line in vertical and horizontal directions on the screen	264
Specify partial search range	267
When sweep type is other than list sweep:	267
When the sweep type is list sweep:	269
Save and Recall the Agilent 4294A Internal Data	270
Agilent 4294A internal data flow	270
Save the setting state, calibration data and memory array (State Save)	271
Save the calibration data and trace data (Data Save)	273
Using files saved in the text (ASCII) format with the data save function	275
Saving a data array in touchstone format	285
Using a file saved in touchstone format	286
Saving display screen (GRAPHICS save)	288
Overwrite on the file to be saved	290
Create a file for automatic setting when power is on	291
Recall the saved file	292
Print the measurement results and internal data with a printer	294
Set the print form (color, resolution and how to handle the paper)	294
Print the measurements in graphic representation	296
Print the measurements and settings (text)	296

9. Setting/Using Control and Management Functions

Re-displaying an Instrument Message	300
Setting/Checking the Internal Clock	301
Setting/Checking the Date	301
Setting/Checking the Time	302
Setting the Built-in Speaker (Beep Sound)	304
Turning On/Off the Completion Beep	304
Turning On/Off the Warning Beep	304
Managing Files	305
Creating a Directory	305
Copying a File	307
Deleting a File or Directory	310
Initializing a Recording Medium	311
Setting/Checking the GPIB	313
Switching between the System Controller Mode and Addressable-only Mode	313
Setting/Checking the GPIB address	313
Setting/Checking the LAN	314
Setting/Checking the IP Address	314
Setting/Checking the Gateway Address	315
Setting/Checking the Subnet Mask	317
Checking the MAC Address	318
Checking the Firmware Version	319
Checking by Key Operation	319
Checking by Powering On Again	319

Performing Self-Diagnosis of the Agilent 4294A	320
Performing the Internal Tests in a Batch Process	320
Checking the Result of Each Test	320
10. Specifications and Supplemental Performance Characteristics	
Basic Characteristics	324
Measurement Parameter	324
Measurement Terminal	324
Source Characteristics	324
dc Bias Function	326
Sweep Characteristics	328
Measurement Time	329
Trigger Function	329
Measurement Bandwidth/Averaging	329
Adapter Setup	330
Calibration	330
Measurement Accuracy	330
Display Functions	344
Marker Functions	344
Equivalent Circuit Analysis	345
Limit Line Test	345
Mass Storage	345
Parallel Printer Port	345
GPIB	346
HP Instrument BASIC	346
8-Bit I/O Port	346
24-bit I/O Port (Handler Interface)	346
LAN Interface	348
General Characteristics	349
External Reference Input	349
Internal Reference Output	349
High Stability Frequency Reference Output (Option 1D5)	349
External Trigger Input	349
External Program RUN/CONT Input	350
External Monitor Output	350
Operating Conditions	350
Non-operating Conditions	351
Other Specifications	351
Furnished Accessories	354
A. Manual Changes	
Manual Changes	356
Change 1	357
Change to the revision 1.0x	357
B. Key Definitions	
Functions of hardkeys	360
Softkeys displayed by pressing the [Meas] key	363

Contents

Softkeys displayed by pressing the [Format] key.	365
Softkeys displayed by pressing the [Display] key	366
Softkeys displayed by pressing the [Scale Ref] key.	373
Softkeys displayed by pressing the [Bw/Avg] key.	376
Softkeys displayed by pressing the [Cal] key.	378
Softkeys displayed by pressing the [Sweep] key	383
Softkeys displayed by pressing the [Source] key.	388
Softkeys displayed by pressing the [Trigger] key	390
Softkeys displayed by pressing the [Marker] key	392
Softkeys displayed by pressing the [Marker→] key	395
Softkeys displayed by pressing the [Search] key	397
Softkeys displayed by pressing the [Utility] key	402
Softkeys displayed by pressing the [System] key	404
Softkeys displayed by pressing the [Local] key.	415
Softkeys displayed by pressing the [Copy] key	417
Softkeys displayed by pressing the [Save] key	421
Softkeys displayed by pressing the [Recall] key	427
C. Error messages	
Error Messages (alphabetical order).	430
D. Initial Settings	
Initial Settings, Settings that can be Saved/Recalled, Settings that can be Backed Up	448

1 Installation

This chapter contains installation and setup instructions for the Agilent 4294A Precision Impedance Analyzer. For information on connecting test accessories such as a test fixture, adapter, probe, or measurement cable, refer to Chapter 4 , “Preparation of Measurement Accessories.”

Incoming Inspection

WARNING

To avoid hazardous electrical shock, do not turn on the Agilent 4294A if there are signs of shipping damage to any portion of the outer enclosure (for example, covers, panel, or display).

Check the shipping container for damage. If the shipping container or cushioning material is damaged, it should be kept until the contents of the shipment have been checked for completeness and the Agilent 4294A has been checked mechanically and electrically. The contents of the shipment should be as listed in Table 1-1.

If the contents are incomplete, there is any mechanical damage or defect, or the analyzer's power-on self-test fails, contact the nearest Agilent Technologies office. If the shipping container is damaged or the cushioning material shows signs of unusual stress, notify the carrier as well as the Agilent Technologies office. Save the shipping materials for the carrier's inspection.

Table 1-1 Contents of the Agilent 4294A package

Agilent product/part number ¹	Description	Quantity
4294A	4294A Precision Impedance Analyzer	1
04294-900x0	Operation Manual (this guide) ²	1
04294-900x1	Programming Manual ²	1
E2083-90005	HP Instrument BASIC User's Handbook ²	1
04294-905xx	CD-ROM (of the manual) ³	1
04294-901x0	Service Manual ⁴	1
04294-180x0	Sample Program Disk (3.5-inch floppy disk)	1
04294-61001	100 Ω resistor (for adapter setup)	1
—	Mini-DIN keyboard ⁵	1
—	Power Cable ⁶	1
1250-1859	BNC Adapter ⁷	1
5063-9229	Handle Kit ⁸	1
5063-9216	Rack Mount Kit ⁹	1
5063-9223	Rack Mount & Handle Kit ¹⁰	1

1. The number of “x” in the part number of each manual or sample program disk, 0 for the first edition, is incremented by 1 each time a revision is made. The latest edition comes with the product.
2. Not supplied unless the product is purchased with Option ABA.
3. The CD-ROM contains the same information as in the *Operation Manual, Programming Manual* and Sample Program Disk.
4. Not supplied unless the product is purchased with Option 0BW.
5. Not supplied unless the product is purchased with Option 810 (with keyboard).
6. This accessory varies from country to country. For the power cable option, see Figure 1-2.
7. Not supplied unless the product is purchased with option ID5 (High Stability Frequency Reference)
8. Not supplied unless the product is purchased with Option 1CN.
9. Not supplied unless the product is purchased with option 1CM.
10. Not supplied unless the product is purchased with Option 1CP.

Precautions to Take Before Setting Up the Power Supply

Before supplying electrical power to the Agilent 4294A, make sure that the correct fuse is selected. Be sure to use a power source that meets the specifications listed later in this section.

Setting Up and Replacing the Fuse

The Agilent 4294A requires the following fuse:

UL/CSA type, time delay, 5 A 250 Vac (Agilent part number 2110-0030)

Spare fuses are available from your nearest Agilent Technologies Sales and Service Office. You can check and replace the fuse by dismantling the fuse folder shown in Figure 1-1. To dismantle the fuse holder, first disconnect the power cable, then use a flat-blade screwdriver or similar tool to push the portion marked “a” in Figure 1-1 upward so that the holder surface rises up a little, and finally pull off the holder.

Figure 1-1

Fuse holder and power inlet

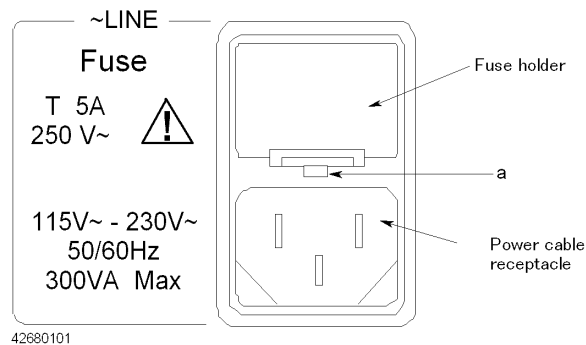

Power Source Requirements

The Agilent 4294A requires a power source that meets the following specifications.

Voltage:	90 to 132 Vac or 198 to 264 Vac (auto select)
Frequency:	47 to 63 Hz
Power consumption:	300 VA (max)

Power Cable

In accordance with international safety standards, the Agilent 4294A uses a three-wire power cable. When connected to an appropriate ac power outlet, this cable grounds the instrument frame through one of the three wires.

The type of power cable shipped with each instrument depends on the country of destination. Refer to Figure 1-2 for the part numbers of the power cables available.



WARNING

For protection against electrical shock, the power cable grounding prong must not be removed.

The power plug must be plugged into an outlet that provides an appropriate receptacle for the ground connection.

Installation
Power Cable

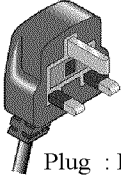
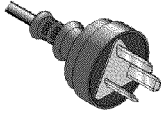
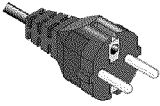
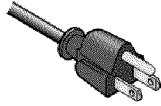
Figure 1-2 Alternative Power Cable Options

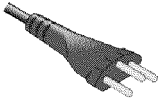
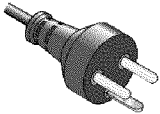
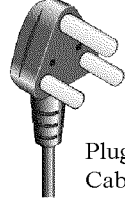
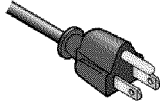
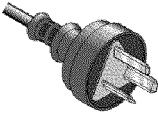
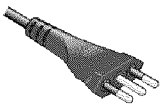
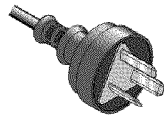
<p>OPTION 900</p>  <p>Front</p> <p>Plug : BS 1363/A, 250V, 10A Cable: 8120-1351</p>	<p>OPTION 901</p>  <p>Australia/ New Zealand</p> <p>Plug : AS 3112, 250V, 10A Cable: 8120-1369</p>
<p>OPTION 902</p>  <p>Continental Europe</p> <p>Plug : CEE 7 Standard Sheet VII, 250V, 10A Cable: 8120-1689</p>	<p>OPTION 903</p>  <p>U.S./ Canada</p> <p>Plug : NEMA 5-15P, 125V, 10A Cable: 8120-1378</p>
<p>OPTION 904</p>  <p>U.S./ Canada</p> <p>Plug : NEMA 6-15P, 250V, 6A Cable: 8120-0698</p>	<p>OPTION 906</p>  <p>Switzerland</p> <p>Plug : SEV Type 12, 250V, 10A Cable: 8120-2104</p>
<p>OPTION 912</p>  <p>Denmark</p> <p>Plug : SR 107-2-D, 250V, 10A Cable: 8120-2956</p>	<p>OPTION 917</p>  <p>India/ Republic of S.Africa</p> <p>Plug : IEC 83-B1, 250V, 10A Cable: 8120-4211</p>
<p>OPTION 918</p>  <p>Japan</p> <p>Plug : JIS C 8303, 125V, 12A Cable: 8120-4753</p>	<p>OPTION 920</p>  <p>Argentina</p> <p>Plug : Argentine Resolution 63, Annex IV, 250V, 10A Cable: 8120-6870</p>
<p>OPTION 921</p>  <p>Chile</p> <p>Plug : CEI 23-16, 250V, 10A Cable: 8120-6978</p>	<p>OPTION 922</p>  <p>China</p> <p>Plug : GB 1002, 250V, 10A Cable: 8120-8376</p>

If you want to use a power cable other than the supplied one, contact your nearest Agilent sales office for information.

4287a0j005

Connecting the BNC Adapter (for Option 1D5 Only)

When Option 1D5 is installed, connect the BNC cable that comes with this option between the REF OVEN and EXT REF INPUT connectors on the rear panel of the Agilent 4294A. Option 1D5 makes the frequency of the Agilent 4294A's test signal both more stable and more accurate.

Figure 1-3

Connecting the BNC Adapter (for Option 1D5 Only)

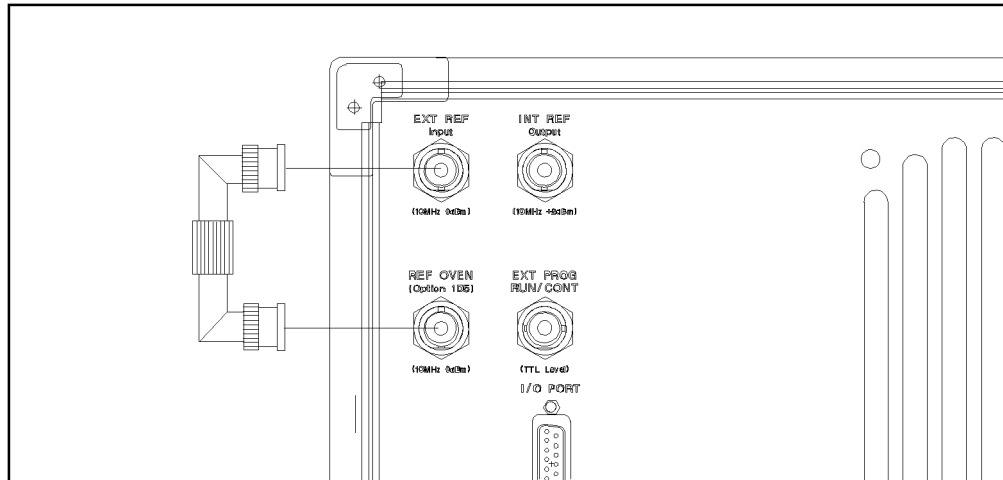

4294AIJ001

Using the LAN Port

You can connect the Agilent 4294A to a local area network by using the RJ-45J UTP (Unshielded Twisted Pair) LAN connector provided on the rear panel.

- Step 1.** To connect the 4294A to a LAN, securely insert the LAN cable into the LAN port.
- Step 2.** For the 4294A to communicate over a LAN, you must set up the network connection as described in the section “Using LAN” in the “Programming Manual.”

Figure 1-4

Using the LAN Port

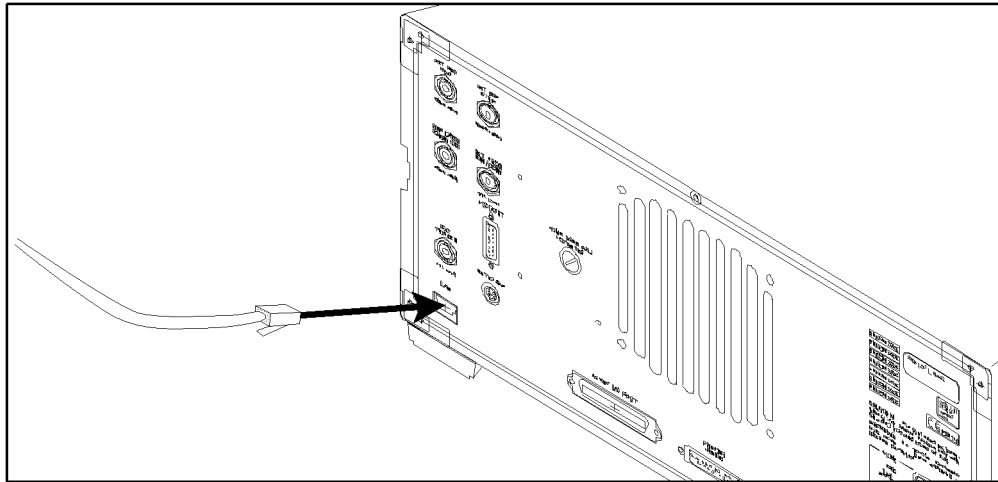

4294AIJ006

Connecting the Keyboard¹

Step 1. Insert the cable of the Mini-DIN keyboard into the keyboard connector on the rear panel.

Step 2. Set the keyboard in a comfortable position.

NOTE

Do not put anything on the keyboard. Doing so can cause an error during the power-on self-test.

Figure 1-5 Connecting the Supplied Keyboard

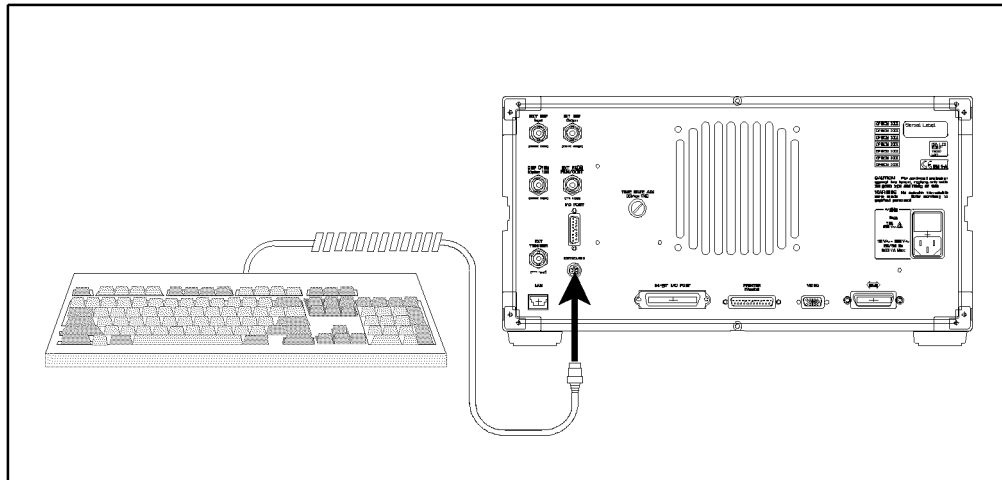

4294AIJ003

1. The Agilent 4294A comes with a keyboard if it is purchased with Option 810 (with keyboard).

Using a Rackmount Kit

If you want to combine the Agilent 4294A with other instruments and a controller to assemble a comprehensive measuring system, you can use one of the optional rackmount/handle kits to install it in an efficient way. Figure 1-6 shows how to install the rackmount kit.

Table 1-2

Rackmount/Handle Kits

Option ID	Description	Agilent part number
1CN	Handle Kit	5063-9229
1CM	Rackmount Kit	5063-9216
1CP	Rackmount & Handle Kit	5063-9223

Figure 1-6

Installing the Rackmount/Handle Kit

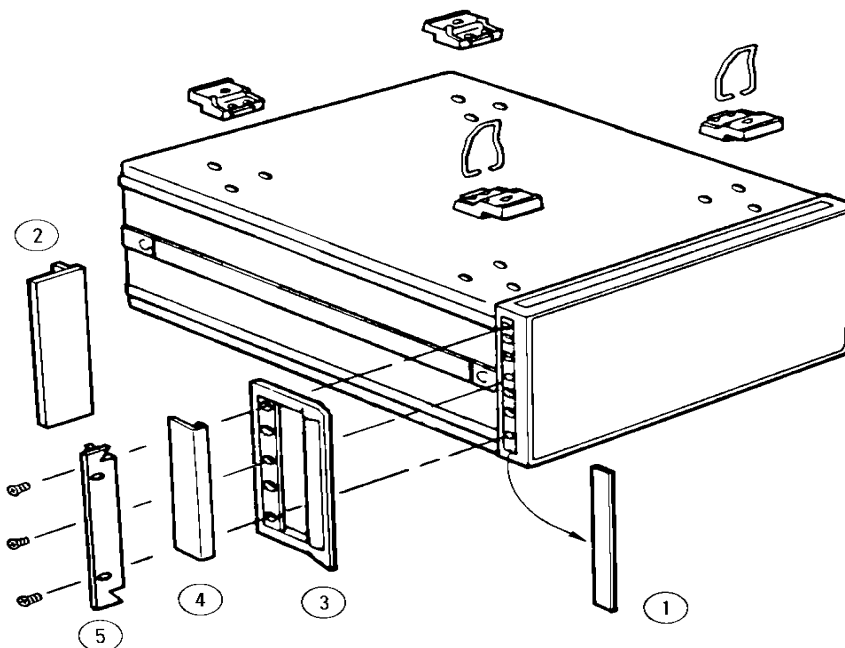

Option 1CN Handle Kit

Option 1CN includes a pair of handles and the parts necessary for attaching the handles to the Agilent 4294A.

Installing the Handles

- Step 1.** Remove the adhesive-backed trim strips (1) from the left and right side faces of the front panel frame (Figure 1-6).
- Step 2.** Attach the front handles (3) to the side faces with the supplied screws.

- Step 3.** Attach the trim strips (4) to the handles.

Option 1CM Rackmount Kit

Option 1CM includes a pair of flanges and the parts necessary for attaching them to the Agilent 4294A. With this option, you can mount the 4294A on an equipment rack with 482.6 mm (19 inch) horizontal spacing.

Mounting the Agilent 4294A on a Rack

- Step 1.** Remove the adhesive-backed trim strips (1) from the left and right side faces of the front panel frame (Figure 1-6 on page 26).
- Step 2.** Attach the flanges (2) to the side faces with the supplied screws.
- Step 3.** Remove all four legs from the bottom face by pulling up the tabs and sliding the legs out in the direction indicated by the arrows.
- Step 4.** Mount the 4294A on the rack.

Option 1CP Rackmount & Handle Kit

Option 1CP includes two flanges and two handles along with their attachments.

Mounting the Agilent 4294A on a Rack (with Handles)

- Step 1.** Remove the adhesive-backed trim strips (1) from the left and right side faces of the front panel frame (Figure 1-6 on page 26).
- Step 2.** Attach the handles (3) and flanges (5) to the side faces with the supplied screws.
- Step 3.** Remove all four legs from the bottom face by pulling up the tabs and sliding the legs out in the direction indicated by the arrows.
- Step 4.** Mount the 4294A on the rack.

Environmental Requirements

The Agilent 4294A is designed to operate under the following environmental conditions (with the floppy disk drive operational). For more information, refer to Chapter 10 , “Specifications and Supplemental Performance Characteristics,” on page 323.

Temperature: 10°C to 40°C
Humidity: 15% to 80% (relative humidity)

NOTE

The Agilent 4294A must be protected from temperature extremes that could cause condensation within the instrument.

Providing clearance to dissipate heat at installation site

To ensure adequate ventilation, make sure that there is adequate clearance of at least 180 mm behind the unit and 60 mm at each side.

To ensure the specifications and measurement accuracy of the product, you must keep ambient temperature around the product within the specified range by providing appropriate cooling clearance around the product or, for the rackmount type, by forcefully air-cooling inside the rack housing. For information on ambient temperature to satisfy the specifications and measurement accuracy of the product, refer to Chapter 10 , “Specifications and Supplemental Performance Characteristics,” on page 323.

When the ambient temperature around the product is kept within the temperature range of the operating environment specification (refer to “Operating Conditions” on page 350), the product conforms to the requirements of the safety standard. Furthermore, under that temperature environment, it has been confirmed that the product still conforms to the requirements of the safety standard when it is enclosed with cooling clearance as follows:

	Conditions
Rear	≥ 180 mm
Side	≥ 60 mm (both right and left)

Instructions for Cleaning

To prevent electrical shock, disconnect the Agilent 4294A's power cable from the power outlet before cleaning.

To clean the exterior of the Agilent 4294A, gently wipe the surfaces with a dry cloth or a soft cloth that is soaked with water and wrung tightly. Do not attempt to clean the 4294A internally.

2

Learning Operation Basics

This chapter guides you through a tour of the basic measurement functions of the Agilent 4294A Precision Impedance Analyzer. If you are new to the Agilent 4294A, this tutorial should help you get familiar with the instrument.

Required Equipment

To perform all of the steps in this tour, you must have the following equipment:

- Agilent 4294A Precision Impedance Analyzer (1 unit)
- 16047E Text Fixture for Lead Components (1 piece)
- DUT: Capacitor with lead wires having self-resonance frequency of 100 MHz or lower, such as a 0.1 μF ceramic capacitor (1 piece)

Figure 2-1

Required Equipment

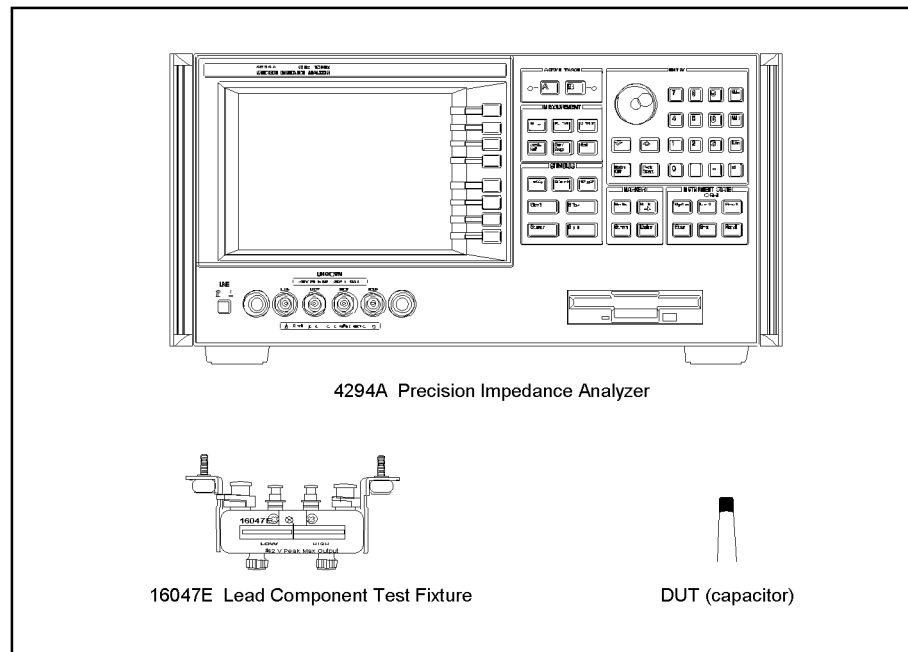

4294a0e006

Preparing for a Measurement

Prepare the Agilent 4294A for measurement by taking the following steps. This procedure assumes that the Agilent 4294A has been correctly installed and set up as described in Chapter 1 , “Installation,” on page 17.

Connect the Agilent 16047E Test Fixture

Connect the Agilent 4294A to the Agilent 16047E Test Fixture for Lead Components.

- Step 1.** Attach the 16047E test fixture to the test connectors on the front panel of the Agilent 4294A by gradually coupling the four BNC connectors and fastening screws of the fixture with the test connectors and accessory mounting holes of the instrument until they are in complete contact.
- Step 2.** Fasten two of the four BNC connectors to the corresponding test connectors by gradually turning the BNC connectors' rotation levers until each pair of connectors is securely connected. Be sure to align the grooves on both sides.
- Step 3.** Simultaneously turn the fixture's two fastening screws clockwise so that the fixture is secured to the instrument.
- Step 4.** Finally, secure the remaining two BNC connectors of the fixture by turning their rotation levers clockwise.

Figure 2-2 Connecting the Agilent 16047E Test Fixture

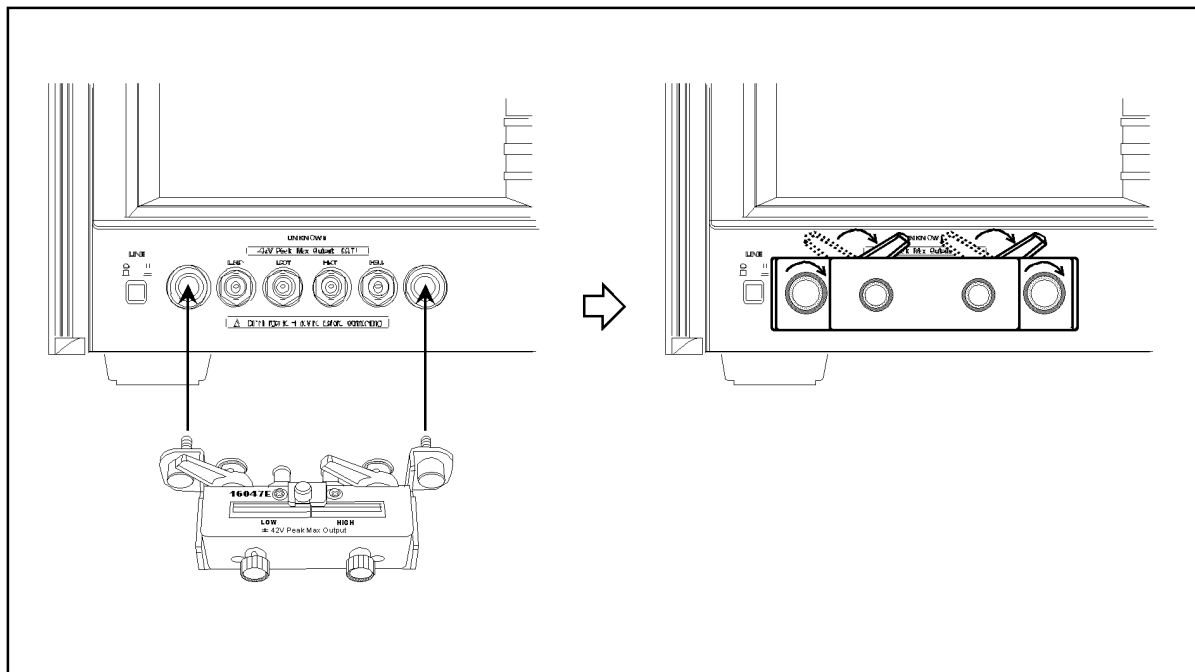

16047eoj0102

NOTE Reverse the above procedure when removing the Agilent 16047E Test Fixture.

Turn ON the Power

Press the power switch to turn on the power to the Agilent 4294A.

The Agilent 4294A performs a power-on self-test. During the self-test, the model name, firmware revision number/date, options, copyright notice, and other information appear on the LCD. When the self-test is completed, the measurement screen appears on the LCD.

Set the Adapter Type to “NONE”

Use the keystroke sequence **[Cal] - ADAPTER [] - NONE** to configure the Agilent 4294A to operate without an adapter.

This option must be selected when the Agilent 4294A is connected to a direct-coupling type test fixture such as the Agilent 16047E. With the adapter type set to “NONE,” the Instrument Status area on the measurement screen does not display the “EX1,” “EX2,” “7mm,” and “PRB” indicators.

NOTE

When you use the Agilent 4294A for actual applications, you may want to use an adapter such as a 7-mm conversion adapter (terminal adapter), cable, or probe. To do so, you must specify the appropriate adapter type and then perform a calibration procedure called “Adapter Setup,” in which you calibrate the Agilent 4294A for the connected adapter by measuring a specific calibration standard. However, because this example uses the Agilent 16047E, which is a direct-coupling fixture that does not require an adapter, you need not perform the “Adapter Setup” procedure in this tour.

For the Agilent 4294A to perform measurement, you must select the appropriate adapter type option. Whenever you start a new measurement session, you should check the indicator (“EX1,” “EX2,” “7mm,” “PRB,” or blank) shown in the Instrument Status area to confirm that the correct adapter type is selected. Do not forget to check the adapter type, particularly if you frequently reconnect the Agilent 4294A to a number of alternative adapters (including a 7-mm conversion adapter, probe, cable, test fixture, and so on).

Specifying Measurement Conditions

Next, you need to specify how your Agilent 4294A should perform measurement.

NOTE

Through this procedure, you will configure parameters that apply to both Traces A and B. You can set each parameter without specifying the active trace or checking its current setting.

Initialize the Agilent 4294A to the Preset State

Press the **[Preset]** key to initialize the Agilent 4294A.

This puts the Agilent 4294A into its preset state.

NOTE

If you turn on the Agilent 4294A with a power-on setting file residing on the flash memory (nonvolatile memory disk) or on a floppy disk inserted in the floppy disk drive, the file is automatically loaded, and the settings contained in the file are restored. Initializing the Agilent 4294A to its preset state ensures that no specific settings are inherited from the last measurement session. Therefore, you should initialize the Agilent 4294A by pressing the **[Preset]** key whenever you are configuring it for a new measurement session, regardless of whether you turned the instrument off and back on after the previous session.

Note that initializing the Agilent 4294A with the **[Preset]** key does not affect which type of adapter the instrument is configured to use. Once you have set the adapter type, the setting is retained until you select another adapter type.

Select $|Z|-\theta$ as the Measurement Parameter

To select the measurement parameter, follow these steps:

- Step 1.** Press the **[Meas]** key to display the Measurement Parameter menu.
- Step 2.** Make sure that the $|Z|-\theta$ key is selected (this key is selected by default in the preset state). With the $|Z|-\theta$ key selected, Trace A reflects the absolute impedance value while Trace B reflects the impedance phase.

Select Frequency as the Sweep Parameter

- Step 1.** Press the **[Sweep]** key to display the Sweep menu.
- Step 2.** Check the **PARAMETER []** softkey label to confirm that “**FREQ**” (frequency sweep) is shown between the brackets **[]** (this setting is selected by default in the preset state).

NOTE

The Sweep Parameter menu, which is not used in this tour, allows you to change the sweep parameter. You can access this menu by pressing the **PARAMETER []** key.

Select Logarithmic Sweep as the Sweep Type

- Step 1.** From the Sweep menu, select **TYPE []** to display the Sweep Type menu.

Learning Operation Basics

Specifying Measurement Conditions

Step 2. Press the **LOG** key to select Log (logarithmic) sweep.

Set the Sweep Start Value to 100 Hz

Step 1. Press the **[Start]** key. The current setting of the sweep start value appears in the Parameter Setting field in the upper-left area of the screen.

Step 2. Type “100” into the Parameter Setting field using these ENTRY block keys: **[1][0][0]**.

Step 3. Specify that the value does not take any unit by pressing the **[×1]** key in the ENTRY block. This puts your entry into effect.

Set the Sweep Stop Value to 100 MHz

Step 1. Press the **[Stop]** key. The current setting of the sweep stop value appears in the Measurement Parameter field in the upper-left area of the screen.

Step 2. Type “100” into the Parameter Setting field using these ENTRY block keys: **[1][0][0]**.

Step 3. Suffix your entry with “M” (mega) by pressing the **[M/m]** key in the ENTRY block. This puts your entry into effect.

Set the Measurement Bandwidth to 2

Step 1. Press the **[Bw/Avg]** key to display the Measurement Bandwidth/Averaging menu.

Step 2. Press the **BANDWIDTH []** key to display the Measurement Bandwidth Setting menu.

Step 3. Set the measurement bandwidth to 2 by pressing the **2** key.

Fixture Compensation

Next, you need to eliminate errors produced between the test fixture and the Agilent 4294A. This process is called “fixture compensation.” You can perform the process using three compensation functions: OPEN, SHORT, and LOAD.

NOTE

All calibration settings, including those established through fixture compensation, are applied to both Traces A and B. You can execute each compensation function without specifying the active trace or checking the current state.

Perform Fixture Compensation for the Open Circuit State

- Step 1.** Press the **[Cal]** key to display the Calibration menu.
- Step 2.** Press the **FIXTURE COMPEN** key to display the Fixture Compensation menu.
- Step 3.** Make sure that the two test electrodes, HIGH and LOW, of the connected test fixture (Agilent 16047E) are open. Be sure to fix the two electrodes in position by turning clockwise the fixture’s two electrode fastening screws.
- Step 4.** Press the **OPEN** key to measure the OPEN compensation data. While the instrument is measuring the compensation data, a message “WAIT--MEASURING STANDARD” is displayed in the Parameter Setting field in the upper-left area of the screen. Upon completion of measurement, the **OPEN on OFF** softkey label changes to **OPEN ON off**, indicating that the OPEN compensation function is turned on.

Perform Fixture Compensation for the Short Circuit State

- Step 1.** Remove the short bar (a metal plate for SHORT compensation) from the upper part of the Agilent 16047E by loosening the screws and then fit the short bar between the HIGH and LOW terminals of the Agilent 16047E. Secure the short bar with the two electrode fastening screws (Figure 2-3 on page 36).

Figure 2-3

Setting Up the Test Circuit for SHORT Compensation

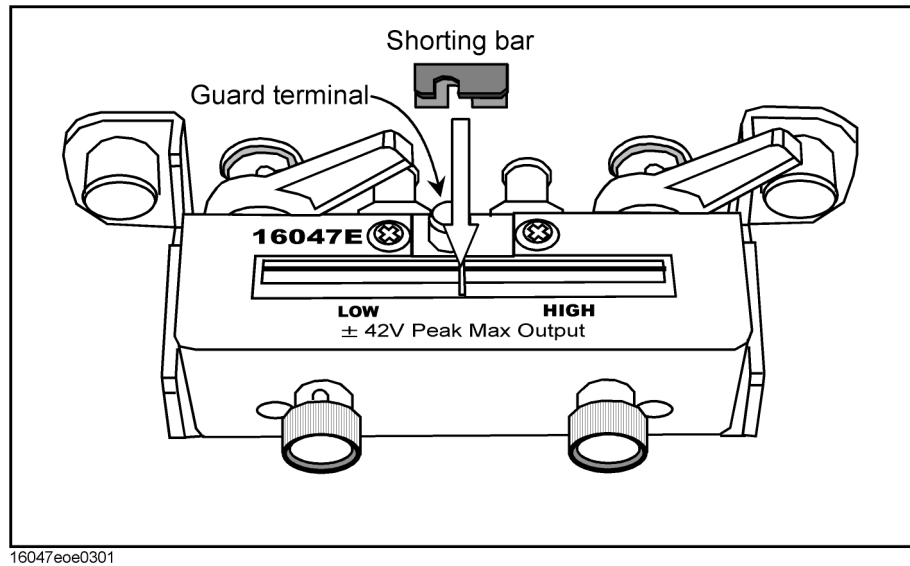

Step 2. Press the **SHORT** key to measure the SHORT compensation data. While the instrument is measuring the compensation data, a message “WAIT--MEASURING STANDARD” is displayed in the Parameter Setting field in the upper-left area of the screen. Upon completion of measurement, the **SHORT on OFF** softkey label changes to **SHORT ON off**, indicating that the SHORT compensation function is turned on.

Step 3. Remove the short bar from the Agilent 16047E's test electrodes.

NOTE

The Agilent 4294A provides three fixture compensation functions: OPEN, SHORT, and LOAD. You can turn on/off each of these compensation functions individually and use them in any combination to perform the fixture compensation process. In typical measurement use, it is recommended that you execute the OPEN and SHORT compensation functions.

Carrying Out Measurement and Viewing Results

Connect the DUT

- Step 1.** Increase the distance between the HIGH and LOW electrodes of the Agilent 16047E by turning their fastening screws counterclockwise.
- Step 2.** Fit the DUT's lead wires between the HIGH and LOW electrodes.
- Step 3.** Turn the fastening screws of the HIGH and LOW electrodes to secure the DUT's lead wires.

Figure 2-4

Connecting the DUT

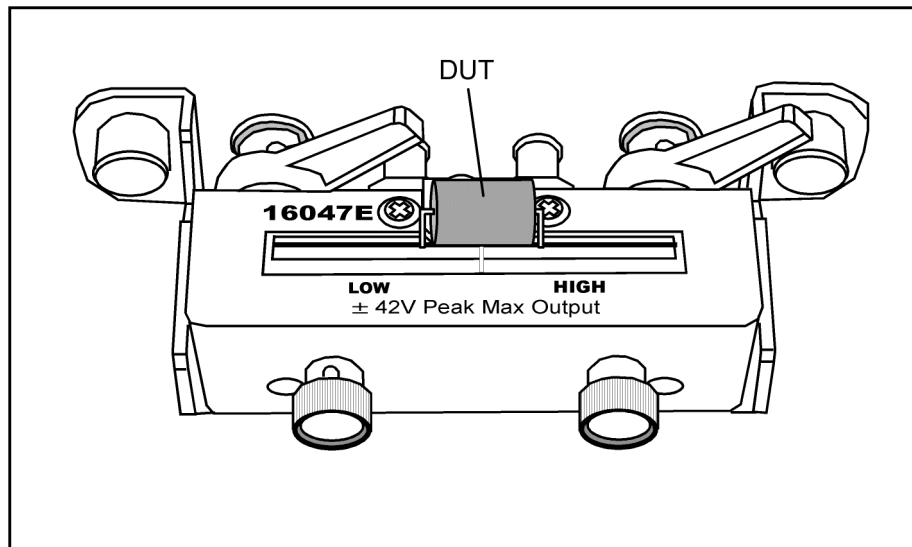

16047eoe0302

Figure 2-5

Measurement results displayed just after connecting the DUT

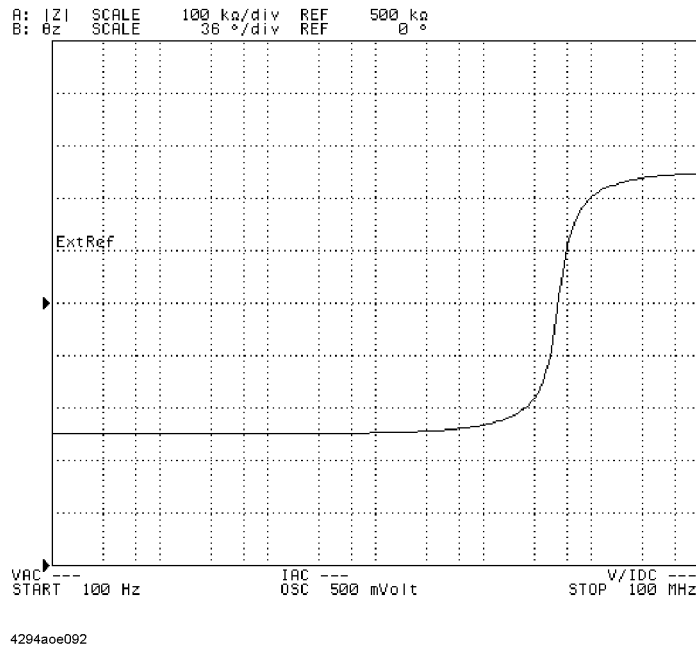

Apply the Logarithmic Format to the Vertical Axis for |Z|

- Step 1.** Make sure that Trace A is selected as the active trace (Trace A is active by default in the preset state).
- Step 2.** Press the **[Format]** key to display the Display Format menu.
- Step 3.** Press the **LOG** key to make the graph's vertical axis logarithmic.

Apply the Linear Format to the Vertical Axis for θ

- Step 1.** Press the **[B]** key to activate Trace B.
- Step 2.** Make sure that the graph's vertical axis is in the linear format with the **LIN** key selected (this setting is selected by default in the preset state).

Figure 2-6

Result of Applying the Logarithmic Format to the Graph

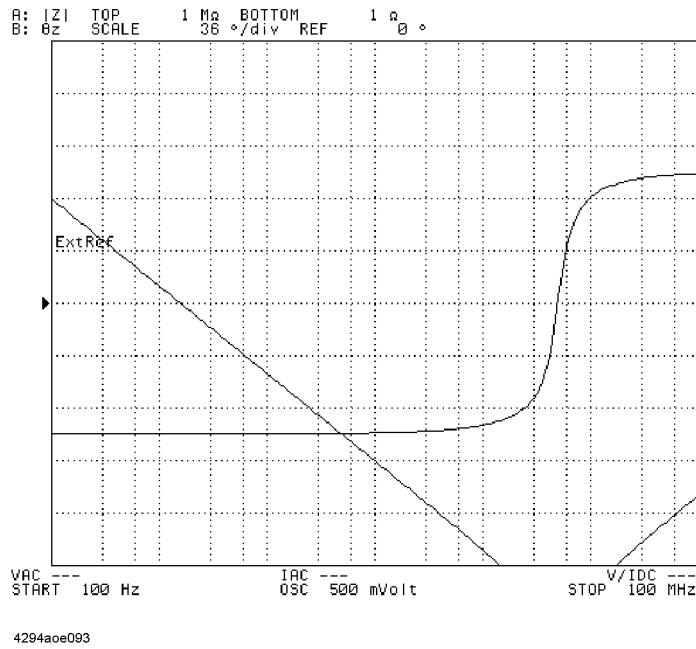

Display the Measured $|Z|$ and θ Values in Parallel

- Step 1.** Press the **[Display]** key to display the Display menu.
- Step 2.** Press the **SPLIT on OFF** key to split the screen into upper and lower halves (the key label should change to **SPLIT ON off**).

Figure 2-7

Displaying Traces A and B in Parallel

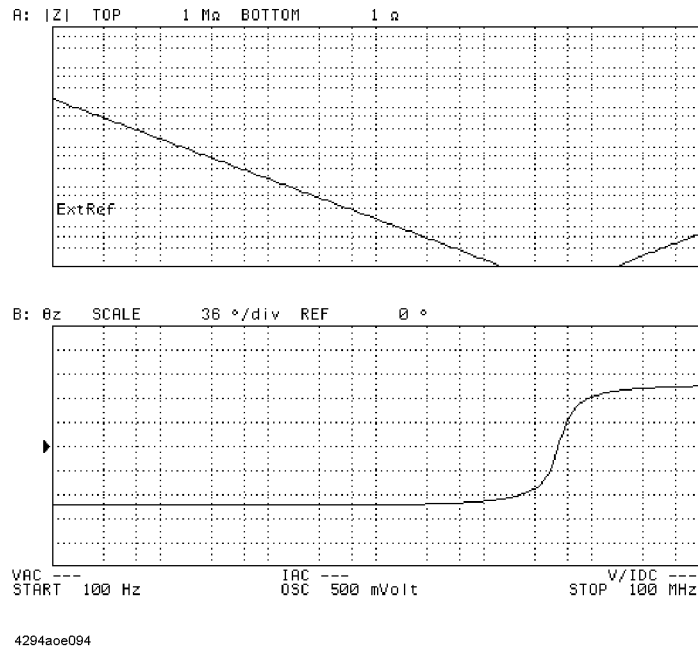

NOTE

You do not need to check which trace is active when you split the screen because this setting is applied to both Traces A and B.

Auto-scale the |Z| Trace

- Step 1.** Press the **[A]** key to activate Trace A.
- Step 2.** Press the **[Scale Ref]** key to display the Scale Reference menu.
- Step 3.** Press the **AUTO SCALE** key to auto-scale the trace for |Z|.

Auto-scale the θ Trace

- Step 1.** Press the **[B]** key to activate Trace B.
- Step 2.** Press the **AUTO SCALE** key to auto-scale the trace for θ .

Figure 2-8

Results of Auto-scaling

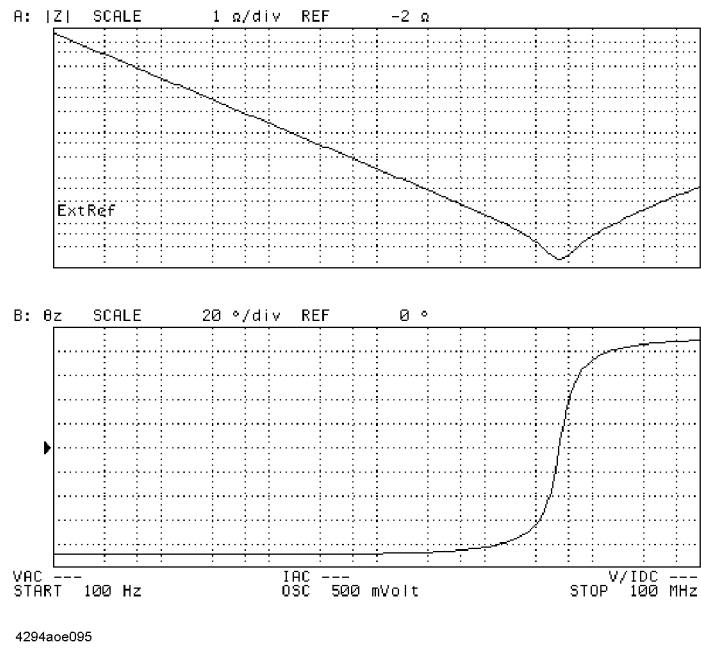

Results of Analysis

Determine the Self-resonance Frequency and Resonant Impedance

- Step 1.** Press the **[A]** key to activate Trace A.
- Step 2.** Press the **[Search]** key to display the Search menu. The main marker (a trace marker identified by number 0) appears in the center of the graph.
- Step 3.** Press the **SEARCH TRK on OFF** key to turn on the search tracking function (the key label should change to **SEARCH TRK ON off**). When this function is enabled, the instrument performs a search action upon completion of each sweep cycle.
- Step 4.** Press the **MIN** key to move the main marker to the minimum $|Z|$ value. Since the search tracking function is enabled, the instrument detects and moves the main marker to the minimum $|Z|$ value each time it has completed one sweep cycle.

You can determine the self-resonance frequency and resonant impedance by reading the sweep parameter (frequency) and measurement parameter values indicated by the main marker that appears in the upper-left area of the graph for Trace A. In the example shown in Figure 2-9, the DUT exhibits its self-resonance frequency and resonant impedance at approximately 5.13 MHz and 155 m Ω , respectively.

Figure 2-9

Result of Searching for the Self-Resonance Frequency (with the Search Tracking Function On)

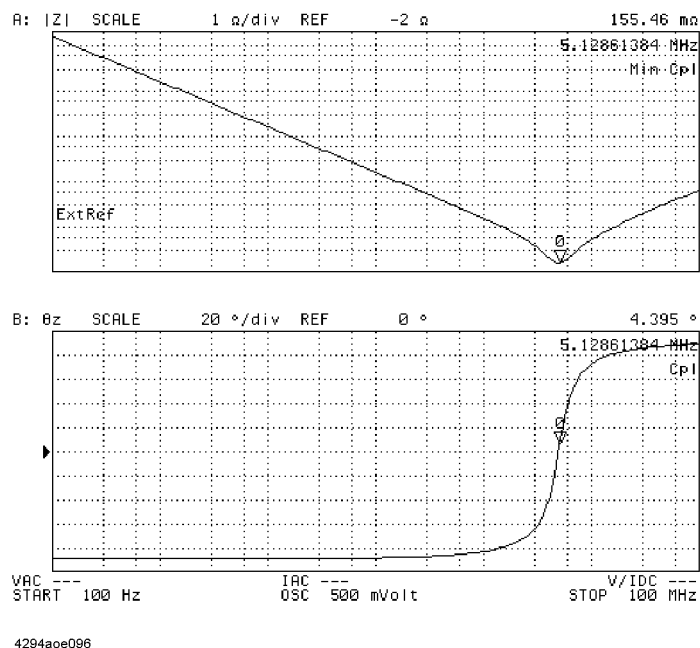

3

Front/Rear Panel and LCD Display

This chapter covers the features of the front and rear panels of the Agilent 4294A. It contains illustrations and descriptions of the front panel features, the LCD display and its labels, and the rear panel connectors.

Front Panel

The front panel of the Agilent 4294A provides several blocks of hardkeys and an LCD display with a series of softkeys along its right-hand edge. Also, there are a number of test connectors and a power switch beneath the LCD display. Figure 3-1 shows the front panel of the Agilent 4294A.

Figure 3-1

Front Panel of the Agilent 4294A

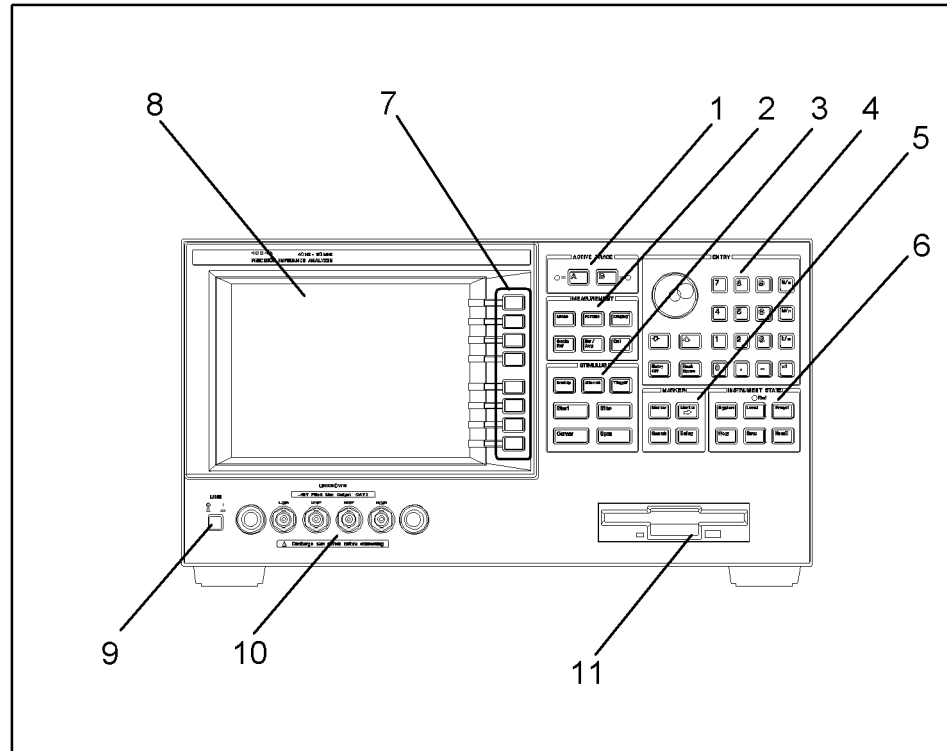

4294A1E004

Hardkeys

The hardkeys are 46 physical keys located on the upper-right part of the front panel; they are divided into six functionally classified blocks (#1 to #6 in Figure 3-1). Each hardkey is labeled with text that describes its function. The eight keys laid out vertically along the right-hand edge of the LCD display are called “softkeys” to distinguish them from the hardkeys. Note that the term “hardkey” refers to all of the controls within each of the six key blocks, including the circular-shaped rotary knob (○) in the Entry block.

A hardkey either directly controls the functions of the Agilent 4294A, provides access to softkey menus, or both.

NOTE

As a typographic convention to distinguish between hardkeys and softkeys, this manual uses a pair of brackets ([]) to enclose hardkey labels while showing softkey labels without enclosing them.

[Hardkey] key Indicates a hardkey labeled “Hardkey.”

Softkey key Indicates a softkey labeled “Softkey.”

Note that descriptive text in this manual sometimes only indicates key labels without following them by the word “key.”

When several keys are separated by a hyphen (-), press them in the sequence indicated. For example, you should use the keystroke sequence **[Scale Ref] - AUTO SCALE** to enable automatic scale adjustment. As an exception, numeric keys may appear without a hyphen in between; for example, the keystroke sequence to enter a value of 100 may be expressed as **[1][0][0]**.

1. ACTIVE TRACE block

With the Agilent 4294A, you can view two traces (waveforms) for each sweep cycle: Trace A and Trace B. Some parameters, such as the sweep range, apply to both traces, while other parameters can be separately configured for each trace. You can use the **[A]** or **[B]** key in the Active Trace block to choose between Traces A and B. Once you have activated either trace, you can configure measurement conditions and perform analysis on that “active” trace. When you set measurement conditions, be aware of which trace is currently active.

[A] key Activates Trace A so you can set conditions and perform analysis on Trace A.

[B] key Activates Trace B so you can set conditions and perform analysis on Trace B.

2. MEASUREMENT Block

This block provides keys for configuring all measurement conditions except the test signal settings.

[Meas] key Provides access to a softkey menu that lets you select measurement parameters.

[Format] key Provides access to softkey menus that let you select the data display format (graph axis format) and set up the phase display unit and phase expansion feature.

[Display] key Provides access to softkey menus that let you configure general display options (except the display format and scale setting) and perform equivalent circuit analysis.

[Scale Ref] key Provides access to a softkey menu that lets you configure graph scale settings.

Front Panel

[Bw/Avg] key	Provides access to a softkey menu that lets you configure the bandwidth and averaging settings.
[Cal] key	Provides access to a softkey menu that lets you set up the calibration feature.

3. STIMULUS Block

This block provides keys for configuring the test signal parameters.

[Sweep] key	Provides access to a softkey menu that lets you configure the sweep settings for the test signals.
[Source] key	Provides access to a softkey menu that lets you configure the frequency (CW frequency), test signal level, and dc bias conditions. When you are setting a sweep parameter, you can use the [Start] , [Stop] , [Center] , and [Span] keys to set the sweep range.
[Trigger] key	Provides access to a softkey menu that lets you set up the trigger system.
[Start] key	Lets you specify the value at which to start the sweep.
[Stop] key	Lets you specify the value at which to stop (finish) the sweep.
[Center] key	Lets you specify the sweep center value.
[Span] key	Lets you specify the sweep span value.

4. ENTRY Block

Provides keys for entering numeric values and text strings. To configure a parameter, first press the hardkey or softkey associated with the parameter to put the instrument into entry mode, in which it can accept your entry with the name and current value of the parameter shown in the upper-left area of the LCD display, and then use these keys to enter the desired value.

○ (rotary knob)	You can adjust the current setting by turning this knob. This method immediately updates the parameter value without requiring you to press a unit key. When working with a particular configuration item, you can also use the rotary knob to move the cursor horizontally.
[↑] and [↓] keys (step keys)	The step keys allow you to increment or decrement the current setting. This method immediately updates the parameter value without requiring you to press a unit key.
[Entry Off] key	This key switches the instrument from entry mode to normal operation mode with the name and current setting of the parameter no longer shown in the upper-left area of the LCD display.

[Back Space] key	Deletes the character to the left of cursor and moves the cursor back one space. If you make a mistake in entering a value through numeric keys, you can use this key to correct your entry.
[0] through [9] keys (numeric keys) with [.] and [-] keys	Use these keys to enter each numeral that makes up your entry. Finally, press a unit key to put your entered value into effect.
[G/n][M/μ][k/m][×1] keys (unit keys)	After entering your desired value through numeric keys, press one of the unit keys to suffix the value with the specific unit. Your entered value does not take effect until you press a unit key. Each unit key, except the [×1] key, represents two different units, identifying them with their respective initial letters. Which unit to use is automatically determined based on the selected parameter. Use the [×1] key to enter a value that does not take a specific unit.

5. MARKER Block

The MARKER block provides keys for configuring marker settings. A marker is an inverted triangle (▽) that appears on the measurement trace (waveform). The marker allows you to read the value of a parameter at a specific point on the trace.

[Marker] key	Provides access to a softkey menu that lets you configure the basic marker settings such as turning on/off the marker facility.
[Marker→] key	Provides access to a softkey menu that lets you assign the currently marked value to another parameter. From the softkey menu, for example, you can select the MKR→START key to use the sweep parameter value at the current marker position as the value at which to start the sweep; this way, you can start a new sweep cycle from the current marker position.
[Search] key	Provides access to a softkey menu that lets you activate the marker search function. The marker search function automatically moves the marker to a specific position (such as the maximum value) on the trace so you can check the value of the parameter at that position.
[Utility] key	Provides access to a softkey menu that lets you activate other marker functions in addition to the marker value assignment ([Marker→]) and marker search ([Search]) functions.

6. INSTRUMENT STATE Block

Provides keys for configuring basic instrument settings that are not directly related to

Front/Rear Panel and LCD Display

Front Panel

measurement or analysis.

[System] key	Provides access to a softkey menu that lets you control and manage the entire instrument. You can also set up the limit line test function.
[Local] key	Pressing this key switches the Agilent 4294A from remote mode (in which it is controlled by an external controller) to local mode (in which it accepts keystrokes from its front panel). While the instrument is in remote mode, the “Rmt” LED above this key is lit. This key also provides access to a softkey menu that lets you configure the GP-IB and LAN settings.
[Preset] key	Initializes the Agilent 4294A to its preset state. No softkey menu is displayed after you put the instrument into the preset state by pressing this key, but you can display a softkey menu by pressing one of the hardkeys associated with softkey menus.
[Copy] key	Provides access to a softkey menu that lets you control how to output the screen contents to the printer.
[Save] key	Provides access to a softkey menu that lets you save such information as the current settings, measurement data, and screen contents to the storage device of the Agilent 4294A.
[Recall] key	Provides access to a softkey menu that lets you recall (load) a state file from the storage device of the Agilent 4294A to restore the settings and measurement data stored in the state file.

7. Softkeys

The softkeys are eight keys located along the right-hand edge of the LCD display. Pressing a hardkey displays a menu of labels that define the functions of the softkeys. For more information on softkey labels, refer to “5. Softkey Label Area” on page 54.

8. Color LCD Display

Displays nearly all information necessary for using the Agilent 4294A, including measurement results (trace data), instrument status, analysis results, and softkey labels.

9. Power Switch

Turns on/off the power to the instrument. When you turn on the Agilent 4294A, it is initialized to its power-on defaults, with no softkey menu shown on the screen. From this state, you can display a softkey menu by pressing a specific hardkey. Note that if you turn on the instrument with a power-on setting file (AUTOREC.STA) residing on the flash memory (nonvolatile memory disk) or on a floppy disk inserted in the floppy disk drive, the file is automatically loaded, and the settings contained in the file are restored.

10. UNKNOWN Terminals

These connectors let you connect the instrument with a device under test (DUT) via test accessories (such as an adapter, test fixture, or cable). These accessories adopt a four-terminal pair design, thereby enabling more accurate and wider-range dynamic measurements. Each test connector has a pair of holes for securing the test accessory to the instrument.

INSTALLATION CATEGORY I

CAUTION



To prevent failure, do not apply dc voltage or current to the UNKNOWN terminal. Special care must be taken with capacitors since they may be charged. Be sure to connect the DUT to the UNKNOWN terminal (or test fixture) only after discharging them sufficiently.

11. Built-in 3.5 Inch Floppy Disk Drive

Allows you to store and retrieve such data as measurement data, instrument settings, screen contents, and HP Instrument BASIC programs. This drive uses a 3.5-inch, MS-DOS format floppy disk of 1.44 MB capacity.

Rear Panel

Figure 3-2

Rear Panel

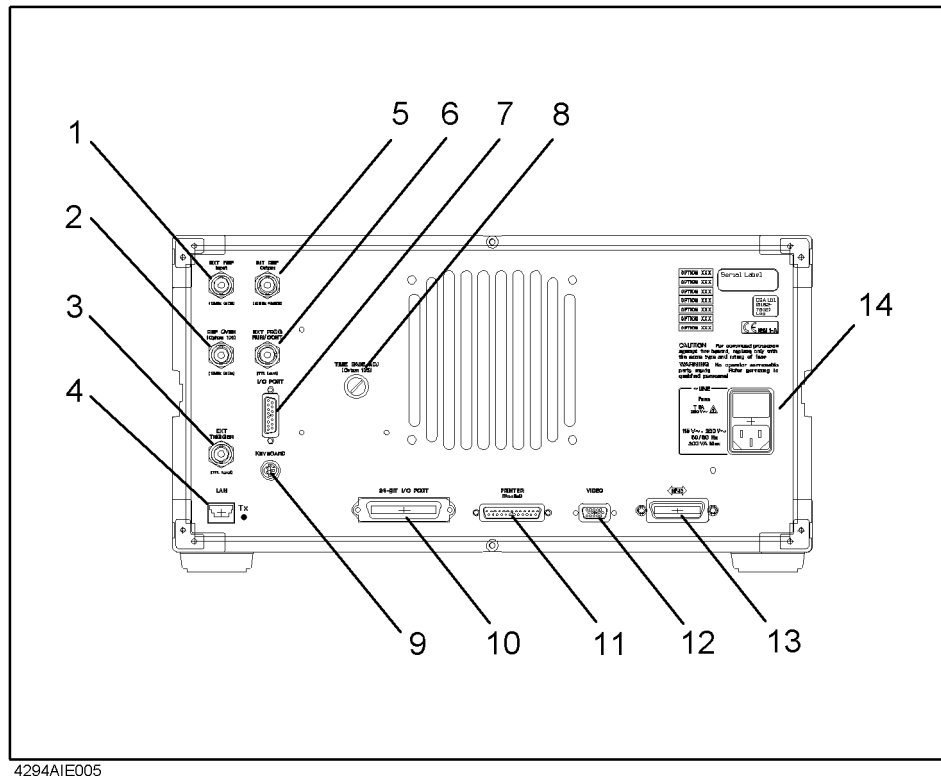

1. External Reference Input Connector

Allows you to connect an external frequency reference signal to the Agilent 4294A so that its internal signal is phase locked to the external frequency reference signal to achieve a more accurate frequency.

If Option 1D5 (High Stability Frequency Reference) is installed, connect the supplied BNC(m)-BNC(m) adapter between this connector and “2. High Stability Frequency Reference (Option 1D5 Only)”.

When an external frequency reference signal is input to this connector, the Agilent 4294A's test signal is automatically phase locked to that reference signal. When the reference signal stops, the Agilent 4294A will automatically revert to its internal frequency reference signal.

2. High Stability Frequency Reference (Option 1D5 Only)

This connector is intended for Option 1D5 (High Stability Frequency Reference) to output the reference signal. If Option 1D5 is installed, connect the supplied BNC(m)-BNC(m) adapter between this connector and “1. External Reference Input Connector”.

3. External Trigger Input

Allows you to input a TTL-compatible signal to trigger the execution of measurement. When the signal shows a rising or falling edge between the LOW and HIGH states, a measurement cycle is triggered. Before you can trigger measurement by inputting a signal through this connector, you have to specify that the trigger signal be input from an external trigger source (via the external trigger input). To do so, use the keystrokes: **[Trigger] - SOURCE [] - EXTERNAL**. For more information on the input signal conditions specific to this connector, refer to Chapter 10 , “Specifications and Supplemental Performance Characteristics,” on page 323.

4. LAN Port

Allows you to connect the Agilent 4294A with a local area network (LAN). The “Tx” (transmit) LED located on the right-hand side of the LAN port is lit while the Agilent 4294A is outputting data over the local area network. For more information on working with a local area network, refer to the *Programming Manual*.

5. Internal Reference Output

Connects to the external reference input terminal of another instrument to phase lock it to the Agilent 4294A.

6. External Program RUN/CONT Input

Allows you to input a TTL-compatible signal that triggers the RUN or CONTINUE command for an HP Instrument BASIC program. When the signal shows a rising or falling edge between the LOW and HIGH states, then the command is triggered. For more information on the input signal conditions specific to this connector, refer to Chapter 10 , “Specifications and Supplemental Performance Characteristics,” on page 323.

7. 8-bit I/O Port

Provides a data communications interface with an external device such as a handler on a production line. This port supports 4-bit data for input and 8-bit data for output.

8. Time Base Adjuster (for Option 1D5)

This adjuster is used to fine-tune the operating frequency of the Agilent 4294A when it is equipped with Option 1D5 (High Stability Frequency Reference).

NOTE

This is intended for service center use only. Do not attempt to adjust the operating frequency yourself.

9. Mini-DIN Keyboard Port

A PS/2 port intended for connecting a 101-key English keyboard. You can use a keyboard to facilitate entry operations such as creating and executing HP Instrument Basic programs or entering display titles.

NOTE

This port only supports a 101-key English keyboard with a PS/2 connector. Do not attempt

to use an unsupported keyboard.

10. 24-bit I/O Port

Provides a data communications interface with an external device such as a handler on a production line. This port supports 8-bit data for input/output and 16-bit data for output.

11. Printer Port

A parallel port that connects to a printer. Connecting a supported printer allows you to print out such data as measurement graphs and lists of measured values or settings. For a list of supported printers, refer to “Print the measurement results and internal data with a printer” on page 294.

12. External Monitor Terminal

Connects to an external color monitor. An external color monitor connected to this terminal can display the same information as the Agilent 4294A's built-in LCD.

13. GPIB Connector

Allows you to connect the Agilent 4294A to any external controller or instrument that supports GPIB (General Purpose Interface Bus). GPIB is useful when you want to assemble an automatic measurement system by having the Agilent 4294A interact with a controller and other instruments. For information on using GPIB to perform automatic measurement, refer to “Programming Guide.”

14. Inlet (with a fuse box)

To use the Agilent 4294A, you must connect this inlet with the three-wire power cable that comes with the Agilent 4294A. For more information, refer to Chapter 1, “Installation and Setup.”

Items Displayed on the LCD

Figure 3-3

Items displayed on the LCD (with split display mode off and full-screen mode on)

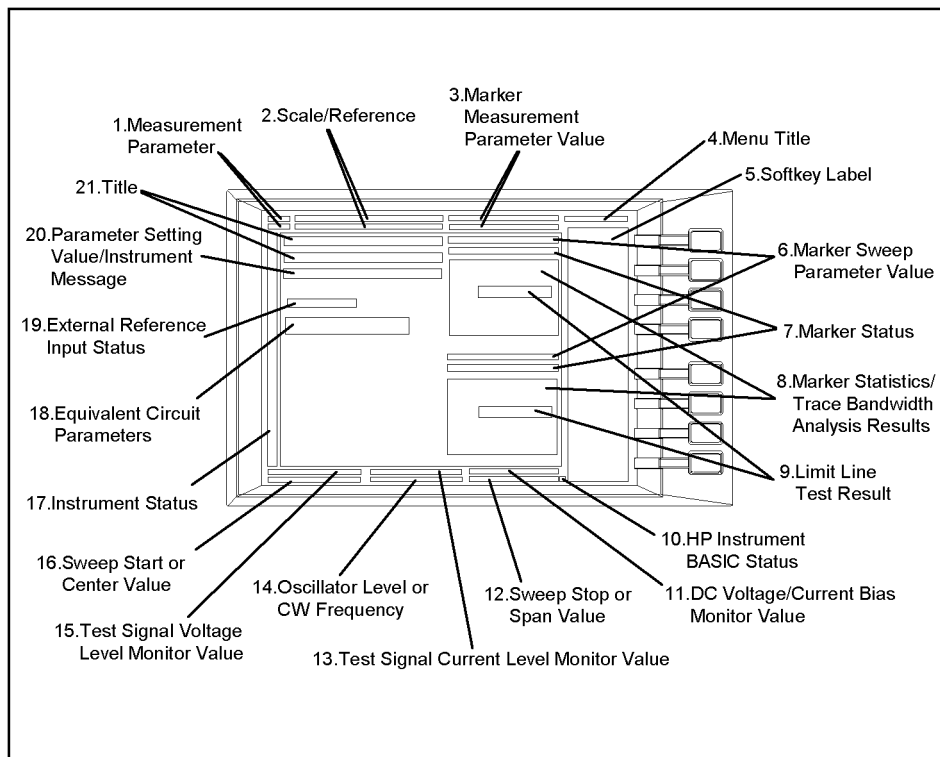

4294a0e085

1. Measurement Parameter Fields

Each of these fields show the currently selected measurement parameters for either Trace A or B.

2. Scale/Reference Fields

These fields show the current scale settings for Traces A and B.

3. Marker Measurement Parameter Value Fields

These fields show the measurement parameter values that correspond to the current marker position for Traces A and B.

4. Menu Title Field

This field shows the name of the current softkey menu, which consists of up to 8 softkey labels.

5. Softkey Label Area

Shows the labels that are, in the current context, associated with the softkeys on the right-hand side. Table 3-1 lists the types of softkey options and their functions.

Table 3-1

Types of softkey options and their functions

Type of softkey option	Function
Two or more softkey labels joined with vertical bars ()	You can select one of these options. The currently selected softkey label is underlined.
Softkey label immediately followed by a “>” symbol	Pressing the softkey displays a softkey sub-menu associated with a specific function.
Softkey label followed by “ON off” or “on OFF”	Pressing the corresponding softkey turns on/off the function in a toggle fashion. The softkey label is followed by “ON off” when the function is on and “on OFF” when the function is off.
Softkey label immediately followed by “[].”	The brackets ([]) enclose text that describes the current setting of the associated function. If the function has two alternative settings, pressing the softkey toggles between the settings. If the function has three or more alternative settings, the label is usually followed by “>,” and pressing the softkey displays a softkey sub-menu for selecting one of those settings.
more n/m	This softkey label indicates that the softkey menu consists of m pages, and that the n th page of the menu is currently displayed. You can use the more n/m key to move to the next page of the softkey menu (or to the first page if the current page is the last one).
return	This softkey label is contained in a softkey sub-menu that is displayed when you press a softkey followed by “>.” You can press the corresponding softkey to return to the main menu, that is, the original softkey menu that had been displayed before you accessed the current menu, as long as the current menu is a sub-menu.
done	Select this softkey label to put your entry into effect and return to the main menu.
yes	This softkey label appears when you are prompted to confirm your entry before applying it. Pressing the corresponding softkey puts your entry into effect.
cancel	Select this softkey label to cancel your entry and return to the main menu.

Table 3-1 Types of softkey options and their functions

Type of softkey option	Function
Softkey label for setting a parameter ¹	Pressing the corresponding softkey displays the function's current setting in the Parameter Setting field in the upper-left part of the screen and allows you to change the current setting with the Entry block keys (for example, [Bw/Avg] - AVERAGING FACTOR).
Softkey label for executing a function ¹	Pressing the corresponding softkey immediately executes the associated function (for example, [Marker] - MKR→START).

1. These softkey labels are displayed without any special symbol.

NOTE

Some softkey labels combine two or more of the functions shown in Table 3-1. For example, the **EDIT LIST** key, which can be accessed through the keystroke sequence **[Sweep] - EDIT LIST**, both turns on “sweep list edit mode” and displays a softkey sub-menu for editing the list.

Some of the softkey labels currently displayed may not be available depending on the current context; such softkey labels are dimmed by displaying them at a lower contrast than the other labels. When you choose the appropriate context by using another key, those softkey labels will revert to the normal contrast and become available.

6. Sweep Parameter Reading Fields

These fields show the sweep parameter values that correspond to the current marker position for Traces A and B.

7. Marker Status Fields

These fields provide textual representation of the current status of the marker facility.

Marker couple mode

Cpl Indicates that the marker facility is currently in couple mode. In this mode, changes to Traces A and B are synchronized.

Marker search track mode

Max Indicates that the marker facility is currently in search track mode and configured to detect the maximum value. The main marker moves to the maximum value on the trace each time one sweep cycle is completed.

Min Indicates that the marker facility is currently in search track mode and configured to detect the minimum value. The main marker moves to the minimum value on the trace each time one sweep cycle is completed.

Targ Indicates that the marker facility is currently in search track mode and configured to detect the specified target value. The main marker moves to the target value on the trace each time one sweep cycle is

Front/Rear Panel and LCD Display Items Displayed on the LCD

completed.

Peak Indicates that the marker facility is currently in search track mode and configured to detect the peak value. The main marker moves to the peak value on the trace each time one sweep cycle is completed.

Δ marker mode

Δ Mkr Indicates that the marker facility is currently in default Δ marker mode. In this mode, the Δ marker keeps track of changes to the trace, maintaining the same position in terms of the sweep parameter value.

Fxd Δ Indicates that the marker facility is currently in fixed Δ marker mode. In this mode, the Δ marker is fixed at a certain point on the screen, without reflecting any changes to the trace. It remains in the same position in terms of both the sweep parameter and measurement parameter values.

Trk Δ Indicates that the marker facility is currently in tracking Δ marker mode. In this mode, the Δ marker appears in the same position as, and moves synchronously with, the main marker,

8. Marker Statistics/Trace Bandwidth Analysis Fields

These fields show the marker statistics (average, standard deviation, and peak-to-peak values) or the results of trace bandwidth analysis (bandwidth, center value, Q peak, ΔL , and ΔR) for Traces A and B. When both features are enabled, they display the marker statistics only.

9. Limit Line Test Fields

These fields show the results of limit line tests as either "PASS" or "FAIL." By performing a limit line test, you can determine whether the trace of measurement results falls within your specified limit line.

10. HP Instrument Basic Status Indicator

Indicates the execution status of HP Instrument BASIC.

* HP Instrument BASIC is currently executing a program or command. You cannot execute an additional command.

– HP Instrument BASIC has suspended the execution of a program. You can resume the program using the CONTINUE command.

? HP Instrument BASIC is waiting for a keystroke to continue the execution of a program. You cannot execute an additional command.

(blank) HP Instrument BASIC is not executing a program or command. You can use commands other than the CONTINUE command.

11. dc Voltage/Current Bias Monitor Field

This field shows the monitor value (voltage or amperage) for the dc bias conditions that are currently in effect. For this field to actually display the monitor value, you must apply dc bias through the keystroke sequence [Source] - BIAS MENU - BIAS on OFF and then turn

on the dc bias monitor feature through the keystroke sequence **[Display] - BIAS MON [] - VOLT/CURRENT**.

12. Sweep Stop/Span Value Field

This field shows the sweep stop or span value that is currently in effect. Use the **[Stop]** key to set the sweep stop value and the **[Span]** key to set the sweep span value.

13. Test Signal Current Level Monitor Field

This field shows the AC current level monitor value for the test signal that is currently in effect. For this field to actually display the monitor value, you must turn on the test signal level monitor feature through the keystroke sequence **[Display] - OSC MON on OFF**.

14. Test Signal Level/CW Frequency Setting Field

This field shows the test signal level setting for frequency sweep or the CW frequency setting for test signal level sweep or dc bias sweep. Use the **[Source]** key to change the current value.

15. Test Signal Voltage Level Monitor Field

This field shows the AC voltage level monitor value for the test signal that is currently in effect. For this field to actually display the monitor value, you must turn on the test signal level monitor feature through the keystroke sequence **[Display] - OSC MON on OFF**.

16. Sweep Start/Center Value Field

Shows the start or center value for the sweep settings that are currently in effect. Use the **[Start]** key to set the sweep start value and the **[Center]** key to set the sweep center value.

17. Instrument Status Area

This area shows the status of various functions of the instrument.

Trace validity

* After you have changed the measurement conditions, this indicator is displayed until you update the measurement trace with the new settings. To get a correct measurement trace, you must update the trace so that this indicator disappears.

dc bias status

DCB	Indicates that the instrument is performing measurement under dc voltage bias conditions (in variable voltage mode) or dc current bias conditions (in variable current mode).
VC	Indicates that the instrument is performing measurement under dc voltage bias conditions (in constant voltage mode).
IC	Indicates that the instrument is performing measurement under dc current bias conditions (in constant current mode).

Front/Rear Panel and LCD Display

Items Displayed on the LCD

V ↓	Indicates that, because you specified dc voltage bias (in constant voltage mode) with a setting that exceeds the defined voltage limit, the actual applied voltage differs from the intended setting.
I ↓	Indicates that, because you specified dc current bias (in constant current mode) with a setting that exceeds the defined current limit, the actual applied current differs from the intended setting.
(blank)	Indicates that dc bias conditions are not applied.

Note that when dc bias conditions are applied, the “DC BIAS ON” indicator appears in the lower-right corner of the screen, regardless of which bias mode (DCB, VC, IC, V ↓, or I ↓) is selected.

Adapter type

EX1	Indicates that the instrument is configured to use a 1-meter, four-terminal pair cable.
EX2	Indicates that the instrument is configured to use a 2-meter, four-terminal pair cable.
7mm	Indicates that the instrument is configured to use the Agilent 42942A Terminal Adapter (four-terminal pair to 7-mm conversion adapter).
PRB	Indicates that the instrument is configured to use the 42941A Impedance Probe.
(blank)	Indicates that the instrument is configured to operate without an adapter.

User calibration/port extension status

	User calibration feature	Port extension feature	Correction point setting
CAL	ON		Fixed
Cal	ON		User-defined
POR		ON	Fixed
Por		ON	User-defined
CAP	ON	ON	Fixed
CaP	ON	ON	User-defined
(blank)			(Unknown)

Blank cells in the table indicate that the feature is off.

Fixture compensation status

	Fixture Compensation feature	Correction point setting
CMP	ON	Fixed
Cmp	ON	User-defined
(blank)		(Unknown)

Blank cells in the table indicate that the feature is off.

NOTE

The user correction and fixture compensation features share the same correction point settings. You cannot set correction points specific to a single feature.

Averaging status

- Avg Indicates that the sweep-to-sweep averaging feature is on.
- (blank) Indicates that the sweep-to-sweep averaging feature is off.

Averaging counter

- (Positive integer) When the sweep-to-sweep averaging feature is on, this counter indicates how many times the current trace has been subjected to sweep-to-sweep averaging. After you have started sweep-to-sweep averaging, the counter shows “1” upon the 1st sweep cycle, “2” upon the 2nd cycle, and so on until it reaches the maximum number of averaging cycles. To view a trace subjected to your specified number of averaging cycles, you must wait for the instrument to repeat the sweep cycles until the counter reaches that number.

Data trace definition

- D–M Indicates that the currently displayed data trace represents the result of subtracting the memory trace data from the measurement data.
- D/M Indicates that the currently displayed data trace represents the result of dividing the measurement data by the memory trace data.
- D%M Indicates that the currently displayed data trace represents the result of the following operation: $\frac{DATA - MEM}{MEM} \times 100$ [%] (where *DATA* is the measurement data and *MEM* is the memory trace data).
- O Indicates that the currently displayed data trace represents the result of subtracting the offset value from the measurement data.
- (blank) Indicates that the currently displayed data trace shows the exact measurement data.

NOTE

If “–O” appears below “D–M” or “D%M,” the data trace represents the result of performing both operations on the measurement data.

Front/Rear Panel and LCD Display Items Displayed on the LCD

Service mode status

Svc	Indicates that the instrument is in service mode, which is intended for servicing use only. The accuracy of data measured in this mode is not guaranteed. For more information, refer to the “Service Manual.”
(blank)	Indicates that the instrument is ready for normal measurement use.

Sweep/trigger status

Hld	Indicates that the sweep function is in Hold status (i.e., not enabled). To enable the sweep function, you must select one of the available sweep modes (single-cycle sweep, group sweep, or continuous sweep).
↓	Indicates that the instrument is performing a sweep cycle. This indicator appears at the measurement point on the trace 1.5 seconds after the start of a sweep cycle.
ext	Indicates that the instrument is waiting for an external signal that triggers the start of measurement. This indicator appears after you have used the keystroke sequence [Trigger] - SOURCE [] - EXTERNAL to specify that the trigger signal be input from an external trigger source (via the external trigger input).
man	Indicates that the instrument is in manual trigger mode, in which you can manually start measurement by pressing the MANUAL key. This indicator appears after you have used the keystroke sequence [Trigger] - SOURCE [] - MANUAL .
bus	Indicates that the instrument is waiting for a measurement trigger command to be input through GP-IB or from a LAN. This indicator appears after you have used the keystroke sequence [Trigger] - SOURCE [] - HP-IB/LAN .

18. Equivalent Circuit Parameters Field

This field shows the equivalent circuit parameter values after you have used the keystroke sequence **[Display] - more 1/2 - EQUIV CKT - PARAMETERS on OFF**. To use this field to view the parameter values, you can first either apply the equivalent circuit analysis feature to calculate the parameter values from the trace representing the measured frequency characteristics or enter the equivalent parameter values for simulating frequency characteristics.

19. External Reference Input Status Field

When a reference signal is input to the external reference input terminal on the rear panel, this field shows “ExtRef” (even if the instrument is not phase locked). The indicator disappears when the reference signal stops.

20. Parameter Setting/Instrument Message Field

When you press a key to set a particular parameter (for example, the **[Start]** to set the sweep start value), this field shows the current setting. When you are changing the current setting, the field also serves as the place to enter the new value through the ENTRY block keys. In addition, an instrument message such as an error message may appear in the upper part of this field. For a list of common error messages, Refer to Appendix C , “Error

messages,” on page 429.

21. Title Field

This field provides a place to enter a title (up to 64 alphanumeric characters) that describes the current screen. To enter the title, use the keystroke sequence **[Display] - more 1/2 - TITLE**.

Front/Rear Panel and LCD Display
Items Displayed on the LCD

4**Preparation of Measurement Accessories**

This chapter describes the required preparation of accessories after finishing installation of the Agilent 4294A and before starting measurements. If you have not completed installation, please refer to Chapter 1 , “Installation,” on page 17 before proceeding to this chapter.

Selecting Accessories for Measurement

Select the appropriate accessories (test fixture, adapter, probe, cable, etc.) for your measurement in accordance with Table 4-1. Detailed specifications are described in catalogs or in the operation manual of each accessory.

Table 4-1 Guidelines for Selecting Accessories

Type of Device	Condition	Accessory	Features of Accessory
Lead component	Entire frequency range of 4294A	16047E	Equipped with screws for firmly fixing the fixture to the 4294A.
	Entire frequency range of 4294A	42942A and 16092A	For both chip and lead components.
	Entire frequency range of 4294A	42942A and 16093A	Two binding-post-type electrodes set 7 mm apart.
	Entire frequency range of 4294A	42942A and 16093B	Three binding-post-type electrodes set 15 mm and 18 mm apart.
	Frequency \leq 40 MHz	16047C	
	Frequency \leq 40 MHz	16047D	For axial and radial lead components.
	Frequency \leq 13 MHz	16047A	For axial and radial lead components.
	Frequency \leq 10 MHz, Balanced component and circuit measurement	16314A	Three binding-post-type electrodes.
	Frequency \leq 2 MHz, External dc bias up to 200 V	16065A	For axial and radial lead components. Equipped with safety cover.
	Frequency \leq 100 kHz, Component terminal diameter \leq 15 mm	16089A	Two Kelvin clips. Cable length: approx. 1 m.
	Frequency \leq 100 kHz, Component terminal diameter \leq 7.9 mm	16089B	Two Kelvin clips. Cable length: approx. 1 m.
	Frequency \leq 100 kHz, Component terminal diameter \leq 6 mm	16089E	Two Kelvin clips. Cable length: approx. 1 m.
	Frequency \leq 100 kHz, IC pin diameter \leq 1 mm	16089C	Two Kelvin clips. Cable length: approx. 1 m.
	Frequency \leq 100 kHz	16089D	Four alligator clips. Cable length: approx. 1 m.

Table 4-1 Guidelines for Selecting Accessories

Type of Device	Condition	Accessory	Features of Accessory
Chip component	Entire frequency range of 4294A, Component size \geq 0603	16034G	
	Entire frequency range of 4294A, Component size \geq 1608	16034H	Can measure array-type components.
	Entire frequency range of 4294A, Component size \geq 2012	42942A and 16191A	Connected to the component's bottom face.
	Entire frequency range of 4294A, Component size \geq 1608	42942A and 16192A	Connected to both sides of the component.
	Entire frequency range of 4294A, Component size \geq 1608	42942A and 16193A	Connected to the component's bottom face.
	Entire frequency range of 4294A	42942A and 16092A	For both chip and lead components.
	Frequency \leq 40 MHz, Component size \geq 1608	16034E	
	Frequency \leq 15 MHz	16334A	Tweezers type. Cable length: approx. 1 m.
	Frequency \leq 10 MHz, Component size \geq 1608, Low impedance device	16044A	Connected to the device by four terminals.
Circuit	Entire frequency range of 4294A	42941A and probe adapter ¹	Probe type.
Solid material	Permittivity measurement	16451B	Cable length: approx. 1 m.
	Permeability measurement	42942A and 16454A	
Liquid material	Permittivity measurement	16048G and 16452A	16048G: approx. 1 m.
		16048H and 16452A	16048H: approx. 2 m.
General	Cable extension	16048G and test fixture	16048G: approx. 1 m.
		16048H and test fixture	16048H: approx. 2 m.
		42942A, coaxial cable, and test fixture	
		42941A, coaxial cable, and test fixture	42941A: approx. 1.5 m.

1. Furnished with the 42941A Impedance Probe Kit.

NOTE

The 16085B Terminal Adapter cannot be used in place of the 42942A Terminal Adapter.
 The 16048A BNC 1 m Cable, the 16048B SMC 1 m Cable, the 16048D BNC 2 m Cable, or the 16048E BNC 4 m Cable cannot be used in place of the 16048G or 16048H.

Connecting the Accessories

Step 1. Connect the measurement accessories to the Agilent 4294A.

Step 2. Press the power switch on the front panel of the Agilent 4294A to turn it on.

For more information on connecting accessories to the Agilent 4294A for measurement, refer to the operation manual furnished with each accessory.

NOTE

Whenever you connect accessories to or disconnect accessories from the Agilent 4294A, you must first turn off the dc bias (Key strokes: **[Source] - BIAS MENU - BIAS ON off**). If this step is not taken, the dc bias may destroy the device.

When you connect or disconnect accessories with the Agilent 4294A turned on, error messages such as “ADC OVERLOAD” or “BRIDGE UNBALANCED” may be displayed on the LCD. However, this does not cause any special problem. To turn off the message, press **[Entry Off]** key.

The power-on self-test is executed at power-on. If an error is detected in the power-on self-test, the message “CAUTION: POWER ON TEST FAILED” is displayed in the upper-left area of the screen. In this case, contact your nearest Agilent Technologies office or the company from which you purchased this instrument. For more information on the self-test (self-diagnostic) function, refer to “Performing Self-Diagnosis of the Agilent 4294A” on page 320.

Adapter Setting

You must ensure that the adapter setting is properly set after you finish connecting accessories to the four-terminal pair port of the Agilent 4294A and before you start measurement. If required, change it to the correct adapter setting. The adapter setting includes adapter selection and the data acquisition process, which is called adapter setup. Table 4-2 lists the device connections and corresponding adapter settings.

Table 4-2 Device Connections and Adapter Settings

Device Connection	Accessory	Adapter Selection	Adapter Setup (data measurement) (√: required; blank: not required)			
			Phase ¹	OPEN	SHORT	LOAD
A. Connect a direct connection type test fixture to the four-terminal pair port of the Agilent 4294A and connect the device to the fixture contacts.	16034E 16034G 16034H 16044A 16047A 16047C 16047D 16047E 16065A ² 16089A ² 16089B ² 16089C ² 16089D ² 16089E ² 16314A	No Adapter (NONE)				
B. Extend the four-terminal pair port of the Agilent 4294A with a 1-meter-long four-terminal pair configuration and connect the device.	16048G and test fixture 16048G and 16452A	Four-terminal pair, 1 meter (4TP 1M)	√			√
	16334A	Four-terminal pair, 1 meter (4TP 1M)	√			√
	16451B	Four-terminal pair, 1 meter (4TP 1M)	√			
C. Extend the four-terminal pair port of the Agilent 4294A with a 2-meter-long four-terminal pair configuration and connect the device.	16048H and test fixture 16048H and 16452A	Four-terminal pair, 2 meters (4TP 2M)	√			√
D. Connect the 42942A directly to the four-terminal pair port of the Agilent 4294A, connect a dedicated test fixture to the 7-mm port, and then connect the device to the fixture contacts.	42942A and 16092A 42942A and 16093A 42942A and 16093B 42942A and 16191A 42942A and 16192A 42942A and 16193A 42942A and 16454A	42942A Terminal Adapter (7mm 42942A)	√	√	√	√

Preparation of Measurement Accessories
Adapter Setting

Table 4-2 Device Connections and Adapter Settings

Device Connection	Accessory	Adapter Selection	Adapter Setup (data measurement) (√: required; blank: not required)			
			Phase ¹	OPEN	SHORT	LOAD
E. Connect the 42942A directly to the four-terminal pair port of the Agilent 4294A, connect a coaxial cable to the 7-mm port, connect a test fixture, and then connect the device to the fixture contacts.	42942A, coaxial cable, and test fixture	42942A Terminal Adapter (7mm 42942A)	√	√	√	√
F. Connect the 42941A directly to the four-terminal pair port of the Agilent 4294A, connect a dedicated probe adapter to the 3.5-mm port, and then connect the device to the adapter contacts.	42941A and probe adapter	42941A Impedance Probe (PROBE 42941A)	√	√	√	√
G. Connect the 42941A directly to the four-terminal pair port of the Agilent 4294A, connect a coaxial cable to the 3.5-mm port, connect a test fixture, and then connect the device to the fixture contacts.	42941A, coaxial cable, and test fixture	42941A Impedance Probe (PROBE 42941A)	√	√	√	√

1. Phase compensation.
2. Although it has a cable, it is considered a direct-connection-type test fixture.

Adapter Selection

The adapter selection setting must be confirmed before measurement in accordance with the connection status of each accessory. If necessary, it must be changed to the correct setting.

The adapter selection of the Agilent 4294A can be confirmed and, if necessary, changed as follows.

- Step 1.** Press **[Cal]** key to display the Calibration Menu.
- Step 2.** The adapter selection status is displayed in the [] space of the **ADAPTER []** key's softkey label. Proceed to Step 3 if you need to change the selection.

Softkey Label	Adapter Selection Status
ADAPTER [NONE]	No Adapter
ADAPTER [1M]	Four-terminal pair, 1 meter
ADAPTER [2M]	Four-terminal pair, 2 meter
ADAPTER [7mm]	42942A Terminal Adapter

Softkey Label	Adapter Selection Status
ADAPTER [PROBE]	42941A Impedance Probe

NOTE Adapter selection status can also be confirmed through the display of the instrument status area on the LCD's left side. Refer to “Adapter type” on page 58.

Step 3. Press **ADAPTER []** key to display the Adapter Setting Menu.

Step 4. Select the corresponding adapter selection from the following:

Adapter Selection	Key Strokes
No Adapter	NONE
Four-terminal pair, 1 meter	4TP 1M
Four-terminal pair, 2 meters	4TP 2M
42942A Terminal Adapter	7mm 42942A
42941A Impedance Probe	PROBE 42941A

Adapter Setup

The adapter setup is a process used to acquire the setup data of the adapter selected by the “Adapter Selection” on page 68. The adapter setup is normally performed in the following cases.

- When using the 16048G with the Agilent 4294A for the first time after it is delivered.
- When using the 16048H with the Agilent 4294A for the first time after it is delivered.
- When using the 16334A with the Agilent 4294A for the first time after it is delivered.
- When using the 16451B with the Agilent 4294A for the first time after it is delivered.
- When using the 42942A with the Agilent 4294A for the first time after it is delivered.
- When using the 42941A with the Agilent 4294A for the first time after it is delivered.
- When making a measurement in an ambient temperature that is outside the range of $\pm 5^{\circ}\text{C}$ from the adapter setup temperature for the above accessories.

NOTE Generally, the adapter setup does not need to be performed except for the above cases.

For each adapter setup procedure, refer to:

- “Adapter Setup Procedure for the 16048G and 16048H” on page 70
- “Adapter Setup Procedure for the 16334A” on page 72
- “Adapter Setup Procedure for the 16451B” on page 73
- “Adapter Setup Procedure for the 42942A” on page 74
- “Adapter Setup Procedure for the 42941A” on page 78

Preparation of Measurement Accessories

Adapter Setting

NOTE

When you select “No Adapter” (**NONE** key) in adapter selection, adapter setup cannot be performed.

Adapter setup data can be obtained and saved for each adapter selection.

Adapter setting (adapter selection and adapter setup data) is not affected by turning on/off the Agilent 4294A or by pressing the [**Preset**] key to initialize the instrument settings.

Adapter Setup Procedure for the 16048G and 16048H

When you use the 16048G 1 m cable or 16048H 2 m cable with another accessory, only perform the adapter setup for the 16048G or 16048H. The operation manuals of the 16048G and 16048H also describe the adapter setup procedure.

NOTE

Adapter setup should be performed at an ambient temperature as close as possible to the temperature in which the device measurement will actually be made.

If the ambient temperature for your measurement is outside the range of $\pm 5^{\circ}\text{C}$ from the adapter setup temperature, it is recommended that you perform adapter setup again at the appropriate temperature.

It takes a few minutes to complete each setup data measurement.

During each data measurement, the message “WAIT--MEASURING ADJUSTMENT KIT” is displayed in the instrument state area in the LCD's upper-left side.

- Step 1.** Make sure that the 16048G or 16048H is correctly connected to the four-terminal pair port of the Agilent 4294A.

Figure 4-1 Connecting the 16048G or 16048H

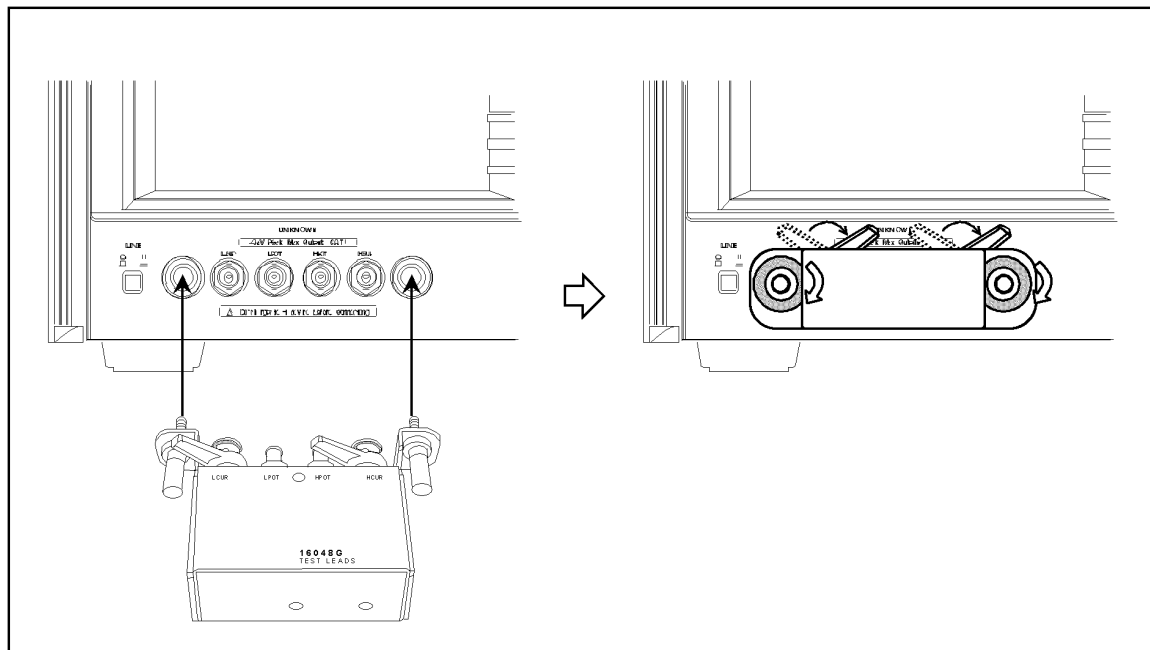

NOTE The 16048G or 16048H cable must be directly connected to the four-terminal pair port of the Agilent 4294A. If another accessory like a cable or adapter is inserted between the 16048G or 16048H and the four-terminal pair port of the Agilent 4294A, the correct adapter setup data cannot be obtained and correct device measurement cannot be performed after the adapter setup.

- Step 2.** More than 30 minutes warm-up time is required after turning on the Agilent 4294A.
- Step 3.** Make the correct adapter selection for the 16048G or 16048H in accordance with “Adapter Selection” on page 68.
- Step 4.** After performing Step 4 of “Adapter Selection” on page 68, press the **SETUP** key to display the Adapter Setup Menu.
- Step 5.** Connect the Lcur and Lpot terminals on the 16048G or 16048H to the Hpot and Hcur terminals of the 100 Ω Resistor (furnished with the Agilent 4294A, Agilent Part Number: 04294-61001) as shown in Figure 4-2. Other terminals should remain open.

Figure 4-2 Connecting 100 Ω Resistor (Phase Compensation Data Measurement)

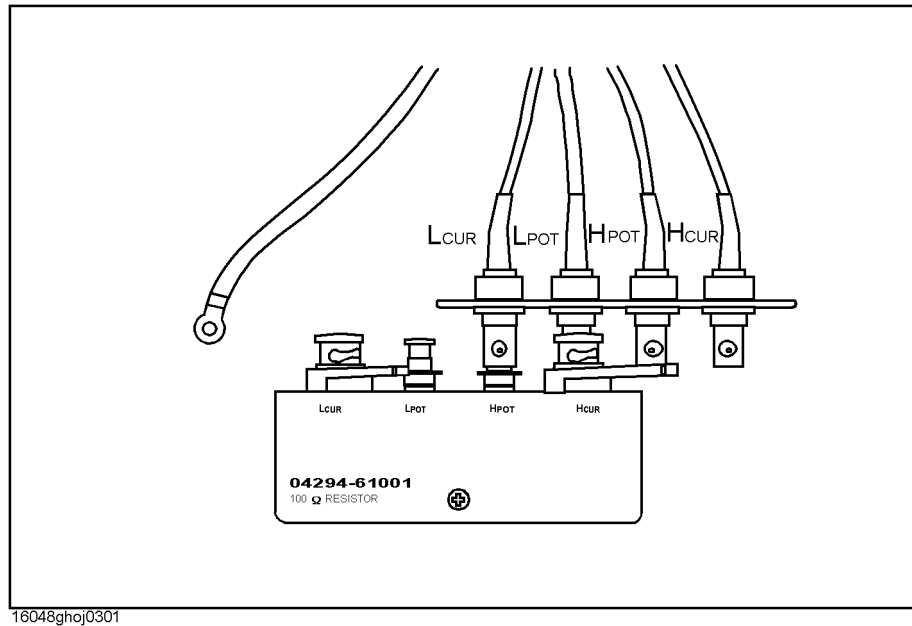

- Step 6.** Press the **PHASE COMP [-]** key to start the phase compensation data measurement.

NOTE The traces on the LCD display do not change during the phase compensation data measurement.

When the phase compensation data measurement is completed, the softkey label changes to **PHASE COMP [DONE]**.

- Step 7.** Connect the Lcur, Lpot, Hpot, and Hcur terminals on the 16048G or 16048H to the Lcur, Lpot, Hpot and Hcur terminals of the 100 Ω Resistor as shown in Figure 4-3.

Figure 4-3

Connecting 100 Ω Resistor (Load Data Measurement)

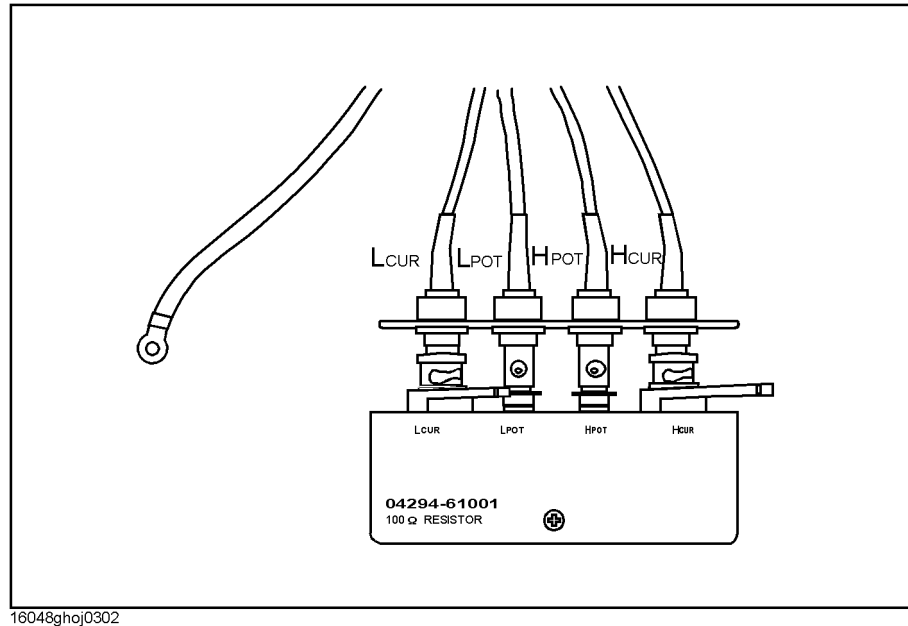

Step 8. Press the **LOAD [-]** key to start the load data measurement.

NOTE When the load data measurement is completed, the softkey label changes to **LOAD [DONE]**.

Step 9. Press the **done** key to start calculating the adapter setup data from the measured phase compensation and load data. The adapter setup data is automatically saved to the EEPROM (nonvolatile memory) in the Agilent 4294A.

NOTE Press the **cancel** key to cancel the adapter setup process. If the adapter setup process is canceled, the previously obtained data is saved as the available adapter setup data.

Adapter Setup Procedure for the 16334A

Perform the adapter setup for the 16334A Tweezers Type Test Fixture in accordance with the following procedure:

NOTE Adapter setup should be performed at an ambient temperature as close as possible to the temperature in which the device measurement will actually be made.

If the ambient temperature for your measurement is outside the range of $\pm 5^{\circ}\text{C}$ from the adapter setup temperature, it is recommended that you perform adapter setup again at the appropriate temperature.

It takes a few minutes to complete each setup data measurement.

During each data measurement, the message "WAIT--MEASURING ADJUSTMENT KIT" is displayed in the instrument state area in the LCD's upper-left side.

Step 1. Make sure that the 16334A is correctly connected to the four-terminal pair port of the

Agilent 4294A.

NOTE

The 16334A must be directly connected to the four-terminal pair port of the Agilent 4294A. If another accessory such as a cable or adapter is inserted between the 16334A and the four-terminal pair port of the Agilent 4294A, the correct adapter setup data cannot be obtained and correct device measurement cannot be performed after the adapter setup.

- Step 2.** More than 30 minutes warm-up time is required after turning on the Agilent 4294A.
- Step 3.** Make the correct adapter selection for the 16334A in accordance with the “Adapter Selection” on page 68.
- Step 4.** After performing Step 4 of the “Adapter Selection” on page 68, press the **SETUP** key to display the Adapter Setup Menu.
- Step 5.** Put the device contacts of the 16334A into the OPEN condition. Refer to the operation manual of the 16334A for instructions on switching to the OPEN condition.
- Step 6.** Press the **PHASE COMP [-]** key to start the phase compensation data measurement.

NOTE

The traces on the LCD display do not change during the phase compensation data measurement.

When the phase compensation data measurement is completed, the softkey label changes to **PHASE COMP [DONE]**.

- Step 7.** Connect a 100 Ω LOAD device to the 16334A.
- Step 8.** Press the **LOAD [-]** key to start the load data measurement.

NOTE

When the load data measurement is completed, the softkey label changes to **LOAD [DONE]**.

- Step 9.** Press the **done** key to start calculating the adapter setup data from the measured phase compensation and load data. The adapter setup data is automatically saved to the EEPROM (nonvolatile memory) in the Agilent 4294A.

NOTE

Press the **cancel** key to cancel the adapter setup process. If the adapter setup process is canceled, the previously obtained data is saved as the available adapter setup data.

Adapter Setup Procedure for the 16451B

Perform the adapter setup for the 16451B Dielectric Test Fixture in accordance with the following procedure:

NOTE

Adapter setup should be performed at an ambient temperature as close as possible to the temperature in which the device measurement will actually be made.

If the ambient temperature for your measurement is outside the range of $\pm 5^{\circ}\text{C}$ from the adapter setup temperature, it is recommended that you perform adapter setup again at the appropriate temperature.

It takes a few minutes to complete each setup data measurement.

Preparation of Measurement Accessories

Adapter Setting

During each data measurement, the message “WAIT--MEASURING ADJUSTMENT KIT” is displayed in the instrument state area in the LCD's upper-left side.

-
- Step 1.** Make sure that the 16451B is correctly connected to the four-terminal pair port of the Agilent 4294A.

NOTE

The 16451B Dielectric Test Fixture must be directly connected to the four-terminal pair port of the Agilent 4294A. If another accessory such as a cable or adapter is inserted between the 16451B and the four-terminal pair port of the Agilent 4294A, the correct adapter setup data cannot be obtained and correct device measurement cannot be performed after the adapter setup.

-
- Step 2.** More than 30 minutes warm-up time is required after turning on the Agilent 4294A.
- Step 3.** Make the correct adapter selection for the 16451B in accordance with “Adapter Selection” on page 68.
- Step 4.** After performing Step 4 of “Adapter Selection” on page 68, press the **SETUP** key to display the Adapter Setup Menu.
- Step 5.** Put the device contacts of the 16451B into the OPEN condition. Refer to the operation manual of the 16451B for instructions on switching to the OPEN condition.
- Step 6.** Press the **PHASE COMP [-]** key to start the phase compensation data measurement.

NOTE

The traces on the LCD display do not change during the phase compensation data measurement.

When the phase compensation data measurement is completed, the softkey label changes to **PHASE COMP [DONE]**.

-
- Step 7.** Press **done** key to start calculating the adapter setup data from the measured load data. The adapter setup data is automatically saved to the EEPROM (nonvolatile memory) in the Agilent 4294A.

NOTE

Press the **cancel** key to cancel the adapter setup process. If the adapter setup process is canceled, the previously obtained data is saved as the available adapter setup data.

Adapter Setup Procedure for the 42942A

Perform the adapter setup for the 42942A Terminal Adapter in accordance with the following procedure (operation manual of the 42942A also describes the adapter setup procedure).

NOTE

Adapter setup should be performed at an ambient temperature as close as possible to the temperature in which the device measurement will actually be made.

If the ambient temperature for your measurement is outside the range of $\pm 5^{\circ}\text{C}$ from the adapter setup temperature, it is recommended that you perform adapter setup again at the appropriate temperature.

It takes a few minutes to complete each setup data measurement.

During each data measurement, the message “WAIT--MEASURING ADJUSTMENT

KIT” is displayed in the instrument state area in the LCD's upper-left side.

- Step 1.** Make sure that the 42942A is correctly connected to the four-terminal pair port of the Agilent 4294A.

Figure 4-4 Connecting the 42942A

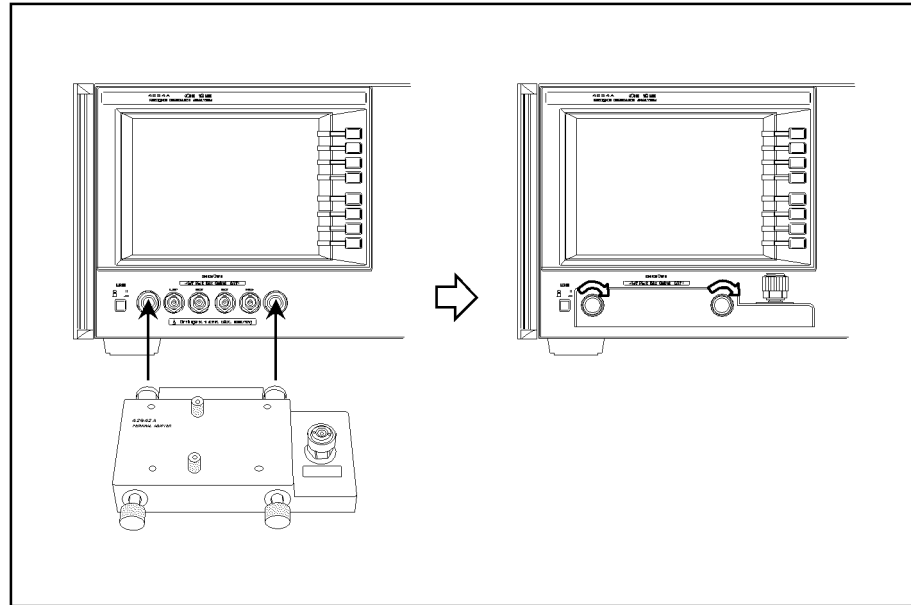

42942aaj0102

NOTE

The 42942A must be directly connected to the four-terminal pair port of the Agilent 4294A. If another accessory such as a cable or adapter is inserted between the 42942A and the four-terminal pair port of the Agilent 4294A, the correct adapter setup data cannot be obtained and correct device measurement cannot be performed after the adapter setup.

- Step 2.** More than 30 minutes warm-up time is required after turning on the Agilent 4294A.
- Step 3.** Make the correct adapter selection for the 42942A in accordance with “Adapter Selection” on page 68.
- Step 4.** After performing Step 4 of “Adapter Selection” on page 68, press the **SETUP** key to display the Adapter Setup Menu.
- Step 5.** Connect OPEN (0 S) to the 7-mm port of the 42942A (the OPEN standard is furnished with the 42942A Terminal Adapter).

Figure 4-5

Connecting OPEN (0 S) to the 42942A

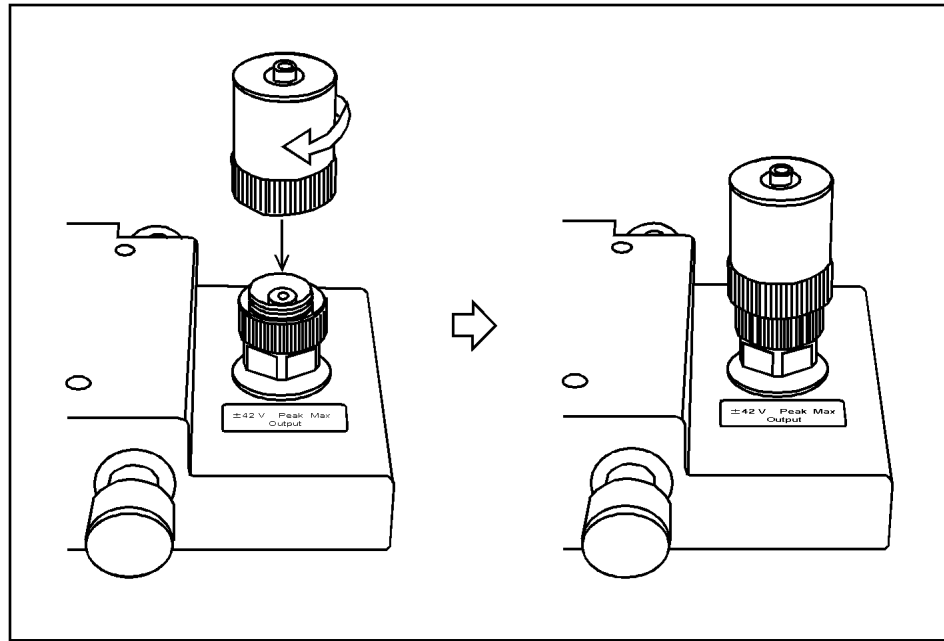

42942a0j0302

Step 6. Press the **PHASE COMP [-]** key to start the phase compensation data measurement.

NOTE

The traces on the LCD display do not change during the phase compensation data measurement.

When the phase compensation data measurement is completed, the softkey label changes to **PHASE COMP [DONE]**.

Step 7. With the OPEN (0 S) standard connected to the 7-mm port, press the **OPEN [-]** key to start the open data measurement.

NOTE

When the load data measurement is completed, the softkey label changes to **OPEN [DONE]**.

Step 8. Remove the OPEN (0 S) standard from the 7-mm port of the 42942A. Then connect the SHORT (0 Ω) standard to the 7-mm port (the SHORT standard is furnished with the 42942A Terminal Adapter).

Figure 4-6

Connecting SHORT (0Ω) to the 42942A

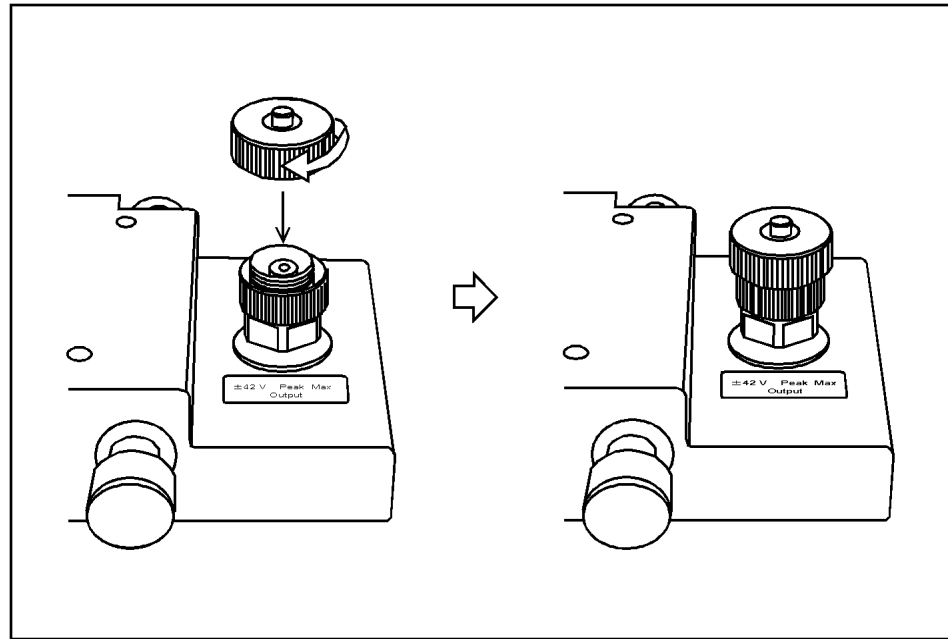

Step 9. Press the **SHORT [-]** key to start the short data measurement.

NOTE

When the short data measurement is completed, the softkey label changes to **SHORT [DONE]**.

Step 10. Remove the SHORT (0Ω) standard from the 7-mm port of the 42942A. Then connect the LOAD (50Ω) standard to the 7-mm port (the LOAD standard is furnished with the 42942A Terminal Adapter).

Figure 4-7

Connecting LOAD (50 Ω) to the 42942A

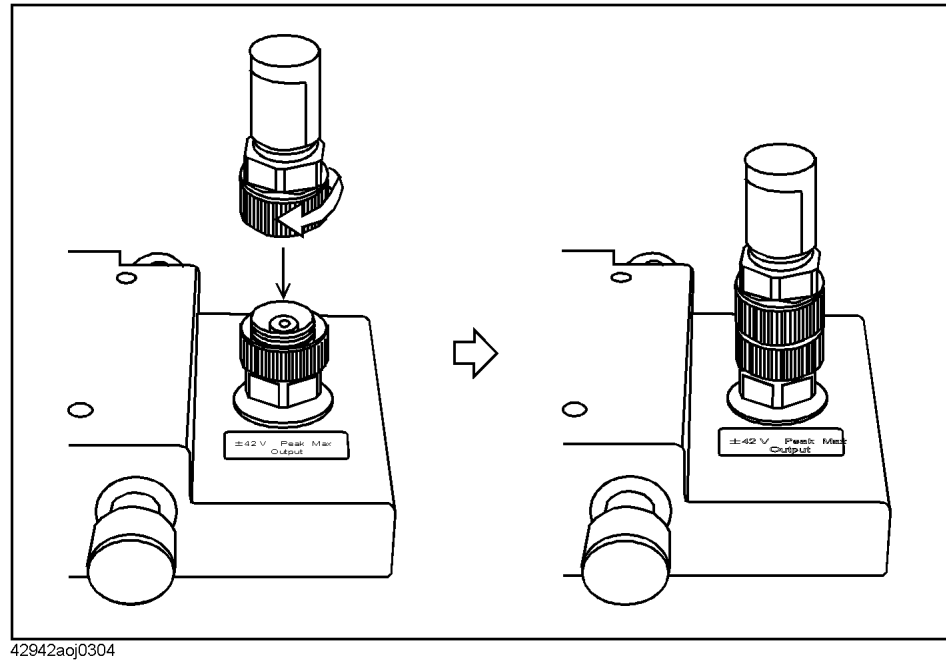

Step 11. Press the **LOAD [-]** key to start the load data measurement.

NOTE When the load data measurement is completed, the softkey label changes to **LOAD [DONE]**.

Step 12. Press the **done** key to start calculating the adapter setup data from the measured OPEN, SHORT, and LOAD data. The adapter setup data is automatically saved to the EEPROM (nonvolatile memory) in the Agilent 4294A.

NOTE Press the **cancel** key to cancel the adapter setup process. If the adapter setup process is canceled, the previously obtained data is saved as the available adapter setup data.

Adapter Setup Procedure for the 42941A

Perform the adapter setup for the 42941A Impedance Probe in accordance with the following procedure (the operation manual for the 42941A also describes the adapter setup procedure).

NOTE Adapter setup should be performed at an ambient temperature as close as possible to the temperature in which the device measurement will actually be made.

If the ambient temperature for your measurement is outside the range of $\pm 5^{\circ}\text{C}$ from the adapter setup temperature, it is recommended that you perform adapter setup again at the appropriate temperature.

It takes a few minutes to complete each setup data measurement.

During each data measurement, the message “WAIT--MEASURING ADJUSTMENT KIT” is displayed in the instrument state area in the LCD's upper-left side.

- Step 1.** Make sure that the 42941A is correctly connected to the four-terminal pair port of the Agilent 4294A.

Figure 4-8

Connecting the 42941A

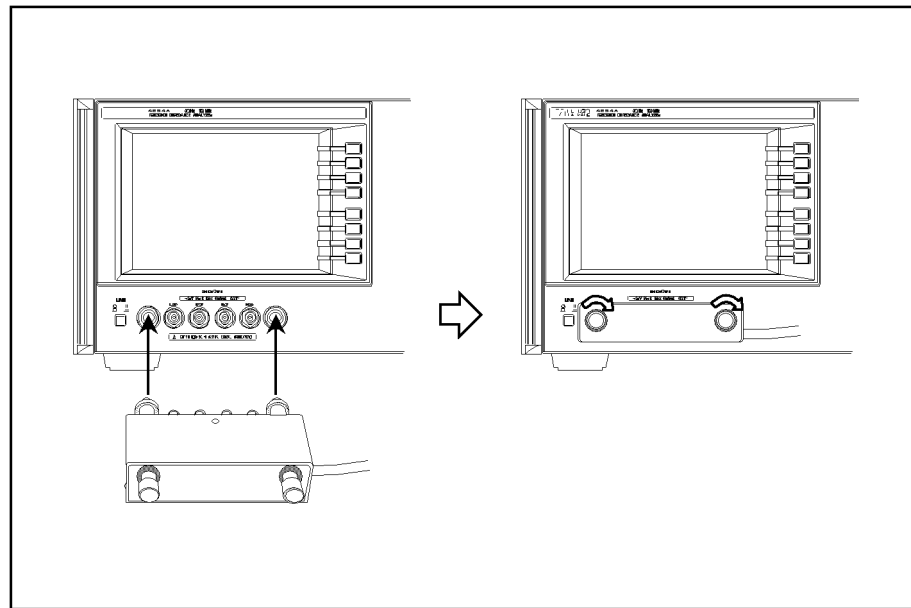

42941aaj0101

NOTE

The 42941A must be directly connected to the four-terminal pair port of the Agilent 4294A. If another accessory such as a cable or adapter is inserted between the 42941A and the four-terminal pair port of the Agilent 4294A, the correct adapter setup data cannot be obtained and correct device measurement cannot be performed after the adapter setup.

- Step 2.** More than 30 minutes warm-up time is required after turning on the Agilent 4294A.
- Step 3.** Make the correct adapter selection for the 42941A in accordance with the “Adapter Selection” on page 68.
- Step 4.** After performing Step 4 of the “Adapter Selection” on page 68, press the **SETUP** key to display the Adapter Setup Menu.
- Step 5.** Leave the 3.5-mm port of the 42941A open (no connection). There is no OPEN standard for the 42941A.
- Step 6.** Press the **PHASE COMP [-]** key to start the phase compensation data measurement.

NOTE

The traces on the LCD display do not change during the phase compensation data measurement.

When the phase compensation data measurement is completed, the softkey label changes to **PHASE COMP [DONE]**.

- Step 7.** With nothing connected to the 3.5-mm port, press the **OPEN [-]** key to start open data measurement.

Preparation of Measurement Accessories

Adapter Setting

NOTE When the load data measurement is completed, the softkey label changes to **OPEN [DONE]**.

Step 8. Connect the SHORT (0 Ω , HRM 504) to the 3.5-mm port (the SHORT is furnished with the 42941A Impedance Probe).

Step 9. Press the **SHORT [-]** key to start the short data measurement.

NOTE When the short data measurement is completed, the softkey label changes to **SHORT [DONE]**.

Step 10. Remove the SHORT (0 Ω , HRM 504) from the 3.5-mm port of the 42941A. Then connect the LOAD (50 Ω , HRM 601) to the 3.5-mm port (the LOAD is furnished with the 42941A Impedance Probe).

Step 11. Press the **LOAD [-]** key to start the load data measurement.

NOTE When the load data measurement is completed, the softkey label changes to **LOAD [DONE]**.

Step 12. Press the **done** key to start calculating the adapter setup data from the measured phase compensation, OPEN, SHORT, and LOAD data. The adapter setup data is automatically saved to the EEPROM (nonvolatile memory) in the Agilent 4294A.

NOTE Press the **cancel** key to cancel the adapter setup process. If the adapter setup process is canceled, the previously obtained data is saved as the available adapter setup data.

5 Setting Measurement Conditions

This chapter explains how to set up the measurement conditions for the Agilent 4294A Precision Impedance Analyzer, including the measurement signal and sweep.

NOTE

Be sure to perform the “adapter setting” before starting your measurement. See “Adapter Setting” on page 67 for how to perform the adapter setting.

Putting the Agilent 4294A into the Preset State (Presetting)

Step 1. Press the [Preset] key.

Executing presetting will put the Agilent 4294A into an initial state called the “preset state.”

When turning on the power to the Agilent 4294A, a power-on state file is loaded to restore the setting stored in the file if it has been saved in the mass storage of the Agilent 4294A. We recommend that you to perform presetting by pressing the **[Preset]** key each time you put the Agilent 4294A into a new setting, regardless of whether it is done immediately after turning the power on.

Note that the adapter setting is not affected by initialization with the **[Preset]** key; once it is set, it cannot be modified by pressing the **[Preset]** key.

Selecting Trace (Active Trace)

The Agilent 4294A can display the measurement results of one sweep measurement in two traces (waveforms) on the screen. These traces are called trace A and trace B. Various conditions or analyses can be applied to these traces independently, while others can be applied to them in common, such as the sweep range.

Step 1. Press one of the following keys to select a trace for setting conditions or for analysis.

Active trace	Key stroke
Trace A	[A]
Trace B	[B]

The settings using the following keys (key operations) can be specified for trace A and trace B independently. Before making settings with these keys (key operations), be sure to check and select the active trace.

- [Format]
- [Display] - DEF TRACE [] (except for DATA → MEMORY)
- [Display] - OFFSET
- [Display] - more 1/2 - TITLE
- [Scale Ref]
- Keys in the MARKER block

The settings using keys other than those above can be commonly applied to trace A and trace B. Therefore, you do not have to select the active trace or check its state before making those settings. However, there are some exceptions. Refer to the operational procedure of each function for details.

Selecting Sweep Parameter

- Step 1.** Press the [Sweep] key.
- Step 2.** Press the **PARAMETER []** key.
- Step 3.** Select the desired sweep parameter

Sweep parameter	Key stroke
Frequency	FREQ
Oscillator level (voltage or current)	OSC LEVEL
dc bias	DC BIAS

NOTE

When selecting the oscillator level as a sweep parameter, follow the steps shown in “Selecting Unit for Oscillator Level (Voltage or Current)” on page 106 to select sweeping by voltage or current level.

When selecting the dc bias as a sweep parameter, proceed to the setting shown in “Setting and Applying dc Bias” on page 107.

The sweep parameter that is currently selected appears in the key label [] of the **PARAMETER []** key.

Softkey label	Selected sweep parameter
PARAMETER [FREQ]	Frequency
PARAMETER [OLEV]	Oscillator level (voltage or current)
PARAMETER [DCB]	dc bias

NOTE

See “Using Time as Sweep Parameter (Zero Span Sweep)” on page 94 for the measurement with time as a sweep parameter (zero span measurement).

The sweep parameter can be set to trace A and trace B in common. It is not necessary to select an active trace or to verify the current selection before setting the parameter.

Figure 5-1 Sweep by Frequency

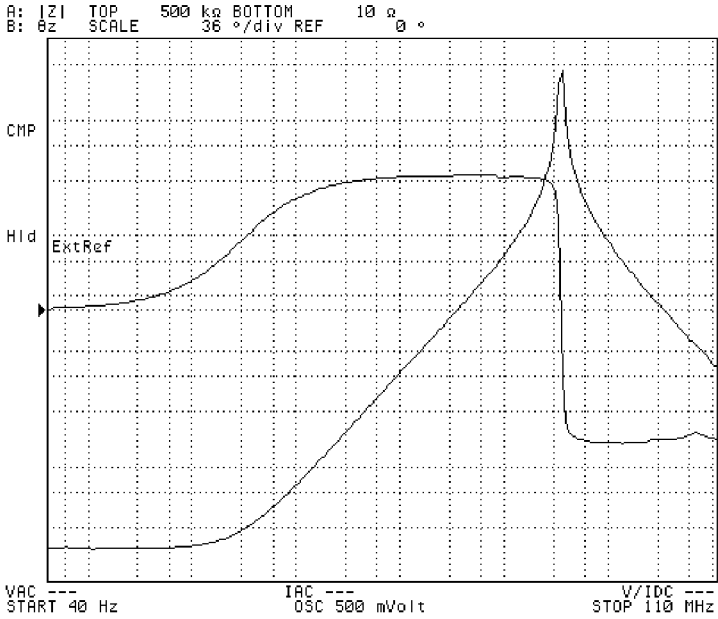

4294aoj007

Figure 5-2 Sweep by signal source current level

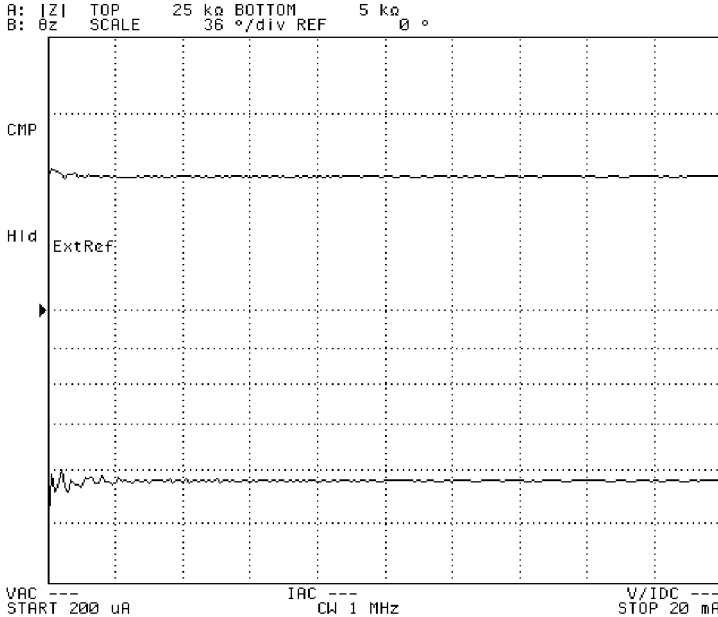

4294aoj008

Setting Measurement Conditions
Selecting Sweep Parameter

Figure 5-3

Sweep by dc current bias (Constant dc bias current mode)

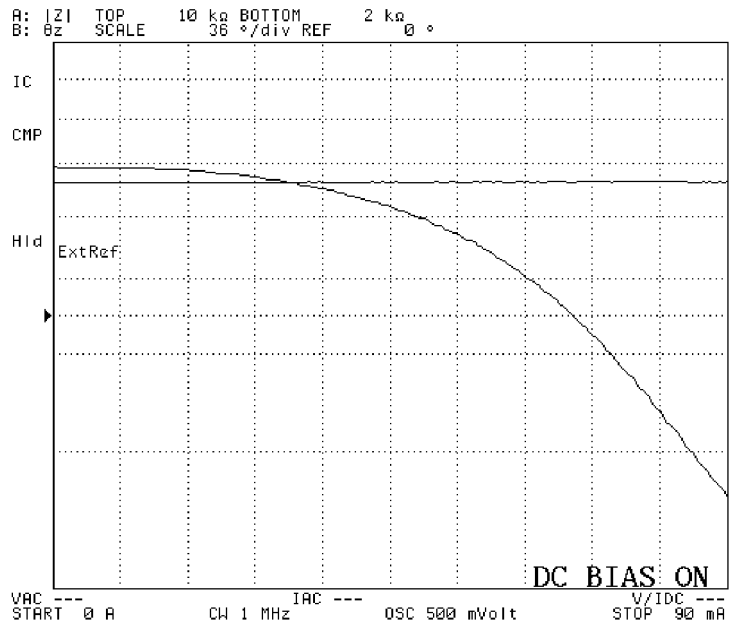

4294aaj009

Selecting Linear, Log, or List Sweep

- Step 1.** Press the [Sweep] key to display the sweep menu.
- Step 2.** Press the **TYPE []** key to display the sweep type menu.
- Step 3.** Press one of the following keys to select the sweep type.

Sweep type	Key stroke
Linear sweep	LINEAR
Log (logarithm) sweep	LOG
List sweep	LIST

NOTE

If the oscillator level or the dc bias is selected as the sweep parameter, you cannot select the log sweep. For how to select the sweep parameter, refer to Appendix , “Selecting Sweep Parameter,” on page 84.

List sweep cannot be selected unless a list sweep table is prepared. Refer to “Sweeping Multiple Sweep Ranges with Different Conditions in a Single Action (List Sweep)” on page 116 to create the list sweep table.

The sweep type that is currently selected appears in the key label [] of the **TYPE []** key.

Softkey label	Selected sweep parameter
TYPE [FREQ]	Linear sweep
TYPE [LOG]	Log sweep
TYPE [LIST]	List sweep

NOTE

The sweep type can be set to trace A and trace B in common. It is not necessary to select an active trace or to verify the current selection before setting the sweep type.

Setting Measurement Conditions
Selecting Linear, Log, or List Sweep

Figure 5-4

Linear sweep

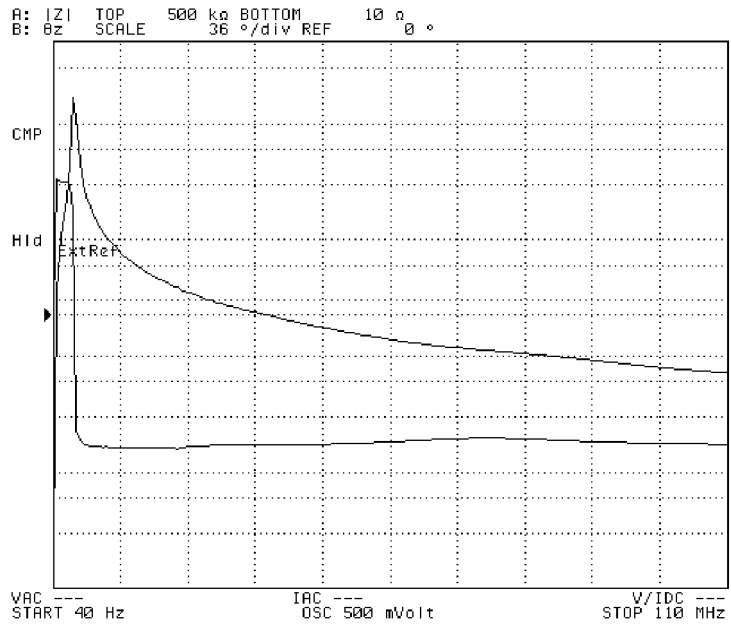

4294aaj010

Figure 5-5

Log (logarithm) sweep

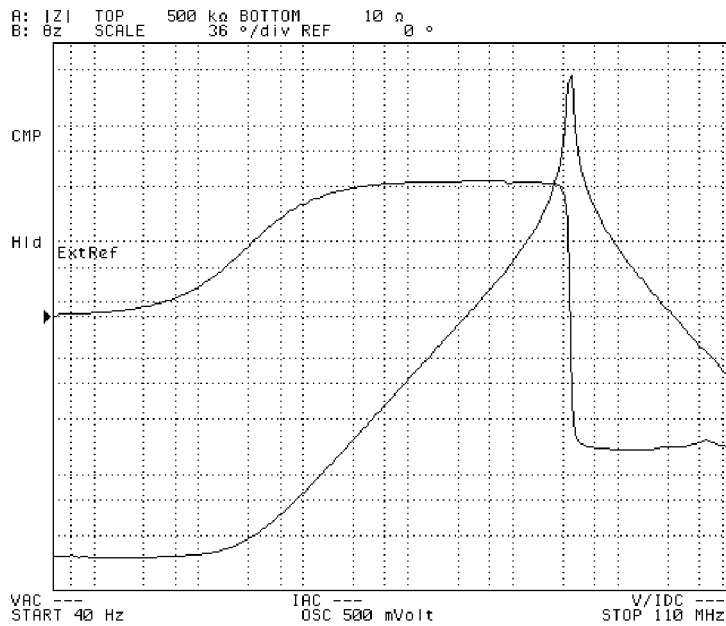

4294aaj011

Setting Sweep Range

Sweep range can be set by specifying either start and stop values or center and span values.

NOTE

The measurement range can be set to trace A and trace B in common. It is not necessary to select an active trace or to verify the current selection before setting the range.

Setting by start and stop values

- Step 1.** Press the **[Start]** key. This will display the current setting for sweep start value in the parameter settings area located in the upper-left part of the screen.
- Step 2.** Use the keys or the rotary knob in the ENTRY block in one of the following ways to specify a value for the sweep start.
- Enter the desired value with the numeric keys (**[0]** to **[9]**, **[.]**, and **[-]**) and then press one of the unit keys (**[G/n]**, **[M/ μ]**, **[k/m]**, or **[\times 1]**).
 - Turn the rotary knob (**(O)**) until the desired value is set.
 - Press the step keys (**(\uparrow)[\downarrow]**) to set the desired value.
- Step 3.** Press the **[Stop]** key. This will display the current setting for the sweep stop value in the parameter settings area in the upper-left part of the screen.
- Step 4.** Use the keys or the rotary knob in the ENTRY block in one of the following ways to specify a value for the sweep stop.
- Enter the desired value with the numeric keys (**[0]** to **[9]**, **[.]**, and **[-]**) and then press one of the unit keys (**[G/n]**, **[M/ μ]**, **[k/m]**, or **[\times 1]**).
 - Turn the rotary knob (**(O)**) until the desired value is set.
 - Press the step keys (**(\uparrow)[\downarrow]**) to set the desired value.

NOTE

When the sweep parameter is set to frequency, the sweep start value cannot be greater than the sweep stop value. Sweep with decreasing frequency can be possible by setting a sweep range with increasing frequency and then specifying a downward sweep direction. Refer to “Selecting Sweep Direction” on page 99 to specify the sweep direction.

Setting by center and span values

- Step 1.** Press the **[Center]** key. This will display the current setting for the sweep center value in the parameter settings area located in the upper-left part of the screen.
- Step 2.** Use the keys or the rotary knob in the ENTRY block in one of the following ways to specify a value for the sweep center.
- Enter the desired value with the numeric keys (**[0]** to **[9]**, **[.]**, and **[-]**) and then press one of the unit keys (**[G/n]**, **[M/ μ]**, **[k/m]**, or **[\times 1]**).
 - Turn the rotary knob (**(O)**) until the desired value is set.

Setting Measurement Conditions

Setting Sweep Range

- Press the step keys ([↑][↓]) to set the desired value.
- Step 3.** Press the **[Stop]** key. This will display the current setting for the sweep stop value in the parameter settings area in the upper-left part of the screen.
- Step 4.** Use the keys or the rotary knob in the ENTRY block in one of the following ways to specify a value for the sweep stop.
- Enter the desired value with the numeric keys ([0] to [9], [.] and [-]) and then press one of the unit keys ([G/n], [M/μ], [k/m], or [×1]).
 - Turn the rotary knob (○) until the desired value is set.
 - Press the step keys ([↑][↓]) to set the desired value.

Setting sweep range with marker

The sweep start value, sweep stop value, and sweep center value are set to the value indicated by the main marker on the trace. Also, the sweep span value can be set to the delta value between the main marker and Δ marker.

- Step 1.** Specify the active trace (the trace for setting) as the trace having the main marker that you want to use for setting a sweep range.

Active trace	Key stroke
Trace A	[A]
Trace B	[B]

- Step 2.** Move the main marker to the point you want to use as a new sweep start value, sweep stop value, or sweep center value. The main marker can be moved in either of the following ways.
- Press the **[Marker]** key to display the current sweep parameter value showing the current main maker's position in the parameter settings area in the upper-left part of the screen. Then, use the keys in the ENTRY block to move the main marker to the desired location.
 - Press the **[Search]** key to display the search menu. Then, use the search function with **MAX**, **MIN**, **TARGET**, and **PEAK** keys to locate the main marker to the desired position.

- Step 3.** Press the **[Marker →]** key to display the marker Æ menu.

- Step 4.** Select one of the following methods to specify the sweep start value, sweep stop value, or sweep center value as the location of the current main marker.

Setting sweep range	Key stroke
Specify a new sweep start value as the current main marker location.	MKR → START
Specify a new sweep stop value as the current main marker location.	MKR → STOP
Specify a new sweep center value as the current main marker location.	MKR → CENTER

Setting sweep range

Set the difference in the sweep parameter value between the current main marker position and the delta marker position¹ as the new sweep span value.

Search the trace for a peak² and specify a new sweep center value as the location of the peak found.

The current main marker position is set as the new sweep center value, and the new sweep span value is set depending on the specified zooming aperture³. As a result, the trace will be magnified (zoomed in) by focusing on the main marker position.

Key stroke

MKR Δ → SPAN

more 1/2 - PEAK → CENTER

more 1/2 - ZOOMING APERTURE to set the zooming aperture, and then **MKR ZOOM**

1. For how to use the main marker and the delta marker, refer to Chapter 8 , “Analysis and Processing of Result,” on page 211.
2. Refer to “Search the maximum/minimum peak” on page 228 and “Define the Peak” on page 232 for information on the peak search function.
3. For the ratio of the new sweep span value to the current sweep span value (%), you can set a value between 0.01% and 100% in steps of 0.01%. The power-on and preset settings are both 10%.

NOTE After you change the sweep range, the trace for the new sweep range will not be displayed unless you perform a new sweep measurement.

Figure 5-6 Before MKR → CENTER

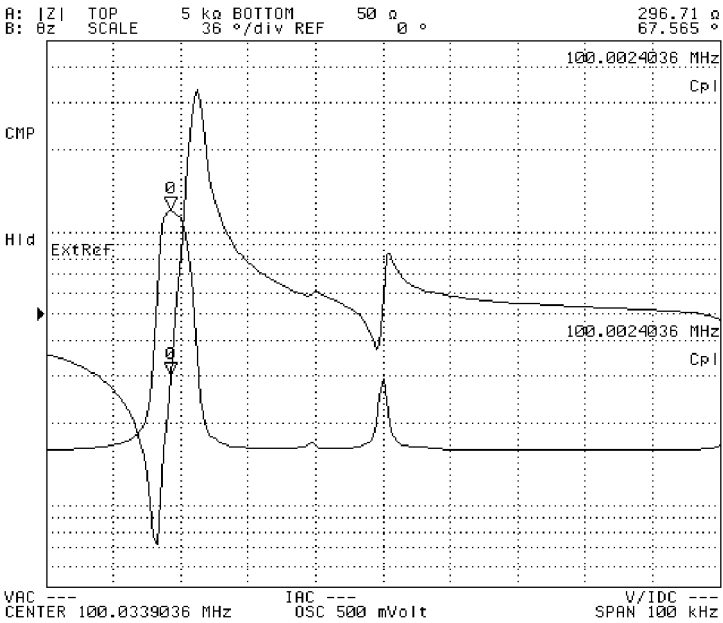

4294aoj012

Setting Measurement Conditions
Setting Sweep Range

Figure 5-7

After MKR → CENTER

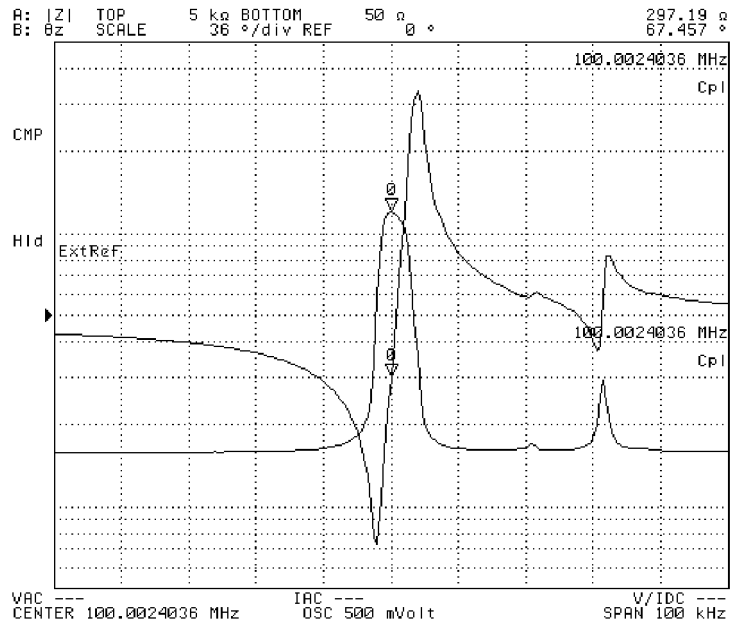

4294aoj013

Figure 5-8

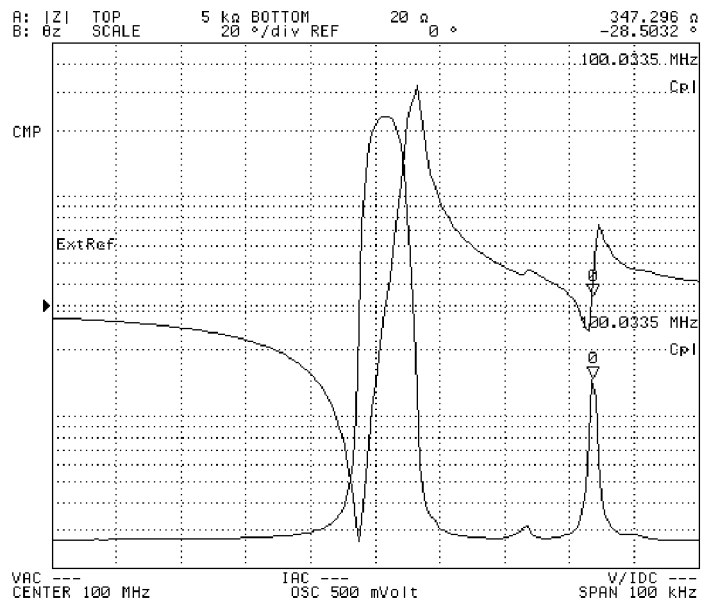

4294aoj114

Figure 5-9

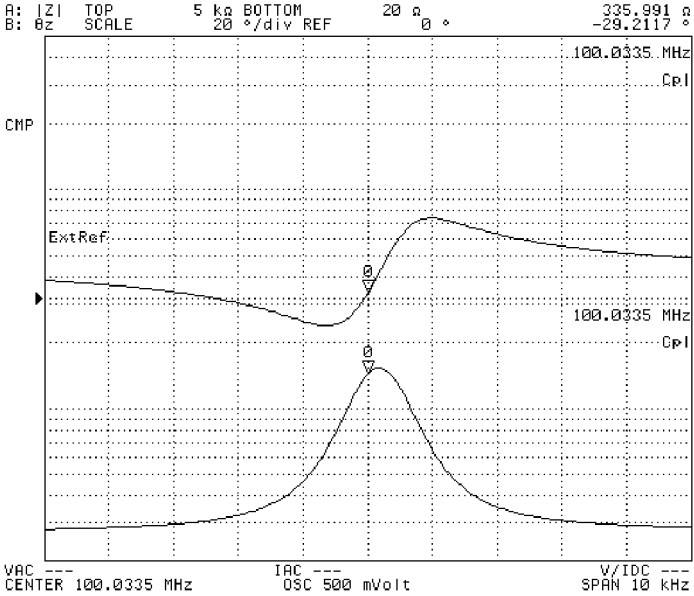

4294aoj115

Using Time as Sweep Parameter (Zero Span Sweep)

Setting the sweep span to zero allows you to perform a measurement with time as a sweep parameter. This kind of sweep is also called zero span sweep.

- Step 1.** Press the **[Sweep]** key to display the sweep menu.
- Step 2.** Press the **PARAMETER []** key to display the sweep parameter menu.
- Step 3.** Press the **FREQ** key to select frequency as a sweep parameter.
- Step 4.** Press the **[Span]** key. This will display the current setting for sweep span value in the parameter settings area in the upper-left part of the screen.
- Step 5.** Press **[0] - [×1]** to set the sweep span value to zero.
- Step 6.** Press the **[Center]** key. At this point, the value displayed in the parameter settings area in the upper-left part of the screen shows that the signal source used has a fixed, not swept, frequency.
- Step 7.** Use the keys or the rotary knob in the ENTRY block in one of the following ways to set the fixed frequency displayed on the screen.
 - Enter the desired value with the numeric keys (**[0]** to **[9]**, **[.]**, and **[-]**) and then press one of the unit keys (**[G/n]**, **[M/μ]**, **[k/m]**, or **[×1]**).
 - Turn the rotary knob (○) until the desired value is set.
 - Press the step keys (**[↑]****[↓]**) to set the desired value.
- Step 8.** Press the **[Sweep]** key to display the sweep menu.
- Step 9.** Press the **TIME** key to display the sweep time menu.
- Step 10.** Press the **SWEEP TIME** key. This will display the current setting for sweep time in the parameter settings area in the upper-left part of the screen. In other words, this shows the current sweep span value in the time sweep.
- Step 11.** Use the keys or the rotary knob in the ENTRY block in one of the following ways to specify a value for the sweep time (sweep span).
 - Enter the desired value with the numeric keys (**[0]** to **[9]**, **[.]**, and **[-]**) and then press one of the unit keys (**[G/n]**, **[M/μ]**, **[k/m]**, or **[×1]**).
 - Turn the rotary knob (○) until the desired value is set.
 - Press the step keys (**[↑]****[↓]**) to set the desired value.

NOTE

Sweep time (sweep span value) can be set up to 10,000 seconds (approx. 2.8 hours).

When using a marker immediately after setting the zero span sweep from the preset state, the sweep parameter value shown by the marker in the parameter settings area in the upper-left part of the screen is indicated by a measurement point number (serial number s from 1 to the number of points for all measurement points). At the same time, an identical value entered with the **[Center]** key for all measurement points is indicated in the marker sweep parameter area in the upper-right part of the screen. This sweep parameter value can be converted into a time-based value for display by pressing the

[Utility] - **MKR X-AXIS []** - **TIME** keys.

Sweep parameters other than frequency can be selected in Step 3. In such a case, the fixed value for the signal source is reflected in the selected parameter in Steps 5 and 6.

Settings for signal sources other than the fixed value in Steps 5 and 6 can be made in the signal source menu, which can be accessed by pressing the **[Source]** key.

The zero span sweep can also be achieved with the **[Start]** and **[Stop]** keys to specify the sweep start value and sweep stop value as the same value.

Figure 5-10 Sweep span value = 20 kHz

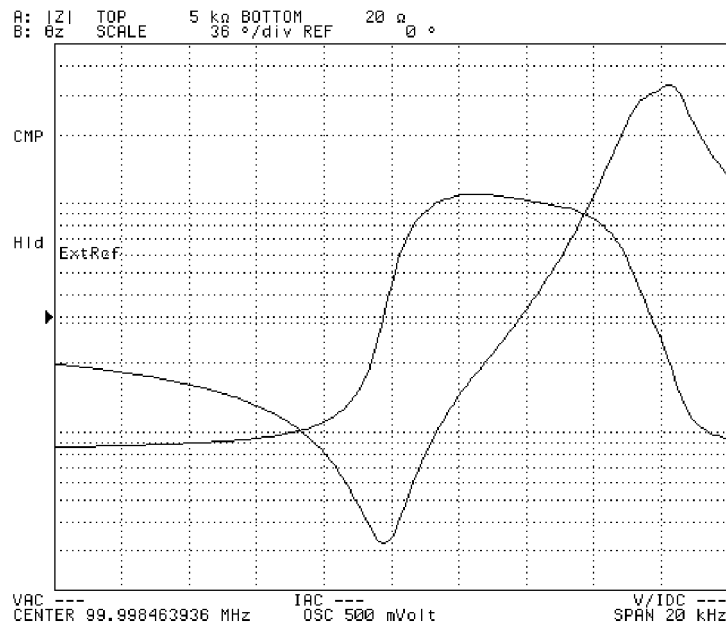

4294aoj014

Setting Measurement Conditions
Using Time as Sweep Parameter (Zero Span Sweep)

Figure 5-11 Sweep span value = 0 Hz (zero span sweep)

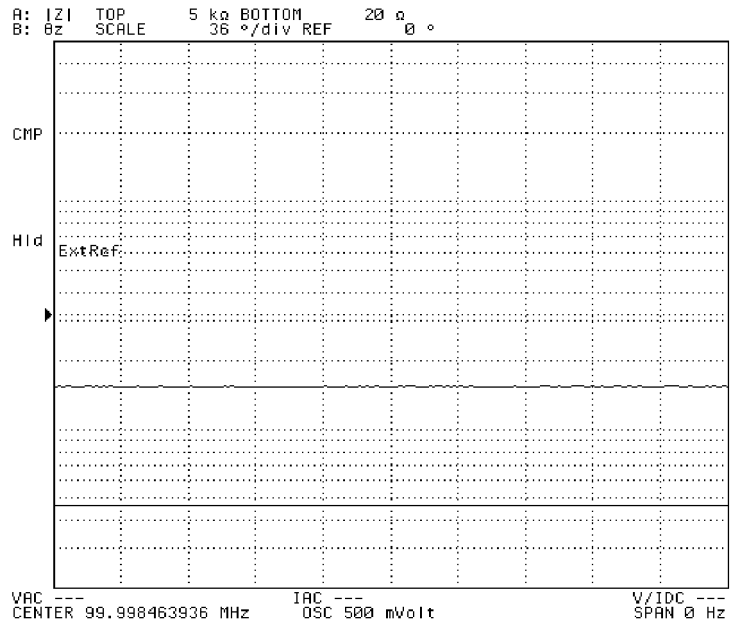

4294aoj015

Setting Number of Points (NOP)

- Step 1.** Press [Sweep] to display the sweep menu.
- Step 2.** Press the **NUMBER OF POINTS** key. This will display the current setting for number of points in the parameter settings area in the upper-left part of the screen.
- Step 3.** Use keys or the rotary knob in the ENTRY block in one of the following ways to specify a value for the number of points.
 - Enter the desired value with the numeric keys ([0] to [9]) and then press the [×1] key.
 - Turn the rotary knob (O) until the desired value is set.
 - Press the step keys ([↑][↓]) to set the desired value.

NOTE

The number of sweep points can be set to any integer from 2 to 801.

When list is selected as a sweep type (list sweep), use a list sweep table to set the number of points.

Setting the number of points is applied commonly to traces A and B.

Figure 5-12

Number of points: 51

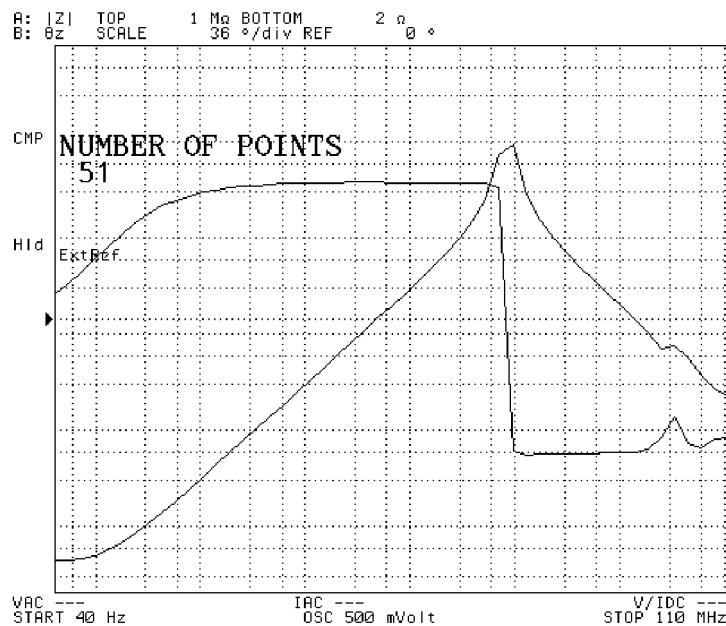

4294aoj016

Setting Measurement Conditions
Setting Number of Points (NOP)

Figure 5-13

Number of points: 801

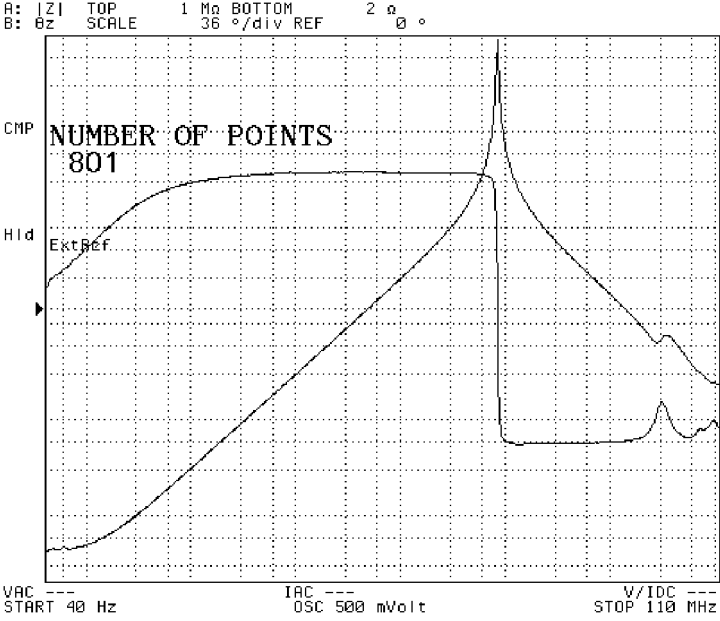

4294aoj017

Selecting Sweep Direction

DUT can be measured in the desired sweep direction when its characteristics has hysteresis with the sweep parameter.

- Step 1.** Press the **[Sweep]** key to display the sweep menu.
- Step 2.** Press the **DIRECTION []** key to select the desired sweep direction (pressing the key toggles the direction).

Softkey label	Selected sweep direction
DIRECTION [UP]	Upward (from sweep start value to sweep stop value)
DIRECTION [DOWN]	Downward (from sweep stop value to sweep start value)

NOTE Setting the sweep direction is applied commonly to traces A and B.

Manual Sweep (Measurement at a Specified Point)

In the normal sweep mode, the Agilent 4294A performs measurement by automatically changing the measurement point in response to triggering. When the set of measurements performed is as many as the number of points, this is regarded as one sweep. On the other hand, in the manual sweep mode the Agilent 4294A does not automatically change measurement points (sweep), and the measurement at a single point specified by the user is regarded as one sweep. Since the measurement point can be arbitrarily specified by the user, this function can be called a user-defined manual sweep. The Agilent 4294A will continue measurement (sweep) at the same point unless it is changed by the user. Follow the steps below to execute the manual sweep.

- Step 1.** Press the **[Sweep]** key to display the sweep menu.
- Step 2.** Press the **MANUAL SWP on OFF** key to turn the manual sweep function ON. This changes the softkey label to **MANUAL SWP ON off**. At the same time, the current measurement point “1” for manual sweep and sweep parameter value for the point are displayed in the parameter settings area located in the upper left of the screen.
- Step 3.** Use the keys or the rotary knob in the ENTRY block in one of the following ways to specify the measurement point (any integer value from 1 to the number of points).
- Enter the desired value with the numeric keys (**[0]** to **[9]**, **[.]**, and **[-]**) and then press the **[×1]** key.
 - Turn the rotary knob (○) until the desired value is set.
 - Press the step keys (**[↑]**/**[↓]**) to set the desired value.

NOTE

Instead of directly setting the measurement point by using the keys or the rotary knob in the ENTRY block, it can be set by moving the main marker to your desired point for the manual sweep and pressing the **[Marker →] - MKR → MANUAL SWP** keys. This operation can assign the manual sweep point to the location of the main marker and is effective before activating the manual sweep.

When you turn the sweep function ON and specify a measurement point, no measurement is performed at the point as long as the sweep mode is disabled or the trigger is not generated.

The number of points can be commonly set to traces A and B.

Figure 5-14 Manual Sweep

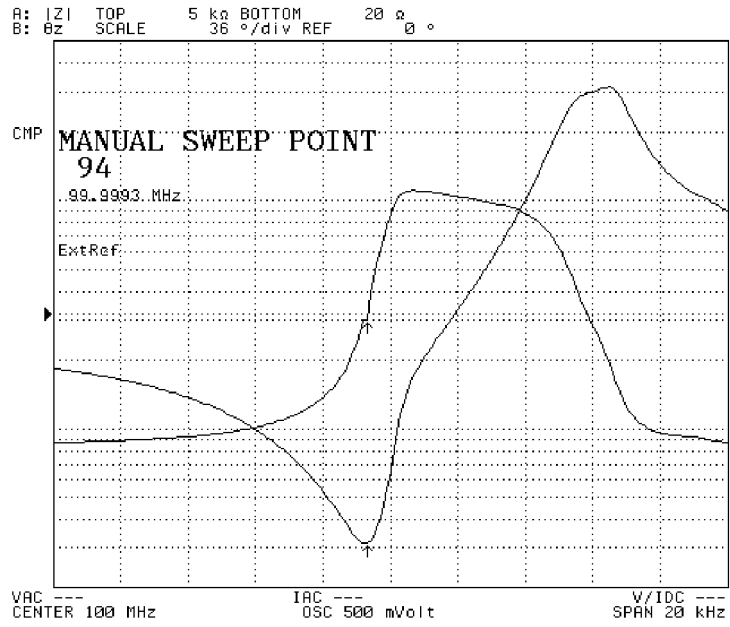

4294aoj018

Setting Time Delay for Measurement

Time delay can be set for the period before sweep or actual measurement starts after the measurement signal is applied to DUT. This function is useful, for example, when a certain period is required before the characteristics of DUT become stable after the signal is applied. Another application of this function is to observe changes in impedance of DUT in the time domain for a long span.

Setting with sweep time

Setting the time period for an entire sweep (sweep time) makes it possible to set equal time delays (time delay at a measurement point): from applying the signal to starting measurement and then to each measurement point.

- Step 1.** Press the **[Sweep]** key to display the sweep menu.
- Step 2.** Press the **TIME** key to display the sweep time menu.
- Step 3.** Press the **SWEEP TIME** key. This will display the current setting for the sweep time value in the parameter settings area in the upper-left part of the screen.
- Step 4.** Use the keys or the rotary knob in the ENTRY block in one of the following ways to specify a value for the sweep time.
 - Enter the desired value with the numeric keys (**[0]** to **[9]**, **[.]**, and **[-]**) and then press one of the unit keys (**[G/n]**, **[M/ μ]**, **[k/m]**, or **[\times 1]**).
 - Turn the rotary knob (**○**) until the desired value is set.
 - Press the step keys (**[↑]****[↓]**) to set the desired value.

Setting with time delay at measurement point

Time delay for each measurement point (time delay at a measurement point) can be directly set.

- Step 1.** Press the **[Sweep]** key to display the sweep menu.
- Step 2.** Press the **TIME** key to display the sweep time menu.
- Step 3.** Press the **POINT DELAY** key. This will display the current setting for the time delay at a point in the parameter settings area in the upper-left part of the screen.
- Step 4.** Use the keys or the rotary knob in the ENTRY block in one of the following ways to specify a value for the time delay at a measurement point.
 - Enter the desired value with the numeric keys (**[0]** to **[9]**, **[.]**, and **[-]**) and then press one of the unit keys (**[G/n]**, **[M/ μ]**, **[k/m]**, or **[\times 1]**).
 - Turn the rotary knob (**○**) until the desired value is set.
 - Press the step keys (**[↑]****[↓]**) to set the desired value.

Setting with sweep time delay

Time delay can be set at the point before sweep starts.

- Step 1.** Press the **[Sweep]** key to display the sweep menu.
- Step 2.** Press the **TIME** key to display the sweep time menu.
- Step 3.** Press the **SWEEP DELAY** key. This will display the current setting for the sweep time delay in the parameter settings area in the upper-left part of the screen.
- Step 4.** Use the keys or the rotary knob in the ENTRY block in one of the following ways to specify a value for the sweep time delay.
 - Enter the desired value with the numeric keys (**[0]** to **[9]**, **[.]**, and **[-]**) and then press one of the unit keys (**[G/n]**, **[M/ μ]**, **[k/m]**, or **[\times 1]**).
 - Turn the rotary knob (**O**) until the desired value is set.
 - Press the step keys (**[\uparrow]**/**[\downarrow]**) to set the desired value.

Setting Fixed Frequency (CW Frequency)

Follow the steps below to specify a fixed frequency for the signal source when the sweep parameter is any item other than frequency (i.e., oscillator level or dc bias).

- Step 1.** Press the **[Source]** key to display the signal source menu.
- Step 2.** Press the **FREQUENCY** key. This will display the current setting for the fixed frequency for the segment in the parameter settings area in the upper-left part of the screen.
- Step 3.** Use the keys or the rotary knob in the ENTRY block in one of the following ways to specify a value for the fixed frequency.
- Enter the desired value with the numeric keys (**[0]** to **[9]**, **[.]**, and **[-]**) and then press one of the unit keys (**[G/n]**, **[M/ μ]**, **[k/m]**, or **[\times 1]**).
 - Turn the rotary knob (**(O)**) until the desired value is set.
 - Press the step keys (**[\uparrow]**/**[\downarrow]**) to set the desired value.

Setting Oscillator Level

Follow the steps below to specify a fixed oscillator level (AC level) when the sweep parameter is any item other than oscillator level (i.e., frequency or dc bias).

- Step 1.** Press the **[Source]** key to display the signal source menu.
- Step 2.** Press the **LEVEL** key. This will display the current setting for the fixed oscillator level for the segment in the parameter settings area in the upper-left part of the screen.
- Step 3.** Use the keys or the rotary knob in the ENTRY block in one of the following ways to specify a value for the fixed oscillator level.
- Enter the desired value with the numeric keys (**[0]** to **[9]**, **[.]**, and **[-]**) and then press one of the unit keys (**[G/n]**, **[M/μ]**, **[k/m]**, or **[×1]**).
 - Turn the rotary knob (**O**) until the desired value is set.
 - Press the step keys (**[↑]****[↓]**) to set the desired value.

NOTE

See “Selecting Unit for Oscillator Level (Voltage or Current)” on page 106 for selecting unit (voltage or current) of the fixed oscillator level.

Selecting Unit for Oscillator Level (Voltage or Current)

- Step 1.** Press the [Source] key to display the signal source menu.
- Step 2.** Press the **OSC UNIT []** key to select the unit for setting and displaying the oscillator level (pressing the key toggles the selection).

Softkey label	Selected unit for oscillator level
OSC UNIT [VOLT]	Voltage
OSC UNIT [CURR]	Current

NOTE

The unit specified for oscillator level through the steps above will be applied to the unit for oscillator level sweep (voltage level sweep or current level sweep) and the unit for the fixed oscillator level when sweeping parameters other than oscillator level. The setting for the unit will not affect the setting for the signal source level monitoring function, since the function displays both voltage and current levels.

Settings of the unit for oscillator level are commonly applied to traces A and B. Accordingly, you do not need to select and verify an active trace before setting.

Setting and Applying dc Bias

Follow the steps below to apply dc bias to DUT, regardless of whether you plan to sweep by dc bias.

1. Selecting dc bias mode

- Step 1.** Press the **[Source]** key to display the signal source menu.
- Step 2.** Press the **BIAS MENU** key to display the dc bias menu.
- Step 3.** Press the **MODE []** key to display the dc bias mode menu.
- Step 4.** Select the dc bias mode.

dc bias mode	Key stroke
Voltage source (non-constant voltage mode)	VOLT
Current source (non-constant current mode)	CURRENT
Voltage source (constant voltage mode)	VOLT CONSTANT
Current source (constant current mode)	CURRENT CONSTANT

- Step 5.** Press the **return** key to return to the dc bias menu. Note that the dc bias mode currently selected is displayed in the key label **[]** of the **MODE []** key.

Softkey label	Selected dc bias mode
MODE [VOLT]	Voltage source (non-constant voltage mode)
MODE [CURR]	Current source (non-constant current mode)
MODE [C-VOLT]	Voltage source (constant voltage mode)
MODE [C-CURR]	Current source (constant current mode)

2. Setting fixed dc bias level

When the sweep parameter is not dc bias, select the dc bias mode and then follow the steps below to set dc bias level.

NOTE

Follow the steps shown in “Setting Sweep Range” on page 89 to set the sweep range when the sweep parameter is dc bias.

- Step 1.** Press the **VOLTAGE LEVEL** key if voltage source is selected for dc bias mode or the **CURRENT LEVEL** key if current source is selected. This will display the current setting for the dc voltage or the current bias level for the segment in the parameter settings located in the upper left area of the screen.
- Step 2.** Use the keys or rotary knob of the ENTRY block in one of the following ways to specify a value for the dc voltage or current bias level.

Setting Measurement Conditions

Setting and Applying dc Bias

- Enter the desired value with the numeric keys ([0] to [9], [.] and [-]) and then press the unit key ([G/n], [M/ μ], [k/m], or [\times 1]).
- Turn the rotary knob (O) until the desired value is set.
- Press the step keys ([\uparrow][\downarrow]) to set the desired value.

3. Setting limits for dc voltage

When constant voltage or current is selected for the dc bias mode, follow the steps below to set limit values for the voltage (upper and lower limits) in order to protect the DUT being measured.

- Step 1.** Press the **MAX LIMIT VOLTAGE** key. This will display the current setting for the upper limit of dc voltage for the segment in the parameter settings located in the upper left area of the screen.
- Step 2.** Use the keys or rotary knob of the ENTRY block in one of the following ways to specify a value for the upper limit of dc voltage.
- Enter the desired value with the numeric keys ([0] to [9], [.] and [-]) and then press the unit key ([G/n], [M/ μ], [k/m], or [\times 1]).
 - Turn the rotary knob (O) until the desired value is set.
 - Press the step keys ([\uparrow][\downarrow]) to set the desired value.
- Step 3.** Press the **MIN LIMIT VOLTAGE** key. This will display the current setting for the lower limit of dc voltage for the segment in the parameter settings located in the upper left area of the screen.
- Step 4.** Use the keys or rotary knob of the ENTRY block in one of the following ways to specify a value for the lower limit of dc voltage.
- Enter the desired value with the numeric keys ([0] to [9], [.] and [-]) and then press the unit key ([G/n], [M/ μ], [k/m], or [\times 1]).
 - Turn the rotary knob (O) until the desired value is set.
 - Press the step keys ([\uparrow][\downarrow]) to set the desired value.

NOTE

When the dc bias applied to DUT exceeds the upper or lower voltage limit specified in the above procedure, the error message “dcBIAS CONSTANT OPERATION FAILED” (error number: 138) will be displayed in the instrument message area in the upper left part of the screen.

The dc voltage limit values specified by the **MAX LIMIT VOLTAGE** or **MIN LIMIT VOLTAGE** key take effect when the dc bias mode is constant voltage or current. The setting for these values is disabled when the dc bias mode is set to non-constant voltage or current mode.

4. Setting dc bias range to 1 mA

Set the dc bias range before turning the dc bias ON. The dc bias range is set to optimize the dc current given to the impedance measurement circuit. This setting affects the accuracy of impedance measurement regardless of which dc bias mode is selected or whether dc bias is turned ON or OFF. Normally, maximum accuracy can be obtained by setting the dc bias

range as narrow as possible without causing the error message “DCBIAS OVERLOAD” (error number: 137) to appear. An initial dc bias range of 1 mA is recommended for the first measurement when dc bias is applied.

NOTE When you do not apply dc bias, always set the dc bias range to 1 mA, which is the preset setting. Keeping this setting is especially important when you run through the sequence of applying dc bias, turning off dc bias, and then performing a measurement.

- Step 1.** Press the **MEAS RANGE []** key to display the dc bias range menu.
- Step 2.** Press the **1mA** key to select 1 mA as the dc bias range (preset state is 1 mA).
- Step 3.** Press the **return** key to return to the dc bias menu.

NOTE Always set the dc bias range to 1 mA when you measure without applying dc bias.

5. Turning dc bias ON or OFF

- Step 1.** Press the **BIAS on OFF** (or **BIAS ON off**) key to make your selection (pressing the key toggles your selection).

Softkey label	Applied dc bias
DC BIAS on OFF	Off
DC BIAS ON off	On

NOTE When the error message “CAUTION: DCBIAS OVERLOAD” (error number: 137) appears in the instrument message area in the upper left part of the screen after turning dc bias ON, follow the steps given in “6. Optimizing dc bias range” to set the appropriate range for the dc bias.

Turning dc bias ON displays “DC BIAS ON” in the lower right area of the screen and also shows the application status of the dc bias (indicating dc bias mode and whether dc voltage exceeds the limits). See “dc bias status” on page 57 for details.

6. Optimizing dc bias range

- Step 1.** When the error message “CAUTION: DCBIAS OVERLOAD” (error number: 137) appears after applying dc bias, increase the dc bias range by 1 step until the message disappears. Then select the narrowest possible range.

dc bias range	Key stroke
1 mA	1mA
10 mA	10mA
100 mA	100mA

- Step 2.** Press the **return** key to return to the dc bias menu. Note that the dc bias range currently

Setting Measurement Conditions
Setting and Applying dc Bias

selected is displayed in the key label [] of the **MEAS RANGE []** key.

Softkey label	Selected dc bias range
MEAS RANGE [1mA]	1 mA
MEAS RANGE [10mA]	10 mA
MEAS RANGE [100mA]	100 mA

NOTE

If the message “CAUTION: DCBIAS OVERLOAD” (error number: 137) still appears even when the dc bias range is set to 100 mA, the connected DUT requires a dc bias with a current that exceeds the maximum dc bias current (100 mA) provided by the Agilent 4294A. In this case, decrease the dc bias voltage level to avoid the error.

Figure 5-15 Characteristics of Capacitance of Varactor Diode versus dc Bias Voltage

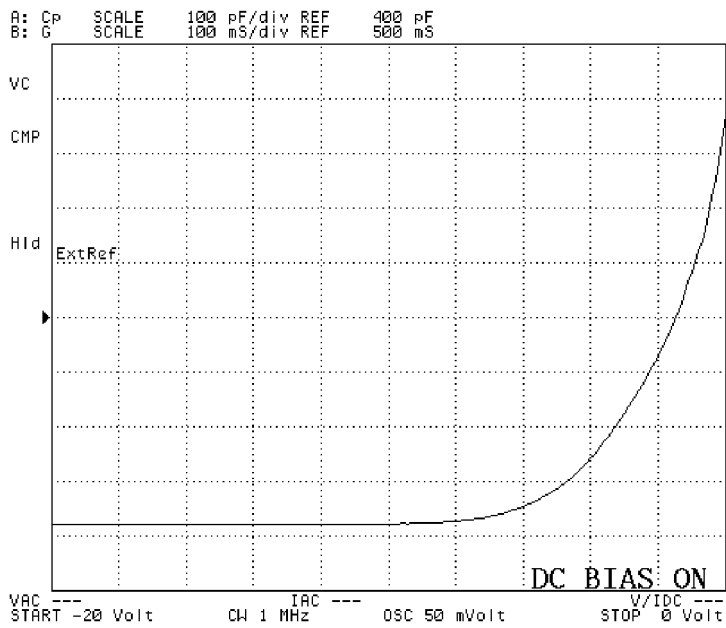

4294aoj019

Selecting a Method to Start Measurement (Trigger Source)

Follow the steps below to select a trigger source, the cue generator for starting your measurement.

- Step 1.** Press the **[Trigger]** key to display the trigger menu.
- Step 2.** Press the **SOURCE []** key to display the trigger source menu.
- Step 3.** Use the following keys to select the trigger source.

Trigger source	Key stroke
Internal (continuous triggering automatically generated in the 4294A; also called free-run)	FREE RUN
External (triggering with a signal from the external trigger input terminal on the rear panel)	EXTERNAL
GP-IB/LAN (triggering generated with a trigger command transferred via GP-IB or LAN for starting measurement.)	HP-IB/LAN
Manual (triggering generated by pressing MANUAL key)	MANUAL

NOTE

See Chapter 10 , “Specifications and Supplemental Performance Characteristics,” on page 323 for characteristics of the signal required for an external trigger (triggering with a signal from the external trigger input terminal on the rear panel).

See the “Programming Guide” for details on how to use the GP-IB/LAN trigger.

The trigger source currently selected is displayed in the key label [] of the **SOURCE []** key.

Softkey label	Selected trigger source
SOURCE [FREE RUN]	Internal (free-run)
SOURCE [EXTERNAL]	External
SOURCE [HP-IB]	GP-IB/LAN
SOURCE [MANUAL]	Manual

Selecting Sweep Trigger/Measurement Point Trigger

You can select whether the event to be triggered (the trigger event) is a single sweep or a measurement at a single point.

- Step 1.** Press the **[Trigger]** key to display the trigger menu.
- Step 2.** Press the **SOURCE []** key to display the trigger source menu.
- Step 3.** Press the **EVENT []** key to select the event to be triggered (pressing the key toggles the selection).

Softkey label	Selected trigger event
EVENT [ON SWEEP]	Sweep (a single sweep for one time trigger)
EVENT [ON POINT]	Measurement point (a measurement at a single point for one time trigger)

NOTE

If the internal trigger (free-run) is selected in “Selecting a Method to Start Measurement (Trigger Source)” on page 111, the sweep specified in “Specifying Sweep Times and Stopping Sweep” on page 114 is performed regardless of which trigger event is selected. Note that a sweep takes a longer time when measurement point is selected for the trigger event than when sweep is selected. This is because the instrument requires an additional process to trigger measurement at each point.

Selecting Polarity of External Trigger Input Signal

You can specify the polarity of the signal given to the external trigger input terminal on the rear panel by following the procedure below.

- Step 1.** Press the **[Trigger]** key to display the trigger menu.
- Step 2.** Press the **SOURCE []** key to display the trigger source menu.
- Step 3.** Press the **EXT POLRITY []** key to select the polarity of the external trigger input signal (pressing the key toggles the selection).

Softkey label	Selected polarity of external trigger signal
EXT POLRITY [POS]	Positive (leading edge of TTL signal is detected for triggering)
EXT POLRITY [NEG]	Negative (trailing edge of TTL signal is detected for triggering)

NOTE

See Chapter 10 , “Specifications and Supplemental Performance Characteristics,” on page 323 for characteristics of the signal required for the external trigger (triggering with signal given to the external trigger terminal on the rear panel).

Specifying Sweep Times and Stopping Sweep

You can specify the number of times sweeping is actually executed upon occurrence of a trigger. After sweeping is repeated the specified times, the sweeping is stopped and no further sweeping is executed by any trigger that may follow. You can also set the sweeping to unlimited times (continuous sweep).

Sweeping by specified times and stopping a sweep are selected and executed by a sweep mode. Pressing the **[Trigger]** key will display the following sweep modes:

Softkey label	Sweep mode
HOLD	Stopping sweep
SINGLE	Single sweep
NUMBER OF GROUPS	Sweeping by specified times
CONTINUOUS	Sweeping unlimited times (continuous sweep)

The operating instructions for each sweep mode are shown below.

Single sweep

- Step 1.** Press the **[Trigger]** key to display the trigger menu.
- Step 2.** Press the **SINGLE** key once to select single sweep.
- Step 3.** Use the method selected in “Selecting a Method to Start Measurement (Trigger Source)” on page 111 to trigger. When the triggered single sweep ends, sweeping is put into the stopping (hold) state. No further sweeping can be triggered after it is stopped.

NOTE

When the internal trigger (free-run) is selected in “Selecting a Method to Start Measurement (Trigger Source)” on page 111, new sweeping starts immediately after step 2 above is performed, and sweeping is put into the stopping state after a single sweep ends. This means that only pressing the **SINGLE** key will allow you to perform a single sweep.

Sweep by specified times

- Step 1.** Press the **[Trigger]** key to display the trigger menu.
- Step 2.** Press the **NUMBER OF GROUPS** key. This will display the current value for the number of sweeps (sweep groups) to be swept out of the specified number of sweeps in the parameter settings located in the upper left area of the screen.
- Step 3.** Use the numeric keys in the ENTRY block (**[0]** to **[9]**) to input a new value for the number of sweeping times and then press the **[×1]** key.

NOTE

The number of sweeping times described above cannot be entered with the rotary knob (○) or step key ([↑][↓]).

- Step 4.** Use the method selected in “Selecting a Method to Start Measurement (Trigger Source)” on page 111 to trigger. When the triggered single sweep ends, sweeping is put into the

stopping (hold) state. No further sweeping can be triggered after it is stopped.

NOTE

When the internal trigger (free-run) is selected in “Selecting a Method to Start Measurement (Trigger Source)” on page 111, new sweeping starts immediately after step 3 above is performed, and sweeping is put into the stopping state after sweeping is repeated the number of times specified. This means that only specifying the number of sweeping times will allow you to repeat sweeping as many times as you specify.

NOTE

The number of sweeping times can be set to an integer ranging from 1 to 999. Specifying the number of sweeping times to 1 is equivalent to executing “Single sweep” on page 114. When you specify the number of sweeping times as that set by sweep-to-sweep averaging, you can stop the sweeping after the repetitions reach the number indicated by sweep-to-sweep averaging.

Sweep with unlimited times (continuous sweep)

- Step 1.** Press the **[Trigger]** key to display the trigger menu.
- Step 2.** Press the **CONTINUOUS** key to select continuous sweep.

NOTE

When continuous sweep is selected, sweeping can be repeated unlimited times after it is triggered. Press the **HOLD** key to stop the sweeping. No further sweeping can be triggered after it is stopped.

Stopping sweep

- Step 1.** Press the **[Trigger]** key to display the trigger menu.
- Step 2.** Press the **HOLD** key to stop the sweep.

NOTE

Pressing the **HOLD** key immediately stops sweeping, regardless of which sweeping state (single, specified times, or continuous) is selected. No further sweeping can be triggered after it is stopped.

Sweeping Multiple Sweep Ranges with Different Conditions in a Single Action (List Sweep)

If you select the linear sweep or log (logarithmic) sweep as the sweep type setting, the actual measurement points are automatically determined depending on the settings of the sweep range and the number of measurement points. For a list sweep, on the other hand, the user sets the number of measurement points, oscillator level, dc bias level, measurement bandwidth, and point averaging count for individual frequency sweep range units called segments, and then all of the segments are swept in a single sweep in the specified order.

The advantage of a list sweep is that, by setting efficient and optimum measurement conditions for each specified frequency range (segment), the efficiency (speed) of measurement for a single sweep can be improved. Furthermore, a list sweep permits the following strategies.

- You can perform sweep measurement for the range of your interest, skipping frequency ranges you do not need to measure.
- You can set optimum measurement conditions for each specified frequency range (segment). For example, for segments you want to measure with higher stability, higher accuracy, and higher (finer) frequency resolution, you can increase the averaging count, the measurement bandwidth, and the number of measurement points, while, for other segments, specifying conditions to speed up the measurement.
- You can use the list sweep to compare traces under different measurement conditions. For example, by setting all segments to the same frequency range and changing conditions such as oscillator level or dc bias level for each segment, you can observe the change in the characteristics. In this case, you would usually set the horizontal axis of the graph to the single span mode, which is the frequency axis common to all segments. For how to compare traces using the list sweep function, refer to “Comparing traces using the list sweep function” on page 186.

For the list sweep, you can change the color of traces for each segment. This function will help you to compare traces.

Setting Measurement Conditions
Sweeping Multiple Sweep Ranges with Different Conditions in a Single
Action (List Sweep)

Figure 5-16

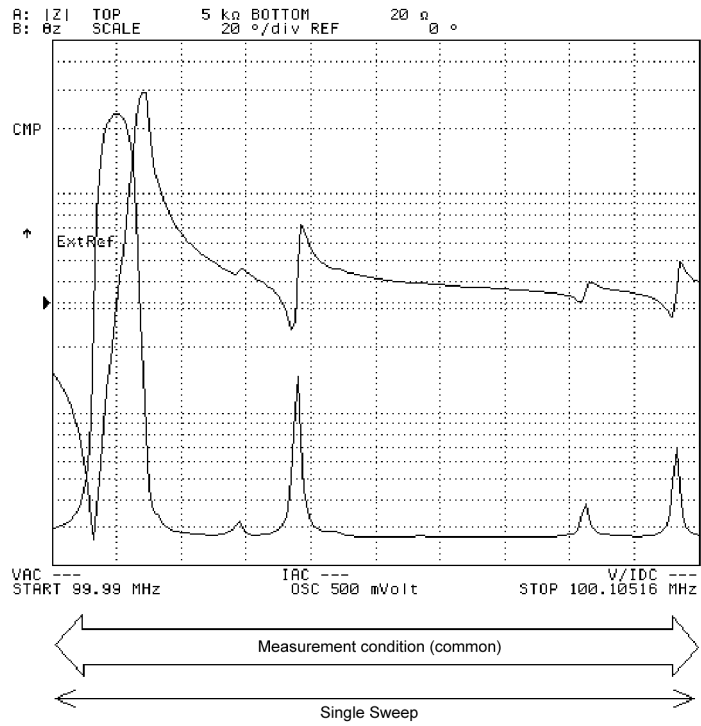

4294aoe102

Setting Measurement Conditions
Sweeping Multiple Sweep Ranges with Different Conditions in a Single Action (List Sweep)

Figure 5-17

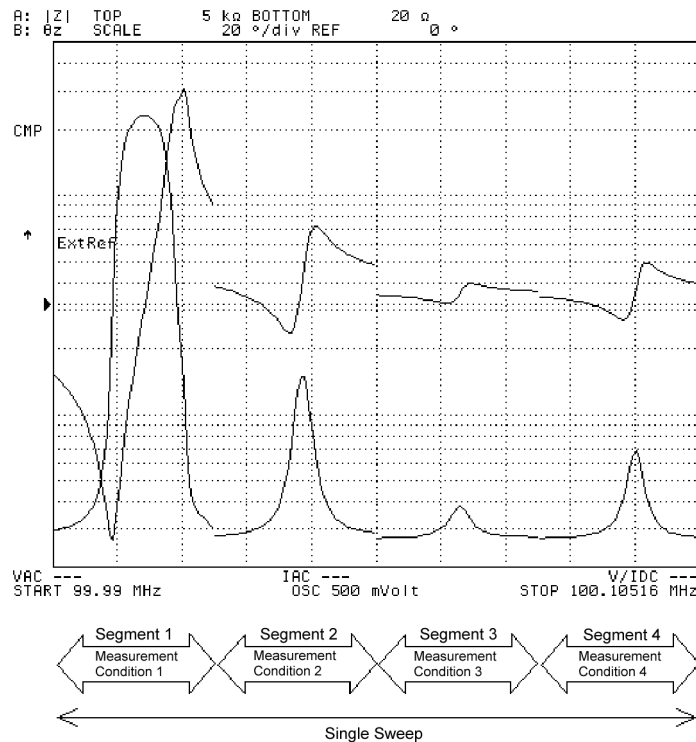

Measurement condition items that can be specified for each segment in the list sweep are:
 Sweep range, Number of points (NOP), Oscillator mode/level, DC bias mode/level,
 Measurement bandwidth, Point averaging factor, Trace color (pen number).

4294a0e103

Preparing list sweep table

Set the list sweep with the list sweep table.

- Step 1.** Press the **[Sweep]** key to display the sweep menu.
- Step 2.** Press the **EDIT LIST** key to enter the list sweep table edit mode. At the same time, the list sweep menu appears.

Figure 5-18

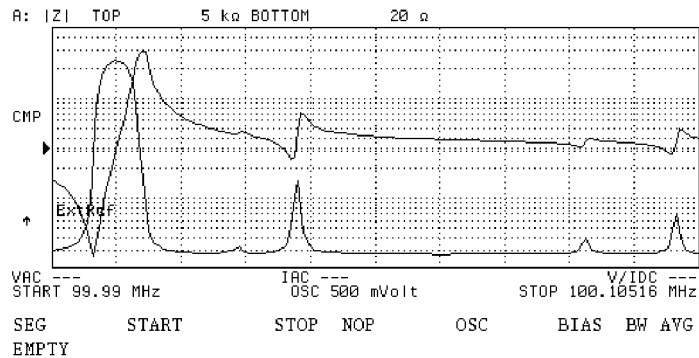

4294aoj104

- Step 3.** Press the **ADD** key to add a new segment to the list sweep table. This operation also displays the segment edit menu (1/3). The segment added to the list sweep table contains predefined initial values.
- Step 4.** Press the **START** key or the **CENTER** key. This will display the current setting for start frequency or sweep center frequency in the parameter settings located in the upper left area of the screen.
- Step 5.** Use the keys or rotary knob of the ENTRY block in one of the following ways to specify a value for the sweep start frequency or sweep center frequency.
- Enter the desired value with the numeric keys (**[0]** to **[9]**, **[.]**, and **[-]**) and then press the unit key (**[G/n]**, **[M/μ]**, **[k/m]**, or **[×1]**).
 - Turn the rotary knob (**○**) until the desired value is set.
 - Press the step keys (**[↑]**/**[↓]**) to set the desired value.
- The above setting will add a new value for the sweep start or center frequency to the cell in the segment row and the sweep start/center frequency column (START or CENTER) of the list sweep table in editing mode.
- Step 6.** Press the **STOP** key if the sweep start frequency is initially set or the **SPAN** key if the sweep center frequency is initially set. This will display the current setting for the sweep stop frequency or sweep span frequency for the segment in the parameter settings located in the upper left area of the screen.
- Step 7.** Use the keys or rotary knob of the ENTRY block in one of the following ways to specify a value for the sweep stop frequency or sweep span frequency.
- Enter a desired value with the numeric keys (**[0]** to **[9]**, **[.]**, and **[-]**), then press the unit key (**[G/n]**, **[M/μ]**, **[k/m]**, or **[×1]**).
 - Turn the rotary knob (**○**) until a desired value is set.
 - Press the step keys (**[↑]**/**[↓]**) to set a desired value.

Setting Measurement Conditions

Sweeping Multiple Sweep Ranges with Different Conditions in a Single Action (List Sweep)

The above setting will add a new value for the sweep stop or span frequency to the cell located in the segment row and the sweep stop/span frequency column (START or CENTER) of the list sweep table in editing mode.

Step 8. Press **NUMBER OF POINTS** key. This will display the current setting for the number of points for the segment in the parameter settings area located in the upper left of the screen.

Step 9. Use keys or the rotary knob of ENTRY block in one of the following way to specify a value for the number of points.

- Enter the desired value with the numeric keys (**[0]** to **[9]**, and **[.]**) and then press the **[×1]** key.
- Turn the rotary knob (**○**) until the desired value is set.
- Press the step keys (**[↑]****[↓]**) to set the desired value.

The above setting will add a new value for the number of points to the cell located in the segment row and the number of points column (NOP) of the list sweep table in editing mode.

NOTE

The number of points that can be set for a single segment is an integer ranging from 2 to 201. Up to 801 points can be set to any segment.

Step 10. Press the **more 1/3** key to display the second page of the segment edit menu.

Step 11. Press the **OSC MODE []** key to select a signal source mode (pressing the key toggles the mode).

Softkey label	Selected signal source mode
OSC MODE [VOLT]	Voltage source mode
OSC MODE [CURR]	Current source mode

The setting above will modify the unit, according to the selected mode, in the cell located in the segment row and the oscillator level column (OSC) of the list sweep table in editing mode.

Step 12. Press the **OSC LEVEL** key. This will display the current setting for the oscillator level for the segment in the parameter settings located in the upper left area of the screen.

Step 13. Use the keys or rotary knob of the ENTRY block in one of the following ways to specify a value for the oscillator level.

- Enter the desired value with the numeric keys (**[0]** to **[9]**, **[.]**, and **[-]**) and then press the unit key (**[G/n]**, **[M/μ]**, **[k/m]**, or **[×1]**).
- Turn the rotary knob (**○**) until the desired value is set.
- Press the step keys (**[↑]****[↓]**) to set the desired value.

The setting above will add a new value for the oscillator level to the cell located in the segment row and the oscillator level column (OSC) of the list sweep table in editing mode.

Step 14. Press the **BIAS MODE []** key to display the dc bias mode menu.

Step 15. Select the dc bias mode.

dc bias mode	Key stroke
Voltage source (non-constant voltage mode)	VOLT
Current source (non-constant current mode)	CURRENT
Voltage source (constant voltage mode)	VOLT CONSTANT
Current source (constant current mode)	CURRENT CONSTANT

Step 16. Press the **return** key to return to the segment edit menu (2/3). Note that the dc bias mode currently selected is displayed in the key label [] of the **BIAS MODE []** key.

Softkey label	Selected dc bias mode
BIAS MODE [VOLT]	Voltage source (non-constant voltage mode)
BIAS MODE [CURR]	Current source (non-constant current mode)
BIAS MODE [C-VOLT]	Voltage source (constant voltage mode)
BIAS MODE [C-CURR]	Current source (constant current mode)

NOTE

The unit for the value in the cell located in the segment row and the dc bias level column (BIAS) is modified according to the selected mode. Remember that you should verify whether the mode is constant/non-constant voltage/current by using the key label of the BIAS MODE [] key.

Step 17. When a voltage source (non-constant or constant voltage mode) is selected for the dc bias mode, press the **DC BIAS VOLTAGE** key. This will display the current setting for the dc voltage bias level value for the segment in the parameter settings located in the upper left area of the screen.

Step 18. Use the keys or rotary knob of the ENTRY block in one of the following ways to specify a value for the dc voltage bias level.

- Enter the desired value with the numeric keys ([0] to [9], [.] and [-]) and then press the unit key ([G/n], [M/μ], [k/m], or [×1]).
- Turn the rotary knob (O) until the desired value is set.
- Press the step keys ([↑][↓]) to set the desired value.

The setting above will add a new value for the dc voltage bias level to the cell located in the segment row and the dc bias column (BIAS) of the list sweep table in editing mode.

Step 19. When a current source (non-constant or constant current mode) is selected for the dc bias mode, press the **DC BIAS CURRENT** key. This will display the current setting for the dc current bias level value for the segment in the parameter settings located in the upper left area of the screen.

Step 20. Use the keys or rotary knob of the ENTRY block in one of the following ways to specify a value for the dc current bias level.

- Enter the desired value with the numeric keys ([0] to [9], [.] and [-]) and then press the

Setting Measurement Conditions

Sweeping Multiple Sweep Ranges with Different Conditions in a Single Action (List Sweep)

unit key (**[G/n]**, **[M/μ]**, **[k/m]**, or **[×1]**).

- Turn the rotary knob (○) until the desired value is set.
- Press the step keys (**[↑]**/**[↓]**) to set the desired value.

The setting above will add a new value for the dc current bias level to the cell located in the segment row and the dc bias column (BIAS) of the list sweep table in editing mode.

Step 21. Press the **more 2/3** key to display the segment edit menu (3/3).

Step 22. Press the **BANDWIDTH []** key to display the measurement bandwidth setting menu.

Step 23. Select the measurement bandwidth for the segment.

Measurement bandwidth	Key stroke
1 (measurement speed maximized)	1 FAST
2	2
3	3
4	4
5 (measurement accuracy maximized)	5 PRECISE

The setting above will add a new value for the measurement bandwidth to the cell located in the segment row and the measurement bandwidth column (BW) of the list sweep table in editing mode.

Step 24. Press the **return** key to return to the segment edit menu (3/3).

Step 25. Press the **POINT AVG FACTOR** key. This will display the current setting for the segment's point averaging in the parameter settings located in the upper left area of the screen.

Step 26. Use the keys or rotary knob of the ENTRY block in one of the following ways to specify a value for the point averaging.

- Enter the desired value with the numeric keys (**[0]** to **[9]**, and **[.]**) and then press the **[×1]** key.
- Turn the rotary knob (○) until the desired value is set.
- Press the step keys (**[↑]**/**[↓]**) to set the desired value.

The setting above will add a new value for the point averaging in the cell located in the segment row and the point averaging column (AVG) of the list sweep table in editing mode.

Step 27. When editing of the segment is finished, press the **done** key to save the edited segment. Pressing this key also returns you to the list sweep menu.

NOTE

If you want to abort editing of the segment and restore the original state before entering the edit mode, press the **cancel** key.

Step 28. With the segment number for the edited segment selected ("**>**" is displayed to the left of the segment number of the SEG line in the list sweep table), press the PEN key. The number of the pen selected to draw the trace of the segment is displayed in the Setting Parameter

Sweeping Multiple Sweep Ranges with Different Conditions in a Single Action (List Sweep)

Value area in the upper left part of the screen.

Step 29. Use one of the following methods with the keys in the ENTRY block to set the pen number for the segment (an integer between 1 and 6).

- Enter the desired value with the numeric keys ([1] to [6]) and then press [x1].
- Turn the rotary knob (O) until the desired value is set.
- Press the step keys ([↑][↓]) to enter the desired value.

There are six pens, from number 1 to number 6, which are set to different colors (the color mapping can be changed). Accordingly, by assigning a different colored pen to each segment, you can color-code the traces on the screen to more easily identify each segment.

The factory setting of the graphic drawing pens are: pen 1: white, pen 2: red, pen 3: yellow, pen 4: green, pen 5: cyan, and pen 6: blue. For how to reset the color of the pens, refer to “Customizing the Color of Each Screen Item” on page 208.

The pen number that is set for each segment is not displayed on the list sweep table. To check the pen number, use the **SEGMENT** key to specify a segment and press the **PEN** key.

Step 30. Repeat steps 3 through 27 until you obtain all segments you need. Use the editing functions below as necessary.

Editing function for list sweep table	Key stroke
Select a segment number (current selection is marked with “>” to the left side of the segment number (SEG row).	SEGMENT - (enter using keys in ENTRY block)
Enter edit mode for the selected segment	EDIT
Delete the selected segment (pressing the key will delete the segment without confirmation).	DELETE
Append a segment to the selected segment and enter edit mode.	ADD
Delete all segments of the list sweep table in edit mode.	CLEAR LIST - yes (cancel to cancel)

NOTE

The number of segments that can be set in a list sweep table ranges from 1 to 18.

The number of points that can be set for a single segment is an integer ranging from 2 to 201. Up to 801 points can be set for each segment.

The sweep frequency range for each segment can be set with a combination of either sweep start value and sweep stop value or one of sweep center value and sweep span value. Also, after setting a sweep range with sweep start value and sweep stop value, pressing the keys for setting sweep center/span value will override the previous format of the sweep range for the list sweep table. This also works in changing the other direction, from center/span to start/stop setting values.

The sweep frequency range set for any segment can overlap with any range set for the other segments.

When appending a segment to the one that is selected, the same values as those in the

Setting Measurement Conditions

Sweeping Multiple Sweep Ranges with Different Conditions in a Single Action (List Sweep)

previous segment are specified as initial values for the sweep start/stop frequencies (the same logic is applied to initial values for a sweep range specified with sweep center/span frequencies). Thus, a continuous sweep frequency range over the entire list sweep table would be obtained if you specify the range by modifying only the sweep stop frequency for each of the appended segments.

Step 31. When editing of the list sweep table is done, press the **done** key in the list sweep menu. Press the **cancel** key to quit editing.

NOTE

When you quit editing of a list sweep table by pressing the **cancel** key, the table will revert to its original state before the edit mode was entered.

Figure 5-19

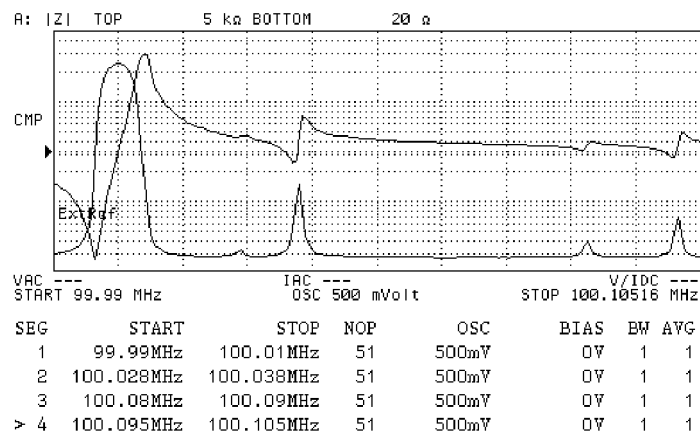

4294aoj105

Selecting the list sweep as the sweep type

You can execute the list sweep according to the completed list sweep table by selecting list sweep as the sweep type. For how to select the sweep type, refer to “Selecting Linear, Log, or List Sweep” on page 87.

Step 1. Press the **[Sweep]** key to display the Sweep menu.

Step 2. Press the **TYPE []** key to display the Sweep Type menu.

Step 3. Press the **LIST** key to select the list sweep.

Setting the Horizontal Axis of the Graph for the List Sweep

There are two types of list span modes that can be selected for the horizontal axis of the graph for the list sweep.

Step 1. Press the **[Sweep]** key to display the Sweep menu.

Step 2. Press the **LIST SPAN []** key to select the setting for the horizontal axis for the list sweep

Setting Measurement Conditions Sweeping Multiple Sweep Ranges with Different Conditions in a Single Action (List Sweep)

(pressing the key toggles your selection).

Softkey label	Selected list span mode
LIST SPAN [SINGLE]	Single span (linear-scaled frequency is used for the horizontal axis, with the left end specified as the minimum frequency in the list sweep table and the right end as the maximum).
LIST SPAN [SEGMENT]	Segment span (measurement numbers are used for the horizontal axis; the points indicate the order of measurement points in the table and are equally spaced along the full length of the axis.)

NOTE

The setting in this procedure does not take effect when COMPLEX Z-Y is selected for the measurement parameter because no axis for the sweep parameter exists in the graticule of display.

Figure 5-20

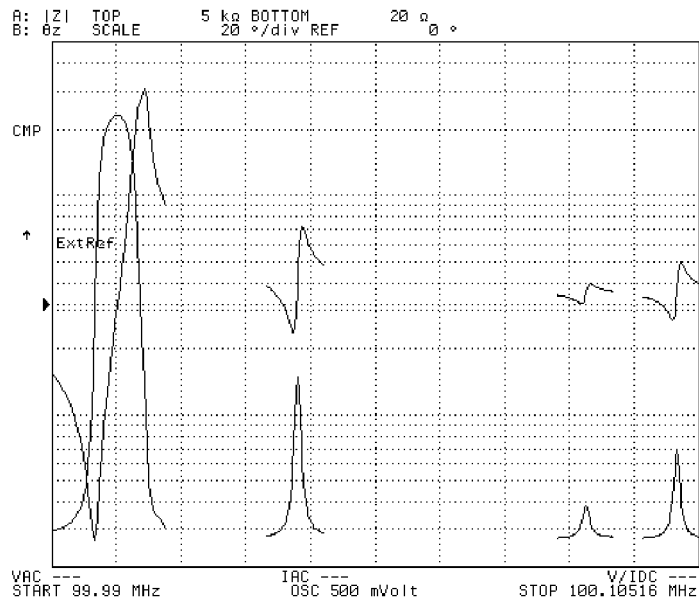

4294a0j106

Setting Measurement Accuracy, Stability, and Time

Setting measurement bandwidth

- Step 1.** Press the **[Bw/Avg]** key to display the measurement bandwidth/averaging menu.
- Step 2.** Press the **BANDWIDTH []** key to display the measurement bandwidth setting menu.
- Step 3.** Select the measurement bandwidth.

Measurement bandwidth	Key stroke
1 (measurement speed maximized)	1 FAST
2	2
3	3
4	4
5 (measurement accuracy maximized)	5 PRECISE

- Step 4.** Press the **return** key to return to the measurement bandwidth/averaging menu. Note that the measurement bandwidth currently selected is displayed in the key label **[]** of the **BANDWIDTH []** key.

Softkey label	Selected measurement bandwidth
BANDWIDTH [1]	1 (measurement speed maximized)
BANDWIDTH [2]	2
BANDWIDTH [3]	3
BANDWIDTH [4]	4
BANDWIDTH [5]	5 (measurement accuracy maximized)

NOTE

Setting a greater measurement bandwidth will improve measurement accuracy, but keep in mind that this requires a longer measurement time.

Averaging between sweeps (sweep-to-sweep averaging)

Sweep-to-sweep averaging computes each data point (vector value) based on an exponential average of consecutive sweeps weighted by a user-specified averaging factor. The sweep-to-sweep uses the algorithm shown in Equation 5-1.

Equation 5-1 **Sweep-To-Sweep Averaging Algorithm**
$$A_n = \frac{S_n}{F} + \left(1 - \frac{1}{F}\right) \times A_{n-1}$$

where:

A_n = Sweep-to-sweep averaging result (vector value) at the measurement point when the sweep count is “n.”

S_n = Current measurement value (vector value) at the measurement point when the sweep count is “n.”

F = Sweep-to-sweep averaging factor (entered with the **AVERAGING FACTOR** key)

Perform the averaging factor setup as follows:

- Step 1.** Press the **[Bw/Avg]** key to display the measurement bandwidth/averaging menu.
- Step 2.** Press the **AVERAGING FACTOR** key to display the current setting for the sweep-to-sweep averaging in the parameter settings located in the upper left area of the screen.
- Step 3.** Use the keys or rotary knob of the ENTRY block in one of the following ways to specify a value for the sweep-to-sweep averaging.
 - Enter the desired value with the numeric keys (**[0]** to **[9]**, **[.]**, and **[-]**) and then press the unit key (**[G/n]**, **[M/μ]**, **[k/m]**, or **[×1]**).
 - Turn the rotary knob (**○**) until the desired value is set.
 - Press the step keys (**[↑]****[↓]**) to set the desired value.

NOTE

The sweep-to-sweep averaging can be set to any natural number from 1 to 256. Setting the sweep-to-sweep averaging to 1 is equivalent to turning the averaging OFF.

- Step 4.** Press the **AVERAGING ON OFF** (or **AVERAGING ON off**) key to turn the sweep-to-sweep averaging ON or OFF (pressing the key toggles your selection).

Softkey label	Sweep-to-sweep averaging
AVERAGING on OFF	Off
AVERAGING ON off	On

NOTE

When the sweep-to-sweep averaging is turned ON, the character “Avg” is displayed in the parameter settings located in the upper left area of the screen. Below the character is also displayed the value of sweep-to-sweep averaging that has been performed for the trace.

The sweep-to-sweep averaging starts after turning it ON or pressing the **AVERAGING RESTART** key. When the averaging starts, “0” is displayed for the averaging count because the number of traces (sweep data) to be swept is always set to 0 at the initial state. Then the count increases by 1 as each sweeping ends. After the count reaches the number specified by the **AVERAGING FACTOR** key, it stays constant while sweeping continues.

Averaging for each measurement point (point averaging)

Point averaging averages each data point by a user-specified averaging factor. The Agilent 4294A repeatedly measures the same point until the averaging factor is reached. It then divides the vector summation of the measurement value by the averaging factor and starts measuring the next point. The sweep time increases in proportion to the averaging factor. The algorithm used for point averaging is shown in Equation 5-2.

Equation 5-2

Point Averaging Algorithm

$$M = \frac{1}{F} \sum_{n=1}^r S_n$$

where:

- M = Point averaging result (vector value) at the measurement point
- S_n = Current measurement value (vector value)
- F = Point averaging factor (entered with **POINT AVG FACTOR** key)

Perform the averaging factor setup as follows:

- Step 1.** Press the **[Bw/Avg]** key to display the measurement bandwidth/averaging menu.
- Step 2.** Press the **POINT AVG FACTOR** key to display the current setting for the point averaging in the parameter settings located in the upper left area of the screen.
- Step 3.** Use the keys or rotary knob of the ENTRY block in one of the following ways to specify a value for the point averaging.
 - Enter the desired value with the numeric keys (**[0]** to **[9]**, **[.]**, and **[-]**) and then press the unit key (**[G/n]**, **[M/μ]**, **[k/m]**, or **[×1]**).
 - Turn the rotary knob (○) until the desired value is set.
 - Press the step keys (**[↑]**/**[↓]**) to set the desired value.

NOTE

The value of point averaging can be set to any natural number from 1 to 256. Setting the point averaging to 1 is equivalent to turning the averaging OFF.

- Step 4.** Press the **POINT AVG on OFF** (or **POINT AVG ON off**) key to turn the point averaging ON or OFF (pressing the key toggles your selection).

Softkey label	Point averaging
POINT AVG on OFF	Off
POINT AVG ON off	On

6 Calibration

This chapter describes calibration methods for the Agilent 4294A Precision Impedance Analyzer.

Selecting Appropriate Calibration Method

The Agilent 4294A has three calibration types: user calibration, port extension compensation, and fixture compensation. Table 6-1 shows each device connection and its corresponding adapter selection and calibration. Calibration should be done according to the particular requirements of each device connection. See “Adapter Setting” on page 67 for adapter selection.

Table 6-1 Device Connection and Corresponding Adapter Selection and Calibration

Device Connection	Adapter Selection	Accessory	Calibration (√: required, blank: not required)		
			User Calibration	Port Extension Compensation	Fixture Compensation
A. Connect a direct connection type test fixture to the four-terminal pair port of the 4294A and connect the device to the fixture.	No adapter (NONE)	16034E 16034H 16044A 16047A 16047C 16047D 16047E 16065A ¹ 16089A ¹ 16089B ¹ 16089C ¹ 16089D ¹ 16089E ¹			Open/Short
		16034G			Open/Short/ Load (Load comp. is required when the frequency is more than 3 MHz)
		16314A			Open/Short/Load
B. Extend the four-terminal pair port of the 4294A with a 1-meter-long four-terminal pair configuration and connect the device.	Four-terminal pair, 1 meter (4TP 1M)	16048G and test fixture			Same as the fixtures are directly connected to the four-terminal pair port
		16048G and 16452A			Short
		16334A 16451B			Open/Short
C. Extend the four-terminal pair port of the 4294A with a 2-meter-long four-terminal pair configuration and connect the device.	Four-terminal pair, 2 meters (4TP 2M)	16048H and test fixture			Same as the fixtures are directly connected to the four-terminal pair port
		16048H and 16452A			Short

Table 6-1 Device Connection and Corresponding Adapter Selection and Calibration

Device Connection	Adapter Selection	Accessory	Calibration (√: required, blank: not required)		
			User Calibration	Port Extension Compensation	Fixture Compensation
D. Connect the 42942A directly to the four-terminal pair port of the 4294A, connect a dedicated test fixture to the 7-mm port, and then connect the device to the fixture contacts.	42942A Terminal Adapter (7mm 42942A)	42942A and 16092A 42942A and 16093A 42942A and 16093B 42942A and 16191A 42942A and 16192A 42942A and 16193A	√ (perform when user-defined calibration kit is used)		Open/Short
		42942A and 16454A			Short
E. Connect the 42942A directly to the four-terminal pair port of the 4294A, connect a coaxial cable to the 7-mm port, connect a test fixture, and then connect the device to the fixture contacts.	42942A Terminal Adapter (7mm 42942A)	42942A, coaxial cable, and test fixture	√ (use Agilent's calibration kit or user-defined calibration kit)	√	Same as the fixtures are directly connected to the terminal adapter.
F. Connect the 42941A directly to the four-terminal pair port of the 4294A, connect a dedicated probe adapter to the 3.5-mm port, and then connect the device to the adapter contacts.	42941A Impedance Probe (PROBE 42941A)	42941A and dedicated probe adapter	√ (perform when user-defined calibration kit is used)		Open/Short
G. Connect the 42941A directly to the four-terminal pair port of the 4294A, connect a coaxial cable to the 3.5-mm port, connect a test fixture, and then connect the device to the fixture contacts	42941A Impedance Probe (PROBE 42941A)	42941A and coaxial cable and test fixture	√ (use Agilent's calibration kit or user-defined calibration kit)	√	Required compensations differ from one test fixture to another.

1. Although it has a cable, it falls into the category of direct connection type test fixture for adapter setup.

Refer to the following sections for the calibration procedure of each device connection:

- “A. Calibration When Using Direct Connection Type Test Fixture” on page 133
- “B. Calibration for Four-Terminal Pair, 1-m Extension” on page 135
- “C. Calibration for Four-Terminal Pair, 2-m Extension” on page 137
- “D. Calibration When an Exclusive Fixture is Connected to the 42942A” on page 139
- “E. Calibration When the 7-mm Port of the 42942A is Extended” on page 141
- “F. Calibration When a Probe Adapter is Connected to the 42941A” on page 143
- “G. Calibration When the 3.5-mm Port of the 42941A is Extended” on page 145

For the three calibration methods, refer to the following sections:

- “User Calibration” on page 147
- “Port Extension Compensation” on page 150
- “Fixture Compensation” on page 151

- “Selecting Calibration/Compensation Data Points” on page 155

NOTE

The user calibration data and fixture compensation data can be saved in the mass storage of the Agilent 4294A. For details, see “Save and Recall the Agilent 4294A Internal Data” on page 270.

A. Calibration When Using Direct Connection Type Test Fixture

This section describes the calibration procedures to follow when a direct connection type test fixture is connected to the four-terminal pair port of the Agilent 4294A and a device is connected to the test fixture contacts.

Figure 6-1

Calibration When Direct Connection Type Test Fixture is Used

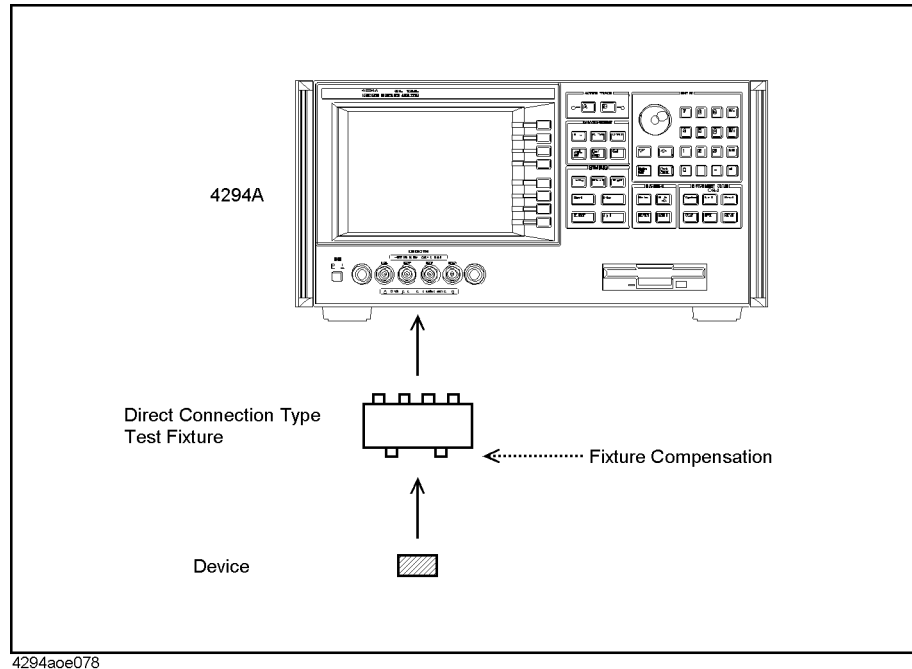

Direct connection type test fixtures include:

- 16034E Chip component test fixture
- 16034G Chip component test fixture
- 16034H Chip component test fixture
- 16044A Chip component test fixture
- 16047A Lead component test fixture
- 16047C Lead component test fixture
- 16047D Lead component test fixture
- 16047E Lead component test fixture
- 16314A Balanced/Unbalanced 4-Terminal Converter

Although the following test fixtures have cables, their calibration must be performed in the same way as a direct connection type test fixture:

- 16065A External DC Bias Fixture
- 16089A Kelvin Clip Lead

Calibration

A. Calibration When Using Direct Connection Type Test Fixture

- 16089B Kelvin Clip Lead
- 16089C Kelvin Clip Lead
- 16089D Alligator Clip Lead
- 16089E Kelvin Clip Lead

Step 1. Make sure that the adapter selection is set to “No Adapter (**NONE**).”

See “Adapter Setting” on page 67 for adapter selection.

Step 2. Perform the fixture compensation in accordance with “Fixture Compensation” on page 151.

NOTE

When you use a direct connection type test fixture, neither user calibration nor port extension compensation is required for measurement (they cannot be performed).

B. Calibration for Four-Terminal Pair, 1-m Extension

This section describes the calibration procedures to follow when the four-terminal pair port of the Agilent 4294A is extended with a 1-meter-long four-terminal pair configuration and the device is connected to the cable's end with a minimal connection.

Figure 6-2

Calibration for Four-Terminal Pair, 1-m Extension

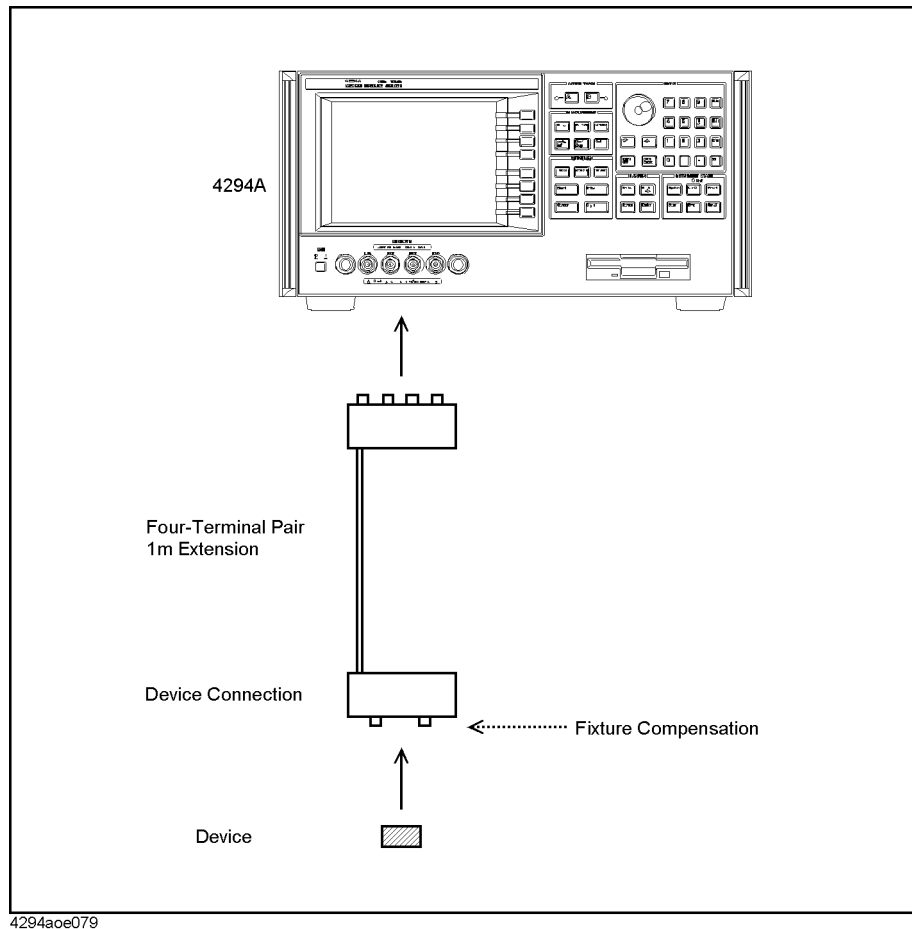

This calibration procedure is applied to the following connections:

- The 16048G (1-m Cable) is connected to the Agilent 4294A and the device is connected to the cable's end with a test fixture.
- The 16048G (1-m Cable) is connected to the Agilent 4294A and the 16452A (Liquid Test Fixture) is connected to the end of the cable.
- The 16334A (Tweezer Type Test Fixture) is connected to the Agilent 4294A.
- The 16451B (Dielectric Test Fixture) is connected to the Agilent 4294A.

Step 1. Make sure that the adapter selection is set to “Four-terminal pair, 1-meter (4TP 1M).”

See “Adapter Setting” on page 67 for adapter selection.

Step 2. Perform the fixture compensation in accordance with “Fixture Compensation” on page

151.

NOTE

When the measurement port is extended by 1 meter with the four-terminal pair configuration, neither user calibration nor port extension compensation is required for measurement (they cannot be performed).

Fixture Compensation When the 16451B is Used

When you perform only the fixture OPEN compensation and fixture SHORT compensation, follow the normal fixture compensation procedures described in “Fixture Compensation” on page 151.

If you perform the LOAD compensation in addition to the OPEN and SHORT compensations, set the standard values as described below in accordance with the procedures in “Defining the standard values for fixture compensation” on page 153.

Furthermore, when you perform the fixture OPEN compensation measurement, use the LOAD key for the OPEN data measurement, and when you perform the fixture LOAD compensation measurement, use the OPEN key for the LOAD data measurement.

Softkey for Compensation Data Definition	Setting Value
OPEN CONDUCT(G)	Definition of equivalent parallel conductance value for <u>LOAD</u> standard
OPEN CAP(C)	Definition of equivalent parallel capacitance value for <u>LOAD</u> standard
SHORT RESIST(R)	Definition of equivalent series resistance value for SHORT standard (usual definition)
SHORT INDUCT(L)	Definition of equivalent series inductance value for SHORT standard (usual definition)
LOAD RESIST(R)	Definition of equivalent series resistance value for <u>OPEN</u> standard (set to maximum setting value 100 G Ω)
LOAD INDUCT(L)	Definition of equivalent series inductance value for <u>OPEN</u> standard (set to 0 H)

These irregular settings are required because the standard value of the Agilent 4294A is defined as a series circuit model of resistance (R) and inductance (L) as shown in Figure 6-9 on page 153, while the 16451B usually requires a parallel circuit of capacitance (C) and conductance (G) for LOAD compensation.

C. Calibration for Four-Terminal Pair, 2-m Extension

This section describes the calibration procedures to follow when the four-terminal pair port of the Agilent 4294A is extended with a 2-meter-long four-terminal pair configuration and the device is connected to the cable's end with a minimal connection.

Figure 6-3 Calibration for Four-terminal Pair, 2-m Extension

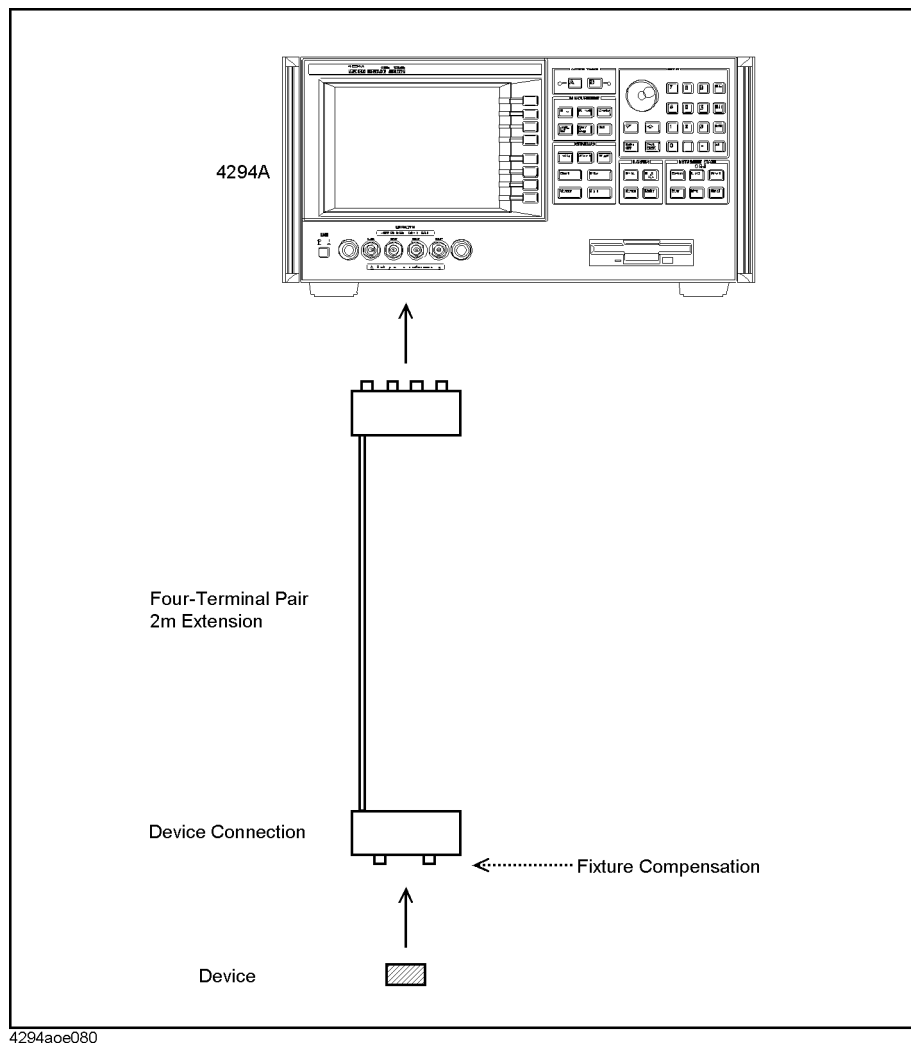

This calibration procedure is applied to the following connections:

- The 16048H (2-m Cable) is connected to the Agilent 4294A and the device is connected to the cable's end with a test fixture.
- The 16048H (2-m Cable) is connected to the Agilent 4294A and the 16452A (Liquid Test Fixture) is connected to the end of the cable.

Step 1. Make sure that the adapter selection is set to "Four-terminal pair, 2-meters (4TP 2M)."

See "Adapter Setting" on page 67 for adapter selection.

C. Calibration for Four-Terminal Pair, 2-m Extension

Step 2. Perform the fixture compensation in accordance with “Fixture Compensation” on page 151.

NOTE

When the measurement port is extended by 2 meters with the four-terminal pair configuration, neither user calibration nor port extension compensation is required for measurement (they cannot be performed).

D. Calibration When an Exclusive Fixture is Connected to the 42942A

When an exclusive test fixture supplied by Agilent Technologies is connected to the 7-mm port of the 42942A Terminal Adapter, which is connected to the four-terminal pair port of the Agilent 4294A, and a device is connected to the test fixture, perform the calibration procedure described below.

Figure 6-4 Calibration When an Exclusive Fixture is Connected to the 42942A

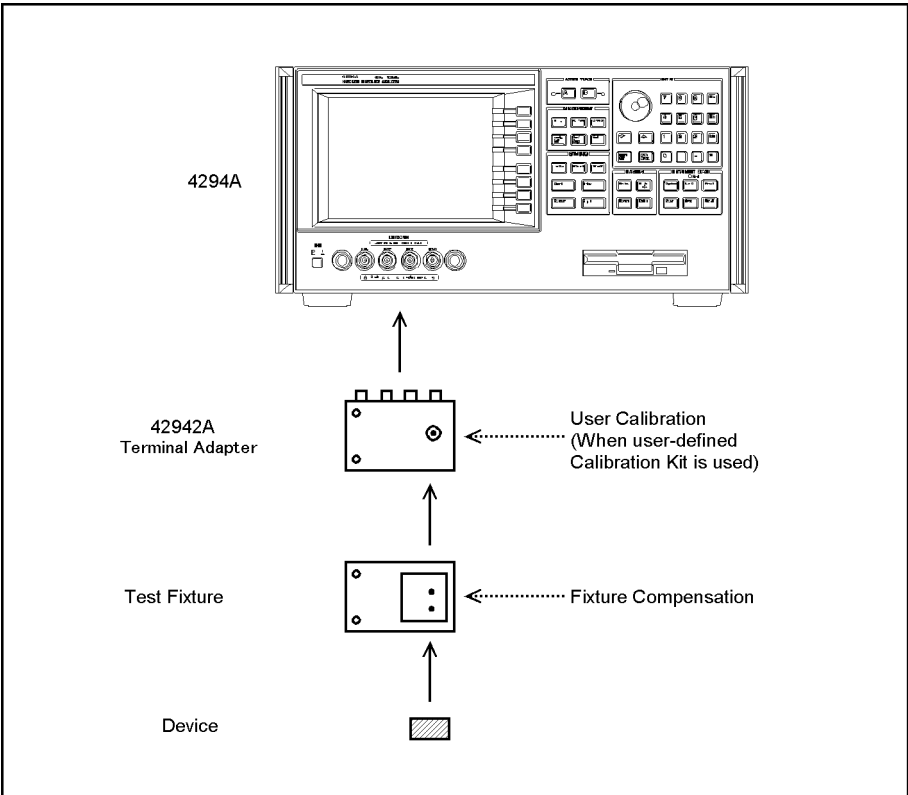

4294aoe081

This calibration procedure is applied when the following Agilent test fixtures are connected to the 42942A's 7-mm port:

- 16092A Lead/Chip component test fixture
- 16093A Lead component test fixture
- 16093B Lead component test fixture
- 16191A Chip component test fixture
- 16192A Chip component test fixture
- 16193A Chip component test fixture
- 16454A Magnetic material test fixture

Step 1. Make sure that the adapter selection is set to “42942A Terminal Adapter (7mm 42942A).”

Calibration

D. Calibration When an Exclusive Fixture is Connected to the 42942A

See “Adapter Setting” on page 67 for adapter selection.

Step 2. When performing calibration for the 7-mm port of the 42942A with a user-defined calibration kit, be sure to use the proper calibration kit. Refer to “User Calibration” on page 147 for the user calibration procedure.

User calibration is not required if you do not use a user-defined calibration kit.

Step 3. Connect a test fixture to the 7-mm port of the 42942A Terminal Adapter. See the operation manual of each test fixture for the appropriate connection setup.

Step 4. Perform the fixture compensation at the device contacts (electrodes) of the fixture. See “Fixture Compensation” on page 151 for the fixture compensation procedure.

NOTE

When an exclusive test fixture is connected to the 7-mm port of a 42942A that is also connected to the four-terminal pair port of the Agilent 4294A, port extension compensation is not required.

E. Calibration When the 7-mm Port of the 42942A is Extended

Perform the following calibration when the 7-mm port of a 42942A connected to the Agilent 4294A is extended with a one-port configuration and the device is connected to the cable's end with a minimal connection.

Figure 6-5 Calibration When the 7-mm Port of the 42942A is Extended

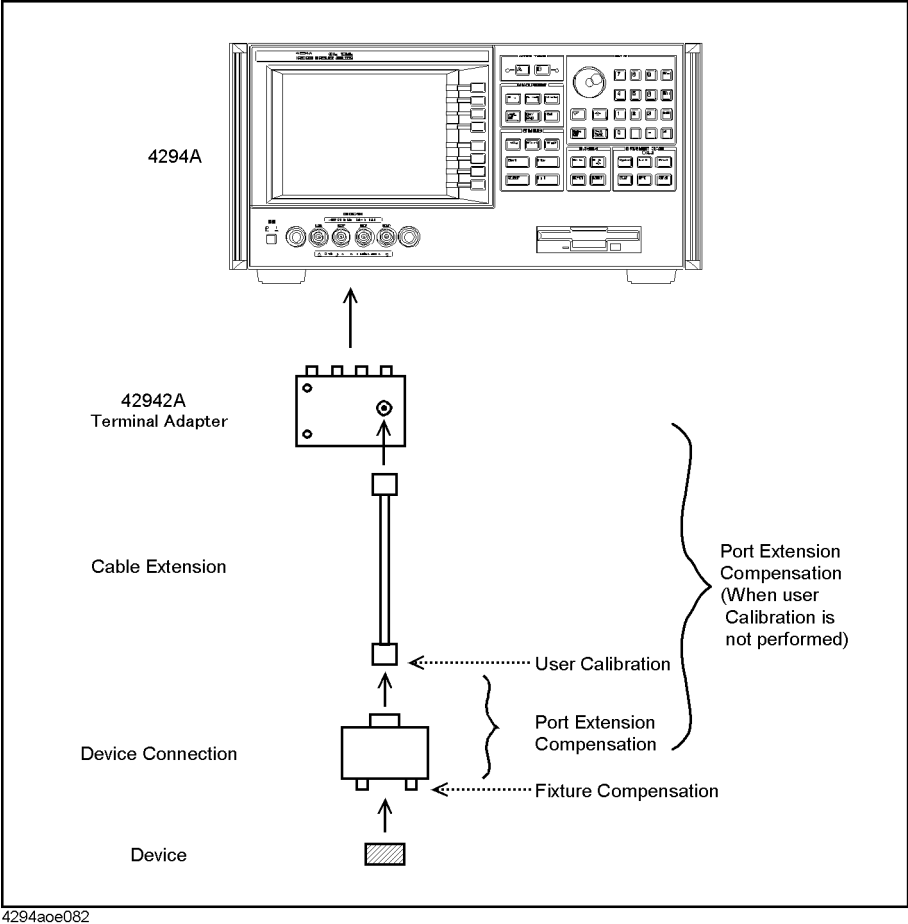

- Step 1.** Make sure that the adapter selection is set to “42942A Terminal Adapter (7mm 42942A).” See “Adapter Setting” on page 67 for adapter selection.
- Step 2.** Perform the user calibration at the other end of the extended 7-mm port of the 42942A Terminal Adapter. You can use either the calibration kit supplied by Agilent Technologies or a user-defined calibration kit. See “User Calibration” on page 147 for the user calibration procedure.
- Step 3.** Set the port extension value in electrical length or delay time, which is equivalent to the electrical length between the user calibration plane and the device contacts of the test fixture, in accordance with “Port Extension Compensation” on page 150.

E. Calibration When the 7-mm Port of the 42942A is Extended

NOTE In measurements using the 4294A, the electrical length (delay time) of a 42942A dedicated test fixture (such as 16092A) and 42941A's dedicated probe adapter can be regarded as 0.

Step 4. Perform fixture compensation at the device contacts of the test fixture. See “Fixture Compensation” on page 151 for the fixture compensation procedure.

NOTE If user calibration in step 2 cannot be performed for some reason, set the port extension value in electrical length or delay time, which is equivalent to the electrical length between the 7-mm port of the 42942A and the device contacts of the test fixture, in place of steps 2 and 3, in accordance with “Port Extension Compensation” on page 150.

F. Calibration When a Probe Adapter is Connected to the 42941A

Perform the following calibration when a probe adapter supplied with the 42941A Impedance Probe is directly connected to the 3.5-mm port of the 42941A, which is connected to the four-terminal pair port of the Agilent 4294A, and a device is connected to the probe adapter.

Figure 6-6 Calibration When a Probe Adapter is Connected to the 42941A

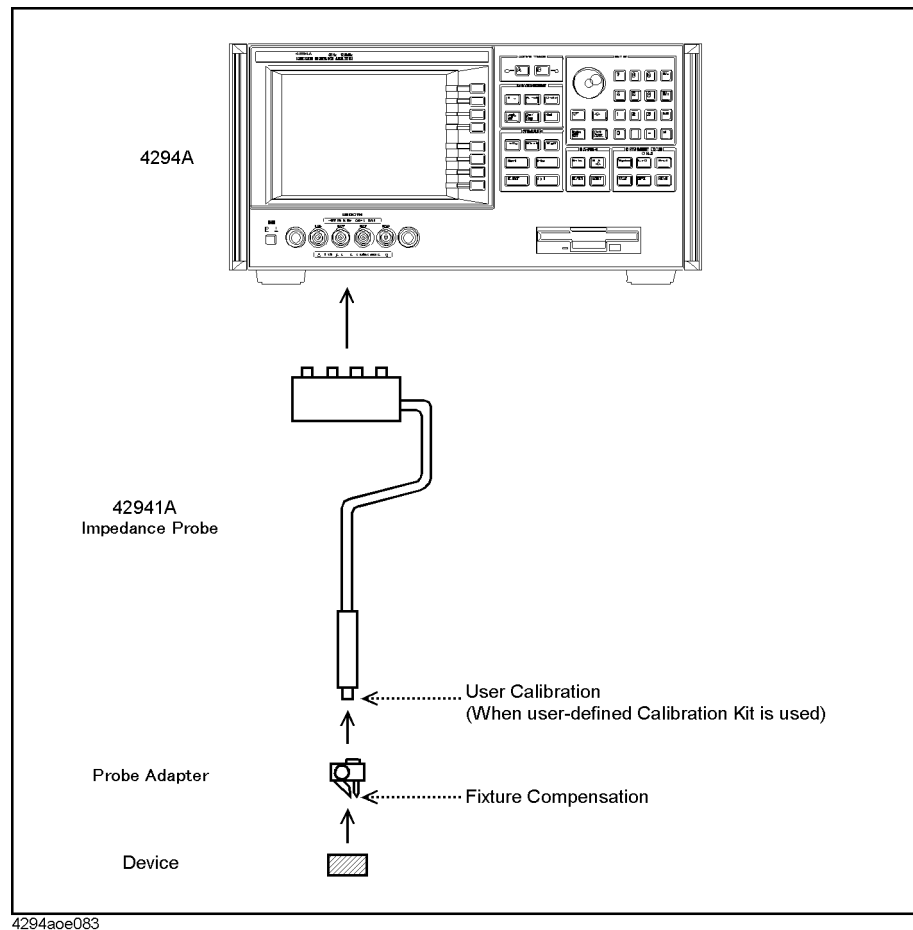

This calibration procedure is applied when the following probe adapters are connected to the 3.5-mm port of the 42941A (see the operation manual of the 42941A for details of probe adapters):

- Pin Probe (with ground electrode or ground lead)
- BNC(m) Adapter
- BNC(m) Adapter with alligator clip leads

Step 1. Make sure that the adapter selection is set to “42941A Impedance Probe (PROBE 42941A).”

Calibration

F. Calibration When a Probe Adapter is Connected to the 42941A

See “Adapter Setting” on page 67 for adapter selection.

- Step 2.** When performing calibration at the 3.5-mm port of the 42941A with a user-defined calibration kit, perform user calibration with the proper calibration kit. Refer to “User Calibration” on page 147 for the user calibration procedure.

User calibration is not required when you do not use a user-defined calibration kit.

- Step 3.** Connect a probe adapter to the 3.5-mm port of the 42941A Impedance Probe. See the operation manual of the 42941A for the appropriate connection setup.

- Step 4.** Perform the fixture compensation at the device contacts (electrodes) of the probe adapter. See “Fixture Compensation” on page 151 for the fixture compensation procedure.

NOTE

When a probe adapter is connected to the 3.5-mm port of a 42941A that is also connected to the four-terminal pair port of the Agilent 4294A, port extension compensation is not required.

G. Calibration When the 3.5-mm Port of the 42941A is Extended

Perform the following calibration when the 3.5-mm port of a 42941A connected to the Agilent 4294A is extended with a one-port configuration and the device is connected to the cable's end with a minimal connection.

Figure 6-7

Calibration When the 3.5-mm Port of the 42941A is Extended

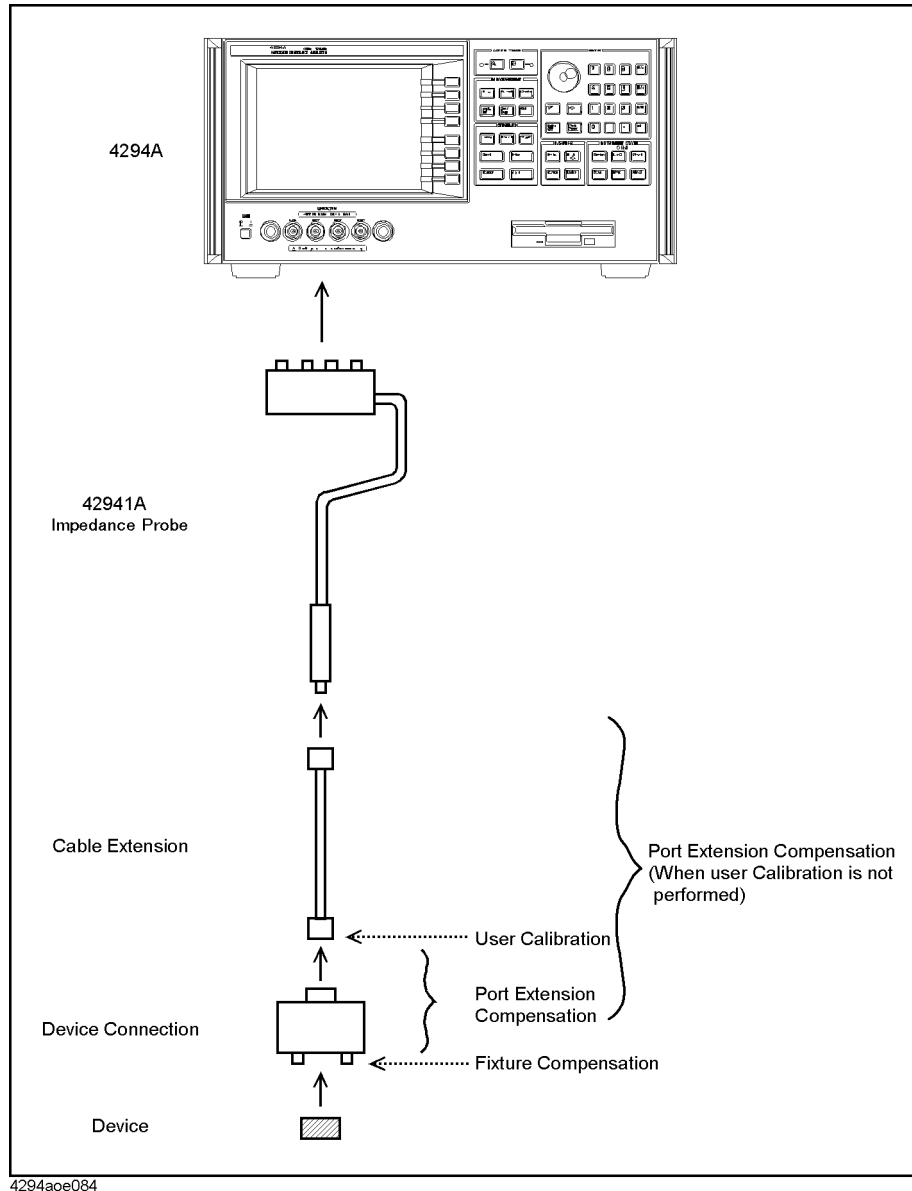

Step 1. Make sure that the adapter selection is set to “42941A Impedance Probe (PROBE 42941A).”

See “Adapter Setting” on page 67 for adapter selection.

G. Calibration When the 3.5-mm Port of the 42941A is Extended

- Step 2.** Perform the user calibration at the other end of the extended 3.5-mm port of the 42941A Impedance Probe. You can use either the calibration kit supplied by Agilent Technologies or a user-defined calibration kit. See “User Calibration” on page 147 for the user calibration procedure.
- Step 3.** Set the port extension value in electrical length or delay time, which is equivalent to the electrical length between the user calibration plane and the device contacts of the test fixture, in accordance with “Port Extension Compensation” on page 150.

NOTE

In measurements using the Agilent 4294A, the electrical length (delay time) of a 42942A dedicated test fixture (such as 16092A) and 42941A’s dedicated probe adapter can be regarded as 0.

- Step 4.** Perform fixture compensation at the device contacts of the test fixture. See “Fixture Compensation” on page 151 for the fixture compensation procedure.

NOTE

If user calibration in step 2 cannot be performed for some reason, set the port extension value in electrical length or delay time, which is equivalent to the electrical length between the 3.5-mm port of the 42941A and the device contacts of the test fixture, in place of steps 2 and 3, in accordance with “Port Extension Compensation” on page 150.

User Calibration

User calibration can be performed only when “42942A Terminal Adapter (7mm 42942A)” or “42941A Impedance Probe (PROBE 42941A)” is selected in the adapter setting.

User Calibration Procedure

Perform user calibration as follows:

NOTE

User calibration consists of three calibration data acquisition procedures: OPEN, SHORT, and LOAD, and you must obtain all three types of calibration data when performing user calibration. It is not possible to turn on or off each type of calibration data independently during your measurement.

- Step 1.** Press the **[Cal]** key to display the Calibration Menu.
- Step 2.** Select calibration (compensation) data acquisition points in accordance with “Selecting Calibration/Compensation Data Points” on page 155.
- Step 3.** Press the **USER CAL** key to display the User Calibration Menu.
- Step 4.** If required, set user-defined standard values in accordance with “Defining Standard Values for User Calibration” on page 148.

After you complete the setup of the user-defined standard values, press the **return** key to return to the User Calibration Menu.
- Step 5.** Press the **EXECUTE CAL** key to display the Calibration Execution Menu.
- Step 6.** Connect the OPEN standard to the port (plane) where you want to perform user calibration.
- Step 7.** Press the **OPEN [-]** key to start OPEN calibration data measurement.

During the calibration data measurement, the message “WAIT--MEASURING STANDARD” is displayed in the instrument state area of the LCD's upper-left side.

When OPEN calibration data measurement is completed, the softkey label changes to **OPEN [DONE]**.
- Step 8.** Remove the OPEN standard from the port. Then, connect the SHORT standard to the port.
- Step 9.** Press the **SHORT [-]** key to start SHORT calibration data measurement.

During the calibration data measurement, the message “WAIT--MEASURING STANDARD” is displayed in the instrument state area of the LCD's upper-left side.

When the SHORT calibration data measurement is completed, the softkey label changes to **SHORT [DONE]**.
- Step 10.** Remove the SHORT standard from the port. Then, connect the LOAD standard to the port.
- Step 11.** Press the **LOAD [-]** key to start LOAD calibration data measurement.

During the calibration data measurement, the message “WAIT--MEASURING STANDARD” is displayed in the instrument state area of the LCD's upper-left side.

Calibration
User Calibration

When LOAD calibration data measurement is completed, the softkey label changes to **LOAD [DONE]**.

- Step 12.** Press the **done** key to start calculating the calibration coefficient from the measured OPEN, SHORT, and LOAD standard data. The coefficient is automatically saved to the internal memory.

When the calculation and storage of the coefficient are completed, the Agilent 4294A returns to the User Calibration Menu. If the user calibration function is off, it is automatically turned on (the key label **CORRECTION on OFF** changes to **CORRECTION ON off**).

NOTE

Press the **cancel** key to cancel the user calibration process. If the user calibration process is canceled, the previously obtained data can be used as the available user calibration coefficient.

Turning User Calibration On/Off

The user calibration function is automatically turned on after completing user calibration data measurement. However, you can turn this function on or off as required.

- Step 1.** Press the **[Cal]** key to display the Calibration Menu.
- Step 2.** Press the **USER CAL** key to display the User Calibration Menu.
- Step 3.** Press the **CORRECTION on OFF (CORRECTION ON off)** key to make the user calibration available (on) or not available (off) for measurement (pressing the key toggles your selection).

Softkey Label	User Calibration
CORRECTION on OFF	Off
CORRECTION ON off	On

Defining Standard Values for User Calibration

You can define standard values of OPEN, SHORT, and LOAD for user calibration. Figure 6-8 shows the circuit models of the user calibration kit for the Agilent 4294A.

Figure 6-8

Circuit Models of User Calibration Kit

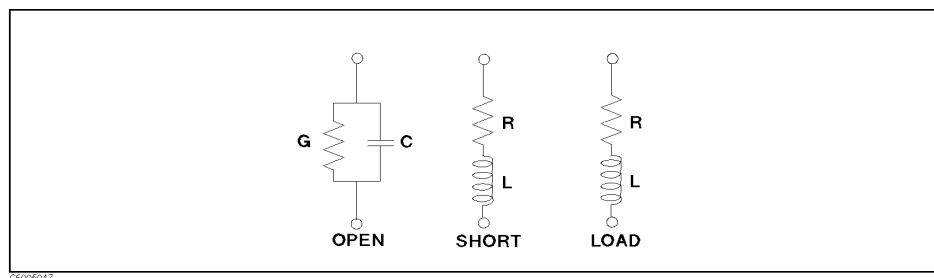

Each calibration's standard value can be confirmed and changed as follows:

- Step 1.** Press the **[Cal]** key to display the Calibration Menu.

- Step 2.** Press the **USER CAL** key to display the User Calibration Menu.
- Step 3.** Press the **DEFINE VALUE** key to display the Calibration Data Definition Menu.
- Step 4.** Select one of the calibration data definition keys, **OPEN CONDUCT(G)**, **OPEN CAP(C)**, **SHORT RESIST(R)**, **SHORT INDUCT(L)**, **LOAD RESIST(R)**, or **LOAD INDUCT(L)**, to confirm or set the calibration data definition.

Calibration Data Definition	Key Stroke
Equivalent parallel conductance value (G) of OPEN standard used for user calibration (preset state: 0 S)	OPEN CONDUCT(G)
Equivalent parallel capacitance value (C) of OPEN standard used for user calibration (preset state: 0 F)	OPEN CAP(C)
Equivalent series resistance value (R) of SHORT standard used for user calibration (preset state: 0 Ω)	SHORT RESIST(R)
Equivalent series inductance value (L) of SHORT standard used for user calibration (preset state: 0 H)	SHORT INDUCT(L)
Equivalent series resistance value (R) of LOAD standard used for user calibration (preset state: 50 Ω)	LOAD RESIST(R)
Equivalent series inductance value (L) of LOAD standard used for user calibration (preset state: 0 H)	LOAD INDUCT(L)

The current value of the calibration data definition is displayed in the parameter setting area of the LCD's upper-left side.

- Step 5.** Use the keys or rotary knob of the ENTRY block in one of the following ways to specify the calibration data definition.
- Enter the desired value with the numerical keys (**[0]** through **[9]**, **[.]**, **[-]**) and then press one of the unit keys (**[G/n]**, **[M/ μ]**, **[k/m]**, or **[\times 1]**).
 - Turn the rotary knob (**(O)**) until the desired value is set.
 - Press the step keys (**(\uparrow)****(\downarrow)**) to set the desired value.

NOTE

When the capacitance value of the calibration data definition is entered with the numerical keys and one of the unit keys, the unit [fF] is automatically added to the entered value.

- Step 6.** Repeat procedures 4 and 5 to set all of the required calibration data definitions.

Port Extension Compensation

Port extension compensation is used to compensate an error caused by the electrical delay when the 7-mm port of the 42942A Terminal Adapter or 3.5-mm port of the 42941A Impedance Probe is extended with a one-port configuration.

Port extension compensation can be performed when “42942A Terminal Adapter (7mm 42942A)” or “42941A Impedance Probe (PROBE 42941A)” is chosen in adapter selection.

Perform the port extension compensation as follows:

- Step 1.** Press the **[Cal]** key to display the Calibration Menu.
- Step 2.** Press the **PORT EXTENSION** key to display the Port Extension Menu.
- Step 3.** Press one of the keys below to set the port extension value.

Port Extension Value and Unit	Key Stroke
Set port extension value in delay time	VALUE (TIME)
Set port extension value in electrical length	VALUE (LENGTH)

The current port extension value is displayed in the setting parameter area of the LCD's upper-left side.

- Step 4.** Use the keys or rotary knob of the ENTRY block in one of the following ways to specify the port extension value.
- Enter the desired value with the numerical keys (**[0]** through **[9]**, **[.]**, **[-]**) and then press one of the unit keys (**[G/n]**, **[M/μ]**, **[k/m]**, or **[×1]**).
 - Turn the rotary knob (**○**) until the desired value is set.
 - Press the step keys (**[↑]**/**[↓]**) to set the desired value.

NOTE

You can set the port extension value in either electrical length or delay time. When the port extension value is set by one of these keys, the value is converted to the other unit and displayed on the bottom line of the setting parameter area in small letters. You can also see the converted value in the setting parameter area by pressing the other key.

- Step 5.** Press the **EXTENSION on OFF** key to turn on the port extension compensation (pressing the key toggles your selection).

Softkey Label	Port Extension Compensation
EXTENSION ON off	On (make the port extension value valid for measurement)
EXTENSION on OFF	Off (make the port extension value invalid for measurement)

Fixture Compensation

Fixture compensation procedure

Perform the fixture compensation as follows:

NOTE If the oscillator level is greater than 500 mV, an error, “REDUCE OSC LEVEL” or “BRIDGE UNBALANCED,” may occur during the Short correction and measurement may not be correct. When you set the oscillator level for measurement to 500 mV or even greater, set it to 500 mV for the Fixture correction.

NOTE Fixture compensation consists of three compensation data acquisition processes: OPEN, SHORT, and LOAD, but you do not need to obtain all three types of compensation data when you perform fixture compensation. Each type of compensation data can be turned on or off independently for measurement. For normal measurement, it is recommended that you perform fixture OPEN compensation and fixture SHORT compensation.

NOTE For the 4294A, because the sending and receiving ends of a measurement path are terminated with the characteristic impedance of 50 Ω at a measurement frequency of 15 MHz for no cable extension (direct connection type test fixture) or a measurement frequency of 5 MHz or higher for 1 m/2 m cable extension, the trace may contain a gap at 15 MHz (or 5 MHz). You can remove this gap by executing the Load correction.

- Step 1.** Press the **[Cal]** key to display the Calibration Menu.
- Step 2.** Select the calibration (compensation) data acquisition points in accordance with “Selecting Calibration/Compensation Data Points” on page 155.
- Step 3.** Press the **FIXTURE COMPEN** key to display the Fixture Compensation Menu.
- Step 4.** If required, set user-defined standard values in accordance with “Defining the standard values for fixture compensation” on page 153.

NOTE When you perform fixture LOAD compensation for the 16451B Dielectric Test Fixture, you need special setups and procedures for standard definition and other processes. See “Fixture Compensation When the 16451B is Used” on page 136 for details.

When you complete the changes, press the **return** key to return to the Fixture Compensation Menu.

- Step 5.** Put the test fixture's device contacts in the OPEN state.

NOTE Refer to the operation manual furnished with each test fixture for more information on the OPEN state of the test fixture. Generally, the OPEN state can be made by connecting no device to the device contacts. If the distance between the HIGH electrode and the LOW electrode can be adjusted for a test fixture, keep the same distance as when the test device is inserted between the electrodes.

Calibration
Fixture Compensation

Step 6. Press the **OPEN** key to start OPEN compensation data measurement.

During the compensation data measurement, the message “WAIT--MEASURING STANDARD” is displayed in the instrument state area of the LCD's upper-left side.

When OPEN compensation data measurement is completed, the softkey label **OPEN on OFF** (if it is off) changes to **OPEN ON off**.

Step 7. Put the test fixture's device contacts in the SHORT state.

NOTE

Refer to the operation manual furnished with each test fixture for more information on the SHORT state of the test fixture. Generally, the SHORT state can be made by connecting a high conductivity metal (shorting bar) to the device contacts or by shorting the HIGH electrode and LOW electrode directly.

Step 8. Press the **SHORT** key to start SHORT compensation data measurement.

During the compensation data measurement, the message “WAIT--MEASURING STANDARD” is displayed in the instrument state area of the LCD's upper-left side.

When SHORT compensation data measurement is completed, the softkey label **SHORT on OFF** (if it is off) changes to **SHORT ON off**.

Step 9. Connect a LOAD device to the test fixture's device contacts.

NOTE

Refer to the operation manual furnished with each test fixture for more information on the necessity or connection of LOAD compensation.

Step 10. Press the **LOAD** key to start LOAD compensation data measurement.

During the compensation data measurement, the message “WAIT--MEASURING STANDARD” is displayed in the instrument state area of the LCD's upper-left side.

When LOAD compensation data measurement is completed, the softkey label **LOAD on OFF** (if it is off) changes to **LOAD ON off**.

Turning the fixture compensation on or off

The fixture compensation function is automatically turned on after completing each compensation data measurement. However, you can turn the function on or off as required.

- Step 1.** Press the **[Cal]** key to display the Calibration Menu.
- Step 2.** Press the **FIXTURE COMPEN** key to bring up the Fixture Compensation Menu.
- Step 3.** Press the **OPEN on OFF (OPEN ON off)** key, **SHORT on OFF (SHORT ON off)** key, and **LOAD on OFF (LOAD ON off)** key to make each fixture compensation valid (on) or invalid (off) for measurement (pressing these keys toggles your selections).

Softkey Label	Fixture OPEN Compensation
OPEN on OFF	Off
OPEN ON off	On

Softkey Label	Fixture SHORT Compensation
SHORT on OFF	Off
SHORT ON off	On

Softkey Label	Fixture LOAD Compensation
LOAD on OFF	Off
LOAD ON off	On

Defining the standard values for fixture compensation

You can define standard values of OPEN, SHORT, and LOAD for fixture compensation. Figure 6-9 shows the circuit models of the fixture compensation kit used for the Agilent 4294A.

Figure 6-9

Circuit Models of Fixture Compensation Kit

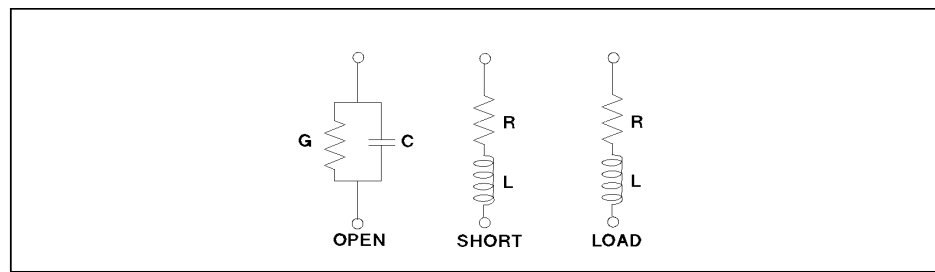

Each compensation standard value can be confirmed and changed as follows:

- Step 1.** Press the **[Cal]** key to display the Calibration Menu.
- Step 2.** Press the **FIXTURE COMPEN** key to display the Fixture Compensation Menu.
- Step 3.** Press the **DEFINE VALUE** key to display the Compensation Data Definition Menu.

Calibration

Fixture Compensation

Step 4. Select one of the compensation data definition keys, **OPEN CONDUCT(G)**, **OPEN CAP(C)**, **SHORT RESIST(R)**, **SHORT INDUCT(L)**, **LOAD RESIST(R)**, or **LOAD INDUCT(L)**, to confirm or set the compensation data definition.

Compensation Data Definition	Key Stroke
Equivalent parallel conductance value (G) of OPEN standard used for fixture compensation (preset state: 0 S)	OPEN CONDUCT(G)
Equivalent parallel capacitance value (C) of OPEN standard used for fixture compensation (preset state: 0 F)	OPEN CAP(C)
Equivalent series resistance value (R) of SHORT standard used for fixture compensation (preset state: 0 Ω)	SHORT RESIST(R)
Equivalent series inductance value (L) of SHORT standard used for fixture compensation (preset state: 0 H)	SHORT INDUCT(L)
Equivalent series resistance value (R) of LOAD standard used for fixture compensation (preset state: 50 Ω)	LOAD RESIST(R)
Equivalent series inductance value (L) of LOAD standard used for fixture compensation (preset state: 0 H)	LOAD INDUCT(L)

The current value of the compensation data definition is displayed in the setting parameter area of the LCD's upper-left side.

- Step 5.** Use the keys or rotary knob of the ENTRY block in one of the following ways to specify the compensation data definition .
- Enter the desired value with the numerical keys (**[0]** through **[9]**, **[.]**, **[-]**) and then press one of the unit keys (**[G/n]**, **[M/ μ]**, **[k/ μ]**, or **[\times 1]**).
 - Turn the rotary knob (**(O)**) until the desired value is set.
 - Press the step keys (**[↑]****[↓]**) to set the desired value.

NOTE

When entering the capacitance value in the compensation data definition, the **[fF]** unit is automatically added at the end of the value you enter with the unit keys. For example, if you enter a value with the numeric keys and then press the **[x1]** key, the **[fF]** unit is added to the entered value.

Step 6. Repeat steps 4 and 5 to set all of the required compensation data definitions.

Selecting Calibration/Compensation Data Points

You can choose the type of frequency points to use in obtaining user calibration data and fixture compensation data as follows:

- Step 1.** Press the **[Cal]** key to display the Calibration Menu.
- Step 2.** Press the **COMP POINT []** key to select the measurement points used for user calibration or those for fixture compensation (pressing the key toggles your selection).

Softkey Label	Calibration/Compensation Points
COMP POINT [FIXED]	Obtain calibration/compensation data at fixed frequency points ¹ covering the entire frequency range of the 4294A. In device measurement, user calibration or fixture compensation is applied to each measurement point by using interpolation. Even if the measurement points are changed by altering the sweep setups, you don't need to retake the calibration or compensation data.
COMP POINT [USER]	Obtain calibration/compensation data at the same frequency points as used in actual device measurement, which are determined by the sweep setups. Each set of calibration/compensation data is applied to each measurement at the same point. If measurement points are changed by altering the sweep setups, calibration/compensation data become invalid and calibration or compensation data acquisition is again required.

1. See "List of fixed calibration/compensation frequency points" on page 156.

NOTE

The calibration/compensation data point selection set by the **COMP POINT []** key is common to user calibration and fixture compensation. You cannot set the selection for either one of them independently.

When the selection of calibration/compensation data points is changed after completing user calibration or fixture compensation, the obtained user calibration or fixture compensation data become invalid. Therefore, do not change the selection of the calibration (compensation) data points after completing user calibration or fixture compensation.

List of fixed calibration/compensation frequency points

When the fixed frequency points for user calibration and fixture compensation are selected (softkey label: **COMP POINT [FIXED]**), calibration/compensation is performed at the frequency points listed in Table 6-2.

Table 6-2**Fixed Calibration/Compensation Points (100 points, in Hz)**

40, 45, 55, 70, 91,
130, 195, 320, 600,
1k, 2.1k, 4k, 9.5k,
21k, 40k, 96k,
130k, 170k, 230k, 275k, 320k, 400k, 510k, 630k, 750k, 800k, 900k,
1M, 1.1M, 1.1M, 1.6M, 1.9M, 2.3M, 2.6M, 3M, 3M, 3.4M, 3.8M, 4.2M, 4.6M, 5M, 5M, 6M, 7M, 8.5M,
10M, 11.5M, 13M, 14M, 15M, 15M, 16M, 18M, 20M, 20M, 22M, 24M, 26M, 28M, 30M, 32M, 34M, 36M, 38M, 40M, 42M, 44M, 46M, 48M, 50M, 52M, 54M, 56M, 58M, 60M, 62M, 64M, 66M, 68M, 70M, 72M, 74M, 76M, 78M, 79.9M, 82M, 84M, 86M, 88M, 90M, 92M, 94M, 96M, 98M,
100M, 102M, 104M, 106M, 108M, 110M

NOTE

The same frequency points are shown in different positions in Table 6-2 because calibration/compensation is performed at some frequency points depending on the different internal setups used with the Agilent 4294A.

7

Setting Up the Display of Measurement Results

This chapter describes how to configure the Agilent 4294A Precision Impedance Analyzer to display the measurement results in the way that best suits your needs.

Selecting the Measurement Parameters

Step 1. Press the [Meas] key to display the Measurement Parameter menu.

Step 2. Select the measurement parameter for each trace with a keystroke shown in Table 7-1.

Table 7-1 Selecting the Measurement Parameters

To select:		Press:
Trace A	Trace B	
Absolute impedance value	Impedance phase	Z - θ
Equivalent series resistance	Equivalent series reactance	R-X
Equivalent series inductance	Equivalent series resistance	Ls-Rs
Equivalent series inductance	Q value ¹	Ls-Q
Equivalent series capacitance	Equivalent series resistance	Cs-Rs
Equivalent series capacitance	Q value ¹	Cs-Q
Equivalent series capacitance	Dissipation factor	Cs-D
Absolute admittance	Admittance phase	more 1/3 - Y θ
Equivalent parallel conductance	Equivalent parallel susceptance	more 1/3 - G-B
Equivalent parallel inductance	Equivalent parallel conductance	more 1/3 - Lp-G
Equivalent parallel inductance	Q value ¹	more 1/3 - Lp-Q
Equivalent parallel capacitance	Equivalent parallel conductance	more 1/3 - Cp-G
Equivalent parallel capacitance	Q value ¹	more 1/3 - Cp-Q
Equivalent parallel capacitance	Dissipation factor	more 1/3 - Cp-D
Impedance (complex value)	Admittance (complex value)	more 1/3 - more 2/3 - COMPLEX Z-Y
Absolute impedance value	Equivalent series inductance	more 1/3 - more 2/3 - Z -Ls
Absolute impedance value	Equivalent series capacitance	more 1/3 - more 2/3 - Z -Cs
Absolute impedance value	Equivalent parallel inductance	more 1/3 - more 2/3 - Z -Lp
Absolute impedance value	Equivalent parallel capacitance	more 1/3 - more 2/3 - Z -Cp
Absolute impedance value	Equivalent series resistance	more 1/3 - more 2/3 - other - Z -Rs
Absolute impedance value	Q value ¹	more 1/3 - more 2/3 - other - Z -Q
Absolute impedance value	Dissipation factor	more 1/3 - more 2/3 - other - Z -D
Equivalent parallel inductance	Equivalent parallel resistance	more 1/3 - more 2/3 - other - Lp-Rp
Equivalent parallel capacitance	Equivalent parallel resistance	more 1/3 - more 2/3 - other - Cp-Rp

1. Quality factor.

NOTE

The Agilent 4294A preserves the graph axis formats, scale settings, data and memory trace contents, and trace definitions for each parameter (for example, Ls) unless it is turned off or reset to its preset state. This feature makes it easy to examine the DUT from various perspectives by switching among a number of measurement parameters. For detailed information on configuring the settings that control how the Agilent 4294A displays measurement results, refer to the following sections:

- “Selecting the Graph Axis Format” on page 160
- “Auto-scaling the Trace” on page 164
- “Manual Scale Setting (for measurements other than COMPLEX Z-Y)” on page 166
- “Manually Scaling the Active Trace for a COMPLEX Z-Y Graph” on page 172
- “Selecting the Target Trace Type (Data or Memory)” on page 177
- “Enabling or Disabling Coupled Scaling Mode” on page 178
- “Trace-based Comparison and Calculation” on page 179

You can set each measurement parameter without specifying the active trace or checking its current state.

Selecting the Graph Axis Format

When Using Cartesian Coordinates

Unless the Agilent 4294A is configured to perform a COMPLEX Z-Y measurement (complex impedance for Trace A, complex admittance for Trace B), it displays measurement results in a Cartesian-coordinate graph whose horizontal and vertical axes indicate the sweep and measurement parameter values, respectively. Use the following procedure to select the vertical axis format for a Cartesian-coordinate graph:

Step 1. Activate the trace for which you want to set the axis format.

To activate:	Press:
Trace A	[A]
Trace B	[B]

Step 2. Press the **[Format]** key to display the Format menu.

Step 3. Select the desired vertical axis format by pressing the appropriate key:

To select:	Press:
Linear	LIN
Logarithmic	LOG

NOTE

The horizontal axis format is automatically determined based on the selected sweep type.

Figure 7-1 Vertical axis for $|Z|$: linear format

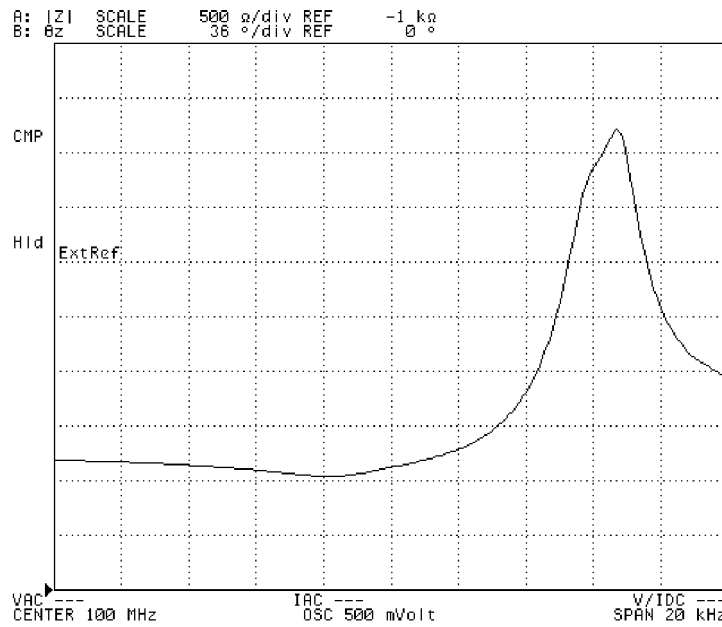

4294aoj020

Figure 7-2 Vertical axis for $|Z|$: logarithmic format

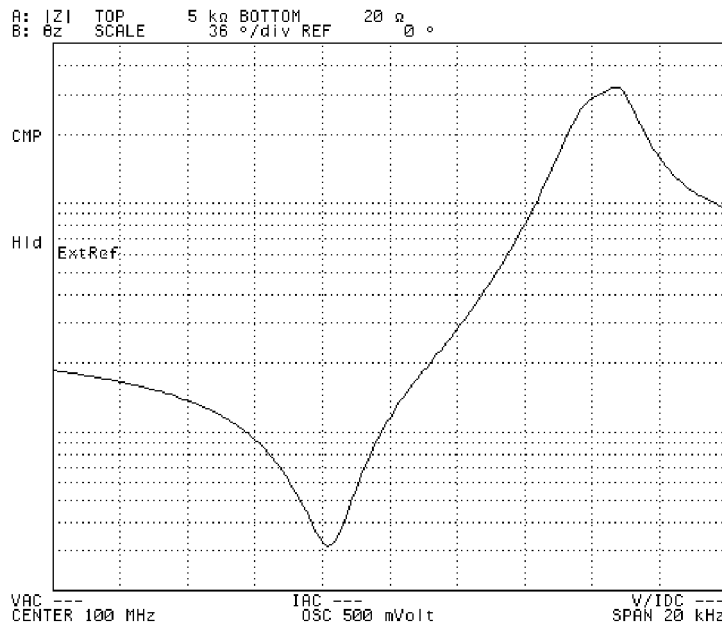

4294aoj021

7. Setting Up the Display of Measurement Results

Setting Up the Display of Measurement Results
Selecting the Graph Axis Format

When Using Complex Parameters (COMPLEX Z-Y)

When the Agilent 4294A is configured to perform a COMPLEX Z-Y measurement (complex impedance for Trace A, complex admittance for Trace B), use the following procedure to select the graph axis formats:

Step 1. Activate the trace for which you want to set the axis format.

To activate:	Press:
Trace A	[A]
Trace B	[B]

Step 2. Press the [Format] key to display the Format menu.

Step 3. Select the desired graph axis format by pressing the appropriate key:

To select:	Press:
Complex plane (where the horizontal and vertical axes use real and complex values, respectively)	COMPLEX
Polar chart	POLAR

Figure 7-3

Complex plane whose Y axis indicates complex admittance (with only Trace B displayed)

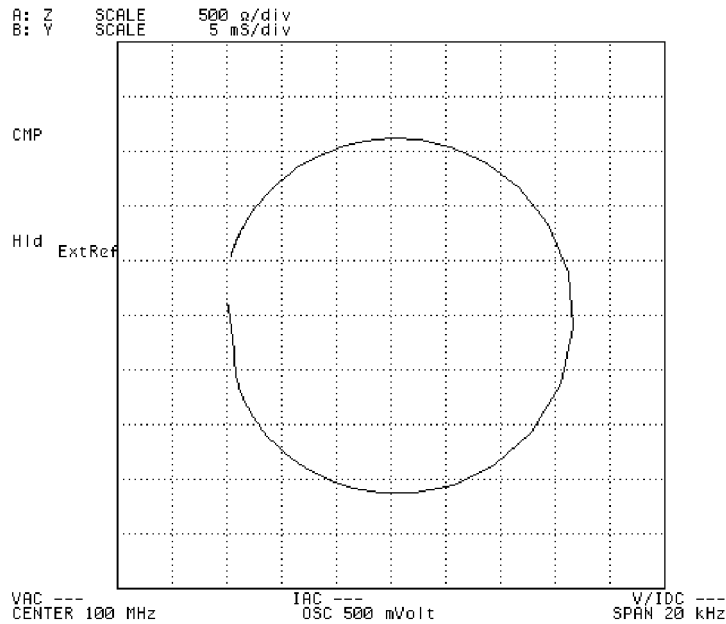

4294aaj022

Figure 7-4

Polar chart whose Y axis indicates complex admittance (with only Trace B displayed)

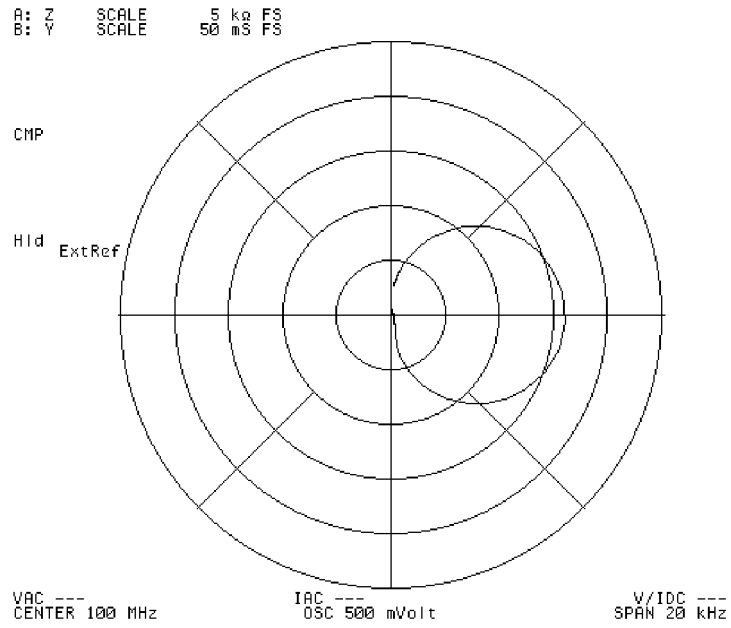

4294aoj023

Auto-scaling the Trace

Step 1. Activate the trace you want auto-scaled.

To activate:	Press:
Trace A	[A]
Trace B	[B]

Step 2. Press the [Scale Ref] key to display the first page of the Scale Reference menu.

Step 3. Press the **AUTO SCALE** key to auto-scale the trace based on the current trace data. This adjusts the scale of the trace so that you can easily examine the overall characteristics while making all of the data visible within the graph.

Figure 7-5

Before auto-scaling

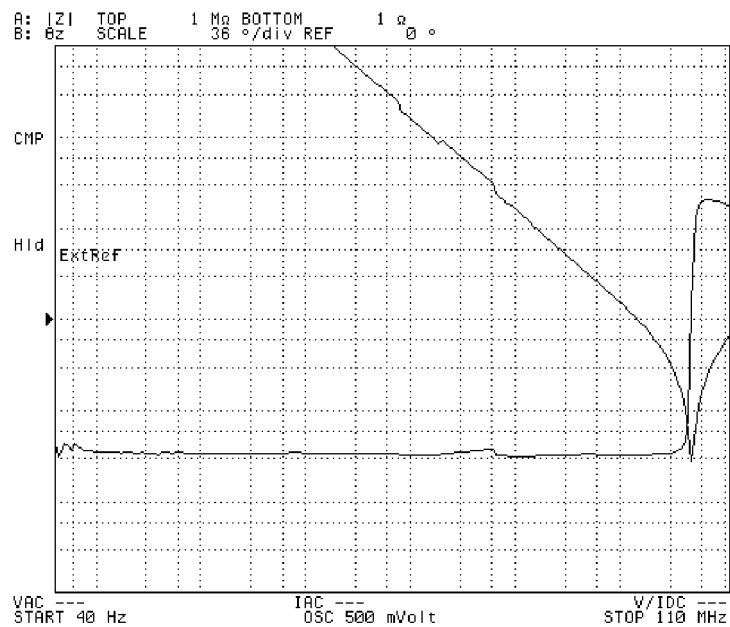

4294aoj024

Figure 7-6 After auto-scaling

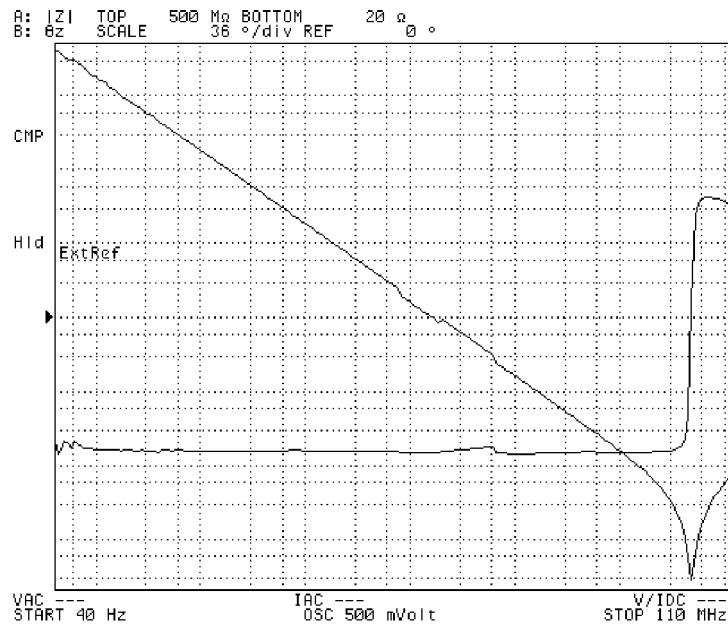

4294aoj025

NOTE

When you have both the data and memory traces displayed, you can specify which trace type you want auto-scaled. For more information, refer to “Selecting the Target Trace Type (Data or Memory)” on page 177.

Manual Scale Setting (for measurements other than COMPLEX Z-Y)

This section describes how to manually scale the active trace for a Cartesian-coordinate graph. Note that these procedures do not apply when the Agilent 4294A is configured to perform a COMPLEX Z-Y measurement (complex impedance for Trace A, complex admittance for Trace B).

Scaling the Trace Based on the Reference Line and Resolution per Division

When the vertical axis is linear, you can scale the trace by first specifying where to position the reference line and what value to assign to it and then setting the scale for each division.

Step 1. Activate the trace you want to manually scale.

To activate:	Press:
Trace A	[A]
Trace B	[B]

Step 2. Press the **[Scale Ref]** key to display the Scale Reference menu.

Step 3. Press the **REFERENCE POSITION** key. The Parameter Setting field in the upper left area of the screen displays a value that represents where the reference line is currently positioned in relation to the bottom of the graph. This value ranges from 0 (bottom) and 10 (top). In the preset state, the reference line position defaults to 5, which means that it is displayed at the center of the graph.

Step 4. Use the keys or rotary knob of the ENTRY block in one of the following ways to specify the position of the reference line.

- Enter the desired value with the numeric keys ([0] to [9] and [.] and then press one of the unit keys ([G/n], [M/μ], [k/m], or [x1]).
- Turn the rotary knob (○) until the desired value is set.
- Press the step keys ([↑][↓]) to set the desired value.

Figure 7-7 **Positioning the reference line**

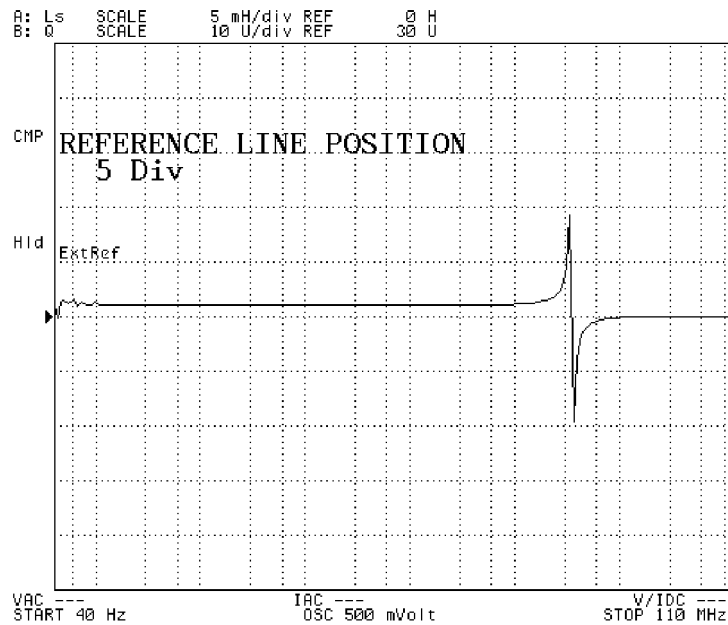

4294aoj026

NOTE

The reference line is a horizontal dotted line displayed in the same color as the corresponding trace. At the left end of the reference line, a “▶” symbol is displayed in the same color.

- Step 5.** Press the **REFERENCE VALUE** key. The Parameter Setting field in the upper left area of the screen indicates the reference value currently in effect, that is, the value of the measurement parameter that corresponds to the current reference line position.
- Step 6.** Use the keys or rotary knob of the ENTRY block in one of the following ways to specify the reference value.
 - Enter the desired value with the numeric keys (**[0]** to **[9]** and **[.]**) and then press one of the unit keys (**[G/n]**, **[M/μ]**, **[k/m]**, or **[×1]**).
 - Turn the rotary knob (**○**) until the desired value is set.
 - Press the step keys (**[↑]**/**[↓]**) to set the desired value.

7. Setting Up the Display of Measurement Results

Setting Up the Display of Measurement Results
Manual Scale Setting (for measurements other than COMPLEX Z-Y)

Figure 7-8

Setting the reference value

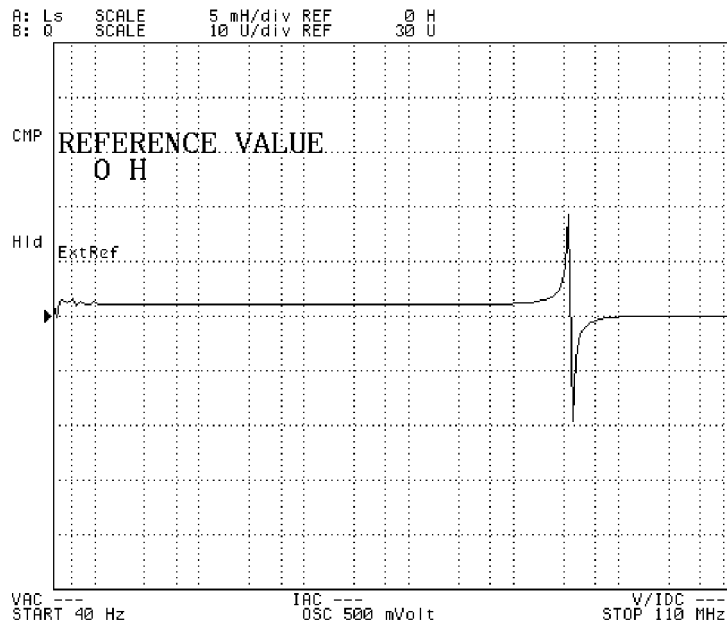

4294aoj027

NOTE

Alternatively, when you have the main marker displayed on the trace, you can press the **MKR** → **REFERENCE** key to use the value at the marker position as the reference value. Thus, you can change the trace scale by placing the reference line at the position indicated by the main marker. The **MKR** → **REFERENCE** key is also accessible from the Marker → menu, which is displayed when you press the **[Marker →]** key.

- Step 7.** Press the **SCALE/DIV** key. The Parameter Setting field in the upper left area of the screen indicates the scale per deviation currently in effect.
- Step 8.** Use the keys or rotary knob of the ENTRY block in one of the following ways to specify the scale per division.
- Enter the desired value with the numeric keys (**[0]** to **[9]** and **[.]**) and then press one of the unit keys (**[G/n]**, **[M/μ]**, **[k/m]**, or **[×1]**).
 - Turn the rotary knob (○) until the desired value is set.
 - Press the step keys (**[↑]**/**[↓]**) to set the desired value.

Figure 7-9 **Setting the scale per division**

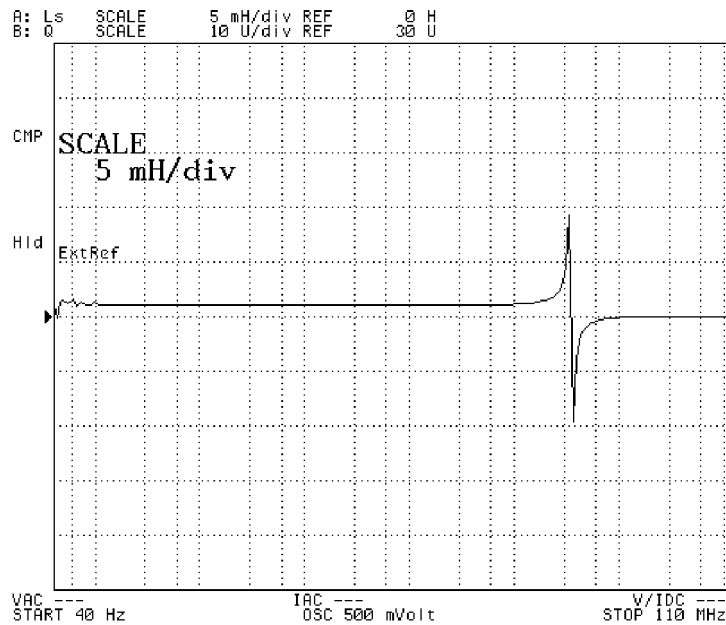

4294aoj028

7. Setting Up the Display of Measurement Results

Scaling the Trace Based on the Top and Bottom Values

Whether the vertical axis is linear or logarithmic, you can scale the trace by specifying the highest (top) and lowest (bottom) values displayed within the graph.

Step 1. Activate the trace you want to manually scale.

To activate:	Press:
Trace A	[A]
Trace B	[B]

Step 2. Press the **[Scale Ref]** key to display the Scale Reference menu.

Step 3. Press the **TOP VALUE** key. The Parameter Setting field in the upper left area of the screen indicates the top value currently in effect, that is, the value that corresponds to the line displayed at the top of the graph.

Step 4. Use the keys or rotary knob of the ENTRY block in one of the following ways to specify the top value.

- Enter the desired value with the numeric keys ([0] to [9] and [.]) and then press one of the unit keys ([G/n], [M/μ], [k/m], or [×1]).
- Turn the rotary knob (O) until the desired value is set.
- Press the step keys ([↑][↓]) to set the desired value.

Setting Up the Display of Measurement Results
Manual Scale Setting (for measurements other than COMPLEX Z-Y)

Figure 7-10 Setting the top value

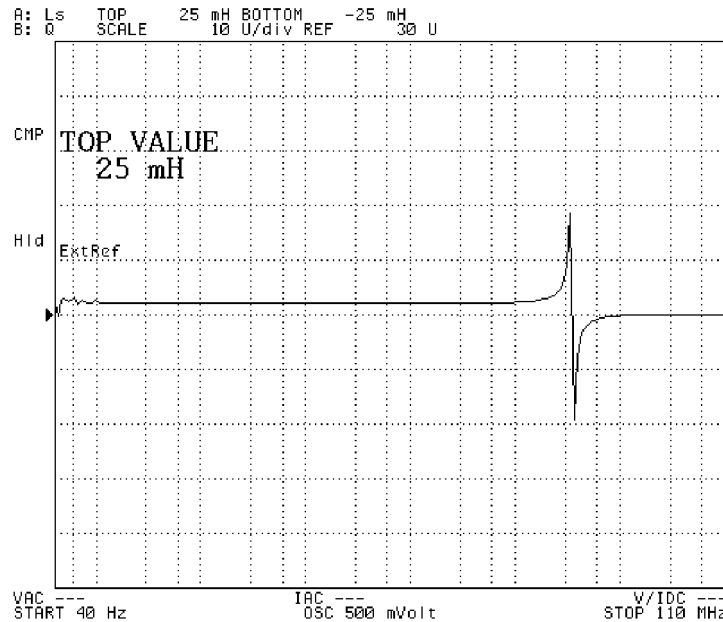

4294aoj029

Step 5. Press the **BOTTOM VALUE** value. The Parameter Setting field in the upper left area of the screen indicates the bottom value currently in effect, that is, the value that corresponds to the line displayed at the bottom of the graph.

Step 6. Use the keys or rotary knob of the ENTRY block in one of the following ways to specify the bottom value.

- Enter the desired value with the numeric keys ([0] to [9] and [.] and then press one of the unit keys ([G/n], [M/ μ], [k/m], or [\times 1]).
- Turn the rotary knob (O) until the desired value is set.
- Press the step keys ([\uparrow][\downarrow]) to set the desired value.

Figure 7-11 Setting the bottom value

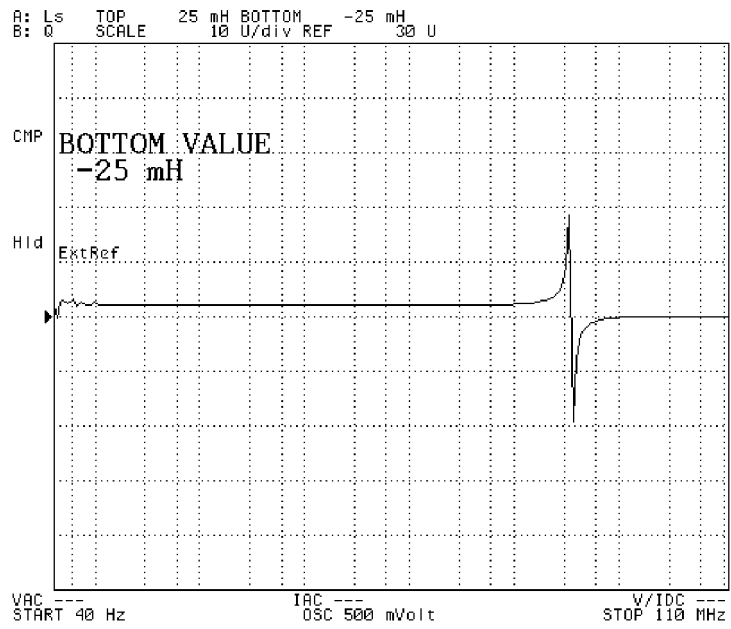

4294aoj030

Manually Scaling the Active Trace for a COMPLEX Z-Y Graph

This section describes how to manually scale the active trace when the Agilent 4294A is configured to perform a COMPLEX Z-Y measurement (complex impedance for Trace A, complex admittance for Trace B).

Scaling the Active Trace for a Complex Plane

When your graph is a complex plane, you can manually scale the active trace by specifying the reference values for the vertical and horizontal axes as well as the scale per division.

Step 1. Activate the trace you want to manually scale.

To activate:	Press:
Trace A	[A]
Trace B	[B]

Step 2. Press the **[Scale Ref]** key to display the Scale Reference menu.

Step 3. Press the **REFERENCE X VALUE** key. The Parameter Setting field in the upper left area of the screen indicates the reference value currently in effect for the horizontal (X) axis; this value is a real value. The reference line for the horizontal axis in a complex plane is stationary in the center of the axis.

Step 4. Use the keys or rotary knob of the ENTRY block in one of the following ways to specify the reference value for the horizontal (X) axis.

- Enter the desired value with the numeric keys ([0] to [9] and [.] and then press one of the unit keys ([G/n], [M/ μ], [k/m], or [$\times 1$]).
- Turn the rotary knob (O) until the desired value is set.
- Press the step keys ([\uparrow][\downarrow]) to set the desired value.

Figure 7-12 Setting the X-axis reference value for a complex plane (for measuring complex impedance)

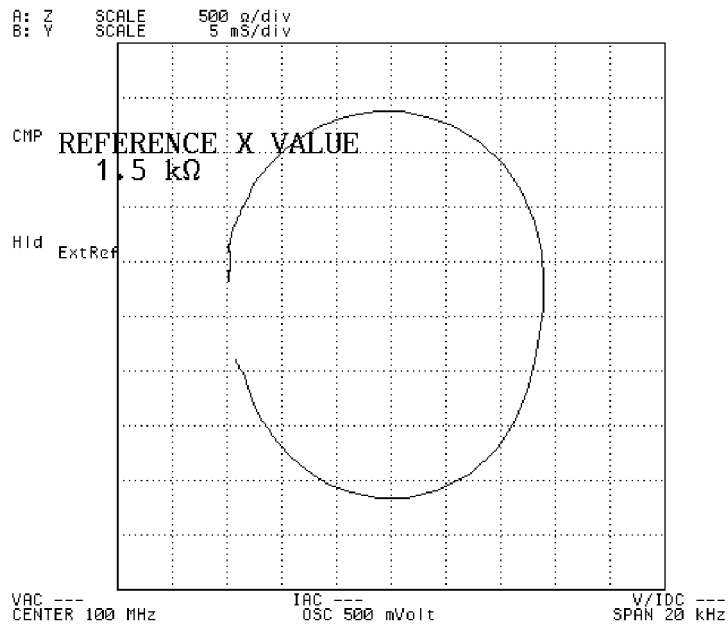

4294aoj031

- Step 5.** Press the **REFERENCE Y VALUE** key. The Parameter Setting field in the upper left area of the screen indicates the reference value currently in effect for the vertical (Y) axis; this value is a complex value. The reference line for the vertical axis in a complex plane is stationary in the center of the axis.
- Step 6.** Use the keys or rotary knob of the ENTRY block in one of the following ways to specify the reference value for the vertical (Y) axis.
- Enter the desired value with the numeric keys ([0] to [9] and [.] and then press one of the unit keys ([G/n], [M/ μ], [k/m], or [\times 1]).
 - Turn the rotary knob (O) until the desired value is set.
 - Press the step keys ([\uparrow]/[\downarrow]) to set the desired value.

Figure 7-13 Setting the Y-axis reference value for a complex plane (for measuring complex

Setting Up the Display of Measurement Results Manually Scaling the Active Trace for a COMPLEX Z-Y Graph

impedance)

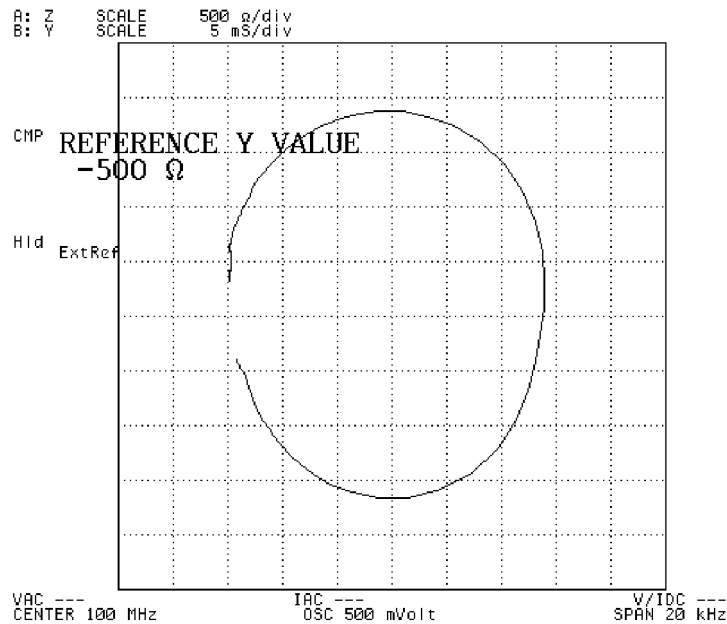

4294aoj032

Step 7. Press the **SCALE/DIV** key. The Parameter Setting field in the upper left area of the screen indicates the scale per division currently in effect. For a complex plane, both the vertical and horizontal axes use the same scale per division.

Step 8. Use the keys or rotary knob of the ENTRY block in one of the following ways to specify the scale per division.

- Enter the desired value with the numeric keys (**[0]** to **[9]** and **[.]**) and then press one of the unit keys (**[G/n]**, **[M/ μ]**, **[k/m]**, or **[\times 1]**).
- Turn the rotary knob (**(O)**) until the desired value is set.
- Press the step keys (**(\uparrow)**/**(\downarrow)**) to set the desired value.

Figure 7-14 Setting the scale per division for a complex plane (for measuring complex impedance)

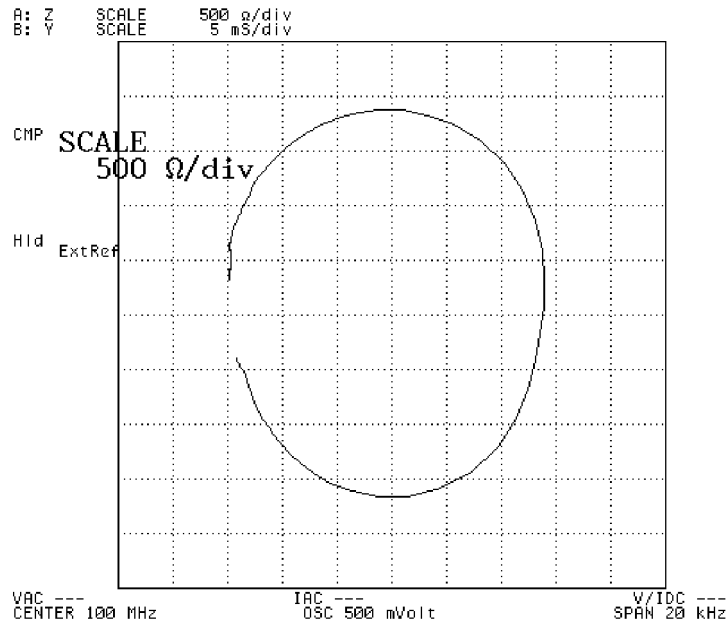

4294aoj033

Scaling the Active Trace for a Polar Chart

When your graph is a polar chart, you can scale the active trace by specifying the full scale value, that is, the distance from the origin to the outermost circle.

Step 1. Activate the trace you want to manually scale.

To activate:	Press:
Trace A	[A]
Trace B	[B]

Step 2. Press the **[Scale Ref]** key to display the Scale Reference menu.

Step 3. Press the **FULL SCALE VALUE** key. The Parameter Setting field in the upper left area of the screen indicates the full scale value currently in effect.

Step 4. Use the keys or rotary knob of the ENTRY block in one of the following ways to specify the full scale value.

- Enter the desired value with the numeric keys ([0] to [9] and [.]) and then press one of the unit keys ([G/n], [M/μ], [k/m], or [×1]).
- Turn the rotary knob (O) until the desired value is set.
- Press the step keys ([↑][↓]) to set the desired value.

Setting Up the Display of Measurement Results
Manually Scaling the Active Trace for a COMPLEX Z-Y Graph

Figure 7-15

Setting the full scale value for a polar chart (for measuring complex impedance)

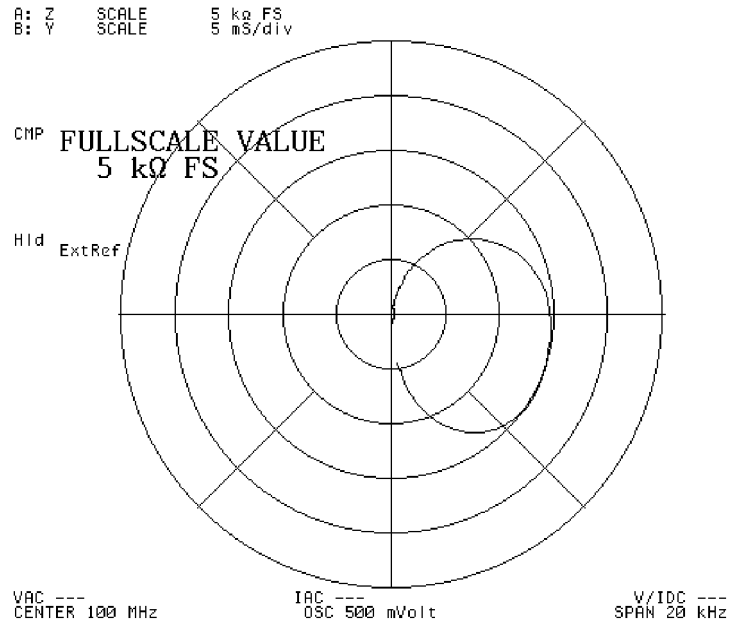

4294aoj034

NOTE

Alternatively, when you have the main marker displayed on the trace, you can press the **MKR** → **REFERENCE** key to use the value at the marker position (i.e., the distance from the origin) as the full scale value. Thus, you can change the trace scale by placing the full scale circle at the position indicated by the main marker.

Selecting the Target Trace Type (Data or Memory)

When changing the scale and display settings through the Scale Reference menu with both the data and memory traces displayed, you can specify whether to apply the new settings to the data or memory trace.

Step 1. Activate the trace you want to manually scale.

To activate:	Press:
Trace A	[A]
Trace B	[B]

Step 2. Press the **[Scale Ref]** key to display the Scale Reference menu.

Step 3. Press the **more 1/2** key to move to the second page of the Scale Reference menu if the vertical axis of the graph is not logarithmic or the measurement parameter is not COMPLEX Z-Y.

Step 4. Press the **SCALE FOR []** key to select the target trace type (either data or memory).

Softkey Labels	Target Trace Type
SCALE FOR [DATA]	Data trace
SCALE FOR [MEMO]	Memory trace

NOTE

The Agilent 4294A provides a feature called “coupled scaling mode” that synchronizes the scale settings of the data and memory traces. When coupled scaling mode is on, changes made to the scale of the target trace type are also applied to the non-target trace type. For more information on coupled scaling mode, refer to “Enabling or Disabling Coupled Scaling Mode” on page 178.

When either the data or memory trace is displayed, that trace type is automatically selected as the target trace type and you cannot change the target to the other trace type.

Enabling or Disabling Coupled Scaling Mode

When both the data and memory traces are displayed, the Agilent 4294A synchronizes the scale settings between them so that changes made to the scale of either trace are automatically applied to the other. This feature, which is called “coupled scaling mode,” is enabled by default when the Agilent 4294A is in its preset state. However, there will be times when you want to apply different scale settings to each of the data and memory traces. To do so, you need to disable coupled scaling mode. Use the following procedure to turn on or off this feature.

Step 1. Activate the trace for which you want to turn on or off coupled scaling mode.

To activate:	Press:
Trace A	[A]
Trace B	[B]

Step 2. Press the [Scale Ref] key to display the Scale Reference menu.

Step 3. Press the **more 1/2** key to move to the second page of the Scale Reference menu.

NOTE

This step is not applicable when the vertical axis of the graph is logarithmic or the measurement parameter is COMPLEX Z-Y.

Step 4. Press the **D&M COPULE on OFF** (or D&M COPULE ON off) key to turn on or off coupled scaling mode (pressing the key toggles your selection).

Softkey Labels	Description
D&M COPULE ON off	Indicates that scaling mode is enabled (enabling this mode causes the 4294A to synchronize the scale settings between the data and memory traces).
D&M COPULE on OFF	Indicates that coupled scaling mode is disabled (disabling this mode allows you to set different scale settings for each of the data and memory traces).

NOTE

For how to target the data or memory trace for scale and display settings, refer to “Selecting the Target Trace Type (Data or Memory)” on page 177.

Trace-based Comparison and Calculation

Traces A and B each provide two different trace types: data and memory. The data trace keeps track of the DUT's characteristics as it is being tested, while the memory trace captures the measurement data at a specific point in time and displays that data. With the data trace, you can perform a simple calculation on the measurement data and display the results. For example, you can display the differential between the measured data and the memory trace data or the result of subtracting your specified offset value from the measured data. Table 7-1 lists the trace types and their functions:

Trace Types		Functions
Trace A	Data trace (yellow ¹)	Displays measurement data/calculations (updated during measurement cycle)
	Memory trace (green ¹)	Stores and displays previously measured data (captures data when DATA → MEMORY is pressed)
Trace B	Data trace (blue ¹)	Displays measurement data/calculations (updated during measurement cycle)
	Memory trace (brown ¹)	Stores and displays previously measured data (captures data when DATA → MEMORY is pressed)

1. Factory default settings. For how to change this setting, refer to “Customizing the Color of Each Screen Item” on page 208.

These features add flexibility to your testing task; for example, on the same screen you can compare the data and memory traces with each other or simultaneously display the results of a calculation as shown by the data and memory traces.

Identifying Differences between Data and Memory Traces through Comparison or Calculation

- Step 1.** Activate the trace for which you want to perform calculation or comparison between the two trace types.

To activate:	Press:
Trace A	[A]
Trace B	[B]

- Step 2.** Press the **[Display]** key to display the Display menu.
- Step 3.** Press the **DEF TRACE []** key to display the Trace Definition menu.
- Step 4.** Press the **DATA** key to have the data trace directly store and display the measurement data. Note that **DATA** is selected by default in the preset state.
- Step 5.** Start testing the DUT so that the data trace displays the results (for the steps necessary to perform such a measurement, refer to the appropriate chapters in this guide). You will store this measurement data into the memory trace later in this procedure.

Setting Up the Display of Measurement Results
Trace-based Comparison and Calculation

NOTE At this time, you may want to hold (stop) the sweep cycle for the data trace by pressing the **HOLD** key in the Trigger menu, which is accessible from the **[Trigger]** key. Doing so ensures that you can create an exact snapshot of the measurement data when you later store the data into the memory trace.

- Step 6.** Press the **[Display]** key to display the Display menu.
- Step 7.** Press the **DEF TRACE []** key to display the Trace Definition menu.
- Step 8.** Press the **DATA → MEMORY** key to store the measurement data into the memory trace.

Figure 7-16 Storing measurement data into memory trace (with constant frequency of 1 MHz)

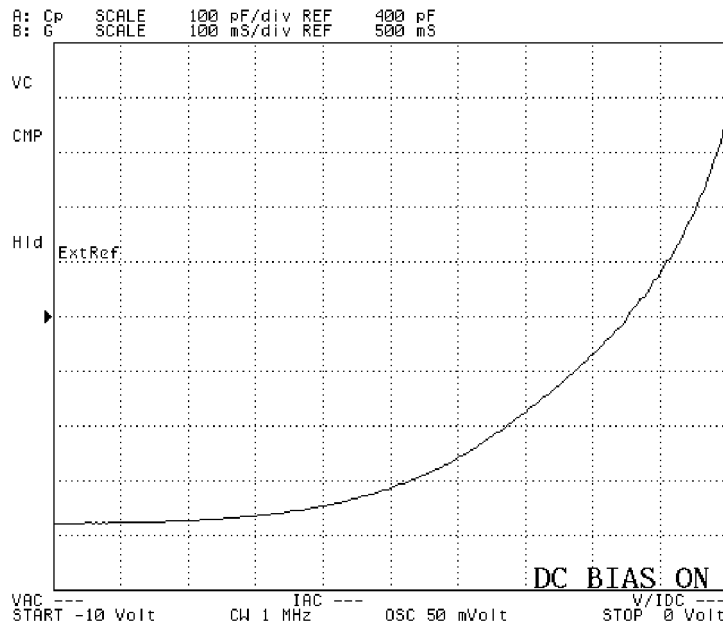

4294aaj035

NOTE When you press the **DATA → MEMORY** key, the memory trace captures the measurement data exactly as it is displayed on screen. The memory trace always stores measurement data, even when the data trace is displaying the results of a calculation. Note that while the subtraction of the offset value is being executed, described in “Subtracting an Offset Value” on page 184, the resulting subtraction is stored in the memory trace.

The **DATA → MEMORY** key affects both Traces A and B. This means that the measurement data for the non-active trace is also stored into the memory trace.

- Step 9.** The Agilent 4294A provides a number of options that allow you to control how each trace is displayed. Select one of the following display options by pressing the appropriate key:

Data trace	Memory trace	Press:
DATA	(Hidden)	DATA

Data trace	Memory trace	Press:
(Hidden)	MEM	MEMORY
DATA	MEM	DATA and MEMORY
DATA - MEM	(Hidden)	DATA-MEMORY
$\frac{DATA - MEM}{MEM} \times 100$	(Hidden)	DELTA %
DATA/MEM	(Hidden)	DATA/MEM

In the table above, DATA represents the current measurement data while MEM represents the data captured by pressing the **DATA** → **MEMORY** key.

- Step 10.** Start testing the DUT to obtain the measurement data for comparison or calculation with the reference measurement data you stored into the memory trace in step 5 (if the sweep cycle is in the hold state, you can restart the measurement by pressing the **[Trigger]** key).

NOTE

If the number of measuring points you specify in step 10 is different than the measurement data stored in the memory trace, then the memory trace is cleared and the data trace will display only the measurement data (this is equivalent to pressing the **DATA** key).

The **DELTA %** key is not available when your measurement parameter is COMPLEX Z-Y. Conversely, the **DATA/MEM** key is available only when your measurement parameter is COMPLEX Z-Y.

If you specify an offset value, the data trace displays the result of subtracting the offset value from the specific type of data that corresponds to the display option you selected in step 9. (For more information on setting an offset value, refer to “Subtracting an Offset Value” on page 184.)

Setting Up the Display of Measurement Results
Trace-based Comparison and Calculation

Figure 7-17

Measuring reference data for comparison (with constant frequency of 50 MHz)

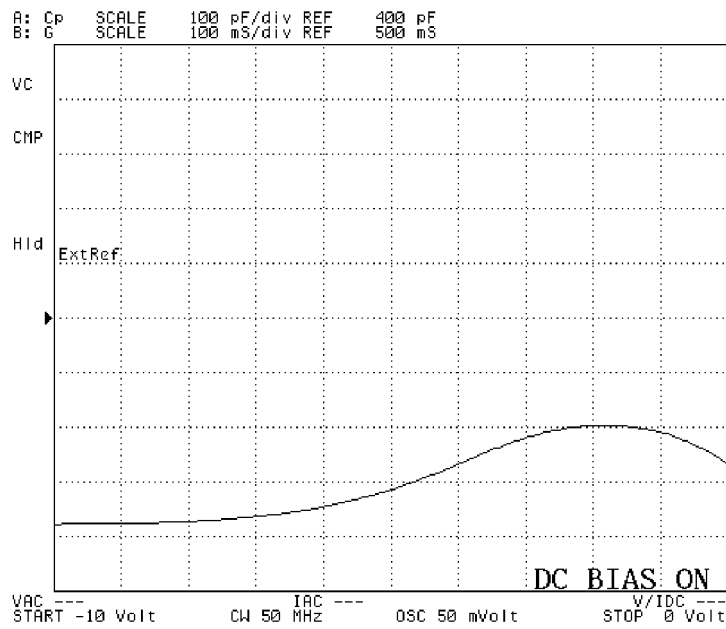

4294aoj036

Figure 7-18

Comparing trace data (by selecting DATA and MEMORY key)

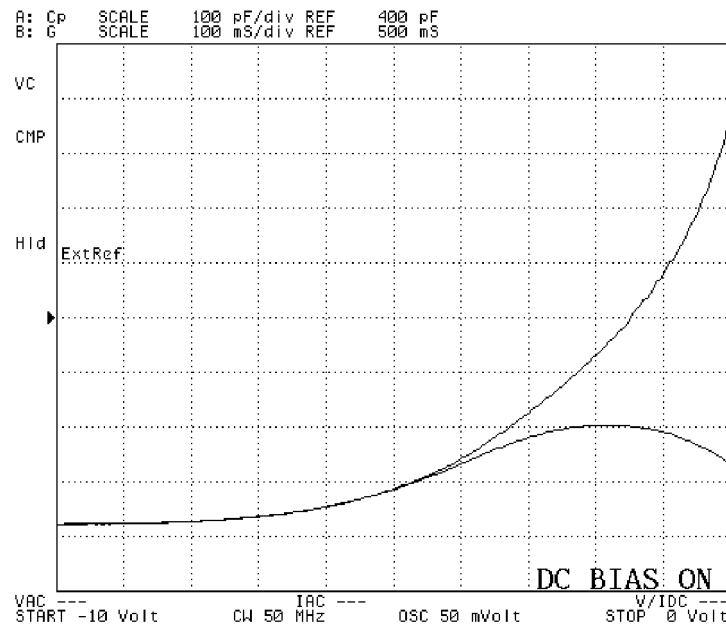

4294aoj037

Figure 7-19 Displaying differential from reference data (by selecting DATA - MEMORY key)

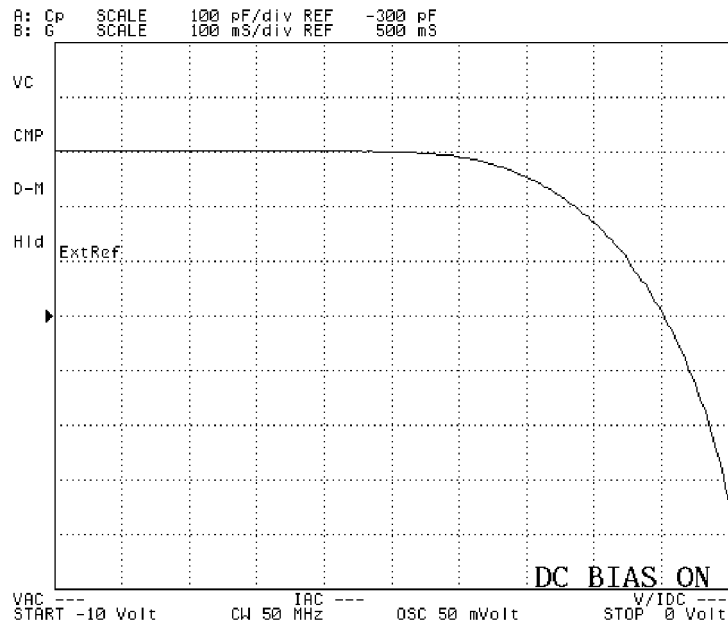

4294aoj038

Figure 7-20 Displaying differential percentage from reference data (by selecting DELTA % key)

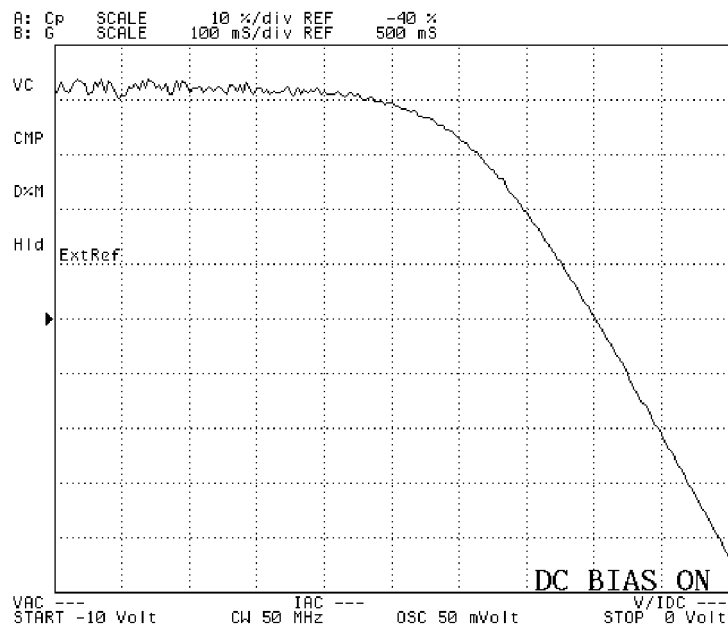

4294aoj039

NOTE When the result of a calculation is displayed on the data trace, the Instrument Status area

7. Setting Up the Display of Measurement Results

Setting Up the Display of Measurement Results

Trace-based Comparison and Calculation

on the measurement screen indicates a simplified expression of the calculation. For more information, refer to “17. Instrument Status Area” on page 57.

You can use the scaling and marker features with the memory trace in the same ways as you can with the data trace. To specify whether to apply the scaling feature to the data or memory trace, press the **[Scale]** - (more 1/2) key to display the Scale Reference menu, and then press the **SCALE FOR []** key to select the target trace type. Similarly, to specify whether to apply the marker feature to the data or memory trace, press the **[Marker]** key, and then press the **MKR ON []** key to select the target trace type.

When you want to compare three or more traces, you can use the trace superimpose feature. For more information, refer to “Superimposing Multiple Traces” on page 185.

Subtracting an Offset Value

You can specify an offset value to be subtracted from the measurement data, and the result of this operation is displayed by the data trace.

- Step 1.** Press the **[Display]** key to display the Display menu.
- Step 2.** Press the **OFFSET** key. The Parameter Setting field in the upper left area of the screen indicates the offset value currently in effect (the offset value defaults to zero in the preset state).
- Step 3.** Use the keys or rotary knob of the ENTRY block in one of the following ways to specify the offset value.
 - Enter the desired value with the numeric keys (**[0]** to **[9]** and **[.]**) and then press one of the unit keys (**[G/n]**, **[M/ μ]**, **[k/m]**, or **[\times 1]**).
 - Turn the rotary knob (**O**) until the desired value is set.
 - Press the step keys (**[\uparrow]****[\downarrow]**) to set the desired value.

NOTE

Alternatively, when you have the main marker displayed on the trace, you can set the offset to the value at the marker position through the keystroke sequence: **[Marker \rightarrow]** - **MKR \rightarrow** - **OFFSET**.

To disable this feature, enter zero as the offset value.

When the result of subtracting an offset value is displayed by the data trace, the Instrument Status field on the measurement screen indicates “-O.”

If you specify an offset value, the data trace displays the result of subtracting the offset value from the specific type of data that corresponds to the display option you selected in step 9 of “Identifying Differences between Data and Memory Traces through Comparison or Calculation” on page 179.

You cannot set an offset value if your measurement parameter is COMPLEX Z-Y.

Superimposing Multiple Traces

In its preset state, the Agilent 4294A plots a new trace while erasing the measuring points used for the last sweep cycle. If you prefer, you can configure the Agilent 4294A to plot a new trace without erasing any existing traces. This feature is called “trace superimpose.”

- Step 1.** Press the **[Display]** key to display the Display menu.
- Step 2.** Press the **ACCUMULATE on OFF** (or **ACCUMULATE ON off**) key to turn on or off the trace superimpose feature (pressing the key toggles your selection).

Softkey Labels	Description
ACCUMULATE ON off	Indicates that the trace superimpose feature is enabled (enabling this feature causes the 4294A to plot a new trace without erasing any existing traces).
ACCUMULATE on OFF	Indicates that the trace superimpose feature is disabled (disabling this feature erases all existing traces and causes the 4294A to plot a new trace while erasing the measuring points for the last sweep cycle).

Figure 7-21

|Z|-θ frequency characteristics of a crystal resonator (with a signal level of 0.1 to 1 V and ten measuring points)

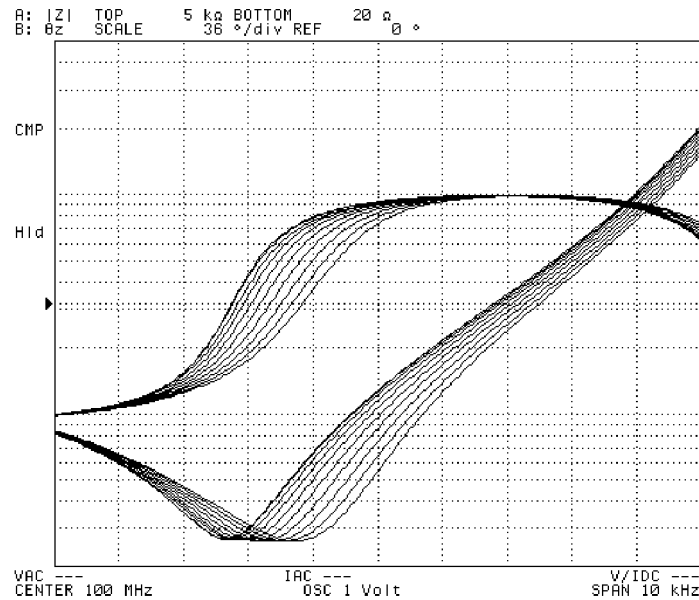

4294aaj040

NOTE

Existing traces superimposed by a new trace do not accept marker or scaling operations. Changing the scale settings does not affect the existing traces: they remain in their previous

Setting Up the Display of Measurement Results

Superimposing Multiple Traces

positions on the screen.

Once you have turned on or off the trace superimpose feature, that setting is applied to both Traces A and B.

Comparing traces using the list sweep function

The list sweep in the Agilent 4294A sweeps multiple frequency sweep ranges (segments) under different conditions at one time. In the list sweep, by specifying the same sweep range for each segment to be set and setting the horizontal axis of the graph to a single span (common frequency axis), you can compare the measurement results under different measurement conditions specified for each segment (oscillator level, dc bias level, and so on) on the screen. For the list sweep, you can specify the pen number used to draw the trace for each segment in order to color-code traces for easy comparison.

Step 1. Follow the procedures described in “Preparing list sweep table” on page 118 to create the list sweep table, specifying each trace you want to compare as one segment. For this operation, you should:

- Specify the same sweep range for all segments.
- Specify the same values for all parameters except for the parameter you want to vary for comparison.
- Assign a different pen number to each segment to vary the colors of the traces.

Figure 7-22

Example of creating a list sweep table to compare traces

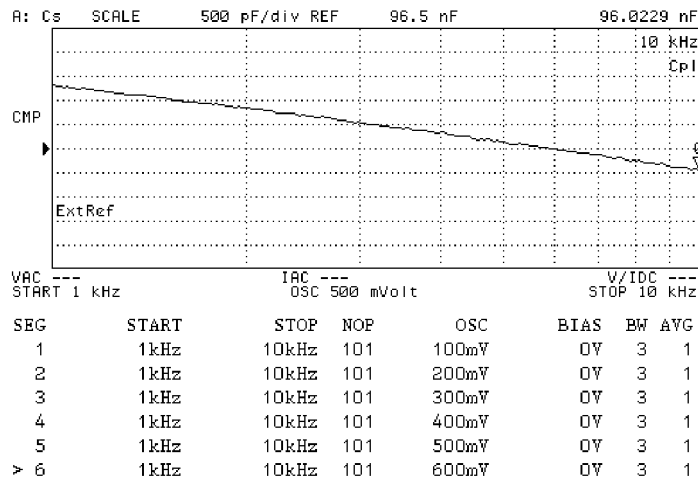

4294a0j116

Step 2. Follow the procedures described in “Selecting the list sweep as the sweep type” on page 124 to set the sweep type to the list sweep.

Step 3. Follow the procedures described in “Setting the Horizontal Axis of the Graph for the List Sweep” on page 124 to set the horizontal axis of the graph. To compare traces using the list sweep, set the horizontal axis of the graph to the single span (common frequency axis).

Figure 7-23

Comparing traces using list sweep function (single span mode)

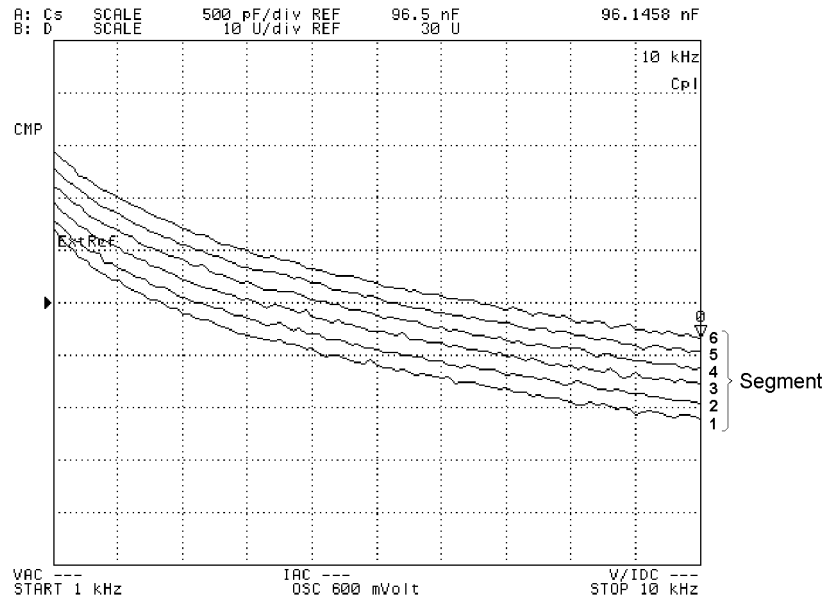

4294aoj117

7. Setting Up the Display of Measurement Results

Figure 7-24

Displaying Figure 7-23 in segment span mode (reference)

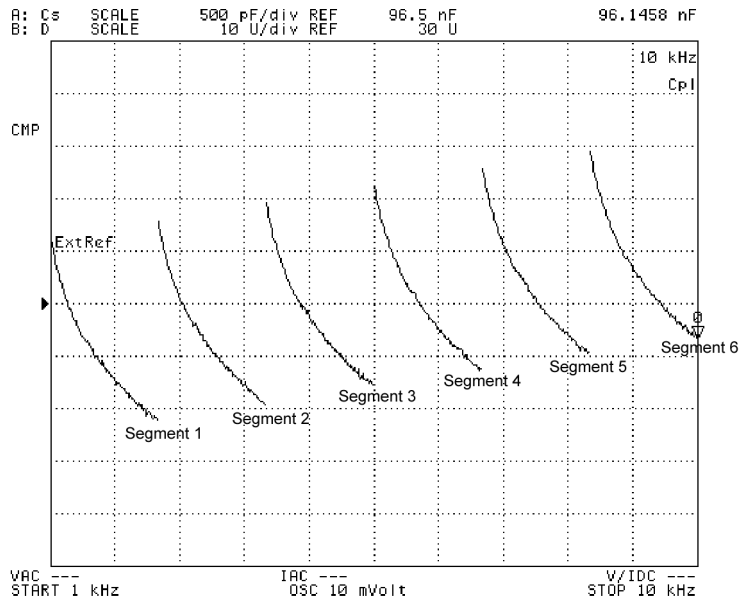

4294aoj118

NOTE

For all traces drawn by the list sweep function, you can read their values by using the marker. Also, by specifying a certain segment as the partial search range, you can execute

Setting Up the Display of Measurement Results

Superimposing Multiple Traces

search within the segment (trace) only. For how to specify a partial search range in the list sweep, refer to “When the sweep type is list sweep:” on page 269.

Monitoring the Test Signal Level (AC)

You can set a constant signal level through the keystroke sequence [Source] - LEVEL and also set the signal level for each measuring point within the range of the signal source level sweep by pressing the [Start], [Stop], [Center], and [Span] keys. All these settings are related to the output signal level of the Agilent 4294A's internal oscillator. In most cases, however, the signal level actually applied to a DUT differs from the setting applied to the signal source because some electrical loss occurs between each test terminal and the DUT.

The Agilent 4294A provides a feature that allows you to monitor both the voltage and amperage values of the test signal level actually applied to the DUT, whether you measure the signal source level by voltage or current. This feature is called “test signal level monitor.”

Monitoring the Test Signal Level on a Real-time Basis

For real-time monitoring, the Agilent 4294A provides two fields in the lower area of the LCD: the Test Signal Voltage Level Monitor field (labeled “VAC”) and the Test Signal Current Level Monitor field (labeled “IAC”). These fields are updated each time a measuring point is reached during the sweep cycle.

- Step 1.** Press the **[Display]** key to display the Display menu.
- Step 2.** Press the **OSC MON on OFF** key to turn on the test signal level monitor feature (pressing this key toggles your selection).

Softkey Labels	Description
OSC MON ON off	Indicates that the test signal level monitor feature is enabled.
OSC MON on OFF	Indicates that the test signal level monitor feature is disabled.

- Step 3.** If the sweep cycle is currently in the hold state, specify the number of sweep cycles (see “Specifying Sweep Times and Stopping Sweep” on page 114) and then start testing the DUT by specifying the trigger source (see “Selecting a Method to Start Measurement (Trigger Source)” on page 111). Alternatively, you can use the continuous sweep mode by implementing a free run trigger.

NOTE

The Agilent 4294A does not monitor the test signal level until you start testing the DUT.

Using the test signal level monitor feature in conjunction with a manual sweep allows you to both determine the characteristic value and monitor the test signal level at your desired measuring point. For more information on manual sweep, refer to “Manual Sweep (Measurement at a Specified Point)” on page 100.

Once you have turned on or off the test signal level monitor feature, that setting is applied to both Traces A and B.

Setting Up the Display of Measurement Results

Monitoring the Test Signal Level (AC)

Figure 7-25

Monitoring signal source level (voltage/current) with manual sweep enabled

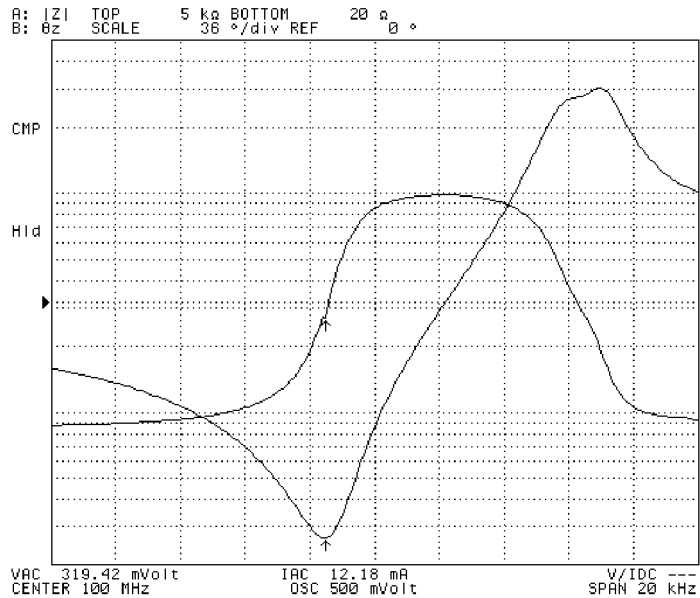

4294aoj041

Using the Marker Feature to Determine the Test Signal Level

You can use the main marker to determine the test signal level at your desired point on the trace. Once you have turned on the test signal level monitor feature, the Agilent 4294A preserves the test signal level value monitored for each measuring point on the trace during the sweep cycle. This allows you to identify the signal level monitored for each measuring point even with the sweep cycle in the hold state.

NOTE

You can place the marker at any measuring point on the trace to determine the signal level monitored at that point, regardless of whether your sweep parameter is frequency, signal source level, or dc bias level.

- Step 1.** Press the **[Display]** key to display the Display menu.
- Step 2.** Press the **OSC MON on OFF** key to turn on the test signal level monitor feature (pressing the key toggles your selection).

Softkey Labels	Description
OSC MON ON off	Indicates that the test signal level monitor feature is enabled.
OSC MON on OFF	Indicates that the test signal level monitor feature is disabled.

- Step 3.** If the sweep cycle is currently in the hold state, specify the number of sweep cycles (see “Specifying Sweep Times and Stopping Sweep” on page 114) and then start testing the DUT by specifying the trigger source (see “Selecting a Method to Start Measurement

(Trigger Source)” on page 111). Alternatively, you can use the continuous sweep mode by implementing a free run trigger.

NOTE

Marker-based level monitoring takes effect when you start a new sweep cycle after turning on the test signal level monitor feature.

- Step 4.** Press the **[Utility]** key to display the Utility menu. The main marker appears on the trace if it is not already displayed.
- Step 5.** Press the **LEVEL MON []** key to display the Level Monitor menu.
- Step 6.** Activate the trace for which you want to monitor the signal level at the marker position. Traces A and B are each associated with a field called “Marker Statistics/Trace Bandwidth Analysis” that is used to display the signal level monitored at the marker position when the corresponding trace is active.

To activate:	Press:
Trace A	[A]
Trace B	[B]

- Step 7.** To set up marker-based level monitoring, press one of the following keys:

To:	Press:
Turn off marker-based level monitoring	OFF
Monitor the test signal voltage level	AC-V
Monitor the test signal current level	AC-I

- Step 8.** Move the main marker to your desired measuring point on the trace. The Marker Statistics/Trace Bandwidth Analysis field for the activate trace indicates the test signal level monitored at the marker position.

NOTE

Marker-based monitoring works using the same mechanism as, but provides level values in higher resolution (more digits) than, real-time monitoring (described in “Monitoring the Test Signal Level on a Real-time Basis” on page 189).

Although marker-based level monitoring uses separate display fields for Traces A and B, it does not depend on the active trace, and provides the same level value regardless of which trace is currently active. You can use Trace A’s display field to monitor the test signal voltage level while using Trace B’s display field to monitor the test signal current level. Also, you can use the display field for Trace A or B to monitor either the dc voltage bias level or the marker-based dc current bias level, but not both. For more information on marker-based dc bias level monitoring, refer to “Monitoring the dc Bias Level” on page 193.

The Marker Statistics/Trace Bandwidth Analysis field for each trace is used to display one of three types of information: (1) the level value monitored at the marker position, (2) the marker statistics, and (3) the results of trace bandwidth analysis; the parenthesized numbers denote the precedence among these information types when more than one of them are enabled at the same time.

Setting Up the Display of Measurement Results
Monitoring the Test Signal Level (AC)

Figure 7-26

Using the marker-based monitoring feature to simultaneously display voltage and current levels

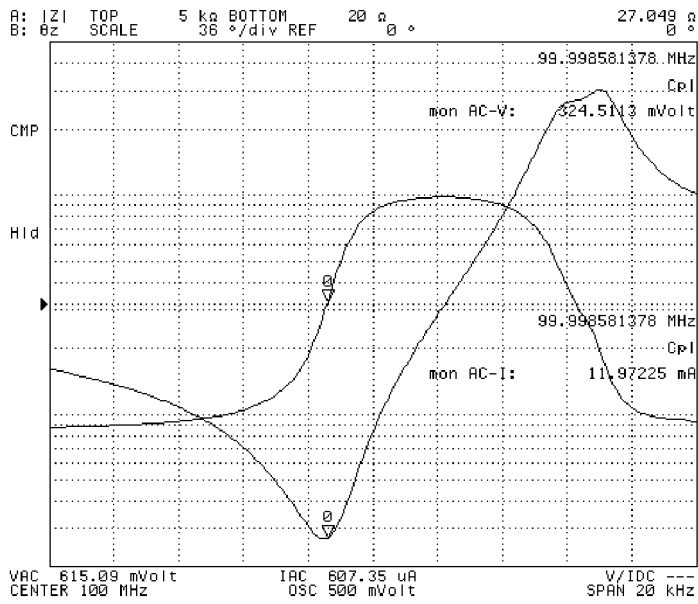

4294aoj042

Monitoring the dc Bias Level

You can set a constant dc bias level through the keystroke sequence **[Source] - BIAS MENU - VOLTAGE LEVEL** or **CURRENT LEVEL** and also set the dc bias level for each measuring point within the range of the dc bias level sweep by pressing the **[Start]**, **[Stop]**, **[Center]**, and **[Span]** keys. All these settings are related to the output level of the Agilent 4294A's internal dc bias power source. In most cases, however, the dc bias level actually applied to a DUT differs from the setting applied to the dc bias source because some electrical loss occurs between each test terminal and the DUT.

The Agilent 4294A provides a feature that allows you to monitor either the voltage or amperage value of the dc bias actually applied to the DUT. This feature is called the “dc bias level monitor.”

Monitoring the dc Bias Level on a Real-time Basis

You can monitor the dc bias level (either voltage or amperage) on a real-time basis through the dc Voltage/Current Bias Monitor field, which is located in the lower part of the LCD and labeled “V/IDC,” “VDC,” or “IDC.” This field is updated each time a measuring point is reached during the dc bias sweep.

NOTE

If your sweep parameter is the frequency or signal source level rather than the dc bias level, the dc Voltage/Current Bias Monitor field only indicates the monitored dc bias level (voltage or amperage) for the first measuring point. In this case, therefore, the field is updated each time a new sweep cycle is started.

- Step 1.** Start applying dc bias. For more information, refer to “Setting and Applying dc Bias” on page 107.
- Step 2.** Press the **[Display]** key to display the Display menu.
- Step 3.** Press the **BIAS MON []** key to display the Bias Monitor menu.
- Step 4.** To set up dc bias level monitoring, press one of the following keys:

To:	Press:
Turn off dc bias level monitoring	OFF
Monitor the dc bias voltage level	VOLT
Monitor the dc bias current level	CURRENT

NOTE

Using the test dc bias level monitor feature in conjunction with manual sweep allows you to both determine the characteristic value and monitor the dc bias level at your desired measuring point. In manual sweep mode, you can monitor on a real-time basis the dc bias level at any measuring point on the trace, whether or not your sweep parameter is the dc bias level, because the Agilent 4294A finishes a sweep cycle when the specified measuring point is reached. For more information on manual sweep, refer to “Manual Sweep (Measurement at a Specified Point)” on page 100.

Once you have turned on or off the dc bias level feature, that setting is applied to both

Setting Up the Display of Measurement Results

Monitoring the dc Bias Level

Traces A and B.

Figure 7-27 Monitoring dc bias level with manual sweep enabled

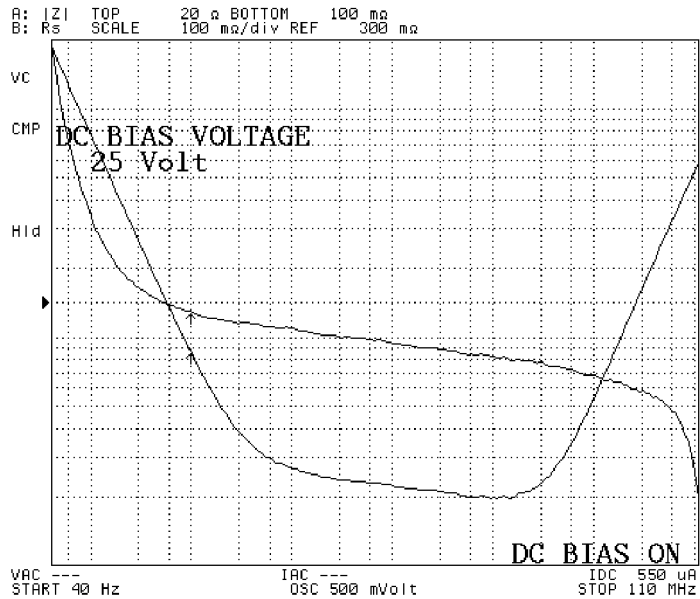

4294aoj043

Using the Marker Feature to Determine the dc Bias Level

During the dc bias sweep, you can use the main marker to determine the dc bias level (voltage or amperage) at your desired point on the trace. Once you have turned on the dc bias level monitor feature, the Agilent 4294A preserves the dc bias level monitored for each measuring point on the trace during the sweep cycle. This allows you to identify the dc bias level monitored for each measuring point even with the sweep cycle in the hold state.

NOTE

If your sweep parameter is frequency or signal source level rather than dc bias level, the dc bias level monitored at the first measuring point continues to be displayed in the dc Voltage/Current Bias Monitor field for all subsequent measuring points because this level remains constant throughout a non-bias sweep cycle.

- Step 1.** Start applying dc bias. For more information, refer to “Setting and Applying dc Bias” on page 107.
- Step 2.** Press the **[Display]** key to display the Display menu.
- Step 3.** Press the **BIAS MON []** key to display the Bias Monitor menu.
- Step 4.** To set up dc bias level monitoring, press one of the following keys:

To:	Press:
Turn off dc bias level monitoring	OFF

To:	Press:
Monitor the dc bias voltage level	VOLT
Monitor the dc bias current level	CURRENT

Step 5. If the sweep cycle is currently in the hold state, specify the number of sweep cycles (see “Specifying Sweep Times and Stopping Sweep” on page 114) and then start testing the DUT by specifying the trigger source (see “Selecting a Method to Start Measurement (Trigger Source)” on page 111). Alternatively, you can use the continuous sweep mode by implementing a free run trigger.

NOTE

Marker-based level monitoring takes effect when you start a new sweep cycle after turning on the dc bias level monitor feature.

Step 6. Press the **[Utility]** key to display the Utility menu. The main marker appears on the trace if it is not already displayed.

Step 7. Press the **LEVEL MON []** key to display the Level Monitor menu.

Step 8. Traces A and B are each associated with a field called “Marker Statistics/Trace Bandwidth Analysis” that is used to display the dc bias level monitored at the marker position when the corresponding trace is active. To activate Trace A or B, press the appropriate key:

To activate:	Press:
Trace A	[A]
Trace B	[B]

Step 9. To set up marker-based level monitoring, press one of the following keys:

To:	Press:
Turn off marker-based level monitoring	OFF
Monitor the dc bias voltage level	DC-V
Monitor the dc bias current level	DC-I

NOTE

The setting you select for marker-based monitoring must match the setting for dc bias level monitoring (step 4).

Step 10. Move the main marker to your desired measuring point on the trace. The Marker Statistics/Trace Bandwidth Analysis field for the activate trace indicates the test signal level monitored at the marker position.

NOTE

Marker-based monitoring works using the same mechanism as, but provides level values in higher resolution (more digits) than, real-time monitoring (described in “Monitoring the dc Bias Level on a Real-time Basis” on page 193).

Although marker-based level monitoring uses separate display fields for Traces A and B, it does not depend on the active trace and provides the same level value regardless of which

Setting Up the Display of Measurement Results

Monitoring the dc Bias Level

trace is currently active.

Traces A and B are each associated with a field called “Marker Statistics/Trace Bandwidth Analysis.” Each of these fields can be used to display one of three types of marker-based monitoring information: the test signal voltage level, the test signal current level, and the dc bias level (voltage or current). For more information on marker-based monitoring of the test signal level, refer to “Monitoring the Test Signal Level (AC)” on page 189.

The Marker Statistics/Trace Bandwidth Analysis field for each trace is used to display one of three types of information: (1) the level value monitored at the marker position, (2) the marker statistics, and (3) the results of trace bandwidth analysis; the parenthesized numbers denote the precedence among these information types when more than one of them are enabled at the same time.

Figure 7-28

Using marker feature to determine dc bias current and test signal voltage levels

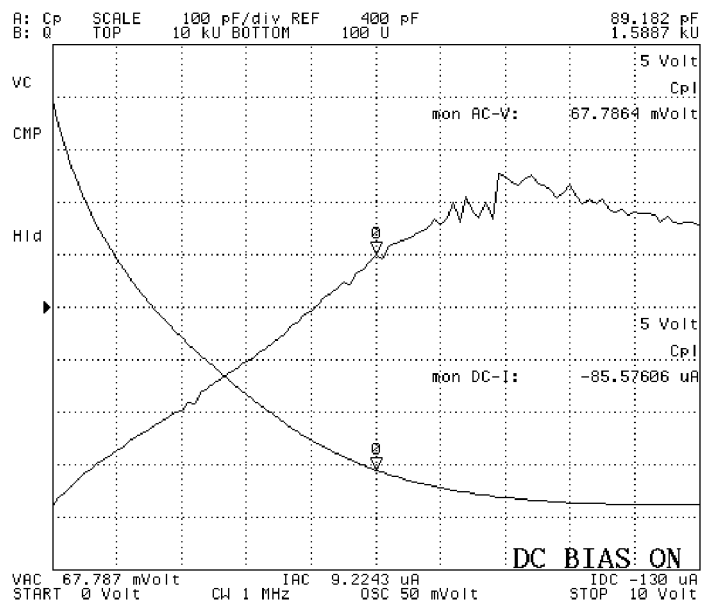

4294aoj044

Selecting the Phase Unit

When you are performing phase-based measurement, you can specify whether to use degrees or radian as the phase unit applied to the scaling and marker features.

Step 1. Activate the trace for which you want to set the phase unit.

To activate:	Press:
Trace A	[A]
Trace B	[B]

NOTE

To set the phase unit, your parameter must be either $|Z|-\theta$ / $|Y|-\theta$ or COMPLEX Z-Y. You should activate Trace B in the former case, and the trace whose axis format is polar in the latter case.

Step 2. Press the **[Format]** key to display the Format menu.

Step 3. Press the **PHASE UNIT []** key to select your desired phase unit (pressing the key toggles your selection).

Softkey Labels	Phase unit
PHASE UNIT [DEG]	Degrees (°)
PHASE UNIT [RAD]	Radian

Displaying Phase Values without Wrapping at $\pm 180^\circ$

The Agilent 4294A provides a feature that allows you to display phase values without wrapping them at $+180^\circ$ or -180° . This feature, called “expanded phase,” is useful when measured phase values are in a continuous increase or decrease and some of them exceed $+180^\circ$ or -180° . To set up the expanded phase feature, follow these steps:

Step 1. Activate the trace for which you want to use the expanded phase feature.

To activate:	Press:
Trace A	[A]
Trace B	[B]

NOTE

To expand the phase, your parameter must be either $|Z|-\theta / |Y|-\theta$ or COMPLEX Z-Y. You should activate Trace B in the former case, and the trace whose axis format is polar in the latter case.

Step 2. Press the **[Format]** key to display the Format menu.

Step 3. Press the **EXP PHASE on OFF** (or **EXP PHASE ON off**) key to turn on or off the expanded phase feature (pressing the key toggles your selection).

Softkey Labels	Description
EXP PHASE ON off	Indicates that the expanded phase feature is enabled.
EXP PHASE on OFF	Indicates that the expanded phase feature is disabled.

Hiding the Non-active Trace

When the screen is not split into upper and lower halves (see “Splitting the Graph” on page 200), Traces A and B appear on the same graph and may overlap each other, making it difficult to examine the DUT’s characteristics. In this case, you can optionally hide the non-active trace.

- Step 1.** Press the **[Display]** key to display the Display menu.
- Step 2.** Press the **HIDE INACT on OFF** (or **HIDE INACT ON off**) key to hide or show the non-active trace (pressing the key toggles your selection).

Softkey Labels	Description
HIDE INACT ON off	Indicates that the non-active trace is hidden.
HIDE INACT on OFF	Indicates that the non-active trace is shown along with the active trace.

NOTE

Once you have specified whether to hide or show the non-active trace, that setting is applied to both Traces A and B. You can specify this setting without activating one of the traces or checking the current state.

When the screen is split into upper and lower halves (see “Splitting the Graph” on page 200), you cannot hide the non-active trace.

Splitting the Graph

You can split the display into upper and lower halves so that Traces A and B are each displayed on a separate graph. To split the display, follow these steps:

- Step 1.** Press the **[Display]** key to display the first page of the Display menu.
- Step 2.** Press the **SPLIT on OFF** (or **SPLIT ON off**) key to turn on or off the split display feature (pressing the key toggles your selection).

Softkey Labels	Description
SPLIT ON off	Indicates that the split display feature is enabled.
SPLIT on OFF	Indicates that the split display feature is disabled.

Figure 7-29 Traces A and B with split display disabled

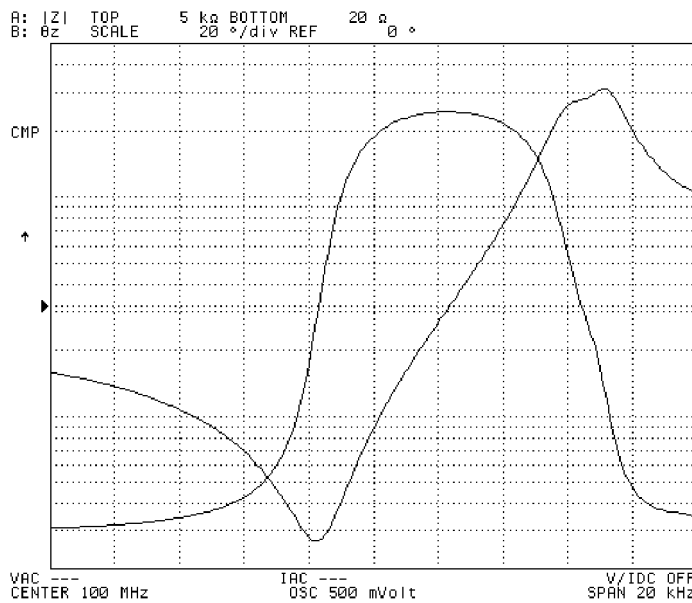

4294aaj045

Figure 7-30 Traces A and B with split display enabled

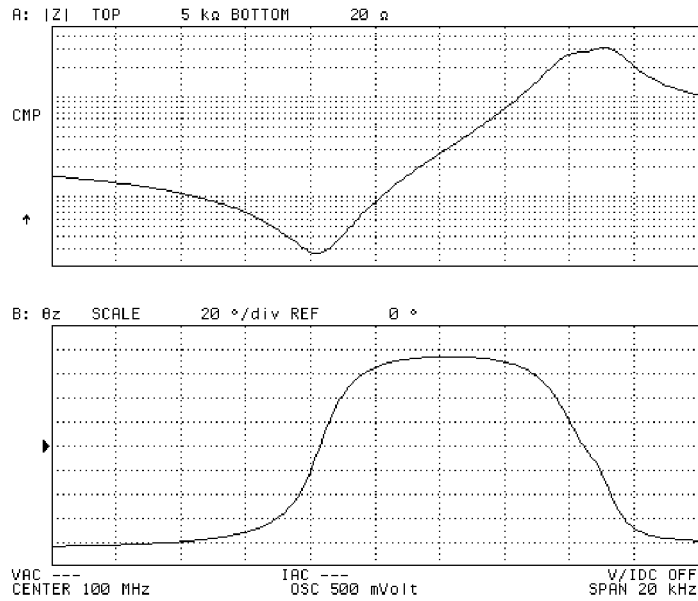

4294aoj046

NOTE

Before you can turn on or off the split display feature, you must configure the screen assignments for HP Instrument BASIC by pressing the **ALL INSTRUMENT** or **BASIC STATUS** key. For more information, refer to “Configuring the Screen Assignments for HP Instrument BASIC” on page 202.

Once you have turned on or off the split display feature, that setting is applied to both Traces A and B. You can specify this setting without activating one of the traces or checking the current state.

Configuring the Screen Assignments for HP Instrument BASIC

The Agilent 4294A can function as both an analyzer and an HP Instrument BASIC controller. You can specify which area of the screen should display the information related to HP Instrument BASIC (such as program and file lists or status data). To do this, follow these steps:

- Step 1.** Press the **[Display]** key to display the first page of the Display menu.
- Step 2.** Press the **more 1/2** key to move to the second page of the Display menu.
- Step 3.** Press the **ALLOCATION** key to display the Screen Assignment menu.
- Step 4.** Specify the screen assignments for HP Instrument BASIC related information by pressing the appropriate key:

To:	Press:
Use the entire screen for analyzer functionality (hiding all HP Instrument BASIC related information)	ALL INSTRUMENT
Use the upper half of the screen for analyzer functionality and the lower half for HP Instrument BASIC	HALF INSTR HALF BASIC
Use the entire screen for HP Instrument BASIC	ALL BASIC
Display three status lines for HP Instrument BASIC beneath the analyzer screen.	BASIC STATUS

NOTE

Initializing the Agilent 4294A to its preset state (**[Preset]** key) does not affect the screen assignments for HP Instrument BASIC.

Figure 7-31

Entire screen assigned to analyzer functions

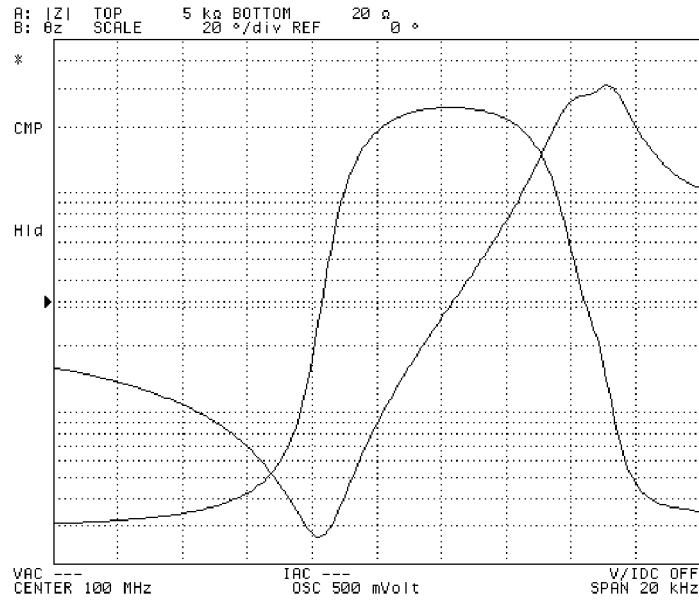

4294aoj047

Figure 7-32

Upper half assigned to analyzer functionality and lower half to HP Instrument BASIC

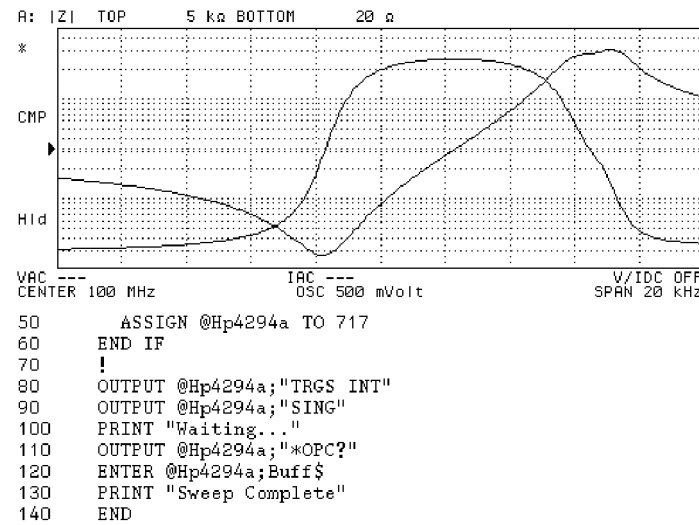

4294aoj048

Setting Up the Display of Measurement Results Configuring the Screen Assignments for HP Instrument BASIC

Figure 7-33 Entire screen assigned to HP Instrument BASIC

```
10 DIM Buff$(9)
20 IF SYSTEM$("SYSTEM ID")="HP4294A" THEN
30   ASSIGN @Hp4294a TO 800
40 ELSE
50   ASSIGN @Hp4294a TO 717
60 END IF
70 !
80 OUTPUT @Hp4294a;"TRGS INT"
90 OUTPUT @Hp4294a;"SING"
100 PRINT "Waiting..."
110 OUTPUT @Hp4294a;"*OPC?"
120 ENTER @Hp4294a;Buff$
130 PRINT "Sweep Complete"
140 END
```

4294aaj049

Figure 7-34 Three status lines displayed for HP Instrument BASIC

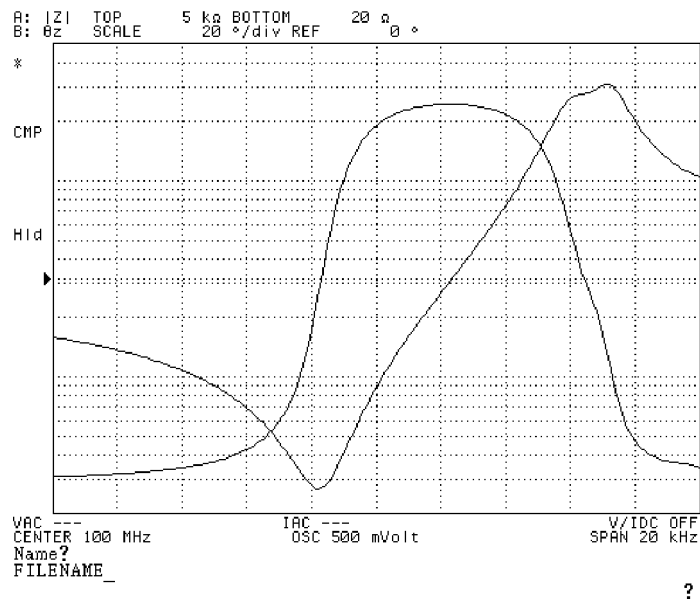

4294aaj050

Adding a Title to the Measurement Screen

The measurement screen provides two title fields, each corresponding to Trace A or B. You can add descriptive text to these fields, and your entered titles are displayed in the same color as the corresponding trace. To add titles to the screen, follow these steps:

Step 1. Activate the trace for which you want to add a title.

To activate:	Press:
Trace A	[A]
Trace B	[B]

Step 2. Press the **[Display]** key to display the first page of the Display menu.

Step 3. Press the **more 1/2** key to move to the second page of the Display menu.

Step 4. Press the **TITLE** key to display the Title menu.

Step 5. Enter your title into the text entry line using the following keys in any combination. If the trace has an existing title, you can edit that title in the text entry line.

Use:	To:
Step keys ([↑][↓])	Scroll up or down the list of available characters displayed below the text entry line.
Rotary knob (○)	Move the cursor (↑) to the previous or next character in the character list.
SELECT LETTER or [G/n]	Copy the selected character from the character list to the cursor () position in the text entry line.
Numeric keys ([0] to [9], [.] and [-])	Enter a value at the cursor () position in the text entry line
SPACE	Insert a space at the cursor () position in the text entry line
BACK SPACE or [Back Space]	Delete the character to the left of cursor () in the text entry line and move the cursor back one space
CLEAR TITLE	Delete all characters from the text entry line

Step 6. When you have finished entering a new title into the text entry line, press **done** or [**×1**] to save the new title. The new title appears in the title field in the upper left area of the screen. Before you save a new title, you can cancel your entry by pressing the **cancel** key.

Setting Up the Display of Measurement Results
Adding a Title to the Measurement Screen

Figure 7-35

Adding a title to measurement screen

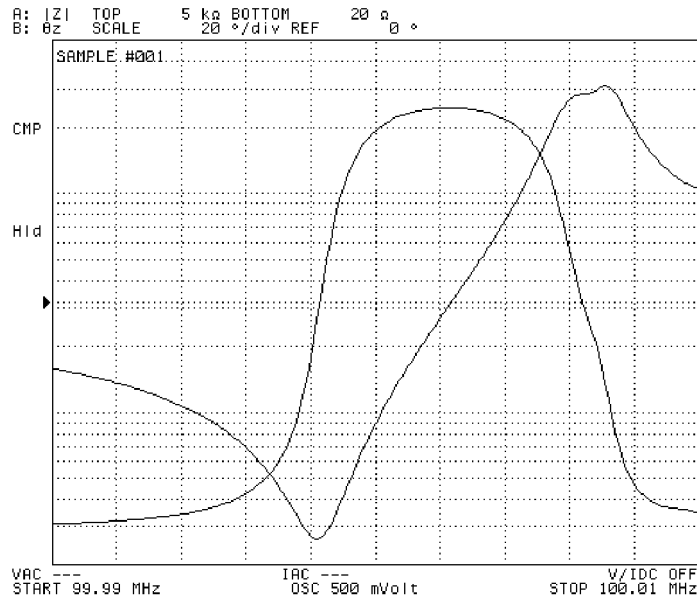

4294aaj051

NOTE

As a more convenient alternative, if your Agilent 4294A is equipped with an external keyboard, you can enter a new title through the keyboard. When you finished entering a new title, just press the **[Enter]** key on the keyboard to save the title.

If you press the **cancel** key to cancel your entry, any existing title remains in the title field.

To delete the existing title from the title field, activate the trace associated with the title and then use the keystroke sequence: **[Display] - more 1/2 - TITLE - CLEAR TITLE - done**.

Customizing Intensity and Color Settings for Screen Display

The Agilent 4294A allows you to customize the intensity and color settings applied to the items displayed on the screen.

NOTE

The settings covered in this section are not affected when you initialize the Agilent 4294A by pressing the **[Preset]** key or turning the power off and back on.

Setting the Foreground Intensity

To adjust the intensity of the text and graphics displayed on the screen, follow these steps:

- Step 1.** Press the **[Display]** key to display the first page of the Display menu.
- Step 2.** Press the **more 1/2** key (the softkey displayed at the bottom) to move to the second page of the Display menu.
- Step 3.** Press the **MODIFY COLOR** key (the 4th softkey from the top) to display the Modify Color menu.
- Step 4.** Press the **INTENSITY** key (the softkey displayed at the top). The Parameter Setting field in the upper left area of the screen indicates the currently applied foreground intensity factor (%) relative to the maximum intensity (100% means the highest intensity).
- Step 5.** Use the keys or rotary knob of the ENTRY block in one of the following ways to specify the foreground intensity factor (%) relative to the maximum intensity.
 - Enter the desired value with the numeric keys (**[0]** to **[9]**) and then press the **[×1]** key.
 - Turn the rotary knob (**○**) until the desired value is set.
 - Press the step keys (**[↑]**/**[↓]**) to set the desired value.

NOTE

The foreground intensity affects the readability of softkey labels, thus the operability of the Agilent 4294A. Take care not to set the foreground intensity to an excessively low value.

The factory default setting of the foreground intensity is 100%.

Adjusting the Background Intensity

To adjust the intensity of the screen's background, follow these steps:

- Step 1.** Press the **[Display]** key to display the first page of the Display menu.
- Step 2.** Press the **more 1/2** key (the softkey displayed at the bottom) to move to the second page of the Display menu.
- Step 3.** Press the **MODIFY COLOR** key (the 4th softkey from the top) to display the Modify Color menu.
- Step 4.** Press the **BACKGROUND INTENSITY** key (the second softkey displayed from the top). The Parameter Setting field in the upper left area of the screen indicates the currently applied background intensity factor (%) relative to the white level (100% means the highest intensity).

Setting Up the Display of Measurement Results

Customizing Intensity and Color Settings for Screen Display

- Step 5.** Use the keys or rotary knob of the ENTRY block in one of the following ways to specify the background intensity factor (%) relative to the maximum intensity.
- Enter the desired value with the numeric keys ([0] to [9]) and then press the [×1] key.
 - Turn the rotary knob (○) until the desired value is set.
 - Press the step keys ([↑][↓]) to set the desired value.

NOTE

The background intensity affects the readability of softkey labels, thus the operability of the Agilent 4294A. Take care not to set the background intensity to an excessively high value.

The factory default setting of the background intensity is 0%.

Customizing the Color of Each Screen Item

You can customize the display color of each screen item (textual or graphical element).

- Step 1.** Press the **[Display]** key to display the first page of the Display menu.
- Step 2.** Press the **more 1/2** key to move to the second page of the Display menu.
- Step 3.** Press the **MODIFY COLOR** key to display the Modify Color menu.
- Step 4.** Press the **MODIFY ITEM COLOR** key to display the first page of the Modify Item Color menu.
- Step 5.** Select the item(s) you want to customize by pressing the appropriate key:

To customize:	Press:
Data trace and scale setting/reference line for Trace A	TRC A DATA
Memory trace, scale setting/reference line, and limit line for Trace A	TRC A MEM LIMIT LINE
Data trace and scale setting/reference line for Trace B	TRC B DATA
Memory trace, scale setting/reference line, and limit line for Trace B	TRC B MEM LIMIT LINE
Graph grid lines	GRATICLULE
Warning messages	more 1/3 - WARNING
Textual items not contained in a graph such as an equivalent circuit diagram or a list sweep table as well as softkey labels and markers (Δ, ∇)	more 1/3 - TEXT MARKER
Text displayed in the HP Instrument BASIC area	more 1/3 - IBASIC
Pen 1 (#1 of the graphic drawing pen set ¹)	more 1/3 - PEN 1

To customize:	Press:
Pen 2 (#2 of the graphic drawing pen set ¹)	more 1/3 - PEN 2
Pen 3 (#3 of the graphic drawing pen set ¹)	more 1/3 - more 2/3 - PEN 3
Pen 4 (#4 of the graphic drawing pen set ¹)	more 1/3 - more 2/3 - PEN 4
Pen 5 (#5 of the graphic drawing pen set ¹)	more 1/3 - more 2/3 - PEN 5
Pen 6 (#6 of the graphic drawing pen set ¹)	more 1/3 - more 2/3 - PEN 6

1. Graphic drawing pens specified in an HP Instrument BASIC program or trace plotting pens specified for each segment of a list sweep cycle

- Step 6.** Press the **MODIFY COLOR** to display the Item Color menu.
- Step 7.** Press the **TINT** key. The Parameter Setting field in the upper left area of the screen indicates the currently applied hue as an integer between 0 and 100. This number is an index to a particular point on a hue ring that defines color transitions from red to blue to black and finally back to red. If the current hue is pure red, it is represented as zero.
- Step 8.** Use the keys or rotary knob of the ENTRY block in one of the following ways to specify the hue as an integer between 0 and 100.
- Enter the desired value with the numeric keys (**[0]** to **[9]**) and then press the **[×1]** key.
 - Turn the rotary knob (**○**) until the desired value is set.
 - Press the step keys (**[↑]**/**[↓]**) to set the desired value.
- Step 9.** Press the **BRIGHTNESS** key. The Parameter Setting field in the upper left area of the screen indicates the currently applied brightness factor (%) relative to the maximum brightness. (100% means the highest brightness.)
- Step 10.** Use the keys or rotary knob of the ENTRY block in one of the following ways to specify the brightness factor (%) relative to the maximum brightness.
- Enter the desired value with the numeric keys (**[0]** to **[9]**) and then press the **[×1]** key.
 - Turn the rotary knob (**○**) until the desired value is set.
 - Press the step keys (**[↑]**/**[↓]**) to set the desired value.
- Step 11.** Press the **COLOR** key. The Parameter Setting field in the upper left part of the screen indicates the currently applied saturation (whiteness) factor (%) relative to the pure color. (0% means white, and 100% means pure color.)

NOTE

If you set the saturation to 0%, the color becomes white and is not affected by any changes to the hue.

- Step 12.** Use the keys or rotary knob of the ENTRY block in one of the following ways to specify

Setting Up the Display of Measurement Results

Customizing Intensity and Color Settings for Screen Display

the saturation factor (%) relative to the pure color.

- Enter the desired value with the numeric keys ([0] to [9]) and then press the [×1] key.
- Turn the rotary knob (○) until the desired value is set.
- Press the step keys ([↑][↓]) to set the desired value.

NOTE

To reset the color of an item to the factory default setting, display the Item Color menu for that item and then press the **RESET COLOR** key.

The factory setting (the setting when the RESET COLOR key is pressed) of the graphic drawing pens is: pen 1: white, pen 2: red, pen 3: yellow, pen 4: green, pen 5: cyan, and pen 6: blue.

The brightness of the softkey labels affects their readability, thus the Agilent 4294A's operability. Take care not to set the softkey labels to an excessively low brightness.

Resetting All Items to Factory Default Colors

You cannot reset the colors of text and graphics by simply pressing the **[Preset]** key or turning the power off and back on. To reset all screen items to the factory default colors, follow these steps:

- Step 1.** Press the **[Display]** key to display the first page of the Display menu.
- Step 2.** Press the **more 1/2** key (the softkey displayed at the bottom) to move to the second page of the Display menu.
- Step 3.** Press the **MODIFY COLOR** key (the 4th softkey from the top) to display the Modify Color menu.
- Step 4.** Press the **DEFAULT COLORS** key (the 3rd softkey from the bottom) to reset all screen items to their factory default colors.

NOTE

Pressing the **DEFAULT COLORS** key does not reset the foreground and background intensity factors to the factory default settings. To reset the foreground and background intensity factors to the factory default settings, you must manually enter the default values (100% and 0%, respectively) by following the procedures described in “Setting the Foreground Intensity” on page 207 and “Adjusting the Background Intensity” on page 207.

8

Analysis and Processing of Result

This chapter describes how to analyze the result of measurements by the Agilent 4294A Precision Impedance Analyzer and how to process the output result to the printer.

Specify the sweep parameter value and read the value on the trace

The value at each point of the trace can be read using the marker 0, which is called the “main marker.” Setting the sweep parameter value allows the main marker position to be moved as desired.

Step 1. Activate the trace that you want to read.

Active trace	Key operation
Trace A	[A]
Trace B	[B]

Step 2. Press the **[Marker]** key. If the main marker is not located on the active trace, it appears at the position of the sweep center value on the trace, and the sweep parameter value indicating the current marker position is displayed in the set parameter value field in the upper left area of the screen.

Step 3. Use the keys or rotary knob of the ENTRY block in one of the following ways to specify a new marker position for the sweep parameter value.

- Enter the desired value with the numeric keys (**[0]** to **[9]**, **[.]** and **[-]**) and then press one of the unit keys (**[G/n]**, **[M/ μ]**, **[k/m]**, or **[\times 1]**).
- Turn the rotary knob (**(O)**) until the desired value is set.
- Press the step keys (**[\uparrow]**/**[\downarrow]**) to set the desired value.

Figure 8-1 Values read on the trace by the main marker

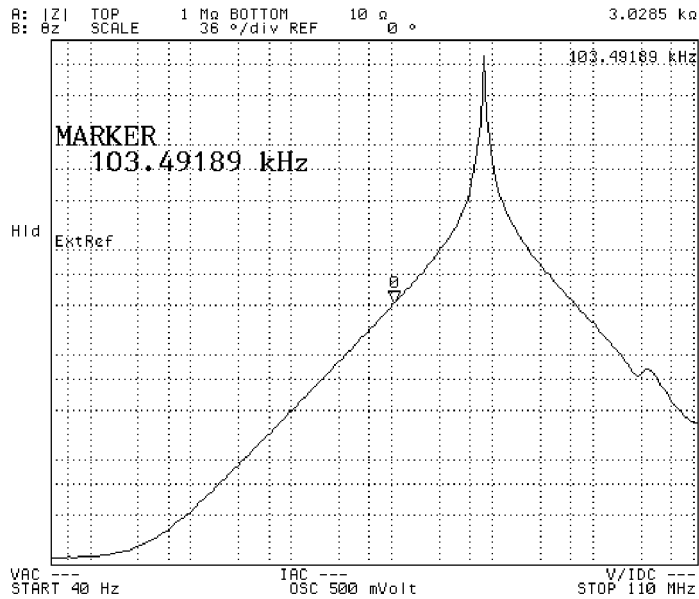

4294aoj053

NOTE

When the marker movement is in non-complementary mode (when the softkey label displayed by pressing the **[Marker]** key indicates **MKR [DISCRETE]**), the marker can move only the actual measuring point on the trace. If you enter the sweep parameter value with the numeric keys to move the marker but the input value does not correspond to the actual measuring point, then the marker will go to the measuring point closest to that input value.

When the marker movement is in complementary mode (when the softkey label displayed by pressing the **[Marker]** key indicates **MKR [CONT]**), automatic compensation is provided between the measuring points. This allows the marker to be moved between the measuring points. When the numeric keys are used to enter the sweep parameter value, the marker can be moved to any desired position on the trace.

For how to set the maker interpolation/non-interpolation mode, refer to “Reading actual measurement points only/reading interpolated values between measurement points” on page 222.

Listing data at several points on the trace

When the main marker (marker numbered 0) is used, data on the trace (sweep parameter value and measured value) are always displayed in the Marker Sweep Parameter Value and Marker Measurement Parameter Value fields in the right area of the screen. To display data at several points on the trace at one time, use the sub-markers (markers numbered 1 to 7) and the marker list function.

Displaying several marker positions using softkey labels

When you turn on the sub-marker, the softkey label of the sub-marker in the Sub-Marker Setting menu changes to the sweep parameter value and measurement parameter value at that point.

Step 1. Activate the trace that you want to read (to which the setting is applied).

Active trace	Key operation
Trace A	[A]
Trace B	[B]

Step 2. Use the softkeys displayed by pressing the **[Marker]** key or the **[Search]** key, the keys in the **ENTRY** block, and so on, to move the main marker to one of the points on the trace whose data you want to read.

Step 3. Press the **[Marker]** key to display the Marker menu.

Step 4. Press the **SUB MKR** key to display the Sub-Marker Setting menu.

Step 5. Select one of the following sub-markers to place it at the current main marker position.

Type of sub-marker	Key operation
Sub-marker 1 (marker number 1)	1 OFF
Sub-marker 2 (marker number 2)	2 OFF
Sub-marker 3 (marker number 3)	3 OFF
Sub-marker 4 (marker number 4)	4 OFF
Sub-marker 5 (marker number 5)	5 OFF
Sub-marker 6 (marker number 6)	6 OFF
Sub-marker 7 (marker number 7)	7 OFF

When you press the softkey, the sub-marker appears at the current main marker position, and the display of the softkey labels change from OFF to the sweep parameter value and measurement parameter value, which indicate the position of the sub-marker.

Step 6. Repeat Step 2 through Step 5 to place sub-markers at several points on the trace.

Figure 8-2 Displaying the marker positions using the softkey labels of the sub-markers

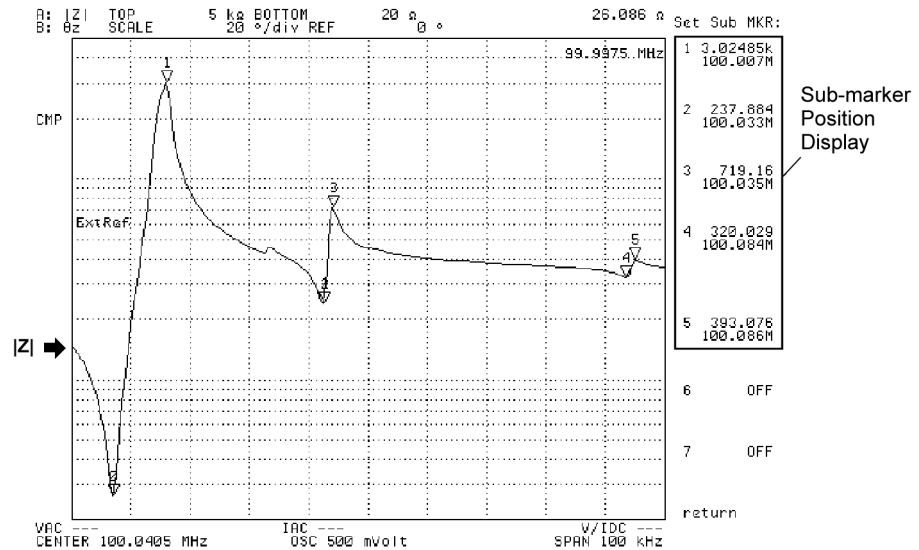

4294aoj108

Listing the marker positions with the marker list function

The marker position display provided by the softkey labels in the Sub-Marker Setting menu may not be usable if you want to show the display at all times because the softkey display changes depending on the keys you operate. In this case, you can use the marker list function.

After performing the steps in “Displaying several marker positions using softkey labels” on page 214, follow these steps:

- Step 1.** Press the **[Utility]** key to display the Utility menu.
- Step 2.** Press the **MKR LIST** on **OFF** key to turn on the marker list function. When the marker list function is turned on, the measured graph is displayed in the upper half of the screen and the positions of all the markers on the trace are listed in the lower half of the screen.

Softkey label	State of marker list function
MKR LIST ON off	On (the positions of the markers on the trace are listed in the lower half of the screen)
MKR LIST on OFF	Off

Figure 8-3

Listing marker positions with the marker list function

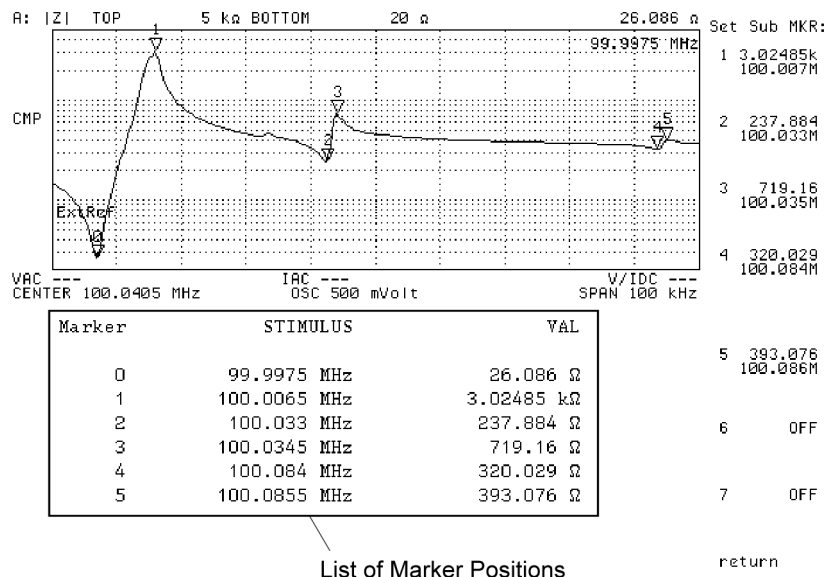

4294aoj109

NOTE

If “Use the upper and lower halves of the screen for analyzer functionality and HP Instrument BASIC, respectively” has been selected as the setting of the assignment of the HP Instrument BASIC screen, turning on the marker list function does not display the measured graph but instead the marker list in the upper half of the screen and the HP Instrument BASIC screen in the lower half of the screen. For how to set the assignment of the HP Instrument BASIC screen, refer to “Configuring the Screen Assignments for HP Instrument BASIC” on page 202.

When the marker list function is on, you cannot turn on/off the split display of the measured graph. For more information on splitting the display of the measured graph, refer to “Splitting the Graph” on page 200.

When the marker list function is on, if you turn off all markers by following the procedure of “Turning off all (main/sub/delta) markers at one time” on page 248, the marker list function is also turned off automatically.

Reading the difference from the reference point on the screen (delta marker)

By placing the marker used as the reference at any point on the screen, you can set and display the positions (sweep parameter value and measurement parameter value) of the markers (main marker and sub-marker) based on relative values (differences) from the reference point. This marker used as the reference is called the delta marker. You can determine whether it will be placed on the trace (delta-marker-on-the-trace mode) or at any point on the screen (fixed delta marker mode).

There are two ways to place (move) the delta marker at a reference point on the screen: using the main marker or using the delta marker alone.

Placing the delta marker on the reference point with the main marker

Follow these steps to first move the main marker to a reference point and then place the delta marker at that point.

Step 1. Activate the trace that you want to analyze.

Active trace	Key operation
Trace A	[A]
Trace B	[B]

Step 2. Using an appropriate function, such as the search function, move the main marker to the point on the trace that you want to specify as the reference. For how to move the main marker, refer to related topics including:

- “Specify the sweep parameter value and read the value on the trace” on page 212
- “Search the maximum/minimum measurements” on page 223
- “Search the point of target measurement” on page 225
- “Search the maximum/minimum peak” on page 228

Step 3. Press the **[Marker]** key to display the Marker menu.

Step 4. Press the **ΔMODE MENU** key to display the Delta Marker menu.

Step 5. Select the delta-marker-on-the-trace mode or the fixed delta marker mode.

Delta marker mode	Key operation
Delta-marker-on-the-trace mode (when the trace changes, the delta marker moves along with it; you set its position with the sweep parameter value only)	Δ MKR

Delta marker mode	Key operation
Fixed delta marker mode (even if the trace changes, the delta marker is always fixed to a certain point on the graph; you set its position with both the sweep parameter value and measurement parameter value)	FIXED ΔMKR

When you select the delta marker mode, the delta marker (Δ) appears at the main marker position on the trace.

NOTE

Even if the fixed delta marker mode is selected, when you perform scale adjustment to change the scales of the graph, the delta marker moves to the point having the same value on the graph.

Even after you have placed the delta marker (Δ) at a point on the screen, you can move the delta marker to the main marker position by pressing the mode selection key described above.

The Delta Marker Mode menu provides a mode in which the delta marker and the main marker move together; this is called the tracking delta marker mode (**TRACKING Δ MKR** key). This function must be used only during “Analyze trace bandwidth” on page 236. Do not select it at this point.

Moving the delta marker alone to place it at a reference point

Follow these steps to move only the delta marker itself to a reference point.

Step 1. By following “Placing the delta marker on the reference point with the main marker” on page 217, display the delta marker on the screen.

Note that you do not have to specify the main marker position in Step 2 this time.

Step 2. Press the **[Marker]** key to display the Marker menu.

Step 3. Press the **Δ MODE MENU** key to display the Delta Marker menu.

Step 4. Select the parameter indicating the position of the delta marker you want to change from the following.

Position parameter of delta marker	Key operation
Sweep parameter value	ΔMKR STIMULUS
Measurement parameter value (when the measurement parameter is COMPLEX Z-Y, the primary measurement parameter value)	FIXED ΔMKR VALUE
Secondary measurement parameter value (can be set only when the measurement parameter is COMPLEX Z-Y)	FIXED ΔMKR AUX VALUE

Reading the difference from the reference point on the screen (delta marker)

When you press the key, the current set value of the selected parameter indicating the delta marker position is displayed in the Setting Parameter Value field in the upper left area of the screen.

When the measurement parameter is COMPLEX Z-Y, there are two types of scalar measurement parameters (primary measurement parameter and secondary measurement parameter) for both trace A and trace B; therefore you set the measurement parameter values of the delta marker with two keys: **FIXED ΔMKR VALUE** key and **FIXED ΔMKR AUX VALUE** key. The definition of the primary measurement parameter and secondary measurement parameter is shown in Table 8-1.

Table 8-1 Definitions of primary and secondary parameters when measurement parameter is COMPLEX Z-Y

Display format	Primary measurement parameter	Secondary measurement parameter
Complex plane (COMPLEX)	Real part (R or G)	Imaginary part (X or B)
Polar coordinates (POLAR)	Absolute value ($ Z $ or $ Y $)	Phase (θ_Z or θ_Y)

NOTE

If you have selected the delta-marker-on-the-trace mode (**ΔMKR** key) in “Placing the delta marker on the reference point with the main marker” on page 217, you cannot set the measurement parameter value (**FIXED ΔMKR** key) or secondary measurement parameter value (**FIXED ΔMKR AUX VALUE** key).

- Step 5.** Use the keys or rotary knob of the ENTRY block in one of the following ways to specify the position parameter of the delta marker you have selected.
- Enter the desired value with the numeric keys (**[0]** to **[9]** **[.]** and **[-]**) and then press one of the unit keys (**[G/n]**, **[M/μ]**, **[k/m]**, or **[×1]**).
 - Turn the rotary knob (**○**) until the desired value is set.
 - Press the step keys (**[↑]****[↓]**) to set the desired value.
- Step 6.** Repeat Step 4 and Step 5 to move the delta marker to the reference point.

NOTE

You cannot use the automatic move (search) function of the delta marker alone to move to a point on the trace such as the maximum value, minimum value, target value, peak, and so on. To move the delta marker to one of these points, follow the step shown in “Placing the delta marker on the reference point with the main marker” on page 217.

Displaying the main/sub-marker and reading the difference from the reference point

After placing the delta marker at the reference point by following “Placing the delta marker on the reference point with the main marker” on page 217 or “Moving the delta marker alone to place it at a reference point” on page 218, display the main marker or sub-marker on the trace and move it to the desired location.

For how to move the main marker, refer to related topics including:

- “Specify the sweep parameter value and read the value on the trace” on page 212
- “Search the maximum/minimum measurements” on page 223
- “Search the point of target measurement” on page 225
- “Search the maximum/minimum peak” on page 228

NOTE

The sweep parameter value or measurement parameter value you specify for moving the main marker should be a relative value from the delta marker. The values displayed in the Marker Sweep Parameter Value field and Marker Measurement Parameter Value field in the upper right area of the screen are also relative values from the delta marker position.

In addition, the softkey labels in the Sub-Marker Setting menu and the marker value list displayed by the marker list function are also displayed as differences from the set delta marker.

For how to turn off the marker, refer to “Clearing (turning off) the marker from the screen” on page 247.

For how to display/move the sub-marker, refer to “Listing data at several points on the trace” on page 214.

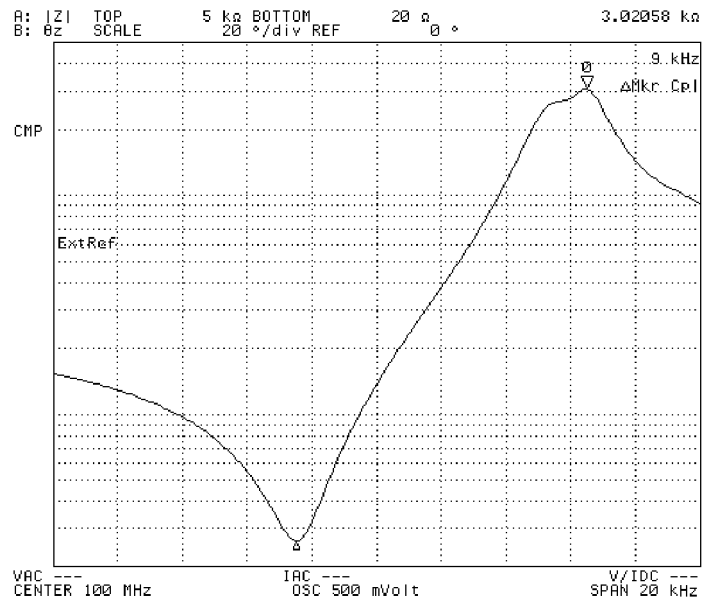
Figure 8-4**Displayed difference from the reference point in the delta-marker-on-the-trace mode**

4294aoj112

Figure 8-5

Displayed difference from the reference point in the fixed delta marker mode

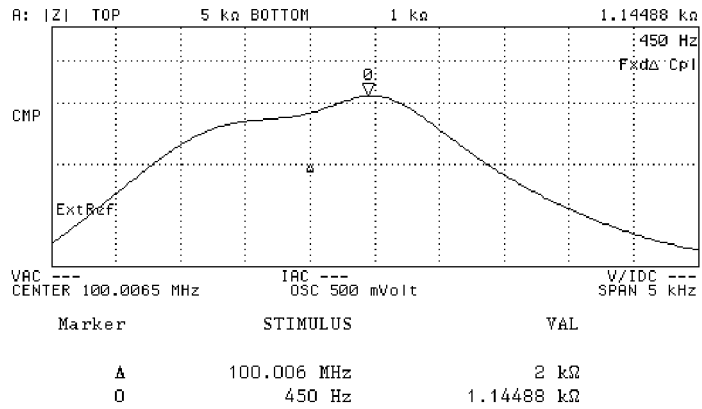

4294aoj113

Reading actual measurement points only/reading interpolated values between measurement points

The preset setting allows you to read, in addition to actual measurement points on the trace, any point between measurement points by an interpolation calculation using the marker (for example, you can directly enter the sweep parameter value of the desired destination with the numeric keys to move the marker to that point). This can be done because the marker interpolation mode is selected as the preset setting. Follow the steps below to set one of two ways to read trace data using the marker: reading interpolated values between measurement points (interpolation mode) or reading measurement points only (non-interpolation mode).

Step 1. Activate the trace whose value you want to read (to which the setting is applied).

Active trace	Key operation
Trace A	[A]
Trace B	[B]

Step 2. Press the **[Marker]** key to display the Marker menu.

Step 3. Press the **MKR []** key to select the marker interpolation mode or non-interpolation mode (pressing the key toggles your selection).

Softkey label	Selected marker mode
MKR [CONT]	Interpolation mode (you can read data between actual measurement points by interpolation calculation)
MKR [DISCRETE]	Non-interpolation mode (you can read data only at actual measurement points)

NOTE

In the marker non-interpolation mode, if you try to move the marker by entering a sweep parameter value with the numeric keys and the entered value is not equal to the value of an actual measurement point, the marker moves to the nearest measurement point having a value larger than the entered value.

Search the maximum/minimum measurements

Step 1. Activate the trace that you want to be searched.

Active trace	Key operation
Trace A	[A]
Trace B	[B]

Step 2. Press the **[Search]** key to display the Search menu. If the main marker is not on the active trace, it appears at the position of the sweep center value on the trace.

Step 3. Use the following keys to search the trace:

Search type	Key operation
Search of maximum parameter value MAX	MAX
Search of maximum parameter value MIN	MIN

Step 4. Read the value displayed in the marker sweep parameter value field and marker measurement parameter value field on the screen.

Figure 8-6

Maximum search value by trace

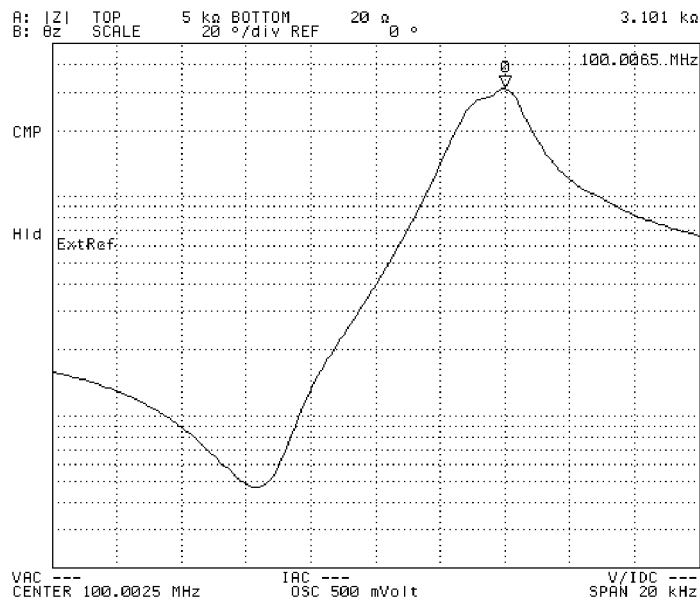

4294a0j055

Figure 8-7

Minimum search value by trace

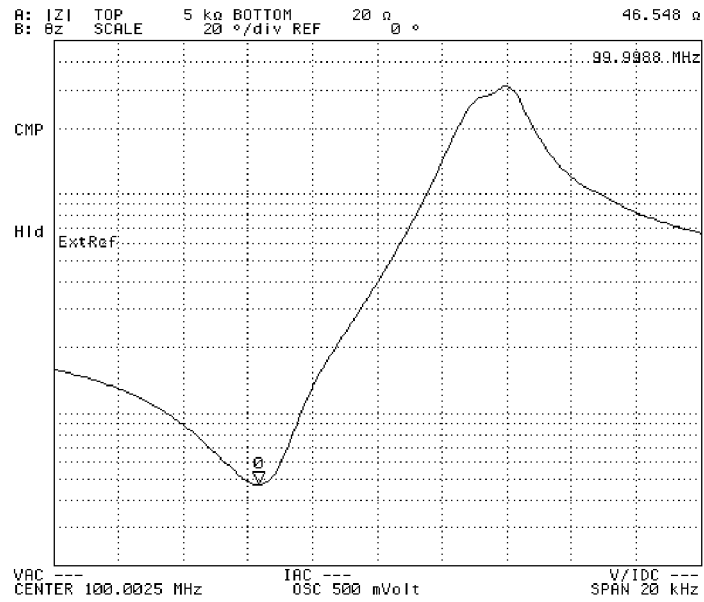

4294aoj056

NOTE

When the **MAX**, **MIN**, **TARGET** or **PEAK** key is used for searching, one search is carried out for the trace when the key is pressed. If the search tracking function is on, search is executed every time a sweep is completed. For details on the search tracking function, refer to “Automatically performing search for each sweep (search tracking)” on page 235.

Search the point of target measurement

You can use the target value search function to move the main marker in automatic mode to the point of the specified (target) measurement on the trace and to read the sweep parameter value at that point.

Step 1. Activate the trace to be searched.

Active trace	Key operation
Trace A	[A]
Trace B	[B]

Step 2. Press the **[Search]** key to display the Search menu. If the main marker is not on the active trace, the main marker appears at the position of the sweep center value on the trace.

Step 3. Press the **TARGET** key, which displays the current target value in the set parameter value field in the upper left area of the screen. At the same time, the target menu also appears.

NOTE

When the **TARGET** key is pressed, the target value search is carried out based on the preset target value (zero when preset), and the main marker is moved to the point of the target measurement. Accordingly, once the target value is set, the set target value can be searched only by pressing the **TARGET** key except when the Preset key is pressed.

Step 4. Use the keys or rotary knob of the ENTRY block in one of the following ways to specify a new target value.

- Enter the desired value with the numeric keys ([0] to [9] [.] and [-]) and then press one of the unit keys ([G/n], [M/ μ], [k/m], or [$\times 1$]).
- Turn the rotary knob (O) until the desired value is set.
- Press the step keys ([\uparrow][\downarrow]) to set the desired value.

When the value is set, the target value is searched and the main marker moves to the target value.

Figure 8-8 Result of target value search (Trace B)

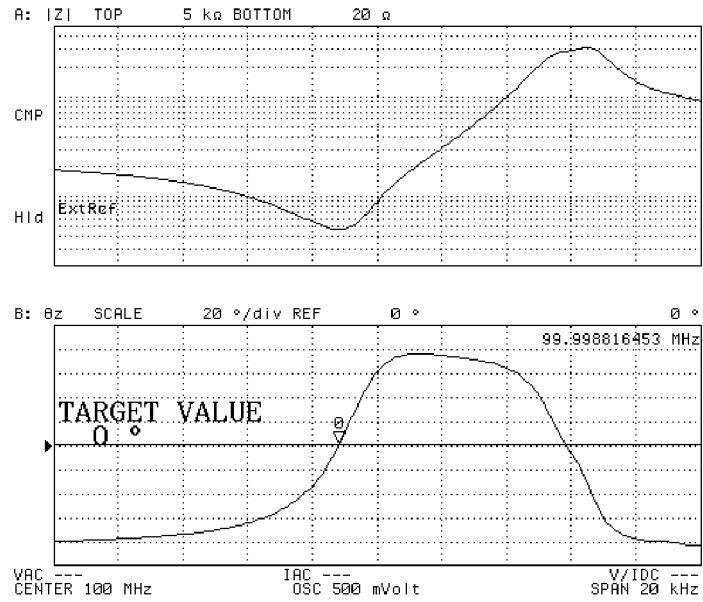

4294aoj057

NOTE

If multiple target values are present on the trace, the main marker moves to the target value of the measuring points that were closest to the main marker immediately before the target value search was executed.

If the target value is not found, the message “TARGET VALUE NOT FOUND” is displayed in the upper left area of the screen.

Step 5. If multiple target measurements are present on the trace, operate the following key to move from the first searched point to other points.

Search type	Key operation
Search in the left direction (search from the current marker position in the direction of decreasing sweep parameter values, and move the main marker to the first detected target value)	SEARCH LEFT
Search in the right direction (search from the current marker position in the direction of increasing sweep parameter values, and move the main marker to the first detected target value)	SEARCH RIGHT

Figure 8-9 Right search after Figure 8-8

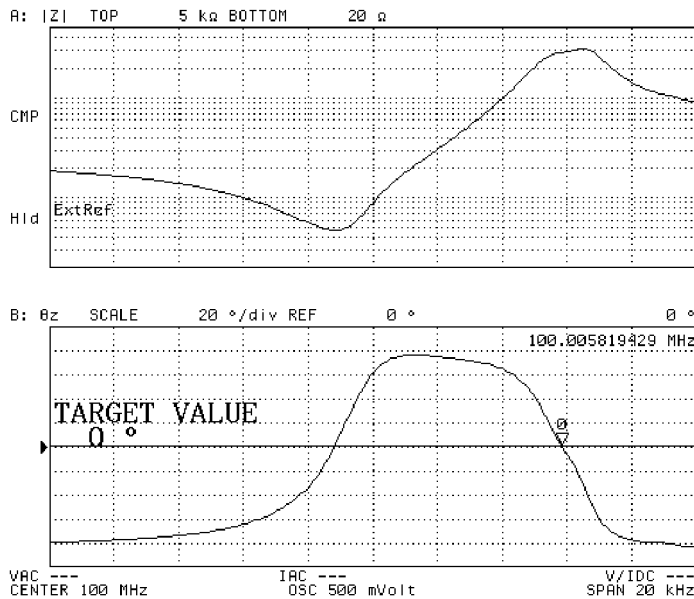

4294aoj058

NOTE

To place the sub-marker on the searched point, press the **SUB MKR** key located on the same target menu to display the sub-marker setting menu. Then select the desired sub-marker out of the seven sub-markers.

Step 6. Read the value displayed in the marker sweep parameter value field on the screen.

NOTE

When the **MAX**, **MIN**, **TARGET**, or **PEAK** key is used for searching, one search is carried out for the trace when the key is pressed. If the search tracking function is on, search is executed every time a sweep is completed.

Search the maximum/minimum peak

The peak search function enables the main marker to be moved to the maximum or minimum point in automatic mode.

Step 1. Activate the trace to be searched.

Active Trace	Key operation
Trace A	[A]
Trace B	[B]

Step 2. Press the **[Search]** key to display the Search menu. If the main marker is not on the active trace, the main marker appears at the position of the sweep center value on the trace.

Step 3. Press the **PEAK** to display the target menu.

NOTE

If the peak is defined in advance by the **PEAK DEF MENU** key inside the target menu, only this specified peak will be searched when the **PEAK** key is pressed. (If the peak is not defined in advance, search will be done according to the definition of the peak at initialization.)

When multiple peaks are present, the main marker will go to the peak where the measurement parameter value is maximum if the peak polarity is defined as positive. The main marker will go to the peak where the measurement parameter value is minimum if the peak polarity is defined as negative.

For details on the peak definition, see the description “Define the Peak” on page 232.

Step 4. In the presence of multiple peaks, use the softkey of the target menu to move the main marker to a peak as shown below.

Peak search type	Key operation
Search the maximum peak (the same function as that of Step 3)	PEAK
Search the maximum peak out of the peaks smaller than the measurement parameter of the current main marker	NEXT PEAK
Search peaks in the left direction (direction of decreasing sweep parameter values) from the current marker, and move the main marker to the first detected peak	NEXT PEAK LEFT
Search peaks in the right direction (direction of increasing sweep parameter values) from the current marker, and move the main marker to the first detected peak	NEXT PEAK RIGHT

NOTE

After moving the main marker to each peak, you can use the **SUB MKR** key in the same

Peak menu to also place the sub-marker at that peak. This **SUB MKR** key is equivalent to the **SUB MKR** key on the Marker menu displayed by pressing the **[Marker]** key. For how to use the sub-marker, refer to “Listing data at several points on the trace” on page 214.

Figure 8-10 Search the maximum peak of $|Z|$ using the **PEAK** key

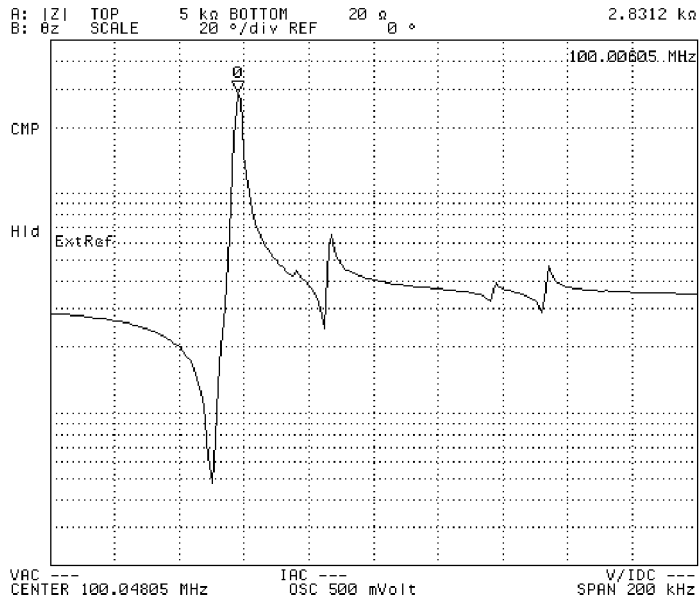

4294aoj059

Figure 8-11

Search the next peak after Figure 8-10 using the NEXT PEAK key

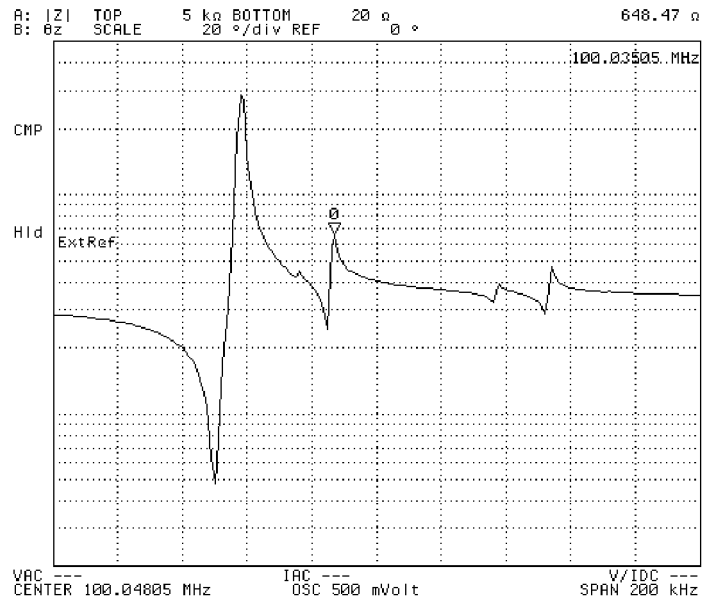

4294aoj060

Figure 8-12

Search the right-hand peak after Figure 8-11 using the NEXT PEAK RIGHT key

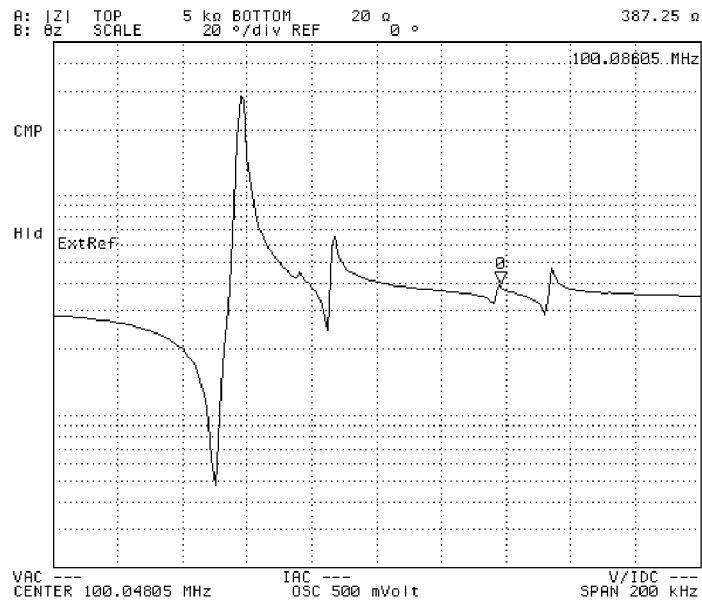

4294aoj061

Define the Peak

When peaks are defined, unwanted peaks can be excluded so that only the peaks matching the definition are detected.

In Figure 8-14, the Agilent 4294A peaks are defined.

Figure 8-14

Defining the Peak

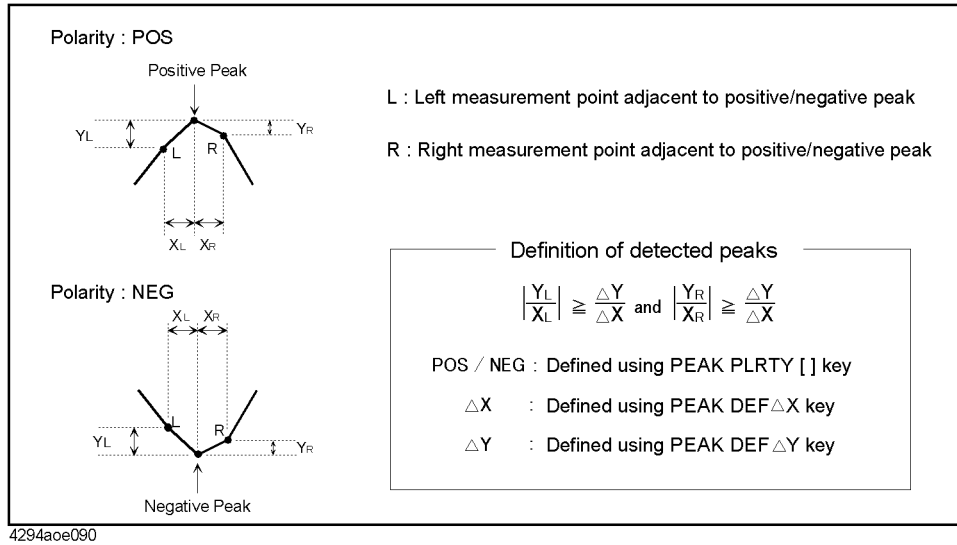

Definition of peak polarity

Define the peak polarity according to the following steps:

Step 1. Activate the trace for which the peak polarity is defined.

Active Trace	Key operation
Trace A	[A]
Trace B	[B]

Step 2. Press the **[Search]** key to display the Search menu.

Step 3. Press the **PEAK** key to display the Peak menu.

Step 4. Press the **PEAK DEF MENU** key to display the Peak Definition menu.

Step 5. Press the **PEAK PLRTY []** key to select the peak polarity (pressing the key toggles the peak polarity).

Softkey label	Selected peak polarity
PEAK PLRTY [POS]	Positive (if the measurement at this point is greater than the measurement of the adjacent measuring points, it is regarded as a peak)

Softkey label

PEAK PLRTY [NEG]

Selected peak polarity

Negative (if the measurement at that point is smaller than the measurement of the adjacent measuring points, it is regarded as a peak)

Define peak sharpness

The following steps are used to define the peak sharpness:

- Step 1.** Press the **[Search]** key to display the Search menu.
- Step 2.** Press the **PEAK** key to display the Peak menu.
- Step 3.** Press the **PEAK DEF MENU** key to display the Peak Definition menu.
- Step 4.** Press the **PEAK DEF ΔX** key. The set value of the current peak ΔX is displayed in the set parameter value field in the upper left area of the screen.
- Step 5.** Use the keys or rotary knob of the ENTRY block in one of the following ways to specify a new peak DX value.
 - Enter the desired value with the numeric keys (**[0]** to **[9]** and **[.]**) and then press one of the unit keys (**[G/n]**, **[M/μ]**, **[k/m]**, or **[×1]**).
 - Turn the rotary knob (**○**) until the desired value is set.
 - Press the step keys (**[↑]****[↓]**) to set the desired value.
- Step 6.** Press the **PEAK DEF ΔY** key to display the set value of the current peak ΔY in the set parameter value field in the upper left area of the screen.
- Step 7.** Use the keys or rotary knob of the ENTRY block in one of the following ways to specify a new peak DY value.
 - Enter the desired value with the numeric keys (**[0]** to **[9]** and **[.]**) and then press one of the unit keys (**[G/n]**, **[M/μ]**, **[k/m]**, or **[×1]**).
 - Turn the rotary knob (**○**) until the desired value is set.
 - Press the step keys (**[↑]****[↓]**) to set the desired value.

Define peak sharpness using a peak on the trace

A peak on the trace can be used to define peak sharpness.

- Step 1.** Activate the trace for which the peak sharpness is defined.

Active Trace	Key operation
Trace A	[A]
Trace B	[B]

- Step 2.** Move the main marker to the peak used to define the peak sharpness.

NOTE

Here, the main marker can be moved to the target peak by a peak search according to

Analysis and Processing of Result

Define the Peak

“Search the maximum/minimum peak” on page 228. It should be noted, however, that a definition must be set in advance by using the **PEAK DEF ΔX** key and **PEAK DEF ΔY** key to ensure that the target peak is searched. To ensure that all peaks are detected, perform peak search after setting the peak ΔY value to zero using the **PEAK DEF ΔY** .

- Step 3.** Press the **[Search]** key to display the Search menu.
- Step 4.** Press the **PEAK** key to display the Peak menu.
- Step 5.** Press the **PEAK DEF MENU** key to display the Peak Definition menu.
- Step 6.** Press the **MKR \rightarrow PEAK DELTA** key to enter the peak sharpness at the main marker position into the peak definition of ΔX and ΔY .

NOTE

When using the **MKR \rightarrow PEK DELTA** key to define the peak, the sharpness of the left side (where the sweep parameter value is smaller) of the peak at the main marker position is used to define ΔX and ΔY .

With both the Δ marker and the main marker displayed on the screen, if you press the **MKR \rightarrow PEK DELTA**, the sweep parameter value (absolute value) of the difference between the main marker and the Δ marker is assigned to the definition of ΔX ; correspondingly, the measurement parameter value (absolute value) of this difference is assigned to the definition of ΔY .

Automatically performing search for each sweep (search tracking)

In the preset setting, the maximum value/minimum value search, target value search, or peak search function is executed only once when the corresponding key (MAX key, MIN key, and so on) is pressed. On the other hand, you can set the search on the trace to perform automatically at the completion of each sweep (search tracking function).

- Step 1.** Activate the trace for which you want to execute search tracking (to which the setting is applied).

Active Trace	Key operation
Trace A	[A]
Trace B	[B]

- Step 2.** Press the **[Search]** key to display the Search menu.

- Step 3.** Press the **SEARCH TRK** on **OFF** key to turn on the search tracking function (pressing the key toggles your selection).

Softkey label	Search tracking function
SEARCH TRK ON off	On (search is executed when you press a search execution key; it is also executed automatically each time a single sweep is completed)
SEARCH TRK on OFF	Off (search is executed only when you press a search execution key)

- Step 4.** Select the search function you want to perform in the search tracking.

Search function	Key operation
Maximum value search	MAX
Minimum value search	MIN
Target value search	TARGET
Peak search	PEAK

For details about each search function, refer to:

- “Search the maximum/minimum measurements” on page 223
- “Search the point of target measurement” on page 225
- “Search the maximum/minimum peak” on page 228 and “Define the Peak” on page 232

Analyze trace bandwidth

The Agilent 4294A can automatically derive the parameters called bandwidth, center value, Q value, peak, ΔL , and ΔR from the measurement trace.

At the instant when the trace bandwidth analysis function is turned on and at the completion of each subsequent sweep, cutoff points are searched for on the sweep parameter value axis, starting from the main marker position at that time and advancing in both directions. When two cutoff points are detected, six parameters (bandwidth (width), center value (center), Q, peak (peak), ΔL , and ΔR) are derived from the data at those points and displayed in the Marker Statistics/Trace Bandwidth Analysis Result field on the right of the screen.

NOTE

The peak (peak), one of the six parameters displayed on the screen as trace bandwidth analysis results, is the first position of the main marker itself. Therefore, before executing the trace bandwidth analysis, use the peak search function and so on to move the main marker to the peak on the trace as necessary.

The cutoff points are searched for according to the definition specified by the user. For how to define the cutoff points, refer to Appendix , “Define the cutoff point in trace bandwidth analysis,” on page 238.

The definitions of the six parameters displayed on the screen as the final results also vary depending on the delta marker mode selected at the time. For how to set the delta marker mode, refer to “Setting the delta marker in the trace bandwidth analysis” on page 239.

Definitions of parameters in the trace bandwidth analysis

Table 8-2 shows the definition of each parameter in the trace bandwidth analysis.

Table 8-2

Definitions of parameters in trace bandwidth analysis

Parameter	Definition
Cutoff point	Two points having the predefined measurement parameter value that are searched for and detected from the main marker position to both ends on the trace. You define the measurement parameter value of the cutoff points by selecting, assuming that the measurement parameter value of the main marker position is $MKRVAL$, $\frac{MKRVAL}{\sqrt{2}}$, $MKRVAL \times \sqrt{2}$, $\frac{MKRVAL}{2}$ or a user entered value (fixed value). For more information on the procedure of the definition, refer to “Define the cutoff point in trace bandwidth analysis” on page 238. At the detected cutoff points, the sub-markers numbered 2 and 3 will be placed.

Table 8-2 **Definitions of parameters in trace bandwidth analysis**

Parameter	Definition
Bandwidth:	Indicates the interval of sweep parameter values at two cutoff points (width = interval between sub-markers 2 and 3 in Figure 8-15). This definition does not depend on the Δ marker mode.
Center:	Indicates a midpoint between the sweep parameter values at two cutoff points (center = sweep parameter value at the position of sub-marker 1 in Figure 8-15). It serves as a relative value with reference to the fixed Δ marker only when the fixed Δ marker is present.
Q	Indicates value Q obtained from two cutoff points (Center/Width).
Peak:	Indicates the measurement parameter value at the position of the main marker (marker 0). However, it indicates a relative value with reference to the fixed Δ marker only when the fixed Δ marker is present. When the main marker is moved to the peak by using the peak search function, that peak is displayed at this position.
ΔL	Indicates the length of the sweep parameter from the sweep center value to the cutoff point on the left. However, it indicates the length of the sweep parameter from the sweep parameter value of the fixed Δ marker to the cutoff point on the left only when the fixed Δ marker is present.
ΔR	Indicates the length of the sweep parameter from the sweep center value to the cutoff point on the right. However, it indicates the length of the sweep parameter from the sweep parameter value of the fixed Δ marker to the cutoff point on the right only when the fixed Δ marker is present.

Figure 8-15

Trace bandwidth analysis function (different definition for each D marker mode)

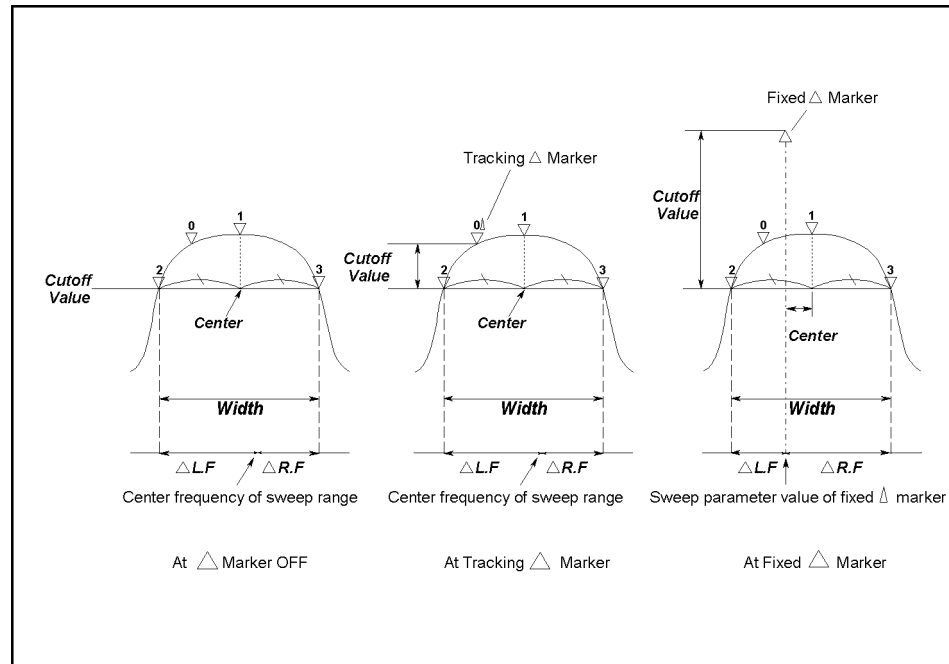

4294ape023

NOTE

The cutoff value in Figure 8-15 indicates the set value when the fixed value (**FIXED VALUE** key) in the definition of the cutoff point is selected. For the definition of the cutoff point, see “Define the cutoff point in trace bandwidth analysis” on page 238.

Define the cutoff point in trace bandwidth analysis

When trace bandwidth analysis is performed, the Agilent 4294A searches for the cutoff points on both sides with respect to the sweep parameter shaft starting from the main marker position. The cutoff point used for this search is defined by the following steps:

Step 1. Activate the trace for which you want to analyze trace bandwidth.

Active Trace	Key operation
Trace A	[A]
Trace B	[B]

Step 2. Press the [Search] key to display the Search menu.

Step 3. Press the **WIDTHS DEF MENU** key to display the trace bandwidth analysis definition menu.

Step 4. Select the definition of the cutoff point in trace bandwidth analysis from the following:

Definition of cutoff point ¹	Key operation
$\frac{MKRVAL}{\sqrt{2}}$	MKRVAL/(√2)
$MKRVAL \times \sqrt{2}$	MKRVAL*(√2)
$\frac{MKRVAL}{2}$	MKRVAL/2
Fixed value (specified by numerical value)	FIXED VALUE

1. MKRVAL: Indicates the measurement parameter value (measurement) at the position of the main marker (marker 0).
Fixed value: Indicates the absolute value of the measurement parameter if there is no Δ marker; it is a relative value with reference to the tracking Δ marker if tracking (Δ marker that moves with the main marker) is present and a relative value with reference to the fixed Δ marker if the fixed Δ marker is present.

Step 5. When the fixed value is selected (using the **FIXED VALUE** key) in step 4, the fixed value (measurement parameter value) to define the current cutoff point is displayed in the set parameter value field in the upper left area of the screen.

Step 6. Use the keys or rotary knob of the ENTRY block in one of the following ways to specify the fixed value of the cutoff point.

- Enter the desired value with the numeric keys ([0] to [9], [-] and [.]) and then press one of the unit keys ([G/n], [M/μ], [k/m], or [×1]).
- Turn the rotary knob (O) until the desired value is set.
- Press the step keys ([↑][↓]) to set the desired value.

To return to the search menu after defining the cutoff point, press the **return** key.

Setting the delta marker in the trace bandwidth analysis

The definition of each parameter obtained in the trace bandwidth analysis varies depending on the delta marker mode selected at the time. Before executing the trace bandwidth analysis, select the delta marker mode. If you use the fixed delta marker mode, set the delta marker position also.

Step 1. Activate the trace for which you want to perform the trace bandwidth analysis.

Active Trace	Key operation
Trace A	[A]
Trace B	[B]

Step 2. Press the **[Marker]** key to display the Marker menu.

Step 3. Press the **ΔMODE MENU** key to display the Delta Marker menu.

Step 4. Select the delta marker mode that specifies the definition of each parameter in the trace

Analysis and Processing of Result

Analyze trace bandwidth

bandwidth analysis.

Delta marker mode	Key operation
Fixed delta marker mode	FIXED ΔMKR
Tracking delta marker mode	TRACING ΔMKR
Delta marker off	ΔMKR OFF

When you have selected the delta marker mode, the delta marker (Δ) appears at the main marker position on the trace.

NOTE

Even after you have placed the delta marker (Δ) at a point on the screen by pressing the mode selection key described above, you can move the delta marker to the main marker position.

The Delta Marker Mode menu provides a mode called the delta-marker-on-the-trace mode (ΔMKR key). This function is used only as described in Appendix , “Reading the difference from the reference point on the screen (delta marker),” on page 217. Do not select it at this point. If you select this mode and then turn on the trace bandwidth analysis function, the mode is automatically changed to the tracking delta marker mode.

- Step 5.** If you use the fixed delta marker mode, move the delta marker to the desired position on the screen. For how to move the delta marker, refer to Appendix , “Moving the delta marker alone to place it at a reference point,” on page 218.

Implement trace bandwidth analysis

The following describes the steps to implement trace bandwidth analysis:

- Step 1.** Activate the trace used to implement trace bandwidth analysis.

Active Trace	Key operation
Trace A	[A]
Trace B	[B]

- Step 2.** Display the main marker and move it to the desired position on the trace to analyze trace bandwidth. To move the main marker to the peak of the trace, see “Search the maximum/minimum peak” on page 228.

- Step 3.** Press the **[Search]** key to display the Search menu.

- Step 4.** Press the **WIDTH on OFF** key to turn on the trace bandwidth analysis function.

Softkey label	State of trace bandwidth analysis function
WIDTH ON off	ON
WIDTH on OFF	OFF

If the trace bandwidth analysis function is turned on, the bandwidth (width), center value (center), Q, peak (peak), ΔL, and ΔR are displayed in the Marker Statistics/Trace

Bandwidth Analysis Result area on the right of the screen.

Figure 8-16 Trace bandwidth analysis result

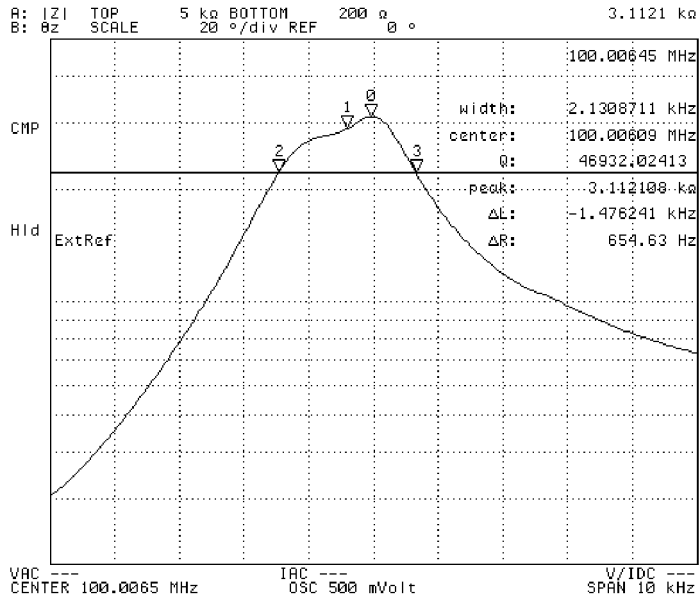

4294aoj063

NOTE

If the trace bandwidth analysis function is turned on, the straight line showing the cutoff line is displayed parallel to the sweep parameter axis.

- Step 5.** When the cutoff point searched is not the target, press the **WIDTH DEF MENU** key to display the trace bandwidth analysis definition menu, and use the following functions:

Cutoff point re-search function	Key operation
Inner search (two different cutoff points are searched for with respect to the two currently displayed cutoff points toward the inside on the sweep parameter axis, and each parameter of trace bandwidth analysis is displayed for the cutoff point detected first)	SEARCH IN
Outer search (two different cutoff points are searched for with respect to the two currently displayed cutoff points toward the outside on the sweep parameter axis, and each parameter of trace bandwidth analysis is displayed for the cutoff point detected first)	SEARCH OUT

Press these softkeys several times if necessary to find the trace bandwidth analysis parameter at the target cutoff point.

NOTE

Cutoff point re-search does not cause the main marker to move, so it does not affect the

Analysis and Processing of Result

Analyze trace bandwidth

peak value.

If the two cutoff points cannot be found by trace bandwidth analysis, the message TARGET VALUE NOT FOUND will appear in the upper left area of the screen.

If a partial search range is specified by following “Specify partial search range” on page 267, trace bandwidth analysis will be executed within that range.

Even if the trace bandwidth analysis function is turned off, the marker used for analysis will not disappear from the screen. To hide all markers, turn them off by pressing **[Marker] - MKR ON off** and the appropriate key operation.

Set the marker separately for either trace A or B

In setting the preset time, marker setting procedures are applied to both traces A and B (for example, movements of the main marker are common to traces A and B). This is because the marker coupling function is turned on in the preset time setting. To set the marker separately for either trace A or B, the following steps must be taken:

- Step 1.** Press the **[Marker]** key to display the marker menu.
- Step 2.** Press the **MKR COUPLE ON off** key to turn off the marker coupling function. The softkey label will change to **MKR COUPLE on OFF**. Setting of the marker thereafter applies separately to either trace A or B.

Softkey label	State of marker coupling function
MKR COUPLE ON off	ON (marker setting applies to both traces A and B)
MKR COUPLE on OFF	OFF (marker setting applies separately to either trace A or B)

Figure 8-17

Marker coupling function off

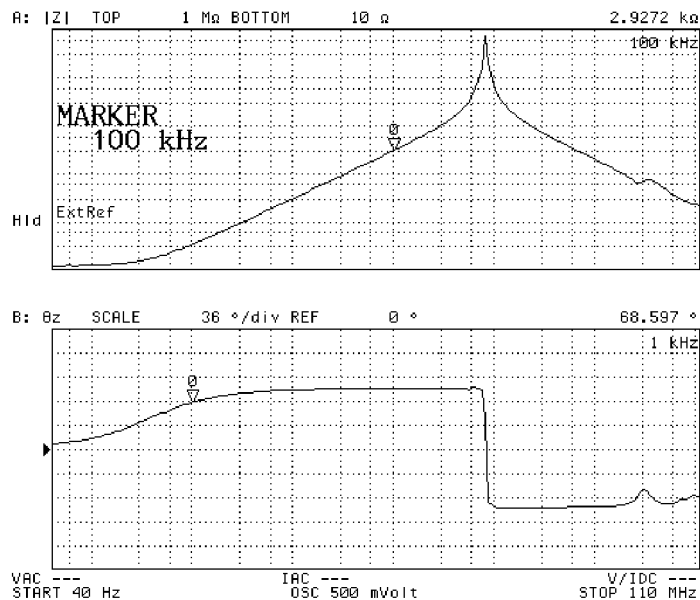

4294a0j054

NOTE

The marker couple function on/off setting applies to both traces A and B. You need not select the active trace or confirm your selection before setting.

Selecting target trace (data or memory) for marker analysis

The Agilent 4294A provides the data trace and memory trace for both trace A and trace B, which you can use to display measured data. Note that, in the preset setting, the target for the analysis using the marker is the data trace (all operations such as moving the marker and displaying data are applied to the data trace). This is because the target trace for marker analysis is the data trace in the preset setting.

Only when the memory trace is displayed on the screen can you select the target trace for marker analysis by following these steps.

Step 1. Activate the trace you want to analyze.

Active Trace	Key operation
Trace A	[A]
Trace B	[B]

Step 2. Press the **[Marker]** key to display the Marker menu.

Step 3. Press the **MKR ON []** key to select the marker analysis target trace (pressing the key toggles your selection).

Softkey label	State of marker coupling function
MKR ON [DATA]	Data trace
MKR ON [MEMORY]	Memory trace

NOTE

If the memory trace for the active trace in marker analysis (trace A or trace B) is not displayed, the target trace is automatically set to the data trace. You cannot change this setting. For how to use the memory trace, refer to “Trace-based Comparison and Calculation” on page 179.

Selecting the sweep parameter value of the marker display as time from start or relaxation time

You can use the following procedure to select how the sweep parameter value is displayed in the Marker Sweep Parameter Value field: time relative to the sweep start or relaxation time. This function allows you to read the sweep parameter value in a unit of time at each point on the trace in the zero span sweep.

- Step 1.** Press the **[Utility]** key to display the Utility menu.
- Step 2.** Press the **MKR X-ASIX []** key to display the Marker X-Axis menu.
- Step 3.** Select the display method of the marker sweep parameter value.

Display in the Marker Sweep Parameter Value field (marker X-axis display)	Key operation
---	---------------

Value of the parameter selected as the sweep parameter (frequency, oscillator level, or dc bias level)	STIMULUS
--	-----------------

Time between the sweep start and the completion of the measurement at the marker position	TIME
---	-------------

Relaxation time = $\frac{1}{2\pi F}$ (F: measurement frequency)	1/(2πF)
---	-------------------------------

NOTE

You can select relaxation time as the method to display the marker sweep parameter value (marker X-axis) only when the frequency is selected as the sweep parameter.

When you use the Δ marker, the relative value from the Δ marker position is displayed in the Marker Sweep Parameter Value area, regardless of the selection of the marker sweep parameter value (marker X-axis) display.

Note that in the [] of the key label of the **MKR X-AXIS []** key, the currently selected marker X-axis display is displayed as follows.

Softkey label	Selected marker X-axis display
MKR X-AXIS [STIM]	Sweep parameter
MKR X-AXIS [TIME]	Time
MKR X-AXIS [1/(2πF)]	Relaxation time = $\frac{1}{2\pi F}$ (F: Measurement frequency)

Selecting the sweep parameter value of the marker display as time from start or relaxation time

Figure 8-18

Marker X-axis display: Time from start

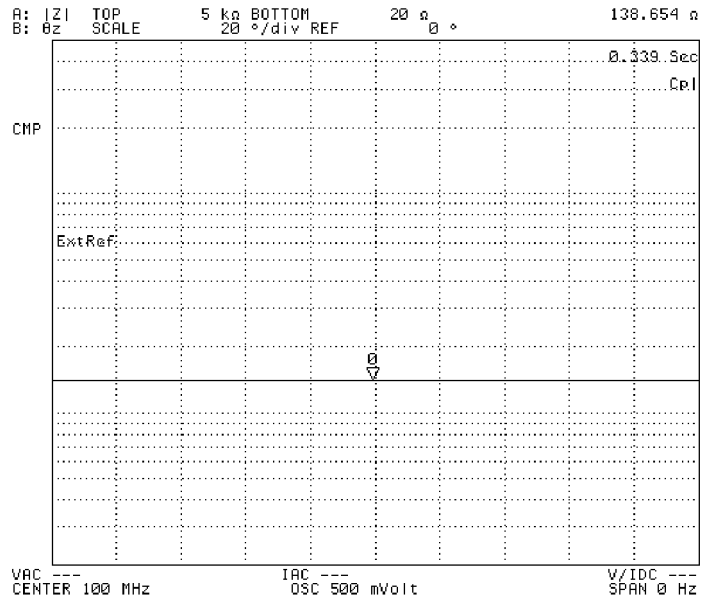

4294aoj111

Clearing (turning off) the marker from the screen

This section describes how to turn off each marker or all markers on the screen.

Turning off the sub-markers

Follow these steps to turn off each sub-marker (markers numbered 1 to 7).

Step 1. Activate the trace displaying the sub-marker you want to turn off.

Active Trace	Key operation
Trace A	[A]
Trace B	[B]

Step 2. Press the **[Marker]** key to display the Marker menu.

Step 3. Press the **CLEAR SUB MKR** key to display the Sub-Marker Clear menu.

Step 4. Select the number of the sub-marker you want to clear from the following.

Type of sub-marker	Key operation
Sub-marker 1 (marker number 1)	1.....
Sub-marker 2 (marker number 2)	2.....
Sub-marker 3 (marker number 3)	3.....
Sub-marker 4 (marker number 4)	4.....
Sub-marker 5 (marker number 5)	5.....
Sub-marker 6 (marker number 6)	6.....
Sub-marker 7 (marker number 7)	7.....

For a sub-marker that is on, the sweep parameter value and measurement parameter value (indicating the position of the sub-marker) are displayed to the right of the sub-marker number of the softkey label (“.....” in the above key operation column). When you turn off the sub-marker, “.....” in the above key operation column changes to OFF.

Turning off the delta marker

You can use the following procedure to turn off the delta marker on the screen regardless of whether the delta marker mode is delta marker mode, fixed delta marker mode, or tracking delta marker mode.

Step 1. Activate the trace containing the delta marker you want to turn off.

Active Trace	Key operation
Trace A	[A]

Analysis and Processing of Result
Clearing (turning off) the marker from the screen

Active Trace	Key operation
Trace B	[B]

- Step 2.** Press the **[Marker]** key to display the Marker menu.
- Step 3.** Press the **ΔMODE MENU** key to display the Delta Marker menu.
- Step 4.** Press the **ΔMKR OFF** key to turn off the delta marker.

Turning off all (main/sub/delta) markers at one time

You can use the following procedure to turn off any marker on the screen, including the main marker (marker numbered 0), the sub-markers (markers numbered 1 to 7), and the delta marker, regardless of the delta marker mode, at one time.

- Step 1.** Activate the trace on which you want to turn off all the markers.

Active Trace	Key operation
Trace A	[A]
Trace B	[B]

- Step 2.** Press the **[Marker]** key to display the Marker menu.
- Step 3.** Press the **MKR ON** off key to turn off all the markers.

Softkey label	Status of all markers
MKR ON off	ON (displayed)
MKR on OFF	OFF (not displayed)

NOTE

While markers are turned off, their positions and other marker-related settings reside in the Agilent 4294A, unless you preset using the **[Preset]** key or turn off the power. Thus, turning on the markers using the MKR on OFF key will restore previous marker settings.

Calculate the equivalent circuit parameter and simulate the frequency characteristics

The Agilent 4294A is provided with four types of 3-element equivalent circuits and one type of 4-element equivalent circuits. It is possible to calculate the equivalent circuit parameter based on the sample measurement results as well as to display the frequency characteristics on the screen based on the input equivalent circuit parameter.

NOTE

Equivalent circuit parameter analysis is always provided for both traces A and B.

Calculate the equivalent circuit parameter based on the measurement result

Calculate the equivalent circuit parameter based on the measurement result trace according to the following steps:

Step 1. Measure the sample using the frequency as the sweep parameter.

NOTE

If frequency is not selected as the sweep parameter, equivalent circuit analysis (calculation of equivalent circuit parameter and simulation of frequency characteristics) is disabled. On the other hand, equivalent circuit analysis is enabled regardless of which measurement parameter is selected.

Step 2. Press the **[Display]** key to display the Display menu.

Step 3. Press the **more 1/2** key to display the second page of the Display menu.

Step 4. Press the **EQUIV CKT** key to display the Equivalent Circuit Analysis menu.

Step 5. Press the **CKT on OFF** key to turn on the equivalent circuit diagram display function. The equivalent circuit diagram, instead of the measurement trace, is shown on the screen. This will enable you to check the equivalent circuit to be selected in the next step. Note that equivalent circuit analysis is enabled without having to turn on this display.

Figure 8-19

Equivalent circuit diagram display

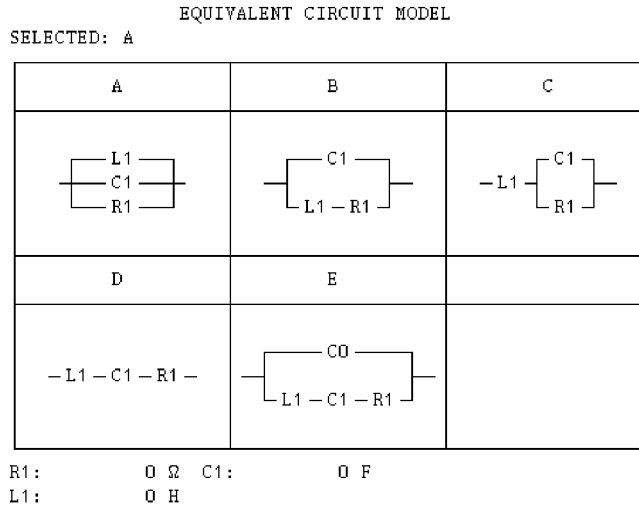

4294acj064

Step 6. Press the **SELECT CIRCUIT** key to display the Equivalent Circuit Select menu.

Step 7. Select the equivalent circuit with key **A, B, C, D** or **E**.

Table 8-3 Selection of equivalent circuit

Equivalent circuit model	Typical frequency characteristics	Sample (example)
<p>A</p>		<p>Inductor with greater core loss</p>
<p>B</p>		<p>Inductor Resistor</p>
<p>C</p>		<p>Resistor with greater value</p>
<p>D</p>		<p>Capacitor</p>

Calculate the equivalent circuit parameter and simulate the frequency characteristics

Table 8-3 Selection of equivalent circuit

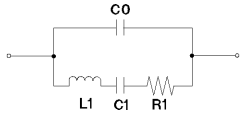
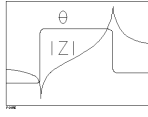
Equivalent circuit model	Typical frequency characteristics	Sample (example)
E 	2 	Resonator

1. Measurement parameter: $|Z| - \theta$, Sweep type: log, Vertical axis: $|Z|$ is log and θ is linear
2. Measurement parameter: $|Z| - \theta$, Sweep type: linear (or log), Vertical axis: $|Z|$ is log and θ is linear

Step 8. Press the **CALCULATE PARAMETERS** (or **CALC PARMS**) key to calculate the equivalent circuit parameter.

When the equivalent circuit parameter is on, the calculated equivalent circuit parameter will be shown under the equivalent circuit diagram. In the case of measurement trace display (equivalent circuit diagram is off), the calculated equivalent circuit parameter will be shown in the equivalent circuit parameter area on the left of the screen.

Figure 8-20 Result of equivalent circuit parameter calculation (using equivalent circuit B)

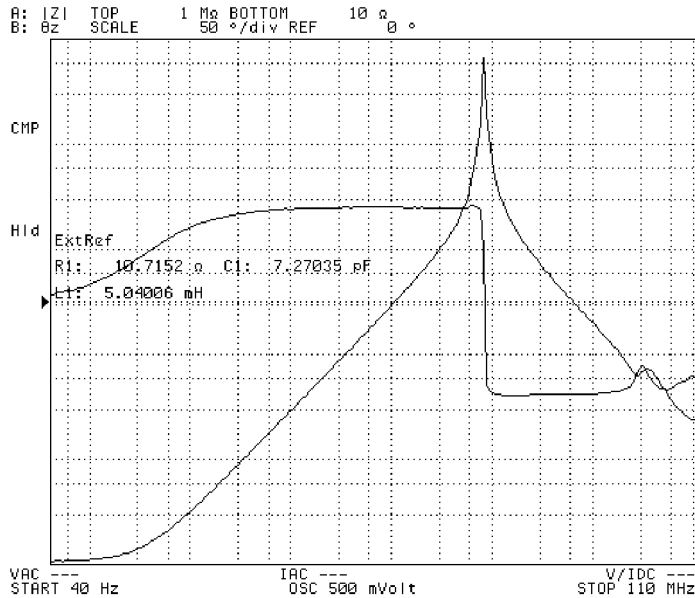

4294aoj065

NOTE

When the partial search range is set, the equivalent circuit parameter is calculated based on the trace within that range. For the partial search range setting procedure, see “Specify partial search range” on page 267.

The display of the equivalent circuit parameter on the measurement trace screen can be turned on and off with the **PARAMETERS ON off** key (**PARAMETERS on OFF**). When the equivalent circuit parameter has been calculated by pressing the **CALCULATE PARAMETER** key, the parameter indication is turned on automatically.

Analysis and Processing of Result

Calculate the equivalent circuit parameter and simulate the frequency characteristics

When the equivalent circuit parameter has been calculated based on the result of sample measurement, we recommend that frequency characteristics be simulated based on the equivalent circuit parameter by following the procedures to “Simulate the frequency characteristics based on the equivalent circuit parameter” (below). The adequacy of the selected equivalent circuit and validity of the parameter calculation result can be verified by comparison between the frequency characteristics of the actual sample and the simulation result.

To calculate the equivalent circuit parameter for a resonator, another possible method, in addition to the method of equivalent circuit analysis used in the equivalent circuit E discussed above, is to use the specifically designed GP-IB command. For details, see *Programming Manual*.

Simulate the frequency characteristics based on the equivalent circuit parameter

Simulate the frequency characteristics according to the following steps:

NOTE

Start from Step 12 when you want to simulate the frequency characteristics on the basis of the equivalent circuit parameter calculated according to the procedure of “Calculate the equivalent circuit parameter based on the measurement result” on page 249.

- Step 1.** Press the **[Display]** key to display the Display menu.
- Step 2.** Press the **more 1/2** key to display the second page of the Display menu.
- Step 3.** Press the **EQUIV CKT** key to display the Equivalent Circuit Analysis menu.
- Step 4.** Press the **CKT on OFF** key to turn on the equivalent circuit diagram indication function. The equivalent circuit diagram, instead of the measurement trace, is shown on the screen. This will enable you to check the equivalent circuit to be selected in the next step. It should be noted that equivalent circuit analysis is enabled without having to turn on this display.
- Step 5.** Press the **SELECT CIRCUIT** key to display the Equivalent Circuit Select menu.
- Step 6.** Select the equivalent circuit according to Table 8-3 on page 250 (using keys **A**, **B**, **C**, **D** and **E**).
- Step 7.** Press the **return** key to go back to the Equivalent Circuit Analysis menu.
- Step 8.** Press the **DEFINE PARAMETERS** key to display the Equivalent Circuit Parameter Definition menu.
- Step 9.** Use the **R1**, **C1**, **L1** and **C0** keys to select the equivalent circuit parameter where the numerical value is to be entered.

Key operation	Key operation
Resistance of R1 of selected equivalent circuit	R1
Capacitance of C1 of selected equivalent circuit	C1
Inductance of L1 of selected equivalent circuit	L1
Capacitance of C0 when the equivalent circuit E is selected	C0

The current set value of the equivalent circuit parameter is displayed in the set parameter

Calculate the equivalent circuit parameter and simulate the frequency characteristics

value field in the upper left area of the screen.

- Step 10.** Use the keys or rotary knob of the ENTRY block in one of the following ways to specify the parameter value.
- Enter the desired value with the numeric keys ([0] to [9], [-] and [.]) and then press one of the unit keys ([G/n], [M/ μ], [k/m], or [$\times 1$]).
 - Turn the rotary knob (O) until the desired value is set.
 - Press the step keys ([\uparrow][\downarrow]) to set the desired value.
- Step 11.** Repeat Steps 9 and 10 to set all required equivalent circuit parameters.
- Step 12.** Press the **SIMULATE F-CHRST** key to simulate frequency characteristics.
- Step 13.** Regardless of the on/off state of the equivalent circuit diagram display function, the measurement trace is displayed on the screen. The frequency characteristics of the equivalent circuit having the set equivalent circuit parameter are simulated and displayed on the screen.

Figure 8-21

Simulation of equivalent circuit frequency characteristics (performed after the calculation in Figure 8-20)

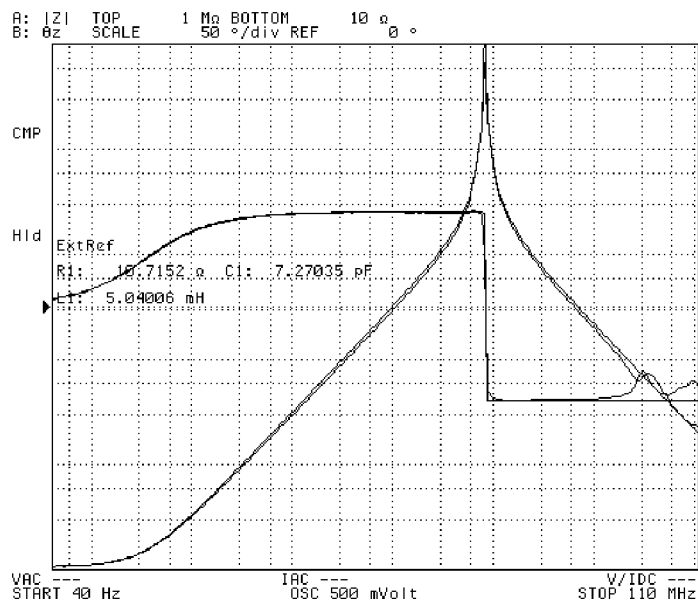

4294aoj066

NOTE

The result of simulating frequency characteristics is automatically stored in the memory trace. At the same time, the **DATA and MEMORY** keys in the Trace Definition menu (display of both measurement data and memory storage) are selected. For the Trace Definition menu, see the description of “Trace-based Comparison and Calculation” on page 179.

Display of the equivalent circuit parameter on the measurement trace screen can be turned on or off by the **PARAMETERS ON off** key (**PARAMETERS on OFF** key).

Calculating the mean value, standard deviation, and peak-to-peak of the trace

A function is provided to automatically calculate the statistics (mean value, standard deviation, and peak-to-peak value) of the trace data and display them. If the partial search function is on, statistics are calculated for the specified search range. For more information about the partial search function, refer to “Specify partial search range” on page 267.

Step 1. Activate the trace whose statistics you want to obtain.

Active Trace	Key operation
Trace A	[A]
Trace B	[B]

Step 2. Press the [Utility] key to display the Utility menu.

Step 3. Press the **STATISTICS on OFF** key to turn on the statistics display.

Softkey label	State of the trace statistics display
STATISTICS ON off	On
STATISTICS on OFF	Off

On the screen, “mean” indicates the mean value, “s.dev” the standard deviation, and “p-p” the peak-to-peak (difference between the maximum and the minimum of the measurement parameter value) of the trace.

Figure 8-22 Statistics display of trace

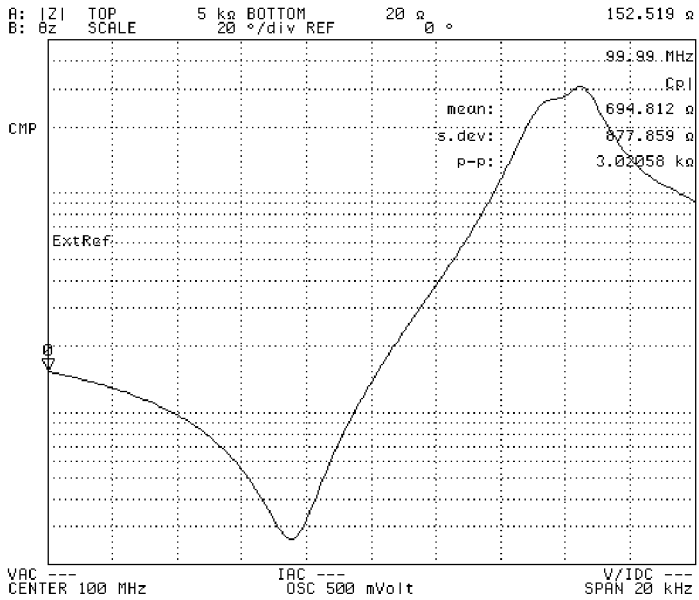

4294aoj110

NOTE

Each time a single sweep is completed, the statistics are calculated and the display is updated.

In Figure 8-22 on page 255, the trace statistics display function is used to obtain the peak-to-peak value (difference between the minimum value and the maximum value). On the other hand, in Figure 8-4 on page 220, the delta marker function is used to obtain the same parameter.

Set a limit to the trace and make pass/fail evaluation

Set a limit line (a line to indicate the upper and lower limits of the trace) to the data trace. If the measurement is within the specified range, it is evaluated as having passed the test. If not, it is evaluated as having failed the test. "PASS" appears in the limit line test result field on the screen when accepted, whereas "FAIL" appears if rejected.

Figure 8-23 Limit line test

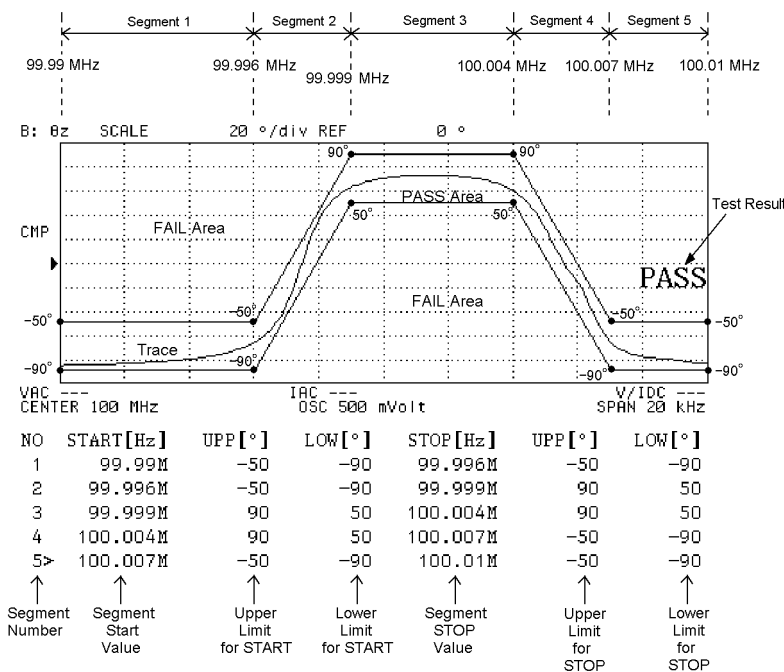

Set the limit line

Use the limit line table to set the limit line.

- Step 1.** Out of the samples subjected to the limit line test, select one standard sample that has been evaluated as passing the test. Take a measurement under the measurement conditions for setting the limit line and display the trace.

NOTE

When creating a limit line table, make sure that the setting meets the measurement conditions of conducting a limit line test.

The limit line table can be set without preparing actual samples and measuring them. However, setting it by observing the measurement waveform will make it easier to have an image of the limit line. This will facilitate your setting work.

Step 2. Activate the trace for testing the limit line.

Active Trace	Key operation
Trace A	[A]
Trace B	[B]

Step 3. Press the **[Marker]** key to display the main marker on the trace.

NOTE The limit line table can be set without displaying the marker. However, the presence of a marker will be convenient for your work because it allows the numerical value on the trace to be read and the marker position to be used to enter the limit line set value.

Step 4. Press the **[System]** key to display the System menu.

Step 5. Press the **LIMIT TEST** key to display the Limit Test menu.

Step 6. Press the **EDIT LIMIT LINE** key to invoke the limit line edit mode. This also displays the Limit Line Edit menu.

Figure 8-24 Limit line edit mode

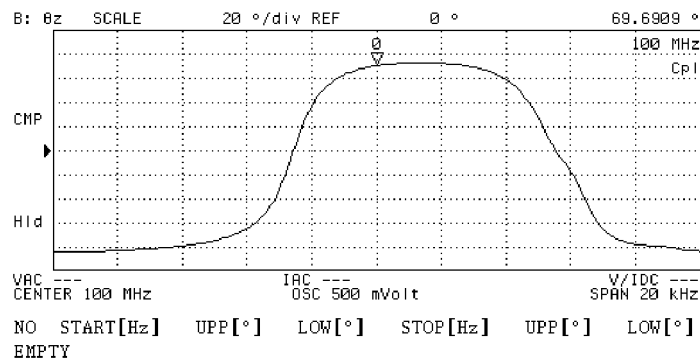

4294aoj094

Step 7. Press the **ADD** key and add a new segment to the limit line table. This also displays the Segment Edit menu. The initial value is input in advance to the segment added to the limit line table.

Step 8. Press the **START** key. The current start value of the segment is displayed in the upper left area of the screen.

Step 9. Use the keys or rotary knob of the ENTRY block in one of the following ways to specify the segment start value.

- Enter the desired value with the numeric keys ([0] to [9], [-] and [.]) and then press one of the unit keys ([G/n], [M/μ], [k/m], or [x1]).
- Turn the rotary knob (O) until the desired value is set.

Analysis and Processing of Result

Set a limit to the trace and make pass/fail evaluation

- Press the step keys ([↑][↓]) to set the desired value.

This setting allows a new start value to be written for the start value string (START) on the line of the segment being edited in the limit line table.

NOTE

Instead of directly entering the start value of the segment according to Steps 8 and 9, you may also follow the procedure below:

- (1) Press the **[Entry Off]** key.
- (2) Move the main marker to the position of the segment start value using the rotary knob (○) or the step keys ([↑][↓]).
- (3) Key operations of **more 1/3 - more 2/3 - MKR → START** allow the sweep parameter value at the position of the main marker to be substituted into the segment start value. After setting in this order, press the **more 3/3** key to go back to the first page of the Segment Edit menu.

Step 10. Press the **UPPER LIMIT** key or **MIDDLE VALUE** key. This displays the upper value or middle value of the limit range at the start point in the set parameter value field in the upper left area of the screen.

Step 11.

Set the upper or middle value by one of the following methods using the keys inside the Entry block:

- Enter the value using the numeric keys ([0] through [9], [-] and [.]) and then press a unit key ([G/n], [M/μ], [k/m], or [×1]).
- Turn the rotary knob (○) to the right or left to set the value.
- Press the step keys ([↑][↓]) to set the value.

This setting allows a new upper limit or middle value to be written for the upper value/middle value string at the start point on the line of the segment being edited in the limit line table.

NOTE

Instead of directly entering the upper or middle value of the segment according to steps 10 and 11, follow the procedure below:

- (1) Press the **[Entry Off]** key.
- (2) Move the main marker to the position of the segment start point using the rotary knob (○) or the step keys ([↑][↓]).
- (3) Key operations of **more 1/3 - more 2/3 - MKR → VALUE START** allow the measurement parameter value at the start point of the trace to be substituted into the limit range center value. After setting in this order, press the **more 3/3** to go back to the Segment Edit menu (1/3).

Step 12. Press the **LOWER LIMIT** key if the limit range was first set by the upper limit value. Press the **DELTA LIMIT** key if it was first set by the center value. The lower limit of the limit range at the start point or the differential value limit (ranges of upper limit value and lower limit value) is displayed in the set parameter value area on the upper left of the screen.

Step 13. Set the lower limit value or limit differential value by one of the following methods using the keys inside the Entry block:

- Enter the value using the numeric keys ([0] through [9], [.] and [-]) and then press a unit key ([G/n], [M/μ], [k/m], or [×1]).
- Turn the rotary knob (O) to the right or left to set the value.
- Press the step keys ([↑][↓]) to set the value.

This setting allows a new lower limit or limit differential value to be written for the lower limit/differential value string (LOWER or DELTA) of the start point on the line of the segment being edited in the limit line table.

Step 14. Operate the **more 1/3 - STOP** keys. The current stop value of the segment is displayed in the set parameter value area on the upper left of the screen.

Step 15. Use the keys or rotary knob of the ENTRY block in one of the following ways to specify the stop value.

- Enter the desired value with the numeric keys ([0] to [9], [-] and [.]) and then press one of the unit keys ([G/n], [M/μ], [k/m], or [×1]).
- Turn the rotary knob (O) until the desired value is set.
- Press the step keys ([↑][↓]) to set the desired value.

This setting allows a new stop value to be written for the stop value string (STOP) on the line of the segment being edited in the limit line table.

NOTE

Instead of directly entering the stop value of the segment according to steps 14 and 15, follow the procedure below:

- (1) Press the **[Entry Off]** key.
- (2) Move the main marker to the position of the segment stop value using the rotary knob (O) or the step keys ([↑][↓]).
- (3) Key operations of **more 2/3 - MKR Æ STOP** allow the measurement parameter value at the position of the main marker to be substituted into the segment stop over. After setting in this order, press the **more 3/3 - more 3/1** keys to go back to the Segment Edit menu (2/3).

Step 16. Press the **UPPER LIMIT** key or **MIDDLE VALUE** key. The upper limit value or middle value of the limit range at the stop point is displayed in the set parameter value field in the upper left area of the screen.

Step 17. Use the keys or rotary knob of the ENTRY block in one of the following ways to specify the upper or middle value.

- Enter the desired value with the numeric keys ([0] to [9], [-] and [.]) and then press one of the unit keys ([G/n], [M/μ], [k/m], or [×1]).
- Turn the rotary knob (O) until the desired value is set.
- Press the step keys ([↑][↓]) to set the desired value.

This setting allows a new upper limit or middle value to be written for the upper value/middle value string at the stop point on the line of the segment being edited in the limit line table.

NOTE

Instead of directly entering the stop value of the segment according to steps 16 and 17, follow the procedure below:

- (1) Press the **[Entry Off]** key.

Analysis and Processing of Result
Set a limit to the trace and make pass/fail evaluation

- (2) Move the main marker to the position of the segment stop value using the rotary knob (O) or the step keys ([↑][↓]).
- (3) Key operations of **more 1/3 - more 2/3 - MKR Æ VALUE STOP** allow the measurement parameter value at the stop point of the trace to be substituted into the limit range middle value. After setting in this order, press the **more 3/3 - more 3/1** keys to go back to the Segment Edit menu (2/3).

Step 18. After the limit range is initially set by the upper value, press the **LOWER LIMIT** key. If it is set by the middle value, press the **DELTA LIMIT** key. The lower limit of the limit range at the stop point or limit width is displayed in the set parameter value field in the upper left area of the screen.

Step 19. Use the keys or rotary knob of the ENTRY block in one of the following ways to specify the lower value or limit differential (ranges of upper limit value and lower limit value).

- Enter the desired value with the numeric keys ([0] to [9], [-] and [.]) and then press one of the unit keys ([G/n], [M/μ], [k/m], or [×1]).
- Turn the rotary knob (O) until the desired value is set.
- Press the step keys ([↑][↓]) to set the desired value.

This setting allows a new lower limit value or limit differential value to be written for the lower limit value/differential value string (LOWER or DELTA) at the stop point on the line of the segment being edited in the limit line table. If you need to turn off (make invalid) the limit line test of the segment temporarily, press **more 2/3 - TEST ON off** to change the softkey label to **TEST on OFF**.

When the limit line test of the segment is turned off, the test will be regarded as having passed even if it exceeds the limit range set by the measurement trace, and the limit line of the segment will not be displayed. When the limit line test is off, * is displayed to the right of the segment number in the completed limit line table. Note that * is not displayed when the pointer (>) is displayed to the right of the segment number.

When a new segment is added, the limit line test is ON (**TEST ON off**) as default setting.

Step 20. Press the **done** key to complete segment editing.

NOTE To suspend editing of the segment and to return to the state before editing started, press the **cancel** key.

Step 21. Repeat steps 7 to 21 to create the required number of segments. Use the following edit function if required.

Limit line table edit function	Key operation
Select the segment number (the currently selected segment is indicated by "<<" indicated to the right of the segment number (NO line).	SEGMENT - (use the ENTRY block key to enter)
Start the edit mode of the selected segment.	EDIT
Delete the selected segment (pressing the key causes deletion immediately).	DELETE

Limit line table edit function	Key operation
Add a new segment to the end of the selected segment and start the edit mode of the segment.	ADD
Delete all of the segments in the list sweep table being edited.	CLEAR LIST - yes (cancel)

Figure 8-25 Completed limit line table

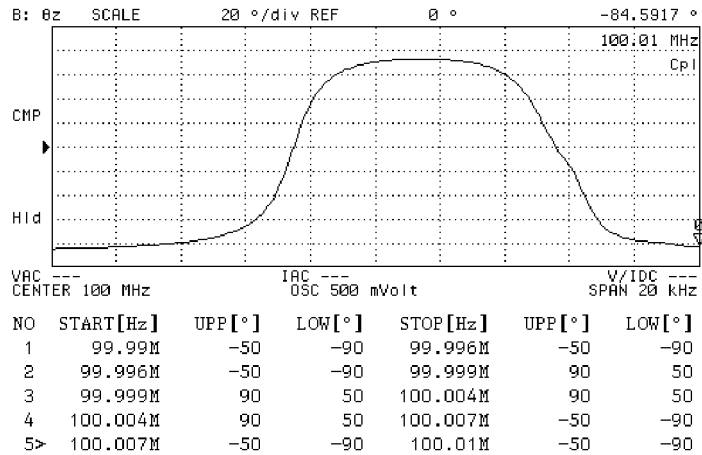

4294aoj095

NOTE

From 1 to 18 segments can be set in the limit line table.

To set the limit range of the segment when an upper value is not required, set an extremely large value that has no influence as an upper value. When a lower value is not required, set an extremely small value that has no influence as a lower value.

The limit range of each segment can be set either as a combination of upper and lower limit values or as a combination of middle and differential values. If the middle and differential value setting keys are pressed for the limit range previously set in terms of upper and lower limit values, or conversely if the upper and lower value setting keys are pressed for the limit range set in terms of middle and differential values, then the format of the limit range of the entire limit test table will be modified according to the most recently pressed keys.

When a new segment is added after the selected segment, it has the same value as that of the immediately preceding segment.

Step 22. After completion of the limit line table editing, press the **done** key of the Limit Line Edit menu. To suspend editing, press the **cancel** key. In both cases, you will return to the Limit Test menu.

NOTE

If you press the **cancel** key to suspend editing of the limit line table, you will return to the contents of the limit line table that existed before entering the edit mode.

Conduct the limit line test

After completing the limit line table, conduct the limit line test according to the following procedure.

- Step 1.** Press the **[System]** key to display the system menu.
- Step 2.** Press the **LIMIT TEST** key to display the Limit Test menu.
- Step 3.** Press the **LIMIT TEST on OFF** key to turn execute the limit line test. The set limit line will appear on the screen, and the result of the limit line test will be displayed for each sweep. (PASS denotes acceptance, while FAIL indicates rejection.)

Softkey label	Limit line test state
LIMIT TEST ON off	ON (execute)
LIMIT TEST on OFF	OFF (don't execute)

Figure 8-26 Limit line test function ON (example of acceptance by test)

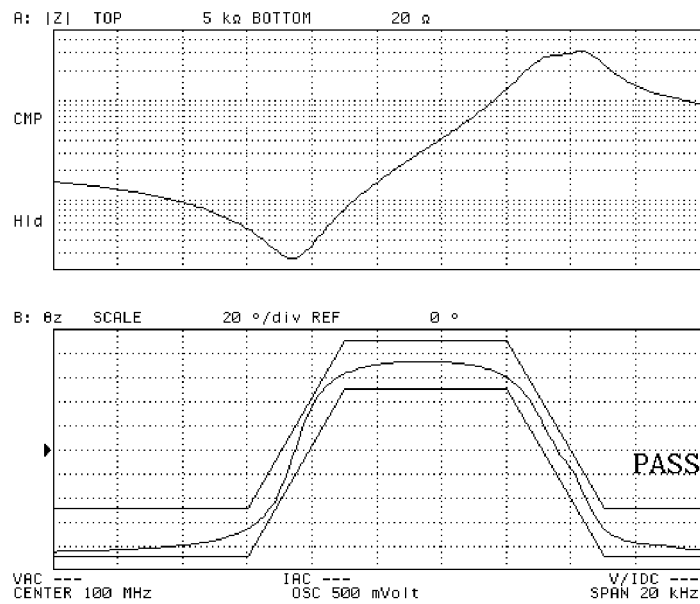

4294aoj096

Figure 8-27 Limit line test function ON (example of rejection by test)

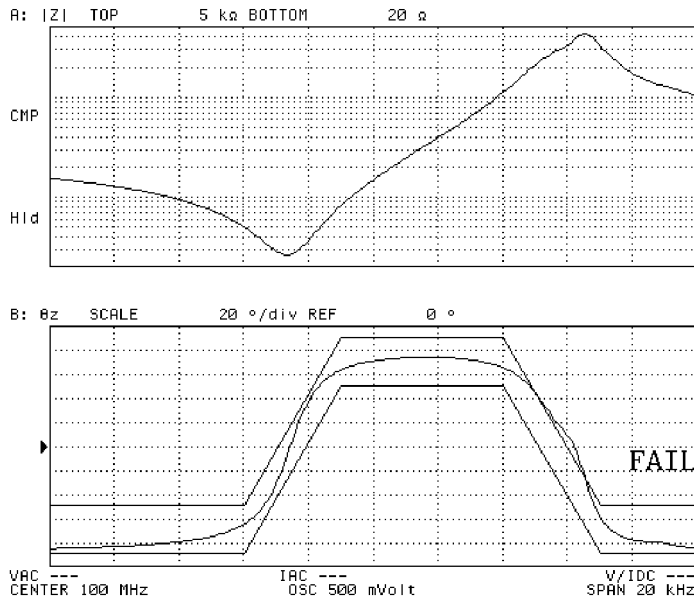

4294aoj097

NOTE

When the limit line test is turned on, the test result (pass/fail) is output as a PASS/FAIL signal through the 24-bit I/O port of the rear panel.

- Step 4.** Operate the **BEEP FAIL on OFF** (or **BEEP FAIL ON off**) key to activate a beep sound in the event that the limit line test indicates failure.

Softkey label	Beep sound when rejected
BEEP FAIL ON off	ON (beeps)
BEEP FAIL on OFF	OFF (doesn't beep)

NOTE

The limit line table can be edited with the limit line test function turned on.

If the limit line test function is turned on, the pass/fail result is indicated by the following four methods.

- “PASS” or “FAIL” is displayed in the Limit Line Test Result field on the right side of the screen.
- If the fail beep setting is On (**BEEP FAIL ON off**), a beep sounds in the event of a failure.
- If you execute the list display (**LIST VALUE** key) of the measurement parameter value (measured value) by following the procedures in “Print the measurements and settings (text)” on page 296, an asterisk “*” indicating a failure is displayed next to measurement points that exceeds the limit.

Analysis and Processing of Result
Set a limit to the trace and make pass/fail evaluation

- In the even of a failure, the limit line test fail bit of the GP-IB status byte is set to “1.”
 For more information on the GP-IB status byte, refer to *Programming Manual*.

Figure 8-28 Limit line table editing with limit line test function

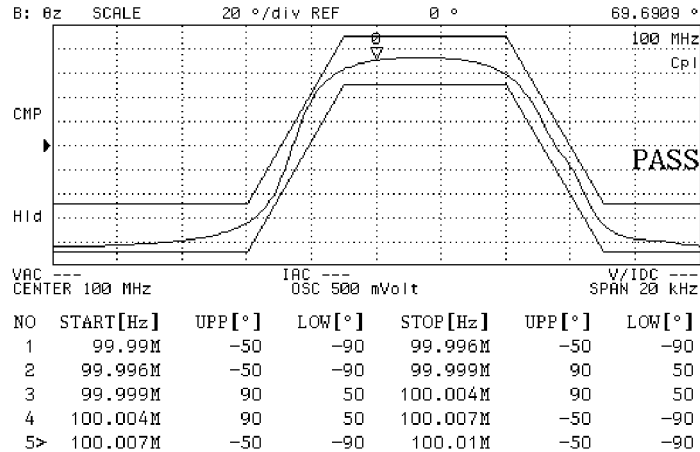

4294aaj098

Move the limit line in vertical and horizontal directions on the screen

You can set the offset of the sweep parameter value and that of the measurement parameter value for the entire limit line set in the limit line table.

When the horizontal axis represents a sweep parameter axis and the vertical axis represents a measurement parameter axis, these offsets allow the entire limit line to move in the vertical and horizontal directions. For example, this function allows the limit line to be set according to the characteristics of a particular sample to be used for other samples with different characteristics or with different measurement parameter values.

- Step 1.** Press the **[System]** key to display the System menu.
- Step 2.** Press the **LIMIT TEST** key to display the Limit Test menu.
- Step 3.** Press the **LIMIT LINE OFFSET** key to display the Limit Line Offset menu.
- Step 4.** Press the **SWP PARAM OFFSET** key to display the current sweep parameter offset value for the limit line in the set parameter value field in the upper left area of the screen.
- Step 5.** Use the keys or rotary knob of the ENTRY block in one of the following ways to specify the sweep parameter offset value.
 - Enter the desired value with the numeric keys (**[0]** to **[9]**, **[-]** and **[.]**) and then press one of the unit keys (**[G/n]**, **[M/μ]**, **[k/m]**, or **[×1]**).
 - Turn the rotary knob (○) until the desired value is set.
 - Press the step keys (**[↑]**/**[↓]**) to set the desired value.

Figure 8-29 Limit line movement by offset (+ 1 kHz)

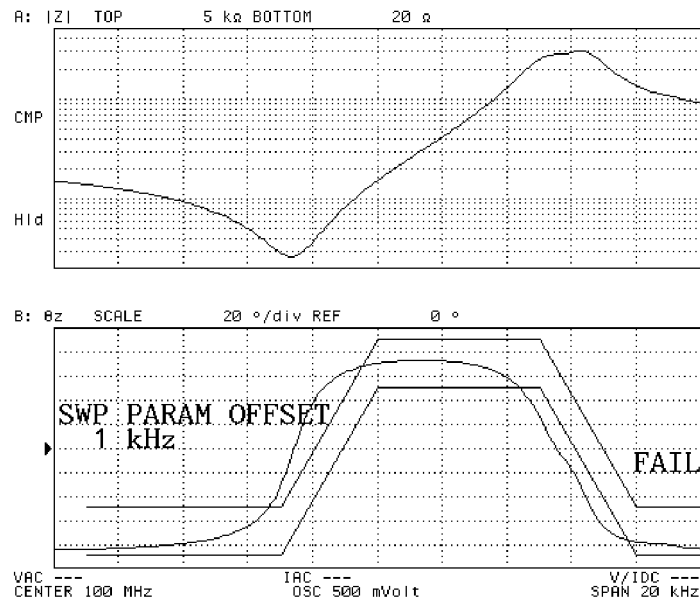

4294aoj099

- Step 6.** Press the **AMPLITUDE OFFSET** key to display the current measurement parameter offset for the limit line in the set parameter value field in the upper left area of the screen.
- Step 7.** Use the keys or rotary knob of the ENTRY block in one of the following ways to specify the measurement parameter offset value.
- Enter the desired value with the numeric keys ([0] to [9], [-] and [.]) and then press one of the unit keys ([G/n], [M/μ], [k/m], or [×1]).
 - Turn the rotary knob (O) until the desired value is set.
 - Press the step keys ([↑][↓]) to set the desired value.

Figure 8-30 Limit line movement by offset (- 10 degrees)

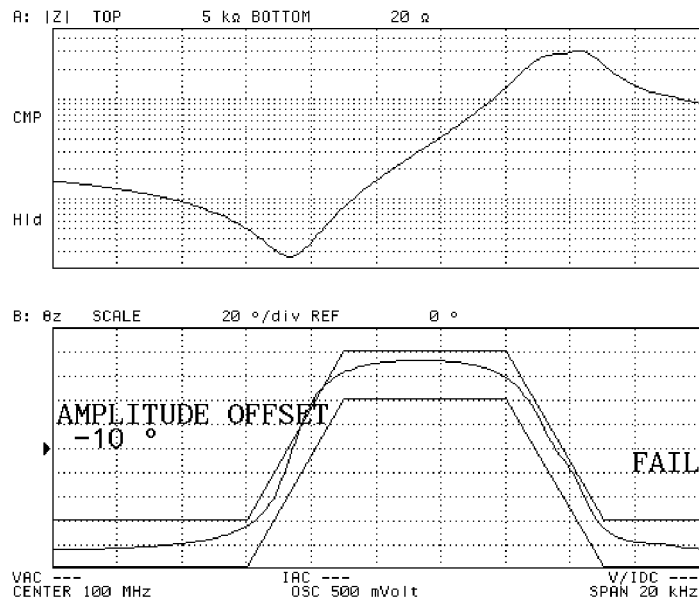

4294aoj100

NOTE

Pressing the **MKR** \rightarrow **AMP. OFST.** key allows the measurement parameter value at the main marker position to be substituted into the measurement parameter offset value of the limit line.

Specify partial search range

Under the presetting conditions, the maximum value search (**[Search] - MAX**), the minimum value search (**[Search] - MIN**), target value search (**[Search] - TARGET**), peak search (**[Search] - PEAK**) and equivalent circuit analysis (**[Display] - more 1/2 - EQUIV CKT - CALCULATE PARAMETERS**) are executed over the entire sweep range. The range to be searched can be specified by following these steps:

When sweep type is other than list sweep:

Step 1. Activate the trace in which you want to specify a partial search range.

Active Trace	Key operation
Trace A	[A]
Trace B	[B]

Step 2. Press the **[Search]** key to display the Search menu.

Step 3. Press the **SEARCH RANGE MENU** key to display the Search Range menu.

Step 4. Press the **MINIMUM** key to display the lower limit of the current partial search range in the set parameter value field in the upper left area of the screen.

Step 5. Use the keys or rotary knob of the ENTRY block in one of the following ways to specify the lower limit of the partial search range.

- Enter the desired value with the numeric keys (**[0]** to **[9]**, **[-]** and **[.]**) and then press one of the unit keys (**[G/n]**, **[M/μ]**, **[k/m]**, or **[×1]**).
- Turn the rotary knob (**○**) until the desired value is set.
- Press the step keys (**[↑]****[↓]**) to set the desired value.

Step 6. Press the **MAXIMUM** key to display the upper limit of the current partial search range in the set parameter value field in the upper left area of the screen.

Step 7. Use the keys or rotary knob of the ENTRY block in one of the following ways to specify the upper limit of the partial search range.

- Enter the desired value with the numeric keys (**[0]** to **[9]**, **[-]** and **[.]**) and then press one of the unit keys (**[G/n]**, **[M/μ]**, **[k/m]**, or **[×1]**).
- Turn the rotary knob (**○**) until the desired value is set.
- Press the step keys (**[↑]****[↓]**) to set the desired value.

Step 8. Press the **PART SRCH on OFF** key to turn on the partial search range. Then the softkey label changes to **PART SRCH ON off**. If the partial search range is turned on, two vertical lines are displayed as boundary lines on each side of the specified search range in the graph. (When the measurement parameter is COMPLEX Z-Y, the boundary lines are not shown.)

Figure 8-31 Minimum value search by turning on partial search range

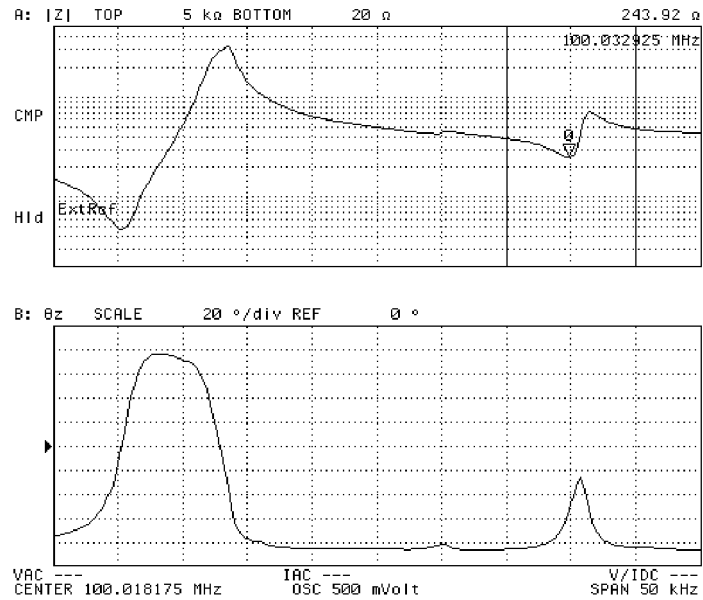

4294aoj067

NOTE

The partial search range cannot be set in excess of the preset sweep range.

If you turn on the partial search function using the **PART SRCH on OFF** key before entering the partial search range, you can set the partial search range while checking the boundary line position.

Note that you can use the marker to enter the partial search range. In this case, use the softkey displayed by **[Search] - SEARCH RANGE MENU**.

How to enter the partial search range

Key operation

Substituting the sweep parameter value of the current main marker into the lower limit of the partial search range (namely, setting the current main marker position to the lower limit of the partial search range)

MKR → MINIMUM

Substituting the sweep parameter value of the current main marker into the upper limit of the partial search range (namely, setting the current main marker position to the upper limit of the partial search range)

MKR → MAXIMUM

Setting the range between the current main marker and Δ marker to the partial search range (where the main marker and Δ marker can be either the upper or lower limit)

MKRD → SEARCH RNG

When the sweep type is list sweep:

Step 1. Activate the trace in which you want to specify a partial search range.

Active Trace	Key operation
Trace A	[A]
Trace B	[B]

Step 2. Press the [Search] key to display the Search menu.

Step 3. Press the **SEARCH RANGE MENU** key to display the Search Range menu.

Step 4. Specify the partial search range by the following key operations:

Specify the partial search range	Key operation
Full range of list sweep table	FULL
One specific segment of list sweep table (specify the segment by the following steps)	SEGMENT

Step 5. Press the **SEGMENT NUMBER** key if the partial search range was specified as one specific segment in the previous step. The set number of the current partial search segment number is displayed in the set parameter value field in the upper left area of the screen.

Step 6. Use the keys or rotary knob of the ENTRY block in one of the following ways to specify the partial search segment number.

- Enter the desired value with the numeric keys ([0] to [9]) and then press the unit key [×1].
- Turn the rotary knob (O) until the desired value is set.
- Press the step keys ([↑][↓]) to set the desired value.

NOTE

There is no key to turn on or off the partial search range in list sweep. Use the partial search function for the segment number specified by selecting the **SEGMENT** key.

Press the **RNG LINE on OFF** key located in the Search Range menu to change the soft label to **RNG LINE ON off**. This will display the partial search range boundary line in the list sweep. When the measurement parameter is COMPLEX Z-Y, however, the boundary line is not displayed.

Save and Recall the Agilent 4294A Internal Data

The Agilent 4294A supports three types of data storage devices: floppy disks, volatile memory disks, and nonvolatile memory disks (flash memory). This section describes how to save data obtained through a series of measurement processes within the Agilent 4294A into a storage device and how to recall data from the storage device.

For how to manage files (copy, delete, and so on), refer to “Managing Files” on page 305.

Agilent 4294A internal data flow

Figure 8-32

4294A internal data flow

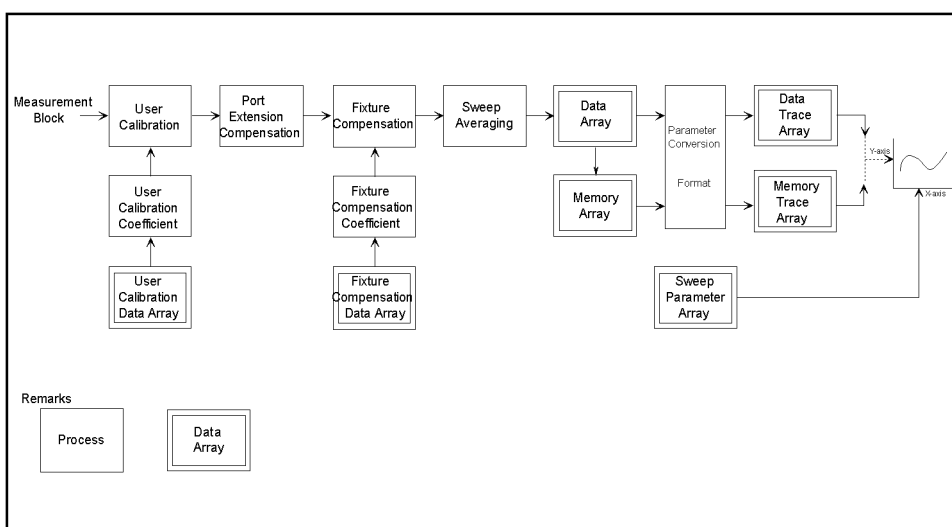

4294a0e091

Table 8-4 shows the types of internal data provided by the Agilent 4294A and the methods used to save these data.

Table 8-4 Agilent 4294A internal data and saving methods

Agilent 4294A internal data		Saving method and saved contents ¹		
		State save	Data save	Graphics save
Setting state	Settings other than those for adapter setup data ²	√		
Calibration data	User calibration data array	√	on/off	
	Fixture compensation data array	√		

Table 8-4 Agilent 4294A internal data and saving methods

Agilent 4294A internal data		Saving method and saved contents ¹		
		State save	Data save	Graphics save
Trace data	Data array (measurement data before data trace storage)		on/off	
	Memory array (measurement data before data trace storage)	√	on/off	
	Data trace array		on/off	
	Memory trace array		on/off	
Graphics	Surface screen at the time of saving			√

1. √: always saving, on/off: saving on/off selection possible
2. The adapter setup data will not be lost even if you turn off the power or execute presetting with the **[Preset]** key. The adapter setup data is maintained for each adapter selection. For how to set up adapters (adapter selection and adapter setup), refer to “Adapter Setting” on page 67.

NOTE

Before saving the calibration data (user calibration data array, fixture compensation data array) with the STATE save, you must turn on (enable) each calibration function. For how to turn on the user calibration functions, refer to “Turning User Calibration On/Off” on page 148. For how to turn on the fixture compensation function, refer to “Turning the fixture compensation on or off” on page 153.

Before saving the memory array or memory trace array with the STATE save or the DATA save, you must save the data into the memory array and memory trace array with the **DATA → MEMORY** key. For more information on using the **DATA → MEMORY** key to save data into the memory array and memory trace array, refer to “Trace-based Comparison and Calculation” on page 179.

For the each saving step, see “Save the setting state, calibration data and memory array (State Save)” on page 271, “Save the calibration data and trace data (Data Save)” on page 273, and “Saving display screen (GRAPHICS save)” on page 288.

Save the setting state, calibration data and memory array (State Save)

The following steps are used to save the setting state, calibration data (user calibration data and graphic compensation data), and memory array (memory data before being sent to the memory trace through measurement parameter conversion) except for the Agilent 4294A adapter setup data:

- Step 1.** Press the **[Save]** key to display the save menu.
- Step 2.** Press the **STORE DEV []** key to display the storage device menu.
- Step 3.** Select the Agilent 4294A storage device.

Storage device	Key operation
Floppy disk drive	FLOPPY
Volatile memory disk	MEMORY

Analysis and Processing of Result
Save and Recall the Agilent 4294A Internal Data

Storage device	Key operation
Non-volatile memory disk (flash memory)	FLASH MEMORY

NOTE

When using the floppy disk drive, make sure a disk is first inserted in the drive. If the floppy disk is set to “Write Protect,” the data cannot be saved. Set the disk to “Write Enable” before using it.

The storage device selection using **[System] - IBASIC - more 1/3 - MASS STORE []** is applicable when using the storage devices of the Agilent 4294A through the HP Instrument BASIC function. It is different from the storage device selection using the **STORE DEV []** key. However, the storage devices themselves are the same.

Step 4. Press the **return** key to return to the Save menu. The selected storage device is displayed in the box [] of the key label of the **STORE DEV []** key.

Softkey label	Selected storage device
STORE DEV [FLOPPY]	Floppy disk drive
STORE DEV [MEMORY]	Volatile memory disk
STORE DEV [FLASH]	Non-volatile memory disk (flash memory)

Step 5. Press the **STATE** key. The file name input line to save the setting state, calibration data and memory array appears in the upper left area of the screen, and the File Name Input menu is displayed.

Step 6. Enter the file name in the character string input line by using a combination of the following keys:

Key	Function
Step keys ([↑][↓])	Scrolls the input character list indicated below the character string line.
Rotary knob (○)	Horizontally moves the cursor (↑) located below the displayed character list.
SELECT LETTER or [G/n]	At the cursor (↓) of the character input line, enters the character specified by the cursor (↑) below the character list.
Numeric keys ([0] through [9] , [.] and [-])	Enter the numerical value at the cursor (↓) of the character string input line.
SPACE	Enters the space at the cursor (↓) of the character string input line.
BACK SPACE or [Back Space]	Returns the cursor (↓) of the character string input line by one character to the left and erases the character in that position.
CLEAR NAME	Erases all the character strings entered in the character string input line.

NOTE There is no need to attach an extension to the file name.

Step 7. After entering the file name in the character string input line, press the **done** key or [**×1**] key to save the file. To suspend saving, press the **cancel** key.

NOTE Steps 6 and 7 can be executed from the external keyboard connected to the rear panel. After entering the file name, press the [**Enter**] key of the keyboard to save the file. An extension [.STA] is automatically attached to the name of the file to be saved.

Save the calibration data and trace data (Data Save)

Select the required data from the four data items (data array, memory array, data trace array and memory trace array) and calibration data (user calibration data and fixture compensation data) and save them into the storage device as one file.

- Step 1.** Press the [**Save**] key to display the Save menu.
- Step 2.** Press the **STORE DEV []** key to display the Storage Device menu.
- Step 3.** Select the Agilent 4294A storage device.

Storage device	Key operation
Floppy disk drive	FLOPPY
Volatile memory disk	MEMORY
Non-volatile memory disk (flash memory)	FLASH MEMORY

NOTE When using the floppy disk drive, make sure a disk is first inserted in the drive. If the floppy disk is set to “Write Protect,” the data cannot be saved. Set the disk to “Write Enable” before using it.

The storage device selection using [**System**] - **IBASIC - more 1/3 - MASS STORE []** is applicable when using the storage devices of the Agilent 4294A through the HP Instrument BASIC function. It is different from the storage device selection using the **STORE DEV []** key. However, the storage devices themselves are the same.

Step 4. Press the **return** key to return to the Save menu. The selected storage device is displayed in the [] box of the key label of the **STORE DEV []** key.

Softkey label	Selected storage device
STORE DEV [FLOPPY]	Floppy disk drive
STORE DEV [MEMORY]	Volatile memory disk
STORE DEV [FLASH]	Non-volatile memory disk (flash memory)

- Step 5.** Press the **DATA** key to display the Data Save menu.
- Step 6.** Press the **SELECT CONTENTS** key to display the Data Contents Select menu.

Analysis and Processing of Result
Save and Recall the Agilent 4294A Internal Data

Step 7. Select the save on/off for the following data (toggle keys):

Type data saved	Softkey label
Calibration data (user calibration and fixture compensation data)	CAL ON off (ON, save) CAL on OFF (OFF, not save)
Data array (measurement data before measurement parameter conversion and data operation and transmission to data trace)	DATA ON off (ON, save) DATA on OFF (OFF, not save)
Memory array (memory data before measurement parameter conversion and data operation and transmission to memory trace)	MEMORY ON off (ON, save) MEMORY on OFF (OFF, not save)
Data trace array (data displayed on the screen as data trace)	TRACE DATA ON off (ON, save) TRACE DATA on OFF (OFF, not save)
Memory trace array (data displayed on the screen as memory trace)	TRACE MEM ON off (ON, save) TRACE MEM on OFF (OFF, not save)

Step 8. Press the **return** key to return to the Data Save menu.

Step 9. Select the key according to how you use the saved data.

How to use the saved data	Key operation
Recall on Agilent 4294A later for reuse (saved in binary format).	BINARY
Read it later as text file on PC, etc. (saved in ASCII format)	ASCII

When you have selected the key, the file name input line will appear on the screen. At the same time, the File Name Input menu will also appear.

Step 10. Enter the file name in the character string input line by using a combination of the following keys:

Key	Function
Step keys ([↑][↓])	Scrolls the input character list indicated below the character string line.
Rotary knob (○)	Horizontally moves the cursor (↑) located below the displayed character list.
SELECT LETTER or [G/n]	At cursor (␣) of the character input line, enters the character specified by the cursor (↑) below the character list.
Numeric keys ([0] through [9], [.] and [-])	Enter a numerical value at cursor (␣) of the character string input line.
SPACE	Enters a space at the cursor (␣) of the character string input line.

Key	Function
BACK SPACE or [Back Space]	Returns the cursor () of the character string input line by one character to the left and erases the character in that position.
CLEAR NAME	Erases the entire the character string entered in the character string input line.

NOTE There is no need to attach an extension to the file name.

Step 11. After entering the file name into the character string input line, press the **done** key or [**×1**] key to save the file. To suspend saving, press the **cancel** key. In both cases, you will return to the Data Save menu.

NOTE Steps 10 and 11 can be executed from the external keyboard connected to the rear panel. After entering the file name, press the [**Enter**] key of the keyboard to save the file.

The extension [.DAT] is automatically attached to the name of the file to be saved when saved in binary format, and the extension [.TXT] is automatically attached to it when saved in text (ASCII) format.

It is not possible to later recall the calibration data and trace data saved in text (ASCII) format for reuse by the Agilent 4294A.

The calibration data and trace data saved in binary format does not contain setting information such as the sweep range or number of sweep points. Accordingly, to recall the data and use it correctly on the Agilent 4294A, save the setting state using the STATE saving function.

Using files saved in the text (ASCII) format with the data save function

You can read data in files saved in the text (ASCII) format as described in “Save the calibration data and trace data (Data Save)” on page 273 using software such as a text editor on your PC (personal computer). You can also import it into the spreadsheet software for further applications. Table 8-5 shows an example of data saved in the text (ASCII) format.

Table 8-5 Example of data saved in the text (ASCII) format

```
4294A REV1.01
"DATE: Nov 1 1999"

"MEASURE PARAMETER: IMPEDANCE MAG PHASE (DEG)"
"ADAPTER: NONE"
"SWEEP TYPE: LIN FREQ"
"NUMBER of POINTS: 201"
"POINT DELAY TIME: 0 Sec"
"SWEEP DELAY TIME: 0 Sec"
"OSC LEVEL: 500 mVolt"
"DC BIAS: OFF"
"BW: 1"
"SWEEP AVERAGING: OFF"
"POINT AVERAGING: OFF"

"Cal Point: FIXED"
"Frequency""Comp[open] Real""Comp[open] Imag""Comp[short] Real""Comp[short] Imag""Comp[load]
Real""Comp[load] Imag"
4.000000000000e+012.947073e-09-1.565653e-09-6.253917e-031.008368e-035.008568e+01-3.311127e-02
.....
.....

"TRACE: A"
"FORMAT: LOG"

"Frequency" "Data Real" "Data Imag" "Data Trace Real" "Data Trace Imag"
4.000000000000e+01 1.976390e-02 5.641327e-03 2.055326e-02 0.000000e+00
.....
.....

"TRACE: B"
"FORMAT: LINEAR"

"Frequency" "Data Real" "Data Imag" "Data Trace Real" "Data Trace Imag"
4.000000000000e+01 1.976390e-02 5.641327e-03 1.593065e+01 0.000000e+00
.....
.....
```

Structure of data saved in the text format

Table 8-6 shows the structure of data saved in the text format. The data is divided into 2 sections: status block and data block. The data block is further divided into 2 parts: instrument setup part and data part.

Table 8-6 Data structure

Contents	Block name	
4294A REV1.01 <= "DATE: Nov 1 1999" <= 	Status block	
"MEASURE PARAMETER: IMPEDANCE MAG PHASE (DEG)" <= "ADAPTER: NONE" <= "SWEEP TYPE: LIN FREQ" <= "NUMBER of POINTS: 201" <= "POINT DELAY TIME: 0 Sec" <= "SWEEP DELAY TIME: 0 Sec" <= "OSC LEVEL: 500 mVolt" <= "DC BIAS: OFF" <= "BW: 1" <= "SWEEP AVERAGING: OFF" <= "POINT AVERAGING: OFF" <= 	Instrument setup part	Data block
"Cal Point: FIXED" <= <= "Frequency_" "Comp[open] Real"_"Comp[open] Imag"_"Comp[short] Real"_" "Comp[short] Imag"_"Comp[load] Real"_"Comp[load] Imag"<= 4.00000000000e+01_2.947073e-09_-1.565653e-09_-6.253917e-03_ 1.008368e-03_5.008568e+01_-3.311127e-02<= "TRACE: A" <= "FORMAT: LOG" <= "Frequency_" "Data Real"_"Data Imag"_"Data Trace Real"_"Data Trace Imag" <= 4.00000000000e+01_1.976390e-02_5.641327e-03_2.055326e-02 _0.000000e+00 <= "TRACE: B"<= "FORMAT: LINEAR"<= <= "Frequency_" "Data Real"_"Data Imag"_"Data Trace Real"_"Data Trace Imag"<= 4.00000000000e+01_1.976390e-02_5.641327e-03_1.593065e+01_ 0.000000e+00<= 	Data part	
Symbols in the table <= : Linefeed, _ : Tab		

Values and strings in a file are separated by the tab code. In Table 8-6, the tab code is

Analysis and Processing of Result
Save and Recall the Agilent 4294A Internal Data

expressed as an underscore (_). Strings including instrument setups and data array names are enclosed with double quotation marks ("). At the end of each line, the linefeed code is inserted. Table 8-6 uses the ↵ mark for the notation of a linefeed code.

Data contents of the status block

The status block stores information related to the instrument and the date when the data was saved.

Contents	Description
4294A REV1.01	ROM version of the 4294A
"DATE: Nov 1 1999"	Date when the data was saved

Data contents of the instrument setup part

The instrument setup part stores the instrument setups when the data was stored.

Contents	Description
"MEASURE PARAMETER: IMPEDANCE MAG PHASE (DEG)" ...	Measurement parameter
"ADAPTER: NONE"	Adapter setting
"SWEEP TYPE: LIN FREQ"	Sweep type
"NUMBER of POINTS: 201"	Number of measurement points
"POINT DELAY TIME: 0 Sec"	Measurement point delay time
"SWEEP DELAY TIME: 0 Sec"	Sweep delay time
"OSC LEVEL: 500 mVolt"	Signal source level
"DC BIAS: OFF"	DC bias application status
"BW: 1"	Measurement bandwidth
"SWEEP AVERAGING: OFF"	Between-sweeps averaging
"POINT AVERAGING: OFF"	Point averaging

Data contents of the data part

The data part stores calibration data (user calibration data and fixture compensation data) or trace data(data array, memory array, data trace array, and memory trace array) that you select on the data save contents selection menu.

Contents of the data part when saving the calibration data If you specify saving the calibration data on the data save contents selection menu, the calibration and compensation data obtained during the user calibration and fixture compensation are saved. The calibration and compensation data is stored as a single piece of data (calibration and compensation data) as shown in Table 8-7, instead of separately saving as the user

calibration data and the fixture compensation data.

Table 8-7 Example of calibration data saved in the data part

<pre>"Cal Point: FIXED" <= <= "Frequency" _ "Comp[open] Real" _ "Comp[open] Imag" _ "Comp[short] Real" _ "Comp[short] Imag" _ "Comp[load] Real" _ "Comp[load] Imag" <= 4.0000000000e+01_2.947073e-09_-1.565653e-09_-6.253917e-03_1.008368e-03_5.008568e+01_ -3.311127e-02 <= 4.5000000000e+01_-7.903406e-11_9.789698e-10_-4.783846e-03_-7.028686e-04_5.007061e+01_ -4.446183e-02<= 5.50000038147e+01_-1.688141e_-10-3.870845e-10_-4.990600e-03_-4.369987e-04_5.008877e+01_ -4.029654e-02<= Symbols in the table <= : Linefeed, _ : Tab</pre>

Table 8-8 shows the contents of the saved calibration data.

Table 8-8 Contents of the calibration data

Setup and data array	Description
"Cal Point: FIXED"	Setting of calibration and compensation data acquisition points
"Frequency"	Frequency points of calibration and compensation data
"Comp[open] Real"	OPEN calibration/compensation data real part
"Comp[open] Imag"	OPEN calibration/compensation data imaginary part
"Comp[short] Real"	SHORT calibration/compensation data real part
"Comp[short] Imag"	SHORT calibration/compensation data imaginary part
"Comp[load] Real"	LOAD calibration/compensation data real part
"Comp[load] Imag"	LOAD calibration/compensation data imaginary part

Data contents of the trace data (data array, memory array, data trace array, and memory trace array)

If you specify saving one of the four data items of the trace data (data array, memory array, data trace array, and memory trace array) on the data save contents selection menu, the selected data is stored in the data part for each trace (trace A and trace B). The following example describes the contents of the data part when saving one of the four data items of the trace data one by one.

Contents of the data part when saving the data array

Table 8-9 is an example of the data part when specifying saving the data array.

Table 8-9 Example of the data array data saved in the data part (part of trace A)

<pre>"TRACE: A" <= "FORMAT: LOG" <= <= "Frequency"_"Data Real"_"Data Imag" <= 4.0000000000e+01_1.976390e-02_5.641327e-03<= 2.24493714300e+06_8.738007e+00_2.715469e+02<= 4.48983428600e+06_2.407099e+01_5.634623e+02<= Symbols in the table <= : Linefeed, _ : Tab</pre>
--

Table 8-10 shows the contents of the saved data array.

Table 8-10 Contents of the trace data

Setup and data name	Description
"TRACE: A"	Type of trace
"FORMAT: LOG"	Setup of display format
"Frequency"	Measurement frequency points
"Data Real"	Data array real part
"Data Imag"	Data array imaginary part

Contents of the data part when saving the memory array

Table 8-11 is an example of the data part when specifying saving the memory array.

Table 8-11 Example of the memory array data saved in the data part (part of trace A)

<pre>"TRACE: A" <= "FORMAT: LOG" <= <= "Frequency"_"Memory Real"_"Memory Imag" <= 4.0000000000e+01_1.976390e-02_5.641327e-03<= 2.24493714300e+06_8.738007e+00_2.715469e+02<= 4.48983428600e+06_2.407099e+01_5.634623e+02<= Symbols in the table <= : Linefeed, _ : Tab</pre>
--

Table 8-12 shows the contents of the saved memory array.

Table 8-12 Contents of the memory array

Setup and data array name	Description
"TRACE: A"	Type of trace
"FORMAT: LOG"	Setup of display format
"Frequency"	Measurement frequency points
"Memory Real"	Memory array real part
"Memory Imag"	Memory array imaginary part

Contents of the data part when saving the data trace array

Table 8-13 is an example of the data part when specifying saving the data trace array.

Table 8-13 Example of the data trace array data saved in the data part (part of trace A)

<pre>"TRACE: A" <= "FORMAT: LOG" <= <= "Frequency""Data Trace Real"_"Data Trace Imag"<= 4.000000000000e+01_2.055326e-02_0.000000e+00<= 2.24493714300e+06_2.716875e+02_0.000000e+00<= 4.48983428600e+06_5.639762e+02_0.000000e+00<= Symbols in the table <= : Linefeed, _ : Tab</pre>
--

Table 8-14 shows the contents of the saved data trace array.

Table 8-14 Contents of the data trace array

Setup and data array name	Description
"TRACE: A"	Type of trace
"FORMAT: LOG"	Setup of display format
"Frequency"	Measurement frequency points
"Data Trace Real"	Data trace array real part
"Data Trace Imag"	Data trace array imaginary part

Contents of the data part when saving the memory trace array

Analysis and Processing of Result
Save and Recall the Agilent 4294A Internal Data

Table 8-15 is an example of the data part when specifying saving the memory trace array.

Table 8-15 Example of the memory trace array data saved in the data part (part of trace A)

<pre>"TRACE: A" <= "FORMAT: LOG" <= <= "Frequency"_"Memory Trace Real"_"Memory Trace Imag" <= 4.00000000000e+01_2.055326e-02_0.000000e+00 <= 2.24493714300e+06_2.716875e+02_0.000000e+00<= 4.48983428600e+06_5.639762e+02_0.000000e+00<=</pre>
Symbols in the table <= : Linefeed, _ : Tab

Table 8-16 shows the contents of the saved memory trace array.

Table 8-16 Contents of the memory trace array

Setup and data array name	Description
"TRACE: A"	Type of trace
"FORMAT: LOG"	Setup of display format
"Frequency"	Measurement frequency points
"Memory Trace Real"	Memory trace array real part
"Memory Trace Imag"	Memory trace array imaginary part

Contents of the data part when saving all data items of the trace data

Table 8-17 is an example of data when specifying saving all the four data items of the data trace (data array, memory array, data trace array, and memory trace array) on the data save contents selection menu. The four data arrays are saved as shown in Table 8-17.

Table 8-17 Example of the trace data saved in the data part (part of trace A)

<pre>"TRACE: A" <= "FORMAT: LOG" <= <= "Frequency"_"Data Real"_"Data Imag"_"Memory Real"_"Memory Imag"_"Data Trace Real"_"Data Trace Imag"_"Memory Trace Real"_"Memory Trace Imag" <= 4.00000000000e+01_1.976390e-02_5.641327e-03_1.976390e-02_5.641327e-03_2.055326e-02 _0.000000e+00_2.055326e-02_0.000000e+00 <=</pre>
Symbols in the table <= : Linefeed, _ : Tab

Data contents saved in the trace data

Depending on the specified measurement parameter, the contents saved in the trace data vary. The data array (Data Real and Data Imag) are always used to save the R and X values (data before the measurement parameter conversion or data operation). The data trace array (Data Trace Real and Data Trace Imag) is used to save the data displayed on the screen after the measurement parameter conversion and data operation, in other words, the value of the specified measurement parameter. Part with no data (indicated with - in the table) contains 0 (actually, 0.000000e+00).

Table 8-18 Specified measurement parameter and saved data

Measurement parameter	Trace A				Trace B			
	Data Real	Data Imag	Data Trace Real	Data Trace Imag	Data Real	Data Imag	Data Trace Real	Data Trace Imag
Z - θ	R	X	Z	-	R	X	θ	-
R-X	R	X	R	-	R	X	X	-
Ls-Rs	R	X	Ls	-	R	X	Rs (R)	-
Ls-Q	R	X	Ls	-	R	X	Q	-
Cs-Rs	R	X	Cs	-	R	X	Rs (R)	-
Cs-Q	R	X	Cs	-	R	X	Q	-
Cs-D	R	X	Cs	-	R	X	D	-
Y - θ	R	X	Y	-	R	X	θ	-
G-B	R	X	G	-	R	X	B	-
Lp-G	R	X	Lp	-	R	X	G	-
Lp-Q	R	X	Lp	-	R	X	Q	-
Cp-G	R	X	Cp	-	R	X	G	-
Cp-Q	R	X	Cp	-	R	X	Q	-
Cp-D	R	X	Cp	-	R	X	D	-
COMPLEX Z-Y	R	X	R	X	R	X	G	B
Z -Ls	R	X	Z	-	R	X	Ls	-
Z -Cs	R	X	Z	-	R	X	Cs	-
Z -Lp	R	X	Z	-	R	X	Lp	-
Z -Cp	R	X	Z	-	R	X	Cp	-
Z -Rs	R	X	Z	-	R	X	Rs (R)	-
Z -Q	R	X	Z	-	R	X	Q	-
Z -D	R	X	Z	-	R	X	D	-
Lp-Rp	R	X	Lp	-	R	X	Rp	-
Cp-Rp	R	X	Cp	-	R	X	Rp	-

Saving a data array in touchstone format

You can save 4294A's data array as a file in the touchstone format, based on the 1 port model, in a storage device.

- Step 1.** Press the **[Save]** key to display the save menu.
- Step 2.** Press the **STORE DEV []** key to display the storage device menu.
- Step 3.** Select one of the 4294A's storage devices.

Storage device	Key operation
Floppy disk drive	FLOPPY
Volatile memory disk	MEMORY
Nonvolatile memory disk (flash memory)	FLASH MEMORY

NOTE

When you use the floppy disk drive, insert a floppy disk into it.

You cannot save data on a floppy disk that is write-protected. Make the disk write-enabled before inserting it.

The setting of the storage device you select using **[System] - IBASIC - more 1/3 - MASS STORE []** is applied when using the 4294A's storage devices from the HP Instrument BASIC function, and it is different from the selection of the storage device using the **STORE DEV []** key here. However, the storage devices themselves are common.

- Step 4.** Press the **return** key to return to the save menu. The selected storage device is displayed in **[]** of the key label of the **STORE DEV []** key.

Softkey label	Selected storage device
STORE DEV [FLOPPY]	Floppy disk drive
STORE DEV [MEMORY]	Volatile memory disk
STORE DEV [FLASH]	Nonvolatile memory disk (flash memory)

- Step 5.** Press the **TOUCHSTONE** key to display the data save menu.
- Step 6.** Use the following keys to enter a file name in the string entry line.

Analysis and Processing of Result

Save and Recall the Agilent 4294A Internal Data

Key	Function
Step keys ([↑][↓])	Scrolls the character entry list displayed below the string entry line.
Rotary knob (○)	Moves the cursor (↑) below the displayed character list to right and left.
SELECT LETTER or [G/n]	Enters the character specified with the cursor (↑) below the character list at the position of the cursor () in the string entry line.
Numeric keys ([0] through [9] , [.] , and [-])	Enters a numeric character at the position of the cursor () in the string entry line.
SPACE	Enters a white space character at the position of the cursor () in the string entry line.
BACK SPACE or [Back Space]	Returns the cursor () in the string entry line one character left and deletes the character at the position.
CLEAR NAME	Deletes the whole of the string entered in the string entry line.

NOTE You do not need to add any extension to the file name.

Step 7. When you finish entering a file name in the string entry line, press the **done** or **[×1]** key to save the data. To cancel the saving operation, press the **cancel** key. In either case, you return to the data save menu .

NOTE You can use your external keyboard connected to the rear panel in Steps 6 and 7. After entering a file name, press the **[Enter]** key to save.

The extension ".S1P" is automatically added to the file name of the file you saved.

You cannot recall and use the data array saved in the touchstone format on the 4294A at a later time.

Using a file saved in touchstone format

You can use data in a touchstone-format file saved as described in “Saving a data array in touchstone format” on page 285 on your PC or workstation for equivalent circuit analysis and so on using a circuit simulator such as Agilent Advanced Design System (ADS). For more information on ADS, refer to the ADS's users manual.

File Structure

In the case of the HP 4294A, the data array is saved as S parameters of the 1-port model in a touchstone-format file. Table 8-19 shows an example of data saved in the touchstone format. You can read out the contents of a file with your text editor because they are text data.

Table 8-19

Example of data saved in touchstone format

<pre>#_KHZ_S_MA_R_50< 1.0000000000e-01_3.33525005034e-01_-7.73675665259e-02< 4.0000960000e+03_3.33353237003e-01_9.86914411187e-02< 8.0000920000e+03_3.33415398880e-01_1.85199186206e-01< 1.2000088000e+04_3.33583392524e-01_2.72698938847e-01< 1.6000084000e+04_3.33311851436e-01_3.00653338432e-01< 2.000080000e+04_3.33375343866e-01_3.66584867239e-01< 2.4000076000e+04_3.33422417685e-01_4.29817110300e-01< 2.8000072000e+04_3.33443503503e-01_4.86124992371e-01< 3.2000068000e+04_3.33431173499e-01_5.43855965137e-01< 3.6000064000e+04_3.33431097810e-01_5.90200841427e-01< 4.000060000e+04_3.33366487197e-01_6.40886545181e-01< 4.400056000e+04_3.33259086931e-01_6.97765290737e-01< 4.800052000e+04_3.33099293459e-01_7.51655459404e-01< 5.200048000e+04_3.32939275455e-01_8.12797546387e-01< 5.600044000e+04_3.32774633027e-01_8.78330588341e-01< 6.000040000e+04_3.32566849713e-01_9.49001610279e-01< 6.400036000e+04_3.32357601579e-01_1.02763938904e+00< 6.800032000e+04_3.32137379193e-01_1.11495888233e+00< 7.200028000e+04_3.31905989161e-01_1.20526015759e+00< 7.600024000e+04_3.31703851783e-01_1.30251085758e+00< 8.000020000e+04_3.31460080009e-01_1.41421270370e+00< 8.400016000e+04_3.31262034449e-01_1.52120709419e+00< 8.800012000e+04_3.31105522810e-01_1.64604377747e+00< 9.200008000e+04_3.30970807903e-01_1.77705621719e+00< 9.600004000e+04_3.30877281129e-01_1.91649520397e+00< 1.0000000000e+05_3.30887617271e-01_2.05756402016e+00<</pre>
<p>Symbols in the table < : return, _ : tab</p>

Now look at the structure of data saved in the touchstone format. The data can be divided into the option line and data lines.

The option line starting with "#" is placed at the beginning of the file. The structure of the option line is as follows. Table 8-20 shows the meaning of each symbol.

<Frequency unit> <Parameter> <Format> <Characteristic impedance>

Table 8-20

Structure of option line

Symbol	Description
#	Indicates that this line is the option line.
<Frequency unit>	Indicates the frequency unit. For the 4294A, it is fixed to kHz.
<Parameter>	Specifies the type of parameters in data lines. For the 4294A, "S" is specified that indicates the S parameter.
<Format>	Specifies the format. For the 4294A, "MA" is specified that indicates the format using an absolute value and phase.
<Characteristic impedance>	Specifies the characteristic impedance. For the 4294A specified is "R 50", meaning 50 Ω.

Analysis and Processing of Result
Save and Recall the Agilent 4294A Internal Data

The second and later lines are data lines. The contents of the data lines depend on the setting in the option line.

Table 8-21

Contents of data line

	Description
First column	A frequency. Its unit is kHz specified in the option line.
Second column	An absolute value of the S parameter.
Third column	A phase of the S parameter.

Saving display screen (GRAPHICS save)

You can save the screen displayed on the 4294A in the TIFF (Tagged Image File Format) format. It is useful when you want to import measurement result graphs onto software on your PC and using them.

- Step 1.** Press the **[Copy]** key to display the copy menu.
- Step 2.** Press the **SETUP** key to display the copy setup menu.
- Step 3.** Select colors.

Colors	Key operation
Black and white (default)	B&W
Using default colors	FIXED COLOR
Colors used to display the screen	IMAGE COLOR

NOTE Although menu items other than shown in the above table appear, they do not affect image files you save.

- Step 4.** Press the **[Save]** key to display the save menu.
- Step 5.** Press the **STORE DEV []** key to display the storage device menu.
- Step 6.** Select one of the storage devices used with the 4294A.

Storage device	Key operation
Floppy disk drive	FLOPPY
Volatile memory disk	MEMORY
Nonvolatile memory disk (flash memory)	FLASH MEMORY

NOTE When you use the floppy disk drive, insert a floppy disk into it.

You cannot save data on a floppy disk that is write-protected. Make the disk write-enabled before inserting it.

The setting of the storage device you select using **[System] - IBASIC - more 1/3 - MASS STORE []** is applied when using the 4294A's storage devices from the HP Instrument BASIC function, and it is different from the selection of the storage device using the **STORE DEV []** key here. However, the storage devices themselves are common.

- Step 7.** Press the **return** key to return to the save menu. The selected storage device is displayed in **[]** of the key label of the **STORE DEV []** key.

Table 8-22

Softkey label	Selected storage device
STORE DEV [FLOPPY]	Floppy disk drive
STORE DEV [MEMORY]	Volatile memory disk
STORE DEV [FLASH]	Nonvolatile memory disk (flash memory)

- Step 8.** Press the **GRAPHICS** key. The file name entry line to save the displayed screen appears and the file name entry menu also appears.

- Step 9.** Use the following keys to enter a file name in the string entry line.

Key	Function
Step keys ([↑][↓])	Scrolls the character entry list displayed below the string entry line.
Rotary knob (○)	Moves the cursor (↑) below the displayed character list to right and left.
SELECT LETTER or [G/n]	Enters the character specified with the cursor (↑) below the character list at the position of the cursor () in the string entry line.
Numeric keys ([0] through [9] , [.] , and [-])	Enters a numeric character at the position of the cursor () in the string entry line.
SPACE	Enters a white space character at the position of the cursor () in the string entry line.
BACK SPACE or [Back Space]	Returns the cursor () in the string entry line one character left and deletes the character at the position.
CLEAR NAME	Deletes the whole of the string entered in the string entry line.

NOTE You do not need to add any extension to the file name.

- Step 10.** When you finish entering a file name in the string entry line, press the **done** or **[×1]** key to execute save. To cancel the save, press the **cancel** key. In either case, you return to the save menu .

NOTE You can use your external keyboard connected to the rear panel for Steps 6 and 7. After entering a file name, press the **[Enter]** key to execute save.

Analysis and Processing of Result

Save and Recall the Agilent 4294A Internal Data

The extension ".TIF" is automatically added to the file name of the file you saved.

If you try to perform the GRAPHICS save operation for a screen such as a list sweep table and limit line table during edit with the **[Save]** key, pressing the **[Save]** key finishes the edit mode and changes the screen and you cannot save a desired display screen. In this case, do not use the **[Save]** key and send the GPIB command for save (SAVDTIF) via GPIB or LAN to the 4294A or use the get command of the FTP (File Transfer Protocol) function to acquire the screen display file "screen.tif" on the 4294A's dynamic data disk via LAN into an external computer. For how to use GPIB, LAN, and the FTP function, see "Programming Guide."

Overwrite on the file to be saved

Using the STATE, DATA and GRAPHICS save functions, you can write new data over the saved data. The contents to be saved by overwriting (STATE, DATA and GRAPHICS save) are identified by the extension attached to the name of the overwritten file. The state of selection of the contents to be saved by the DATA saving function conform to that of the file to be overwritten.

- Step 1.** Press the **[Save]** key to display the Save menu.
- Step 2.** Press the **STORE DEV []** key to display the Storage Device menu.
- Step 3.** Select the Agilent 4294A storage device.

Storage device	Key operation
Floppy disk drive	FLOPPY
Volatile memory disk	MEMORY
Non-volatile memory disk (flash memory)	FLASH MEMORY

NOTE

When using the floppy disk drive, make sure a disk is first inserted in the drive. If the floppy disk is set to "Write Protect," the data cannot be saved. Set the disk to "Write Enable" before using it.

The storage device selection using **[System] - IBASIC - more 1/3 - MASS STORE []** is applicable when using the storage devices of the Agilent 4294A through the HP Instrument BASIC function. It is different from the storage device selection using the **STORE DEV []** key here. However, the storage devices themselves are the same.

- Step 4.** Press the **return** key to return to the Save menu. The selected storage device is displayed in the **[]** box of the key label of the **STORE DEV []** key.

Softkey label	Selected storage device
STORE DEV [FLOPPY]	Floppy disk drive
STORE DEV [MEMORY]	Volatile memory disk
STORE DEV [FLASH]	Non-volatile memory disk (flash memory)

- Step 5.** Press the **RE-SAVE** key. Then the contents of the selected storage device are read and the File Select menu is displayed. The first through fourth softkey labels from the top in the

File Select menu serve as the file names and the directory name lists (first four items in alphabetical order when there are four or more files or directories) read from the selected storage device.

Step 6. When the file to be overwritten is not displayed as a softkey label, use the following method to display the file as a softkey label:

- Use the softkey of the file select menu to scroll the file/directory list of thee softkey label.

Function	Key operation
Displays the previous page of the list.	PREV FILES
Displays the next page of the list.	NEXT FILES

- To move the directory, press the softkey of the corresponding directory name.

Function	Key operation
Goes to the directory to display the file and directory names located at that position.	Directory name\
Goes to the next higher-order directory and displays the file and directory name located at that position.	..

NOTE

The directory name displayed as the softkey label is followed by “\”.

Step 7. Use the softkey to select the file to be overwritten and start overwriting.

Create a file for automatic setting when power is on

When power to the Agilent 4294A is turned on, the system is set to a state normally called “power on default setting,” which is one of the default settings.

If you save the setting (using the STATE save function) with the file name “AUTOREC.STA” in the storage device (flash memory or floppy disk), then the file is automatically read when power is turned on, and the previous setting is reproduced. The power on default setting file (AUTOREC.STA) can be created by the following steps:

- Step 1.** Set the Agilent 4294A to the state that you want to have automatically set (power on default setting) when the power is turned on.
- Step 2.** Press the **[Save]** key to display the Save menu.
- Step 3.** Press the **POWER ON CONFIG** key to display the Power On Default Setting File Save menu.
- Step 4.** Press the **yes** key to save it into the non-volatile memory disk (flash memory) of the AUTOREC.STA file. To suspend saving, press the **cancel** key. In both cases, the Save menu returns.

NOTE

If the **POWER ON CONFIG** key is used, the AUTOREC.STA file is always stored in the nonvolatile memory disk (flash memory), regardless of the selection state of the storage

device by the **STORE DEV []** key.

To store the power as a default setting file on a floppy disk, store the file in the nonvolatile memory (flash memory) once. Then copy it onto the floppy disk by using the file utility menu displayed by **[Save] - FILE UTILITIES** and key operations.

If the AUTOREC.STA file is present on both the floppy disk and the nonvolatile memory disk when the power is turned on, only the AUTOREC.STA file of the floppy disk is read.

If you only store the AUTOREC.STA file on the nonvolatile memory disk, the file will not be read when the power is turned on.

Recall the saved file

You can use the following steps to recall the data stored in the Agilent 4294A storage device according to “Save the setting state, calibration data and memory array (State Save)” on page 271 and “Save the calibration data and trace data (Data Save)” on page 273.

- Step 1.** Press the **[Recall]** key. This reads the pre-selected contents of the storage device and displays the Recall menu.
- Step 2.** Press the **STORE DEV []** key to display the Storage Device menu.
- Step 3.** Select the storage device that contains the file to be recalled.

Storage device	Key operation
Floppy disk drive	FLOPPY
Volatile memory disk	MEMORY
Non-volatile memory disk (flash memory)	FLASH MEMORY

NOTE

When using the floppy disk drive, make sure the disk is first inserted in the drive.

The storage device selection using **[System] - IBASIC - more 1/3 - MASS STORE []** is applicable when using the storage devices of the Agilent 4294A through the HP Instrument BASIC function. It is different from the storage device selection using the **STORE DEV []** key. However, the storage devices themselves are the same.

- Step 4.** Press the **return** key to return to the Recall menu. The selected storage device is displayed in the **[]** box of the key label of the **STORE DEV []** key.

Softkey label	Selected storage device
STORE DEV [FLOPPY]	Floppy disk drive
STORE DEV [MEMORY]	Volatile memory disk
STORE DEV [FLASH]	Non-volatile memory disk (flash memory)

The first through fourth softkey labels in the Recall menu serve as the file names and the directory name lists (first four items in alphabetical order when there are four or more files or directories) read from the selected storage device.

Step 5. When the file to be recalled is not displayed as a softkey label, use the following method to indicate the file as a softkey label:

- Use the softkey of the File Select menu to scroll the file/directory list of the softkey label.

Function	Key operation
Displays the previous page of the list.	PREV FILES
Displays the next page of the list.	NEXT FILES

- To move the directory, press the softkey of the corresponding directory name.

Function	Key operation
Goes to the directory to display the file and directory names located at that position.	Directory name\
Goes to the next higher-order directory and displays the file and directory name located at that position.	..^

NOTE The directory name displayed as the softkey label is followed by “\”.

Step 6. Use the softkey to recall the file and start recalling.

NOTE You cannot recall files saved in text (ASCII) format (with extension.TXT) for use on the Agilent 4294A.

Print the measurement results and internal data with a printer

Connect a printer to the printer board located on the rear panel of the Agilent 4294A. This allows you to print a graphic representation of the measurement result, a list of the measurements, and a list of setting statuses. For the printer to be used, see Table 8-23.

Table 8-23 Available Printers for the Agilent 4294A

Printer	Black & White	Fixed Color	Image Color
HP DeskJet 340J	√	√	
HP DeskJet 505 ¹	√		
HP DeskJet 506C	√	√	
HP DeskJet 694C	√	√	
HP DeskJet 850C	√	√	
HP DeskJet 870C	√	√	
HP DeskJet 880C	√	√	
HP DeskJet 895Cxi	√	√	
HP DeskJet 930C	√	√	
HP DeskJet 940C	√	√	
HP DeskJet 948C	√	√	
HP DeskJet 1200	√	√	√
HP DeskJet 1600CM	√	√	√

1. needs DeskJet 500/500C printer personality cartridge.

Set the print form (color, resolution and how to handle the paper)

Before starting to printing, set the color, resolution, margins, and landscape/portrait orientation for the paper, automatic form feed as well as the softkey/time printing by following these steps:

- Step 1.** Press the **[Copy]** key to display the Copy menu.
- Step 2.** Press the **SETUP** key to display the Copy Setup menu.
- Step 3.** Specify the print color.

Function	Key operation
Monochrome printing	B&W
Preset default color	FIXED COLOR
Printing in colors as close as possible to those on screen ¹	IMAGE COLOR

1. The printing color may differ from that on the screen owing to the limitations of the ink of your printer. For the setup procedures for color on the screen, see “Customizing Intensity and Color Settings for Screen Display” on page 207.

NOTE The background during printing is always set to white.

- Step 4.** Press the **DPI** key to display the current print resolution (dots per inch) in the set parameter value field in the upper left area of the screen.
- Step 5.** Use the keys or rotary knob of the ENTRY block in one of the following ways to specify the resolution (DPI).
- Enter the desired value with the numeric keys (**[0]** to **[9]**) and then press the unit key **[×1]**.
 - Turn the rotary knob (**○**) until the desired value is set.
 - Press the step keys (**[↑]****[↓]**) to set the desired value.

NOTE DPI can be set to an integer ranging from 75 through 600.

Printing cannot be carried out at a resolution higher than that of your printer.

- Step 6.** Press the **TOP MARGIN** key. Then the current top margin (the length of the blank area on the top of the paper) is displayed in inches in the set parameter value field in the upper left area of the screen.
- Step 7.** Use the keys or rotary knob of the ENTRY block in one of the following ways to specify the top margin (in inches).
- Enter the desired value with the numeric keys (**[0]** to **[9]** and **[.]**) and then press the unit key **[×1]**.
 - Turn the rotary knob (**○**) until the desired value is set.
 - Press the step keys (**[↑]****[↓]**) to set the desired value.

NOTE The top margin can be set in a range from 0 to 5 inches.

- Step 8.** Press the **LFT MARGIN** key. Then the current left margin (the width of the white space on the left side of the paper) is displayed in inches in the set parameter value field in the upper left area of the screen.
- Step 9.** Use the keys or rotary knob of the ENTRY block in one of the following ways to specify the left margin (in inches).
- Enter the desired value with the numeric keys (**[0]** to **[9]** and **[.]**) and then press the unit key **[×1]**.
 - Turn the rotary knob (**○**) until the desired value is set.
 - Press the step keys (**[↑]****[↓]**) to set the desired value.

NOTE The left margin can be set in a range from 0 to 5 inches.

Step 10. Press the **more 1/2** key to display the Copy Setup menu.

Step 11. Select the following Setup On/Off keys (toggle keys):

Print setup	Softkey label
Use paper in landscape orientation (horizontal) ¹	LANDSCAPE ON off (ON, print in landscape) LANDSCAPE on OFF (OFF, print in portrait)
Form feed (automatic feeding of another sheet of paper after feeding one page) ²	FORM FEED ON off (ON) FORM FEED on OFF (OFF)
Print softkey on the left side of the screen	SOFTKEY ON off (ON) SOFTKEY on OFF (OFF)
Time stamp function during printing (prints time and date at the start of printing)	TIME ON off (ON) TIME on OFF (OFF)

1. This setting is invalid if your printer does not print in landscape.
2. This cannot be set to ON if printing in landscape is set to ON.

Note

To return the setup print format to the initial default value, press the **[Copy] - DEFAULT SETTING** key.

Print the measurements in graphic representation

You can print the measurements in graphic representation by following these steps:

NOTE

Before printing, set up the print format according to “Set the print form (color, resolution and how to handle the paper)” on page 294.

Step 1. Connect the printer to the printer board of the Agilent 4294A rear panel and make the printer ready for operation.

NOTE

For information on how to make the printer ready for operation, see the printer manual.

Step 2. Display on the screen the measurement result to be printed by the printer.

Step 3. Press the **[Copy]** key to display the Copy menu.

Step 4. Press the **START** key to start printing.

NOTE

To suspend printing, press the **ABORT** key.

Print the measurements and settings (text)

You can print out measurement data and settings in a list by following these steps:

Step 1. Press the **[Copy]** key to display the Copy menu.

Step 2. Press the **SELECT CONTENTS** key to display the Copy Contents Select menu.

Step 3. Select the print contents. Then the selected print contents are displayed on the screen, and

the Copy Data menu is also indicated.

Print contents	Key operation
List of measurement parameter values (measurement values)	LIST VALUE
List of measurement conditions	OPERATING PARAMETERS
Data definition list of user calibration kit	CAL KIT VALUE
Data definition list of fixture compensation kit	COMPEN KIT VALUE
List sweep table	LIST SWEEP SEGMENTS
Limit line table	LIMIT TEST SEGMENTS

Figure 8-33

List of measurement parameter values (measurement values)

STIMULUS [Hz]	A: Z [Ω]	B: θz [°]
99.99M	184.3	-80.502
99.9901M	183.46	-80.409
99.9902M	182.62	-80.34
99.9903M	181.75	-80.261
99.9904M	180.87	-80.171
99.9905M	179.98	-80.087
99.9906M	179.1	-79.999
99.9907M	178.18	-79.907
99.9908M	177.26	-79.822
99.9909M	176.32	-79.72
99.991M	175.36	-79.622
99.9911M	174.38	-79.523
99.9912M	173.41	-79.423
99.9913M	172.42	-79.318
99.9914M	171.41	-79.215
99.9915M	170.38	-79.098
99.9916M	169.34	-78.985
99.9917M	168.27	-78.861
99.9918M	167.19	-78.745
99.9919M	166.1	-78.621
99.992M	164.98	-78.495

4294aoj091

Figure 8-34 List of measurement conditions

```

OPERATING PARAMETERS:

SWEEP PARAMETER          FREQ
SWEEP TYPE               LIN
NUMBER of POINTS        201
SWEEP DELAY TIME        0 Sec
POINT DELAY TIME        0 Sec
START                    99.99 MHz
STOP                     100.01 MHz
POINT AVG FACTOR        1
    
```

4294aoj074

Step 4. While checking the print contents displayed on the screen, select the time stamp and display/print form.

Scroll the screen to check print contents.	Key operation
Display the next page.	NEXT PAGE
Display the previous page.	PREV PAGE
Set the display/print format	Softkey label
Time stamp function during printing (printing of time and date at the start of printing)	TIME ON off (ON) TIME on OFF (OFF)
Display/print mode in the sweep range of list sweep table segment ¹	DISP MODE [STRT-STP] (Start/stop) DISP MODE [CTR-SPAN] (Center/span)
Display/print mode in the limit range of limit line table ²	DISP MODE [UPR-LWR] (Upper/lower values) DISP MODE [VAL-DLT] (Middle and differential values)
1. Only during printing of list sweep table 2. Only during printing of limit line table	

Step 5. Press the **START** key to start printing.

NOTE To suspend printing, press the **ABORT** key.

Press the **RESTORE DISPLAY** key to restore the measurement/setting list back to the normal screen.

9

Setting/Using Control and Management Functions

This section describes how to set/use the control and management functions of the Agilent 4294A Precision Impedance Analyzer that are not directly related to measurements or analysis.

Re-displaying an Instrument Message

A message displayed in the instrument message area will be overwritten by the next message displayed. Also, the message currently displayed disappears when the **[Entry Off]** key is pressed. Follow these steps to re-display and check instrument messages previously displayed.

- Step 1.** Press the **[System]** key to display the System menu.
- Step 2.** Press the **RECALL MESSAGE** key to re-display the last instrument message displayed.

The instrument messages are successively displayed in reverse chronological order when this key is pressed.

NOTE

The instrument message re-displayed by pressing the **RECALL MESSAGE** key is preceded by a number enclosed in [], which indicates the messages's position in reverse chronological order. For example, the last message displayed is preceded with [0], and the next older message with [-1].

After re-displaying a needed instrument message, the most recent instrument message can be displayed again by pressing the **[Entry Off]** key once to clear the instrument message. You can then use the above procedure to re-display any other stored message you need.

When the oldest message stored is displayed by repeatedly pressing the **RECALL MESSAGE** key, another pressing of the key returns to the first message displayed.

Up to 32 messages can be stored. However, if you turn on the power again after shutting down the device or execute presetting with the **[Preset]** key, they are deleted.

If no instrument message is stored, pressing the **RECALL MESSAGE** key displays “[0] MESSAGE EMPTY.”

You cannot save accumulated instrument messages by using the procedures described in “Save the setting state, calibration data and memory array (State Save)” on page 271.

Setting/Checking the Internal Clock

The Agilent 4294A has a built-in clock that maintains the current date and time. This internal clock is used for time stamps when outputting to a printer (printing the date and time), for recording the date and time when saving internal data or HP Instrument BASIC programs to a file, and for other functions requiring date/time recording. Follow these steps to set/check the internal clock's date, date display format, and time.

Setting/Checking the Date

- Step 1.** Press the **[System]** key to display the System menu.
- Step 2.** Press the **CLOCK** key to display the Internal Clock menu.
- Step 3.** Press the **DATE MODE []** key to select the date mode, which determines the date's display format (pressing the key toggles your selection).

Softkey label	Date mode
DATE MODE [MM/DD/YY]	Selects "2-digit number for month/2-digit number for day/4-digit number for year" as the date display format.
DATE MODE [DD/MM/YY]	Selects "2-digit number for day/2-digit number for month/4-digit number for year" as the date display format.

NOTE The date display format specified here is not applied to the dates in the file list displayed on the HP Instrument BASIC screen when the CAT command is executed.

- Step 4.** Press the **DATE** key to display the Date Configuration menu.
- Step 5.** Press the **MONTH** key. In the set parameter value field in the upper left area of the screen, a number indicating the currently set month is displayed. Below it, the currently set date (year, month, and day) is displayed in a smaller size with the date mode set in Step 3.

NOTE When you press the **DATE** key in Step 4, the same display appears in the set parameter value field as when the **MONTH** key is pressed. Therefore, you do not actually need to press the **MONTH** key here. You use the **MONTH** key when you want to change the "month" setting after executing Steps 7 through 10.

- Step 6.** Use the keys or rotary knob of the ENTRY block in one of the following ways to specify the "month."
 - Enter the desired value with the numeric keys (**[0]** to **[9]**) and then press the **[×1]** unit key.
 - Turn the rotary knob (**○**) until the desired value is set.
 - Press the step keys (**[↑]**/**[↓]**) to set the desired value.

"Month" can be set by an integer ranging from 1 through 12.

Setting/Using Control and Management Functions

Setting/Checking the Internal Clock

- Step 7.** Press the **DAY** key. In the set parameter value field in the upper left area of the screen, a number indicating the currently set day is displayed. Below it, the currently set date (year, month, and day) is displayed in a smaller size as in Step 5.
- Step 8.** Use the keys or rotary knob of the ENTRY block in one of the following ways to specify the “day.”
- Enter the desired value with the numeric keys (**[0]** to **[9]**) and then press the **[×1]** unit key.
 - Turn the rotary knob (**○**) until the desired value is set.
 - Press the step keys (**[↑]****[↓]**) to set the desired value.
- “Day” can be set to an integer ranging from 1 through 31.
- Step 9.** Press the **YEAR** key. In the set parameter value field in the upper left area of the screen, a 4-digit number indicating the currently set year is displayed. Below it, the currently set date (year, month, and day) is displayed in a smaller size as in Step 5.
- Step 10.** Use the keys or rotary knob of the ENTRY block in one of the following ways to specify the “year” as a 4-digit number.
- Enter the desired value with the numeric keys (**[0]** to **[9]**) and then press the **[×1]** unit key.
 - Turn the rotary knob (**○**) until the desired value is set.
 - Press the step keys (**[↑]****[↓]**) to set the desired value.
- “Year” can be set to an integer ranging from 1900 through 2099.
- Step 11.** Press the **done** key to save the month/day/year data set in Steps 5 through 10 in the Agilent 4294A and to return to the Internal Clock menu.

NOTE

When the **done** key is pressed, the entered value is checked for whether it is valid as an actual date. If invalid, the “CAUTION: INVALID DATE” message appears. In this case, set the correct date.

When you want to cancel the setting of the date, press the **cancel** key instead of the **done** key. The previous date setting remains without changes.

Setting/Checking the Time

- Step 1.** Press the **[System]** key to display the System menu.
- Step 2.** Press the **CLOCK** key to display the Internal Clock menu.
- Step 3.** Press the **TIME** key to display the Time Configuration menu.
- Step 4.** Press the **HOUR** key. In the set parameter value field in the upper left area of the screen, a number indicating the currently set hour is displayed. Below it, the currently set time (hour:minute:second) is displayed in a smaller size.

NOTE

When you press the **TIME** key in Step 3, the same display as when you press the **HOUR** key appears in the set parameter value field. Therefore, you do not need to press the **HOUR** key here. You use the **HOUR** key when you want to change the “hour” setting after executing

Steps 6 through 9.

Step 5. Use the keys or rotary knob of the ENTRY block in one of the following ways to specify the “hour.”

- Enter the desired value with the numeric keys ([0] to [9]) and then press the [×1] unit key.
- Turn the rotary knob (○) until the desired value is set.
- Press the step keys ([↑][↓]) to set the desired value.

“Hour” can be set to an integer ranging from 0 through 23.

Step 6. Press the **MINUTE** key. In the set parameter value field in the upper left area of the screen, a number indicating the currently set minute is displayed. Below it, the currently set time (hour:minute:second) is displayed in a smaller size as in Step 4.

Step 7. Use the keys or rotary knob of the ENTRY block in one of the following ways to specify the “minute.”

- Enter the desired value with the numeric keys ([0] to [9]) and then press the [×1] unit key.
- Turn the rotary knob (○) until the desired value is set.
- Press the step keys ([↑][↓]) to set the desired value.

“Minute” can be set to an integer ranging from 0 through 59.

Step 8. Press the **SECOND** key. In the set parameter value field in the upper left area of the screen, a number indicating the currently set second is displayed. Below it, the currently set time (hour:minute:second) is displayed in a smaller size as in Step 4.

Step 9. Use the keys or rotary knob of the ENTRY block in one of the following ways to specify the “second.”

- Enter the desired value with the numeric keys ([0] to [9]) and then press the [×1] unit key.
- Turn the rotary knob (○) until the desired value is set.
- Press the step keys ([↑][↓]) to set the desired value.

“Second” can be set to an integer ranging from 0 through 59.

Step 10. Press the **done** key to save the “hour,” “minute,” and “second” data set in Steps 4 through 9 in the Agilent 4294A and to return to the Internal Clock menu.

NOTE

When you want to cancel the setting of the time, press the **cancel** key instead of the **done** key. The previous time setting remains without changes.

Setting the Built-in Speaker (Beep Sound)

The Agilent 4294A has a built-in speaker to output beep sounds. The beep sound functions are classified into the following three groups. You can set each of them on or off.

Table 9-1

Beep functions of the Agilent 4294A

Type	Function
Completion beep	Sounds when storage of calibration or instrument states is completed.
Warning beep	Sounds when a warning message occurs.
Limit line test fail beep	Sounds when the result of a limit line test is fail.

Follow the steps below to turn on/off the completion beep and warning beep. For how to turn on/off the limit line test fail beep, refer to Step 4 in “Conduct the limit line test” on page 262.

Turning On/Off the Completion Beep

Follow these steps to turn on and off the completion beep.

- Step 1.** Press the **[System]** key to display the System menu.
- Step 2.** Press the **BEEPER** key to display the Built-In Speaker menu.
- Step 3.** Press the **BEEP DONE on OFF** key (**BEEP DONE ON off** key) to turn on/off the completion beep (pressing the key toggles your selection).

Softkey label	Setting of the completion beep
BEEP DONE ON off	On
BEEP DONE on OFF	Off

Turning On/Off the Warning Beep

Follow these steps to turn on and off the warning beep.

- Step 1.** Press the **[System]** key to display the System menu.
- Step 2.** Press the **BEEPER** key to display the Built-In Speaker menu.
- Step 3.** Press the **BEEP WARN on OFF** key (**BEEP WARN ON off** key) to turn on/off the warning beep (pressing the key toggles your selection).

Softkey label	Setting of the warning beep
BEEP WARN ON off	On
BEEP WARN on OFF	Off

Managing Files

The Agilent 4294A provides three types of data storage device: floppy disk drive, volatile memory disk, and nonvolatile memory disk (flash memory). This section describes how to manage data files with these devices.

For how to save and recall internal data, refer to “Save and Recall the Agilent 4294A Internal Data” on page 270.

Creating a Directory

The file management in the storage devices of the Agilent 4294A is based on the hierarchical tree structure used for the file systems of conventional personal computers. Follow these steps to create a “joint” in the tree structure called a directory.

- Step 1.** To create a directory on a floppy disk, insert the disk into the floppy disk drive.
- Step 2.** Press the **[Save]** key to display the Save menu.
- Step 3.** Press the **FILE UTILITIES** key to display the File Utilities menu.
- Step 4.** In [] of the **STORE DEV []** key's softkey label, the currently selected storage device is displayed.

Softkey label	Selected storage device
STORE DEV [FLOPPY]	Floppy disk drive
STORE DEV [MEMORY]	Volatile memory disk
STORE DEV [FLASH]	Nonvolatile memory disk (flash memory)

To create a directory on the currently selected storage device, proceed to Step 6.

To create a directory on a storage device other than the currently selected one, press the **STORE DEV []** key to display the Mass Storage menu.

- Step 5.** Select the storage device on which you want to create a directory.

Storage device	Key operation
Floppy disk drive	FLOPPY
Volatile memory disk	MEMORY
Nonvolatile memory disk (flash memory)	FLASH MEMORY

Pressing one of the above keys returns the display to the File Utilities menu.

- Step 6.** When a storage device is selected, the current directory (the current location in the hierarchical tree structure to store files) at that time and the amount of available space on the storage device are displayed in the upper left area of the screen. No name is assigned to the highest level directory, called the root directory, and only “\” is displayed.

To create a new directory under the current directory, proceed to Step 9.

Setting/Using Control and Management Functions

Managing Files

To create a new directory in a location other than the current directory, press the **CHANGE DIRECTORY** key to display the Filename Select menu.

- Step 7.** Use the following softkeys to move from the current directory to the directory under which you want to create a new directory.

Function	Key operation
Displays the previous page of the file/directory list.	PREV FILES
Displays the next page of the file/directory list.	NEXT FILES
Moves to the specified directory and displays the names of the files and directories under it.	Directory name\
Moves to the parent directory and displays the names of the files and directories under it.	..\

- Step 8.** Press the **return** key to return to the File Utilities menu.

- Step 9.** Press the **CREATE DIRECTORY** key to display the File Name menu.

- Step 10.** Use the following keys to enter the new directory name you want to create in the string input line.

Key	Function
Step keys ([↑][↓])	Scrolls up or down the list of available characters displayed below the text entry line.
Rotary knob(○)	Horizontally moves the cursor (↑) located below the displayed character list.
SELECT LETTER or [G/n]	At the cursor () of the string input line, enters the character specified with the cursor (↑) below the character list.
Numeric keys ([0] through [9] , [.] , [-])	Enters a numerical value at the position cursor () of the character string input line.
SPACE	Enters a space at the position cursor () of the character string input line.
BACK SPACE or [Back Space]	Moves the cursor () of the character string input line one character to the left and erases the character in that position.
CLEAR NAME	Erases everything entered in the character string input line.

NOTE

You do not have to add a backslash “\” to the end of a directory name.

- Step 11.** When you are finished entering the directory name in the string input line, press the **done** or the **[×1]** key to execute creation of the directory. To cancel creating the directory, press the **cancel** key. In either case, the screen returns to the File Utilities menu.

NOTE

You can perform Steps 10 and 11 with the external keyboard connected to the rear panel. After entering a directory name, press the **[Enter]** key on the keyboard to execute creation of the directory.

Copying a File

Follow these steps to copy (duplicate) a file stored in any storage device of the Agilent 4294A.

- Step 1.** If a copy source file is on a floppy disk or if you create a copy destination file on a floppy disk, insert this floppy disk into the floppy disk drive.
- Step 2.** Press the **[Save]** key to display the Save menu.
- Step 3.** Press the **FILE UTILITIES** key to display the File Utilities menu.
- Step 4.** Press the **COPY FILE** key to display the File Selection menu.
- Step 5.** In [] of the **STORE DEV []** key's softkey label, the currently selected storage device is displayed.

Softkey label	Selected storage device
STORE DEV [FLOPPY]	Floppy disk drive
STORE DEV [MEMORY]	Volatile memory disk
STORE DEV [FLASH]	Nonvolatile memory disk (flash memory)

If the copy source file is on the currently selected storage device, proceed to Step 7.

If the copy source file is not on the currently selected storage device, press the **STORE DEV []** key to display the Mass Storage menu.

- Step 6.** Select the storage device where the copy source file is stored.

Storage device	Key operation
Floppy disk drive	FLOPPY
Volatile memory disk	MEMORY
Nonvolatile memory disk (flash memory)	FLASH MEMORY

Pressing the key returns the display to the File Selection menu.

- Step 7.** When a storage device is selected, the current directory (the current location in the hierarchical tree structure used to store files) at that time and the amount of available space on the storage device are displayed in the upper left area of the screen. No name is assigned to the highest level directory, called the root directory, and only “\” is displayed. The four softkey labels at the top of the File Selection menu show the list of files and directories other than program files under the current directory on the storage device selected with the **STORE DEV []** key. This list is made in alphabetical order. If there are more than four files or directories, the first four are displayed.

If the copy source file is not displayed as a softkey label, follow these steps to display the

Setting/Using Control and Management Functions

Managing Files

target file as a softkey label.

- You can scroll the softkey label file/directory list by using the softkeys on the File Selection menu.

Function	Key operation
Displays the previous page of the list.	PREV FILES
Displays the next page of the list.	NEXT FILES

- To move to another directory, press the softkey of the desired directory name.

Function	Key operation
Moves to the specified directory and displays the names of the files and directories under it.	Directory name\
Moves to the parent directory and displays the names of the files and directories under it.	..\

NOTE

“\” is attached to the end of the directory name displayed as a softkey label.

- Step 8.** Press the softkey corresponding to the copy source file.

The Copy Destination Filename menu is displayed. At this time, the filename input line contains the same filename as the copy source file as the temporary copy destination filename.

- Step 9.** In [] of the **DEST DEV []** key's softkey label, the currently selected copy destination storage device is displayed.

Softkey label	Selected storage device
DEST DEV [FLOPPY]	Floppy disk drive
DEST DEV [MEMORY]	Volatile memory disk
DEST DEV [FLASH]	Nonvolatile memory disk (flash memory)

To save the copy destination file on the currently selected storage device, proceed to Step 11.

To change the currently selected copy destination storage device, press the **DEST DEV []** key to display the Copy Destination Device menu.

- Step 10.** Select the storage device in which you want to save the copy destination file.

Storage device	Key operation
Floppy disk drive	FLOPPY
Volatile memory disk	MEMORY
Nonvolatile memory disk (flash memory)	FLASH MEMORY

NOTE

Each of the following menus allows you to independently select a storage device. However, for each type of device, there is only a single device used commonly for all of the menu settings.

- The Mass Storage menu displayed by the **STORE DEV []** key.
- The Copy Destination Device menu displayed by the **DEST DEV []** key.
- The IBASIC Mass Storage menu displayed by the key operation: **[System] - IBASIC - more 1/3 - MASS STORE Åm]**.

The IBASIC Mass Storage menu manages the setting to be used for the storage devices of the Agilent 4294A through the HP Instrument Basic functions.

Pressing the key returns the display to the File Selection menu.

Step 11. When a storage device is selected, the current directory (the current location in the hierarchical tree structure used to store files) at that time and the amount of available space on the storage device are displayed on the upper left area of the screen. No name is assigned to the highest level directory, called the root directory, and only “\” is displayed. The current directory shown here is that of the storage device previously specified.

If you do not change the copy destination filename to store, proceed to Step 12.

If you want to change the filename, use the following keys to change it in the string input line.

Key	Function
Step keys ([↑][↓])	Scrolls up or down the list of available characters displayed below the text entry line.
Rotary knob (○)	Horizontally moves the cursor (↑) located below the displayed character list.
SELECT LETTER or [G/n]	At the cursor () of the string input line, enters the character specified with the cursor (↑) below the character list.
Numeric keys ([0] through [9], [.), [-])	Enters the numerical value at the position cursor () of the character string input line.
SPACE	Enters a space at the position cursor () of the character string input line.
BACK SPACE or [Back Space]	Moves the cursor () of the character string input line one character to the left and erases the character in that position.
CLEAR NAME	Erases everything entered in the character string input line.

NOTE

You do not have to add an extension to the filename.

Step 12. When you have finished entering the copy destination filename into the string input line, press the **done** or **[x1]** key to execute the save. To cancel the save, press the **cancel** key. In either case, the screen returns to the File Utilities menu.

NOTE

You can perform Steps 11 and 12 with the external keyboard connected to the rear panel. After entering the filename, press the **[Enter]** key on the keyboard to execute the save.

The same extension as that of the copy source is automatically added to the filename of the copy destination file.

Deleting a File or Directory

Follow these steps to delete a file or directory on a storage device of the Agilent 4294A.

- Step 1.** To delete a file or directory on a floppy disk, insert it into the floppy disk drive.
- Step 2.** Press the **[Save]** key to display the Save menu.
- Step 3.** Press the **FILE UTILITIES** key to display the File Utilities menu.
- Step 4.** In [] of the **STORE DEV []** key's softkey label, the currently selected storage device is displayed.

Softkey label	Selected storage device
STORE DEV [FLOPPY]	Floppy disk drive
STORE DEV [MEMORY]	Volatile memory disk
STORE DEV [FLASH]	Nonvolatile memory disk (flash memory)

To delete a file or directory on the currently selected storage device, proceed to Step 6.

To delete a file or directory on a storage device other than the currently selected one, press the **STORE DEV []** key to display the Mass Storage menu.

- Step 5.** Select the storage device from which you want to delete a file or directory.

Storage device	Key operation
Floppy disk drive	FLOPPY
Volatile memory disk	MEMORY
Nonvolatile memory disk (flash memory)	FLASH MEMORY

Pressing one of the above keys returns the display to the File Utilities menu.

- Step 6.** Press the **PURGE FILE** key to display the File Selection menu.
- Step 7.** Use the following softkeys to display the file or directory you want to delete as a softkey label.

Function	Key operation
Displays the previous page of the file/directory list.	PREV FILES
Displays the next page of the file/directory list.	NEXT FILES

Function	Key operation
Moves to the specified directory and displays the names of the files and directories under it.	Directory name\
Moves to the parent directory and displays the names of the files and directories under it.	..

Step 8. Press the softkey corresponding to the file or directory you want to delete to display the File Deletion Confirmation menu.

NOTE The File Deletion Confirmation menu will not appear if there are any files or directories under the directory you want to delete, even if you press the softkey of the directory name. Instead, the current directory is changed to the directory you specified and the files and directories under it are displayed. To delete the directory, first delete all the files and directories under it.

Step 9. Press the **yes** key to execute deleting the file or directory. To cancel the deletion, press the **cancel** key. In either case, the screen returns to the File Utilities menu.

Initializing a Recording Medium

Recording media used by the storage devices of the Agilent 4294A can be initialized (formatted) by following these steps.

NOTE Initializing a recording medium deletes all data (including filenames and directory names) currently stored in the medium.

- Step 1.** Press the **[Save]** key to display the Save menu.
- Step 2.** Press the **FILE UTILITIES** key to display the File Utilities menu.
- Step 3.** Press the **STORE DEV []** key to display the Mass Storage menu.
- Step 4.** Before initializing a floppy disk, disable its write protection feature, if applied, by moving the small tab in the corner slot of the disk to the write enabled position and then insert it into the floppy disk drive.
- Step 5.** Select the storage device corresponding to the recording medium you want to initialize.

Storage device	Key operation
Floppy disk drive	FLOPPY
Volatile memory disk	MEMORY
Nonvolatile memory disk (flash memory)	FLASH MEMORY

Step 6. If you have not pressed a key to select a storage device in Step 5, pressing the **return** key returns the display to the Save menu (if you have pressed a key to select a storage device, the display automatically returns to the Save menu).

Setting/Using Control and Management Functions

Managing Files

In [] of the **STORE DEV []** key's key label, the selected storage device is displayed.

Softkey label	Selected storage device
STORE DEV [FLOPPY]	Floppy disk drive
STORE DEV [MEMORY]	Volatile memory disk
STORE DEV [FLASH]	Nonvolatile memory disk (flash memory)

Step 7. Press the **FORMAT** key to display the Format Confirmation menu.

Step 8. Press the **yes** key to start the initialization of the medium of the specified storage device.

If you do not want to start the initialization of the medium, press the **cancel** key.

NOTE

The initialization function of the Agilent 4294A supports 3.5-inch 1.44 MB floppy disks only. The initialization is performed according to the DOS format.

Setting/Checking the GPIB

This section describes how to set or check the interface necessary to use the Agilent 4294A's GPIB (General Purpose Interface Bus). For more information on automatic measurements using the GPIB, refer to *Programming Manual*.

Switching between the System Controller Mode and Addressable-only Mode

When you use the Agilent 4294A in an GPIB system, you have to specify whether to use it as the system controller (system controller mode) or in the state where addressing is always made from other devices (addressable-only mode). Follow these steps to switch between the system controller mode and the addressable-only mode.

- Step 1.** Press the **[Local]** key to display the Local menu.
- Step 2.** Select the system controller mode or addressable-only mode with one of the following keys.

GPIB mode	Key operation
system controller mode	SYSTEM CONTROLLER
addressable-only mode	ADDRESSABLE ONLY MODE

NOTE

There should only be one system controller on a GPIB system. If there is another system controller, set this instrument to the addressable-only mode. If you try to set the Agilent 4294A as the system controller using the above key while there is another system controller, the “CAUTION: CAN'T CHANGE - ANOTHOR CONROLLER ON BUS” error message is displayed.

To pass the GPIB control from the controller to this instrument, set this instrument to the addressable-only mode in advance.

Setting/Checking the GPIB address

Follow these steps to set or check the GPIB address of this instrument.

- Step 1.** Press the **[Local]** key to display the Local menu.
- Step 2.** Press the **ADDRESS: HP-IB** key. In the set parameter value field in the upper left area of the screen, the currently set GPIB address is displayed.
- Step 3.** Use the keys or rotary knob of the ENTRY block in one of the following ways to specify the GPIB address.
 - Enter the desired value with the numeric keys (**[0]** to **[9]**) and then press the **[×1]** unit key.
 - Turn the rotary knob (**○**) until the desired value is set.
 - Press the step keys (**[↑]**/**[↓]**) to set the desired value.

The GPIB address can be set to an integer ranging from 0 through 30.

Setting/Checking the LAN

This section describes how to set or check the addresses necessary to use the Agilent 4294A's LAN (Local Area Network) functions. For more information on the use of the LAN, refer to the *Programming Manual*.

Setting/Checking the IP Address

Follow these steps to set or check the IP (Internet Protocol) address. The IP address is delimited into four parts by periods; each part is independently set.

- Step 1.** Press the **[Local]** key to display the Local menu.
- Step 2.** Press the **IP ADDRESS** key to display the IP Address Setting menu.
- Step 3.** Press the **1st** key. In the set parameter value field in the upper left area of the screen, the 1st part of the IP address (current set value) is displayed. Below it, the entire currently set IP address is displayed in a smaller size.
- Step 4.** Use the keys or rotary knob of the ENTRY block in one of the following ways to specify the 1st part of the IP address.
- Enter the desired value with the numeric keys (**[0]** to **[9]**) and then press the **[×1]** unit key.
 - Turn the rotary knob (**○**) until the desired value is set.
 - Press the step keys (**[↑]****[↓]**) to set the desired value.
- The 1st part of the IP address can be set to an integer ranging from 0 through 255.
- Step 5.** Press the **2nd** key. In the set parameter value field in the upper left area of the screen, the 2nd part of the IP address (current set value) is displayed. Below it, the entire currently set IP address is displayed in a smaller size.
- Step 6.** Use the keys or rotary knob of the ENTRY block in one of the following ways to specify the 2nd part of the IP address.
- Enter the desired value with the numeric keys (**[0]** to **[9]**) and then press the **[×1]** unit key.
 - Turn the rotary knob (**○**) until the desired value is set.
 - Press the step keys (**[↑]****[↓]**) to set the desired value.
- The 2nd part of the IP address can be set to an integer ranging from 0 through 255.
- Step 7.** Press the **3rd** key. In the set parameter value field in the upper left area of the screen, the 3rd part of the IP address (current set value) is displayed. Below it, the entire currently set IP address is displayed in a smaller size.
- Step 8.** Use the keys or rotary knob of the ENTRY block in one of the following ways to specify the 3rd part of the IP address.
- Enter the desired value with the numeric keys (**[0]** to **[9]**) and then press the **[×1]** unit key.

- Turn the rotary knob (○) until the desired value is set.
- Press the step keys ([↑][↓]) to set the desired value.

The 3rd part of the IP address can be set to an integer ranging from 0 through 255.

Step 9. Press the **4th** key. In the set parameter value field in the upper left area of the screen, the 4th part of the IP address (current set value) is displayed. Below it, the entire currently set IP address is displayed in a smaller size.

Step 10. Use the keys or rotary knob of the ENTRY block in one of the following ways to specify the 4th part of the IP address.

- Enter the desired value with the numeric keys ([0] to [9]) and then press the [×1] unit key.
- Turn the rotary knob (○) until the desired value is set.
- Press the step keys ([↑][↓]) to set the desired value.

The 4th part of the IP address can be set to an integer ranging from 0 through 255.

Step 11. Press the **done** key to store the IP address data set in Steps 3 through 10 in the Agilent 4294A and to return to the Local menu.

NOTE

When you want to cancel the setting of the IP address, press the **cancel** key instead of the **done** key. The previous IP address setting remains without changes.

Step 12. Reboot the Agilent 4294A. This will put the entered IP address into effect.

When you set the LAN addresses (IP address, gateway address, and subnet mask) at one time, you need to reboot only after the completion of all settings to put all of the LAN addresses into effect.

Setting/Checking the Gateway Address

Follow these steps to set or check the gateway address. The gateway address is delimited into four parts by periods; each part is independently set.

Step 1. Press the **[Local]** key to display the Local menu.

Step 2. Press the **GATEWAY ADDRESS** key to display the Gateway Address Setting menu.

Step 3. Press the **1st** key. In the set parameter value field in the upper left area of the screen, the 1st part of the gateway address (current set value) is displayed. Below it, the entire currently set gateway address is displayed in a smaller size.

Step 4. Use the keys or rotary knob of the ENTRY block in one of the following ways to specify the 1st part of the gateway address.

- Enter the desired value with the numeric keys ([0] to [9]) and then press the [×1] unit key.
- Turn the rotary knob (○) until the desired value is set.
- Press the step keys ([↑][↓]) to set the desired value.

The 1st part of the gateway address can be set to an integer ranging from 0 through 255.

Setting/Using Control and Management Functions

Setting/Checking the LAN

Step 5. Press the **2nd** key. In the set parameter value field in the upper left area of the screen, the 2nd part of the gateway address (current set value) is displayed. Below it, the entire currently set IP address is displayed in a smaller size.

Step 6. Use the keys or rotary knob of the ENTRY block in one of the following ways to specify the 2nd part of the gateway address.

- Enter the desired value with the numeric keys (**[0]** to **[9]**) and then press the **[×1]** unit key.
- Turn the rotary knob (**○**) until the desired value is set.
- Press the step keys (**[↑]****[↓]**) to set the desired value.

The 2nd part of the gateway address can be set to an integer ranging from 0 through 255.

Step 7. Press the **3rd** key. In the set parameter value field in the upper left area of the screen, the 3rd part of the gateway address (current set value) is displayed. Below it, the entire currently set gateway address is displayed in a smaller size.

Step 8. Use the keys or rotary knob of the ENTRY block in one of the following ways to specify the 3rd part of the gateway address.

- Enter the desired value with the numeric keys (**[0]** to **[9]**) and then press the **[×1]** unit key.
- Turn the rotary knob (**○**) until the desired value is set.
- Press the step keys (**[↑]****[↓]**) to set the desired value.

The 3rd part of the gateway address can be set to an integer ranging from 0 through 255.

Step 9. Press the **4th** key. In the set parameter value field in the upper left area of the screen, the 4th part of the gateway address (current set value) is displayed. Below it, the entire currently set gateway address is displayed in a smaller size.

Step 10. Use the keys or rotary knob of the ENTRY block in one of the following ways to specify the 4th part of the gateway address.

- Enter the desired value with the numeric keys (**[0]** to **[9]**) and then press the **[×1]** unit key.
- Turn the rotary knob (**○**) until the desired value is set.
- Press the step keys (**[↑]****[↓]**) to set the desired value.

The 4th part of the gateway address can be set to an integer ranging from 0 through 255.

Step 11. Press the **done** key to store the gateway address data set in Steps 3 through 10 in the Agilent 4294A and to return to the Local menu.

NOTE

When you want to cancel the setting of the gateway address, press the **cancel** key instead of the **done** key. The previous gateway address setting remains without changes.

Step 12. Reboot the Agilent 4294A. This will put the entered gateway address into effect.

When you set the LAN addresses (IP address, gateway address, and subnet mask) at one time, you need to cycle power only after the completion of all settings to put all of the LAN addresses into effect.

Setting/Checking the Subnet Mask

Follow these steps to set or check the subnet mask. The subnet mask is delimited into four parts by periods; each part is independently set.

- Step 1.** Press the **[Local]** key to display the Local menu.
- Step 2.** Press the **SUBNET MASK** key to display the Subnet Mask Setting menu.
- Step 3.** Press the **1st** key. In the set parameter value field in the upper left area of the screen, the 1st part of the subnet mask (current set value) is displayed. Below it, the entire currently set subnet mask is displayed in a smaller size.
- Step 4.** Use the keys or rotary knob of the ENTRY block in one of the following ways to specify the 1st part of the subnet mask.
- Enter the desired value with the numeric keys (**[0]** to **[9]**) and then press the **[×1]** unit key.
 - Turn the rotary knob (**○**) until the desired value is set.
 - Press the step keys (**[↑]**/**[↓]**) to set the desired value.

The 1st part of the subnet mask can be set to an integer ranging from 0 through 255.

- Step 5.** Press the **2nd** key. In the set parameter value field in the upper left area of the screen, the 2nd part of the subnet mask (current set value) is displayed. Below it, the entire currently set subnet mask is displayed in a smaller size.
- Step 6.** Use the keys or rotary knob of the ENTRY block in one of the following ways to specify the 2nd part of the subnet mask.
- Enter the desired value with the numeric keys (**[0]** to **[9]**) and then press the **[×1]** unit key.
 - Turn the rotary knob (**○**) until the desired value is set.
 - Press the step keys (**[↑]**/**[↓]**) to set the desired value.

The 2nd part of the subnet mask can be set to an integer ranging from 0 through 255.

- Step 7.** Press the **3rd** key. In the set parameter value field in the upper left area of the screen, the 3rd part of the subnet mask (current set value) is displayed. Below it, the entire currently set subnet mask is displayed in a smaller size.
- Step 8.** Use the keys or rotary knob of the ENTRY block in one of the following ways to specify the 3rd part of the subnet mask.
- Enter the desired value with the numeric keys (**[0]** to **[9]**) and then press the **[×1]** unit key.
 - Turn the rotary knob (**○**) until the desired value is set.
 - Press the step keys (**[↑]**/**[↓]**) to set the desired value.

The 3rd part of the subnet mask can be set to an integer ranging from 0 through 255.

- Step 9.** Press the **4th** key. In the set parameter value field in the upper left area of the screen, the 4th part of the subnet mask (current set value) is displayed. Below it, the entire currently set subnet mask is displayed in a smaller size.

Setting/Using Control and Management Functions

Setting/Checking the LAN

Step 10. Use the keys or rotary knob of the ENTRY block in one of the following ways to specify the 4th part of the subnet mask.

- Enter the desired value with the numeric keys (**[0]** to **[9]**) and then press the **[×1]** unit key.
- Turn the rotary knob (**○**) until the desired value is set.
- Press the step keys (**[↑]**/**[↓]**) to set the desired value.

The 4th part of the subnet mask can be set to an integer ranging from 0 through 255.

Step 11. Press the **done** key to store the IP address data set in Steps 3 through 10 in the Agilent 4294A and to return to the Local menu.

NOTE

When you want to cancel the setting of the subnet mask, press the **cancel** key instead of the **done** key. The previous subnet mask setting remains without changes.

Step 12. Reboot the Agilent 4294A. This will put the entered subnet mask into effect.

When you set the LAN addresses (IP address, gateway address, and subnet mask) at one time, you need to reboot only after the completion of all settings to put all of the LAN addresses into effect.

Checking the MAC Address

Follow these steps to check the MAC address.

Step 1. Press the **[System]** key to display the System menu.

Step 2. Press the **DIAGNOSTIC TEST** key to display the Self-Diagnosis menu.

Step 3. Press the **MAC ADDRESS** key. At the top of the set parameter value field in the upper left area of the screen, the MAC address, delimited by colons, is displayed.

NOTE

The MAC address is a unique address assigned to each instrument. You cannot change the MAC address.

You can check the MAC address with the sticker above the LAN port on the Agilent 4294A's rear panel. For the location of the LAN port on the rear panel, refer to "4. LAN Port" on page 51.

Checking the Firmware Version

You can check the version of the installed firmware (a built-in program to control the Agilent 4294A) by either of the following two methods.

Checking by Key Operation

- Step 1.** Press the **[System]** key to display the System menu.
- Step 2.** Press the **DIAGNOSTIC TEST** key to display the Self-Diagnosis menu.
- Step 3.** Press the **FIRMWARE REVISION** key.

This operation displays the model number, firmware version, and firmware date & time at the top of the set parameter value entry field in the upper left area of the screen.

Checking by Powering On Again

- Step 1.** Power on the Agilent 4294A again.

At power-on, the model number, firmware version, firmware date, and copyright information are displayed on the screen.

Performing Self-Diagnosis of the Agilent 4294A

The Agilent 4294A has a built-in self-test function to confirm whether it is operating normally. This self-diagnosis consists of three test groups: “internal tests,” “external tests,” and “display tests.” This section describes how to automatically execute the “internal tests” in a batch process that does not need special tools and is easy to perform. For more information on each internal test and the “external tests” and “display tests,” refer to the *Service Manual* (English).

NOTE

When executing the self-diagnosis, “Svc” appears in the instrument status area in the left-most area of the screen to indicate that the Agilent 4294A is in service mode status. If you measure a DUT in this service mode status, you cannot obtain a correct measurement result that meets the specifications. After completion of the self-diagnosis, be sure to press the **[Preset]** key or cycle power and then check that the “Svc” display is no longer displayed before performing any measurement.

Performing the Internal Tests in a Batch Process

Follow these steps to automatically perform all of the internal tests in a batch process.

- Step 1.** Press the **[System]** key to display the System menu.
- Step 2.** Press the **DIAGNOSTIC TEST** key to display the Self-Diagnosis menu. At this time, in the set parameter value field in the upper left area of the screen, the currently selected test item is displayed together with “DIAGNOSTIC TEST.”
- Step 3.** Press the **INTERNAL TEST** key to select test number 0, “All internal tests.” In the set parameter value field in the upper left area of the screen, “DIAGNOSTIC TEST 0 ALL INTERNAL” is displayed.
- Step 4.** Press the **RUN TEST** key to automatically start executing all of the internal tests.

NOTE

While the self-diagnosis is being executed, at the top of the set parameter value field the current test item that is being executed (if an error occurs as the test result, its description) is displayed in a smaller size.

Execution of all of the internal tests takes approximately one and a half minutes.

- Step 5.** When all the internal tests are completed, the test result “PASS” or “FAIL” is displayed at the right of “DIAGNOSTIC TEST 0 ALL INTERNAL” in the set parameter value field in the upper left area of the screen.

If the test fails, the Agilent 4294A may be at fault. Contact your local Agilent Technologies sales office or the company you purchased the instrument from.

Checking the Result of Each Test

You can check the result of each executed test after the batch execution of the internal tests.

- Step 1.** Press the **[System]** key to display the System menu.
- Step 2.** Press the **DIAGNOSTIC TEST** key to display the Self-Diagnosis menu. At this time, the

currently selected test item is displayed in the set parameter value field in the upper left area of the screen.

Step 3. Use the keys or rotary knob of the ENTRY block in one of the following ways to specify the test number for the item whose result you want to check.

- Enter the desired value with the numeric keys ([0] to [9]) and then press the [×1] unit key.
- Turn the rotary knob (○) until the desired value is set.
- Press the step keys ([↑][↓]) to set the desired value.

The desired test result is displayed at the right of the test number and test item in the set parameter value field in the upper left area of the screen.

NOTE

The power-on self-test automatically executed at power-on is a partial execution of the “internal tests.” You can also check the result of each test in the power-on self-test by entering its test number as described above.

Specifications and Supplemental Performance Characteristics
Basic Characteristics

Specifications describe the instrument's warranted performance over the temperature range of 0°C to 40°C (except as noted). Supplemental performance characteristics are intended to provide information that is useful for applying non-warranted performance parameters to the instrument. Such parameters are denoted as SPC (supplemental performance characteristics), typical, or nominal. Warm-up time must at least 30 minutes after power-on for all specifications.

Basic Characteristics

Measurement Parameter

Impedance Parameters	$ Z $ - θ , R-X, Ls-Rs, Ls-Q, Cs-Rs, Cs-Q, Cs-D, $ Y $ - θ , G-B, Lp-G, Lp-Q, Cp-G, Cp-Q, Cp-D, Complex Z-Y, $ Z $ -Ls, $ Z $ -Cs, $ Z $ -Lp, $ Z $ -Cp, $ Z $ -Rs, $ Z $ -Q, $ Z $ -D, Lp-Rp, Cp-Rp
----------------------	--

Measurement Terminal

Configuration	Four-terminal pair configuration
Connector type	Four BNC (female) connectors. Can be converted to one-port terminal using the 42942A Terminal Adapter (7-mm port) or the 42941A Impedance Probe (3.5-mm port).

Source Characteristics

Frequency

Range	40 Hz to 110 MHz
Resolution	1 mHz
Accuracy	
without Option 1D5	± 20 ppm (at $23 \pm 5^\circ\text{C}$) ± 40 ppm (at 0 to 55°C)
with Option 1D5	± 0.13 ppm (at 0 to 55°C)

Voltage Signal Level

Range	5 mVrms to 1 Vrms
Resolution	1 mV
Accuracy	

at four-terminal pair port of the 4294A or 7-mm port of the 42942A	$\pm [(10 + 0.05 \times f)\% + 1 \text{ mV}]$ (at $23 \pm 5^\circ\text{C}$)
at measurement port of the 42941A, 16048G/H	$\pm [(15 + 0.1 \times f)\% + 1 \text{ mV}]$ (at $23 \pm 5^\circ\text{C}$)

NOTE

f: frequency [MHz].
 These characteristics apply when an OPEN is connected to each port.
 Test signal level should be $\pm 0.5 \text{ V}_{\text{rms}}$ when the measured impedance is $\pm 50 \text{ W}$.
 Beyond a temperature of $23 \pm 5^\circ\text{C}$, the test signal level setting accuracy decreases to half the value described.

Current Signal Level

Range	200 μArms to 20 mArms
Resolution	20 μA
Accuracy	
at four-terminal pair port of the 4294A	
at $\leq 15 \text{ MHz}$	$+ [10\% + 50 \mu\text{A}], - [(10 + 0.2 \times f^2)\% + 50 \mu\text{A}]$ (at $23 \pm 5^\circ\text{C}$, typical)
at $> 15 \text{ MHz}$	$\pm [(10 + 0.3 \times f)\% + 50 \mu\text{A}]$ (at $23 \pm 5^\circ\text{C}$, typical)
at 7-mm port of the 42942A	
at $\leq 5 \text{ MHz}$	$+ [10\% + 50 \mu\text{A}], - [(10 + 1 \times f^2)\% + 50 \mu\text{A}]$ (at $23 \pm 5^\circ\text{C}$, typical)
at $> 5 \text{ MHz}$	$\pm [(10 + 0.3 \times f)\% + 50 \mu\text{A}]$ (at $23 \pm 5^\circ\text{C}$, typical)
at measurement port of the 42941A, 16048G/H	
at $\leq 5 \text{ MHz}$	$+ [10\% + 50 \mu\text{A}], - [(15 + 1.5 \times f^2)\% + 50 \mu\text{A}]$ (at $23 \pm 5^\circ\text{C}$, typical)
at $> 5 \text{ MHz}$	$\pm [(20 + 0.3 \times f)\% + 50 \mu\text{A}]$ (at $23 \pm 5^\circ\text{C}$, typical)

NOTE

f: frequency [MHz].
 These characteristics apply when a SHORT is connected to each port.
 Test signal level should be $\pm 20 \text{ mArms}$ when the measured impedance is $\pm 50 \text{ W}$.

Signal Level Monitor

Voltage range	(same as the voltage signal level setting range)
Voltage monitor accuracy	
at four-terminal pair port of the 4294A or 7-mm port of the 42942A	$\pm (10 + 0.05 \times f + 100/Z_x)$ [%] (at $23 \pm 5^\circ\text{C}$, typical)
at measurement port of the 42941A, 16048G/H	$\pm (10 + 0.15 \times f + 100/Z_x)$ [%] (at $23 \pm 5^\circ\text{C}$, typical)
Current range	(same as the current signal level setting range)
Current monitor accuracy	
at four-terminal pair port of the 4294A or 7-mm port of the 42942A	$\pm (10 + 0.3 \times f + Z_x/100)$ [%] (at $23 \pm 5^\circ\text{C}$, typical)
at measurement port of the 42941A, 16048G/H	$\pm (10 + 0.4 \times f + Z_x/100)$ [%] (at $23 \pm 5^\circ\text{C}$, typical)

NOTE

f : frequency [MHz], Z_x : impedance measurement value [W].
 Beyond $23 \pm 5^\circ\text{C}$, the test signal level monitor accuracy decreases to half the value described.

Output Impedance

Output impedance	25 Ω (nominal)
------------------	-----------------------

dc Bias Function

dc voltage bias	
Range	0 to ± 40 V (see Figure 10-1)
Resolution	1 mV
Accuracy	$\pm [0.1\% + (5 + 30 \times I_{mon}) \text{ mV}]$ (at $23 \pm 5^\circ\text{C}$) $\pm [0.2\% + (10 + 30 \times I_{mon}) \text{ mV}]$ (beyond $23 \pm 5^\circ\text{C}$)
dc current bias	
Range	0 to ± 100 mA (see Figure 10-1)
Resolution	40 μA
Accuracy	$\pm [2\% + (0.2 + V_{mon} /20) \text{ mA}]$ (at $23 \pm 5^\circ\text{C}$) $\pm [4\% + (0.4 + V_{mon} /10) \text{ mA}]$ (beyond $23 \pm 5^\circ\text{C}$)
dc voltage bias at constant voltage mode	

Range	0 to ± 40 V (see Figure 10-1)
Resolution	1 mV
Accuracy	$\pm [0.5\% + (5 + Z_d \times I_{mon}) \text{ mV}]$ (at $23 \pm 5^\circ\text{C}$, typical) $\pm [1.0\% + (10 + Z_d \times I_{mon}) \text{ mV}]$ (beyond $23 \pm 5^\circ\text{C}$, typical)
dc current bias at constant current mode	
Range	0 to ± 100 mA (see Figure 10-1)
Resolution	40 μA
Accuracy	$\pm [1\% + (0.5 + V_{mon} /10000) \text{ mA}]$ (at $23 \pm 5^\circ\text{C}$, typical) $\pm [2\% + (1.0 + V_{mon} /5000) \text{ mA}]$ (beyond $23 \pm 5^\circ\text{C}$, typical)
dc bias monitor	
dc voltage range	(same as the dc voltage bias setting range)
dc voltage accuracy	$\pm [0.2\% + (5 + Z_d \times I_{mon}) \text{ mV}]$ (at $23 \pm 5^\circ\text{C}$) $\pm [0.4\% + (10 + Z_d \times I_{mon}) \text{ mV}]$ (beyond $23 \pm 5^\circ\text{C}$)
dc current range	(Same as the dc current bias setting range)
dc current monitor accuracy	$\pm [1\% + (0.5 + V_{mon} /10000) \text{ mA}]$ (at $23 \pm 5^\circ\text{C}$) $\pm [2\% + (1.0 + V_{mon} /5000) \text{ mA}]$ (beyond $23 \pm 5^\circ\text{C}$)
Output impedance	25 Ω (nominal)

NOTE

V_{mon} : dc voltage bias monitor reading value [mV]
 I_{mon} : dc current bias monitor reading value [mA]
 $Z_d = 0.3$ (at four-terminal pair port of the 4294A, adapter setup: NONE)
 $Z_d = 2.0$ (at 3.5 mm port of the 42941A, adapter setup: 42941A Impedance Probe)
 $Z_d = 0.5$ (at 7-mm port of the 42942A, adapter setup: 42942A Terminal Adapter)
 $Z_d = 1.0$ (at measurement port of the 16048G, adapter setup: four-terminal pair 1m)
 $Z_d = 1.5$ (at measurement port of the 16048H, adapter setup: four-terminal pair 2m)

Figure 10-1

dc Bias Range (SPC)

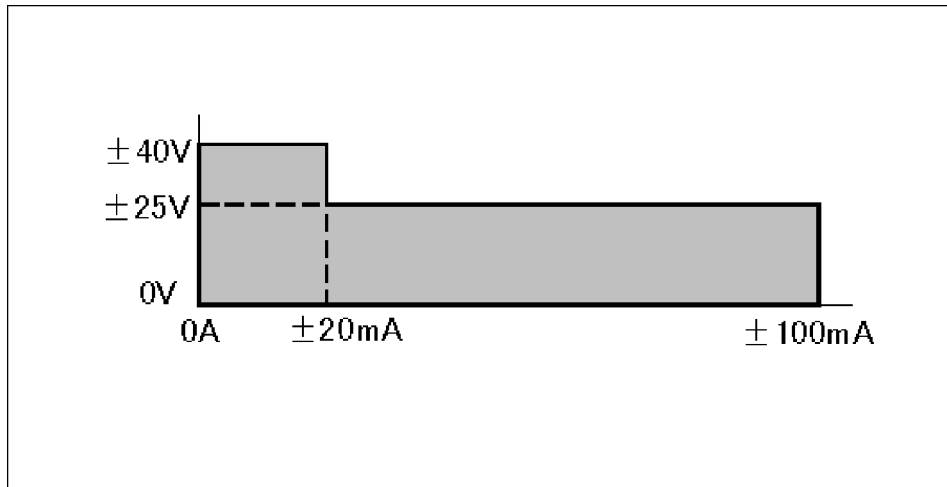

4294a0e008

Sweep Characteristics

Available sweep parameters	Frequency, signal voltage, signal current, dc bias voltage, dc bias current
Sweep types	Linear, log ¹ , list ¹ , zero-span, manual
Manual sweep	Available for all sweep types
Sweep directions	Up-sweep, down-sweep
Number of measurement points	2 to 801
List Sweep	
Available setup parameters for each segment	Sweep frequency range, number of measurement points, signal level (voltage or current), dc bias (voltage or current), measurement bandwidth, point averaging factor
Number of segments	1 to 18
Sweep span types	Segment span, single span
Delay time	
Types	Point delay, sweep delay
Range	0 to 30 sec
Resolution	1 msec

1. Frequency sweep only.

Measurement Time

Figure 10-2

Measurement Time (SPC)

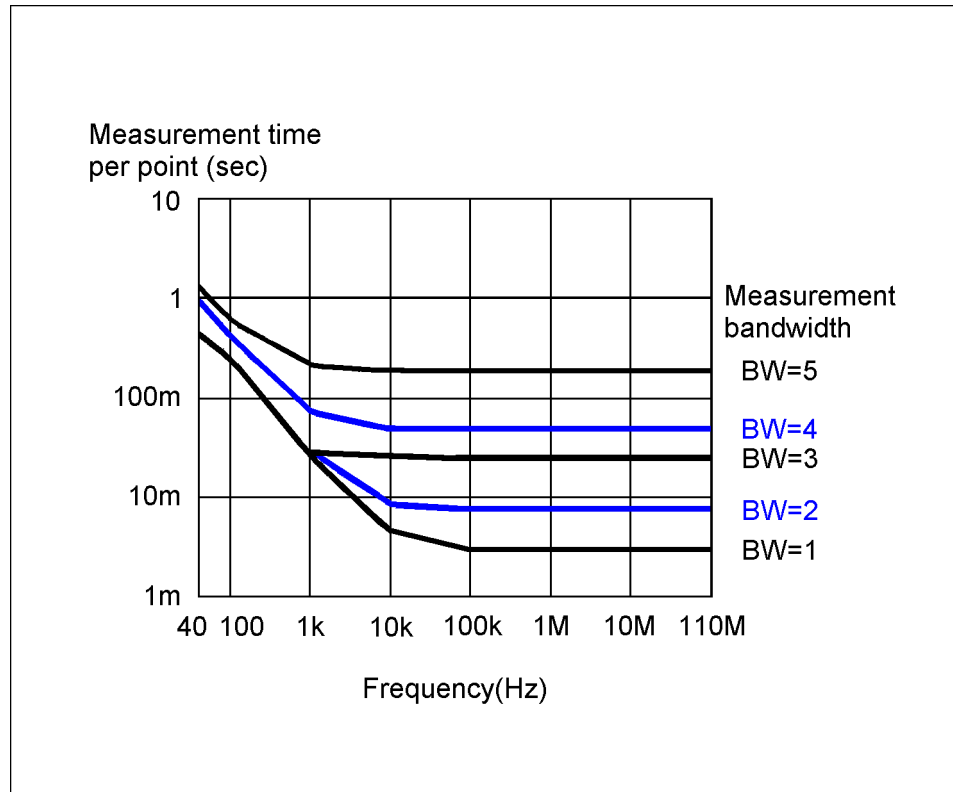

4294a0e005

NOTE

When the 42941A Impedance Probe or the 42942A Terminal Adapter is used, measurement time is 1.5 times longer than the value shown in Figure 10-2.

Trigger Function

Trigger types	Continuous, single, number of groups
Trigger sources	Internal (free run), external (BNC connector input), GP-IB or LAN, manual (front key)
Trigger event types	Point trigger, sweep trigger

Measurement Bandwidth/Averaging

Measurement bandwidth	
Range	1 (Fast) to 5 (Precise), 5 steps
Averaging	
Types	Sweep-to-sweep averaging, point averaging

Specifications and Supplemental Performance Characteristics
Basic Characteristics

Averaging factor	1 to 256 (integer)
------------------	--------------------

Adapter Setup

Adapter Selection	
NONE	No adapter (the 16047E or other direct connection type test fixture) is connected
4TP 1M	Four-terminal pair 1 m (16048G)
4TP 2M	Four-terminal pair 2 m (16048H)
7-mm 42942A	Terminal Adapter (42942A)
PROBE 42941A	Impedance Probe (42941A)

Calibration

Calibration	
User calibration	Calibration performed with user-defined calibration kit (OPEN, SHORT, LOAD)
Port extension	Compensation performed when the measurement terminal is expanded from the 7-mm connector of the 42942A Terminal Adapter or the 3.5-mm connector of the 42941A Impedance Probe. Enter electrical length or delay time for the extension.
Fixture compensation	Compensation performed at the device contacts of the test fixture using OPEN, SHORT, LOAD.
Calibration points	Fixed points or user points determined by sweep setups

Measurement Accuracy

Accuracy Specifications

Temperature	
Four-terminal pair port of the 4294A's front panel	23 ± 5°C Beyond 23 ± 5°C, the measurement accuracy decreases to half the value described.
7-mm port of the 42942A Terminal Adapter	Within ± 5°C from the adapter setup temperature. Measurement accuracy applies when the adapter setup is performed at 23 ± 5°C. When the adapter setup is performed beyond 23 ± 5°C, the measurement accuracy decreases to half the value described.

3.5-mm port of the 42941A Impedance Probe	Within $\pm 5^\circ\text{C}$ from the adapter setup temperature. Measurement accuracy applies when the adapter setup is performed at $23 \pm 5^\circ\text{C}$. When the adapter setup is performed beyond $23 \pm 5^\circ\text{C}$, the measurement accuracy decreases to half the value described.
Measurement terminal of the 16048G or 16048H	Within $\pm 5^\circ\text{C}$ from the adapter setup temperature. Measurement accuracy applies when the adapter setup is performed at $23 \pm 5^\circ\text{C}$. When the adapter setup is performed beyond $23 \pm 5^\circ\text{C}$, the measurement accuracy decreases to half the value described.
Measurement bandwidths	5

Measurement Accuracy

$ Z , Y $ accuracy	$\pm E$ [%] (see Equation 10-1 on page 332, Equation 10-2 on page 335, Equation 10-3 on page 337)
θ accuracy	$\pm E/100$ [rad]
L, C, X, B accuracy	
at $D_x \leq 0.1$	$\pm E$ [%]
at $D_x > 0.1$	$\pm E \times \sqrt{1 + D_x^2}$ [%]
R accuracy	
at $D_x \leq 0.1$ ($Q_x \geq 10$)	Rp: $\pm \frac{E}{D_x \mp E/100}$ [%] Rs: $\pm E/D_x$ [%]
at $0.1 < D_x < 10$ ($0.1 < Q_x < 10$)	Rp: $\pm E \times \frac{\sqrt{1 + D_x^2}}{D_x \mp \frac{E}{100} \times \sqrt{1 + D_x^2}}$ [%] Rs: $\pm E \times \frac{\sqrt{1 + D_x^2}}{D_x}$ [%]
at $D_x \geq 10$ ($Q_x \leq 0.1$)	$\pm E$ [%]
D accuracy	
at $D_x \leq 0.1$	$\pm E/100$
at $0.1 < D_x \leq 1$	$\pm E \times (1 + D_x)/100$
Q accuracy (at $Q_x \times D_a < 1$)	

Specifications and Supplemental Performance Characteristics
Basic Characteristics

at $Q_x \leq 10$ ($D_x \geq 0.1$)	$\pm \frac{Q_x^2 \times E(1 + D_x)/100}{1 \mp Q_x \times E(1 + D_x)/100}$
at $Q_x > 10$ ($D_x < 0.1$)	$\pm \frac{Q_x^2 \times E/100}{1 \mp Q_x \times E/100}$
G accuracy	
at $D_x > 0.1$	$\pm E \times \frac{\sqrt{1 + D_x^2}}{D_x}$ [%]
at $D_x \leq 0.1$	$\pm E/D_x$ [%]

NOTE

D_x : measurement value of D.
 Q_x : measurement value of Q.
 D_a : measurement accuracy of D.

Impedance Measurement Accuracy at Four-terminal Pair Port

Equation 10-1 shows the impedance measurement accuracy [%] at the four-terminal pair port of the Agilent 4294A or at the measurement port of the 16048G, 16048H.

Equation 10-1

Impedance Measurement Accuracy [%] at four-terminal pair port

$$E = E_P' + \left(\frac{Z_S'}{|Z_X|} + Y_O' \cdot |Z_X| \right) \times 100$$

Where,

$$E_P' = E_{PL} + E_{PBW} + E_{POSC} + E_P \text{ [%]}$$

$$Y_O' = Y_{OL} + K_{BW} \times K_{YOSC} \times (Y_{ODC} + Y_O) \text{ [S]}$$

$$Z_S' = Z_{SL} + K_{BW} \times K_{ZOSC} \times Z_S \text{ [W]}$$

Y_O , E_P , Z_S : see Figure 10-3 on page 340.

E_{posc} [%] =	
at oscillator level > 500 mV	$0.03 \times \left(\frac{1000}{V_{mV}} - 1 \right) + \frac{f}{100}$
at oscillator level > 250 mV, ≤ 500 mV	$0.03 \times \left(\frac{500}{V_{mV}} - 1 \right)$
at oscillator level > 125 mV, ≤ 250 mV	$0.03 \times \left(\frac{250}{V_{mV}} - 1 \right)$

at oscillator level > 64 mV, ≤ 125 mV	$0.03 \times \left(\frac{125}{V_{mV}} - 1 \right)$
at oscillator level ≤ 64 mV	$\left(\frac{64}{V_{mV}} - 1 \right) \times (0.03 + E_{PBW})$
$Ky_{osc} =$	
at oscillator level > 500 mV	$\frac{1000}{V_{mV}}$
at oscillator level ≤ 500 mV	$\frac{500}{V_{mV}}$
$Kz_{osc} =$	
at oscillator level > 500 mV	2
at oscillator level > 250 mV, ≤ 500 mV	$\frac{500}{V_{mV}}$
at oscillator level > 125 mV, ≤ 250 mV	$\frac{250}{V_{mV}}$
at oscillator level > 64mV, ≤ 125 mV	$\frac{125}{V_{mV}}$
at oscillator level ≤ 64 mV	$\frac{64}{V_{mV}}$
$E_{PBW} [\%] =$	
at measurement BW = 5	0
at measurement BW = 4	
frequency ≥ 50 kHz	0.03
frequency < 50 kHz	0.06
at measurement BW = 3	
frequency ≥ 50 kHz	0.1
frequency < 50 kHz	0.2
at measurement BW = 2	
frequency ≥ 50 kHz	0.2
frequency < 50 kHz	0.4
at measurement BW = 1	
frequency ≥ 50 kHz	0.4
frequency < 50 kHz	0.8

Specifications and Supplemental Performance Characteristics
Basic Characteristics

$K_{BW} =$	
at measurement BW = 5	1
at measurement BW = 4	1
at measurement BW = 3	
frequency \leq 1 MHz	3
frequency $>$ 1 MHz	4
at measurement BW = 2	
frequency \leq 1 MHz	4
frequency $>$ 1 MHz	5
at measurement BW = 1	
frequency \leq 1 MHz	6
frequency $>$ 1 MHz	10
$Y_{ODC} =$	
at dc bias range = 1 mA	0 [S]
at dc bias range = 10 mA	1 [μ S]
at dc bias range = 100 mA	10 [μ S]
E_{PL} [%] =	
when 16048G is used	$0.02 + 2 \times \frac{f}{100}$
when 16048H is used	$0.02 + 3 \times \frac{f}{100}$
$Y_{OL} =$	
when 16048G is used	$500 \times \frac{f}{100}$ [nS]
when 16048H is used	$1 \times \frac{f}{100}$ [μ S]
$Z_{SL} =$	
when 16048G or 16048H is used	
frequency \geq 500 Hz	2 [m Ω]
frequency $<$ 500 Hz	5 [m Ω]

NOTE

SPC at frequency $>$ 10 MHz.

f : frequency in MHz.
 V_{mV} : oscillator level in mV.

Impedance Measurement Accuracy at 7-mm Port of the 42942A

Equation 10-2 shows the impedance measurement accuracy [%] at the 7-mm port of the 42942A Terminal Adapter.

Equation 10-2 Impedance Measurement Accuracy [%] at 7-mm Port of 42942A

$$E = E_P' + \left(\frac{Z_S'}{|Z_X|} + Y_{O'} \cdot |Z_X| \right) \times 100$$

Where,

$$E_P' = E_{PBW} + E_{POSC} + E_P \text{ [%]}$$

$$Y_{O'} = K_{BW} \times K_{YOSC} \times (Y_{ODC} + Y_O) \text{ [S]}$$

$$Z_S' = K_{BW} \times K_{ZOSC} \times Z_S \text{ [W]}$$

Y_O, E_P, Z_S : See Figure 10-3 on page 340

$E_{posc} \text{ [%]} =$	
at oscillator level > 500 mV	$\frac{f}{100} \times \left(\frac{V_{mV}}{500} - 1 \right)$
at oscillator level > 125 mV, ≤ 500 mV	0
at oscillator level ≤ 125 mV	$\left(\frac{125}{V_{mV}} - 1 \right) \times (0.05 + E_{PBW})$
$K_{y_{osc}} =$	
at oscillator level ≥ 500 mV	1
at oscillator level < 500 mV	$\frac{500}{V_{mV}}$
$K_{z_{osc}} =$	
at oscillator level > 500 mV	$2 + \frac{f}{100}$
at oscillator level > 250 mV, ≤ 500 mV	$\frac{500}{V_{mV}}$
at oscillator level ≤ 250 mV, > 125 mV	$\frac{250}{V_{mV}}$

Specifications and Supplemental Performance Characteristics
Basic Characteristics

at oscillator level ≤ 125 mV	$\frac{125}{V_{mV}}$
E_{PBW} [%] =	
at measurement BW = 5	0
at measurement BW = 4	
frequency ≥ 50 kHz	0.03
frequency < 50 kHz	0.06
at measurement BW = 3	
frequency ≥ 50 kHz	0.1
frequency < 50 kHz	0.2
at measurement BW = 2	
frequency ≥ 50 kHz	0.2
frequency < 50 kHz	0.4
at measurement BW = 1	
frequency ≥ 50 kHz	0.4
frequency < 50 kHz	0.8
K_{BW} =	
at measurement BW = 5	1
at measurement BW = 4	1
at measurement BW = 3	3
at measurement BW = 2	4
at measurement BW = 1	6
Y_{ODC} =	
at dc bias range = 1 mA	0 [S]
at dc bias range = 10 mA	1 [μ S]
at dc bias range = 100 mA	10 [μ S]

NOTE

f : frequency in MHz.
 V_{mV} : oscillator level in mV.

Impedance Measurement Accuracy at 3.5-mm Port of the 42941A

Equation 10-3 shows the impedance measurement accuracy [%] at the 3.5-mm port of the 42941A Impedance Probe.

Equation 10-3 Impedance Measurement Accuracy [%] at 3.5-mm Port of 42941A

$$E = E_P' + \left(\frac{Z_S'}{|Z_X|} + Y_O' \cdot |Z_X| \right) \times 100$$

Where,

$$E_P' = E_{PBW} + E_{POSC} + E_P \text{ [%]}$$

$$Y_O' = K_{BW} \times K_{YOSC} \times (Y_{ODC} + Y_O) \text{ [S]}$$

$$Z_S' = K_{BW} \times K_{ZOSC} \times Z_S \text{ [W]}$$

Y_O, E_P, Z_S : see Figure 10-3 on page 340

$E_{posc} \text{ [%]} =$	
at oscillator level > 500 mV	$\frac{f}{100} \times \left(\frac{V_{mV}}{500} - 1 \right)$
at oscillator level > 125 mV, ≤ 500 mV	0
at oscillator level ≤ 125 mV	$\left(\frac{125}{V_{mV}} - 1 \right) \times (0.05 + E_{PBW})$
$K_{yosc} =$	
at oscillator level ≥ 500 mV	1
at oscillator level < 500 mV	$\frac{500}{V_{mV}}$
$K_{zosc} =$	
at oscillator level > 500 mV	$2 + \frac{f}{100}$
at oscillator level > 250 mV, ≤ 500 mV	$\frac{500}{V_{mV}}$
at oscillator level ≤ 250 mV, > 125 mV	$\frac{250}{V_{mV}}$
at oscillator level ≤ 125 mV	$\frac{125}{V_{mV}}$
$E_{PBW} \text{ [%]} =$	
at measurement BW = 5	0
at measurement BW = 4	

Specifications and Supplemental Performance Characteristics
Basic Characteristics

frequency \geq 50 kHz	0.03
frequency $<$ 50 kHz	0.06
at measurement BW = 3	
frequency \geq 50 kHz	0.1
frequency $<$ 50 kHz	0.2
at measurement BW = 2	
frequency \geq 50 kHz	0.2
frequency $<$ 50 kHz	0.4
at measurement BW = 1	
frequency \geq 50 kHz	0.4
frequency $<$ 50 kHz	0.8
$K_{BW} =$	
at measurement BW = 5	1
at measurement BW = 4	1
at measurement BW = 3	3
at measurement BW = 2	4
at measurement BW = 1	6
$Y_{ODC} =$	
at dc bias range = 1 mA	0 [S]
at dc bias range = 10 mA	1 [μ S]
at dc bias range = 100 mA	10 [μ S]

NOTE

f : frequency in MHz.
 V_{mV} : oscillator level in mV.

Temperature Coefficient of the 42941A Impedance Probe (SPC)

Proportional part (at 50 Ω measurement)	
$ Z $ deviation [ppm/ $^{\circ}$ C]	
at frequency \leq 1 MHz	< 5
at frequency $>$ 1 MHz	$20 + 500 \times \frac{f}{100}$
θ deviation [μ rad/ $^{\circ}$ C]	

at frequency ≤ 1 MHz	< 5
at frequency > 1 MHz, ≤ 5 MHz	$30 \times \frac{f}{5}$
at frequency > 5 MHz, ≤ 30 MHz	$50 + 150 \times \frac{f}{30}$
at frequency > 30 MHz	200
Residual part	
Residual impedance	$5 \times \frac{f}{100}$ [m Ω /°C]
Residual admittance	$\frac{f}{100}$ [μ S/°C]

NOTE

f: frequency in MHz.

These characteristics apply when the temperature of the probe, for a length of 30 cm from the tip, is changed.

Specifications and Supplemental Performance Characteristics
Basic Characteristics

Parameters Y_o , E_p , and Z_s

Figure 10-3

Parameters Y_o , E_p , and Z_s

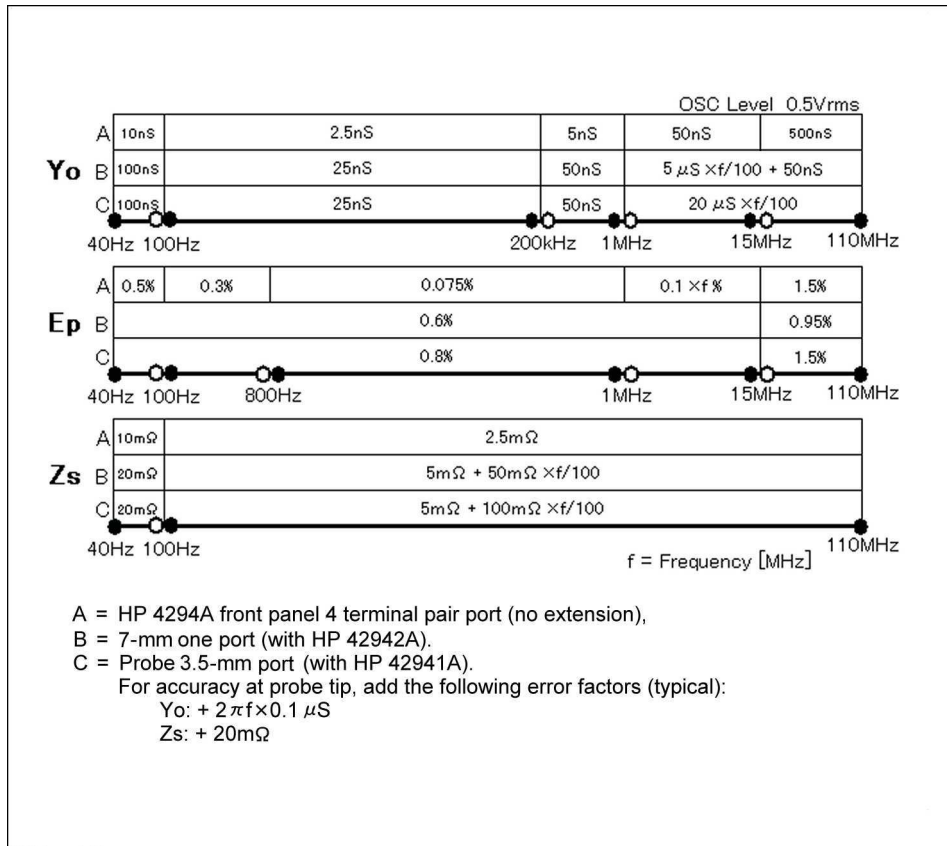

4294a0e009

Examples of Calculated Impedance Measurement Accuracy

Figure 10-4

Impedance Measurement Accuracy at Four-terminal Pair Port of Agilent 4294A's Front Panel (Oscillator Level = 0.5 Vrms)

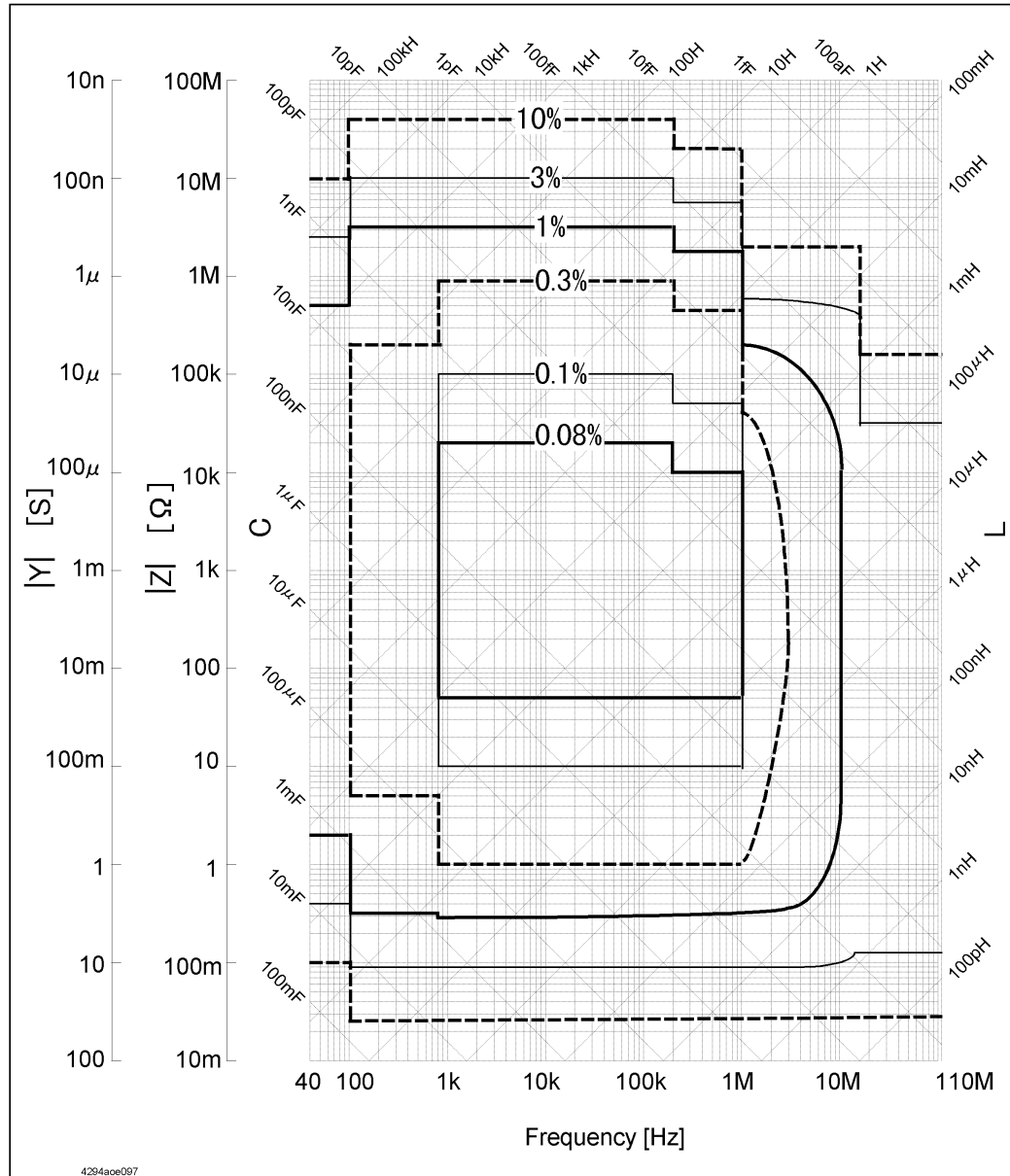

4294a0e097

Figure 10-5 Impedance Measurement Accuracy at 7-mm Port of 42942A Terminal Adapter Connected to the Agilent 4294A (Oscillator Level = 0.5 Vrms)

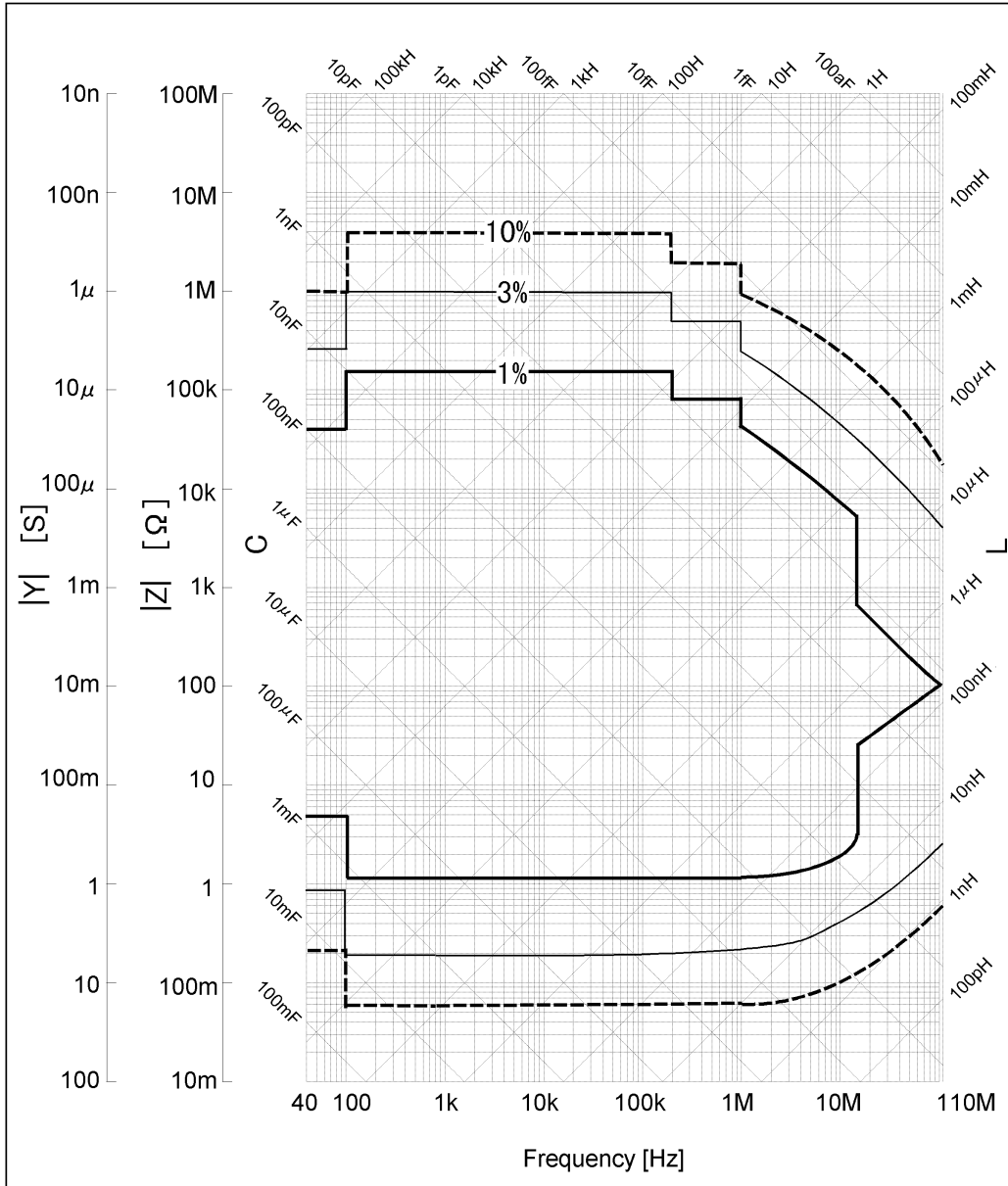
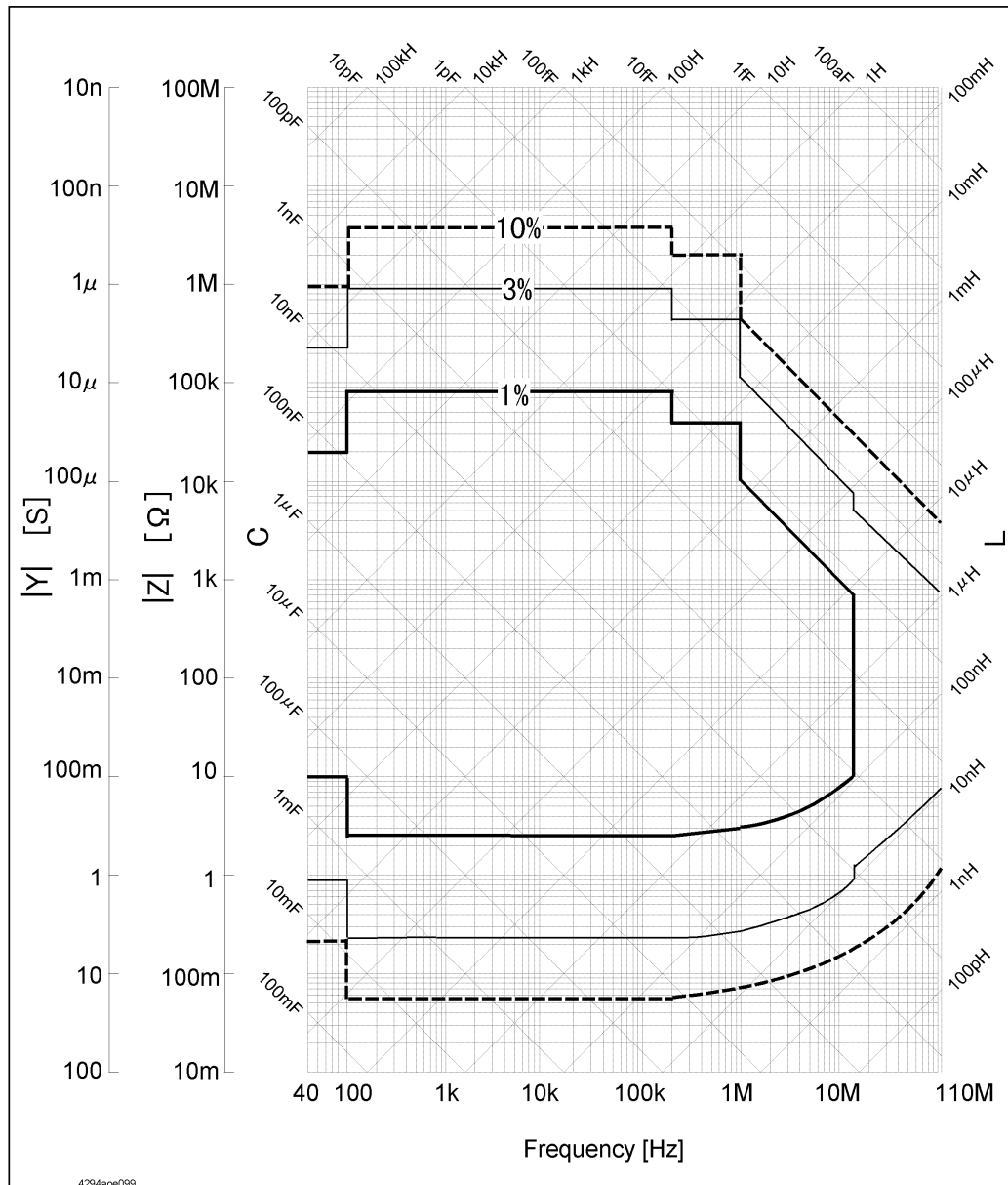

Figure 10-6 Impedance Measurement Accuracy at 3.5-mm port of 42941A Impedance Probe Connected to the Agilent 4294A (Oscillator Level = 0.5 Vrms)



Display Functions

Display	
Size/Type	8.4 inch color LCD (TFT)
Resolution (pixels)	640 × 480 (VGA)
Scale types	
X-axis scale	Linear and log
Y-axis scale	Linear and log (depending on sweep type)
Number of traces	
Data trace	2 traces (trace A and trace B)
Memory trace	2 traces (trace A and trace B)
Split display	Available (trace A: upper half, trace B: lower half)
Instrument/IBASIC display selection	All instrument, Half instrument and half IBASIC, All IBASIC, or Instrument and IBASIC status.
Other display functions	Inactive trace off, trace accumulation, phase expansion
Data math functions	Data - memory, data/memory ¹ , delta% ² , offset

1. Complex Z-Y measurements only.
2. Except for Complex Z-Y measurements.

Marker Functions

Marker type and number	
Main marker	One for each trace (A and B).
Sub marker	Seven for each trace (A and B).
Δ marker	One for each trace (A and B).
Marker search	
Search type	Maximum, minimum, target, peak, trace bandwidth analysis
Search track	Performs search with each sweep
Marker X-axis display	Sweep parameter value, sweep elapsed time, or relaxation time ($1/2\pi f$)
Other functions	Marker continuous mode, Δ marker mode, marker coupled mode, marker value substitution (marker→), marker zooming, marker list, marker statistics, marker signal/dc bias monitor

Equivalent Circuit Analysis

Circuit models	3-component model (4 models), 4-component model (1 model)
Analysis types	Equivalent circuit parameters calculation, frequency characteristics simulation

Limit Line Test

Available setup parameters for each segment	Sweep start value, sweep stop value, upper limit (middle value) and lower limit (delta limit) for sweep start, upper limit (middle value) and lower limit (delta limit) for sweep stop
Number of segments	1 to 18
Other functions	Beep fail, limit line offset

Mass Storage

Flexible disk drive	
Type	3.5 inch, Built-in
Size	1.44 MB
Format	DOS
Formatting	Available
Volatile memory disk	
Size	512 KB
Nonvolatile memory disk (flash memory)	
Size	10 MB
Stored data	State (binary), data (binary or ASCII), display graphics (TIFF)

Parallel Printer Port

Interface standard	IEEE 1284 Centronics
Printer control language	HP PCL3 printer control language
Connector type	25-pin D-SUB connector

GPIB

Standard conformity	IEEE 448.1-1987, IEEE 488.2-1987, IEC 625, JIS C 1901-1987
Available functions (function code) ¹	SH1, AH1, T6, TE0, L4, LE0, SR1, RL1, PP0, DC1, DT1, C1, C2, C3, C4, C11, E2
Numeric data transfer formats	ASCII, 32- or 64-bit IEEE 754 floating point format, DOS PC format (32-bit IEEE reversed byte order)

1. See the standard's documentation for a description of each code.

HP Instrument BASIC

Keyboard	
Type	PS/2 style 101 English
Connector type	Mini-DIN connector

8-Bit I/O Port

Connector type	15-pin D-SUB connector
Signal level	TTL
Number of I/O bits	4 bits for input, 8 bits for output
Pin assignment	(see Figure 10-7)

Figure 10-7

8 Bit I/O Port Pin Assignment

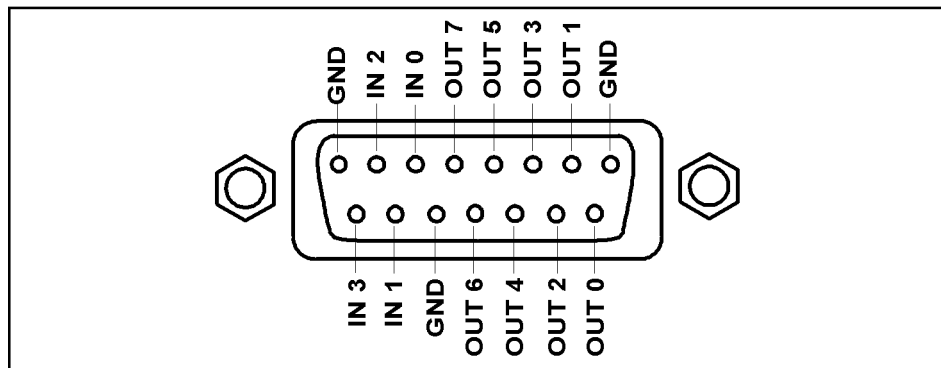

4294aaj004

24-bit I/O Port (Handler Interface)

Connector type	36-pin D-SUB connector
Signal level	TTL

Number of I/O bits	8 bits for input or output, 16s bit for output
Pin Assignment	(see Figure 10-8 and Table 10-1)

Figure 10-8 24-Bit I/O Port Pin Assignment

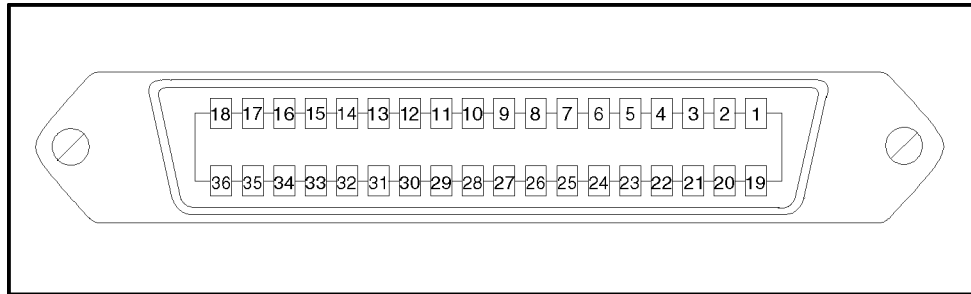

Table 10-1 24-Bit I/O Port Pin Assignment

Pin No.	Signal Name	Signal Standard
1	GND	0 V
2	INPUT1	TTL level, pulse input, pulse width: 1µs or above
3	OUTPUT1	TTL level, latch output
4	OUTPUT2	TTL level, latch output
5	Output port A0	TTL level, latch output
6	Output port A1	TTL level, latch output
7	Output port A2	TTL level, latch output
8	Output port A3	TTL level, latch output
9	Output port A4	TTL level, latch output
10	Output port A5	TTL level, latch output
11	Output port A6	TTL level, latch output
12	Output port A7	TTL level, latch output
13	Output port B0	TTL level, latch output
14	Output port B1	TTL level, latch output
15	Output port B2	TTL level, latch output
16	Output port B3	TTL level, latch output
17	Output port B4	TTL level, latch output
18	Output port B5	TTL level, latch output
19	Output port B6	TTL level, latch output
20	Output port B7	TTL level, latch output

Table 10-1

24-Bit I/O Port Pin Assignment

Pin No.	Signal Name	Signal Standard
21	Input/Output port C0	TTL level, latch output
22	Input/Output port C1	TTL level, latch output
23	Input/Output port C2	TTL level, latch output
24	Input/Output port C3	TTL level, latch output
25	Input/Output port D0	TTL level, latch output
26	Input/Output port D1	TTL level, latch output
27	Input/Output port D2	TTL level, latch output
28	Input/Output port D3	TTL level, latch output
29	Port C status	TTL level, input mode: LOW, output mode: HIGH
30	Port D status	TTL level, input mode: LOW, output mode: HIGH
31	Write strobe signal	TTL level, active low, pulse output (width: 10 μ s, typical)
32	+5V pullup	
33	SWEEP END signal	TTL level, active low, pulse output (width: 20 μ s, typical)
34	+5V	+5V, 100mA MAX
35	PASS/FAIL signal	TTL level, PASS: HIGH, FAIL: LOW, latch output
36	PASS/FAIL write strobe signal	TTL level, active low, pulse output (width: 10 μ s, typical)

LAN Interface

Standard conformity	10 Base-T Ethertwist, RJ45 connector
Protocol	TCP/IP
Supported applications	Telnet, FTP, FTP with automatic execution

General Characteristics

External Reference Input

Frequency	10 MHz \pm 10 ppm (typical)
Level	- 5 dBm to + 5 dBm (typical)
Input impedance	50 Ω (nominal)
Connector type	BNC (female)

Internal Reference Output

Frequency	10 MHz (nominal)
Level	0 dBm (typical)
Output impedance	50 Ω (nominal)
Connector type	BNC (female)

High Stability Frequency Reference Output (Option 1D5)

Frequency	10 MHz (nominal)
Level	0 dBm (typical)
Output impedance	50 Ω (nominal)
Connector type	BNC (female)

External Trigger Input

Level	TTL
Pulse width (Tp)	\geq 2 μ s (typical), see Figure 10-9 for the definition of Tp.
Polarity	Positive or Negative (selectable)
Connector type	BNC (female)

Figure 10-9

Required Pulse Width (T_p) for External Trigger Input

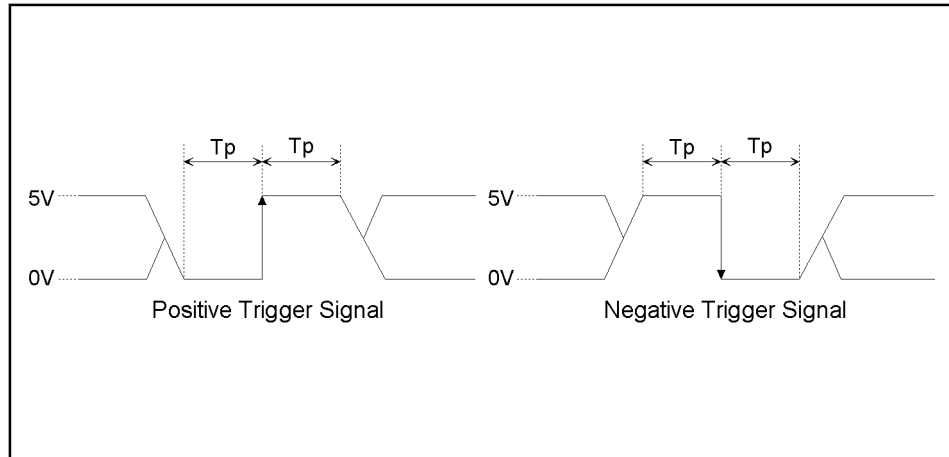

C5010014e

External Program RUN/CONT Input

Level	TTL
Connector type	BNC (female)

External Monitor Output

Connector type	D-SUB, 15-pin HD
Display resolution (pixels)	640 × 480 (VGA)

Operating Conditions

Temperature	
Disk drive non-operating condition	0°C to 40°C
Disk drive operating condition	10°C to 40°C
Humidity (at wet bulb temperature $\leq 29^\circ\text{C}$, without condensation)	
Disk drive non-operating condition	15% to 95% RH
Disk drive operating condition	15% to 80% RH
Altitude	0 m to 2,000 m
Warm up time	30 minutes

Non-operating Conditions

Temperature	- 20°C to + 60°C
Humidity (at wet bulb temperature ≤ 45°C, without condensation)	15% to 95% RH
Altitude	0 m to 4,572 m

Other Specifications

EMC	<ul style="list-style-type: none"> • EN 55011(1991) / CISPR 11(1990) Group 1, Class A • EN 50082-1(1992) / IEC 61000-4-2(1995) 4 kV CD, 8 kV AD • EN 50082-1(1992) / IEC 61000-4-3(1995) 3 V/m, 27 MHz - 1 GHz • EN 50082-1(1992) / IEC 61000-4-4(1995) 0.5 kV Signal Line, 1 kV Power Line • EN 61000-3-2(1995) / IEC 61000-3-2(1995) • EN 61000-3-3(1995) / IEC 61000-3-3(1994) <p>This ISM device complies with Canadian ICES-001. Cet appareil ISM est conforme à la norme NMB-001 du Canada.</p>
Safety	<ul style="list-style-type: none"> • EN 61010-1(1993) +Amd2(1995) / IEC61010-1(1990) +Am1(1992) +Am2(1995) • CSA-C22.2 NO.1010.1-92
Power requirements	90 V to 132 V, or 198 V to 264 V (automatically switched), 47 Hz to 63 Hz, 300 VA max.
Weight	25 kg (SPC)
Dimensions	(see Figure 10-10 through Figure 10-12)

Figure 10-12

Dimensions (side view, with Option 1CN/1D5, typical, in millimeters)

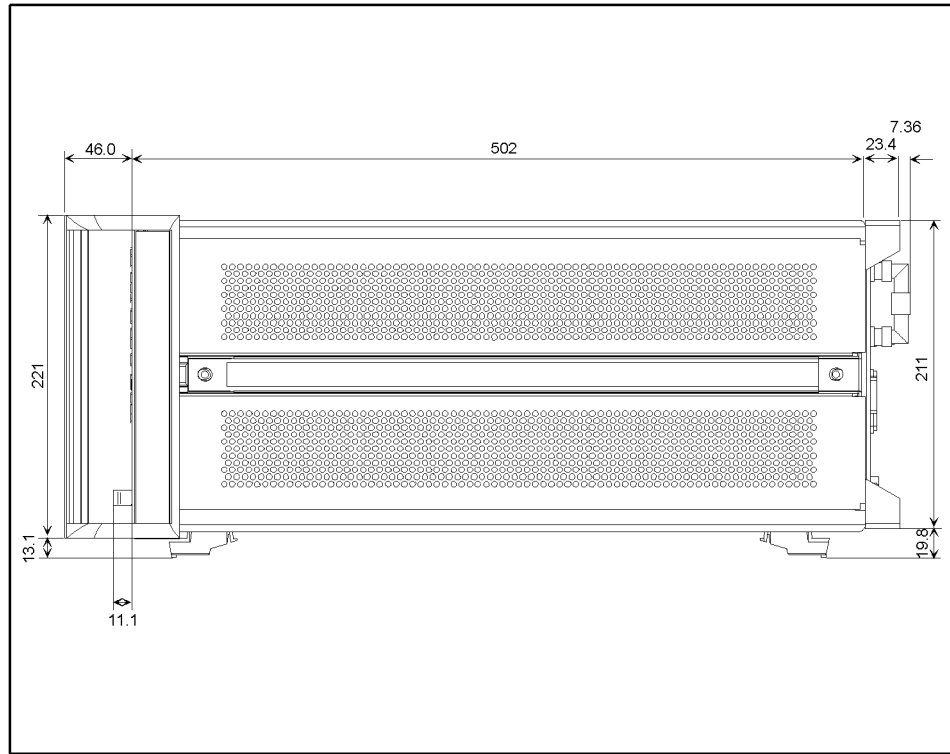

4294AOJ003

Furnished Accessories

Agilent Part Number ¹	Description	Qty
04294-900x0	<i>Operation Manual</i> ²	1
04294-900x1	<i>Programming Manual</i> ²	1
E2083-90005	<i>HP Instrument BASIC User's Handbook</i> ²	1
04294-901x0	<i>Service Manual</i> ³	1
04294-180x0	Sample Program Disk (3.5 inch) ²	1
04294-61001	100 Ω Resistor	1
-	Mini-DIN Keyboard ⁴	1
-	Power Cable ⁵	1
1250-1859	BNC Adapter ⁶	1
5063-9229	Handle Kit ⁷	1
5063-9216	Rackmount Kit ⁸	1
5063-9223	Rackmount & Handle Kit ⁹	1

1. The number of "x" in the part number of each manual or sample program disk, 0 for the first edition, is incremented by 1 each time revision is made. The latest edition comes with the product.
2. Option ABA (With Operation Manual Set) only.
3. Option 0BW (With Service Manual) only.
4. Option 810 (With Keyboard) only.
5. The power cable depends on which country the instrument is used in.
6. Option 1D5 (High Stability Frequency Reference) only.
7. Option 1CN (Handle Kit) only.
8. Option 1CM (Rackmount Kit) only.
9. Option 1CP (Rackmount & Handle Kit) only.

A **Manual Changes**

This appendix contains the information required to adapt this manual to versions or configurations of the Agilent 4294A earlier than the current printing date of this manual. The information in this manual applies directly to an Agilent 4294A with a serial number prefix that is listed on the title page of this manual.

Manual Changes

To adapt this manual to your 4294A, refer to Table A-1 and Table A-2.

Table A-1 Manual Changes by Serial Number

Serial Prefix or Number	Make Manual Changes

Table A-2 Manual Changes by Firmware Version

Version	Make Manual Changes
1.10	

Agilent Technologies uses a two-part, ten-character serial number that is stamped on the serial number plate (see Figure A-1). The first five characters are the serial prefix and the last five digits are the suffix.

Press **[System] - DIAGNOSTIC TEST - FIRMWARE REVISION** keys to display the firmware version of your Agilent 4294A.

Figure A-1 Example of Serial Number Plate



4287ae0j048

Change 1

The firmware before the revision 1.0x does not support the following function.

- Saving the internal data in the touchstone format.

Change to the revision 1.0x

Chapter 8 , “Analysis and Processing of Result,” on page 211

Delete the following section

- “Saving a data array in touchstone format” on page 285
- “Using a file saved in touchstone format” on page 286

Table B-105 on page 421

Modify as follows.

Key operation: [Save]

Softkey	Function	GPIB command
STATE ►	Selects storage of the configuration states and internal data array of the Agilent 4294A and displays Table B-106, “Filename entry (File Name) menu,” on page 421.	SAVDSTA <string>
DATA ►	Selects storage of the internal data array of the Agilent 4294A and displays Table B-107, “Data save (Save Data) menu,” on page 422.	(N/A)
GRAPHICS ►	Selects storage of the displayed screen in TIFF format and displays Table B-106, “Filename entry (File Name) menu,” on page 421. It is stored in the colors selected in Table B-99, “Copy configuration (Copy Setup) menu (1/2),” on page 417. The softkeys are also stored.	SAVDTIF <string>
RE-SAVE FILE ►	Displays Table B-111, “File selection (Select File) menu,” on page 424.	RESAVD <string>
POWER ON CONFIG ►	Displays Table B-109, “Power-on configuration save (Save config?) menu,” on page 423.	SAVPSTA
FILE UTILITIES ►	Displays Table B-110, “File utility (File Utility) menu,” on page 423.	(N/A)
STORE DEV [] ►	Displays Table B-81, “Mass storage (Store Device) menu,” on page 408. In [] of the softkey label, the currently selected mass storage is displayed (flexible disk drive: [FLOPPY], volatile memory disk: [MEMORY], or nonvolatile memory disk (flash memory): [FLASH]).	(N/A)

Miscellaneous Changes

The option system of the 4294A has changed since February 2003. Apply the following changes.

Table A-3

New Option Number	Old Option Number	Remark
800 (Standard Frequency Reference)	Standard	1
same as the right number	1D5 (High Stability Frequency Reference)	
810 (Add Mini DIN Keyboard)	-	2
-	1A2 (Delete Mini DIN Keyboard)	
same as the right number	1CN (Handle Kit)	
same as the right number	1CM (Rack Mount Kit)	
same as the right number	1CP (Rack Mount & Handle Kit)	
ABA (Add Operation Manual set (English))	-	3
-	ABA (Add Operation Manual set (English))	
ABJ (Add Operation Manual set (Japanese))	-	3
-	ABJ (Add Operation Manual set (Japanese))	
same as the right number	0BW (Add Service Manual)	
-	0B1 (Delete Manual Sets)	4
-	0B1 (Add Manual Sets)	

1. In the previous system, an option for the frequency reference was available only for the high stability frequency reference. In the new option system, it is available for the high stability and standard references, requiring the customer to select either of them.

2. In the previous option system, the keyboard comes as one of standard accessories. In the new option system, it will be attached only when you choose option 810.

3. In the previous system, the option number is used to choose the language of the operation manual set (standard accessory). In the new option system, it is used to add an operation manual set (optional accessory) of the language the customer desires.

4. No selection of addition/deletion is required for the operation manual set because it is only available as an optional accessory in the new option system. When 2 or more sets are required, specify option ABA, ABJ * (number of required sets).

B **Key Definitions**

This chapter describes the functions of the front keys (both hardkeys and softkeys) of the Agilent 4294A.

Functions of hardkeys

This section describes the function and corresponding GPIB command for each hardkey.

Table B-1 ACTIVE TRACE key

Hardkey	Function	GPIB command
[A]	Trace A is selected as the active trace. Changes the configurations to trace A (for example, when Z - θ are selected as measurement parameters, the trace of Z is selected). This selection is available only for functions where trace A and trace B can be set independently. When trace A is selected, the LED to the left of the key is lit.	TRAC A
[B]	Trace B is selected as the active trace. Changes the configurations to trace B (for example, when Z - θ are selected as measurement parameters, the trace of θ is selected). This selection is available only for functions where trace A and trace B can be set independently. When trace B is selected, the LED to the right of the key is lit.	TRAC B

Table B-2 MEASUREMENT block

Hardkey	Function	GPIB command
[Meas]	Displays Table B-7, "Measurement parameter (Measurement) menu (1/3)," on page 363.	(N/A)
[Format]	Displays Table B-11, "Format (Format) menu (1)," on page 365.	(N/A)
[Display]	Displays Table B-13, "Display (Display) menu (1/2)," on page 366.	(N/A)
[Scale Ref]	Displays Table B-27, "Scale reference (Scale Ref) menu (1-1/2)," on page 373.	(N/A)
[Bw / Avg]	Displays Table B-32, "Measurement bandwidth/averaging (Bw/Average) menu," on page 376.	(N/A)
[Cal]	Displays Table B-34, "Calibration (Calibration) menu," on page 378.	(N/A)

Table B-3 STIMULUS block

Hardkey	Function	GPIB command
[Sweep]	Displays Table B-43, "Sweep (Sweep) menu," on page 383.	(N/A)
[Source]	Sets the fixed oscillator level value if the sweep parameter is frequency; sets the fixed oscillator frequency (CW frequency) if the sweep parameter is oscillator level or dc bias. Also displays Table B-53, "Source oscillator (Source Osc) menu," on page 388.	(N/A)
[Trigger]	Displays Table B-56, "Trigger (Trigger) menu," on page 390.	(N/A)
[Start]	Sets the sweep start value.	STAR <value>
[Stop]	Sets the sweep stop value.	STOP <value>
[Center]	Sets the sweep center value.	CENT <value>
[Span]	Sets the sweep span value.	SPAN <value>

Table B-4 MARKER block

Hardkey	Function	GPIB command
[Marker]	Displays the marker at the sweep center value position if it has not been displayed and lets you enter a sweep parameter value that specifies a marker position. Also displays Table B-58, “Marker (Marker) menu,” on page 392.	MKR ON; MKRPRM <value>
[Marker →]	Displays the marker at the sweep center value position if it has not been displayed and lets you enter a sweep parameter value that specifies a marker position. Also displays Table B-62, “Marker→ (Marker →/Zoom) menu (1/2),” on page 395.	MKR ON; MKRPRM <value>
[Search]	Displays the marker at the sweep center value position if it has not been displayed. Also displays Table B-64, “Search (Search) menu,” on page 397.	MKR ON
[Utility]	Displays the marker at the sweep center value position if it has not been displayed. Also displays Table B-71, “Utility (Utility) menu,” on page 402.	MKR ON

Table B-5 INSTRUMENT STATE block

Hardkey	Function	GPIB command
[System]	Displays Table B-74, “System (System) menu,” on page 404.	(N/A)
[Local]	Brings the 4294A from the remote state into the local state. Also displays Table B-94, “Local (Local) menu,” on page 415.	(N/A)
[Preset]	Sets the configurations of the 4294A to the initial values (preset state).	PRES
[Copy]	Displays Table B-98, “Copy (Copy) menu,” on page 417. Specify the configurations required to output the screen to the printer.	(N/A)
[Save]	Displays Table B-105, “Save (Save) menu,” on page 421. Specify the configurations required to store the configurations of the 4294A, trace data, and graphics into the internal memory or diskettes.	(N/A)
[Recall]	Displays Table B-8, “Measurement parameter (Measurement) menu (2/3),” on page 363. In this menu, the filenames of the state files in the currently selected mass storage are called and displayed.	RECD <string>

Table B-6 ENTRY block

Hardkey	Function	GPIB command
○ (rotary knob)	By turning this knob, you can adjust the current setting. This method immediately updates the parameter value without requiring you to press a unit key. When working with particular configuration items, you can also use the rotary knob to move the cursor horizontally.	(N/A)
↓ (step key)	This key allows you to decrementally change the current setting. This method immediately updates the parameter value without requiring you to press a unit key.	(N/A)
↑ (step key)	This key allows you to incrementally change the current setting. This method immediately updates the parameter value without requiring you to press a unit key.	(N/A)
[Entry Off]	Switches the instrument from entry mode to normal operation mode with the name and current setting of the parameter no longer shown in the upper left area of the LCD display. An error message previously shown on the display also disappears.	(N/A)

Key Definitions
Functions of hardkeys

Table B-6 ENTRY block

Hardkey	Function	GPIB command
[Back Space]	Moves the cursor one space back and deletes the character to the left of the cursor. If you make a mistake in entering a value through the numeric keys, you can use this key to correct your entry.	(N/A)
[0] to [9], [.] , [-] (numeric key)	Use these keys to enter each numeral that makes up your entry. Press a unit key to put your entered value into effect.	(N/A)
[G/n][M/μ][k/m][x1](unit key)	After entering your desired value through numeric keys, press one of these unit keys to suffix the value with the specific unit. The entered value does not take effect until you press a unit key. Each unit key, except the [x1] key, represents two different units, identified by their respective initial letters. Which unit to use is automatically determined based on the selected parameter. Use the [x1] key to enter a value that does not take a specific unit.	(N/A)

Softkeys displayed by pressing the [Meas] key

Table B-7 Measurement parameter (Measurement) menu (1/3)

Key operation: [Meas]

Softkey	Function	GPIB command
Z - θ 	Selects impedance absolute value and impedance phase as measurement parameters. The 1st parameter on the softkey label (in this case, Z) is assigned to trace A; the 2nd parameter (in this case, θ), to trace B. (This system of trace assignment is applicable to other measurement parameters.)	MEAS IMPH
R - X 	Selects series resistance and reactance as measurement parameters.	MEAS IRIM
Ls - Rs 	Selects series inductance and series resistance as measurement parameters.	MEAS LSR
Ls - Q 	Selects series inductance and Q factor (quality factor) as measurement parameters.	MEAS LSQ
Cs - Rs 	Selects series capacitance and series resistance as measurement parameters.	MEAS CSR
Cs - Q 	Selects series capacitance and Q factor (quality factor) as measurement parameters.	MEAS CSQ
Cs - D	Selects series capacitance and dissipation factor as measurement parameters.	MEAS CSD
more 1/3	Displays Table B-8, "Measurement parameter (Measurement) menu (2/3)," on page 363.	(N/A)

Table B-8 Measurement parameter (Measurement) menu (2/3)

Key operation: [Meas] - more 1/3

Softkey	Function	GPIB command
Y - θ 	Selects admittance absolute value and admittance phase as measurement parameters.	MEAS AMPH
G - B 	Selects conductance and susceptance as measurement parameters.	MEAS ARIM
Lp - G 	Selects parallel inductance and conductance as measurement parameters.	MEAS LPG
Lp - Q 	Selects parallel inductance and Q factor (quality factor) as measurement parameters.	MEAS LPQ
Cp - G 	Selects parallel capacitance and conductance as measurement parameters.	MEAS CPG
Cp - Q 	Selects parallel capacitance and Q factor (quality factor) as measurement parameters.	MEAS CPQ
Cp - D	Selects parallel capacitance and dissipation factor as measurement parameters.	MEAS CPD
more 2/3	Displays Table B-9, "Measurement parameter (Measurement) menu (3/3)," on page 364.	(N/A)

Key Definitions
Softkeys displayed by pressing the [Meas] key

Table B-9 Measurement parameter (Measurement) menu (3/3)

Key operation: [Meas] - more 1/3 - more 2/3

Softkey	Function	GPIB command
COMPLEX Z-Y 	Selects complex impedance (Z) and complex admittance (Y) as measurement parameters. If these parameters are selected, the graph is displayed in the complex plane or polar coordinates (selected using Table B-12, "Format (Format) menu (2)," on page 365).	MEAS COMP
Z - Ls 	Selects impedance absolute value and series inductance as measurement parameters.	MEAS IMLS
Z - Cs 	Selects impedance absolute value and series capacitance as measurement parameters.	MEAS IMCS
Z - Lp 	Selects impedance absolute value and parallel inductance as measurement parameters.	MEAS IMLP
Z - Cp 	Selects impedance absolute value and parallel capacitance as measurement parameters.	MEAS IMCP
other	Displays Table B-10, "Measurement parameter (Measurement) menu (other)," on page 364.	(N/A)
more 3/3	Displays Table B-7, "Measurement parameter (Measurement) menu (1/3)," on page 363.	(N/A)

Table B-10 Measurement parameter (Measurement) menu (other)

Key operation: [Meas] - more 1/3 - more 2/3 - other

Softkey	Function	GPIB command
Z - Rs 	Selects impedance absolute value and series resistance as measurement parameters.	MEAS IMRS
Z - Q 	Selects impedance absolute value and Q factor (quality factor) as measurement parameters.	MEAS IMQ
Z - D 	Selects impedance absolute value and dissipation factor as measurement parameters.	MEAS IMD
Lp - Rp 	Selects parallel inductance and parallel resistance as measurement parameters.	MEAS LPR
Cp - Rp	Selects parallel capacitance and parallel resistance as measurement parameters.	MEAS CPR
return	Returns to Table B-7, "Measurement parameter (Measurement) menu (1/3)," on page 363.	(N/A)

Softkeys displayed by pressing the [Format] key

Table B-11 Format (Format) menu (1)

Key operation: [Format]¹

Softkey	Function	GPIB command
LIN 	Selects the linear scale as the vertical axis (Y axis) for the graph.	FMT LINY
LOG	Selects the log (logarithm) scale as the vertical axis (Y axis) for the graph.	FMT LOGY
PHASE UNIT []	Toggles the phase display unit between degree [DEG] and radian [RAD] each time this key is pressed.	PHAU {DEG RAD}
EXP PHASE on OFF	Toggles on and off the phase expansion display function each time this key is pressed. ON off in the softkey label indicates ON state; on OFF, OFF state.	EXPP {ON OFF}

1. When the measurement parameter is not COMPLEX Z-Y.

Table B-12 Format (Format) menu (2)

Key operation: [Format]¹

Softkey	Function	GPIB command
COMPLEX 	Selects the complex plane to display the graph. This plane has a grid scale whose horizontal axis is the actual axis and whose vertical axis is an imaginary axis.	FMT COMP
POLAR	Selects the polar coordinates to display the graph. Complex parameters are displayed in an absolute value scale (distance from the origin) and a phase scale (counterclockwise phase angle).	FMT POLA
PHASE UNIT []	Toggles the phase display unit between degree [DEG] and radian [RAD] each time this key is pressed.	PHAU {DEG RAD}
EXP PHASE on OFF	Toggles on and off the phase expansion display function each time this key is pressed. ON off in the softkey label indicates ON state; on OFF, OFF state.	EXPP {ON OFF}

1. When the measurement parameter is COMPLEX Z-Y. (Key operation: [Meas] - more 1/3 - more 2/3 - COMPLEX Z-Y)

Softkeys displayed by pressing the [Display] key

Table B-13 Display (Display) menu (1/2)

Key operation: [Display]

Softkey	Function	GPIB command
SPLIT on OFF	Toggles on and off the trace split display. When the split display is on, the scale is horizontally divided into two parts on the screen; trace A is displayed in the upper half, trace B in the lower half. When the split display is off, full-screen display is invoked, and trace A and trace B are displayed on a single scale. Note that this function is valid only when the ALL INSTRUMENT key or the BASIC STATUS key has been selected in Table B-21, "Display allocation (Disp Alloc) menu," on page 369.	SPLD {ON OFF}
HIDE INACT on OFF	Toggles on and off the inactive trace display. The inactive trace means trace B when trace A is active and trace A when trace B is active.	HIDI {ON OFF}
ACCUMULATE on OFF	Toggles on and off the accumulation of trace display on the screen. If this is set to on, traces once written on the screen are not deleted, and the next trace is superimposed. With accumulated traces, you cannot read out data using markers or change the scale configuration. When accumulation is turned off, the trace accumulation is canceled, and all accumulated traces until then are deleted.	ACCUD {ON OFF}
DEF TRACE [] ►	Displays Table B-15, "Trace definition (Define Trace) menu," on page 367. The currently defined trace type is displayed in [] of the softkey label.	(N/A)
OFFSET	Sets the offset value that is subtracted from the data trace of the traces defined using the above DEF TRACE [] key. If an offset value other than zero is entered, "-O" is displayed at the left edge of the screen in the same color as the trace. For the memory trace, the offset value is not subtracted.	DATOVAL <value>
OSC MON on OFF	Toggles on and off the monitor display of the test signal level. If this is set to on, the test signal level is monitored and displayed at the bottom of the display during measurement.	OMON {ON OFF}
BIAS MON [] ►	Displays Table B-16, "Bias Monitor (Bias Monitor) menu," on page 367.	(N/A)
more 1/2	Displays Table B-14, "Display (Display) menu (2/2)," on page 366.	(N/A)

Table B-14 Display (Display) menu (2/2)

Key operation: [Display] - more 1/2

Softkey	Function	GPIB command
TITLE ►	Displays Table B-17, "Title menu," on page 368 and waits for entry of a string. The entered string is displayed in the title area of each active trace on the screen. Up to 65 characters can be displayed.	TITL <string>
EQUIV CKT ►	Displays Table B-18, "Equivalent circuit analysis (Equiv Circuit) menu," on page 368.	(N/A)
ALLOCATION ►	Displays Table B-21, "Display allocation (Disp Alloc) menu," on page 369.	(N/A)
MODIFY COLOR ►	Displays Table B-22, "Display color modification (Modify Color) menu," on page 370.	(N/A)
more 2/2	Displays Table B-13, "Display (Display) menu (1/2)," on page 366.	(N/A)

Table B-15 Trace definition (Define Trace) menu

Key operation: [Display] - DEF TRACE[]

Softkey	Function	GPIB command
DATA 	For the current active trace (A or B), stores the measured data into the data trace without further calculation and displays it ¹ .	DISP DATA
MEMORY 	For the current active trace (A or B), displays the memory trace on the screen ¹ . Before selecting this key, you must store data into the memory trace.	DISP MEMO
DATA and MEMORY 	For the current active trace (A or B), stores the measured data into the data trace and displays both the data trace and the memory trace ¹ . Before selecting this key, you must store data into the memory trace.	DISP DATM
DATA-MEM 	For the current active trace (A or B), subtracts the data in the memory trace from the measured data, stores the result into the data trace, and displays it on the screen ¹ . If this key is selected, “D-M” is displayed at the left edge of the screen in the same color as the trace.	DISP DMNM
DELTA % 	For the current active trace (A or B), executes the calculation of $\{(DATA-MEM)/MEM\} \times 100[\%]$ (DATA: measured data, MEM: memory trace data), stores the result into the data trace, and displays it on the screen ¹ . If DELTA % is selected, “D%M” is displayed at the left edge of the screen in the same color as the trace. You can select this key only when the measurement parameter is not COMPLEX Z-Y.	DISP DELP
DATA/MEM	For the current active trace (A or B), divides the measured data by the memory trace data, stores the result into the data trace, and displays it on the screen ¹ . If DATA/MEM is selected, “D/M” is displayed at the left edge of the screen in the same color as the trace. You can select this key only when the measurement parameter is COMPLEX Z-Y.	DISP DDVM
DATA → MEMORY	For both trace A and trace B, stores the current measured data into the memory trace.	DATMEM
return	Returns to the display menu (1).	(N/A)

1. The factory default colors used to display traces of the state are as follows: data trace A, yellow; data trace B, blue; memory trace A, green; memory trace B, brown. You can change the colors of the traces by using the keys in Table B-23, “Item color modification (Color Item) menu (1/3),” on page 370.

Table B-16 Bias Monitor (Bias Monitor) menu

Key operation: [Display] - BIAS MON []

Softkey	Function	GPIB command
OFF 	Turns off the dc bias monitor display.	BMON OFF
VOLT 	Monitors the dc bias voltage value and displays it in the lower right area of the screen.	BMON VOLT
CURRENT	Monitors the dc bias current value and displays it in the lower right area of the screen.	BMON CURR
return	Returns to Table B-13, “Display (Display) menu (1/2),” on page 366.	(N/A)

Key Definitions
Softkeys displayed by pressing the [Display] key

Table B-17 Title menu

Key operation: [Display] - more 1/2 - TITLE

Softkey	Function	GPIB command
SELECT LETTER	Enters the character at the character selection cursor (↑), which has been selected with the arrow keys ([↑] or [↓]) and the rotary knob, at the position of the cursor () on the string entry line and moves the cursor to the right by 1 character.	(N/A)
SPACE	Enters a space at the position of the cursor () on the string entry line and moves the cursor to the right by 1 character.	(N/A)
BACK SPACE	Moves the cursor () on the string entry line to the left by 1 character and deletes the character in that position.	(N/A)
CLEAR TITLE	Deletes the entire string on the string entry line and moves the cursor () to the leftmost position.	(N/A)
done	Stores the string entered in the string entry line and displays it in the title area. Also returns to Table B-13, “Display (Display) menu (1/2),” on page 366.	(N/A)
cancel	Cancels string entry in the title area. In the title area, the previously stored string is displayed. Also returns to Table B-13, “Display (Display) menu (1/2),” on page 366.	(N/A)

Table B-18 Equivalent circuit analysis (Equiv Circuit) menu

Key operation: [Display] - more1/2 - EQUIV CKT

Softkey	Function	GPIB command
CIRCUIT on OFF	Toggles on and off the display of the equivalent circuit diagram. If this is set to on, the equivalent circuit diagram is displayed instead of the trace display.	DISECIRC {ON OFF}
SELECT CIRCUIT ►	Displays Table B-19, “Equivalent circuit selection (Select Circ) menu,” on page 369.	(N/A)
PARAMETERS on OFF	Toggles on and off the display of the equivalent circuit parameter values on the trace display screen.	DISECPARA {ON OFF}
DEFINE PARAMETERS ►	Displays Table B-20, “Equivalent circuit parameter definition (Define Param) menu,” on page 369.	(N/A)
CALCULATE PARAMETERS	Calculates and displays the equivalent circuit parameters based on the data stored in the data trace and the equivalent circuit selected using the SELECT CIRCUIT key. If the display of the equivalent circuit parameter values is off (PARAMETERS on OFF), it is automatically turned on.	CALECPARA
SIMULATE F-CHRST	Simulates the frequency characteristics of the selected equivalent circuit and stores the result in the memory trace based on the equivalent circuit parameter values entered using the DEFINE PARAMETERS key or calculated from the trace using the CALCULATE PARAMETERS key. Executing this key automatically selects DATA and MEMORY (displaying both the data trace and the memory trace) in Table B-15, “Trace definition (Define Trace) menu,” on page 367.	SIMFCHAR
return	Returns to Table B-14, “Display (Display) menu (2/2),” on page 366.	(N/A)

Table B-19 Equivalent circuit selection (Select Circ) menu

Key operation: [Display] - more 1/2 - EQUIV CKT - SELECT CIRCUIT

Softkey	Function	GPIB command
A 	Selects equivalent circuit A. Equivalent circuit A is generally suitable for the equivalent circuit analysis of inductors with high core loss.	EQUC CIRA
B 	Selects equivalent circuit B. Equivalent circuit B is generally suitable for the equivalent circuit analysis of inductors with high winding resistance or resistors with low resistance value.	EQUC CIRB
C 	Selects equivalent circuit C. Equivalent circuit C is generally suitable for the equivalent circuit analysis of resistors with high resistance value.	EQUC CIRC
D 	Selects equivalent circuit D. Equivalent circuit D is generally suitable for the equivalent circuit analysis of capacitors.	EQUC CIRD
E	Selects equivalent circuit E. Equivalent circuit E is generally suitable for the equivalent circuit analysis of oscillators (vibrators).	EQUC CIRE
CALC PARMS	Has the same function as the CALCULATE PARAMETERS key in Table B-18, "Equivalent circuit analysis (Equiv Circuit) menu," on page 368.	CALECPARA
SIMULATE F-CHRST	Has the same function as the SIMULATE F-CHRST key in Table B-18, "Equivalent circuit analysis (Equiv Circuit) menu," on page 368.	SIMFCHAR
return	Returns to Table B-18, "Equivalent circuit analysis (Equiv Circuit) menu," on page 368.	(N/A)

Table B-20 Equivalent circuit parameter definition (Define Param) menu

Key operation: [Display] - more 1/2 - EQUIV CKT - DEFINE PARAMETERS

Softkey	Function	GPIB command
R1	Sets a value of equivalent circuit parameter R1.	DEFECR1 <value>
C1	Sets a value of equivalent circuit parameter C1.	DEFECC1 <value>
L1	Sets a value of equivalent circuit parameter L1.	DEFECL1 <value>
C0	Sets a value of current equivalent circuit parameter C0. You can set C0 only when equivalent circuit E has been selected in Table B-19, "Equivalent circuit selection (Select Circ) menu," on page 369.	DEFECC0 <value>
SIMULATE F-CHRST	Has the same function as the SIMULATE F-CHRST key in Table B-18, "Equivalent circuit analysis (Equiv Circuit) menu," on page 368.	SIMFCHAR
return	Returns to Table B-18, "Equivalent circuit analysis (Equiv Circuit) menu," on page 368.	(N/A)

Table B-21 Display allocation (Disp Alloc) menu

Key operation: [Display] - more 1/2 - ALLOCATION

Softkey	Function	GPIB command
ALL INSTRUMENT 	Uses the entire screen as the instrument screen ¹ .	DISA ALLI

Key Definitions
Softkeys displayed by pressing the [Display] key

Table B-21 Display allocation (Disp Alloc) menu

Key operation: [Display] - more 1/2 - ALLOCATION

Softkey	Function	GPIB command
HALF INSTR HALF BASIC 	Uses the upper half of the screen as the instrument screen ¹ and the lower half as the HP Instrument BASIC screen ² .	DISA HIHB
ALL BASIC 	Uses the entire screen as the HP Instrument BASIC screen ² .	DISA ALLB
BASIC STATUS	Allocates status lines (3 lines) for HP Instrument BASIC below the instrument screen ¹ .	DISA BASS
return	Returns to Table B-14, “Display (Display) menu (2/2),” on page 366.	(N/A)

1. The internal function of the 4294A can be divided into “instrument” and “HP Instrument BASIC” to control it. The instrument screen means the screen used to display the information of “instrument.” It is used to display scales and traces of measurement results, the list sweep table, the limit line table, and so on.
2. The internal function of the 4294A can be divided into “instrument” and “HP Instrument BASIC” to control it. The HP Instrument BASIC screen means the screen used to display the information of HP Instrument BASIC. It is used to display program lists, file lists, statuses, and so on.

Table B-22 Display color modification (Modify Color) menu

Key operation: [Display] - more 1/2 - MODIFY COLOR

Softkey	Function	GPIB command
INTENSITY	Sets the intensity of information displayed on the screen (text, graphics) in a percentage of the maximum value.	INTE <value>
BACKGROUND INTENSITY	Sets the background intensity on the screen in a percentage of white balance.	BACI <value>
MODIFY ITEM COLOR ➤	Displays Table B-23, “Item color modification (Color Item) menu (1/3),” on page 370.	(N/A)
DEFAULT COLORS	Returns all color configurations of items displayed on the screen to the factory default states.	DEFC
return	Returns to Table B-14, “Display (Display) menu (2/2),” on page 366.	(N/A)

Table B-23 Item color modification (Color Item) menu (1/3)

Key operation: [Display] - more 1/2 - MODIFY COLOR - MODIFY ITEM COLOR

Softkey	Function	GPIB command
MODIFY COLOR ➤	Displays Table B-26, “Item color entry (Color Item) menu,” on page 372.	(N/A)
TRC A DATA 	Selects the trace A data trace as the display item that can be changed with the MODIFY COLOR key.	COLO TRAD
TRC A MEM LIMIT LINE 	Selects the trace A memory trace, scale reference lines, and limit lines as the display items that can be changed with the MODIFY COLOR key.	COLO TRAM
TRC B DATA 	Selects the trace B data trace as the display item that can be changed with the MODIFY COLOR key.	COLO TRBD

Table B-23 Item color modification (Color Item) menu (1/3)

Key operation: [Display] - more 1/2 - MODIFY COLOR - MODIFY ITEM COLOR

Softkey	Function	GPIB command
TRC B MEM LIMIT LINE 	Selects the trace B memory trace, scale reference lines, and limit lines as the display items that can be changed with the MODIFY COLOR key.	COLO TRBM
GRATICULE	Selects the graph grid as the display item that can be changed with the MODIFY COLOR key.	COLO GRAT
more 1/3	Displays Table B-24, “Item color modification (Color Item) menu (2/3),” on page 371.	(N/A)
return	Returns to Table B-22, “Display color modification (Modify Color) menu,” on page 370.	(N/A)

Table B-24 Item color modification (Color Item) menu (2/3)

Key operation: [Display] - more 1/2 - MODIFY COLOR - MODIFY ITEM COLOR - more 1/3

Softkey	Function	GPIB command
MODIFY COLOR ►	Displays Table B-26, “Item color entry (Color Item) menu,” on page 372.	(N/A)
WARNING 	Selects warning messages as the display item that can be changed with the MODIFY COLOR key.	COLO WARN
TEXT MARKER 	Selects text in display modes other than graph display (equivalent circuit diagram, list sweep table), softkey labels, and markers themselves (Δ , ∇) as the display items that can be changed with the MODIFY COLOR key.	COLO TEXT
IBASIC 	Selects text on the HP Instrument BASIC screen as the display item that can be changed with the MODIFY COLOR key.	COLO IBT
PEN 1 	Selects PEN 1 ¹ as the display item that can be changed with the MODIFY COLOR key.	COLO PEN1
PEN 2	Selects PEN 2 ¹ as the display item that can be changed with the MODIFY COLOR key.	COLO PEN2
more 2/3	Displays Table B-25, “Item color modification (Color Item) menu (3/3),” on page 371.	(N/A)
return	Returns to Table B-22, “Display color modification (Modify Color) menu,” on page 370.	(N/A)

1. These pens can be used to draw graphics by specifying them in HP Instrument BASIC programs.

Table B-25 Item color modification (Color Item) menu (3/3)

Key operation: [Display] - more 1/2 - MODIFY COLOR - MODIFY ITEM COLOR - more 1/3 - more 2/3

Softkey	Function	GPIB command
MODIFY COLOR ►	Displays Table B-26, “Item color entry (Color Item) menu,” on page 372.	(N/A)
PEN 3 	Selects PEN 3 ¹ as the display item that can be changed with the MODIFY COLOR key.	COLO PEN3

Key Definitions
Softkeys displayed by pressing the [Display] key

Table B-25 Item color modification (Color Item) menu (3/3)

Key operation: [Display] - more 1/2 - MODIFY COLOR - MODIFY ITEM COLOR - more 1/3
 - more 2/3

Softkey	Function	GPIB command
PEN 4 	Selects PEN 4 ¹ as the display item that can be changed with the MODIFY COLOR key.	COLO PEN4
PEN 5 	Selects PEN 5 ¹ as the display item that can be changed with the MODIFY COLOR key.	COLO PEN5
PEN 6	Selects PEN 6 ¹ as the display item that can be changed with the MODIFY COLOR key.	COLO PEN6
more 3/3	Displays Table B-23, "Item color modification (Color Item) menu (1/3)," on page 370.	(N/A)
return	Returns to Table B-22, "Display color modification (Modify Color) menu," on page 370.	(N/A)

1. These pens can be used to draw graphics by specifying them in HP Instrument BASIC programs.

Table B-26 Item color entry (Color Item) menu

Key operation: [Display] - more 1/2 - MODIFY COLOR - MODIFY ITEM COLOR
 - MODIFY COLOR
 [Display] - more 1/2 - MODIFY COLOR - MODIFY ITEM COLOR - more 1/3
 - MODIFY COLOR
 [Display] - more 1/2 - MODIFY COLOR - MODIFY ITEM COLOR - more 1/3
 - more 2/3 - MODIFY COLOR

Softkey	Function	GPIB command
TINT	Adjusts tint ¹ of the displayed items you have chosen from Table B-23, "Item color modification (Color Item) menu (1/3)," on page 370, Table B-24, "Item color modification (Color Item) menu (2/3)," on page 371, or Table B-25, "Item color modification (Color Item) menu (3/3)," on page 371.	TINT <value>
BRIGHTNESS	Adjusts color brightness of the displayed items you have chosen from Table B-23, "Item color modification (Color Item) menu (1/3)," on page 370, Table B-24, "Item color modification (Color Item) menu (2/3)," on page 371, or Table B-25, "Item color modification (Color Item) menu (3/3)," on page 371.	CBRI <value>
COLOR	Adjusts chromaticity ² of the displayed items you have chosen from Table B-23, "Item color modification (Color Item) menu (1/3)," on page 370, Table B-24, "Item color modification (Color Item) menu (2/3)," on page 371, or Table B-25, "Item color modification (Color Item) menu (3/3)," on page 371.	COLOR <value>
RESET COLOR	Returns the above 3 parameters for the displayed items you have chosen from Table B-23, "Item color modification (Color Item) menu (1/3)," on page 370, Table B-24, "Item color modification (Color Item) menu (2/3)," on page 371, or Table B-25, "Item color modification (Color Item) menu (3/3)," on page 371 to the factory states.	RSCO
return	Returns to the higher-level menu that called this menu (Table B-23, "Item color modification (Color Item) menu (1/3)," on page 370, Table B-24, "Item color modification (Color Item) menu (2/3)," on page 371 or Table B-25, "Item color modification (Color Item) menu (3/3)," on page 371).	(N/A)

1. Color continuity of the tint circle in which color changes from red, to green, to blue, to black, and back to red.
 2. The degree of whiteness of color (from white to pure color).

Softkeys displayed by pressing the [Scale Ref] key

Table B-27 Scale reference (Scale Ref) menu (1-1/2)

Key operation: [Scale Ref]¹

Softkey	Function	GPIB command
AUTO SCALE	For the selected trace (data trace/memory trace of trace A/B), executes automatic scale adjustment based on the trace data when the key is pressed. The trace is magnified and displayed so that the graph contains the entire data, allowing you to easily grasp the overall characteristics. You can select the data trace or the memory trace with the SCALE FOR [] key in Table B-28, "Scale reference (Scale Ref) menu (1-2/2)," on page 373.	AUTO
SCALE/DIV	For the selected trace (data trace/memory trace of trace A/B), sets a value for the scale per division in the axis for measured value. This is one of the scale configurations using REFERENCE POSITION, REFERENCE VALUE, and SCALE/DIV.	SCAL <value>
REFERENCE POSITION	For the selected trace (data trace/memory trace of trace A/B), sets the position of the scale reference line. The position of the reference line is indicated by a value, assuming that the lowest line of the graph is 0 and the highest line is 10. This is one of the scale configurations using REFERENCE POSITION, REFERENCE VALUE, and SCALE/DIV.	REFP <value>
REFERENCE VALUE	For the selected trace (data trace/memory trace of trace A/B), sets a reference value (the value of the scale reference line). This is one of the scale configurations using REFERENCE POSITION, REFERENCE VALUE, and SCALE/DIV.	REFV <value>
MKR → REFERENCE	For the selected trace (data trace/memory trace of trace A/B), substitutes the absolute value of the main marker into the reference value (the value of the scale reference line) regardless of the value of the Δ marker. As a result, the marker moves to the reference line position.	MKRREF
TOP VALUE	Sets a value of the top line in the scale graph. This is one of the scale configurations using TOP VALUE and BOTTOM VALUE.	TOPV <value>
BOTTOM VALUE	Sets a value of the bottom line in the scale graph. This is one of the scale configurations using TOP VALUE and BOTTOM VALUE.	BOTV <value>
more 1/2	Displays Table B-28, "Scale reference (Scale Ref) menu (1-2/2)," on page 373.	(N/A)

1. When the measurement parameter is not COMPLEX Z-Y and the vertical axis is in the linear or percentage format.

Table B-28 Scale reference (Scale Ref) menu (1-2/2)

Key operation: [Scale Ref] - more1/2

Softkey	Function	GPIB command
SCALE FOR []	When both the data trace and the memory trace are displayed on the screen, selects the kind of trace to which the scale configurations in Table B-27, "Scale reference (Scale Ref) menu (1-1/2)," on page 373 are applied from the data trace [DATA] or the memory trace [MEMO].	SCAF {DATA MEMO}
D&M COUPLE ON off	When both the data trace and the memory trace are displayed on the screen, selects performing the scale configurations in Table B-27, "Scale reference (Scale Ref) menu (1-1/2)," on page 373 for both the data trace and the memory trace together (couple on) or for each of them separately (couple off).	SCAC {ON OFF}

Key Definitions
Softkeys displayed by pressing the [Scale Ref] key

Table B-28 Scale reference (Scale Ref) menu (1-2/2)

Key operation: [Scale Ref] - more1/2

Softkey	Function	GPIB command
more 2/2	Displays Table B-27, "Scale reference (Scale Ref) menu (1-1/2)," on page 373.	(N/A)

Table B-29 Scale reference (Scale Ref) menu (2)

Key operation: [Scale Ref]¹

Softkey	Function	GPIB command
AUTO SCALE	For the selected trace (data trace/memory trace of trace A/B), executes automatic scale adjustment based on the trace data when the key is pressed. The trace is magnified and displayed so that the graph contains the data of all sweep points, allowing you to easily grasp the overall characteristics. You can select the data trace or the memory trace with the SCALE FOR [] key in this menu.	AUTO
TOP VALUE	Sets a value of the top line in the scale graph. This is one of the scale configurations using TOP VALUE and BOTTOM VALUE.	TOPV <value>
BOTTOM VALUE	Sets a value of the bottom line in the scale graph. This is one of the scale configurations using TOP VALUE and BOTTOM VALUE.	BOTV <value>
SCALE FOR []	When both the data trace and the memory trace are displayed on the screen, selects the kind of trace to which the scale configurations in this menu are applied as either data trace [DATA] or memory trace [MEMO].	SCAF {DATA MEMO}
D&M COUPLE ON off	When both the data trace and the memory trace are displayed on the screen, selects performing the scale configurations in this menu for both the data trace and the memory trace together (couple on) or for each of them separately (couple off).	SCAC {ON OFF}

1. When the measurement parameter is not COMPLEX Z-Y and the vertical axis is log display. (Key operation: [Format] - LOG)

Table B-30 Scale reference (Scale Ref) menu (3)

Key operation: [Scale Ref]¹

Softkey	Function	GPIB command
AUTO SCALE	For the selected trace (data trace/memory trace of trace A/B), executes automatic scale adjustment based on the trace data when the key is pressed. The trace is magnified and displayed so that the graph contains the data of all sweep points, allowing you to easily grasp the overall characteristics. You can select the data trace or the memory trace with the SCALE FOR [] key in this menu.	AUTO
SCALE/DIV	For the selected trace (data trace/memory trace of trace A/B), sets the amount of each scale tick. This configuration is applied commonly to the vertical (Y) axis scale and the horizontal (X) axis scale.	SCAL <value>
REFERENCE X VALUE	Sets a value of the reference line of the horizontal (X) axis (always located at the center of the horizontal axis).	REFX <value>
REFERENCE Y VALUE	Sets a value of the reference line of the vertical (Y) axis (always located at the center of the vertical axis).	REFY <value>
SCALE FOR []	When both the data trace and the memory trace are displayed on the screen, selects the kind of trace to which the scale configurations in this menu are applied as either data trace [DATA] or memory trace [MEMO].	SCAF {DATA MEMO}

Table B-30 Scale reference (Scale Ref) menu (3)Key operation: [Scale Ref]¹

Softkey	Function	GPIB command
D&M COUPLE ON OFF	When both the data trace and the memory trace are displayed on the screen, selects performing the scale configurations in this menu for both the data trace and the memory trace together (couple on) or for each of them separately (couple off).	SCAC {ON OFF}

1. When the measurement parameter is COMPLEX Z-Y and the display format is COMPLEX.
(Key operation: [Meas] - more 1/3 - more 2/3 - COMPLEX Z-Y, [Format] - COMPLEX)

Table B-31 Scale reference (Scale Ref) menu (4)Key operation: [Scale Ref]¹

Softkey	Function	GPIB command
AUTO SCALE	For the selected trace (data trace/memory trace of trace A/B), executes automatic scale adjustment based on the trace data when the key is pressed. The trace is magnified and displayed so that the graph contains the data of all sweep points, allowing you to easily grasp the overall characteristics. You can select the data trace or the memory trace with the SCALE FOR [] key in this menu.	AUTO
FULLSCALE VALUE	Sets a scale value of the outermost circle in the polar coordinates display (the distance between the origin and the outermost circle).	REFV <value>
MKR → REFERENCE	For the selected trace (data trace/memory trace of trace A/B), substitutes the absolute value of the marker, regardless of the Δ marker value, into the full scale value of the outermost circle in the polar coordinates display. As a result, the marker moves to the full scale line position.	MKRREF
SCALE FOR []	When both the data trace and the memory trace are displayed on the screen, selects the kind of trace to which the scale configurations in this menu are applied as either data trace [DATA] or memory trace [MEMO].	SCAF {DATA MEMO}
D&M COUPLE ON off	When both the data trace and the memory trace are displayed on the screen, selects performing the scale setting in this menu for both the data trace and the memory trace together (couple on) or for each of them separately (couple off).	SCAC {ON OFF}

1. When the measurement parameter is COMPLEX Z-Y and the display format is POLAR.
(Key operation: [Meas] - more 1/3 - more 2/3 - COMPLEX Z-Y, [Format] - POLAR)

Softkeys displayed by pressing the [Bw/Avg] key

Table B-32 Measurement bandwidth/averaging (Bw/Average) menu

Key operation: [Bw/Avg]

Softkey	Function	GPIB command
BANDWIDTH [] ►	Displays Table B-33, “Measurement bandwidth (Bandwidth) configuration menu,” on page 376. In [], the currently selected measurement bandwidth is displayed.	(N/A)
AVERAGING RESTART	Resets the sweep-to-sweep averaging function so that the sweep count starts from CP at the next sweep. The sweep count of the sweep-to-sweep averaging is displayed in the upper left area of the screen.	AVERREST
AVERAGING on OFF	For both A and B traces, toggles on and off the averaging (sweep-to-sweep averaging) function that, based on the sweep data obtained as many times as the specified count, executes averaging and displays the result. When the averaging function is on, based on an exponential average of consecutive sweeps weighted by an averaging factor specified by the user with the AVERAGING FACTOR key, each data point (vector value) is calculated and the data is displayed. The numeric value, displayed below “Avg” in the status indication field in the upper left area of the screen, indicates the number of past sweeps to be used for averaging the current trace. The number becomes effective when the current sweep is completed. Immediately after the averaging function is turned on, there is no past sweep data and so the count starts from 0. If you restart the averaging with the AVERAGING RESTART key or you change instrument states that affect measured data, the averaging sweep count is reset to 0. After that, data is averaged over the available data at that time, and the displayed trace is updated each time a new sweep is performed until the count reaches the averaging count specified with the AVERAGING FACTOR key. When the count reaches the specified averaging count, averaging is performed over the past trace data measured as many times as the specified averaging factor, including the new measured data, and the resulting data are displayed. Refer to Equation 5-1 on page 126 for the algorithm of the sweep-to-sweep averaging.	AVER {ON OFF}
AVERAGING FACTOR	Sets the averaging count for the sweep-to-sweep averaging. Specify an integer between 1 and 256.	AVERFACT <value>
POINT AVG on OFF	For both the A and B traces, toggles on and off the averaging (point averaging) function that executes averaging of the data of the specified count at each measurement point and displays the result.	PAVER {ON OFF}
POINT AVG FACTOR	Sets the averaging count for the point averaging. Specify an integer between 1 and 256. Refer to Equation 5-2 on page 128 for the algorithm of the point averaging.	PAVERFACT <value>

Table B-33 Measurement bandwidth (Bandwidth) configuration menu

Key operation: [Bw/Avg] - BAND WIDTH []
[Sweep] - EDIT LIST - EDIT/ADD - more 1/3 - more 2/3 - BAND WIDTH []

Softkey	Function	GPIB command
1 FAST 	Selects 1 as the measurement bandwidth (during list sweep segment edit, sets the measurement bandwidth of the segment to 1). The measurement speed is fastest.	BWFACT 1
2 	Selects 2 as the measurement bandwidth (during list sweep segment edit, sets the measurement bandwidth of the segment to 2).	BWFACT 2

Table B-33 Measurement bandwidth (Bandwidth) configuration menu

Key operation: [Bw/Avg] - BAND WIDTH []
 [Sweep] - EDIT LIST - EDIT/ADD - more 1/3 - more 2/3 - BAND WIDTH []

Softkey	Function	GPIB command
3 	Selects 3 as the measurement bandwidth (during list sweep segment edit, sets the measurement bandwidth of the segment to 3).	BWFACT 3
4 	Selects 4 as the measurement bandwidth (during list sweep segment edit, sets the measurement bandwidth of the segment to 4).	BWFACT 4
5 PRECISE	Selects 5 as the measurement bandwidth (during list sweep segment edit, sets the measurement bandwidth of the segment to 5). The measurement accuracy is highest.	BWFACT 5
return	Returns to the higher-level menu (Table B-32, “Measurement bandwidth/averaging (Bw/Average) menu,” on page 376, or Table B-50, “Segment edit (Edit Segment) menu (3/3),” on page 386).	(N/A)

Softkeys displayed by pressing the [Cal] key

Table B-34 Calibration (Calibration) menu

Key operation: [Cal]

Softkey	Function	GPIB command
ADAPTER [] ►	Displays Table B-35, “Adapter configuration (Adapter) menu,” on page 378. In [] of the softkey label, the currently selected adapter configuration is displayed.	(N/A)
FIXTURE COMPEN ►	Displays Table B-37, “Fixture compensation (Fixture Comp) menu,” on page 380.	(N/A)
CAL POINT []	For fixture compensation (FIXTURE COMPEN) and user calibration (USER CAL), selects a preset single fixed frequency point [FIXED], which does not change regardless of conditions, or a frequency point determined by the user-specified sweep range [USER]. This configuration is commonly applied to both user calibration and fixture compensation.	CALP {FIXED USER}
USER CAL ►	Displays Table B-39, “User calibration (User Cal) menu,” on page 381. This key is valid only when 7-mm 42942A or PROBE 42941A has been selected with the ADAPTER [] key.	(N/A)
PORT EXTENSION ►	Displays Table B-42, “Port extension (Prt Extension) menu,” on page 382. This key is valid only when 7-mm 42942A or PROBE 42941A has been selected with the ADAPTER [] key.	(N/A)

Table B-35 Adapter configuration (Adapter) menu

Key operation: [Cal] - ADAPTER []

Softkey	Function	GPIB command
NONE 	You select this key when using no extension cable from the measurement terminal on the front panel to connect a DUT during four-terminal pair measurement. This is the proper configuration when using the HP 16047E test fixture (direct-coupled fixture for devices with leads) and similar devices.	E4TP OFF
4TP 1M 	You select this key when using a 1-m extension cable from the measurement terminal on the front panel to connect a DUT during four-terminal pair measurement. This is the proper configuration when using the HP 16048G test cable (4TP 1m cable).	E4TP M1
4TP 2M 	You select this key when using a 2-m extension cable from the measurement terminal on the front panel to connect a DUT during four-terminal pair measurement. This is the proper configuration when using the HP 16048H test cable (4TP 2m cable).	E4TP M2
7mm 42942A 	You select this key when connecting the HP 42942A Terminal Adapter to the measurement terminal on the front panel.	E4TP APC7
PROBE 42941A	You select this key when connecting the HP 42941A Impedance Probe to the measurement terminal on the front panel.	E4TP PROBE

Table B-35 Adapter configuration (Adapter) menu

Key operation: [Cal] - ADAPTER []

Softkey	Function	GPIB command
SETUP ►	Displays Table B-36, “Adapter setup (Adapter Setup) menu,” on page 379. If you select an adapter configuration corresponding to a key other than the NONE key (HP 16047E test fixture, etc.), you have to enter this menu when you use the adapter (4TP 1M, 4TP 2M, 7mm 42942A, PROBE 42941A) for the first time and measure the calibration standard. The setup data of adapters once set up are stored in the internal non-volatile memory of the 4294A, and therefore re-setup is not required under normal conditions. If the NONE key is selected as the adapter configuration, this SETUP key is invalid (setup is not required).	(N/A)
return	Returns to Table B-34, “Calibration (Calibration) menu,” on page 378.	(N/A)

Table B-36 Adapter setup (Adapter Setup) menu

Key operation: [Cal] - ADAPTER [] - SETUP

Softkey	Function	GPIB command
PHASE COMP []	Executes the measurement of the phase compensation data. The content of [] is - before the data acquisition and changes to DONE after the data acquisition. If the 4TP 1M key, 4TP 2M key, 7mm 42942A key, or PROBE 42941A key has been selected in Table B-35, “Adapter configuration (Adapter) menu,” on page 378, this phase compensation data must be measured.	ECALP
OPEN []	Executes the measurement of the OPEN data. The content of [] is - before the data acquisition and changes to DONE after the data acquisition. If the 7mm 42942A key or PROBE 42941A key has been selected in Table B-35, “Adapter configuration (Adapter) menu,” on page 378, this OPEN data must be measured. Otherwise, the measurement of the OPEN data is not required (OPEN [] key is invalid).	ECALA
SHORT []	Executes the measurement of the SHORT data. The content of [] is - before the data acquisition and changes to DONE after the data acquisition. If the 7mm 42942A key or PROBE 42941A key has been selected in Table B-35, “Adapter configuration (Adapter) menu,” on page 378, this SHORT data must be measured. Otherwise, the measurement of the SHORT data is not required (SHORT [] key is invalid).	ECALB
LOAD []	Executes the measurement of the LOAD data. The contents of [] is - before the data acquisition, and changes to DONE after the data acquisition. If the 4TP 1M key, 4TP 2M key, 7mm 42942A key, or PROBE 42941A key has been selected in Table B-35, “Adapter configuration (Adapter) menu,” on page 378, this LOAD data must be measured.	ECALC
done	Based on the above acquired data, calculates the setup data for the selected adapter and stores it in the internal non-volatile memory of the 4294A. For adapters whose setup data is once acquired, re-setup is not required under normal conditions. Executing this key returns to Table B-35, “Adapter configuration (Adapter) menu,” on page 378.	ECALDON
cancel	Cancels the setup for the selected adapter and returns to Table B-35, “Adapter configuration (Adapter) menu,” on page 378. Setup data previously executed is valid.	ECALQUI

Key Definitions
Softkeys displayed by pressing the [Cal] key

Table B-37 Fixture compensation (Fixture Comp) menu

Key operation: [Cal] - FIXTURE COMPEN

Softkey	Function	GPIB command
OPEN on OFF	Validates/invalidates (turns on/off) the OPEN correction of the fixture compensation for measurements. If the measurement of the OPEN data using the OPEN key and the storage of the compensation coefficient have not been performed, this key cannot be toggled on and off.	COMSTA {ON OFF}
SHORT on OFF	Validates/invalidates (turns on/off) the SHORT correction of the fixture compensation for measurements. If the measurement of the SHORT data using the SHORT key and the storage of the compensation coefficient have not been performed, this key cannot be toggled on and off.	COMSTB {ON OFF}
LOAD on OFF	Validates/invalidates (turns on/off) the LOAD correction of the fixture compensation for measurements. If the measurement of the LOAD data using the LOAD key and the storage of the compensation coefficient have not been performed, this key cannot be toggled on and off.	COMSTC {ON OFF}
OPEN	Executes the measurement of the OPEN data and stores the compensation coefficient. After completion, the OPEN correction function is automatically turned on.	COMA
SHORT	Executes the measurement of the SHORT data and stores the compensation coefficient. After completion, the SHORT correction function is automatically turned on.	COMB
LOAD	Executes the measurement of the LOAD data and stores the compensation coefficient. After completion, the LOAD correction function is automatically turned on.	COMC
DEFINE VALUE ►	Displays Table B-38, “Calibration data definition (Define Value) menu,” on page 380.	(N/A)
return	Returns to Table B-34, “Calibration (Calibration) menu,” on page 378.	(N/A)

Table B-38 Calibration data definition (Define Value) menu

Key operation: [Cal] - USER CAL - DEFINE VALUE
[Cal] - FIXTURE COMPEN - DEFINE VALUE

Softkey	Function	GPIB command
OPEN CONDUCT (G)	Sets the conductance value (G) of the OPEN standard you use ¹ .	DCALOPENG <value>
OPEN CAP (C)	Sets the capacitance value (C) of the OPEN standard you use ¹ .	DCALOPENC <value>
SHORT RESIST (R)	Sets the resistance value (R) of the SHORT standard you use ¹ .	DCALSHORR <value>
SHORT INDUCT (L)	Sets the inductance value (L) of the SHORT standard you use ¹ .	DCALSHORL <value>
LOAD RESIST (R)	Sets the resistance value (R) of the LOAD standard you use ¹ .	DCALLOADR <value>
LOAD INDUCT (L)	Sets the inductance value (L) of the LOAD standard you use ¹ .	DCALLOADL <value>
return	Returns to the higher-level menu that called this menu (Table B-39, “User calibration (User Cal) menu,” on page 381 or Table B-37, “Fixture compensation (Fixture Comp) menu,” on page 380).	(N/A)

1. These set values are stored separately for user calibration or fixture compensation.

Table B-39 User calibration (User Cal) menu

Key operation: [Cal] - USER CAL

Softkey	Function	GPIB command
CORRECTION on OFF	Toggles on and off applying the user calibration to measurements. The user calibration is done by using a user's unique calibration kit (OPEN, SHORT, LOAD) whose values are defined by the user. If you use the calibration kit attached to the 4294A or its accessories, this user calibration function is not used.	CALST {ON OFF}
EXECUTE CAL ►	Displays Table B-40, "Calibration execution (Execute Cal) menu," on page 381.	(N/A)
DEFINE VALUE ►	Displays Table B-38, "Calibration data definition (Define Value) menu," on page 380.	(N/A)
return	Returns to Table B-34, "Calibration (Calibration) menu," on page 378.	(N/A)

Table B-40 Calibration execution (Execute Cal) menu

Key operation: [Cal] - USER CAL - EXECUTE CAL

Softkey	Function	GPIB command
OPEN []	Executes the measurement of the OPEN data. The content of [] is - before the data acquisition and changes to DONE after the data acquisition.	CALA
SHORT []	Executes the measurement of the SHORT data. The content of [] is - before the data acquisition and changes to DONE after the data acquisition.	CALB
LOAD []	Executes the measurement of the LOAD data. The content of [] is - before the data acquisition and changes to DONE after the data acquisition.	CALC
done	Calculates the error coefficient and stores it based on the three kinds of acquired calibration data: OPEN, SHORT, and LOAD. Executing this key returns to Table B-39, "User calibration (User Cal) menu," on page 381, and the user calibration function is automatically turned on. (The softkey label changes to CORRECTION ON off.)	CALDON
cancel	Cancels the acquisition of the calibration data and returns to Table B-39, "User calibration (User Cal) menu," on page 381.	CALQUI

Table B-41 Calibration data definition for user calibration (Define Value) menu

Key operation: [Cal] - USER CAL - DEFINE VALUE

Softkey	Function	GPIB command
OPEN CONDUCT (G)	Sets the conductance value (G) of the OPEN standard you use ¹ .	DCALOPENG <value>
OPEN CAP (C)	Sets the capacitance value (C) of the OPEN standard you use ¹ .	DCALOPENC <value>
SHORT RESIST (R)	Sets the resistance value (R) of the SHORT standard you use ¹ .	DCALSHORR <value>
SHORT INDUCT (L)	Sets the inductance value (L) of the SHORT standard you use ¹ .	DCALSHORL <value>
LOAD RESIST (R)	Sets the resistance value (R) of the LOAD standard you use ¹ .	DCALLOADR <value>
LOAD INDUCT (L)	Sets the inductance value (L) of the LOAD standard you use ¹ .	DCALLOADL <value>
return	Returns to Table B-39, "User calibration (User Cal) menu," on page 381	(N/A)

Key Definitions

Softkeys displayed by pressing the [Cal] key

1. Though the softkey labels are the same as those in Table B-38, "Calibration data definition (Define Value) menu," on page 380, the set values are saved separately.

Table B-42 Port extension (Prt Extension) menu

Key operation: [Cal] - PORT EXTENSION

Softkey	Function	GPIB command
EXTENSION on OFF	Toggles on and off the port extension compensation. The port extension compensation means compensation performed to extend the measurement terminal surface from the 7-mm port of the HP 42942A Terminal Adapter or the 3.5-mm port at the tip of the HP 42941A probe, maintaining a 1-port configuration. Enter a value in electrical length or delay time.	PORE {ON OFF}
VALUE (TIME)	Enters a value of the extended port in delay time (seconds). The electrical length corresponding to the entered delay time is displayed below the parameter entry line in smaller characters.	PORTZ <value>
VALUE (LENGTH)	Enters a value of the extended port in electrical length (meters). The delay time corresponding to the entered electrical length is displayed below the parameter entry line in smaller characters.	PORTL <value>
return	Returns to Table B-39, "User calibration (User Cal) menu," on page 381.	(N/A)

Softkeys displayed by pressing the [Sweep] key

Table B-43 Sweep (Sweep) menu

Key operation: [Sweep]

Softkey	Function	GPIB command
PARAMETER [] ►	Displays Table B-44, “Sweep parameter (Sweep Param) menu,” on page 383. In [] of the softkey label, the currently selected sweep parameter is displayed (frequency sweep [FREQ], signal level sweep [OLEV], or dc bias sweep [DCB]).	(N/A)
NUMBER OF POINTS	Sets the number of measurement points per sweep (number of points, NOP) when the sweep type is not LIST (LINEAR or LOG). Enter an integer between 2 and 801. You set the number of points for list sweep in the list sweep table.	POIN <value>
DIRECTION []	Switches the sweep direction between upward [UP] and downward [DOWN]. The upward direction is the direction in which the sweep parameter value increases; the downward direction is the direction in which the sweep parameter value decreases.	SWED {UP DOWN}
MANUAL SWP on OFF	Toggles on and off the manual sweep function. Immediately after pressing the MANUAL SWP on OFF key, you can freely move to one of the specified sweep points (1–number of points) with the rotary knob, step keys ([↑], [↓]), or numeric entry keys and perform measurements at the point. If the manual sweep function is set to on, you can also enter sweep points (1–number of points) with the [sweep] key.	MANS <value>
TIME ►	Displays Table B-45, “Sweep time (Sweep Time) menu,” on page 384.	(N/A)
TYPE [] ►	Displays Table B-46, “Sweep type (Sweep Type) menu,” on page 384. In [] of the softkey label, the currently selected sweep type is displayed (linear sweep [LINEAR], log sweep [LOG], or list sweep [LIST]).	(N/A)
EDIT LIST ►	Displays Table B-47, “List sweep (List Sweep) menu,” on page 384.	EDITLIST
LIST SPAN []	Switches the list span (configuration of the horizontal axis of the graph in list sweep) between single span [SINGLE] or segment span [SEGMENT]. Single span is a method to set the linear frequency axis as a horizontal axis whose left edge is the minimum frequency and whose right edge is the maximum frequency in the entire list sweep table. On the other hand, segment span is a method to set, as the horizontal axis of the graph, an axis in which the measurement points of each segment are equally positioned in the measurement order in the entire table from the left edge to right edge of the graph (measurement number order axis). If COMPLEX Z-Y has been selected as measurement parameter, there is no sweep parameter axis on the graph and therefore this configuration is invalid.	LISPAN {SINGLE SEGMENT}

Table B-44 Sweep parameter (Sweep Param) menu

Key operation: [Sweep] - PARAMETER []

Softkey	Function	GPIB command
FREQ 	Selects frequency as the sweep parameter.	SWPP FREQ
OSC LEVEL 	Selects oscillator level as the sweep parameter.	SWPP OLEV
DC BIAS	Selects dc bias as the sweep parameter.	SWPP DCB

Key Definitions
Softkeys displayed by pressing the [Sweep] key

Table B-44 Sweep parameter (Sweep Param) menu

Key operation: [Sweep] - PARAMETER []

Softkey	Function	GPIB command
return	Returns to Table B-43, "Sweep (Sweep) menu," on page 383.	(N/A)

Table B-45 Sweep time (Sweep Time) menu

Key operation: [Sweep] - TIME

Softkey	Function	GPIB command
SWEEP TIME	Sets sweep time.	SWET <value>
POINT DELAY	Sets the measurement start delay time for each measurement point.	PDEL T <value>
SWEEP DELAY	Sets the sweep start delay time for each sweep.	SDEL T <value>
return	Returns to Table B-43, "Sweep (Sweep) menu," on page 383.	(N/A)

Table B-46 Sweep type (Sweep Type) menu

Key operation: [Sweep] - TYPE []

Softkey	Function	GPIB command
LINEAR 	Selects the linear sweep as the sweep type. The linear sweep linearly allocates sweep points (measurement points) and performs sweeps within the sweep range specified by start and stop (or center and span).	SWPT LIN
LOG 	Selects the log (logarithmic) sweep as the sweep type. The log sweep logarithmically allocates sweep points (measurement points) and performs sweeps within the sweep range specified by start and stop (or center and span).	SWPT LOG
LIST	Selects the list sweep as the sweep type. Before selecting the list sweep, you must create a list sweep table with the EDIT LIST key in Table B-47, "List sweep (List Sweep) menu," on page 384.	SWPT LIST
return	Returns to Table B-43, "Sweep (Sweep) menu," on page 383.	(N/A)

Table B-47 List sweep (List Sweep) menu

Key operation: [Sweep] - EDIT LIST

Softkey	Function	GPIB command
SEGMENT	If there is a list sweep table, specify the segment number you want to edit. The currently specified segment is indicated by the pointer (>) in the SEG column at the leftmost area of the list sweep table.	SEGM <value>
EDIT >	Displays Table B-48, "Segment edit (Edit Segment) menu (1/3)," on page 385.	SEDI
DELETE	Executes the deletion of the segment specified by the pointer (>).	SDEL
ADD >	Displays Table B-48, "Segment edit (Edit Segment) menu (1/3)," on page 385.	SADD

Table B-47 List sweep (List Sweep) menu

Key operation: [Sweep] - EDIT LIST

Softkey	Function	GPIB command
PEN	Sets the pen number for the trace of the list sweep segment specified by the pointer (>). There are six graphics pens that have different colors. See Table B-24, "Item color modification (Color Item) menu (2/3)," on page 371, or Table B-25, "Item color modification (Color Item) menu (3/3)," on page 371 to modify each pen color.	SCOL
CLEAR LIST >	Displays Table B-52, "List deletion (Clear List?) menu," on page 387.	CLEL
done	Stores the edited list sweep table, and returns to Table B-43, "Sweep (Sweep) menu," on page 383.	EDITDONE
cancel	Cancels editing of the list sweep table and returns to Table B-43, "Sweep (Sweep) menu," on page 383.	(N/A)

Table B-48 Segment edit (Edit Segment) menu (1/3)

Key operation: [Sweep] - EDIT LIST - EDIT
[Sweep] - EDIT LIST - ADD

Softkey	Function	GPIB command
START	Sets the sweep start frequency of the list sweep segment ¹ .	STAR <value>
STOP	Sets the sweep stop frequency of the list sweep segment ¹ .	STOP <value>
CENTER	Sets the sweep center frequency of the list sweep segment ¹ .	CENT <value>
SPAN	Sets the sweep frequency span of the list sweep segment ¹ .	SPAN <value>
NUMBER OF POINTS	Sets the number of points in the list sweep segment. Specify a value between 2 and 201 as the number of sweep points per segment. Note that the maximum number of points in all segments is a total of 801.	POIN <value>
more 1/3	Displays Table B-49, "Segment edit (Edit Segment) menu (2/3)," on page 385.	(N/A)
done	Stores the edited list sweep segment and returns to Table B-47, "List sweep (List Sweep) menu," on page 384.	SDON
cancel	Cancels the editing of the list sweep segment and returns to Table B-47, "List sweep (List Sweep) menu," on page 384.	SQUI

1. The frequency range specified for each segment may overlap the frequency ranges of other segments.

Table B-49 Segment edit (Edit Segment) menu (2/3)

Key operation: [Sweep] - EDIT LIST - EDIT - more 1/3
[Sweep] - EDIT LIST - ADD - more 1/3

Softkey	Function	GPIB command
OSC MODE []	Switches the oscillator level of the list sweep segment between the voltage source mode [VOLT] and the current source mode [CURR].	POWMOD {VOLT CURR}
OSC LEVEL	Sets the oscillator level of the list sweep segment.	POWE <value>

Key Definitions
Softkeys displayed by pressing the [Sweep] key

Table B-49 Segment edit (Edit Segment) menu (2/3)

Key operation: [Sweep] - EDIT LIST - EDIT - more 1/3
[Sweep] - EDIT LIST - ADD - more 1/3

Softkey	Function	GPIB command
BIAS MODE [] ►	Displays Table B-51, “DC bias mode (DC Bias Mode) menu,” on page 387. In [] of the softkey label, the currently selected dc bias mode (voltage mode: [VOLT] or current mode: [CURR]) is displayed.	(N/A)
DC BIAS VOLTAGE	Sets the dc bias voltage of the segment.	DCV <value>
DC BIAS CURRENT	Sets the dc bias current of the segment.	DCI <value>
more 2/3	Displays Table B-50, “Segment edit (Edit Segment) menu (3/3),” on page 386.	(N/A)
done	Stores the edited list sweep segment and returns to Table B-47, “List sweep (List Sweep) menu,” on page 384.	SDON
cancel	Cancels the editing of the list sweep segment and returns to Table B-47, “List sweep (List Sweep) menu,” on page 384.	SQUI

Table B-50 Segment edit (Edit Segment) menu (3/3)

Key operation: [Sweep] - EDIT LIST - EDIT - more 1/3 - more 2/3
[Sweep] - EDIT LIST - ADD - more 1/3 - more 2/3

Softkey	Function	GPIB command
BANDWIDTH [] ►	Displays Table B-33, “Measurement bandwidth (Bandwidth) configuration menu,” on page 376. In [] of the softkey label, the currently selected measurement bandwidth is displayed.	(N/A)
POINT AVG FACTOR	Sets the point averaging factor for the segment (averaging count performed for each measurement point). Specify an integer between 1 and 256.	PAVERFACT <value>
MKR → START	Enters the frequency at the current marker position to the sweep start value of the segment.	MKRSTAR
MKR → STOP	Enters the frequency at the current marker position to the sweep stop value of the segment.	MKRSTOP
MKR → CENTER	Enters the frequency at the current marker position to the sweep center value of the segment.	MKRCENT
more 3/3	Displays Table B-48, “Segment edit (Edit Segment) menu (1/3),” on page 385.	(N/A)
done	Stores the edited list sweep segment and returns to Table B-47, “List sweep (List Sweep) menu,” on page 384.	SDON
cancel	Cancels the editing of the list sweep segment and returns to Table B-47, “List sweep (List Sweep) menu,” on page 384.	SQUI

Table B-51 DC bias mode (DC Bias Mode) menu

Key operation: [Sweep] - EDIT LIST - EDIT - more 1/3 - BIAS MODE []
 [Sweep] - EDIT LIST - ADD - more 1/3 - BIAS MODE []
 [Source] - more 1/2 - MODE []

Softkey	Function	GPIB command
VOLT 	Selects the voltage source as the dc bias source configuration.	DCMOD VOLT
CURRENT 	Selects the current source as the dc bias source configuration.	DCMOD CURR
VOLT CONSTANT 	Sets the constant voltage source as the dc bias source configuration. The output voltage is kept constant irrespective of the connected load. Note that the maximum current is restricted.	DCMOD CVOLT
CURRENT CONSTANT	Sets the constant current source as the dc bias source configuration. The output current is kept constant irrespective of the connected load. Note that the maximum voltage is restricted.	DCMOD CCURR
return	Returns to the higher-level menu (Table B-49, “Segment edit (Edit Segment) menu (2/3),” on page 385 or Table B-54, “DC bias (Source Bias) menu,” on page 388).	(N/A)

Table B-52 List deletion (Clear List?) menu

Key operation: [Sweep] - EDIT LIST - CLEAR LIST

Softkey	Function	GPIB command
yes	Deletes all contents of the currently edited list sweep table from the screen and returns to Table B-47, “List sweep (List Sweep) menu,” on page 384. However, even after all of the contents of the list sweep table have been deleted from the screen with this key, you can reset the previously stored list sweep table by pressing the cancel key in Table B-47, “List sweep (List Sweep) menu,” on page 384 without deleting its contents.	(N/A)
cancel	Cancels the deletion of the list sweep table from the screen and returns to Table B-47, “List sweep (List Sweep) menu,” on page 384.	(N/A)

Softkeys displayed by pressing the [Source] key

Table B-53 Source oscillator (Source Osc) menu

Key operation: [Source]

Softkey	Function	GPIB command
FREQUENCY	Sets the fixed oscillator frequency (CW frequency) when performing sweeps with a parameter other than frequency.	CWFREQ <value>
LEVEL	Sets the fixed oscillator level when performing sweeps with a parameter other than oscillator level.	POWE <value>
OSC UNIT []	Selects voltage [VOLT] or current [CURR] as the unit of oscillator level configuration. The unit set here is applied to both fixed oscillator level and oscillator level sweeps.	POWMOD {VOLT CURR}
BIAS MENU ►	Displays Table B-54, “DC bias (Source Bias) menu,” on page 388.	(N/A)

Table B-54 DC bias (Source Bias) menu

Key operation: [Source] - BIAS MENU

Softkey	Function	GPIB command
BIAS on OFF	Toggles on and off the dc bias output.	DCO {ON OFF}
MEAS RANGE [] ►	Displays Table B-55, “DC bias range (DC Bias Range) menu,” on page 388. The currently selected dc bias range is displayed ([<1mA], [<10mA], or [<100mA]) in [] of the softkey label.	(N/A)
MODE [] ►	Displays Table B-51, “DC bias mode (DC Bias Mode) menu,” on page 387. The currently selected dc bias mode is displayed (voltage source mode: [VOLT], current source mode: [CURR], constant voltage source mode: [C-VOLT], or constant current source mode: [C-CURR]) in [] of the softkey label.	(N/A)
VOLTAGE LEVEL	Sets the dc bias voltage level.	DCV <value>
CURRENT LEVEL	Sets the dc bias current level.	DCI <value>
MAX LIMIT VOLTAGE	Sets the voltage limit value (upper limit) when using the dc bias source in the constant current mode. Within the range that does not exceed this upper limit voltage, the constant current output of the dc bias operates.	MAXDCV <value>
MIN LIMIT VOLTAGE	Sets the current limit value (upper limit) when using the dc bias source in the constant voltage mode. Within the range that does not exceed this upper limit current, the constant voltage output of the dc bias operates.	MINDCV <value>
OSC MENU ►	Displays Table B-53, “Source oscillator (Source Osc) menu,” on page 388.	(N/A)

Table B-55 DC bias range (DC Bias Range) menu

Key operation: [Source] - BIAS MENU - MEAS RANGE []

Softkey	Function	GPIB command
1mA 	Selects < 1 mA (less than 1 mA) as the dc bias range ¹ .	DCRNG M1

Table B-55 DC bias range (DC Bias Range) menu

Key operation: [Source] - BIAS MENU - MEAS RANGE []

Softkey	Function	GPIB command
10mA 	Selects < 10 mA (less than 10 mA) as the dc bias range ¹ .	DCRNG M10
100mA	Selects < 100 mA (less than 100 mA) as the dc bias range ¹ .	DCRNG M100
return	Returns to Table B-54, "DC bias (Source Bias) menu," on page 388.	(N/A)

1. The dc bias range is set to optimize the dc level of the current that is inputted into the HP 4294A's impedance measurement circuit. This setting affects the impedance measurement accuracy, regardless of the selection of the dc bias mode or whether application of the dc bias is turned on or off. Usually, you can obtain the highest impedance measurement accuracy by setting the smallest dc bias range such that the "DCBIAS OVERLOAD" (error number: 137) error does not appear. When first applying the dc bias, set the dc bias range to 1 mA. Then, if an error occurs, increase the range as necessary to avoid this error. If you do not apply dc bias, be sure to set the range to 1 mA.

Softkeys displayed by pressing the [Trigger] key

Table B-56 Trigger (Trigger) menu

Key operation: [Trigger]

Softkey	Function	GPIB command
HOLD 	Selects the sweep stop. The status indication area at the left side of the screen shows "Hld." After the stop of the sweep, if "*" is displayed at the top of the status indication area, it indicates that the sweep was stopped before completion and therefore the data trace has not been updated completely. To update the data trace completely, press the SINGLE key to execute a new single sweep.	HOLD
SINGLE 	Performs a single sweep to update the data trace and then goes into the sweep stop status.	SING
NUMBER OF GROUPS 	Sets the sweep group count (the number of sweeps specified by users). When the user finishes entry of the sweep group count with the numeric keys, the sweeps are started. After the sweeps of the specified count, the sweep stop status occurs. If the sweep-to-sweep averaging function is on, specify a sweep group count equal to or larger than the averaging factor (count) to execute averaging completely. When the group count is entered, the averaging counter is reset to 0 and the sweeps are started. Specify an integer between 0 (no sweep) and 999 for the sweep group count.	NUMG <value>
CONTINUOUS	Selects the automatic continuous sweep mode. The trace is updated for each sweep.	CONT
SOURCE [] ▶	Displays Table B-57, "Trigger source (Trig source) menu," on page 390. In [] of the softkey label, the currently selected trigger source is displayed (internal trigger: [FREE RUN], external trigger input terminal: [EXTERNAL], GPIB/LAN: [HP-IB], or manual: [MANUAL]).	(N/A)

Table B-57 Trigger source (Trig source) menu

Key operation: [Trigger] - SOURCE []

Softkey	Function	GPIB command
FREE RUN 	Selects the internal trigger mode (free run), in which triggers are automatically generated inside the 4294A.	TRGS INT
EXTERNAL 	Selects triggers from the external trigger input terminal (BNC(f) connector) on the rear panel.	TRGS EXT
HP-IB/LAN 	Selects triggers via GPIB or LAN. If this mode is selected, you can generate triggers from the external controller using the *TRG command.	TRGS BUS
MANUAL	Selects manual triggering. After the selection, pressing the MANUAL key generates a single trigger.	TRGS MAN
EVENT []	Selects applying a trigger to each measurement point [ON POINT] or to each sweep [ON SWEEP]. This configuration is valid for each trigger mode of EXTERNAL, GPIB/LAN, and MANUAL described above. For FREE RUN, this key has no meaning.	TRGEVE {SWE POIN}
EXT POLRTY []	Selects the polarity of the trigger signal supplied from the external trigger input terminal on the rear panel. [POS] means positive polarity, and triggers are generated by detecting the rise of the TTL signal. [NEG] means negative polarity, and triggers are generated by detecting the fall of the TTL signal.	TRGP {POS MEG}

Table B-57 Trigger source (Trig source) menu

Key operation: [Trigger] - SOURCE []

Softkey	Function	GPIB command
return	Returns to Table B-56, "Trigger (Trigger) menu," on page 390.	(N/A)

Softkeys displayed by pressing the [Marker] key

Table B-58 Marker (Marker) menu

Key operation: [Marker]

Softkey	Function	GPIB command
MKR ON off	Toggles on and off all the markers displayed on the screen. The markers include main marker (marker number: 0), sub markers (marker number: 1 - 7), and delta marker (Δ). Even if you turn off the markers using this key, their states at the on status are stored. Therefore, when you turn them on again, their states at the previous on status are restored.	MKR {ON OFF}
SUB MKR ►	Displays Table B-59, “Sub marker configuration (Set SMKR) menu,” on page 392.	(N/A)
CLEAR SUB MKR ►	Displays Table B-60, “Sub marker deletion (Clear SMKR) menu,” on page 393.	(N/A)
MKR ON []	For the selected active trace (A or B), selects between placing the marker on the data trace and displaying its value [DATA] or placing the marker on the memory trace and displaying its value [MEMORY].	MKRO {DATA MEMO}
MKR COUPLE ON off	Toggles on and off the marker couple function. If the marker couple function is on, the movement of the marker on the inactive trace becomes interlocked with the movement of the marker on the selected active trace (A or B). If the marker couple function is off, the marker on the inactive trace moves independently of the marker on the selected active trace (A or B). This configuration is commonly applied to traces A and B.	MKRCOUP {ON OFF}
MKR []	For the selected active trace (A or B), toggles the marker movement mode between the interpolation mode [CONT] and the non-interpolation mode [DISCRETE]. In the non-interpolation mode, the markers can read out the values of only actual measurement points on the trace. On the other hand, in the interpolation mode, interpolation calculation between measurement points is performed so that markers can read out values of any position on the trace.	MKRMOV {CONT DISC}
Δ MODE MENU ►	Displays Table B-61, “Delta marker (Delta MKR) menu,” on page 393.	(N/A)

Table B-59 Sub marker configuration (Set SMKR) menu

Key operation: [Marker] - SUB MKR

Softkey	Function	GPIB command
1: OFF	Pressing this key in the off status (1: OFF) causes sub marker 1 to appear at the current position of the main marker (marker number: 0). After that, each time this key is pressed, sub marker 1 moves to the position of the main marker at that time. If in the on instead of OFF status of the softkey label, the measurement parameter value and the sweep parameter value at the position of sub marker 1 are displayed. This function enables you to read out the values of the sub marker easily without using the marker list function in Table B-71, “Utility (Utility) menu,” on page 402.	SMKR1 ON
2: OFF	For sub marker 2, executes the same operation as the above key for sub marker 1.	SMKR2 ON
3: OFF	For sub marker 3, executes the same operation as the above key for sub marker 1.	SMKR3 ON
4: OFF	For sub marker 4, executes the same operation as the above key for sub marker 1.	SMKR4 ON
5: OFF	For sub marker 5, executes the same operation as the above key for sub marker 1.	SMKR5 ON

Table B-59 Sub marker configuration (Set SMKR) menu

Key operation: [Marker] - SUB MKR

Softkey	Function	GPIB command
6: OFF	For sub marker 6, executes the same operation as the above key for sub marker 1.	SMKR6 ON
7: OFF	For sub marker 7, executes the same operation as the above key for sub marker 1.	SMKR7 ON
return	Returns to Table B-58, "Marker (Marker) menu," on page 392.	(N/A)

Table B-60 Sub marker deletion (Clear SMKR) menu

Key operation: [Marker] - CLEAR SUB MKR

Softkey	Function	GPIB command
1: OFF	Turns off sub marker 1 in the on status. If it is in the off status (1: OFF), nothing happens.	SMKR1 OFF
2: OFF	For sub marker 2, executes the same operation as the above key for sub marker 1.	SMKR2 OFF
3: OFF	For sub marker 3, executes the same operation as the above key for sub marker 1.	SMKR3 OFF
4: OFF	For sub marker 4, executes the same operation as the above key for sub marker 1.	SMKR4 OFF
5: OFF	For sub marker 5, executes the same operation as the above key for sub marker 1.	SMKR5 OFF
6: OFF	For sub marker 6, executes the same operation as the above key for sub marker 1.	SMKR6 OFF
7: OFF	For sub marker 7, executes the same operation as the above key for sub marker 1.	SMKR7 OFF
return	Returns to Table B-58, "Marker (Marker) menu," on page 392.	(N/A)

Table B-61 Delta marker (Delta MKR) menu

Key operation: [Marker] - DMODE MENU

Softkey	Function	GPIB command
ΔMKR 	Displays and moves the Δ marker to the current position of the main marker. This Δ marker, when the trace is updated and changed, moves together with the trace so that it is always located on the trace (only the sweep parameter value is fixed). If this Δ marker is selected, "ΔMkr" is displayed in the upper right area of the screen.	DMKR ON
FIXED ΔMKR 	Displays and moves the fixed Δ marker to the current position of the main marker. This fixed Δ marker is fixed on the screen and does not move, even when the trace is updated and changed. If this fixed Δ marker mode is selected, "FxdΔ" is displayed in the upper right area of the screen.	DMKR FIX
TRACKING ΔMKR 	Displays the tracking Δ marker at the current position of the main marker. This tracking Δ marker always moves together with the main marker. Moving the main marker causes the tracking Δ marker to move also. On the other hand, moving the tracking Δ marker using the ΔMKR STIMULUS key causes the main marker to also move. If the tracking Δ marker is selected, "TrkΔ" is displayed in the upper right area of the screen.	DMKR TRAC
ΔMKR OFF	Turns off the selected Δ marker (Δ marker, fixed Δ marker, or tracking Δ marker) and deletes it from the screen.	DMKR OFF

Key Definitions
Softkeys displayed by pressing the [Marker] key

Table B-61 Delta marker (Delta MKR) menu

Key operation: [Marker] - DMODE MENU

Softkey	Function	GPIB command
ΔMKR STIMULUS	For the selected Δ marker (Δ marker, fixed Δ marker, or tracking Δ marker), sets the position in a stimulus value (sweep parameter value).	DMKRPRM <value>
FIXED ΔMKR VALUE	If the fixed Δ marker is selected, sets the position in the measurement parameter value (primary measurement parameter value ¹ of each trace (A and B) if COMPLEX Z-Y has been selected as the measurement parameter).	DMKRVAL <value>
FIXED ΔMKR AUX VALUE	If COMPLEX Z-Y has been selected as the measurement parameter, sets the position in the secondary measurement parameter value ² of the fixed Δ marker.	DMKRAUV <value>
return	Returns to Table B-58, “Marker (Marker) menu,” on page 392.	(N/A)

1. If COMPLEX has been selected as the display format, the value of the real part of each complex parameter (R or G); if POLAR, the absolute value of each complex parameter (|Z| or |Y|).
2. If COMPLEX has been selected as the display format, the value of the imaginary part of each complex parameter (X or B); if POLAR, the value of the phase of each complex parameter (θ).

Softkeys displayed by pressing the [Marker→] key

Table B-62 Marker→ (Marker →/Zoom) menu (1/2)

Key operation: [Marker→]

Softkey	Function	GPIB command
MKR → START	Substitutes the sweep parameter value at the main marker on the current active trace (A or B) into the sweep start value. In other words, the sweep range is changed by using the marker position as the new sweep start value.	MKRSTAR
MKR → STOP	Substitutes the sweep parameter value at the main marker on the current active trace (A or B) into the sweep stop value. In other words, the sweep range is changed by using the marker position as the new sweep stop value.	MKRSTOP
MKR → CENTER	Substitutes the sweep parameter value at the main marker on the current active trace (A or B) into the sweep center value. In other words, the sweep range is changed by using the marker position as the new sweep center value.	MKRCENT
MKRΔ → SPAN	Substitutes the difference (MKRΔ) between the sweep parameter value at the main marker on the current active trace (A or B) and the sweep parameter value of the Δ marker into the sweep span value. In other words, the sweep range is changed by using the range between the main marker and the Δ marker as the new sweep span value. Note that the sweep center value is not changed by this key.	MKRSPAN
MKR → REFERENCE	Substitutes the sweep parameter value at the main marker on the current active trace (A or B) into the reference value (value of the reference line). In other words, the scale is changed by using the marker position as the new reference line position. Note that this key has the same function as the MKR → REFERENCE key in Table B-27, “Scale reference (Scale Ref) menu (1-1/2),” on page 373.	MKRREF
MKR → MANUAL SWP	Substitutes the sweep parameter value at the main marker on the current active trace (A or B) into the manual sweep point. In other words, the manual sweep point moves to the marker position. Note that the manual sweep function should be turned on before pressing this key. Refer to Table B-43, “Sweep (Sweep) menu,” on page 383 for the MANUAL SWP on OFF key.	MKRMAMP
MKR → OFFSET	Substitutes the sweep parameter value at the main marker on the current active trace (A or B) into the offset value. Refer to Table B-43, “Sweep (Sweep) menu,” on page 383 for the OFFSET key.	MKROFS
more 1/2	Displays Table B-63, “Marker→ (Marker →/Zoom) menu (2/2),” on page 395.	(N/A)

Table B-63 Marker→ (Marker →/Zoom) menu (2/2)

Key operation: [Marker→] - more 1/2

Softkey	Function	GPIB command
PEAK → CENTER	Searches for a peak on the current active trace (A or B) ¹ , and substitutes the sweep parameter value at the point into the sweep center value. In other words, the sweep range is changed by using the peak in the trace as the new sweep center value. If no peak was detected due to the shape of the trace, “PEAK NOT FOUND” is displayed at the upper left of the screen.	PEAKCENT

Table B-63 Marker→ (Marker →/Zoom) menu (2/2)

Key operation: [Marker→] - more 1/2

Softkey	Function	GPIB command
MKR ZOOM	Substitutes the sweep parameter value at the main marker on the current active trace (A or B) into the sweep center value and simultaneously changes the current sweep span value to the sweep span value specified with the ZOOMING APERTURE key. In other words, the sweep range is changed so that the marker position is the new sweep center value and the sweep span is magnified by the amount specified with the ZOOMING APERTURE key.	MKRZM
ZOOMING APERTURE	Sets the zooming aperture (ratio of the new sweep span value to the current sweep span value) used when the MKR ZOOM key is executed as a percentage. Specify a value between 0.01% and 100% in resolution of 0.01%. Note that the default value in power-on or preset state is 10%.	ZMAPER <value>
more 2/2	Displays Table B-62, "Marker→ (Marker →/Zoom) menu (1/2)," on page 395.	(N/A)

1. The function to search for a peak is the same as the PEAK key in Table B-66, "Peak (Peak) menu," on page 398.

Softkeys displayed by pressing the [Search] key

Table B-64 Search (Search) menu

Key operation: [Search]

Softkey	Function	GPIB command
MAX 	Moves the main marker on the current active trace (A or B) to the maximum value of the measurement parameter value ¹ on the trace.	SEAM MAX
MIN 	Moves the main marker on the current active trace (A or B) to the minimum value of the measurement parameter value ¹ on the trace.	SEAM MIN
TARGET ► 	Moves the main marker on the current active trace (A or B) to the position of the measurement parameter value ¹ specified with the TARGET VALUE key and displays Table B-65, “Target (Target) menu,” on page 398. The TARGET VALUE key is in this newly displayed menu. If the specified measurement parameter value is not on the trace, the marker is not moved and “TARGET VALUE NOT FOUND” is displayed in the upper left area of the screen.	SEAM TARG
PEAK ►	Moves the main marker on the current active trace (A or B) to the peak position of the measurement parameter value ¹ depending on the peak definition specified with the PEAK DEF MENU key and displays Table B-66, “Peak (Peak) menu,” on page 398. The PEAK DEF MENU key is in this newly displayed menu. If no measurement parameter value can be a peak on the trace, the marker is not moved and “TARGET VALUE NOT FOUND” is displayed in the upper left area of the screen.	SEAM PEAK
SEARCH TRK on OFF	For the current active trace (A or B), toggles on and off the function to execute search each time a sweep is performed (search tracking function). If you turn on this function and select a marker search function with one of the above keys (MAX, MIN, TARGET, PEAK), the search is executed each time the trace is updated by a sweep; if off, the search is executed only when the marker search function key is pressed.	TRACK {ON OFF}
WIDTHS on OFF	For the current active trace (A or B), toggles on and off the trace bandwidth analysis function. If you turn on this function, the cutoff points defined with the WIDTHS DEF MENU key are searched for toward both sides of the measurement parameter axis using the current position of the main marker as the center. If the cutoff points are detected, the following are displayed on the screen: bandwidth (distance between the 2 cutoff point sweep parameter values), center value (midpoint of the 2 cutoff point sweep parameter values), Q, peak (measurement parameter value of the peak between the cutoff points), ΔL (sweep parameter length from the sweep center value to the left cutoff point), ΔR (sweep parameter length from the sweep center value to the right cutoff point). If correct parameters cannot be obtained due to the shape of the trace, “TARGET VALUE NOT FOUND” is displayed in the upper left area of the screen. If you turn on the trace bandwidth analysis function, a horizontal line showing the cutoff value appears on the screen. You can set the cutoff value with the softkeys in Table B-68, “Trace bandwidth analysis definition (Widths Def) menu,” on page 400.	WIDT {ON OFF}
WIDTHS DEF MENU ►	Displays Table B-68, “Trace bandwidth analysis definition (Widths Def) menu,” on page 400.	(N/A)
SEARCH RANGE MENU ►	Displays Table B-69, “Search range (Search Rng) menu (1),” on page 400.	(N/A)

1. If COMPLEX Z-Y has been selected as the measurement parameter, it is the primary measurement parameter value. The primary measurement parameter value means: if COMPLEX has been selected as the display format, the value of the real part in each complex parameter (R or G); if POLAR, the absolute value (|Z| or |Y|).

Key Definitions
Softkeys displayed by pressing the [Search] key

Table B-65 Target (Target) menu

Key operation: [Search] - TARGET

Softkey	Function	GPIB command
TARGET VALUE	Sets the destination where the main marker on the current active trace (A or B) will be moved as the measurement parameter value of the trace ¹ (sets the target value). After the value is entered, the main marker moves to the position of the measurement parameter value. If there is no measurement parameter value on the trace, the marker is not moved and “TARGET VALUE NOT FOUND” is displayed in the upper left area of the screen.	SEATARG <value>
SEARCH LEFT	For the main marker on the current active trace (A or B), the target value is searched for from the current position toward the left. If it is detected, the main marker moves to the position. If not, the marker is not moved and “TARGET VALUE NOT FOUND” is displayed in the upper left area of the screen.	SEAL
SEARCH RIGHT	For the main marker on the current active trace (A or B), the target value is searched for from the current position toward the right. If it is detected, the main marker moves to the position. If not, the marker is not moved and “TARGET VALUE NOT FOUND” is displayed in the upper left area of the screen.	SEAR
LINE on OFF	For the current active trace (A or B), toggles on and off the line displayed on the screen corresponding to the target value.	SEATARGL {ON OFF}
SUB MKR ►	Displays Table B-59, “Sub marker configuration (Set SMKR) menu,” on page 392.	(N/A)
return	Returns to Table B-64, “Search (Search) menu,” on page 397.	(N/A)

1. If COMPLEX Z-Y has been selected as the measurement parameter, this is the primary measurement parameter value. The primary measurement parameter value means: if COMPLEX has been selected as the display format, the value of the real part (R or G) of each complex parameter; if POLAR, the absolute value ($|Z|$ or $|Y|$) of each complex parameter.

Table B-66 Peak (Peak) menu

Key operation: [Search] - PEAK

Softkey	Function	GPIB command
PEAK	Searches for peaks (pointed parts in the waveform) of the measurement parameter values ¹ according to the peak definition specified with the PEAK DEF MENU key and moves the main marker on the current active trace (A or B) to the position of the highest peak ² . If there is no measurement parameter value that can be a peak on the trace, the marker is not moved and “TARGET VALUE NOT FOUND” is displayed in the upper left area of the screen.	SEAM PEAK
NEXT PEAK	For the peaks in the current active trace (A or B) that have been detected in the immediately previous search execution, moves the main marker to the next lower peak ² .	SEANPK
NEXT PEAK LEFT	For the peaks in the current active trace (A or B) that have been detected in the immediately previous search execution, performs peak search toward the left and moves the main marker to the position of the first detected peak.	SEANPKL
NEXT PEAK RIGHT	For the peaks in the current active trace (A or B) that have been detected in the immediately previous search execution, performs peak search toward the right and moves the main marker to the position of the first detected peak.	SEANPKR
PEAK DEF MENU ►	Displays Table B-67, “Peak definition (Peak Def) menu,” on page 399.	(N/A)

Table B-66 Peak (Peak) menu

Key operation: [Search] - PEAK

Softkey	Function	GPIB command
SUB MKR >	Displays Table B-59, “Sub marker configuration (Set SMKR) menu,” on page 392.	(N/A)
return	Displays Table B-64, “Search (Search) menu,” on page 397.	(N/A)

1. If COMPLEX Z-Y has been selected as the measurement parameter, this is the primary measurement parameter value. The primary measurement parameter value means: if COMPLEX has been selected as the display format, the value of the real part (R or G) of each complex parameter; if POLAR, the absolute value ($|Z|$ or $|Y|$) of each complex parameter.
2. The amplitude of peaks means: amplitude of crests (parts that protrude in the waveform in the increasing direction of the measurement parameter value) if the peak polarity is defined as positive; amplitude of troughs (parts that protrude in the waveform in the decreasing direction of the measurement parameter value) if negative.

Table B-67 Peak definition (Peak Def) menu

Key operation: [Search] - PEAK - PEAK DEF MENU

Softkey	Function	GPIB command
PEAK PLRTY []	For the current active trace (A or B), selects positive [POS] or negative [NEG] to define the polarity of peaks for peak search. If the peak polarity is set to positive [POS], peaks are parts (crests) that protrude in the waveform in the increasing direction of the measurement parameter value ¹ ; if negative [NEG], parts (troughs) that protrude in the waveform in the decreasing direction of the measurement parameter value ¹ .	PKPOL {POS NEG}
PEAK DEF: ΔX	Sets ΔX of the peak slope $^2\Delta Y/\Delta X$, one of the peak definition items for executing peak search for the current active trace (A or B). If the peak slope $\Delta Y/\Delta X$ is set in the peak definition, peaks that have a slope greater than this slope are detected in peak search.	PKDLTX <value>
PEAK DEF: ΔY	Sets ΔY of the peak slope $\Delta Y/\Delta X$, one of the peak definition items for executing peak search for the current active trace (A or B). If the peak slope $^2\Delta Y/\Delta X$ is set in the peak definition, peaks that have a slope greater than this slope are detected in peak search.	PKDLTY <value>
MKR → PEAK DELTA	Substitutes the peak slope ² at the position of the main marker on the current active trace (A or B) into the peak slope $\Delta Y/\Delta X$ as the peak definition used for peak search. In other words, peaks that have a slope greater than the peak at the current marker position are detected in peak search.	MKRPKD
return	Returns to Table B-66, “Peak (Peak) menu,” on page 398.	(N/A)

1. If COMPLEX Z-Y has been selected as the measurement parameter, this is the primary measurement parameter value. The primary measurement parameter value means: if COMPLEX has been selected as the display format, the value of the real part (R or G) of each complex parameter; if POLAR, the absolute value ($|Z|$ or $|Y|$) of each complex parameter.
2. The peak slope means, on the plane whose vertical axis is the measurement parameter value and whose horizontal axis is the sweep parameter value, the absolute value of the smaller slope: a slope of the line connecting the peak measurement point and the next left measurement point or a slope of the line connecting the peak measurement point and the next right measurement point. It indicates the sharpness of the peak. Note that if COMPLEX Z-Y has been selected as the measurement parameter, this definition can be applied, assuming a plane whose vertical axis is the primary measurement parameter value and whose horizontal axis is the sweep parameter value.

Key Definitions
Softkeys displayed by pressing the [Search] key

Table B-68 Trace bandwidth analysis definition (Widths Def) menu

Key operation: [Search] - WIDTHS DEF MENU

Softkey	Function	GPIB command
MKRVAL($\sqrt{2}$) 	Uses the value obtained by dividing the measurement parameter value at the main marker on the current active trace (A or B) by $\sqrt{2}$ as the value of the cutoff point for trace bandwidth search.	WIDVTYPE DIVS2
MKRVAL*($\sqrt{2}$) 	Uses the value obtained by multiplying the measurement parameter value at the main marker on the current active trace (A or B) by $\sqrt{2}$ as the value of the cutoff point for trace bandwidth analysis.	WIDVTYPE MULS2
MKRVAL/2 	Uses the value obtained by dividing the measurement parameter value at the main marker on the current active trace (A or B) by 2 as the value of the cutoff point for trace bandwidth analysis.	WIDVTYPE DIV2
FIXED VALUE	Directly enters the cutoff point for trace bandwidth analysis.	WIDVTYPE FIX and WIDFVAL <value>
SEARCH IN	When the trace bandwidth analysis function is on, searches for two (left and right) cutoff points on the trace inwardly, relative to the currently displayed cutoff points, and displays the parameters of the trace bandwidth analysis for the first detected cutoff points. Executing this key does not change the peak values. If two new cutoff points are not detected, "TARGET VALUE NOT FOUND" is displayed in the upper left area of the screen.	WIDSIN
SEARCH OUT	When the trace bandwidth analysis function is on, searches for two (left and right) cutoff points on the trace outwardly, relative to the currently displayed cutoff points, and displays the parameters of the trace bandwidth analysis for the first detected cutoff points. Executing this key does not change the peak values. If two new cutoff points are not detected, "TARGET VALUE NOT FOUND" is displayed in the upper left area of the screen.	WIDSOUT
return	Returns to Table B-64, "Search (Search) menu," on page 397.	(N/A)

Table B-69 Search range (Search Rng) menu (1)

Key operation: [Search] - SEARCH RANGE MENU¹

Softkey	Function	GPIB command
PART SRCH on OFF	For the current active trace (A or B), toggles on and off the partial search function. The partial search function executes search within the specified range on the trace. If the partial search function is on, both edges of the currently specified search range are indicated by two small Δ s. If no search range is specified, the search range is the entire trace (same as when partial search is off).	PARS {ON OFF}
MINIMUM	For the current active trace (A or B), directly enters the lower limit of the partial search range.	SEARMIN <value>
MAXIMUM	For the current active trace (A or B), directly enters the upper limit of the partial search range.	SEARMAX <value>
MKR → MINIMUM	Substitutes the sweep parameter value at the main marker on the current active trace (A or B) into the partial search range lower limit. In other words, the sweep range is changed by using the current position of the main marker as the new partial search range lower limit.	MKRTRMIN

Table B-69 Search range (Search Rng) menu (1)

Key operation: [Search] - SEARCH RANGE MENU¹

Softkey	Function	GPIB command
MKR → MAXIMUM	Substitutes the sweep parameter value at the main marker on the current active trace (A or B) into the partial search range upper limit. In other words, the sweep range is changed using the current position of the main marker as the new partial search range upper limit.	MKRTRMAX
MKRA → SEARCH RNG	Uses the range between the main marker on the current active trace (A or B) and the Δ marker as the partial search range.	MKRTR
return	Returns to Table B-64, “Search (Search) menu,” on page 397.	(N/A)

1. When the sweep type is not list (list sweep).

Table B-70 Search range (Search Rng) menu (2)

Key operation: [Search] - SEARCH RANGE MENU¹

Softkey	Function	GPIB command
FULL 	Selects the mode in which the partial search range is the entire list sweep table.	SEARNG FULL
SEGMENT	Selects the mode in which the partial search range is one specific segment in the list sweep table.	SEARNG SEGMENT
SEGMENT NUMBER	When a segment is selected as the partial search range, specify a segment number for partial search.	SEGMNUM <value>
RNG LINE on OFF	Toggles on and off the partial search range border line display to indicate the borders of the partial search range by two vertical lines on the graph. If the measurement parameter is COMPLEX Z-Y, you cannot turn on the partial search range border line display.	SEARLINE {ON OFF}
return	Returns to Table B-64, “Search (Search) menu,” on page 397.	(N/A)

1. When the sweep type is list (list sweep).

Softkeys displayed by pressing the [Utility] key

Table B-71 Utility (Utility) menu

Key operation: [Utility]

Softkey	Function	GPIB command
MKR LIST on OFF	Toggles on and off the marker list function. This function displays the list of the sweep parameter values and measurement parameter values of all markers (main marker, sub markers, Δ marker). If ALL INSTRUMENT has been selected in Table B-21, "Display allocation (Disp Alloc) menu," on page 369, the upper half of the screen displays the graph, and the lower half displays the list of the marker values. If HALF INSTR HALF BASIC has been selected, only the list of the marker values are displayed.	MKRL {ON OFF}
STATISTICS on OFF	For the search range of the current active trace (A or B), calculates statistics (mean value, standard deviation, peak-to-peak value) and displays them. If the partial search function is off, statistics are calculated for the entire trace.	MEASTAT {ON OFF}
MKR X-AXIS [] ►	Displays Table B-72, "Marker X axis (MKR X-Axis) menu," on page 402. In [] of the softkey label, the currently selected marker's X axis is displayed (sweep parameter [STIM], sweep lapse time [TIME], or relief time [1/(2 π F)]).	(N/A)
LEVEL MON [] ►	Displays Table B-73, "Level monitor (Level Mon) menu," on page 403.	(N/A)

Table B-72 Marker X axis (MKR X-Axis) menu

Key operation: [Utility] - MKR X-AXIS []

Softkey	Function	GPIB command
STIMULUS 	For the marker on the current active trace (A or B), selects the sweep parameter value as the value displayed in the X axis. If Δ marker is used, the value of the sweep parameter value, relative to the position of the Δ marker, is displayed.	MKRXUNIT STIM
TIME 	For the marker on the current active trace (A or B), selects time as the value displayed in the X axis. Time means the elapsed time between the start of the sweep and the marker position. In this configuration, the sweep start position is zero and the sweep stop position is the sweep time. This function is useful when setting the sweep span to zero (zero span measurement) and evaluating the change in a DUT with respect to time at a fixed frequency. If the Δ marker is used, the value of time, relative to the position of the Δ marker, is displayed.	MKRXUNIT TIME
1/(2 π F)	For the marker on the current active trace (A or B), selects the relief time {1/(2 π F), F: measurement frequency} as the value displayed in the X axis. This function is available only when frequency has been selected as the sweep parameter. If the Δ marker is used, the value of the relief time, relative to the position of the Δ marker, is displayed.	MKRXUNIT RFREQ
return	Returns to Table B-71, "Utility (Utility) menu," on page 402.	(N/A)

Table B-73 Level monitor (Level Mon) menu

Key operation: [Utility] - LEVEL MON []

Softkey	Function	GPIB command
OFF 	Turns off the marker level monitor function. Usual markers are displayed.	MKRMON OFF
AC-V 	Displays the voltage value of the test signal at the marker position on the current trace (A or B) in the upper right area of the screen. Before selecting this function, you must turn on the monitor display of the test signal level with the OSC LEVEL on OFF key in Table B-13, "Display (Display) menu (1/2)," on page 366.	MKRMON ACV
AC-I 	Displays the current value of the test signal at the marker position on the current active trace (A or B) in the upper right area of the screen. Before selecting this function, you must turn on the monitor display of the test signal level with the OSC LEVEL on OFF key in Table B-13, "Display (Display) menu (1/2)," on page 366.	MKRMON ACI
DC-V 	Displays the voltage value of the dc bias at the marker position on the current active trace (A or B) in the upper right area of the screen. Before selecting this function, you must select VOLT (dc bias voltage value monitor) in Table B-16, "Bias Monitor (Bias Monitor) menu," on page 367.	MKRMON DCV
DC-I	Displays the current of the dc bias at the marker position on the current active trace (A or B) in the upper right area of the screen. Before selecting this function, you must select CURRENT (dc bias current value monitor) in Table B-16, "Bias Monitor (Bias Monitor) menu," on page 367.	MKRMON DCI
return	Returns to Table B-71, "Utility (Utility) menu," on page 402.	(N/A)

Softkeys displayed by pressing the [System] key

Table B-74 System (System) menu

Key operation: [System]

Softkey	Function	GPIB command
IBASIC ►	Displays Table B-75, “HP Instrument BASIC (IBASIC) menu (1/3),” on page 404.	(N/A)
PROGRAM MENU ►	Searches the mass storage specified with the STORE DEV [] key in Table B-111, “File selection (Select File) menu,” on page 424 for program files and directories, and displays Table B-111, “File selection (Select File) menu,” on page 424 to show the list of them.	(N/A)
LIMIT TEST ►	Displays Table B-82, “Limit test (Limit Test) menu,” on page 408.	(N/A)
RECALL MESSAGE	Displays messages that were displayed in the message area on the screen one-by-one in reverse chronological order each time this key is pressed. Pressing this key with the oldest stored message displayed returns to the first displayed message. Up to 32 messages can be stored. Pressing the [Preset] key to execute preset deletes all of them.	(N/A)
CLOCK ►	Displays Table B-89, “Internal clock (Clock) menu,” on page 412. The internal clock is used for time stamps (TIME on OFF key in Table B-100, “Copy configuration (Copy Setup) menu (2/2),” on page 418) when outputting to a printer or for a date record when storing files.	(N/A)
BEEPER ►	Displays Table B-92, “Built-in speaker (Beeper) menu,” on page 413.	(N/A)
DIAGNOSTIC TEST ►	Displays Table B-93, “System diagnosis (Diagnosis) menu,” on page 413.	(N/A)

Table B-75 HP Instrument BASIC (IBASIC) menu (1/3)

Key operation: [System] - IBASIC

Softkey	Function	GPIB command
Step	Executes a program line-by-line. This is useful for debugging.	(N/A)
Continue	Resumes the execution of the program from the line next to the line (current line) that caused the program to pause.	(N/A)
Run	Executes a program from its first line.	(N/A)
Pause	After executing the line (current line) at the press of this key, causes the execution of the program to pause.	(N/A)
Stop	After executing the line (current line) at the press of this key, aborts the execution of the program. You cannot resume the execution of the program from the aborted line.	(N/A)
Edit ►	Enters into the program edit mode and displays Table B-78, “IBASIC edit (Editor) menu,” on page 406. In the program edit mode, regardless of the setting in Table B-21, “Display allocation (Disp Alloc) menu,” on page 369, the entire screen is set to the HP Instrument BASIC screen and the program list is displayed.	(N/A)
ON KEY LABELS	Displays key labels defined using the ON KEY command in an HP Instrument BASIC program as softkeys. Pressing one of other hardkeys that call softkeys causes ON KEY labels to disappear and original softkeys to be displayed again.	(N/A)

Table B-75 HP Instrument BASIC (IBASIC) menu (1/3)

Key operation: [System] - IBASIC

Softkey	Function	GPIB command
more 1/3	Displays Table B-76, “HP Instrument BASIC (IBASIC) menu (2/3),” on page 405.	(N/A)

Table B-76 HP Instrument BASIC (IBASIC) menu (2/3)

Key operation: [System] - IBASIC - more 1/3

Softkey	Function	GPIB command
CAT	Enters CAT in the HP Instrument BASIC command line ¹ . From here, use the external keyboard to enter required parameters and press the [Enter] key. The list of the contents (files) of the specified mass storage/directory is displayed in the HP Instrument BASIC screen ² .	(N/A)
SAVE	Enters SAVE "" in the HP Instrument BASIC command line ¹ . The character entry cursor is located below the second ". From here, use the external keyboard to enter required parameters (filename, and so on) and press the [Enter] key. The SAVE command is executed, and the program is stored using the entered filename. The SAVE command stores programs in the ASCII format. If the same filename exists on the disk, “-257 FILE NAME ERROR” occurs and the program cannot be stored.	(N/A)
RE-SAVE	Enters RE-SAVE "" in the HP Instrument BASIC command line ¹ . The character entry cursor is located below the second ". From here, use the keyboard to enter required parameters (filename and so on) and press the [Enter] key. The RE-SAVE command is executed for the specified file, and the program is stored using the entered filename. The RE-SAVE command stores programs in ASCII format. Even if there is a file having the same filename on the disk, the RE-SAVE command causes no error alert and overwrites the file with new data.	(N/A)
GET	Enters GET "" in the HP Instrument BASIC command line ¹ . The character entry cursor is located below the second ". From here, use the keyboard to enter required parameters (filename and so on) and press the [Enter] key. The GET command is executed for the specified file. The GET command loads the ASCII file having the specified filename into the program workspace. If a file with the specified filename does not exist on the disk, the “-256 File not found” error occurs.	(N/A)
PURGE	Enters PURGE "" in the HP Instrument BASIC command line ¹ . The character entry cursor is located below the second ". From here, use the keyboard to enter required parameters (filename and so on) and press the [Enter] key. The PURGE command is executed for the specified file. The PURGE command deletes the file having the specified filename from the disk. If a file with the specified filename does not exist on the disk, the “-256 File not found” error occurs.	(N/A)
INITIALIZE	Enters INITIALIZE in the HP Instrument BASIC command line ¹ . From here, use the external keyboard to enter required parameters and press the [Enter] key. The specified disk is initialized. After the disk is initialized, all of the files on the specified disk are deleted.	(N/A)
MASS STORE [] ►	Displays Table B-79, “IBASIC mass storage (Mass Storage) menu,” on page 407. In [] of the softkey label, the currently selected IBASIC mass storage is displayed (flexible disk drive [FLOPPY], volatile memory disk [MEMORY], or nonvolatile memory disk (flash memory) [FLASH]).	(N/A)

Key Definitions
Softkeys displayed by pressing the [System] key

Table B-76 HP Instrument BASIC (IBASIC) menu (2/3)

Key operation: [System] - IBASIC - more 1/3

Softkey	Function	GPIB command
more 2/3	Displays Table B-77, “HP Instrument BASIC (IBASIC) menu (3/3),” on page 406.	(N/A)

1. Before displaying the result in the command line, you must select the BASIC STATUS key, HALF INSTR HALF BASIC key, or ALL BASIC key in Table B-21, “Display allocation (Disp Alloc) menu,” on page 369.
2. Before displaying the result on the HP Instrument BASIC screen, you must select the HALF INSTR HALF BASIC key or the ALL BASIC key in Table B-21, “Display allocation (Disp Alloc) menu,” on page 369.

Table B-77 HP Instrument BASIC (IBASIC) menu (3/3)

Key operation: [System] - IBASIC - more 2/3

Softkey	Function	GPIB command
SCRATCH	Enters SCRATCH in the HP Instrument BASIC command line ¹ . From here, use the external keyboard to enter required parameters and press the [Enter] key. The contents of the specified memory space of HP Instrument BASIC are deleted. For example, if the SCRATCH command is executed without specifying parameters, the program in the program workshops and variables in spaces except for the common (COM) space are deleted from the HP Instrument BASIC memory space.	(N/A)
RENUMBER	Enters REN in the HP Instrument BASIC command line ¹ . From here, use the external keyboard to enter required parameters and press the [Enter] key. The line numbers of the program currently in the program workshops are renumbered.	(N/A)
LIST	Enters LIST in the HP Instrument BASIC command line ¹ . From here, use the external keyboard to enter required parameters and press the [Enter] key. The list of the program currently in the program workshops is displayed on the HP Instrument BASIC screen ² .	(N/A)
COMMAND ENTRY ►	Displays Table B-80, “IBASIC command name (Command Name) menu,” on page 407.	(N/A)
CLEAR I/O	Cancels the execution of the command for I/O (input/output) that is being executed.	(N/A)
RESET LABELS	Initializes HP Instrument BASIC (BASIC Reset).	(N/A)
more 3/3	Displays Table B-75, “HP Instrument BASIC (IBASIC) menu (1/3),” on page 404.	(N/A)

1. Before displaying the result in the command line, you must select the BASIC STATUS key, HALF INSTR HALF BASIC key, or ALL BASIC key in Table B-21, “Display allocation (Disp Alloc) menu,” on page 369.
2. Before displaying the result on the HP Instrument BASIC screen, you must select the HALF INSTR HALF BASIC key or the ALL BASIC key in Table B-21, “Display allocation (Disp Alloc) menu,” on page 369.

Table B-78 IBASIC edit (Editor) menu

Key operation: [System] - IBASIC - Edit

Softkey	Function	GPIB command
ASSIGN @Hp4294	Inserts ASSIGN @Hp4294 TO 800 at the position of the current cursor.	(N/A)

Table B-78 IBASIC edit (Editor) menu

Key operation: [System] - IBASIC - Edit

Softkey	Function	GPIB command
OUTPUT @Hp4294	Inserts OUTPUT @Hp4294 TO 800 at the current cursor position.	(N/A)
ENTER @Hp4294	Inserts ASSIGN @Hp4294 TO 800 at the current cursor position.	(N/A)
END	Inserts END at the current cursor position.	(N/A)
GOTO LINE	Enters ENTER LINE NUMBER/LABEL? in the HP Instrument BASIC command line. From here, use the external keyboard to enter a line number or its defined label name and press the [Enter] key. The cursor moves to the specified line.	(N/A)
RECALL LINE	Restores the line last deleted.	(N/A)
done	Exits the program edit mode and returns to Table B-75, “HP Instrument BASIC (IBASIC) menu (1/3),” on page 404. The display mode specified in Table B-21, “Display allocation (Disp Alloc) menu,” on page 369 is restored on the screen.	(N/A)

Table B-79 IBASIC mass storage (Mass Storage) menu

Key operation: [System] - IBASIC - more 1/3 - MASS STORE []

Softkey	Function	GPIB command
FLOPPY 	Selects the flexible disk drive as the HP Instrument BASIC mass storage ¹ .	(N/A)
MEMORY 	Selects the volatile memory disk as the HP Instrument BASIC mass storage ¹ .	(N/A)
FLASH MEMORY	Selects the nonvolatile memory disk (flash memory) as the HP Instrument BASIC mass storage ¹ .	(N/A)
CHANGE DIRECTORY	Enters MSI " [in the HP Instrument BASIC command line ² . The character entry cursor is located below the second ". From here, use the external keyboard to enter a directory name and press the [Enter] key. The current directory changes to the specified directory.	(N/A)
return	Returns to Table B-76, “HP Instrument BASIC (IBASIC) menu (2/3),” on page 405.	(N/A)

1. The selection of the mass storage device is set independently in each of the following menus: this menu, Table B-81, “Mass storage (Store Device) menu,” on page 408, and Table B-115, “Copy destination device (Dest Device) menu,” on page 425. However, there is only a single set of mass storage devices for all menu selections.
2. Before displaying the result in the command line, you must select the BASIC STATUS key, HALF INSTR HALF BASIC key, or ALL BASIC key in Table B-21, “Display allocation (Disp Alloc) menu,” on page 369. MSI is the abbreviation of MASS STRAGE IS.

Table B-80 IBASIC command name (Command Name) menu

Key operation: [System] - IBASIC - more 1/3 - more 2/3 - COMMAND ENTRY

Softkey	Function	GPIB command
SELECT LETTER	Selects a character indicated by “↑” on the screen and enters it.	(N/A)
SPACE	Enters a space.	(N/A)
BACK SPACE	Deletes the character last entered.	(N/A)

Key Definitions
Softkeys displayed by pressing the [System] key

Table B-80 IBASIC command name (Command Name) menu

Key operation: [System] - IBASIC - more 1/3 - more 2/3 - COMMAND ENTRY

Softkey	Function	GPIB command
CLEAR NAME	Deletes all entered characters.	(N/A)
done	Finishes the entry of characters and executes the entered command.	(N/A)
cancel	Cancels the entry of characters and returns to Table B-77, “HP Instrument BASIC (IBASIC) menu (3/3),” on page 406.	(N/A)

Table B-81 Mass storage (Store Device) menu

Key operation: [System] - PROGRAM MENU - STORE DEV []
[Save] - STORE DEV []
[Save] - STATE/ CREATE DIRECTORY/ CHANGE DIRECTORY/ COPY FILE/ FILE UTILITIES - STORE DEV []

Softkey	Function	GPIB command
FLOPPY 	Selects the flexible disk drive as the mass storage ¹ .	STOD DISK
MEMORY 	Selects the volatile memory disk as the mass storage ¹ .	STOD MEMO
FLASH MEMORY	Selects the nonvolatile memory disk (flash memory) as the mass storage ¹ .	STOD FLASH
return	Returns to Table B-111, “File selection (Select File) menu,” on page 424.	(N/A)

1. The selection of the mass storage device is set independently in each of the following menus: this menu, Table B-79, “IBASIC mass storage (Mass Storage) menu,” on page 407, and Table B-115, “Copy destination device (Dest Device) menu,” on page 425. However, there is only a single set of mass storage devices for all menu selections.

Table B-82 Limit test (Limit Test) menu

Key operation: [System] - LIMIT TEST

Softkey	Function	GPIB command
LIMIT TEST on OFF	Toggles on and off the limit line test function. If this is set to on, according to the limit line table, the limit lines are displayed on the screen and the limit test is executed.	LIMITEST {ON OFF}
BEEP FAIL on OFF	Toggles on and off the beep that sounds each time the result of a limit line test is failure (FAIL).	DEEFAIL {ON OFF}
EDIT LIMIT LINE ►	Displays Table B-83, “Limit line edit (Edit Limit) menu,” on page 409. Regardless of the setting in Table B-21, “Display allocation (Disp Alloc) menu,” on page 369, the upper half of the screen displays the measured graph, and the lower half displays the limit line table.	EDITLIML
LIMIT LINE OFFSETS ►	Displays Table B-88, “Limit line offset (Limit Offset) menu,” on page 412.	(N/A)
return	Returns to Table B-74, “System (System) menu,” on page 404.	(N/A)

Table B-83 Limit line edit (Edit Limit) menu

Key operation: [System] - LIMIT TEST - EDIT LIMIT LINE

Softkey	Function	GPIB command
SEGMENT	From the limit line table, specifies a segment number to be edited. The currently specified segment is indicated by the pointer (>) on the table. You can change the specified segment number using the ENTRY block keys (numeric key, rotary knob, [↑][↓] keys) on the front panel. If there is no segment in the limit line table ("EMPTY" is displayed at the top of the table), add/edit segments using the EDIT key or ADD key.	LIMSEGM <value>
EDIT ►	For the segment indicated by the current pointer (enters into the edit mode. In the segment edit mode, the menu changes to Table B-84, "Segment edit (Edit Limit) menu (1/3)," on page 409. If there is no segment in the limit line table ("EMPTY" is displayed at the top of the table), a preset segment is added as substitution and the edit mode is invoked.	LIMSEDI
DELETE	Deletes the segment indicated by the current pointer (>).	LIMSDEL
ADD ►	Inserts a segment whose contents are the same as the segment indicated by the current pointer (>) after the segment and enters the segment edit mode. In the segment edit mode, the menu changes to Table B-84, "Segment edit (Edit Limit) menu (1/3)," on page 409. If there is no segment in the limit line table ("EMPTY" is displayed at the top of the table), a preset segment is added as substitution and the edit mode is invoked.	LIMSADD
CLEAR LIST ►	Displays Table B-87, "List deletion (Clear List?) menu," on page 412.	LIMCLEL
done	Finishes the editing of the limit line table, replaces the table before the editing with the new table, and stores it. Also, returns to Table B-82, "Limit test (Limit Test) menu," on page 408.	LIMEDONE
cancel	Cancels the editing of the limit line table and returns to Table B-82, "Limit test (Limit Test) menu," on page 408. The limit line table before the editing remains unchanged.	(N/A)

Table B-84 Segment edit (Edit Limit) menu (1/3)Key operation: [System] - LIMIT TEST - EDIT LIMIT LINE - EDIT
[System] - LIMIT TEST - EDIT LIMIT LINE - ADD

Softkey	Function	GPIB command
START	Sets the sweep start value of the segment.	LIMSTAR <value>
UPPER LIMIT	Sets the upper limit of the measured value at the sweep start point of the segment ¹ . Be sure to set both the upper limit and the lower limit. If an upper limit is not required, set an extremely large value (for example, 1G) as the upper limit. If you set the upper limit smaller than the lower limit, both limits are set to the newly entered value automatically.	LIMUSTAR <value>
LOWER LIMIT	Sets the lower limit of the measured value at the sweep start point of the segment ¹ . Be sure to set both the upper limit and the lower limit. If a lower limit is not required, set an extremely small value (for example, -1G) as the lower limit. If you set the lower limit greater than the upper limit, both limits are set to the newly entered value automatically.	LIMLSTAR <value>

Key Definitions
Softkeys displayed by pressing the [System] key

Table B-84 Segment edit (Edit Limit) menu (1/3)

Key operation: [System] - LIMIT TEST - EDIT LIMIT LINE - EDIT
[System] - LIMIT TEST - EDIT LIMIT LINE - ADD

Softkey	Function	GPIB command
MIDDLE VALUE	Sets the limit center value of the measured value at the sweep start point of the segment ¹ . When setting the center value, also set the difference value (difference between upper and the lower limits) with the DELTA LIMIT key. This kind of limit configuration set by the center value and the difference value can be used as an alternative to a limit configuration set by the upper and lower limits.	LIMVSTAR <value>
DELTA LIMIT	Sets the limit difference value of the measured value at the sweep start point of the segment ¹ . When setting the difference value, also set the center value with the MIDDLE VALUE key. This kind of limit configuration set by the center value and the difference value can be used as an alternative to a limit configuration set by the upper and lower limits.	LIMDSTAR <value>
more 1/3	Displays Table B-85, "Segment edit (Edit Limit) menu (2/3)," on page 410.	(N/A)
done	Finishes the editing of the segment, replaces the segment before the editing with the new segment, and stores it. Also, returns to Table B-83, "Limit line edit (Edit Limit) menu," on page 409.	LIMSDON
cancel	Cancels the editing of the segment and returns to Table B-83, "Limit line edit (Edit Limit) menu," on page 409. The segment before the editing remains unchanged.	LIMSQUI

1. Even if you have set the limits with the MIDDLE VALUE (center value) key and the DELTA LIMIT (difference value) key, you can convert the table into the upper and lower limit format by pressing the UPPER LIMIT key or the LOWER LIMIT key. On the other hand, even if you have set the limits with the UPPER LIMIT (upper limit) key and the LOWER LIMIT (lower limit) key, you can convert the table into the center and difference value format by pressing the MIDDLE VALUE key or the DELTA LIMIT key.

Table B-85 Segment edit (Edit Limit) menu (2/3)

Key operation: [System] - LIMIT TEST - EDIT LIMIT LINE - EDIT - more 1/3
[System] - LIMIT TEST - EDIT LIMIT LINE - ADD - more 1/3

Softkey	Function	GPIB command
STOP	Sets the sweep stop value of the segment.	LIMSTOP <value>
UPPER LIMIT	Sets the upper limit of the measured value at the sweep stop point of the segment ¹ . Be sure to set both the upper and lower limits. If an upper limit is not required, set an extremely large value (for example, 1G) as the upper limit. If you set the upper limit smaller than the lower limit, both limits are set to the newly entered value automatically.	LIMUSTOP <value>
LOWER LIMIT	Sets the lower limit of the measured value at the sweep stop point of the segment ¹ . Be sure to set both the upper and lower limits. If a lower limit is not required, set an extremely small value (for example, -1G) as the lower limit. If you set the lower limit greater than the upper limit, both limits are set to the newly entered value automatically.	LIMLSTOP <value>
MIDDLE VALUE	Sets the limit center value of the measured value at the sweep stop point of the segment ¹ . When setting the center value, also set the difference value (difference between the upper and lower limits) with the DELTA LIMIT key. This kind of limit configuration set by the center value and the difference value can be used as an alternative to the limit configuration set by the upper and lower limits.	LIMVSTOP <value>

Table B-85 Segment edit (Edit Limit) menu (2/3)

Key operation: [System] - LIMIT TEST - EDIT LIMIT LINE - EDIT - more 1/3
 [System] - LIMIT TEST - EDIT LIMIT LINE - ADD - more 1/3

Softkey	Function	GPIB command
DELTA LIMIT	Sets the limit center value of the measured value at the sweep stop point of the segment ¹ . When setting the center value, also set the difference value (difference between the upper and lower limits) with the DELTA LIMIT key. This kind of limit configuration set by the center value and the difference value can be used as an alternative to the limit configuration set by the upper and lower limits.	LIMDSTOP <value>
more 2/3	Displays Table B-86, "Segment edit (Edit Limit) menu (3/3)," on page 411.	(N/A)
done	Has the same function as the done key in Table B-84, "Segment edit (Edit Limit) menu (1/3)," on page 409.	LIMSDON
cancel	Has the same function as the cancel key in Table B-84, "Segment edit (Edit Limit) menu (1/3)," on page 409.	LIMSQUI

1. Even if you have set the limits with the MIDDLE VALUE (center value) key and the DELTA LIMIT (difference value) key, you can convert the table into the upper and lower limit format by pressing the UPPER LIMIT key or the LOWER LIMIT key. On the other hand, even if you have set the limits with the UPPER LIMIT (upper limit) key and the LOWER LIMIT (lower limit) key, you can convert the table into the center and difference value format by pressing the MIDDLE VALUE key or the DELTA LIMIT key.

Table B-86 Segment edit (Edit Limit) menu (3/3)

Key operation: [System] - LIMIT TEST - EDIT LIMIT LINE - EDIT - more 1/3 - more 2/3
 [System] - LIMIT TEST - EDIT LIMIT LINE - ADD - more 1/3 - more 2/3

Softkey	Function	GPIB command
TEST ON off	Toggles on and off the limit line test for the segment. When the limit line test is off, * is displayed to the right of the segment number in the completed limit line table. Note that * is not displayed when the pointer (>) is displayed to the right of the segment number.	LIMSTEST {ON OFF}
MKR → START	Substitutes the sweep parameter value at the main marker on the current active trace (A or B) into the sweep start value of the segment.	MKRLIMSTAR
MKR → STOOP	Substitutes the sweep parameter value at the main marker on the current active trace (A or B) into the sweep stop value of the segment.	MKRLIMSTOP
MKR → VALUE STAR	Substitutes the sweep parameter value at the main marker on the current active trace (A or B) into the limit center point at the sweep start point of the segment.	MKRLIMVSTAR
MKR → VALUE STOP	Substitutes the sweep parameter value at the main marker on the current active trace (A or B) into the limit center point at the sweep stop point of the segment.	MKRLIMVSTOP
more 3/3	Displays Table B-84, "Segment edit (Edit Limit) menu (1/3)," on page 409.	(N/A)
done	Has the same function as the done key in Table B-84, "Segment edit (Edit Limit) menu (1/3)," on page 409.	LIMSDON
cancel	Has the same function as the cancel key in Table B-84, "Segment edit (Edit Limit) menu (1/3)," on page 409.	LIMSQUI

Table B-87 List deletion (Clear List?) menu

Key operation: [System] - LIMIT TEST - EDIT LIMIT LINE - CLEAR LIST

Softkey	Function	GPIB command
yes	Deletes the contents of the limit line table that is being edited from the edit area. Even after using this key, you can keep the table without deleting it by pressing the cancel key in Table B-83, "Limit line edit (Edit Limit) menu," on page 409, which is stored in original form before the limit line table edit mode is invoked.	(N/A)
cancel	Cancels deletion of the contents of the limit line table being edited from the edit screen. The tables that have already been edited are kept in the edit area.	(N/A)

Table B-88 Limit line offset (Limit Offset) menu

Key operation: [System] - LIMIT TEST - LIMIT LINE OFFSETS

Softkey	Function	GPIB command
SWP PARAM OFFSET	For the limit lines currently set in the limit line table, sets the sweep parameter offset value. By setting the sweep parameter offset value, all of the set limit lines are moved in the sweep parameter direction by the offset value.	LIMIPRMO <value>
AMPLITUDE OFFSET	For the limit lines currently set in the limit line table, sets the amplitude offset value. By setting the amplitude offset value, all of the set limit lines are moved in the measurement parameter direction by the offset value.	LIMIAMPO <value>
MKR → AMP. OFST.	Substitutes the measurement parameter value at the main marker on the current active trace (A or B) into the amplitude offset value. If you have set the limit center value in the limit line table to zero, you can use this key to change the limit lines using the measurement parameter value at the main marker position as the limit center value. Therefore, you can use this key to maintain a constant limit line shape and difference value (difference between the upper and lower limits) in order to change only the center value for each DUT, that is, to define limit lines immediately suitable for the DUT .	MKRAMPO
return	Returns to Table B-82, "Limit test (Limit Test) menu," on page 408.	(N/A)

Table B-89 Internal clock (Clock) menu

Key operation: [System] - CLOCK

Softkey	Function	GPIB command
TIME ►	Displays Table B-90, "Time configuration (Set Time) menu," on page 413.	SETCTIME <hour>,<minute>,<second>
DATE ►	Displays Table B-91, "Date configuration (Set Date) menu," on page 413.	SETCDATE <year>,<month>,<day>
DATE MODE []	Toggles the date display format between "2-digit number representing month/2-digit number representing day/2-digit number representing year" [MM/DD/YY] and "2-digit number representing day/2-digit number representing month/2-digit number representing year" [DD/MM/YY]. This display format is applied only to time stamps when outputting to a printer (TIME on OFF key in Table B-100, "Copy configuration (Copy Setup) menu (2/2)," on page 418).	DMODE {MDY DMY}
return	Returns to Table B-74, "System (System) menu," on page 404.	(N/A)

Table B-90 Time configuration (Set Time) menu

Key operation: [System] - CLOCK - TIME

Softkey	Function	GPIB command
HOUR	Sets the time (hour).	SETCTIME <hour>,<minute>,<second>
MINUTE	Sets the time (minute).	
SECOND	Sets the time (second).	
done	Finishes the time configuration and returns to Table B-89, “Internal clock (Clock) menu,” on page 412.	(N/A)
cancel	Cancels the time configuration and returns to Table B-89, “Internal clock (Clock) menu,” on page 412.	(N/A)

Table B-91 Date configuration (Set Date) menu

Key operation: [System] - CLOCK - DATE

Softkey	Function	GPIB command
MONTH	Sets the date (month).	SETCDATE <year>,<month>,<day>
DAY	Sets the date (day).	
YEAR	Sets the date (year).	
done	Finishes the date configuration and returns to Table B-89, “Internal clock (Clock) menu,” on page 412.	(N/A)
cancel	Cancels the date configuration and returns to Table B-89, “Internal clock (Clock) menu,” on page 412.	(N/A)

Table B-92 Built-in speaker (Beeper) menu

Key operation: [System] - BEEPER

Softkey	Function	GPIB command
BEEP DONE on OFF	Toggles on and off the beep function that notifies the completion of storing calibration or instrument states.	BEEPDONE {ON OFF}
BEEP WARN on OFF	Toggles on and off the beep function that sounds with warning messages.	BEEPWARN {ON OFF}
return	Returns to Table B-74, “System (System) menu,” on page 404.	(N/A)

Table B-93 System diagnosis (Diagnosis) menu

Key operation: [System] - DIAGNOSTIC TEST

Softkey	Function	GPIB command
RUN TEST	Refer to “Service Manual.”	(N/A)
INTERNAL TEST 	Refer to “Service Manual.”	(N/A)

Key Definitions
Softkeys displayed by pressing the [System] key

Table B-93 System diagnosis (Diagnosis) menu

Key operation: [System] - DIAGNOSTIC TEST

Softkey	Function	GPIB command
EXTERNAL TEST 	Refer to "Service Manual."	(N/A)
DISPLAY TEST	Refer to "Service Manual."	(N/A)
MAC ADDRESS	Displays the MAC address assigned to this Agilent 4294A on the screen. A unique MAC address is assigned to each instrument. The MAC address cannot be changed.	(N/A)
FIRMWARE REVISION	Displays the version information on the firmware currently installed in this Agilent 4294A.	(N/A)
return	Returns to Table B-74, "System (System) menu," on page 404.	(N/A)

Softkeys displayed by pressing the [Local] key

Table B-94 Local (Local) menu

Key operation: [Local]

Softkey	Function	GPIB command
SYSTEM CONTROLLER 	Sets this instrument as the system controller when it is used in a GPIB system. This mode can only be selected by manual operation with the SYSTEM CONTROLLER key. Only one system controller can exist on each GPIB system. Therefore, if there is already a system controller, you cannot set this instrument as the system controller (“CAUTION: CAN’T CHANGE - ANOTHOR CONTROLLER ON BUS” is displayed).	(N/A)
ADDRESSABLE ONLY	Sets this instrument in the addressable-only mode, in which an address can be set, when it is used in a GPIB system. You select this mode when there is already a system controller in the GPIB system. Also, when the controller passes the authority for GPIB control to this instrument, this mode must be set.	(N/A)
ADDRESS: HP-IB	Sets the GPIB address used to control this instrument from an external controller.	(N/A)
ADDRESS: CONTROLLER	Sets the address of this instrument as a controller. This address is used when a controller passes the authority for GPIB control to this instrument.	ADDRCONT <value>
IP ADDRESS ►	Displays Table B-95, “LAN address (LAN Address) menu,” on page 415.	See Table B-95
GATEWAY ADDRESS ►	Displays Table B-95, “LAN address (LAN Address) menu,” on page 415.	See Table B-96
SUBNET MASK ►	Displays Table B-95, “LAN address (LAN Address) menu,” on page 415.	See Table B-97

Table B-95 LAN address (LAN Address) menu

Key operation: [Local] - IP ADDRESS
[Local] - GATEWAY ADDRESS
[Local] - SUBNET MASK

Softkey	Function	GPIB command
1st	Sets the 1st part of an IP address, gateway address, or subnet mask separated by periods (.).	(Refer to corresponding higher-level keys in Table B-94, “Local (Local) menu,” on page 415.)
2nd	Sets the 2nd part of an IP address, gateway address, or subnet mask separated by periods (.).	
3rd	Sets the 3rd part of an IP address, gateway address, or subnet mask separated by periods (.).	
4th	Sets the 4th part of an IP address, gateway address, or subnet mask separated by periods (.).	
done	Stores the configuration of the IP address, gateway address, or subnet mask specified with the above keys and returns to Table B-94, “Local (Local) menu,” on page 415. After performing the configuration, turn the Agilent 4294A off and then on again so that the configuration takes effect.	(N/A)

Key Definitions
Softkeys displayed by pressing the [Local] key

Table B-95 LAN address (LAN Address) menu

Key operation: [Local] - IP ADDRESS
 [Local] - GATEWAY ADDRESS
 [Local] - SUBNET MASK

Softkey	Function	GPIB command
cancel	Cancels setting the IP address, gateway address, or subnet address specified with the above keys and returns to Table B-94, "Local (Local) menu," on page 415.	(N/A)

Table B-96 Gateway address setting (LAN Address) menu

Key operation: [Local] - GATEWAY ADDRESS

Softkey	Function	GPIB command
1st	Sets the 1st part of the gateway address separated by periods (.).	ADDRGW <1st addr>,<2nd addr>,<3rd addr>,<4th addr>
2nd	Sets the 2nd part of the gateway address separated by periods (.).	
3rd	Sets the 3rd part of the gateway address separated by periods (.).	
4th	Sets the 4th part of the gateway address separated by periods (.).	
done	Stores the gateway address setting specified with the above keys and returns to Table B-94, "Local (Local) menu," on page 415. To allow this setting to take effect after pressing this key, turn the Agilent 4294A off and then on again.	(N/A)
cancel	Cancels the gateway address setting specified with the above keys and returns to Table B-94, "Local (Local) menu," on page 415.	(N/A)

Table B-97 Subnet mask setting (LAN Address) menu

Key operation: [Local]-SUBNET MASK

Softkey	Function	GPIB command
1st	Sets the 1st part of the subnet mask separated by periods (.).	SUBNET <1st addr>,<2nd addr>,<3rd addr>,<4th addr>
2nd	Sets the 2nd part of the subnet mask separated by periods (.).	
3rd	Sets the 3rd part of the subnet mask separated by periods (.).	
4th	Sets the 4th part of the subnet mask separated by periods (.).	
done	Stores the subnet mask setting specified with the above keys and returns to Table B-94, "Local (Local) menu," on page 415. To allow this setting to take effect after pressing this key, turn the Agilent 4294A off and then on again.	(N/A)
cancel	Cancels the subnet mask setting specified with the above keys and returns to Table B-94, "Local (Local) menu," on page 415.	(N/A)

Softkeys displayed by pressing the [Copy] key

Table B-98 Copy (Copy) menu

Key operation: [Copy]

Softkey	Function	GPIB command
START	Starts printing the measurement graph displayed on the screen with the printer connected to the printer parallel port on the rear panel. Note that the measurement graph is not displayed on the screen if you have not selected the ALL INSTRUMENT key or the HALF INSTR HALF BASIC key in Table B-21, "Display allocation (Disp Alloc) menu," on page 369.	PRINALL
ABORT	Aborts the printing operation.	COPA
SETUP ►	Displays Table B-99, "Copy configuration (Copy Setup) menu (1/2)," on page 417.	(N/A)
DEFAULT SETTING	Resets the configurations changed with the above SETUP key to the initial values (print resolution: 75 dpi, form feed: ON, form orientation: portrait, softkey label print: OFF, top margin: 1.0 inch, left margin: 1.0 inch).	DFLT
SELECT CONTENTS ►	Displays Table B-101, "Copy data selection (Copy Contents) menu," on page 418.	(N/A)

Table B-99 Copy configuration (Copy Setup) menu (1/2)

Key operation: [Copy] - SETUP

Softkey	Function	GPIB command
B&W 	Selects black-and-white printing.	PRIC STAN
FIXED COLOR 	Selects the print mode in which information on the screen is printed using preset colors.	PRIC FIXE
IMAGE COLOR	Selects the print mode in which colors as close as possible to those on the screen are used ¹ . You can change the colors on the screen in Table B-22, "Display color modification (Modify Color) menu," on page 370.	PRIC VARI
DPI	Sets the resolution in DPI (dot/inch) of the printer used. You can specify the resolution within a range of 75 - 600 dpi.	DPI <value>
TOP MARGIN	Sets the margin at the top of printed forms in inches. You can specify the margin within a range of 0 - 5 inches in steps of 0.1 inch.	TMARG <value>
LFT MARGIN	Sets the margin at the left side of printed forms in inches. You can specify the margin within a range of 0 - 5 inches in steps of 0.1 inch.	LMARG <value>
more 1/2	Displays Table B-100, "Copy configuration (Copy Setup) menu (2/2)," on page 418.	(N/A)
return	Returns to Table B-98, "Copy (Copy) menu," on page 417.	(N/A)

1. Print colors may differ from those displayed on the screen due to the ink used by your printer. The background in printing is always set to white.

Key Definitions
Softkeys displayed by pressing the [Copy] key

Table B-100 Copy configuration (Copy Setup) menu (2/2)

Key operation: [Copy] - SETUP - more 1/2

Softkey	Function	GPIB command
LANDSCAPE on OFF	Toggles on and off the print mode for using forms in the horizontal orientation (landscape). If your printer does not support landscape orientation, this setting is invalid.	LANDSCAPE {ON OFF}
FORM FEED ON off	Toggles on and off the function (form feed) to automatically feed (eject) forms at the completion of printing one screen. If the form orientation is landscape (if landscape is on), this key cannot be pressed (is not displayed).	FORMFEED {ON OFF}
SOFTKEY on OFF	Toggles on and off softkey label print.	PRSOFT {ON OFF}
TIME on OFF	Toggles on and off the time stamp function used when outputting to a printer. If this is set to on, the time and date at the time is printed first, and then the specified screen information is printed.	COPT {ON OFF}
more 2/2	Displays Table B-99, "Copy configuration (Copy Setup) menu (1/2)," on page 417.	(N/A)
return	Returns to Table B-98, "Copy (Copy) menu," on page 417.	(N/A)

Table B-101 Copy data selection (Copy Contents) menu

Key operation: [Copy] - SELECT CONTENTS

Softkey	Function	GPIB command
LIST VALUE ►	Displays Table B-102, "Copy data (Copy Contents) menu," on page 419.	LISV
OPERATING PARAMETERS ►	Displays Table B-102, "Copy data (Copy Contents) menu," on page 419.	OPEP
CAL KIT VALUE ►	Displays Table B-102, "Copy data (Copy Contents) menu," on page 419.	CALS
COMPEN KIT VALUE ►	Displays Table B-102, "Copy data (Copy Contents) menu," on page 419.	COMS
LIST SWEEP SEGMENTS ►	Displays Table B-103, "List sweep segment copy start (Copy Contents) menu," on page 419.	DISL
LIMIT TEST SEGMENTS ►	Displays Table B-104, "Limit test segment copy start (Copy Contents) menu," on page 420.	DISLLIST
return	Returns to Table B-98, "Copy (Copy) menu," on page 417.	(N/A)

Table B-102 Copy data (Copy Contents) menu

Key operation: [Copy] - SELECT CONTENTS - LIST VALUE
 [Copy] - SELECT CONTENTS - OPERATING PARAMETERS
 [Copy] - SELECT CONTENTS - CAL KIT VALUE
 [Copy] - SELECT CONTENTS - COMPEN KIT VALUE

Softkey	Function	GPIB command
START	Prints the information (measured value list, operating parameter, or calibration kit value) displayed on the screen with the printer connected to the printer parallel port on the rear panel. Note that the information is not displayed on the screen if you have not selected the ALL INSTRUMENT key or the HALF INSTR HALF BASIC key in Table B-21, "Display allocation (Disp Alloc) menu," on page 369.	PRINALL
ABORT	Aborts the printing operation.	COPA
TIME on OFF	Toggles on and off the time stamp function used when outputting to a printer. If this is set to on, the current time and date are printed first, and then the specified screen information is printed. This configuration is common to the TIME on OFF key in Table B-100, "Copy configuration (Copy Setup) menu (2/2)," on page 418.	COPT {ON OFF}
NEXT PAGE	Displays the next page of the list displayed on the screen.	NEXP
PREV PAGE	Displays the previous page of the list displayed on the screen.	PREP
RESTORE DISPLAY ►	Displays Table B-101, "Copy data selection (Copy Contents) menu," on page 418.	RESD

Table B-103 List sweep segment copy start (Copy Contents) menu

Key operation: [Copy] - SELECT CONTENTS - LIST SWEEP SEGMENTS

Softkey	Function	GPIB command
START	Prints the list sweep table displayed on the screen with the printer connected to the printer parallel port on the rear panel. Note that the information is not displayed on the screen if you have not selected the ALL INSTRUMENT key or the HALF INSTR HALF BASIC key in Table B-21, "Display allocation (Disp Alloc) menu," on page 369.	PRINALL
ABORT	Aborts the printing operation.	COPA
TIME on OFF	Toggles on and off the time stamp function used when outputting to a printer. If this is set to on, the current time and date are printed first, and then the specified screen information is printed. This configuration is common to the TIME on OFF key in Table B-100, "Copy configuration (Copy Setup) menu (2/2)," on page 418.	COPT {ON OFF}
DISP MODE []	Selects start value and stop value [STRT-STP] or center value and span value [CTR-SPAN] as the display format of the sweep range of the printed list sweep table.	DISMPRM {STSP CTSP}
NEXT PAGE	Displays the next page of the list displayed on the screen.	NEXP
PREV PAGE	Displays the previous page of the list displayed on the screen.	PREP
RESTORE DISPLAY ►	Displays Table B-101, "Copy data selection (Copy Contents) menu," on page 418.	RESD

Key Definitions

Softkeys displayed by pressing the [Copy] key

Table B-104 Limit test segment copy start (Copy Contents) menu

Key operation: [Copy] - SELECT CONTENTS - LIMIT TEST SEGMENTS

Softkey	Function	GPIB command
START	Prints the limit line table displayed on the screen with the printer connected to the printer parallel port on the rear panel. Note that the information is not displayed on the screen if you have not selected the ALL INSTRUMENT key or the HALF INSTR HALF BASIC key in Table B-21, "Display allocation (Disp Alloc) menu," on page 369.	PRINALL
ABORT	Aborts the printing operation.	COPA
TIME on OFF	Toggles on and off the time stamp function used when outputting to a printer. If this is set to on, the current time and date are printed first, and then the specified screen information is printed. This configuration is common to the TIME on OFF key in Table B-100, "Copy configuration (Copy Setup) menu (2/2)," on page 418.	COPT {ON OFF}
DISP MODE []	Selects upper limit and lower limit [UPR-LWR] or center value and difference value [VAL-DLT] as the display format of the limit value of the printed limit line table.	DISMAMP {UL MD}
NEXT PAGE	Displays the next page of the list displayed on the screen.	NEXP
PREV PAGE	Displays the previous page of the list displayed on the screen.	PREP
RESTORE DISPLAY ►	Displays Table B-101, "Copy data selection (Copy Contents) menu," on page 418.	RESD

Softkeys displayed by pressing the [Save] key

Table B-105 Save (Save) menu

Key operation: [Save]

Softkey	Function	GPIB command
STATE >	Selects storage of the configuration states and internal data array of the Agilent 4294A and displays Table B-106, "Filename entry (File Name) menu," on page 421.	SAVDSTA <string>
DATA >	Selects storage of the internal data array of the Agilent 4294A and displays Table B-107, "Data save (Save Data) menu," on page 422.	(N/A)
GRAPHICS >	Selects storage of the displayed screen in TIFF format and displays Table B-106, "Filename entry (File Name) menu," on page 421. It is stored in the colors selected in Table B-99, "Copy configuration (Copy Setup) menu (1/2)," on page 417. The softkeys are also stored.	SAVDTIF <string>
TOUCHSTONE	Selects storage of the internal data array in the touchstone format and displays Table B-107, "Data save (Save Data) menu," on page 422.	SAVDS1P <string>
RE-SAVE FILE >	Displays Table B-111, "File selection (Select File) menu," on page 424.	RESAVD <string>
POWER ON CONFIG >	Displays Table B-109, "Power-on configuration save (Save config?) menu," on page 423.	SAVPSTA
FILE UTILITIES >	Displays Table B-110, "File utility (File Utility) menu," on page 423.	(N/A)
STORE DEV [] >	Displays Table B-81, "Mass storage (Store Device) menu," on page 408. In [] of the softkey label, the currently selected mass storage is displayed (flexible disk drive: [FLOPPY], volatile memory disk: [MEMORY], or nonvolatile memory disk (flash memory): [FLASH]).	(N/A)

Table B-106 Filename entry (File Name) menu

Key operation: [Save] - STATE
 [Save] - DATA - BINARY/ASCII
 [Save] - GRAPHICS
 [Save] - FILE UTILITIES - CREATE DIRECTORY

Softkey	Function	GPIB command
SELECT LETTER	Enters a character indicated by "↑" on the screen.	(N/A)
SPACE	Enters a space.	(N/A)
BACK SPACE	Deletes a character last entered.	(N/A)
CLEAR NAME	Deletes all entered characters.	(N/A)
STORE DEV [] >	Displays Table B-81, "Mass storage (Store Device) menu," on page 408. In [] of the softkey label, the currently selected mass storage is displayed (flexible disk drive: [FLOPPY], volatile memory disk: [MEMORY], or nonvolatile memory disk (flash memory): [FLASH]).	(N/A)

Key Definitions
Softkeys displayed by pressing the [Save] key

Table B-106 Filename entry (File Name) menu

Key operation: [Save] - STATE
[Save] - DATA - BINARY/ASCII
[Save] - GRAPHICS
[Save] - FILE UTILITIES - CREATE DIRECTORY

Softkey	Function	GPIB command
done	Using the entered string as the filename, executes storing states, data, or graphics. When creating a directory, a directory having the entered string is created. After execution, returns to the higher-level menu (Table B-105, “Save (Save) menu,” on page 421, Table B-107, “Data save (Save Data) menu,” on page 422, or Table B-110, “File utility (File Utility) menu,” on page 423).	(N/A)
cancel	Cancels the storage or creation of a directory and returns to the higher-level menu (Table B-105, “Save (Save) menu,” on page 421, Table B-107, “Data save (Save Data) menu,” on page 422, or Table B-110, “File utility (File Utility) menu,” on page 423).	(N/A)

Table B-107 Data save (Save Data) menu

Key operation: [Save] - DATA

Softkey	Function	GPIB command
BINARY ►	Selects storage of measured data in binary format and displays Table B-106, “Filename entry (File Name) menu,” on page 421.	SAVDDAT <string>
ASCII ►	Selects storage of measured data in ASCII format and displays Table B-106, “Filename entry (File Name) menu,” on page 421.	SAVDASC <string>
SELECT CONTENTS ►	Displays Table B-108, “Data save item selection (Save Contents) menu,” on page 422.	(N/A)
STORE DEV [] ►	Displays Table B-81, “Mass storage (Store Device) menu,” on page 408. In [] of the softkey label, the currently selected mass storage is displayed (flexible disk drive: [FLOPPY], volatile memory disk: [MEMORY], or nonvolatile memory disk (flash memory): [FLASH]).	(N/A)
return	Returns to Table B-105, “Save (Save) menu,” on page 421.	(N/A)

Table B-108 Data save item selection (Save Contents) menu

Key operation: [Save] - DATA - SELECT CONTENTS

Softkey	Function	GPIB command
CAL on OFF	Toggles on (stores) and off (does not store) storage of the calibration coefficient array.	SAVCAL {ON OFF}
DATA on OFF	Toggles on (stores) and off (does not store) storage of the data array.	SAVDAT {ON OFF}
MEMORY on OFF	Toggles on (stores) and off (does not store) storage of the memory array.	SAVMEM {ON OFF}
TRACE DATA ON off	Toggles on (stores) and off (does not store) storage of the trace array.	SAVDTRC {ON OFF}
TRACE MEM ON off	Toggles on (stores) and off (does not store) storage of the memory trace array.	SAVMTRC {ON OFF}
return	Returns to Table B-107, “Data save (Save Data) menu,” on page 422.	(N/A)

Table B-109 Power-on configuration save (Save config?) menu

Key operation: [Save] - POWER ON CONFIG

Softkey	Function	GPIB command
yes	Stores the current configuration of the Agilent 4294A as the configuration at power-on (power-on configuration). Also, returns to Table B-105, "Save (Save) menu," on page 421.	(N/A)
cancel	Cancels the storage of the power-on configuration and returns to Table B-105, "Save (Save) menu," on page 421.	(N/A)

Table B-110 File utility (File Utility) menu

Key operation: [Save] - FILE UTILITIES

Softkey	Function	GPIB command
PURGE FILE ►	Searches the mass storage specified with the STORE DEV [] key for files other than program files and directories and displays Table B-111, "File selection (Select File) menu," on page 424, including the filename list.	PURG <string>
CREATE DIRECTORY ►	Displays Table B-106, "Filename entry (File Name) menu," on page 421.	CRED <string>
CHANGE DIRECTORY ►	Searches the mass storage specified with the STORE DEV [] key for directories and displays Table B-111, "File selection (Select File) menu," on page 424, including the filename list.	CHAD <string>
COPY FILE ►	Searches the mass storage specified with the STORE DEV [] key for files other than program files and directories and displays Table B-111, "File selection (Select File) menu," on page 424, including the filename list.	FILC <srcFile>,<srcDevType> ,<dstFile>,<dstDevType> >
FORMAT ►	Displays Table B-113, "Format confirmation (Format Media?) menu," on page 425.	INID
STORE DEV [] ►	Displays Table B-81, "Mass storage (Store Device) menu," on page 408. In [] of the softkey label, the currently selected mass storage is displayed (flexible disk drive: [FLOPPY], volatile memory disk: [MEMORY], or nonvolatile memory disk (flash memory): [FLASH]).	(N/A)
return	Returns to Table B-105, "Save (Save) menu," on page 421.	(N/A)

Key Definitions

Softkeys displayed by pressing the [Save] key

Table B-111 File selection (Select File) menu

Key operation: [System] - PROGRAM MENU
 [Save] - RE-SAVE FILE
 [Save] - FILE UTILITIES - PURGE FILE/ CHANGE DIRECTORY/ COPY FILE

Softkey	Function	GPIB command
(filename)	For the program menu ([System] - PROGRAM MENU), this key immediately executes the program having the specified filename. For file resolve ([Save] - RE-SAVE FILE), this key overwrites the old file having the specified filename with the present data using the same data items and format. For file deletion ([Save] - FILE UTILITIES - PURGE FILE), this key displays Table B-112, “File deletion confirmation (Purge File?) menu,” on page 424 after the filename is selected. For directory change ([Save] - FILE UTILITIES - CHANGE DIRECTORY), this key changes the current directory to the specified directory. For file copy ([Save] - FILE UTILITIES - COPY FILE), this key displays Table B-114, “Copy destination filename (Dest File) menu,” on page 425, after the filename is selected. In any of the above cases, if a softkey label is a directory name (“\” is located at the end of the name), pressing the key changes the current directory to the label’s directory, and files or subdirectories under the directory are displayed as softkey labels. Pressing the “..” directory name moves the current directory to the higher-level directory.	(N/A)
(filename)	Has the same function as above.	(N/A)
(filename)	Has the same function as above.	(N/A)
(filename)	Has the same function as above.	(N/A)
PREV FILES	Displays the previous page of the filename list displayed as the softkey labels.	(N/A)
NEXT FILES	Displays the next page of the filename list displayed as the softkey labels.	(N/A)
STORE DEV [] ►	Displays Table B-81, “Mass storage (Store Device) menu,” on page 408. In [] of the softkey label, the currently selected mass storage is displayed (flexible disk drive: [FLOPPY], volatile memory disk: [MEMORY], or nonvolatile memory disk (flash memory): [FLASH]).	(N/A)
return	Returns to the higher-level menu that displayed this menu (Table B-74, “System (System) menu,” on page 404, Table B-105, “Save (Save) menu,” on page 421, or Table B-110, “File utility (File Utility) menu,” on page 423).	(N/A)

Table B-112 File deletion confirmation (Purge File?) menu

Key operation: [Save] - FILE UTILITIES - PURGE FILE - (filename)

Softkey	Function	GPIB command
yes	Executes the deletion of the specified file and returns to Table B-111, “File selection (Select File) menu,” on page 424.	(N/A)
cancel	Cancels the deletion of the specified file and returns to Table B-111, “File selection (Select File) menu,” on page 424.	(N/A)

Table B-113 Format confirmation (Format Media?) menu

Key operation: [Save] - FILE UTILITIES - FORMAT

Softkey	Function	GPIB command
yes	Starts the initialization of the mass storage (disk) specified with the STORE DEV [] key in Table B-110, "File utility (File Utility) menu," on page 423. Executing the initialization of the mass storage (disk) deletes all files on the disk. When the initialization is completed, returns to Table B-110, "File utility (File Utility) menu," on page 423.	(N/A)
cancel	Cancels the initialization of the mass storage (disk) and returns to Table B-110, "File utility (File Utility) menu," on page 423.	(N/A)

Table B-114 Copy destination filename (Dest File) menu

Key operation: [Save] - FILE UTILITIES - COPY FILE - (filename)

Softkey	Function	GPIB command
SELECT LETTER	Enters a character indicated by "↑" on the screen at the position of the cursor () on the filename entry line.	(N/A)
SPACE	Enters a space at the position of the cursor () on the filename entry line.	(N/A)
BACK SPACE	Moves the cursor () on the filename entry line to the left and deletes the character at that position.	(N/A)
CLEAR NAME	Deletes all entered characters on the filename entry line.	(N/A)
DEST DEV [] ▶	Displays Table B-115, "Copy destination device (Dest Device) menu," on page 425. In [] of the softkey label, the currently selected mass storage is displayed (flexible disk drive [FLOPPY], volatile memory disk [MEMORY], or nonvolatile memory disk (flash memory) [FLASH]).	(N/A)
done	Creates a new file using the string entered in the filename entry line as the copy destination filename. Note that when the copy destination filename menu appears, the copy source filename is already set in the filename entry line. If the device and filename of the copy source and those of the copy destination are the same, "-257 Filename error" occurs. In this case, before pressing done, change the copy destination device with the DEST DEV [] key or change the copy destination filename with the SELECT, SPACE, and BACK SPACE keys.	(N/A)
cancel	Cancels copying of the file and returns to Table B-110, "File utility (File Utility) menu," on page 423.	(N/A)

Table B-115 Copy destination device (Dest Device) menu

Key operation: [Save] - FILE UTILITIES - COPY FILE - (filename) - DEST DEV []

Softkey	Function	GPIB command
FLOPPY 	Selects the flexible disk drive as the file copy destination mass storage ¹ .	(N/A)
MEMORY 	Selects the volatile memory disk as the file copy destination mass storage.	(N/A)
FLASH MEMORY	Selects the nonvolatile memory disk (flash memory) as the copy destination mass storage.	(N/A)

Table B-115 Copy destination device (Dest Device) menu

Key operation: [Save] - FILE UTILITIES - COPY FILE - (filename) - DEST DEV []

Softkey	Function	GPIB command
return	Returns to Table B-114, "Copy destination filename (Dest File) menu," on page 425.	(N/A)

1. The selection of the mass storage device is set independently in each of the following menus: this menu, Table B-79, "IBASIC mass storage (Mass Storage) menu," on page 407, and Table B-81, "Mass storage (Store Device) menu," on page 408. However, there is only a single set of mass storage devices for all menu selections.

Softkeys displayed by pressing the [Recall] key

Table B-116 Recall (Select File) menu

Key operation: [Recall]

Softkey	Function	GPIB command
(filename)	This key loads the specified state file and uses the instrument configuration states stored in the file (including the internal data array). If a softkey label is a directory name (“\” is located at the end of the name), pressing the key changes the current directory to the label’s directory, and files or subdirectories under the directory are displayed as softkey labels. Pressing the “..” directory name moves the current directory to the higher-level directory.	(N/A)
(filename)	Has the same function as above.	(N/A)
(filename)	Has the same function as above.	(N/A)
(filename)	Has the same function as above.	(N/A)
PREV FILES	Displays the previous page of the filename list displayed as softkey labels described above.	(N/A)
NEXT FILES	Displays the next page of the filename list displayed as softkey labels described above.	(N/A)
STORE DEV [] ►	Displays Table B-81, “Mass storage (Store Device) menu,” on page 408. In [] of the softkey label, the currently selected mass storage is displayed (flexible disk drive: [FLOPPY], volatile memory disk, [MEMORY], or nonvolatile memory disk (flash memory), [FLASH]).	(N/A)

Key Definitions

Softkeys displayed by pressing the [Recall] key

C Error messages

The Agilent 4294A provides error messages to indicate its operating status. This appendix describes the error messages of the Agilent 4294A.

Error messages are outputted on the LCD or through the GPIB. This section gives a description of each error message and how it should be handled.

NOTE

If an error with a positive error number occurs, only its error message is displayed on the LCD following the string of “CAUTION:” (in this case, its error number is not displayed). On the other hand, if an error with a negative error number occurs, “CAUTION: HP-IB error occurred” is always displayed on the LCD. When error messages are outputted through GP-IB, their error number and error message are outputted for all errors (“CAUTION:” is not added). Some messages displayed on the LCD do not have “CAUTION:”; these are not error messages. Messages without “CAUTION:” are not described here.

Errors with a negative error number are basically general errors for GPIB instruments defined by IEEE488.2. On the other hand, errors with a positive error number are ones defined specifically for the Agilent 4294A.

The error message displayed on the LCD display due to the occurrence of an error will not disappear even if the cause of the error is removed. To clear the error message display, press the **[Entry Off]** key. Also, the error message disappears when you call new softkey labels using a hardkey or softkey or when you display a new parameter value in the Set Parameter Value field.

If a new error occurs, the previously displayed error message is replaced with the new one. Therefore, even if several errors occur successively at short time intervals, you can only read the last message. To display and recheck a past message, follow the steps in “Re-displaying an Instrument Message” on page 300.

This chapter explains the error messages in alphabetical order. They are also described in the error number order in the *Programming Manual*.

Error Messages (alphabetical order)

A

135

ADC OVERLOAD

Due to, for example, a sudden change in the connection of a DUT, the internal circuit (ADC) is temporarily overloaded. Measurement data when this error occurs is invalid. If this error often occurs during normal measurements, the instrument may fail. In this case, Contact your local Agilent Technologies sales office or the company you purchased this instrument from.

10

ADDITIONAL STANDARDS NEEDED

Before completing measurement of all calibration standards (OPEN, SHORT, LOAD) required for user calibration or four-terminal pair extension setting, a GPIB command (CALDON or ECALDON) to calculate error coefficients is sent. The command is invalid. Finish measuring any remaining calibration standard.

B

17

BACKUP DATA LOST

This error (check sum error) occurs after losing the contents of the battery-powered backup

memory (SRAM), which stores user calibration data, fixture compensation data, GP-IB address, IP address, and so on. This is caused by the battery used for backup being drained. To again enable the battery-powered backup memory, turn on the power and keep the device on for approximately 10 minutes to charge the battery completely.

-160

Block data error

An error not described by error numbers from -161 to -169 occurs during the syntax analysis of block data.

-168

Block data not allowed

A block data element is received where the Agilent 4294A does not accept any block data element.

136

BRIDGE UNBALANCED

Because the connection of a DUT or the setting for it is incorrect, the internal circuit (BRIDGE) temporarily cannot perform measurements (UNBALANCED).

- The setting of the four-terminal pair extension (NONE, 4TP 1M, 4TP 2M, 7mm 42942A, PROBE 42941A) may not match the fixture, cable, adapter, or probe actually connected. Check and correct the setting.
- The setup (acquisition of calibration data) for the setting of the four-terminal pair extension may have failed. If necessary, perform the setup again.
- Some measured DUTs may cause this error due to their characteristics. In this case, the error may be avoided by changing the measurement conditions (for example, lowering the measurement signal level).

If this error often occurs in normal measurements, the instrument may fail. In this case, Contact your local Agilent Technologies sales office or the company you purchased this instrument from.

C

13

CALIBRATION ABORTED

One of the following problems has occurred.

- In the middle of or after the completion of the setup for user calibration or fixture compensation (measurement of required calibration data and calculation and storage of error coefficients), the setting of calibration points (FIXED or USER) is changed. The current setup and error coefficients previously stored become invalid.
- When the setting of calibration points is USER, in the middle of or after the completion of the setup for user calibration or fixture compensation (measurement of required calibration data and calculation and storage of error coefficients), the sweep condition (sweep range, sweep parameter, number of sweep points, sweep type) is changed. The current setup and error coefficients previously stored become invalid.
- In the middle of the setup for user calibration or four-terminal pair extension (measurement of required calibration data and calculation and storage of error coefficients), the setup is canceled (the cancel key, CALQUI command, or ECALQUI command is executed). The setup is invalid, but error coefficients previously stored are still available.

If necessary, again perform the setup for user calibration, fixture compensation, or

CALIBRATION NOT USABLE

four-terminal pair extension.

12

CALIBRATION NOT USABLE

A command to execute data measurement for unnecessary (not allowed) calibration (user calibration or fixture compensation) for the current adapter selection is sent. The command is invalid. For example, when NONE (no adapter) is selected as the adapter selection, sending the CALA command, which executes OPEN data measurement for the user calibration, causes this error (when the adapter selection is NONE, you cannot execute the user calibration).

Execute the measurement of necessary (allowed) calibration data for the current adapter selection. For more information on the appropriate adapter selection and calibration, refer to Table 6-1, "Device Connection and Corresponding Adapter Selection and Calibration," on page 130

11

CALIBRATION REQUIRED

In user calibration or fixture compensation, although error coefficients based on the measurement of the required calibration standards (OPEN, SHORT, or LOAD) have not been acquired, a GP-IB command (CALST ON, COMCA ON, COMCB ON, or COMCC ON) to turn on the user calibration function or fixture compensation function is sent. Valid error coefficients are not detected, and the command is invalid. For user calibration, it is necessary to measure all calibration standards (OPEN, SHORT, LOAD) and acquire error coefficients based on the measurement. On the other hand, for fixture compensation, it is necessary to measure a calibration standard (OPEN, SHORT, or LOAD) corresponding to the fixture compensation function (OPEN compensation function, SHORT compensation function, or LOAD compensation function) you select and obtain error coefficients based on the measurement.

-281

Cannot create program

Programs cannot be created. Insufficient memory is suspected.

35

CAN'T CALCULATE EQUIVALENT PARAMETERS

Because measurement data does not match the selected equivalent circuit, equivalent circuit parameters cannot be calculated. Acquire data again or select another equivalent circuit.

82

CAN'T CHANGE—ANOTHER CONTROLLER ON BUS

When an active controller is on the same GP-IB bus, you attempt to set the Agilent 4294A as a system controller. Unless another active controller is removed from the same GP-IB bus, you cannot set the 4294A as a system controller.

133

CAN'T CHANGE ON LIST SWEEP

When the sweep type is set to the list sweep, you attempt to execute a command to specify the lower limit of a partial search range (SEARMIN) or a command to specify the upper limit of a partial search range (SEARMAX) and, as a result, the command is ignored.

When the sweep type is the list sweep, you cannot specify a partial search range by using the lower limit and the upper limit. You must first specify a sweep type other than the list sweep (command: SWPT LIN or SWPT LOG).

130

CAN'T CHANGE ON ZERO SPAN

During the execution of the list sweep when the sweep span of each segment is zero, you attempt to change the list sweep span (integrated total span of individual segments specified as the horizontal axis of the graph for the list sweep) to a single span (specifying a linear frequency axis for the horizontal axis of a graph whose left edge and right edge are

CAN'T SAVE GRAPHICS WHEN COPY IN PROGRESS

the minimum frequency and the maximum frequency, respectively, within all segments) with the LIST SPAN [] key or the LISPAN SINGLE command and, as a result, the command is ignored. When executing the list sweep when the sweep span of each segment is set to zero, the list sweep span is automatically set to the segment span and cannot be changed.

114

CAN'T SAVE GRAPHICS WHEN COPY IN PROGRESS

You want to execute a command to save the graphics screen during copying (outputting to a printer), but the graphics screen cannot be saved during printing.

-140

Character data error

An error not described by error numbers from -141 to -149 occurs during the syntax analysis of a character data element.

-148

Character data not allowed

A character data element (that does not violate the standard) is received where the Agilent 4294A does not accept any character data element. For example, a parameter must be enclosed with double quotation marks (“”) but they are missing.

-144

Character data too long

The length of the character data element exceeds 12 characters. (Refer to IEEE488.2,7.7.1.4.)

-100

Command error

A comprehensive syntax error occurs for which the Agilent 4294A cannot detect further details of the error. This error code simply indicates the occurrence of a command error that is defined in IEEE488.2,11.5.1.1.4.

75

COMMAND IGNORED—SEGMENT NOT DONE YET

During the editing of a segment in the list sweep table or limit line table, an inappropriate edit command (EDIT LIML, EDITLIST, LIMCLEL, LIMSEDI, LIMSADD, LIMSDEL, SLEL, SEDI, SADD, SEGM) is sent and, as a result, the command is ignored. If necessary, execute SDON (command to finish the editing of a list sweep segment), or LIMSDON (command to finish the editing of a limit segment) to finish the editing of the segment and then perform the setting.

74

CURRENT EDITING SEGMENT SCRATCHED

During the editing of a segment in the list sweep table or limit line table, a key or command not related to edit of the table is executed, and the segment being edited becomes invalid. To avoid this, press the “done key” in the segments menu, SDON (command to finish the editing of a list sweep segment), or LIMSDON (command to finish the editing of a limit segment) and then perform other settings.

D

91

DATA AND MEMORY TRACE NOT DISPLAYED

While the data trace and memory trace are not both displayed, you attempt to change the setting of the data & memory couple (command: SCAC ON or SCAC OFF). To change the setting of the data & memory couple, first display both the data trace and the memory trace (command: DISP DATM).

-230

Data corrupt or stale

Error messages
Data out of memory

The data may be invalid. Otherwise, a newly initiated read operation may not have been completed since the latest access.

-225 **Data out of memory**

The Agilent 4294A does not have enough memory to perform the requested operation.

-222 **Data out of range**

A data element (that did not violate the standard) out of the range defined by the Agilent 4294A is received.

-231 **Data questionable**

Data may be questionable, and so the accuracy of measurement data may be deteriorated.

-104 **Data type error**

The parser recognized impossible data elements. For example, numeric values or string data are expected, but block data are sent.

138 **DCBIAS CONSTANT OPERATION FAILED**

When the dc bias mode is constant voltage (VOLT CONSTANT) or constant current (CURRENT CONSTANT), the actual dc bias output does not converge to the set dc voltage value or dc current value, or it exceeds the set voltage limit or current limit. If a DUT needs time to stabilize after dc bias is applied, specify the point delay. If necessary, change the voltage limit value or the current limit value.

139 **DCBIAS LEVEL MONITOR NOT VALID**

When the dc bias level monitor is not on, you attempt to execute the command to turn on the marker dc voltage level monitor or the marker dc current level monitor (MKRMON DCV or MKRMON DCI) and, as a result, the command is ignored. Before turning on the marker dc voltage level monitor or the marker dc current level monitor, turn on the corresponding dc bias level monitor (command: BMON VOLT or BMON CURR).

137 **DCBIAS OVERLOAD**

When the dc bias is applied, dc current that exceeds the setting of the dc bias range (<1mA, <10mA, or <100mA) is supplied from the bias source, or the overcurrent limit circuit of the dc bias source takes effect. Increase the setting of the dc bias range or decrease the level of the applied dc bias.

99 **DELTA MARKER OFF**

When the delta marker is not displayed, you attempt to execute a function that needs the display of the delta marker and, as a result, the command is ignored. For example, when the delta marker is not displayed, a command corresponding to the MKRD?SPAN key (MKRDSPAN) is sent. Before executing a function with the delta marker, first display the delta marker (command: DMKR ON).

118 **DEVICE TYPE IS NOT DOS**

The execution of write access to the mass storage cannot be executed because the format type of the mass storage is not DOS.

37 **DISPLAY BUFFER IS FULL**

Executing the DRAW or MOVE command in HP Instrument BASIC fills the Agilent 4294A's display buffer to its capacity. Further write to the display buffer is impossible.

E

- 194 **EEPROM WRITE FAIL**
- A write error is detected in the memory (EEPROM) to store the OPEN, SHORT, and LOAD data for the four-terminal pair extension setting. Contact your local Agilent Technologies sales office or the company you purchased this instrument from.
- 200 **Execution error**
- A comprehensive execution error occurs and the Agilent 4294A cannot detect further details of the error. This error code simply indicates the occurrence of an execution error defined in IEEE 488.2, 11.5.1.1.5.
- 123 **Exponent too large**
- The absolute value of the exponent exceeds 32,000. (Refer to IEEE 488.2, 7.7.2.4.1.)
- 178 **Expression data not allowed**
- An equation data element was received at where the 4294A did not accept any equation data elements.
- 170 **Expression error**
- An error not described by error numbers from -171 to -179 occurs during the syntax analysis of equation data.

F

- 257 **FILE NAME ERROR**
- There is an error in the filename and, as a result, the command is not executed correctly. This message is displayed, for example, when you attempt to copy a file using the same filename.
- 256 **File name not found**
- The specified filename is not found and, as a result, the command is not executed correctly. This message is displayed, for example, when you attempt to read/write a file that does not exist on the disk.
- 143 **FLOATING POINT ERROR OCCURRED**
- Due to the execution of an application inside the instrument for inappropriate data sent from outside the instrument, an error for floating point operations occurs inside the instrument. The result of the operation may be incorrect. Contact your local Agilent Technologies sales office or the company you purchased this instrument from.
- 85 **FORMAT NOT VALID FOR COMPLEX MEASUREMENT**
- When COMPLEX Z-Y (i.e., complex parameter measurement) is selected as a measurement parameter, you attempt to select a display format not available for the measurement parameter, for example, the linear scale format (FMT LINY command), and, as a result, the command is ignored. When COMPLEX Z-Y is selected as a measurement parameter, set the display format to the complex plane display format (command: FMT COMP) or the polar coordinates display format (command: FMT POLA).
- 86 **FORMAT NOT VALID FOR SCALAR MEASUREMENT**

Error messages
FREQUENCY SWEEP ONLY

When a measurement parameter other than COMPLEX Z-Y (i.e., scalar parameter measurement) is selected, you attempt to select a display format not available for the measurement parameter, for example, the complex plane display format (command: FMT COMP), and, as a result, the command is ignored. When a measurement parameter other than COMPLEX Z-Y is selected, select a display format from the linear scale format (command: FMT LINY), the log scale format (command: FMT LOGY), or the percent format (command: FMT PERC).

131 **FREQUENCY SWEEP ONLY**

When a sweep parameter other than frequency is specified, you attempt to execute an equivalent circuit analysis command (CALECPARA and so on). You can execute the equivalent circuit analysis only when the sweep parameter is frequency.

G

-105 **GET not allowed**

A group execution trigger (GET) was received in a program message. (Refer to IEEE488.2,7.7.)

H

-240 **Hardware error**

The program command cannot be executed due to a hardware-related error. This indicates that an error other than -241 to -249 has occurred.

-241 **Hardware missing**

The received command or Query complies with the standard but cannot be executed due to hardware-related reasons (for example, the option is not installed).

-111 **Header separator error**

The header separator is wrong. This error is displayed when a character other than a defined header follows the header. For example, when “*SRE 4” is correct, a character follows the header without a space as “*SRE4”.

-114 **Headers Suffix out of range**

The suffix of the header is out of range. The suffix of a numeral parameter that follows the SCPI command makes the header invalid.

I

-224 **Illegal parameter value**

The value of the parameter is illegal.

-282 **Illegal program name**

The program name is illegal. This message is displayed, for example, when you attempt to delete a program name that does not exist, define an existing program name again, or refer to a program that does not exist.

-283 **Illegal variable name**

- The variable name is illegal. This message is displayed when you attempt to refer to a variable that does not exist.
- 213 **Init ignored**
- Another measurement is being executed, so the measurement start request is ignored.
- 141 **INSUFFICIENT MEMORY**
- Multiple processes are executed at the same time and the memory is exhausted, which causes the last process to be aborted. For example, if you try to simultaneously execute an HP Instrument BASIC program, print the screen, and transfer the data array, the memory of the system is depleted and this message may be displayed. In this case, terminate some of the processes and then perform the next operation.
- 161 **Invalid block data**
- Block data is expected but the given block data is invalid for some reason. (Refer to IEEE488.2,7.7.6.2.) For example, the END message is received before the length of the block data is reached.
- 101 **Invalid character**
- Invalid characters exist in the program message string. For example, for a correct program message, “MEAS IRIM,” an ampersand (&) is inserted by mistake as “MEAS&IRIM.”
- 141 **Invalid character data**
- There are invalid characters in a character data element or the received parameter is not valid. For example, although the correct program message is “MEAS LSR,” a wrong program message, “MEAS LSD,” is received.
- 121 **Invalid character in number**
- An invalid character for the data type of the syntax analysis target is received. For example, alphabetical characters exist in a decimal value, or “9” exists in octal data.
- 154 **INVALID DATE**
- You attempt to specify the date of the built-in clock with the DATE key or the SETCDATE command, but the date is out of range and, as a result, the setting you attempt to execute becomes invalid. The available range is: 1900 to 2099 for year, 1 to 12 for month, and 1 to 31 for day. Also, you cannot specify a date that does not actually exist. Be sure to specify correct date data.
- 171 **Invalid expression**
- The equation data element is invalid. (Refer to IEEE488.2,7.7.7.2.) For example, parentheses are not paired or a character violates the standard.
- 112 **INVALID FILE NAME**
- When the recall command (RECD <string>) or the re-save command (RESAVD <string>) is executed, a string that indicates a file name is not followed by a necessary extension and, as a result, the command is ignored. Add a required extension and then perform recall or re-save. This message occurs, for example, when you attempt to execute the recall or re-save command without adding an extension (“.STA”, “.DAT”, “.TXT”) to a file name. It also occurs when you attempt to execute re-save of a graphics file without adding an extension (“.TIF”).
- 103 **Invalid separator**

Error messages

Invalid string data

The parser (syntax analysis program) expects a separator, but a character other than a separator is sent. For example, although “;” should be used to separate two sent program messages such as “MEAS IRIM;FMT LOGY”, the semicolon (;) for separating the program messages is missing as “MEAS IRIM FMT LOGY”.

-151 **Invalid string data**

Character string data is expected but the given string data are invalid for some reason. (Refer to IEEE488.2,7.7.5.2.) For example, the END message is received before the end quotation mark character appears.

-131 **Invalid suffix**

The suffix does not meet the syntax defined in IEEE488.2,7.7.3.2 or is inappropriate for the Agilent 4294A.

L

132 **LIST SWEEP ONLY**

When a sweep type other than the list sweep is specified, you attempt to execute a command to specify all segments (entire sweep range) as the search range setting (SEARNG FULL) or a command to specify a certain segment as the search target (SEGMNUM <value>) and, as a result, the command is ignored. Before setting the search range for the list sweep, specify the list sweep as the sweep type (command: SWPT LIST).

124 **LIST TABLE EMPTY OR INSUFFICIENT TABLE**

When the list sweep table is empty or insufficient, you attempt to select LIST as the sweep type (command: SWPT LIST) and, as a result, the command is ignored. Before selecting the list sweep as the sweep type, set the list sweep table correctly.

M

-250 **MASS STORAGE ERROR**

A mass storage error other than -257 occurs.

88 **MATH FUNCTION NOT VALID FOR PERCENT FORMAT**

When the percent format is selected as the display format, you attempt to change the setting of data operations. In the percent format, data operations are fixed to delta % (command: MATH DELP), and thus you cannot change the data operation setting to DATA (command: MATH DATA), DATA-MEM (command: MATH DMNM), or DATA/MEM (command: MATH DDVM).

105 **MEASUREMENT PARAMETER NOT FOR ANALYSIS**

When a measurement parameter other than |Z|-q is set, you attempt to execute a waveform analysis command (for example, OUTPCERR?) and, as a result, the command is ignored. Before executing a waveform analysis command, set the measurement parameter to |Z|-θ (command: MEAS IMPH).

-258 **Media protected**

You attempt to save/delete data to/from the storage device or initialize the media, but the media is write-protected, and, as a result, the operation cannot be executed. This message is displayed, for example, when you have specified the floppy disk drive as the storage device

and a floppy disk is write-protected. If necessary, disable the write-protection of the floppy disk.

-311

Memory error

An error is detected in the memory of the Agilent 4294A.

34

MEMORY TRACE NOT ACTIVE

Although no data is stored in the memory trace, you attempt to execute a command (DISP MEMO, DMNM, and so on) that uses the memory trace. Therefore, the command is invalid. First, use the DATMEM command and store data in the memory trace.

-252

Missing media

You attempt to access a storage device, but the media type does not exist or is not installed correctly. This message is displayed, for example, when you specify the floppy disk drive as the storage device but no floppy disk is correctly inserted into the drive.

-109

Missing parameter

The number of parameters is less than that the command requires. For example, although the "POIN" command requires 1 parameter such as "POIN 101," no parameter is added as "POIN."

36

MUST BE MORE THAN 2 POINTS FOR ANALYSIS

Although the calculation of equivalent circuit parameters (CALCULATE PARAMETERS key, CALC PARMS key, or CALECPARA command) is executed, because the number of points (NOP) within the sweep range (if the partial search function is on and within the specified search range) is two, they cannot be calculated. Set the number of points within the sweep range (if the partial search function is on, within the specified search range) to three or more.

N

98

NO ACTIVE MARKER

When the marker is not displayed, you attempt to execute the marker moving (Marker?) function and, as a result, the command is ignored. For example, when the marker is not displayed, a command corresponding to the MKR?START key (MKRSTAR) is sent. Before executing the marker moving function, display the marker (command: MKR ON).

0

(No error)

No error has occurred. This message is not displayed on the LCD. 0 is returned as the error number if no error occurs in the instrument when the OUTPERRO? command is sent through GP-IB.

100

NO FIXED DELTA MARKER

When the fixed Δ marker (FIXED DMKR) is not displayed, you attempt to execute a command of a function that needs the display of the fixed Δ marker and, as a result, the command is ignored. For example, when the fixed Δ marker is not displayed, a command corresponding to the FIXED DMKR VALUE, FIXED DMKR AUX VALUEN key (DMKRVAL <value>, DMRRAUV <value>) is sent. Before executing a function using the fixed Δ marker, first display the fixed Δ marker (command: DMKR FIX).

113

NO STATE/DATA FILES ON DISK

Although you attempt to display the list of files and directories on a floppy disk on the

NO STATE/DATA FILES ON MEMORY

softkey labels with the recall ([Recall]) key, file re-save (RE-SAVE FILE) key, file deletion (PURGE FILE) key, directory change (CHANGE DIRECTORY) key, or file copy (COPY FILE) key, no file or directory corresponding to the execution of the key is on the floppy disk.

116 **NO STATE/DATA FILES ON MEMORY**

Although you attempt to display the list of files and directories on a volatile memory disk or nonvolatile memory disk (flash memory) on the softkey labels with the recall ([Recall]) key, file re-save (RE-SAVE FILE) key, file deletion (PURGE FILE) key, directory change (CHANGE DIRECTORY) key, file copy (COPY FILE) key, and so on, no file or directory corresponding to the execution of the key is on the volatile memory disk or nonvolatile memory disk (flash memory).

55 **NOT ENOUGH DATA**

When data is sent from the controller to the Agilent 4294A in the FORM2, FORM3, or FORM5 data transfer format, the amount of sent binary data is too small, or data items do not reach the number of points (NOP) set in the 4294A. Set the amount of data to be sent or the number of points correctly.

83 **NOT VALID FOR COMPLEX MEASUREMENT**

When the COMPLEX Z-Y measurement parameter (that is, complex parameter measurement) is selected, a command to execute one of the following is sent. As a result, the command is ignored.

- Setting or reading an offset value in the trace calculation function (DATOVAL command)
- Assigning the main marker to the offset value in the trace calculation function (MKROFS command)
- Selecting DELTA % in the trace calculation function (DISP DELP command)

When making the above settings, first select a measurement parameter other than COMPLEX Z-Y.

84 **NOT VALID FOR SCALAR MEASUREMENT**

When a measurement parameter other than COMPLEX Z-Y (that is, scalar parameter measurement) is selected, a command to execute one of the following is sent. As a result, the command is ignored.

- Setting the secondary measurement parameter value of the fixed Δ marker (DMKRAUV command)
- Selecting DATA/MEM in the trace calculation function (DISP DDVM command)

When making the above settings, first select the COMPLEX Z-Y measurement parameter.

-120 **Numeric data error**

Numeric data (including numeric data without a decimal point) is causing an error. A numeric value error other than -121 to -129 has occurred.

-128 **Numeric data not allowed**

A numeric value data element (that did not violate the standard) is received where the Agilent 4294A does not accept any numeric value data elements.

O

140 **OSC LEVEL MONITOR NOT VALID**

When the oscillator level monitor is not on, you attempt to execute a command to turn on the marker's ac voltage level monitor or the marker's ac current level monitor (MKRMON ACV or MKRMON ACI) and, as a result, the command is ignored. Before turning on the marker's ac voltage level monitor or the marker's ac current level monitor, turn on the ac bias level monitor (command: OMON ON).

P

-220 **Parameter error**

An error not described by error numbers from -221 to -229 occurs during the analysis of a program data element. This error occurs, for example, when you attempt to specify an invalid value for the LOAD correction reference value or the LOAD correction data (values that are not finite when converted to R-X form impedance values). If this error occurs, the command is ignored. This error also occurs when you attempt to specify an invalid LOAD correction reference value from the front panel keys.

-108 **Parameter not allowed**

The number of parameters is larger than that the command requires. For example, though the "POIN" command requires one parameter such as "POIN 101," two parameters are added as "POIN 101,1."

89 **PERCENT FORMAT NOT SELECTED**

When the percent format is not selected as the display format, you attempt to select delta % as the data operation setting (you send the MATH DELP command). If you want to select delta % as the data operation setting, the percent format (command: FMT PERC) must be selected as the display format.

48 **PHASE LOCK LOOP UNLOCKED**

Anomalies in the Agilent 4294A's internal circuit are detected (phase lock loop is not locked). The instrument needs adjustment or repair. Contact your local Agilent Technologies sales office or the company you purchased this instrument from.

193 **POWER ON TEST FAILED**

In the power-on self-test, an instrument fault is detected. Contact your local Agilent Technologies sales office or the company you purchased this instrument from.

26 **PRINTER: not on, not connected, out of paper**

The printer does not respond to commands from the Agilent 4294A. Check the power to the printer, on-line status, paper, and so on. Otherwise, the connected printer may not be supported. For information on supported printers, refer to the "Options and accessories" chapter.

-284 **Program currently running**

A program is running. This message is displayed when you attempt to perform an operation that cannot be executed at the same time as a program is running. For example, this occurs when you attempt to delete a running program.

-280 **Program error**

Error messages

Program mnemonic too long

An error occurred in a downloaded program. A program error other than -281 to -289 occurred.

-112

Program mnemonic too long

The length of the header exceeds 12 characters. (Refer to IEEE488.2,7.6.1.4.1.)

-286

Program runtime error

An error occurs while an HP Instrument BASIC program is being executed. To obtain detailed information on the particular error, use the ERRM\$ or ERRM command of HP Instrument BASIC.

-285

Program syntax error

A program syntax error occurs in the downloaded program.

Q

-430

Query DEADLOCKED

The current status causes a “DEADLOCKED” Query error. (Refer to IEEE488.2,6.3.1.7.) This error occurs, for example, when both input and output buffers become full and the Agilent 4294A cannot continue processing.

-400

Query error

A comprehensive Query error occurs, and the Agilent 4294A cannot detect further details of the error. This code simply indicates the occurrence of a Query error that is defined in IEEE488.2,11.5.1.1.7 and 6.3.

-410

Query INTERRUPTED

The current status causes an “INTERRUPTED” Query error. (Refer to IEEE488.1,6.3.2.3.) This error occurs, for example, when after Query, data byte (DAB) or GET is received before the response has been sent completely.

-420

Query UNTERMINATED

The current status causes an “UNTERMINATED” Query error. (Refer to IEEE488.2,6.3.2.) This error occurs, for example, when the 4294A is specified as a talker and an incomplete program message is received.

-440

Query UNTERMINATED after indefinite response

In a certain program message, after a Query that requests an ambiguous response is executed, another Query is received. (Refer to IEEE488.2,6.5.7.5.7.)

-350

Queue overflow

The queue contains a certain code instead of the code that caused this error. This code indicates that an error has occurred due to insufficient space in the queue but it has not been recorded.

R

111

RECALL ERROR: INSTR STATE PRESET

Because an error occurred while reading out a file, the Agilent 4294A is being preset. This

error occurs, for example, when data in a file to be read out is destroyed or when an extension for a file name does not match with the contents of the file.

134

REDUCE OSC LEVEL

The oscillator level is considerably higher than the measured $|Z|$ (absolute value of impedance) of the DUT, causing increased nonlinear measurement error that cannot be ignored. This message is displayed when the oscillator level is set to greater than 0.5 V while $|Z|$ of the DUT is smaller than 48 Ω . To avoid this error, set the oscillator level below 0.5 V.

S

110

SAVE ERROR

When saving a file, anomalies in the storage media are detected. For example, if you attempt to save a file on a floppy disk, it may be damaged. Check that there is no problem with the storage media.

90

SCALE PARAMETER NOT VALID

You attempt to set a display scale not available for the selected display format and, as a result, the command is ignored. For example, when the log scale (command: FMT LOGY) is selected as the display format, you attempt to perform the SCALE/DIV setting (command: SCAL <value>).

102

SEARCH RANGE TYPE IS NOT SEGMENT

Although in the list sweep all segments (entire sweep range) are specified as the search range (command: SEARNG FULL), you attempt to execute a command to specify a certain segment as a search target (SEGMNUM <value>) and, as a result, the command is ignored. Before executing the search function by specifying a certain list sweep segment, set the search range to a single segment (command: SEARNG SEGMENT).

101

SEARCH WIDTH OFF

When the band width function is off, you attempt to execute a command to search the cutoff point on the trace (WIDSIN or WIDSOUT) and, as a result, the command is ignored. Before executing the cutoff point search of the band width function, turn on the band width function (command: WIDT ON).

-330

Self-test failed

The result of the self-test is failure. Contact your local Agilent Technologies sales office or service center, or refer to the service manual.

-221

Setting conflict

A program data element complying with the syntax standard is analyzed but the 4294A cannot execute it at present.

-150

String data error

An error not described by error numbers from -151 to -159 occurs during the syntax analysis of a string data element.

-158

String data not allowed

A string data element is received where the 4294A does not accept any string data element.

-130

Suffix error

Error messages
Suffix not allowed

- A suffix error. An error other than -131 to -139 occurs in the notation of a suffix.
- 138 **Suffix not allowed**
- A suffix is added to a numeric value element to which no suffix should be added.
- 134 **Suffix too long**
- The suffix is too long. The suffix contains the notation of 12 characters or more. (Refer to IEEE488.2,7.7.3.4.)
- 102 **Syntax error**
- There is a command or data type that cannot be recognized. For example, although the 4294A does not accept any strings, a string is received.
- 310 **System error**
- One of the “system errors” defined for the 4294A occurred.

T

- 87 **THETA MEASUREMENT NOT SELECTED**
- When the setting of the phase (q) is not active as a measurement parameter, you attempt to execute a command to set the phase unit (PHAU DEG or PHAU RAD) or a command to set the phase expansion display (EXPP ON or EXPP OFF) and, as a result, the command is ignored. The active status of the phase (θ) setting means:
- $|Z|-\theta$ or $|Y|-\theta$ is selected as a measurement parameter, and trace B is active.
 - COMPLEX Z-Y is selected as a measurement parameter, and the display format is POLAR (polar coordinates display format) for the selected active trace.
- Before executing a command to set the phase unit or a command to set the phase expansion display, perform one of the above settings.
- 124 **Too many digits**
- The number of digits of the mantissa of the decimal value data element exceeds 255 except when there are preceding 0s. (Refer to IEEE 488.27.7.2.4.1.)
- 64 **TOO MANY SEGMENTS**
- You attempt to add segments to the limit line table at a quantity that exceeds the maximum number (18). The number of segments you can set in the limit line table is up to 18.
- 77 **TOO MANY SEGMENTS OR POINTS**
- During the editing of the list sweep table, you attempt to set a value that exceed the maximum number of segments (18), the maximum number of points per segment (201), or the maximum number of total points in all segments (801). Set the number of segments or the number of points to a value that does not exceed the maximum value.
- 54 **TOO MUCH DATA**
- When data is sent from the controller to the Agilent 4294A in the FORM2, FORM3, or FORM5 data transfer format, the amount of the sent binary data is too large, or data items exceed the number of points (NOP) set. Be sure to correctly set the data to be sent or the number of points of the Agilent 4294A.
- 223 **Too much data**

The received block, equation, or string type program data comply with the standard, but the amount of data exceeds the limit that the 4294A can deal with, due to memory or device-specific conditions related to memory.

-210

Trigger error

A trigger error. An error other than -211 to -219 has occurred.

-211

Trigger ignored

A trigger command or trigger signal is received and recognized by the 4294A, but it was ignored due to the timing relationship with the 4294A (for example, when the 4294A was not ready to respond).

U

-113

Undefined header

A header not defined for the Agilent 4294A is received. For example, the header “*XYZ”, which is not defined for the 4294A is received.

19

UNEXPECTED DATA DETECTED

During the measurement of calibration data (OPEN, SHORT, LOAD) for user calibration, fixture compensation, and four-terminal pair extension setting, abnormal data are detected, and the acquisition of the calibration data is aborted. Check that there is no problem in standards or setup you use.

W

142

WRONG I/O PORT DIRECTION

For a 24-bit input/output (I/O) shared port (port C and port D), you attempt to execute input/output (I/O) of data in the direction opposite from the preset input/output direction. The command is thus invalid. For example, if you use the CIN command to specify port C as an input port and then use the OUTCIO <value> command to output data from port C, this error is displayed.

Error messages
WRONG I/O PORT DIRECTION

D **Initial Settings**

This appendix provides initial settings, settings that can be saved/recalled, and settings that can be backed up.

Initial Settings, Settings that can be Saved/Recalled, Settings that can be Backed Up

The columns of Table D-1 show the following items.

- Initial settings (factory settings)
- Settings reset from the front panel or the GPIB by the **PRES** command
- Settings reset from the GPIB by the ***RST** command
- Settings that can be saved/recalled

Table D-1 uses the following symbols.

√: Settings that can be saved/recalled

blank: Settings that cannot be saved/recalled

- Settings that can be backed up

Table D-1 uses the following symbols.

√: Settings that can be backed up

blank: Settings that cannot be backed up

The symbol “←” in Table D-1 indicates that the value is the same as that indicated to the left.

Table D-1 Initial settings, settings that can be saved/recalled, settings that can be backed up

Function	Setting	Initial settings (factory settings)	[Preset]	*RST	Save/Recall	Backup		
Measurement condition	Active trace	A	←	←	√			
	Measurement parameter	A: Z B: θ	←	←	√			
	Number of points	201	←	←	√			
	Sweep	Parameter	Frequency	←	←	√		
		Type	Linear	←	←	√		
		Direction	UP	←	←	√		
		Delay time	Sweep	0	←	←	√	
			Measurement point	0	←	←	√	
		Range	Start value	40 Hz	←	←	√	
			Stop value	110 MHz	←	←	√	
			Center value	55.00002 MHz	←	←	√	
			Span	109.99996 MHz	←	←	√	
		Manual sweep	On/Off	Off	←	←	√	
	Point setting		1	←	←	√		
	OSC	Level	setting mode	Voltage	←	←	√	
			setting	500 mV	←	←	√	
		Frequency	1 MHz	←	←	√		
	DC bias	On/Off	Off	←	←	√		
		Range	1 mA	←	←	√		
		Mode	Voltage	←	←	√		
		Level	Current	0 A	←	←	√	
			Voltage	0 V	←	←	√	
	Minimum voltage		-40 V	←	←	√		
	Bandwidth		1	←	←	√		
	Averaging	Sweep	On/Off	Off	←	←	√	
			Factor	16	←	←	√	
		Measurement point	On/Off	Off	←	←	√	
Factor			4	←	←	√		
List sweep table		Empty	←	←	√			
Span display type (Single/Segment)		Single	←	←	√			

Initial Settings

Initial Settings, Settings that can be Saved/Recalled, Settings that can be Backed Up

Table D-1 Initial settings, settings that can be saved/recalled, settings that can be backed up

Function	Setting		Initial settings (factory settings)	[Preset]	*RST	Save/Recall	Backup	
Display	On/Off (GPIB Command only)		On	←	←	√		
	Backlight On/Off (GPIB Command only)		On	←	←	√		
	Trace A/B split display		Off	←	←	√		
	Trace definition		Data	←	←	√		
	Accumulate display		Off	←	←	√		
	Non-active trace display hiding		Off	←	←	√		
	Allocation (Instrument/IBASIC)		All instrument	No effect	←			
	Level monitor display	OSC		Off	←	←	√	
		DC bias		Off	←	←	√	
	Title		blank	←	←	√		
	Offset value		0	←	←	√		
	Format		Linear	←	←	√		
	Phase unit		degree (°)	←	←	√		
	Expanded phase display		Off	←	←	√		
	Scale	Scale/div		A: 100 kΩ/div B: 36 °/div	←	←	√	
		Reference line	Position	5 div	←	←	√	
			value	A: 500 kΩ B: 0 °	←	←	√	
Top value		A: 1 MΩ B: 180 °	←	←	√			
Bottom value		A: 0 Ω B: -180 °	←	←	√			
Scaled trace selection (Data/Memory)		Data	←	←	√			
Coupled scale setting between Data and Memory traces		On	←	←	√			
Adapter setting	Adapter selection		None	No effect	←	√	√	
	Setup data		Empty	No effect	←		√	
User calibration	On/Off		Off	←	←	√		
	Standard definition for data measurement	Open	G	0 S	←	←	√	
			C	0 F	←	←	√	
		Short	R	0 Ω	←	←	√	
			L	0 H	←	←	√	
		Load	R	50 Ω	←	←	√	
	L		0 H	←	←	√		
Data measurement point setting for user calibration and fixture compensation		Fixed	←	←	√			
User calibration coefficient		Empty	←	←	√			
Port extension compensation	On/Off		Off	←	←	√		
	Port extension value		0	←	←	√		

Table D-1 Initial settings, settings that can be saved/recalled, settings that can be backed up

Function	Setting		Initial settings (factory settings)	[Preset]	*RST	Save/Recall	Backup	
Fixture compensation	On/Off	Open	Off	←	←	√		
		Short	Off	←	←	√		
		Load	Off	←	←	√		
	Standard definition for data measurement	Open	G	0 S	←	←	√	
			C	0 F	←	←	√	
		Short	R	0 Ω	←	←	√	
			L	0 H	←	←	√	
		Load	R	50 Ω	←	←	√	
			L	0 H	←	←	√	
	Data measurement point setting for user calibration and fixture compensation			Fixed	←	←	√	
Fixture compensation coefficient			Empty	←	←	√		
Trigger	Sweep mode		Continuous	←	Hold	√		
	Trigger source selection		Internal (Free run)	←	←	√		
	Polarity of external trigger signal		Positive	←	←	√		
	Trigger event mode		On sweep	←	←	√		
Marker	Marker (main marker)		Off	←	←	√		
	Sub marker		Off	←	←	√		
	Objective trace selection (Data/Memory)		Data	←	←	√		
	Trace A/B coupled mode On/Off		On	←	←	√		
	Marker movement mode (Continuous/Discrete)		Continuous	←	←	√		
	Δ marker mode		Off	←	←	√		
	Sweep parameter value		Stimulus value	←	←	√		
	Level monitor value display mode		Off	←	←	√		
	Marker list display		Off	←	←	√		
Marker search	Search function		Off	←	←	√		
	Target search	Target value	Off	←	←	√		
		Target line display	Off	←	←	√		
	Peak definition	ΔX value		500 kHz	←	←	√	
		ΔY value		1	←	←	√	
		Polarity (Positive/Negative)		Positive	←	←	√	
	Search tracking function On/Off		Off	←	←	√		
	Partial search	On/Off		Off	←	←	√	
		Search range	Lower limit value	40 Hz	←	←	√	
			Upper limit value	110 MHz	←	←	√	
Search range for List sweep	Full (All segments)/Specified segment		Full	←	←	√		
	Search segment		1	←	←	√		
	Search range line display		Off	←	←	√		

Initial Settings

Initial Settings, Settings that can be Saved/Recalled, Settings that can be Backed Up

Table D-1 Initial settings, settings that can be saved/recalled, settings that can be backed up

Function	Setting		Initial settings (factory settings)	[Preset]	*RST	Save/Recall	Backup
Analysis	Equivalent circuit analysis	Equivalent circuit model	Selection	A	←	←	√
			Display	Off	←	←	√
		Equivalent circuit parameter	Display	Off	←	←	√
			Value	0	←	←	√
	Statistical analysis		Off	←	←	√	
	Trace bandwidth analysis	On/Off		Off	←	←	√
		Cutoff point definition	Definition type	Fixed	←	←	√
			Fixed value	0	←	←	√
	Waveform analysis (GPIB command only)	Analysis range		Full sweep range	←	←	√
		Analyzed segment when sweep type is list		0	←	←	√
		Analyzed trace (Data/Memory)		Data	←	←	√
Peak definition		0	←	←	√		
Limit test	On/Off		Off	←	←	√	
	Beep On/Off		Off	←	←	√	
	Limit line table		Empty	←	←	√	
	Limit range offset	Limit value (X-axis) offset	0	←	←	√	
Sweep parameter value (Y-axis) offset		0	←	←	√		
Save, recall and so on	Contents selection for saving data arrays	Data array	Off	←	←		
		Memory array	Off	←	←		
		Data trace array	On	←	←		
		Memory trace array	On	←	←		
		User calibration data and fixture compensation data array	Off	←	←		
	Storage device selection		Floppy Disk Drive	No effect	←		√
Status report structure (GPIB command only)	Service request enable register value		0	No effect	←		
	Standard event status enable register value		0	No effect	←		
	Instrument event status enable register value		0	No effect	←		
	Operation status enable register value		0	No effect	←		
	Positive transition filter value of operation status register		0	No effect	←		
	Negative transition filter value of operation status register		0	No effect	←		
LAN/GPIB	4294A IP address		0.0.0.0	No effect	←		√
	Gateway IP address		0.0.0.0	No effect	←		√
	Subnet mask		0.0.0.0	No effect	←		√
	4294A GPIB address		17	No effect	←		√
	Controller GPIB address		21	No effect	←		√

Table D-1 Initial settings, settings that can be saved/recalled, settings that can be backed up

Function	Setting	Initial settings (factory settings)	[Preset]	*RST	Save/Recall	Backup
Printer	Color	Black and White	No effect	←		√
	Resolution	75 DPI	No effect	←		√
	Top margin	1 inch	No effect	←		√
	Left margin	1 inch	No effect	←		√
	Landscape printing	Off	No effect	←		√
	Formfeed	On	No effect	←		√
	Softkey label printing	Off	No effect	←		√
	Time stamp	Off	No effect	←		√
	Table format when list sweep table is printed	Start value / Stop value	No effect	←		√
	Table format when limit line table is printed	Upper limit value / Lower limit value	No effect	←		√
Beep	On/Off setting of the beep to notify the completion of operation	On	No effect	←		√
	On/Off setting of the beep when the limit test result is FAIL	Off	←	←	√	
	On/Off setting of the beep when an error occurred or when an invalid key is pressed	Off	No effect	←		√
Others	Date display format of internal clock	MM/DD/YY	No effect	←		√
	Front panel key and rotary knob lock (GPIB command only)	Off	No effect	←		
	IBASIC mass storage device selection	Floppy Disk Drive	No effect	←		√
	Data transfer format (GPIB command only)	ASCII	←	←	√	

Initial Settings

Initial Settings, Settings that can be Saved/Recalled, Settings that can be Backed Up

Symbols

-, 56
 *, 56, 57
 ?, 56

Numerics

[0]-[9][.][-] keys, 46
 16034E, 64
 16034G, 64
 16034H, 64
 16044A, 64
 16047A, 64
 16047C, 64
 16047D, 64
 16047E, 64
 16048A, 64
 16048B, 64
 16048D, 64
 16048E, 64
 16048G, 64
 16048H, 64
 16065A, 64
 16085B, 64
 16089A, 64
 16089B, 64
 16089C, 64
 16089D, 64
 16089E, 64
 16092A, 64
 16093A, 64
 16093B, 64
 16191A, 64
 16192A, 64
 16193A, 64
 16314A, 64
 16334A, 64
 16451B, 64
 16452A, 64
 16454A, 64
 1st key
 setting/checking the IP address, 314, 315, 317
 24-bit I/O port, 52, 346
 2nd key
 setting/checking the IP address, 314, 316, 317
 3rd key
 setting/checking the IP address, 314, 316, 317
 42941A, 64
 42942A, 64
 4th key
 setting/checking the IP address, 315, 316, 317
 7mm, 58
 8-bit I/O port, 51, 346

A

[A] key, 45
 active trace, 83

ACTIVE TRACE block, 45
 adapter
 selection, 68
 setting, 67
 setup, 69, 330
 ADDRESS: HP-IB key, 313
 addressable only mode, 313
 ADDRESSABLE ONLY MODE key, 313
 auto scaling, 164
 averaging, 329
 point, 127
 algorithm, 128
 sweep-to-sweep, 126
 algorithm, 126

B

[B] key, 45
 [Back Space] key, 46
 BEEP DONE on OFF (ON off) key, 304
 BEEP WARN on OFF (ON off) key, 304
 BEEPER key, 304
 Buck-up, 448
 [Bw/Avg] key, 45

C

CAL, 58
 Cal, 58
 [Cal] key, 45
 calibration, 129, 330
 42941A and probe adapter, 143
 42941A, cable, and test fixture, 145
 42942A and test fixture, 139
 42942A, cable, and test fixture, 141
 direct connection type test fixture, 133
 fixture compensation, 151
 four-terminal pair, 1 m, 135
 four-terminal pair, 2 m, 137
 port extension compenstion, 150
 user, 147
 calibration data
 data contents saved with the data save function, 278
 calibration/compensationdata point, 155
 CAP, 58
 CaP, 58
 [Center] key, 46
 cleaning, 28
 clock
 Setting/Checking the Internal Clock, 301
 CLOCK key, 301, 302
 color LCD display, 48
 color settings, 207
 completion beep, 304
 contents, 18
 COPY FILE key, 307
 CREATE DIRECTORY key, 305
 current level monitor, 326
 current signal level, 325

CW frequency, 104

D

Δ marker mode, 56
data array
 data contents saved with the data save function, 280
data block, 277
data part, 277
 data contents saved with the data save function, 278
data save
 structure of files saved in the text format, 275, 286
 touchstone file, 285
data trace array
 data contents saved with the data save function, 281
DATE key, 301
DATE MODE [] key, 301
DAY key, 301
dc bias
 range, 108, 109
 setting, 107
dc bias function, 326
DCB, 57
deleting
 directory, 310
 file, 310
DEST DEV [] key, 309
DIAGNOSTIC TEST key, 320
dimensions, 351
directory
 creating, 305
 deleting, 310
display
 function, 344
display allocation, 202
[Display] key, 45
display test, 320
 Δ Mkr, 56
down arrow, 46

E

EMC, 351
ENTRY block, 46
[Entry Off] key, 46
environmental requirements, 28
equivalent circuit parameter analysis, 249
equivalent circuit analysis, 345
EX1, 58
EX2, 58
external monitor terminal, 52
external monitor output, 350
external program RUN/CONT input, 350
external program run/cont input, 51
external reference input, 349
external reference input connector, 50
external test, 320
external trigger input, 51, 349

F

Factory settings, 448
file
 copy, 307
 deleting, 310
 how to manage, 305
FIRMWARE REVISION key, 319
firmware version
 how to check, 319
fixture compensation, 151
 defining standard value, 153
fixture compensation data
 data contents saved with the data save function, 278
flexible disk drive, 49
FORMAT key, 311
[Format] key, 45
formatting
 recording medium, 311
frequency, 324
front panel, 44
furnished accessories, 354
fuse, 20
Fxd Δ , 56

G

[G/n] key, 46
gateway address
 setting/checking procedure, 315
GATEWAY ADDRESS key, 315
GP-IB
 connector, 52
GRAPHICS key, 289

H

hardkey, 44
hiding non-active trace, 199
high stability frequency reference, 50
high stability frequency reference output, 349
HOUR key, 302
HP 42941A
 temperature coefficient, 338
HP Instrument BASIC, 346
HP-IB, 346
 address
 setting/checking procedure, 313
 addressable only mode, 313
 setting/checking procedure, 313
 system controller mode, 313

I

I downarrow, 57
IC, 57
incoming inspection, 18
Initial settings, 448
initialization
 medium, 311

- recording medium, 311
 - inlet with a fuse box, 52
 - installation, 17
 - keyboard, 25
 - rackmount kit, 26
 - instrument message
 - displaying again, 300
 - instrument setup part, 277
 - data contents saved with the data save function, 278
 - INSTRUMENT STATE block, 47
 - internal clock
 - setting/checking, 301
 - internal reference output, 51, 349
 - internal test, 320
 - INTERNAL TEST key, 320
 - IP address
 - setting/checking procedure, 314
 - IP ADDRESS key, 314
- K**
- [k/m] key, 46
 - key definitions, 359
 - keyboard
 - installation, 25
- L**
- LAN
 - gateway address
 - setting/checking procedure, 315
 - installation, 24
 - IP address
 - setting/checking procedure, 314
 - MAC address
 - check procedure, 318
 - port, 51
 - setting/checking procedure, 314
 - subnet mask
 - setting/checking procedure, 317
 - LAN interface, 348
 - limit line test, 256, 345
 - linear sweep, 87
 - list sweep, 87, 116
 - [Local] key, 48
 - log sweep, 87
- M**
- [M/micro] key, 46
 - MAC address
 - check procedure, 318
 - MAC ADDRESS key, 318
 - manual changes, 355
 - manual sweep, 100
 - marker, 212
 - function, 344
 - MARKER block, 47
 - marker couple mode
 - status display, 55
 - [Marker] key, 47
 - [Marker to] key, 47
 - MASS STORE [] key, 309
 - mass storage, 345
 - Max, 55
 - [Meas] key, 45
 - measurement
 - accuracy, 330
 - bandwidth, 126, 329
 - parameter, 324
 - terminal, 324
 - time, 329
 - measurement accessory
 - preparation, 63
 - MEASUREMENT block, 45
 - measurement parameter
 - data contents saved in the trace data, 283
 - measurement parameters, 158
 - medium
 - formatting, 311
 - initialization, 311
 - memory array
 - data contents saved with the data save function, 280
 - memory trace array
 - data contents saved with the data save function, 281
 - message
 - instrument message
 - how to display again, 300
 - MESSAGE EMPTY, 300
 - Min, 55
 - mini-DIN keyboard, 25
 - port, 51
 - MINUTE key, 302
 - monitoring
 - dc bias level, 193
 - test signal level, 189
 - MONTH key, 301
- N**
- non-operating conditions, 351
 - NOP, 97
 - number of points, 97
 - numeric keys, 46
- O**
- operating conditions, 350
 - option
 - 1CM rackmount kit, 27
 - 1CN handle kit, 26
 - 1CP rackmount & handle kit, 27
 - 1D5, 23
 - 1D5 high stability frequency reference, 50
 - oscillator level
 - setting, 105
 - unit, 106
 - output impedance, 326

P

Peak, 55
peak
 definition, 232
phase unit, 197
point averaging, 127
 algorithm, 128
POR, 58
Por, 58
port extension compensation, 150
power
 cable, 21
 options, 22
 source
 requirements, 20
 switch, 48
power requirement, 351
PRB, 58
[Preset] key, 48
Preset value, 448
presetting, 82
printer
 parallel port, 345
 port, 52
printing, 294
PURGE FILE key, 310

Q

quick start, 29

R

rackmount kit, 26
rear panel, 50
Recall
 Settings that can be recalled, 448
recall, 270
[Recall] key, 48
RECALL MESSAGE key, 300
recording medium
 formatting, 311
 initialization, 311
Reset
 4294A
 Initial settings, 448
Resume function
 Settings that can be backed up, 448
rotary knob, 46
RUN TEST key, 320

S

safety, 351
Save
 Settings that can be saved, 448
save, 270
save graphics, 288
[Save] key, 48

[Scale Ref] key, 45
search
 max, 223
 target value, 225
[Search] key, 47
search min, 223
search range, 267
SECOND key, 302
self-diagnosis, 320
selftest, 320
setting the beep sound, 304
setting the built-in speaker, 304
Setting/Using Control and Management Functions, 299
softkey, 48
[Source] key, 46
[Span] key, 46
speaker
 setting the built-in speaker, 304
specifications and supplemental performance characteristics,
 323
splitting graph, 200
[Start] key, 46
status block, 277
 data contents saved with the data save function, 278
STIMULUS block, 46
[Stop] key, 46
STORE DEV [] key, 309
subnet mask
 setting/checking procedure, 317
SUBNET MASK key, 317
sweep
 characteristics, 328
 direction, 99
 list, 116
 manual, 100
 mode, 114
 parameter, 84
 range, 89
 time, 102
 type, 87
[Sweep] key, 46
sweep-to-sweep averaging, 126
 algorithm, 126
SYSTEM CONTROLLER key, 313
system controller mode, 313
[System] key, 48

T

Targ, 55
TIFF format, 288
time delay, 102
TIME key, 302
title, 205
touchstone format
 data save, 285
 using file, 286
TOUCHSTONE key, 285

trace bandwidth, 236
trace data
 data contents saved with the data save function, 279
trace math, 179
trigger
 event, 112
 function, 329
 source, 111
[Trigger] key, 46
TrkΔ, 56

U

unit keys, 46
UNKNOWN terminals, 49
up arrow, 46
user calibration, 147
 defining standard value, 148
user calibration data
 data contents saved with the data save function, 278
[Utility] key, 47

V

V downarrow, 57
VC, 57
ventilation requirements, 28
voltage signal level, 324

W

warning beep, 304
weight, 351

X

[x1] key, 46

Y

YEAR key, 301

Z

zero span, 94

REGIONAL SALES AND SUPPORT OFFICES

For more information about Agilent Technologies test and measurement products, applications, services, and for a current sales office listing, visit our web site: <http://www.agilent.com/find/tmdir>. You can also contact one of the following centers and ask for a test and measurement sales representative. 11/29/99

United States:

Agilent Technologies
Test and Measurement Call Center
P.O.Box 4026
Englewood, CO 80155-4026
(tel) 1 800 452 4844

(fax) (61 3) 9272 0749
(tel) 0 800 738 378 (New Zealand)
(fax) (64 4) 802 6881

Canada:

Agilent Technologies Canada Inc.
5150 Spectrum Way
Mississauga, Ontario
L4W 5G1
(tel) 1 877 894 4414

Asia Pacific:

Agilent Technologies
24/F, Cityplaza One, 1111 King's Road,
Taikoo Shing, Hong Kong
(tel) (852)-3197-7777
(fax) (852)-2506-9284

Europe:

Agilent Technologies
Test & Measurement
European Marketing Organization
P.O.Box 999
1180 AZ Amstelveen
The Netherlands
(tel) (31 20) 547 9999

Japan:

Agilent Technologies Japan Ltd.
Call Center
9-1, Takakura-Cho, Hachioji-Shi,
Tokyo 192-8510, Japan
(tel) (81) 426 56 7832
(fax) (81) 426 56 7840

Latin America:

Agilent Technologies
Latin American Region Headquarters
5200 Blue Lagoon Drive, Suite #950
Miami, Florida 33126
U.S.A.
(tel) (305) 267 4245
(fax) (305) 267 4286

Australia/New Zealand:

Agilent Technologies Australia Pty Ltd
347 Burwood Highway
Forest Hill, Victoria 3131
(tel) 1-800 629 485 (Australia)