

Agilent 4284A Precision LCR Meter

Data Sheet

Specifications

The complete Agilent Technologies 4284A specifications are listed in this data sheet. These specifications are the performance standards or limits against which the instrument is tested. When shipped from the factory, the Agilent 4284A meets the specifications listed here.

Measurement Functions

Measurement parameters

- |Z| = Absolute value of impedance
- |Y| = Absolute value of admittance
- L = Inductance
- C = Capacitance
- R = Resistance
- G = Conductance
- D = Dissipation factor
- Q = Quality factor
- R_s = Equivalent series resistance
- R_p = Parallel resistance
- X = Reactance
- B = Susceptance
- θ = Phase angle

Combinations of measurement parameters

Z , Y	L, C	R	G
θ (deg), θ (rad)	D, Q, R _s , R _p , G	X	B

Mathematical functions

The deviation and the percent of deviation of measurement values from a programmable reference value.

Equivalent measurement circuit

Parallel and series

Ranging

Auto and manual (hold/up/down)

Trigger

Internal, external, BUS (GPIB), and manual

Delay time

Programmable delay from the trigger command to the start of the measurement, 0 to 60.000 s in 1 ms steps.

Measurement terminals

Four-terminal pair

Test cable length

Standard 0 m and 1 m selectable

With Option 4284A-006 0 m, 1 m, 2 m, and 4 m selectable

Integration time

Short, medium, and long (see *Supplemental Performance Characteristics* for the measurement time)

Averaging

1 to 256, programmable



Agilent Technologies

Test Signal

Frequency

20 Hz to 1 MHz, 8610 selectable frequencies

Accuracy

±0.01%

Signal modes

Normal (non-constant) – Program selected voltage or current at the measurement terminals when they are opened or shorted, respectively.

Constant – Maintains selected voltage or current at the device under test (DUT) independent of changes in the device's impedance.

Signal level

	Mode	Range	Setting accuracy
Voltage	Non-constant	5 mV _{rms} to 2 V _{rms}	±(10% + 1 mV _{rms})
	Constant ¹	10 mV _{rms} to 1 V _{rms}	±(6% + 1 mV _{rms})
Current	Non-constant	50 μA _{rms} to 20 mA _{rms}	±(10% + 10 μA _{rms})
	Constant ¹	100 μA _{rms} to 10 mA _{rms}	±(6% + 10 μA _{rms})

1. Automatic Level Control Function is set to ON.

Output impedance

100 Ω, ±3%

Test signal level monitor

Mode	Range	Accuracy
Voltage ¹	5 mV _{rms} to 2 V _{rms}	±(3% of reading + 0.5 mV _{rms})
	0.01 mV _{rms} to 5 mV _{rms}	±(11% of reading + 0.1 mV _{rms})
Current ²	50 μA _{rms} to 20 mA _{rms}	±(3% of reading + 5 μA _{rms})
	0.001 μA _{rms} to 50 μA _{rms}	±(11% of reading) + 1 μA _{rms})

1. Add the impedance measurement accuracy [%] to the voltage level monitor accuracy when the DUT's impedance is < 100 Ω.
2. Add the impedance measurement accuracy [%] to the current level monitor accuracy when the DUT's impedance is ≥ 100 Ω.

Accuracies apply when test cable length is 0 m or 1 m. The additional error when test cable length is 2 m or 4 m is given as

$$fm \times \frac{L}{2} \text{ [%]}$$

where:

fm = Test frequency [MHz]

L = Test cable length [m]

For example,

DUT's impedance:	50 Ω
Test signal level:	0.1 V _{rms}
Measurement accuracy:	0.1%
Cable length:	0 m

Then, voltage level monitor accuracy is

±(3.1% of reading + 0.5 mV_{rms})

Display Range

Parameter	Range
Z , R, X	0.01 mΩ to 99.9999 MΩ
Y , G, B	0.01 nS to 99.9999 S
C	0.01 fF to 9.99999 F
L	0.01 nH to 99.9999 kH
D	0.000001 to 9.99999
Q	0.01 to 99999.9
θ	-180.000° to 180.000°
Δ	-999.999% to 999.999%

Absolute Accuracy

Absolute accuracy is given as the sum of the relative accuracy plus the calibration accuracy.

|Z|, |Y|, L, C, R, X, G, and B accuracy

|Z|, |Y|, L, C, R, X, G, and B accuracy is given as

$$A_e + A_{cal} [\%]$$

where:

A_e = Relative accuracy

A_{cal} = Calibration accuracy

L, C, X, and B accuracies apply when D_x (measured D value) ≤ 0.1 . R and G accuracies apply when Q_x (measured Q value) ≤ 0.1 . G accuracy described in this paragraph applies to the G-B combination only.

D accuracy

D accuracy is given as

$$D_e + \theta_{cal}$$

where:

D_e is the relative D accuracy

θ_{cal} is the calibration accuracy [radian]

Accuracy applies when D_x (measured D value) ≤ 0.1 .

Q accuracy

Q accuracy Q_e is given as

$$Q_e = \pm \frac{Q_x \times D_a}{1 + Q_x \times D_a}$$

where:

Q_x = Measured Q value

D_a = D accuracy

Q accuracy applies when $Q_x \times D_a < 1$.

θ accuracy

θ accuracy is given as

$$\theta_e + \theta_{cal} [deg]$$

where:

θ_e = Relative θ accuracy [deg]

θ_{cal} = Calibration accuracy [deg]

G accuracy

When D_x (measured D value) ≤ 0.1

G accuracy is given as

$$B_x \times D_a [S]$$

$$B_x = 2 \pi f C_x = \frac{1}{2 \pi f L_x}$$

where:

B_x = Measured B value [S]

C_x = Measured C value [F]

L_x = Measured L value [H]

D_a = Absolute D accuracy

f = Test frequency [Hz]

G accuracy described in this paragraph applies to the C_p -G and L_p -G combinations only.

R_p accuracy

When D_x (measured D value) ≤ 0.1

R_p accuracy is given as

$$R_p = \pm \frac{R_{px} \times D_a}{D_x + D_a} [\Omega]$$

where:

R_{px} = Measured R_p value [Ω]

D_x = Measured D value

D_a = Absolute D accuracy

R_s accuracy

When D_x (measured D value) ≤ 0.1

R_s accuracy is given as

$$X_x \times D_a \quad [\Omega]$$

$$X_x = 2 \pi f L_x = \frac{1}{2 \pi f C_x}$$

where:

- X_x = Measured X value [Ω]
- C_x = Measured C value [F]
- L_x = Measured L value [H]
- D_a = Absolute D accuracy
- f = Test frequency [Hz]

Relative Accuracy

Relative accuracy includes stability, temperature coefficient, linearity, repeatability, and calibration interpolation error. Relative accuracy is specified when all of the following conditions are satisfied:

1. Warm-up time: ≥ 30 minutes
 2. Test cable length: 0 m, 1 m, 2 m, or 4 m (Agilent 16048 A/B/D/E)
- For 2 m or 4 m cable length operation, test signal voltage and test frequency are set according to Figure 1-1. (2 m and 4 m cable can only be used when Option 4284A-006 is installed.)

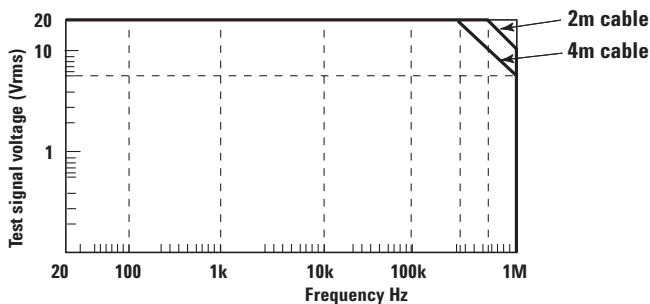

Figure 1-1. Test signal voltage and test frequency upper limits to apply relative accuracy to 2 m and 4 m cable length operation

3. OPEN and SHORT corrections have been performed.

4. Bias current isolation: Off

(For accuracy with bias current isolation, refer to supplemental performance characteristics.)

5. Test signal voltage and DC bias voltage are set according to Figure 1-2.

6. The optimum measurement range is selected by matching the DUT's impedance to the effective measuring range. (For example, if the DUT's impedance is 50 k Ω , the optimum range is the 30 k Ω range.)

Range 1: Relative accuracy can apply.

Range 2: The limits applied for relative accuracy differ according to the DUT's DC resistance. Three dotted lines show the upper limits when the DC resistance is 10 Ω , 100 Ω and 1 k Ω .

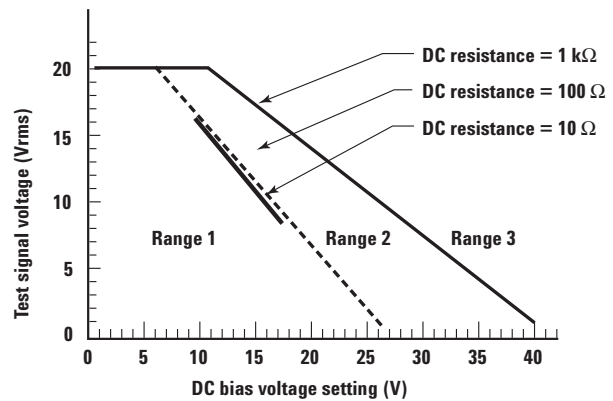

Figure 1-2. Test signal voltage and DC bias voltage upper limits apply for relative accuracy

|Z|, |Y|, L, C, R, X, G, and B accuracy

|Z|, |Y|, L, C, R, X, G, and B accuracy A_e is given as

$$A_e = \pm [A + (K_a + K_{aa} + K_b \times K_{bb} + K_c) \times 100 + K_d] \times K_e \text{ [%]}$$

A = Basic accuracy (refer to Figure 1-3 and 1-4)

K_a = Impedance proportional factor (refer to Table 1-1)

K_{aa} = Cable length factor (refer to Table 1-2)

K_b = Impedance proportional factor (refer to Table 1-1)

K_{bb} = Cable length factor (refer to Table 1-3)

K_c = Calibration interpolation factor (refer to Table 1-4)

K_d = Cable length factor (refer to Table 1-6)

K_e = Temperature factor (refer to Figure 1-5)

L, C, X, and B accuracies apply when D_x (measured D value) ≤ 0.1 .

R and G accuracies apply when Q_x (measured Q value) ≤ 0.1 .

When $D_x \geq 0.1$, multiply A_e by $\sqrt{1 + D_x^2}$ for L, C, X, and B accuracies

When $Q_x \geq 0.1$, multiply A_e by $\sqrt{1 + Q_x^2}$ for R and G accuracies.

G accuracy described in this paragraph applies to the G-B combination only.

D accuracy

D accuracy D_e is given as

$$D_e = \pm \frac{A_e}{100}$$

Accuracy applies when D_x (measured D value) ≤ 0.1 .

When $D_x > 0.1$, multiply D_e by $(1 + D_x)$.

Q accuracy

Q accuracy is given as

$$\pm \frac{Q_x^2 \times D_e}{1 \mp Q_x \times D_e}$$

where:

Q_x = Measured Q value

D_e = Relative D accuracy

Accuracy applies when $Q_x \times D_e < 1$.

 θ accuracy

θ accuracy is given as

$$\frac{180 \times A_e}{\pi \times 100} \text{ [deg]}$$

G accuracy

When D_x (measured D value) ≤ 0.1

G accuracy is given as

$$B_x \times D_e \text{ [S]}$$

$$B_x = 2 \pi f C_x = \frac{1}{2 \pi f L_x}$$

where:

B_x = Measured B value [S]

C_x = Measured C value [F]

L_x = Measured L value [H]

D_e = Relative D accuracy

f = Test frequency [Hz]

G accuracy described in this paragraph applies to the C_p-G and L_p-G combinations only.

R_p accuracy

When D_x (measured D value) ≤ 0.1

R_p accuracy is given as

$$\pm \frac{R_{px} \times D_e}{D_x \mp D_e} [\Omega]$$

where:

R_{px} = Measured R_p value [Ω]

D_x = Measured D value

D_e = Relative D accuracy

R_s accuracy

When D_x (measured D value) ≤ 0.1

R_s accuracy is given as

$$X_x \times D_a [\Omega]$$

$$X_x = 2 \pi f L_x = \frac{1}{2 \pi f C_x}$$

where:

X_x = Measured X value [Ω]

C_x = Measured C value [F]

L_x = Measured L value [H]

D_e = Relative D accuracy

f = Test frequency [Hz]

Example of C-D Accuracy Calculation

Measurement conditions

Frequency: 1 kHz

C measured: 100 nF

Test signal voltage: 1 V_{rms}

Integration time: MEDIUM

Cable length: 0 m

Then:

A = 0.05

$$\begin{aligned} |Z_m| &= \frac{1}{2\pi \times 1 \times 10^3 \times 100 \times 10^{-9}} \\ &= 1590 [\Omega] \end{aligned}$$

$$\begin{aligned} K_a &= \frac{1 \times 10^{-3}}{1590} \left(1 + \frac{200}{1000} \right) \\ &= 7.5 \times 10^{-7} \end{aligned}$$

$$\begin{aligned} K_b &= 1590 \times 1 \times 10^{-9} \left(1 + \frac{70}{1000} \right) \\ &= 1.70 \times 10^{-6} \end{aligned}$$

$K_c = 0$

Therefore,

$$\begin{aligned} C_{\text{accuracy}} &= \pm [0.05 + (7.5 \times 10^{-7} + 1.70 \times 10^{-6}) \times 100] \\ &\approx \pm 0.05 [\%] \end{aligned}$$

$$D_{\text{accuracy}} = \pm \frac{0.05}{100}$$

$$= \pm 0.0005$$

Specification Charts and Tables

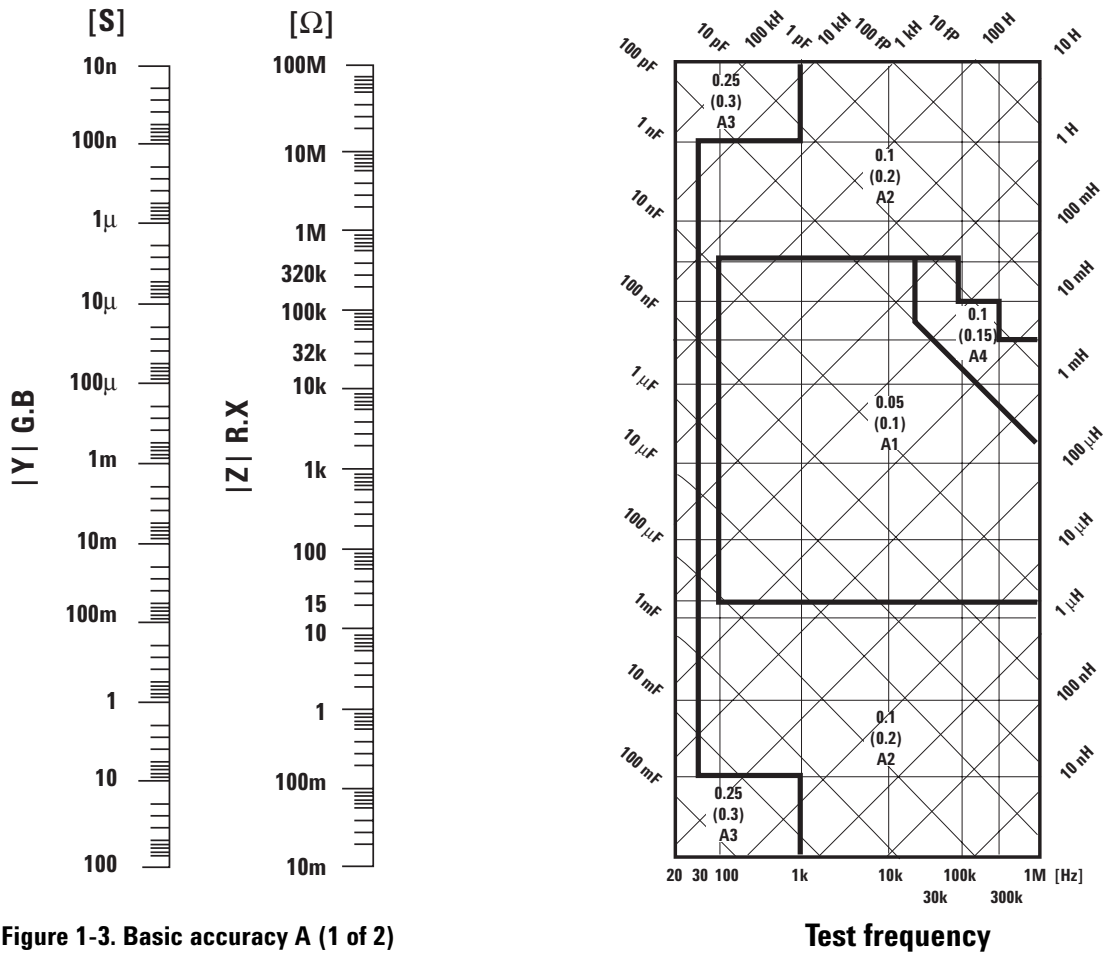

Figure 1-3. Basic accuracy A (1 of 2)

On boundary line apply the better value.

Example of how to find the A value:

0.05 = A value when $0.3 V_{\text{rms}} \leq V_s \leq 1 V_{\text{rms}}$ and integration time is MEDIUM and LONG.

(0.1) = A value when $0.3 V_{\text{rms}} \leq V_s \leq 1 V_{\text{rms}}$ and integration time is SHORT.

A_1 = A value when $V_s < 0.3 V_{\text{rms}}$ or $V_s > 1 V_{\text{rms}}$.
To find the value of A_1 , A_2 , A_3 , and A_4 refer to the following table.

where:

V_s = Test signal voltage

The following table lists the value of A_1 , A_2 , A_3 , and A_4 . When Atl is indicated find the Atl value using Figure 1-4.

		Test signal voltage									
		5m	12m	0.1	0.15	0.3	1	2	5	20 [Vrms]	
Medium/ long	$A_1 = Atl$	$A_1 = Atl$	$A_1 = Atl$	$A_1 = Atl$	$A_1 = Atl$	$A_1 = Atl$	$A_1 = Atl$	$A_1 = Atl$	$A_1 = Atl$	$A_1 = Atl$	
	$A_2 = Atl$ *	$A_2 = Atl$ *	$A_2 = Atl$ *	$A_2 = Atl$	$A_2 = 0.1$	$A_2 = 0.1$	$A_2 = Atl$	$A_2 = Atl$	$A_2 = Atl$	$A_2 = Atl$ **	
	$A_3 = Atl$	$A_3 = 0.25$	$A_3 = 0.25$	$A_3 = 0.25$	$A_3 = 0.25$	$A_3 = 0.25$	$A_3 = 0.25$	$A_3 = 0.25$	$A_3 = 0.25$	$A_3 = 0.25$	
	$A_4 = Atl$	$A_4 = Atl$	$A_4 = Atl$	$A_4 = Atl$	$A_4 = 0.1$	$A_4 = 0.1$	$A_4 = Atl$	$A_4 = Atl$	$A_4 = Atl$	$A_4 = Atl$	
Short	$A_1 = Atl$	$A_1 = Atl$		$A_1 = Atl$		$A_1 = Atl$		$A_1 = Atl$		$A_1 = Atl$ **	
	$A_2 = Atl$	$A_2 = Atl$		$A_2 = Atl$		$A_2 = 0.2$		$A_2 = Atl$		$A_2 = Atl$ **	
	$A_3 = Atl$	$A_3 = 0.3$		$A_3 = 0.3$		$A_3 = 0.3$		$A_3 = 0.3$		$A_3 = 0.3$	
	$A_4 = Atl$	$A_4 = Atl$		$A_4 = Atl$		$A_4 = 0.5 \times Atl + 0.1$		$A_4 = Atl$		$A_4 = Atl$	
		5m	33m	0.15	1	2	5	20 [Vrms]			

* Multiply the A values as follows, when the test frequency is less than 300 Hz.

100 Hz $\leq f_m < 300$ Hz: Multiply the A values by 2.
 $f_m < 100$ Hz: Multiply the A values by 2.5.

** Add 0.15 to the A values when all of the following measurement conditions are satisfied.

Test frequency: 300 kHz $< f_m \leq 1$ MHz
 Test signal voltage: 5 V_{rms} $< V_s \leq 20$ V_{rms}
 DUT: Inductor, $|Z_m| < 200 \Omega$ ($|Z_m|$: impedance of DUT)

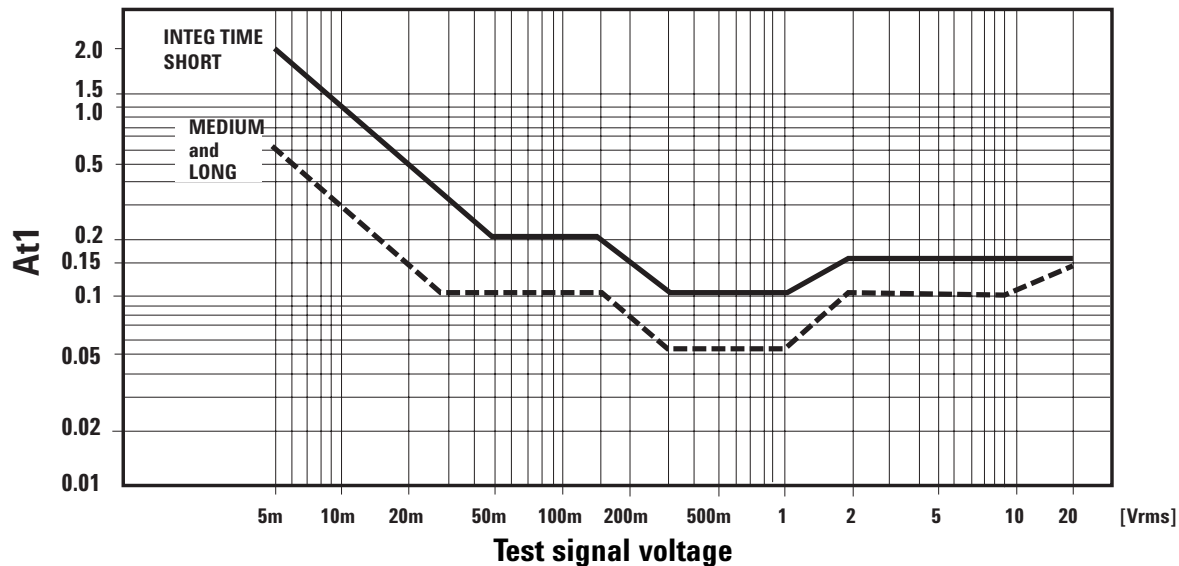

Figure 1-4. Basic accuracy A (2 of 2)

K_a and K_b values are the incremental factors in low impedance and high impedance measurements, respectively. K_a is practically negligible for impedances above 500 Ω , and K_b is negligible for impedances below 500 Ω .

Table 1-1. Impedance proportional factors K_a and K_b

Integ-time	Frequency	K_a	K_b
MEDIUM LONG	$f_m < 100$ Hz	$\left(\frac{1 \times 10^{-3}}{ Z_m }\right) \left(1 + \frac{200}{V_s}\right) \left(1 + \sqrt{\frac{100}{f_m}}\right)$	$ Z_m (1 \times 10^{-9}) \left(1 + \frac{70}{V_s}\right) \left(1 + \sqrt{\frac{100}{f_m}}\right)$
	100 Hz $\leq f_m \leq 100$ kHz	$\left(\frac{1 \times 10^{-3}}{ Z_m }\right) \left(1 + \frac{200}{V_s}\right)$	$ Z_m (1 \times 10^{-9}) \left(1 + \frac{70}{V_s}\right)$
	100 kHz $< f_m \leq 300$ kHz	$\left(\frac{1 \times 10^{-3}}{ Z_m }\right) \left(2 + \frac{200}{V_s}\right)$	$ Z_m (3 \times 10^{-9}) \left(1 + \frac{70}{V_s}\right)$
	300 kHz $< f_m \leq 1$ MHz	$\left(\frac{1 \times 10^{-3}}{ Z_m }\right) \left(3 + \frac{200}{V_s} + \frac{V_s^2}{10^8}\right)$	$ Z_m (10 \times 10^{-9}) \left(1 + \frac{70}{V_s}\right)$
SHORT	$f_m < 100$ Hz	$\left(\frac{2.5 \times 10^{-3}}{ Z_m }\right) \left(1 + \frac{400}{V_s}\right) \left(1 + \sqrt{\frac{100}{f_m}}\right)$	$ Z_m (2 \times 10^{-9}) \left(1 + \frac{100}{V_s}\right) \left(1 + \sqrt{\frac{100}{f_m}}\right)$
	100 Hz $\leq f_m \leq 100$ kHz	$\left(\frac{2.5 \times 10^{-3}}{ Z_m }\right) \left(1 + \frac{400}{V_s}\right)$	$ Z_m (2 \times 10^{-9}) \left(1 + \frac{100}{V_s}\right)$
	100 kHz $< f_m \leq 300$ kHz	$\left(\frac{2.5 \times 10^{-3}}{ Z_m }\right) \left(2 + \frac{400}{V_s}\right)$	$ Z_m (6 \times 10^{-9}) \left(1 + \frac{100}{V_s}\right)$
	300 kHz $< f_m \leq 1$ MHz	$\left(\frac{2.5 \times 10^{-3}}{ Z_m }\right) \left(3 + \frac{400}{V_s} + \frac{V_s^2}{10^8}\right)$	$ Z_m (20 \times 10^{-9}) \left(1 + \frac{100}{V_s}\right)$
f_m : Test frequency [Hz] $ Z_m $: Impedance of DUT [Ω] V_s : Test signal voltage [mV_{rms}]			

K_{aa} is practically negligible for impedances above 500 Ω .

Table 1-2. Cable length factor K_{aa}

Test signal voltage	Cable length			
	0 m	1 m	2 m	4 m
$\leq 2 V_{rms}$	0	0	$\frac{K_a}{2}$	K_a
$> 2 V_{rms}$	0	$\frac{2 \times 10^{-3} \times f_m^2}{ Z_m }$	$\frac{(1+5 \times f_m^2) \times 10^{-3}}{ Z_m }$	$\frac{(2+10 \times f_m^2) \times 10^{-3}}{ Z_m }$
f_m : Test frequency [MHz] $ Z_m $: Impedance of DUT [Ω] K_a : Impedance proportional factor				

Table 1-3. Cable length factor K_{bb}

Frequency	Cable length			
	0 m	1 m	2 m	4 m
$f_m \leq 100$ kHz	1	$1 + 5 \times f_m$	$1 + 10 \times f_m$	$1 + 20 \times f_m$
$100 \text{ kHz} < f_m \leq 300$ kHz	1	$1 + 2 \times f_m$	$1 + 4 \times f_m$	$1 + 8 \times f_m$
$300 \text{ kHz} < f_m \leq 1$ MHz	1	$1 + 0.5 \times f_m$	$1 + 1 \times f_m$	$1 + 2 \times f_m$

f_m : Test Frequency [MHz]

Table 1-4. Calibration interpolation factor K_c

Test frequency	K_c
Direct calibration frequencies	0
Other frequencies	0.0003

Direct calibration frequencies are the following forty-eight frequencies.

Table 1-5. Preset calibration frequencies

			20	25	30	40	50	60	80	[Hz]
100	120	150	200	250	300	400	500	600	800	[Hz]
1	1.2	1.5	2	2.5	3	4	5	6	8	[kHz]
10	12	15	20	25	30	40	50	60	80	[kHz]
100	120	150	200	250	300	400	500	600	800	[kHz]
1	[MHz]									

Table 1-6. Cable length factor K_d

Test signal level	Cable length		
	1 m	2 m	4 m
$\leq 2 V_{rms}$	$2.5 \times 10^{-4}(1 + 50 \times f_m)$	$5 \times 10^{-4}(1 + 50 \times f_m)$	$1 \times 10^{-3}(1 + 50 \times f_m)$
$> 2 V_{rms}$	$2.5 \times 10^{-3}(1 + 16 \times f_m)$	$5 \times 10^{-3}(1 + 16 \times f_m)$	$1 \times 10^{-2}(1 + 16 \times f_m)$

Temperature [$^{\circ}$ C]	5	8	18	28	38	45
K_e		4	2	1	2	4

Figure 1-5. Temperature factor K_e

Agilent 4284A Calibration Accuracy

Calibration accuracy is shown in the following figure:

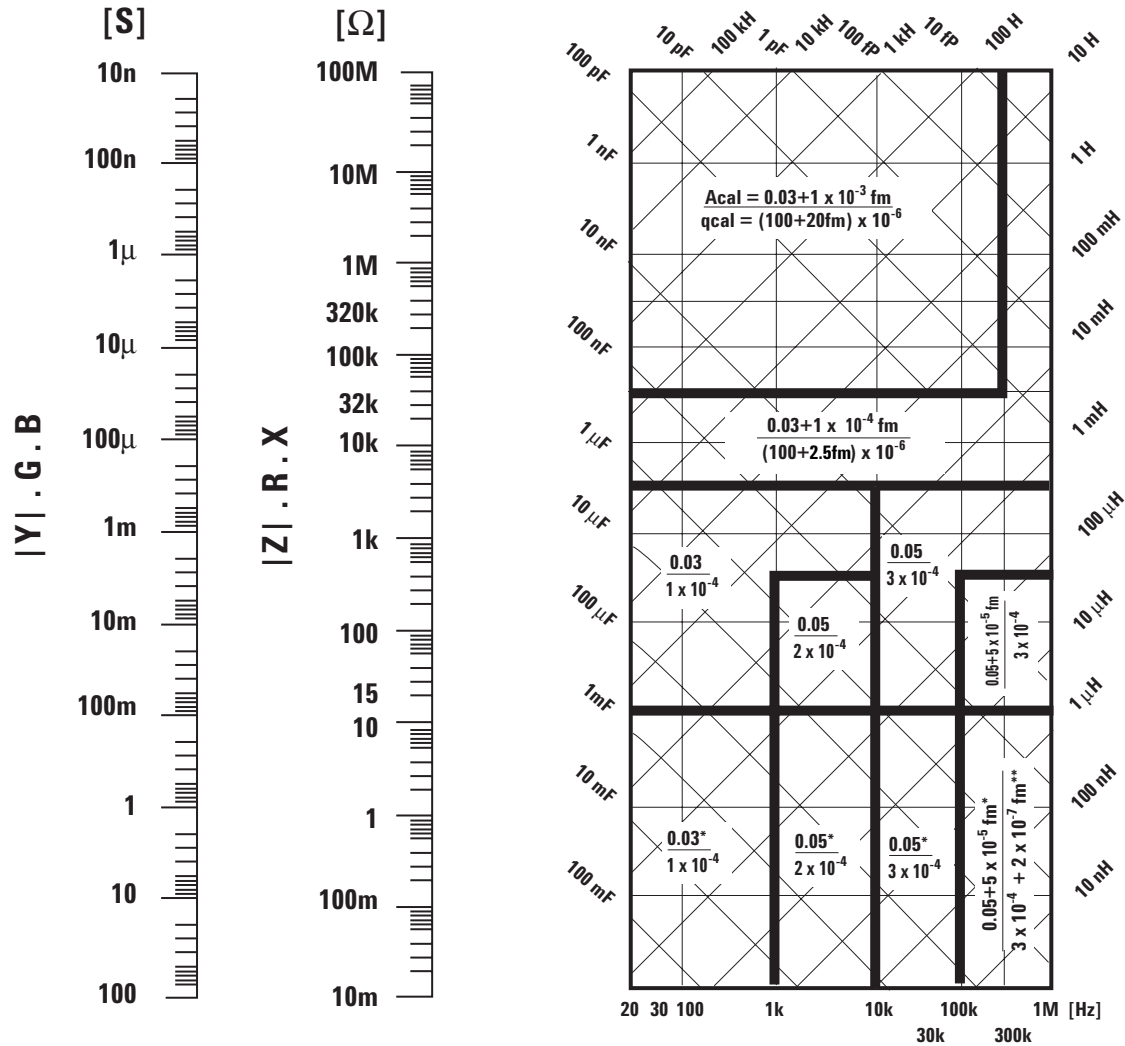

f_m = test frequency [kHz]

On boundary line apply the better value:

Upper value (A_{cal}) is $|Z|$, $|Y|$, L, C, R, X, G, and B calibration accuracy [%]

Lower value (θ_{cal}) is phase calibration accuracy in radians.

Test frequency

- * $A_{cal} = 0.1\%$ when Hi-PW mode is on.
- ** $A_{cal} = (300 + f_m) \times 10^{-6}$ [rad] when Hi-PW mode is on.

Phase calibration accuracy in degree, θ_{cal} [deg] is given as,

$$\theta_{cal} [deg] = \frac{180}{\pi \times \theta_{cal}} [rad]$$

Additional Specifications

When measured value < 10 mΩ, |Z|, R, and X accuracy A_e, which is described on page 5, is given as following equation.

|Z|, R, and X accuracy:

$$A_e = \pm[(K_a + K_{aa} + K_c) \times 100 + K_d] \times K_e \quad (\%)$$

Where

- K_a: Impedance proportional factor (refer to Table 1-1)
- K_{aa}: Cable length factor (refer to Table 1-2)
- K_c: Calibration interpolation factor (refer to Tables 1-4 and 1-5)
- K_d: Cable length factor (refer to Table 1-6)
- K_e: Temperature factor (refer to Figure 1-5)
 - X accuracy apply when D_x (measured D value) ≤ 0.1
 - R accuracy apply when Q_x (measured Q value) ≤ 0.1
 - When D_x > 0.1, multiply A_e by $\sqrt{(1 + D_x^2)}$ for X accuracy.
 - When Q_x > 0.1, multiply A_e by $\sqrt{(1 + Q_x^2)}$ for R accuracy.

When measured value < 10 mΩ, calibration accuracy A_{cal}, which is described on page 11, is given as follows.

Calibration accuracy:

- When 20 Hz ≤ fm ≤ 1 kHz, calibration accuracy is 0.03 [%]*.
- When 1 kHz < fm ≤ 100 kHz, calibration accuracy is 0.05 [%]*.
- When 100 kHz < fm ≤ 1 MHz, calibration accuracy is 0.05 + 5 × 10⁻⁵ fm [%]*.
 - fm: test frequency [kHz]
 - *A_{cal} = 0.1% when Hi-PW mode is on.

Correction Functions

Zero open

Eliminates measurement errors due to parasitic stray impedances of the test fixture.

Zero short

Eliminates measurement errors due to parasitic residual impedances of the test fixture.

Load

Improves the measurement accuracy by using a working standard (calibrated device) as a reference.

List Sweep

A maximum of 10 frequencies or test signal levels can be programmed. Single or sequential test can be performed. When Option 4284A-001 is installed, DC bias voltages can also be programmed.

Comparator Function

Ten bin sorting for the primary measurement parameter, and IN/OUT decision output for the secondary measurement parameter.

Sorting modes

Sequential mode. Sorting into unnested bins with absolute upper and lower limits

Tolerance mode. Sorting into nested bins with absolute or percent limits

Bin count

0 to 999,999

List sweep comparator

HIGH/IN/LOW decision output for each point in the list sweep table.

DC Bias

0 V, 1.5 V, and 2 V selectable

Setting accuracy

±5% (1.5 V, 2 V)

Other Functions

Store/load

Ten instrument control settings, including comparator limits and list sweep programs, can be stored and loaded from and into the internal non-volatile memory. Ten additional settings can also be stored and loaded from each removable memory card.

GPIB

All control settings, measured values, comparator limits, list sweep program. ASCII and 64-bit binary format. GPIB buffer memory can store measured values for a maximum of 128 measurements and output packed data over the GPIB bus. Complies with IEEE-488.1 and 488.2. The programming language is SCPI.

Interface functions

SH1, AH1, T5, L4, SR1, RL1, DC1, DT1, C0, E1

Self test

Softkey controllable. Provides a means to confirm proper operation.

Options

Option 4284A-001 (power amp/DC bias)

Increases test signal level and adds the variable DC bias voltage function.

Test signal level

	Mode	Range	Setting accuracy
Voltage	Non-constant	5 mV to 20 V _{rms}	±(10% + 1 mV)
	Constant ¹	10 mV to 10 V _{rms}	±(10% + 1 mV)
Current	Non-constant	50 μA to 200 mArms	±(10% + 10 μA)
	Constant ¹	100 μA to 100 mArms	±(10% + 10 μA)

1. Automatic level control function is set to on.

Output impedance

100 Ω, ±6%

Test signal level monitor

Mode	Range	Accuracy
Voltage ¹	> 2 V _{rms}	±(3% of reading + 5 mV)
	5 mV to 2 V _{rms}	±(3% of reading + 0.5 mV)
	0.01 mV to 5 mV _{rms}	±(11% of reading + 0.1 mV)
Current ²	> 20 mArms	±(3% of reading + 50 μA)
	50 μA to 20 mArms	±(3% of reading + 5 μA)
	0.001 μA to 50 μArms	±(11% of reading + 1 μA)

1. Add the impedance measurement accuracy [%] to the voltage level monitor accuracy when the DUT's impedance is < 100 Ω
2. Add the impedance measurement accuracy [%] to the current level monitor accuracy when the DUT's impedance is ≥ 100 Ω.

Accuracies apply when test cable length is 0 m or 1 m. Additional error for 2 m or 4 m test cable length is given as:

$$f_m \times \frac{L}{2} [\%]$$

where:

f_m is test frequency [MHz]

L is test cable length [m]

DC bias level

The following DC bias level accuracy is specified for an ambient temperature range of 23 °C ±5 °C. Multiply the temperature induced setting error listed in Figure 1-5 for the temperature range of 0 °C to 55 °C.

Test signal level ≤ 2 V_{rms}

Voltage range	Resolution	Setting accuracy
±(0.000 to 4.000) V	1 mV	±(0.1% of setting + 1 mV)
±(4.002 to 8.000) V	2 mV	±(0.1% of setting + 2 mV)
±(8.005 to 20.000) V	5 mV	±(0.1% of setting + 5 mV)
±(20.01 to 40.00) V	10 mV	±(0.1% of setting + 10 mV)

Test signal level > 2 V_{rms}

Voltage range	Resolution	Setting accuracy
±(0.000 to 4.000) V	1 mV	±(0.1% of setting + 3 mV)
±(4.002 to 8.000) V	2 mV	±(0.1% of setting + 4 mV)
±(8.005 to 20.000) V	5 mV	±(0.1% of setting + 7 mV)
±(20.01 to 40.00) V	10 mV	±(0.1% of setting + 12 mV)

Setting accuracies apply when the bias current isolation function is set to OFF. When the bias current isolation function is set to on, add ±20 mV to each accuracy value (DC bias current ≤ 1 μA).

Bias current isolation function

A maximum DC bias current of 100 mA (typical value) can be applied to the DUT.

DC bias monitor terminal

Rear panel BNC connector

Other Options

Option 4284A-700	Standard power (2 V, 20 mA, 2 V DC bias)
Option 4284A-001	Power amplifier/DC bias
Option 4284A-002	Bias current interface Allows the 4284A to control the 42841A bias current source.
Option 4284A-004	Memory card
Option 4284A-006	2 m/4 m cable length operation
Option 4284A-201	Handler interface
Option 4284A-202	Handler interface
Option 4284A-301	Scanner interface
Option 4284A-710	Blank panel
Option 4284A-907	Front handle kit
Option 4284A-908	Rack mount kit
Option 4284A-909	Rack flange and handle kit
Option 4284A-915	Add service manual
Option 4284A-ABJ	Add Japanese manual
Option 4284A-ABA	Add English manual

Furnished Accessories

Power cable	Depends on the country where the 4284A is being used.
Fuse	Only for Option 4284A-201, Part number 2110-0046, 2 each

Power Requirements

Line voltage

100, 120, 220 Vac ±10%, 240 Vac +5% – 10%

Line frequency

47 to 66 Hz

Power consumption

200 VA max

Operating Environment

Temperature

0 °C to 55 °C

Humidity

≤ 95% R.H. at 40 °C

Dimensions

426 (W) by 177 (H) by 498 (D) (mm)

Weight

Approximately 15 kg (33 lb., standard)

Display

LCD dot-matrix display

Capable of displaying

Measured values
Control settings
Comparator limits and decisions
List sweep tables
Self test message and annunciations

Number of display digits

6 digits, maximum display count 999,999

Supplemental Performance Characteristics

The 4284A supplemental performance characteristics are not specifications but are typical characteristics included as supplemental information for the operator.

Stability

MEDIUM integration time and operating temperature at 23 °C ±5 °C

|Z|, |Y| L, C, R, < 0.01%/day

D < 0.0001/day

Temperature Coefficient

MEDIUM integration time and operating temperature at 23 °C ±5 °C

Test signal level	Z , Y , L, C, R	D
≥ 20 mV _{rms}	< 0.0025%/°C	< 0.000025/°C
< 20 mV _{rms}	< 0.0075%/°C	< 0.000075/°C

Settling Time

Frequency (f_m)

< 70 ms (f_m ≥ 1 kHz)

< 120 ms (100 Hz ≤ f_m < 1 kHz)

< 160 ms (f_m < 100 Hz)

Test signal level

< 120 ms

Measurement range

< 50 ms/range shift (f_m ≥ 1 kHz)

Input Protection

Internal circuit protection, when a charged capacitor is connected to the UNKNOWN terminals.

The maximum capacitor voltage is:

$$V_{max} = \sqrt{\frac{1}{C}} \text{ [V]}$$

where:

V_{max} ≤ 200 V,
C is in Farads

Measurement Time

Typical measurement times from the trigger to the output of EOM at the handler interface. (EOM: end of measurement)

Integration time	Test frequency			
	100 Hz	1 kHz	10 kHz	1 MHz
SHORT	270 ms	40 ms	30 ms	30 ms
MEDIUM	400 ms	190 ms	180 ms	180 ms
LONG	1040 ms	830 ms	820 ms	820 ms

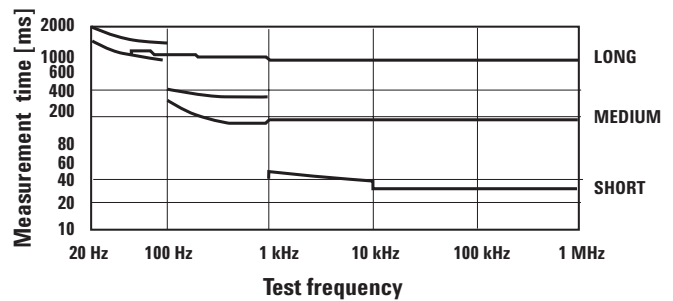

Display time

Display time for each display format is given as

MEAS DISPLAY page	Approx. 8 ms
BIN No. DISPLAY page	Approx. 5 ms
BIN COUNT DISPLAY page	Approx. 0.5 ms

GPIB data output time

Internal GPIB data processing time from EOM output to measurement data output on GPIB lines (excluding display time).

Approx. 10 ms

DC Bias (1.5 V/2 V)

Output current.: 20 mA max.

Option 4284A-001 (Power Amp/DC Bias)

DC bias voltage

DC bias voltage applied to DUT (V_{dut}) is given as

$$V_{dut} = V_b - 100 \times I_b \quad [V]$$

where:

Where, V_b is DC bias setting voltage [V]
 I_b is DC bias current [A]

P is the coefficient listed on Table 1-7.
n is the number of averaging.

DC bias current

DC bias current applied to DUT (I_{dut}) is given as

$$I_{dut} = \frac{V_b}{100 + R_{dc}} \quad [A]$$

where: V_b is DC bias setting voltage [V]
 R_{dc} is the DUT's DC resistance [Ω]

Maximum DC bias current when the normal measurement can be performed is as follows.

Measurement range		10 Ω	100 Ω	300 Ω	1 k Ω	3 k Ω	10 k Ω	30 k Ω	100 k Ω
Bias current isolation	On	100 mA	100 mA	100 mA	100 mA	100 mA	100 mA	100 mA	100 mA
	Off	2 mA	2 mA	2 mA	1 mA	300 μ A	100 μ A	30 μ A	10 μ A

Relative accuracy with bias current isolation

When the bias current isolation function is set to on, add the display fluctuation (N) given in the following equation to the A_e of relative accuracy. (Refer to "relative accuracy" of specification.)

The following equation is specified when all of the following conditions are satisfied.

DUT impedance $\geq 100 \Omega$
Test signal level setting $\leq 1 V_{rms}$
DC bias current $\geq 1 \text{ mA}$
Integration time : MEDIUM

$$N = P \times \frac{\text{DUT impedance } [\Omega]}{\text{Measurement range } [\Omega]} \times \frac{\text{DC bias current } [\text{mA}]}{\text{Test signal level } [V_{rms}]} \times \frac{1}{\sqrt{n}} \times 10^{-4} \quad [\%]$$

When the DC bias current is less than 1 mA, apply N value at 1 mA. When integration time is set to SHORT, multiply N value by 5. When integration time is set to LONG, multiply N value by 0.5.

Table 1-7. Coefficient related to test frequency and measurement range

Meas. range	Test frequency f_m [Hz]			
	$20 \leq f_m < 100$	$100 \leq f_m < 1 \text{ k}$	$1 \text{ k} \leq f_m < 10 \text{ k}$	$10 \text{ k} \leq f_m \leq 1 \text{ M}$
100 Ω	0.75	0.225	0.045	0.015
300 Ω	2.5	0.75	0.15	0.05
1 k Ω	7.5	2.25	0.45	0.15
3 k Ω	25	7.5	1.5	0.5
10 k Ω	75	22.5	4.5	1.5
30 k Ω	250	75	15	5
100 k Ω	750	225	45	15

Calculation Example
Measurement conditions

DUT: 100 pF
Test signal level: 20 mVrms
Test frequency: 10 kHz
Integration time: MEDIUM

Then:

DUT's impedance = $1/(2\pi \times 10^4 \times 100 \times 10^{-12}) = 159 \text{ k}\Omega$
Measurement range is 100 k Ω
DC bias current $\ll 1 \text{ mA}$
P = 15 (according to Table 1-7)

A_e of relative accuracy without bias current isolation is ± 0.22 [%]. (Refer to "relative accuracy" of specification.)

Then, $N = 15 \times (159 \times 10^3) / (100 \times 10^3) \times 1 / (20 \times 10^{-3}) \times 10^{-4} = 0.12$ [%]

Therefore, relative capacitance accuracy is:

$\pm(0.22 + 0.12) = \pm 0.34$ [%]

DC Bias Settling Time

When DC bias is set to on, add the settling time listed in the following table to the measurement time. This settling time does not include the DUT charge time.

Test frequency (f_m)	Bias current isolation	
	On	Off
$20 \text{ Hz} \leq f_m < 1 \text{ kHz}$	210 ms	20 ms
$1 \text{ kHz} \leq f_m < 10 \text{ kHz}$	70 ms	20 ms
$10 \text{ kHz} \leq f_m \leq 1 \text{ MHz}$	30 ms	20 ms

Sum of DC bias settling time plus DUT (capacitor) charge time is shown in the following figure.

Bias source	Bias current isolation	Test frequency (f_m)
(1) Standard	On/Off	$20 \text{ Hz} \leq f_m \leq 1 \text{ MHz}$
(2) Option 4284A-001	Off	$20 \text{ Hz} \leq f_m \leq 1 \text{ MHz}$
(3)	On	$10 \text{ kHz} \leq f_m \leq 1 \text{ MHz}$
(4)	On	$1 \text{ kHz} \leq f_m < 10 \text{ kHz}$
(5)	On	$20 \text{ Hz} \leq f_m < 1 \text{ kHz}$

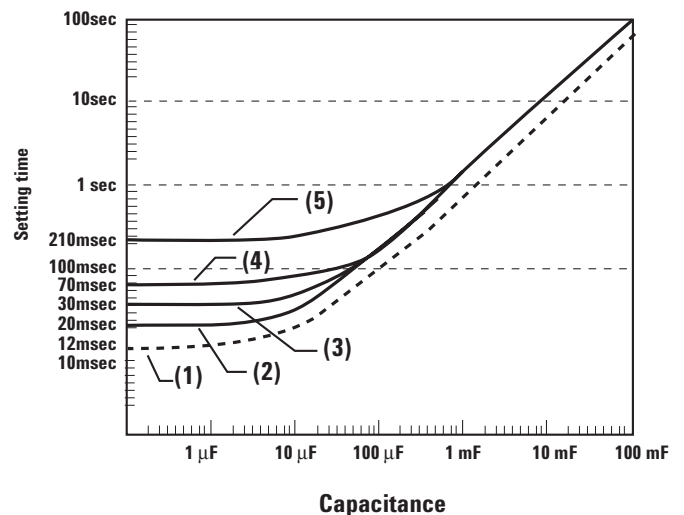

Figure 1-6. Measurement time

Rack/Handle Installation

The Agilent 4284A can be rack mounted and used as a component of a measurement system. The following figure shows how to rack mount the 4284A.

Table 1-8. Rack mount kits

Option	Description	Kit part number
4284A-907	Handle kit	5061-9690
4284A-908	Rack flange kit	5061-9678
4284A-909	Rack flange and handle kit	5061-9684

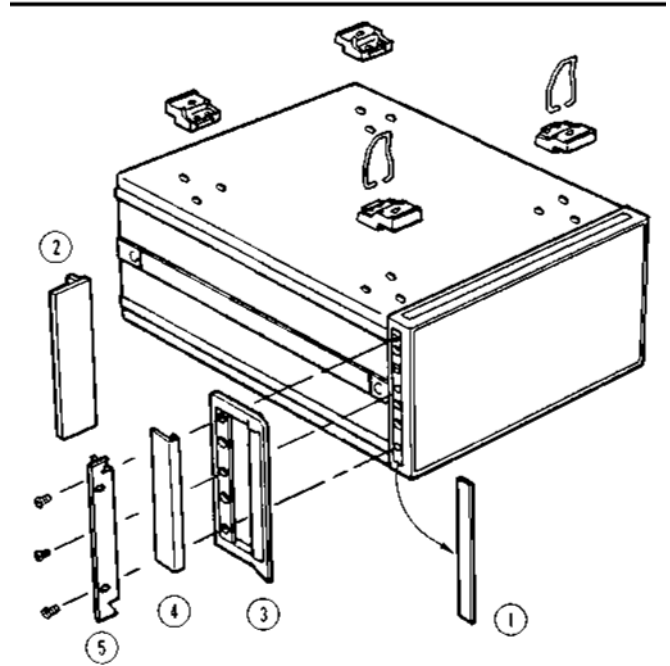

Figure 1-7. Rack mount kits installation

1. Remove the adhesive-backed trim strips (1) from the left and right front sides of the 4284A.
2. HANDLE INSTALLATION: Attach the front handles (3) to the sides using the screws provided and attach the trim strip (4) to the handle.
3. RACK MOUNTING: Attach the rack mount flange (2) to the left and right front sides of the 4284A using the screws provided.
4. HANDLE AND RACK MOUNTING: Attach the front handle (3) and the rack mount flange (5) together on the left and right front sides of the 4284A using the screws provided.
5. When rack mounting the 4284A (3 and 4 above), remove all four feet (lift bar on the inner side of the foot and slide the foot toward the bar).

Storage and repacking

This section describes the environment for storing or shipping the Agilent 4284A, and how to repack the 4284A for shipment when necessary.

Environment

The 4284A should be stored in a clean, dry environment. The following environmental limitations apply for both storage and shipment

Temperature: -20 °C to 60 °C

Humidity: ≤ 95% RH (at 40 °C)

To prevent condensation from taking place on the inside of the 4284A, protect the instrument against temperature extremes.

Original packaging

Containers and packing materials identical to those used in factory packaging are available through your closest Agilent sales office. If the instrument is being returned to Agilent for servicing, attach a tag indicating the service required, the return address, the model number, and the full serial number. Mark the container *FRAGILE* to help ensure careful handling. In any correspondence, refer to the instrument by model number and its full serial number.

Other packaging

The following general instructions should be used when repacking with commercially available materials:

1. Wrap the 4284A in heavy paper or plastic. When shipping to an Agilent sales office or service center, attach a tag indicating the service required, return address, model number, and the full serial number.
2. Use a strong shipping container. A double-walled carton made of at least 350 pound test material is adequate.
3. Use enough shock absorbing material (3- to 4-inch layer) around all sides of the instrument to provide a firm cushion and to prevent movement inside the container. Use cardboard to protect the front panel.
4. Securely seal the shipping container.
5. Mark the shipping container *FRAGILE* to help ensure careful handling.
6. In any correspondence, refer to the 4284A by model number and by its full serial number.

Caution

The memory card should be removed before packing the 4284A.

Agilent Technologies' Test and Measurement Support, Services, and Assistance

Agilent Technologies aims to maximize the value you receive, while minimizing your risk and problems. We strive to ensure that you get the test and measurement capabilities you paid for and obtain the support you need. Our extensive support resources and services can help you choose the right Agilent products for your applications and apply them successfully. Every instrument and system we sell has a global warranty. Support is available for at least five years beyond the production life of the product. Two concepts underlie Agilent's overall support policy: "Our Promise" and "Your Advantage."

Our Promise

Our Promise means your Agilent test and measurement equipment will meet its advertised performance and functionality. When you are choosing new equipment, we will help you with product information, including realistic performance specifications and practical recommendations from experienced test engineers. When you receive your new Agilent equipment, we can help verify that it works properly and help with initial product operation.

Your Advantage

Your Advantage means that Agilent offers a wide range of additional expert test and measurement services, which you can purchase according to your unique technical and business needs. Solve problems efficiently and gain a competitive edge by contracting with us for calibration, extra-cost upgrades, out-of-warranty repairs, and onsite education and training, as well as design, system integration, project management, and other professional engineering services. Experienced Agilent engineers and technicians worldwide can help you maximize your productivity, optimize the return on investment of your Agilent instruments and systems, and obtain dependable measurement accuracy for the life of those products.



Agilent Email Updates

www.agilent.com/find/emailupdates

Get the latest information on the products and applications you select.

Agilent T&M Software and Connectivity

Agilent's Test and Measurement software and connectivity products, solutions and developer network allows you to take time out of connecting your instruments to your computer with tools based on PC standards, so you can focus on your tasks, not on your connections. Visit www.agilent.com/find/connectivity for more information.

For more information on Agilent Technologies' products, applications or services, please contact your local Agilent office. The complete list is available at:

Phone or Fax

United States:

(tel) 800 829 4444
(fax) 800 829 4433

Canada:

(tel) 877 894 4414
(fax) 800 746 4866

China:

(tel) 800 810 0189
(fax) 800 820 2816

Europe:

(tel) 31 20 547 2111

Japan:

(tel) (81) 426 56 7832
(fax) (81) 426 56 7840

Korea:

(tel) (080) 769 0800
(fax) (080)769 0900

Latin America:

(tel) (305) 269 7500

Taiwan:

(tel) 0800 047 866
(fax) 0800 286 331

Other Asia Pacific Countries:

(tel) (65) 6375 8100
(fax) (65) 6755 0042

Email: tm_ap@agilent.com

www.agilent.com/find/contactus

Product specifications and descriptions in this document subject to change without notice.

© Agilent Technologies, Inc. 2004, 2003, 2002
Printed in USA, September 21, 2004
5963-5390E



Agilent Technologies