

DECLARATION OF CONFORMITY

According to ISO/IEC Guide 22 and CEN/CENELEC EN 45014

Manufacturer's Name: Agilent Technologies Japan, Ltd.

Manufacturer's Address: 1-3-2, Murotani, Nishi-ku, Kobe-shi,
Hyogo, 651-2241 Japan

Declares, that the product:

Product Name: LCR Meter

Model Number: 4263B

Product Options: This declaration covers all options of the above product

Conforms with the following product standards:

EMC:	Standard	Limit
	IEC 61326-1:1997 +A1:1998 / EN 61326-1:1997 +A1:1998	
	CISPR 11:1997 / EN 55011:1998 / AS/NZS 2064.1/2	Group 1, Class A ⁽¹⁾
	IEC 61000-4-2:1995 / EN 61000-4-2:1995 +A1:1998	4 kV CD, 4 kV AD
	IEC 61000-4-3:1995 / EN 61000-4-3:1996 +A1:1998	3 V/m 80% AM 80 - 1000 MHz
	IEC 61000-4-4:1995 / EN 61000-4-4:1995	0.5 kV signal lines, 1 kV power lines
	IEC 61000-4-5:1995 / EN 61000-4-5:1995	0.5 kV line-line, 1 kV line-ground
	IEC 61000-4-6:1996 / EN 61000-4-6:1996	3 V 80% AM 0.15 - 80 MHz
	IEC 61000-4-11:1994 / EN 61000-4-11:1994	1 cycle, 100%
	Canada: ICES-001	
Safety:	IEC 61010-1:1990 +A1:1992 +A2:1995 / EN 61010-1:1993 +A2:1995	
	CAN / CSA C22.2 No. 1010.1-92	

Conformity / Supplementary Information:

The product herewith complies with the requirements of the Low Voltage Directive 73/23/EEC and the EMC Directive 89/336/EEC (including 93/68/EEC) and carries the CE-marking accordingly (European Union).

LEDs in this product are Class 1 in accordance with EN 60825-1:1994.

⁽¹⁾ The product was tested in a typical configuration with Agilent Technologies test systems.

Kobe, Japan Dec. 15, 2000
Date

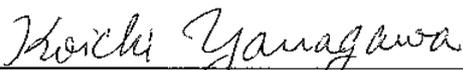
Name Koichi Yanagawa / Quality Engineering Manager

For further information, please contact your local Agilent Technologies sales office, agent or distributor.

Safety Summary

When you notice any of the unusual conditions listed below, immediately terminate operation and disconnect the power cable.

Contact your local Agilent Technologies sales representative or authorized service company for repair of the instrument. If you continue to operate without repairing the instrument, there is a potential fire or shock hazard for the operator.

- Instrument operates abnormally.
- Instrument emits abnormal noise, smell, smoke or a spark-like light during the operation.
- Instrument generates high temperature or electrical shock during operation.
- Power cable, plug, or receptacle on instrument is damaged.
- Foreign substance or liquid has fallen into the instrument.

Herstellerbescheinigung

GERÄUSCHEMISSION

LpA < 70 dB
am Arbeitsplatz
normaler Betrieb
nach DIN 45635 T. 19

Manufacturer's Declaration

ACOUSTIC NOISE EMISSION

LpA < 70 dB
operator position
normal operation
per ISO 7779

Caution

Do not apply DC voltage or current to the UNKNOWN terminals. Do not apply External DC bias voltage more than **+2.5V**. Doing so will damage the 4263B. Before you measure a capacitor, be sure the capacitor is fully discharged.

Agilent 4263B LCR Meter Operation Manual

SERIAL NUMBERS

This manual applies directly to instruments which has the serial number prefix JP1KD, or firmware revision 1.0. For additional important information about serial numbers, read “Serial Number” in Appendix A.



Agilent Technologies

**Agilent Part No. 04263-90050
Printed in JAPAN March 2003**

Sixth Edition

Notice

The information contained in this document is subject to change without notice.

This document contains proprietary information that is protected by copyright. All rights are reserved. No part of this document may be photocopied, reproduced, or translated to another language without the prior written consent of the Agilent Technologies.

Agilent Technologies Japan, Ltd.
Component Test PGU-Kobe
1-3-2, Murotani, Nishi-ku, Kobe-shi,
Hyogo, 651-2241 Japan

©Copyright 1996, 1998, 2000, 2002, 2003 Agilent Technologies Japan, Ltd.

Manual Printing History

February 1996	First Edition (part number: 04263-90010)
June 1998	Second Edition (part number: 04263-90020)
January 2000	Third Edition (part number: 04263-90020)
December 2000	Fourth Edition (part number: 04263-90030)
September 2002	Fifth Edition (part number: 04263-90030)
March 2003	Sixth Edition (part number: 04263-90050)

Safety Summary

The following general safety precautions must be observed during all phases of operation, service, and repair of this instrument. Failure to comply with these precautions or with specific **WARNINGS** elsewhere in this manual may impair the protection provided by the equipment. In addition it violates safety standards of design, manufacture, and intended use of the instrument.

The Agilent Technologies assumes no liability for the customer's failure to comply with these requirements.

Note 4263B complies with INSTALLATION CATEGORY II and POLLUTION DEGREE 2 in IEC1010-1. 4263B is INDOOR USE product.



Ground The Instrument

To avoid electric shock hazard, the instrument chassis and cabinet must be connected to a safety earth ground by the supplied power cable with earth blade.

DO NOT Operate In An Explosive Atmosphere

Do not operate the instrument in the presence of flammable gasses or fumes. Operation of any electrical instrument in such an environment constitutes a definite safety hazard.

Keep Away From Live Circuits

Operating personnel must not remove instrument covers. Component replacement and internal adjustments must be made by qualified maintenance personnel. Do not replace components with the power cable connected. Under certain conditions, dangerous voltages may exist even with the power cable removed. To avoid injuries, always disconnect power and discharge circuits before touching them.

DO NOT Service Or Adjust Alone

Do not attempt internal service or adjustment unless another person, capable of rendering first aid and resuscitation, is present.

DO NOT Substitute Parts Or Modify Instrument

Because of the danger of introducing additional hazards, do not install substitute parts or perform unauthorized modifications to the instrument. Return the instrument to a Agilent Technologies Sales and Service Office for service and repair to ensure that safety features are maintained.

Dangerous Procedure Warnings

Warnings, such as the example below, precede potentially dangerous procedures throughout this manual. Instructions contained in the warnings must be followed.

Warning **Dangerous voltages, capable of causing death, are present in this instrument. Use extreme caution when handling, testing, and adjusting this instrument.**



Certification

Agilent Technologies certifies that this product met its published specifications at the time of shipment from the factory. Agilent Technologies further certifies that its calibration measurements are traceable to the United States National Institute of Standards and Technology, to the extent allowed by the Institution's calibration facility, or to the calibration facilities of other International Standards Organization members.

Warranty

This Agilent Technologies instrument product is warranted against defects in material and workmanship for a period of one year from the date of shipment, except that in the case of certain components listed in *General Information* of this manual, the warranty shall be for the specified period. During the warranty period, Agilent Technologies will, at its option, either repair or replace products that prove to be defective.

For warranty service or repair, this product must be returned to a service facility designated by Agilent Technologies. Buyer shall prepay shipping charges to Agilent Technologies and Agilent Technologies shall pay shipping charges to return the product to Buyer. However, Buyer shall pay all shipping charges, duties, and taxes for products returned to Agilent Technologies from another country.

Agilent Technologies warrants that its software and firmware designated by Agilent Technologies for use with an instrument will execute its programming instruction when properly installed on that instrument. Agilent Technologies does not warrant that the operation of the instrument, or software, or firmware will be uninterrupted or error free.

Limitation Of Warranty

The foregoing warranty shall not apply to defects resulting from improper or inadequate maintenance by Buyer, Buyer-supplied software or interfacing, unauthorized modification or misuse, operation outside the environmental specifications for the product, or improper site preparation or maintenance.

No other warranty is expressed or implied. Agilent Technologies specifically disclaims the implied warranties of merchantability and fitness for a particular purpose.

Exclusive Remedies

The remedies provided herein are buyer's sole and exclusive remedies. Agilent Technologies shall not be liable for any direct, indirect, special, incidental, or consequential damages, whether based on contract, tort, or any other legal theory.

Assistance

Product maintenance agreements and other customer assistance agreements are available for Agilent Technologies products.

For any assistance, contact your nearest Agilent Technologies Sales and Service Office. Addresses are provided at the back of this manual.

Safety Symbols

General definitions of safety symbols used on equipment or in manuals are listed below.



Instruction manual symbol: the product is marked with this symbol when it is necessary for the user to refer to the instruction manual.



Alternating current.



Direct current.



On (Supply).



Off (Supply).



Frame or chassis terminal

Warning



This **Warning** sign denotes a hazard. It calls attention to a procedure, practice, condition or the like, which, if not correctly performed or adhered to, could result in injury or death to personnel.

Caution



This **Caution** sign denotes a hazard. It calls attention to a procedure, practice, condition or the like, which, if not correctly performed or adhered to, could result in damage to or destruction of part or all of the product.

Note



Note denotes important information. It calls attention to a procedure, practice, condition or the like, which is essential to highlight.

Herstellerbescheinigung

GERXISCEMISSION

LpA < 70 dB
am Arbeitsplatz
normaler Betrieb
nach DIN 45635 T. 19

Manufacturer's Declaration

ACOUSTIC NOISE EMISSION

LpA < 70 dB
operator position
normal operation
per ISO 7779

Contents of this Manual

Chapter 1

Provides the product overview and basic measurement procedure. First time users of the 4263B should read this chapter first.

Chapter 2

Shows how to operate the 4263B from its front panel. Please refer to this chapter when you wish to learn about operations using the front panel keys.

Chapter 3

Describes all functions of this instrument. Please refer to this chapter when you wish to learn about the functions of the front and rear panel keys and terminals.

Chapter 4

Shows how to remotely operate the 4263B. Please refer to this chapter when you wish to learn about the procedures for remotely operating the 4263B via the GPIB.

Chapter 5

Contains complete information on remotely operating the 4263B via the GPIB. Please refer to this chapter when you wish to learn about the GPIB's commands, status reporting mechanism, trigger system, and data transmission format.

Chapter 6

Provides a measurement example using the 4263B.

Chapter 7

Provides information for effective operations.

Chapter 8

Provides specifications, reference data, and other general information.

Chapter 9

Describes how to verify the specifications.

Appendix A

Contains information on using the 4263Bs which were manufactured before this manual was printed.

Appendix B

Contains information which is required for using the handler interface. Before using the handler interface, please read this appendix and set the handler interface input/output signal.

Appendix C

Contains the summary of operations, when the 4263B detects OVLD (Overload), or N.C. (No-Contact).

Contents

1. Getting Started

Overview	1-2
Features	1-2
Accessories Available	1-3
Options Available	1-3
Guided Tour of Panels	1-4
 Front Panel	1-4
Display	1-7
 Rear Panel	1-8
Incoming Inspection	1-9
Providing clearance to dissipate heat at installation site	1-9
Instruction for Cleaning	1-9
Power Cable	1-10
Preparation for Turning On	1-12
Setting the Line Voltage	1-12
 Fuse	1-12
Turning On the 4263B and Setting the Line Frequency	1-13
Using the Front-Panel Keys	1-14
Direct Execution Type Keys	1-14
Toggle Type Keys	1-14
Selection Type Keys	1-14
Value Setup Type Keys	1-15
Numeric Keys	1-15
Minimum and Maximum Keys	1-16
Up/Right, Down/Left Arrow Keys	1-16
Back Space Key	1-17
Basic Operation	1-18
Connecting a Test Fixture	1-19
Resetting the 4263B	1-20
Selecting the Measurement Parameter	1-21
Setting the Test Signal Frequency	1-22
Selecting the Measurement Range	1-22
Auto Range mode	1-22
Hold Range mode	1-22
Setting the Test Signal Level	1-23
Matching the Cable Length	1-23
Performing the OPEN Correction	1-24
Performing the SHORT Correction	1-25
Performing the LOAD Correction	1-26

2. Operating the 4263B	
Measurement Configuration	2-1
Selecting Measurement Time Mode	2-1
Setting the Averaging Rate	2-1
Setting Trigger Delay Time	2-2
Setting Contact Check	2-2
Setting the Beeper Mode	2-3
Setting the Level Monitor Mode	2-3
Triggering a Measurement	2-4
Applying the DC Bias	2-4
Using the Internal DC Bias Source	2-4
Using an External DC Bias Source	2-5
Using the Comparator Function	2-5
Display Configuration	2-6
Displaying Deviation Data	2-6
Setting the Reference Value	2-6
Selecting the Deviation Display Mode	2-7
Changing the Measurement Settings Display Mode	2-8
Setting the Display Digit and Display Mode	2-9
Locking Out the Front Panel Keys	2-9
Returning the Local Mode (Exiting the Remote Mode)	2-10
Setting the GPIB Address	2-10
Saving and Recalling Instrument Settings	2-10
Printing Measurement Data	2-11
Testing the 4263B	2-12
Performing a Self-Test	2-12
Testing the Front Panel Keys' Functionality	2-12
If You Have a Problem	2-14
If the Display is Blank and the 4263B Appears Dead	2-14
If an Error Message is Displayed	2-14
If the 4263B does not Accept Any Key Input	2-14
3. Function Reference and Technical Information	
Front Panel	3-2
Display	3-2
LINE Switch	3-3
Chassis Terminal	3-3
 UNKNOWN Terminals	3-3
DC Bias Key 	3-4
Measurement Parameter Key 	3-4
Deviation (Δ) Mode Key 	3-5
Measurement Time Key 	3-5
Average Key 	3-5
Frequency Key 	3-6
Display Mode Key 	3-6
Measurement Settings Display Key 	3-6
Level Monitor Key 	3-6
Level Key 	3-7

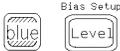
DC Bias Setup Key		3-7
Auto/Hold Range Key		3-7
Range Setup Key		3-8
Trigger Key		3-8
Trigger Mode Key		3-9
Delay Key		3-9
Local Key		3-9
Address Key		3-10
Save Key		3-10
Recall Key		3-10
Comparator Limit Keys		3-11
Left/Down Arrow Key and Up/Right Arrow Key,		3-11
0,1,...,9,(Point),-(Minus) Keys,		3-11
Enter Key		3-11
Shift Key		3-11
Engineering Units Key		3-11
Back Space key		3-12
Minimum Key		3-12
Maximum Key		3-12
Open Key		3-13
Short Key		3-14
Load Key		3-15
Comparator Key		3-16
Contact Check Key		3-17
Cable Key		3-18
Key Lock Key		3-18
Reset Key		3-19
Configuration Key		3-20
Rear Panel		3-21
External Trigger Terminal		3-21
 External DC Bias Terminal		3-22
 LINE Fuse Holder		3-22
LINE Voltage Selector		3-22
Serial Number Plate		3-22
Power Cord Receptacle		3-22

Power Code	3-22
Handler Interface	3-23
Specification	3-23
GPIB Interface	3-26
Technical Information	3-27
Overall Impedance Measurement Theory	3-27
Transformer Parameters Measurement	3-30
Test Current Level	3-32
Test Current Transient	3-33

4. Remote Operation (To Control from a Computer)

Getting Started	4-2
Input/Output Statements	4-2
Reading the GPIB Address	4-2
Sending a Remote Command	4-2
Returning to Local Mode	4-3
Query Commands	4-3
Getting Data from the 4263B	4-3
Remote Operation	4-4
To Set Up the 4263B	4-5
To Reset the 4263B	4-5
To Set the Power Line Frequency	4-5
To Match Cable Length of the Test Fixture	4-5
To Select the Measurement Parameter	4-5
To Select the Test Signal Frequency	4-7
To Select the Test Signal Level	4-7
To Select Measurement Range	4-7
To Apply a DC Bias	4-8
To Perform Correction	4-8
To Select Measurement Time Mode	4-9
To Set the Averaging Rate	4-10
To Set Trigger Delay Time	4-10
To Set Beeper Mode	4-10
To Lock Out the Front Panel Keys	4-10
To Check Contact Integrity at the Test Fixture	4-10
To Use the Comparator Function	4-10
To Display a Deviation Measurement	4-11
To Wait Until Previously Sent Commands are Completed	4-11
To Get the Current Instrument Settings	4-12
To Save and Recall Instrument Settings	4-12
To Trigger a Measurement	4-13
Waiting For Completion Of Measurement (detecting completion of measurement)	4-14
Sample program	4-15
Reading Out Measured Result	4-16
Reading out measured result using *TRG command	4-17
Reading out measured result using :FETC? command	4-21
To Retrieve Data Efficiently	4-25
To Use a Data Buffer	4-25
Other Features	4-26
To Test the 4263B	4-26
To Report the Instrument's Status	4-26
If You Have a Problem	4-28
If the 4263B Hangs Up When You Send the :ABORt Command	4-28

5. GPIB Reference

GPIB Commands	5-1
Common Commands	5-1
Subsystem Commands	5-2
Concept of Subsystem Command Tree	5-4
Program Message Syntax	5-5
Case	5-5
Program Message Terminator	5-5
Subsystem Command Syntax	5-5
Common Command Syntax	5-5
Parameters	5-5
Parameter Types	5-6
Units	5-6
Multiple Messages	5-7
Query and Response Message Syntax	5-7
Command Reference	5-8
Notations	5-8
ABORt Command	5-9
:ABORt	5-9
CALCulate Subsystem	5-10
:CALCulate1:FORMat { REAL MLINear CP CS LP LS }	
:CALCulate2:FORMat { IMAGinary PHASe D Q REAL LP RP INV }	5-11
:CALCulate{1 2}:LIMit:BEEPer:CONDition {FAIL PASS}	5-12
:CALCulate{1 2}:LIMit:BEEPer[:STATe] { ON OFF 1 0 }	5-12
:CALCulate{1 2}:LIMit:CLEar	5-13
:CALCulate{1 2}:LIMit:FAIL?	5-13
:CALCulate{1 2}:LIMit:LOWer[:DATA] <numeric_value>	5-13
:CALCulate{1 2}:LIMit:LOWer:STATe { ON OFF 1 0 }	5-13
:CALCulate{1 2}:LIMit:STATe { ON OFF 1 0 }	5-13
:CALCulate{1 2}:LIMit:UPPer[:DATA] <numeric_value>	5-13
:CALCulate{1 2}:LIMit:UPPer:STATe { ON OFF 1 0 }	5-14
:CALCulate{1 2}:MATH:EXPRession:CATalog?	5-14
:CALCulate{1 2}:MATH:EXPRession:NAME { DEV PCNT }	5-14
:CALCulate{1 2}:MATH:STATe { ON OFF 1 0 }	5-14
:CALCulate{1 2}:PATH?	5-14
:CALCulate{3 4}:MATH:STATe {ON OFF 1 0}	5-14
CALibratIon Subsystem	5-15
:CALibratIon:CABLe <numeric_value>	5-15
DATA Subsystem	5-16
:DATA[:DATA] { REF1 REF2 },<numeric_value>	5-16
:DATA[:DATA]? { BUF1 BUF2 }	5-17
:DATA[:DATA]? {IMON VMON}	5-17
:DATA:FEED { BUF1 BUF2 },<data_handle>	5-18
:DATA:FEED:CONTRol { BUF1 BUF2 },{ ALWAYS NEVER }	5-18
:DATA:POINts { BUF1 BUF2 },<numeric_value>	5-18
DISPlay Subsystem	5-19
:DISPlay[:WINDow][:STATe] { ON OFF 1 0 }	5-19
:DISPlay[:WINDow]:TEXT1:DIGit {3 4 5}	5-19
:DISPlay[:WINDow]:TEXT1:PAGE {1 2}	5-19
:DISPlay[:WINDow]:TEXT2:PAGE {1 2 3 4 5 6}	5-20
FETCh? Query	5-21
:FETCh?	5-21
FORMat Subsystem	5-22
:FORMat[:DATA] { ASCii REAL[,64]}	5-22
INITiate Subsystem	5-23

:INITiate[:IMMEDIATE]	5-23
:INITiate:CONTinuous {ON OFF 1 0}	5-23
SENSE Subsystem	5-24
[:SENSe]:AVERage:COUNT <numeric_value>	5-24
[:SENSe]:AVERage[:STATe] { ON OFF 1 0 }	5-24
[:SENSe]:CORRection:CKIT:STANdard3 <numeric_value>,<numeric_value>	5-25
[:SENSe]:CORRection:COLLect[:ACQuire] STANdard{1 2 3}	5-25
[:SENSe]:CORRection:COLLect:METhod { REFL2 REFL3 }	5-26
[:SENSe]:CORRection:DATA? STANdard{1 2 3}	5-26
[:SENSe]:CORRection[:STATe] { ON OFF 1 0 }	5-26
[:SENSe]:FIMPedance:APERture <numeric_value>[MS S]	5-26
[:SENSe]:FIMPedance:CONtact:VERify { ON OFF 1 0 }	5-26
[:SENSe]:FIMPedance:RANGe:AUTO { ON OFF 1 0 }	5-26
[:SENSe]:FIMPedance:RANGe[:UPPer]	
<numeric_value>[MOHM OHM KOHM MAOHM]	5-27
[:SENSe]:FUNctIon:CONCurrent { ON OFF 1 0 }	5-27
[:SENSe]:FUNctIon:COUNT?	5-27
[:SENSe]:FUNctIon[:ON] <sensor_function>	5-27
SOURCE Subsystem	5-29
:SOURce:FREquency[:CW] <numeric_value>[HZ KHZ]	5-29
:SOURce:VOLTage[:LEVel][:IMMEDIATE][:AMPLitude] <numeric_value>[MV V]	5-29
:SOURce:VOLTage[:LEVel][:IMMEDIATE]:OFFSet <numeric_value> [MV V]	5-29
:SOURce:VOLTage[:LEVel][:IMMEDIATE]:OFFSet:SOURce { INTernal EXTernal }	5-29
:SOURce:VOLTage[:LEVel][:IMMEDIATE]:OFFSet:STATe { ON OFF 1 0 }	5-30
STATUS Subsystem	5-31
:STATus:OPERation[:EVENT]?	5-31
:STATus:OPERation:CONDition?	5-31
:STATus:OPERation:ENABle <numeric_value>	5-31
:STATus:PRESet	5-31
:STATus:QUESTionable[:EVENT]?	5-31
:STATus:QUESTionable:CONDition?	5-31
:STATus:QUESTionable:ENABle<numeric_value>	5-32
SYSTEM Subsystem	5-33
:SYSTem:BEEPper[:IMMEDIATE]	5-33
:SYSTem:BEEPper:STATe {ON OFF 1 0}	5-33
:SYSTem:ERRor?	5-33
:SYSTem:KLOCK {ON OFF 1 0}	5-33
:SYSTem:LFRequency <numeric_value>	5-33
:SYSTem:PRESet	5-33
:SYSTem:VERSion?	5-34
TRIGGER subsystem	5-35
:TRIGger:DELay<numeric_value> [MS S]	5-35
:TRIGger[:IMMEDIATE]	5-35
:TRIGger:SOURce {BUS EXTernal INTernal MANual}	5-35
Common Commands	5-36
*CLS	5-36
*ESE<numeric_value>	5-36
*ESE?	5-36
*ESR?	5-36
*IDN?	5-36
*LRN?	5-36
*OPC	5-36
*OPC?	5-36
*OPT?	5-36
*RCL<numeric_value>	5-36

*RST	5-37
*SAV<numeric_value>	5-37
*SRE<numeric_value>	5-37
*SRE?	5-37
*STB?	5-37
*TRG	5-37
*TST?	5-37
*WAI	5-38
Status Reporting Structure	5-39
Service Request (SRQ)	5-39
Status Byte Register	5-40
Standard Event Status Register	5-41
Standard Operation Status Group	5-42
Operation Status Register	5-44
Questionable Status Register	5-44
Trigger System	5-46
4263B Trigger System Configuration	5-46
IDLE State	5-46
Initiate State	5-47
Trigger Event Detection State	5-47
Sequence Operation State	5-47
Data Transfer Format	5-48
AScii	5-48
REAL	5-49

6. Application Measurement

Measuring Electrolytic Capacitors (Sample Program)	6-1
Measuring Transformers	6-6
Measuring High Inductance Transformers	6-9

7. Impedance Measurement Basics

Characteristics Example	7-2
Parallel/Series Circuit Mode	7-3
Selecting Circuit Model for Capacitance Measurement	7-4
Small Capacitance Values	7-4
Large Capacitance Values	7-4
Selecting Circuit Model for Inductance Measurement	7-5
Small Inductance Values	7-5
Large Inductance Values	7-5
Four-Terminal Pair Configuration	7-6
Measurement Contacts	7-7
Capacitance to Ground	7-8
Contact Resistance	7-9
Extending Test Leads	7-9
Using a Guard Plate for Low Capacitance Measurements	7-10
Shielding	7-10
Contact Check	7-11
Correction Functions of the 4263B	7-12
Standard for the LOAD Correction	7-14
Using a Standard Supplied by a Component Manufacturer	7-14
Using Your Own Standard	7-14
Selecting the LOAD standard	7-14
Measuring the LOAD reference value	7-14

8. Specifications	
Specifications	8-2
Measurement Parameters	8-2
Measurement Conditions	8-2
Measurement Range	8-3
Measurement Accuracy	8-3
Measurement Support Functions	8-9
General	8-10
Supplemental Performance Characteristics	8-11
9. Maintenance	
Test Equipment	9-2
Performance Tests	9-3
Introduction	9-3
Test Equipment	9-3
Calculation Sheet	9-3
Performance Test Record	9-4
Calibration Cycle	9-4
How to Set the 4263B for the Performance Tests	9-4
Test Signal Frequency Accuracy Test	9-5
Specification	9-5
Test Equipment	9-5
Procedure	9-5
Test Signal Level Accuracy Test	9-7
Specification	9-7
Test Equipment	9-7
Procedure	9-7
DC Bias Level Accuracy Test	9-9
Specification	9-9
Test Equipment	9-9
Procedure	9-9
0 m Impedance Measurement Accuracy Test	9-11
Specification	9-11
Test Equipment	9-11
Procedure	9-11
0 m Capacitance Measurement Accuracy Test (Meas. Time Mode: LONG)	9-11
0 m Capacitance Measurement Accuracy Test (Meas. Time Mode: MED)	9-13
0 m Capacitance Measurement Accuracy Test (Meas. Time Mode: SHORT)	9-14
0 m Capacitance Measurement Accuracy Test (DC Bias: ON)	9-14
0 m Resistance Measurement Accuracy Test (Meas. Time Mode: LONG)	9-15
0 m Resistance Measurement Accuracy Test (Meas. Time Mode: MED)	9-16
0 m Resistance Measurement Accuracy Test (Meas. Time Mode: SHORT)	9-16
0 m DC Resistance Measurement Accuracy Test (Opt. 001 Only)	9-17
1 m Impedance Measurement Accuracy Test	9-18
Specification	9-18
Test Equipment	9-18
Procedure	9-18
1 m Capacitance Measurement Accuracy Test	9-18
1 m Resistance Measurement Accuracy Test	9-20
1 m DC Resistance Measurement Accuracy Test (Opt. 001 Only)	9-21
2 m Impedance Measurement Accuracy Test	9-22
Specification	9-22
Test Equipment	9-22
Procedure	9-22
2 m Capacitance Measurement Accuracy Test	9-22

2 m Resistance Measurement Accuracy Test	9-24
2 m DC Resistance Measurement Accuracy Test (Opt. 001 Only)	9-25
4 m Impedance Measurement Accuracy Test	9-26
Specification	9-26
Test Equipment	9-26
Procedure	9-26
4 m Capacitance Measurement Accuracy Test	9-26
4 m Resistance Measurement Accuracy Test	9-28
4 m DC Resistance Measurement Accuracy Test (Opt. 001 Only)	9-29
Calculation Sheet	9-30
Test Signal Frequency Accuracy Test	9-30
Test Signal Level Accuracy Test	9-30
DC Bias Level Accuracy Test	9-30
Standards' Calibration Values	9-31
0 m Impedance Measurement Accuracy Test	9-32
1 m Impedance Measurement Accuracy Test	9-35
2 m Impedance Measurement Accuracy Test	9-36
4 m Impedance Measurement Accuracy Test	9-37
Performance Test Record	9-38
Test Signal Frequency Accuracy Test	9-38
Test Signal Level Accuracy Test	9-38
DC Bias Level Accuracy Test	9-39
0 m Impedance Measurement Accuracy Test	9-40
1 m Impedance Measurement Accuracy Test	9-43
2 m Impedance Measurement Accuracy Test	9-44
4 m Impedance Measurement Accuracy Test	9-45
Functional Tests	9-46
Introduction	9-46
Test Equipment	9-46
Transformer Measurement Functional Test (Opt. 001 Only)	9-47
Test Equipment	9-47
Procedure	9-47
Handler Interface Functional Test	9-49
Test Equipment	9-49
Procedure	9-49
Initial Setup	9-49
Key Lock Function Test	9-49
External Trigger Function Test	9-49
Handler Interface Output Test	9-50
Contact Check Functional Test	9-51
Test Equipment	9-51
Procedure	9-51
Functional Test Record	9-53
Transformer Measurement Functional Test (Opt. 001 Only)	9-53

A. Manual Changes

Introduction	A-1
Manual Changes	A-1
Serial Number	A-2

B. Handler Interface Installation	
Introduction	B-1
Electrical Characteristics	B-1
Output Signals	B-1
Input Signals	B-4
Handler Interface Board Setup	B-5
Tools and Fasteners	B-5
Procedure	B-5
C. Overload/No-Contact Operations	
Messages	
Instrument Errors	Messages-2
GPIB Errors	Messages-3
Index	

Figures

1-1. Power Cable Supplied	1-11
1-2. Voltage Selector and Fuse	1-12
1-3. Connecting a Test Fixture	1-19
3-1. Front Panel	3-2
3-2. Rear Panel	3-21
3-3. Required External Trigger Pulse Specification	3-21
3-4. Pin Assignment of Handler Interface Connector	3-23
3-5. Timing Diagram	3-25
3-6. Simplified Model of Impedance Measurement	3-27
3-7. Vector Representation of Impedance	3-27
3-8. Relationship Between Impedance and Admittance	3-28
3-9. Vector Representation of Admittance	3-28
3-10. Relationship between Measurement Parameters	3-29
3-11. Basic Transformer Measurement Setup	3-30
3-12. Test Signal for DCR Measurement	3-32
3-13. Test Signal Transient in DC Resistance Measurement	3-34
4-1. Simple Program Example	4-4
4-2. SRQ generation sequence (when measurement finishes)	4-14
4-3. Detecting the completion of measurement using SRQ	4-15
4-4. Reading out the measured result in ASCII transfer format by using the *TRG command	4-18
4-5. Reading out the measured result in binary transfer format using *TRG command	4-20
4-6. Reading out the measured result in ASCII transfer format using the :FETC? command	4-22
4-7. Reading out measured result in binary transfer format using :FETC? command	4-24
5-1. Proper Use of the Colon and Semicolon	5-4
5-2. Status Reporting Structure	5-39
5-3. Status Byte Register	5-40
5-4. Standard Event Status Register	5-41
5-5. Standard Operation Status Group Structure	5-43
5-6. Trigger System Configuration	5-46
5-7. Inside an Trigger Event Detection State	5-47
5-8. NR1 Format	5-48
5-9. NR2 Format	5-48
5-10. NR3 Format	5-48
5-11. REAL Data Format	5-49
6-1. Measuring Electrolytic Capacitors	6-1
6-2. Sample Program to Measure Electrolytic Capacitors	6-3
6-3. Connecting a Transformer	6-7
7-1. Typical Characteristics of Components	7-2
7-2. Capacitance Circuit Model Selection	7-4
7-3. Inductance Circuit Model Selection	7-5
7-4. Four-Terminal Pair Measurement Principle	7-6
7-5. Measurement Contacts	7-7
7-6. Model of Capacitance to Ground	7-8
7-7. Reducing Capacitance to Ground	7-8

7-8. Contact Configuration	7-9
7-9. Measurement Contacts for Test Lead Extension	7-9
7-10. Example of DUT Guard Plate Connection	7-10
7-11. Guard Shield	7-10
7-12. Stray Capacitance Causing Contact Check Error	7-11
8-1. Conversion Diagram	8-4
8-2. Maximum Capacitor Voltage	8-17
9-1. Test Signal Frequency Accuracy Test Setup	9-5
9-2. Test Signal Level Accuracy Test Setup	9-7
9-3. DC Bias Level Accuracy Test Setup	9-9
9-4. DC Bias Level Accuracy Test Setup Without The Interface Box	9-10
9-5. 0 m Impedance Measurement Accuracy Test Setup	9-11
9-6. 1 m Impedance Measurement Accuracy Test Setup	9-19
9-7. 2 m Impedance Measurement Accuracy Test Setup	9-23
9-8. 4 m Impedance Measurement Accuracy Test Setup	9-27
9-9. Transformer Measurement Functional Test Setup	9-47
9-10. Handler Interface Functional Test Setup	9-49
9-11. Handler interface Output Order	9-50
9-12. Contact Check Functional Test Setup	9-51
A-1. Serial Number Plate	A-2
B-1. Handler Interface Comparison Output Signals Diagram	B-2
B-2. Handler Interface Control Output Signals Diagram	B-3
B-3. Handler Interface Input Signal Diagram	B-4
B-4. A1 Main Board	B-7

Tables

1-1. Line Voltage Selection	1-12
3-1. Measurement Range Selection	3-8
3-2. Displayable Range	3-8
3-3. Line Voltage selection	3-22
3-4. Pin Assignment of Handler Interface Connector	3-24
3-5. GPIB Interface Capability	3-26
5-1. Usable Units	5-7
5-2. Measurement Parameter Choices	5-12
5-3. Measurement Function Selection	5-28
5-4. Status Byte Assignments	5-40
5-5. Standard Event Status Register Assignments	5-42
5-6. Operation Status Condition Register Assignments	5-44
5-7. Operation Status Event Register Assignments	5-44
5-8. Questionable Status Register Assignments	5-45
7-1. Parallel/Series Circuit Model	7-3
7-2. Correction Functions	7-12
8-1. Measurement Accuracy Parameter: A, B, and C	8-5
8-2. Measurement Accuracy Parameter: D	8-6
8-3. Measurement Accuracy Parameter: E	8-6
8-4. Measurement Time (DC Bias: OFF)	8-15
8-5. Measurement Time (DC Bias: ON)	8-15
8-6. Additional Measurement Time for Rdc Measurement	8-16
8-7. Additional Measurement Time for N and M Measurement	8-16
9-1. Recommended Test Equipment	9-2
9-2. Frequency Accuracy Test Settings	9-6
9-3. Level Accuracy Test Settings	9-8
9-4. Bias Level Accuracy Test Settings	9-10
9-5. 0 m Capacitance Measurement Test (LONG) Settings	9-13
9-6. 0 m Capacitance Measurement Test (MED) Settings	9-14
9-7. 0 m Capacitance Measurement Test (SHORT) Settings	9-14
9-8. 0 m Capacitance Measurement Test (DC Bias) Setting	9-15
9-9. 0 m Resistance Measurement Test (LONG) Settings	9-16
9-10. 0 m Resistance Measurement Test (MED) Settings	9-16
9-11. 0 m Resistance Measurement Test (SHORT) Settings	9-17
9-12. 1 m Capacitance Measurement Test Settings	9-20
9-13. 1 m Resistance Measurement Test Settings	9-20
9-14. 2 m Capacitance Measurement Test Settings	9-24
9-15. 2 m Resistance Measurement Test Settings	9-24
9-16. 4 m Capacitance Measurement Test Settings	9-28
9-17. 4 m Resistance Measurement Test Settings	9-28
9-18. Transformer Measurement Test Limits	9-48
A-1. Manual Changes by Serial Number	A-1
B-1. Handler Output Electrical Characteristics	B-1
B-2. Handler Interface Input Electrical Characteristics	B-4
B-3. Pull-up Resistor Location	B-8
C-1. OVLD/N.C. Condition	C-1

C-2. Simultaneous OVL and N.C. Condition C-2

Getting Started

This chapter provides information to get you started using your 4263B LCR Meter. This chapter discusses the following topics:

- Overview
- Guided Tour of Panels
- Incoming Inspection
- Ventilation Requirements
- Instruction for Cleaning
- Power Cable
- Preparation for Turning On
- Using Front-Panel Keys
- Basic Operation

Overview

4263B LCR Meter is a general purpose LCR meter designed for both component evaluation on the production line and fundamental impedance testing for bench-top applications.

Features

Basic accuracy: 0.1%
Test frequency: 100 Hz, 120 Hz, 1 kHz, 10 kHz, 20 kHz (option 002 only), and 100 kHz
Test Signal Level: 20 mV to 1 Vrms, 5 mV step
Measurement speed: 29 ms
High speed contact check function (5ms)
Quick test recovery
Wide capacitance measurement range
Front-end protection
Built-in comparator
Transformer parameter measurements (option 001)

■ High Reliability / High Throughput

The 4263B has a measurement speed of 29 ms at any test signal frequency. This ability improves the throughput of component evaluation on the product line. The 4263B can check the contact between the test terminals and the Device Under Test (DUT), ensuring the reliability of PASS/FAIL testing with automatic handlers in production.

■ Electrolytic Capacitor Measurement

Electrolytic capacitor measurements require high measurement accuracy in the low impedance range. The 4263B's high accuracy and wide measurement range allow you to make precise measurements of electrolytic capacitors.

■ Transformer Parameter Measurements (Option 001)

The 4263B's ability to make turns ratio (N), mutual inductance (M), and DC resistance (DCR) measurement obsolete data calculations and changing test setups.

4263B

Accessories Available

(Note: This is an optional product.)

16034E	Test Fixture (For SMD or Chip type DUT)
16047A	Test Fixture (For Axial or Radial DUT)
16047B	Test Fixture (For Axial or Radial DUT)
16047C	HF Test Fixture (For Axial or Radial DUT)
16047D	Test Fixture (For Axial or Radial DUT)
16048A	Test Leads (1 m, BNC)
16048B	Test Leads (1 m, SMC)
16048D	Test Leads (2 m, BNC)
16048E	Test Leads (4 m, BNC)
16060A	Transformer Test Fixture
16065A	External Bias Test Fixture
16065C	External Bias Adapter
16085B	Terminal Adapter: Converts 4 terminal pair connector to APC7 connector.
16089A	Kelvin Clip Leads (1 m, two large clips)
16089B	Kelvin Clip Leads (1 m, two medium clips)
16089C	Kelvin Clip Leads (1 m, two IC clips)
16089D	Alligator Clip Leads (1 m, four medium clips)
16089E	Kelvin Clip Leads (1 m, two large clips)
16092A ¹	RF Spring Clip: Axial Radial and SMD
16093A ¹	RF Two-Terminal Binding Post
16093B ¹	RF Three-Terminal Binding Post
16094A ^{1,2}	RF Probe Tip/Adapter
16095A ³	LF Probe Adapter
16191A ¹	Side Electrode SMD Test Fixture
16192A ¹	Parallel Electrode SMD Test Fixture
16193A ¹	Small Side Electrode SMD Test Fixture
16194A ¹	Wide Temperature SMD Test Fixture
16314A	50Ω/4-Term Converter 100Hz-10MHz
16334A	Test Fixture (For SMD or Chip type DUT)
16451B	Dielectric Test Fixture
16452A	Magnetic Test Fixture
16064B	LED Display/Trigger Box (with GO/NO-GO display and trigger button)

¹ 16085B adapter required.

² Cables adapted to APC7 on each end required.

³ Don't connect ground-lead to 4263B.

Note



There is some possibility that available accessories are changed. Refer to latest accessories catalogue about the latest information.

Options Available

Option 001	Add N/M/DCR Measurement Function
Option 002	Add 20 kHz test signal frequency

Guided Tour of Panels

Front Panel

This section gives a guided tour of the front panel. For a detailed description of each key's function, refer to Chapter 3.

Each description starting with (Shift) is the secondary function of the key, which is available by pressing the blue shift key. (Refer to "Shift key.")

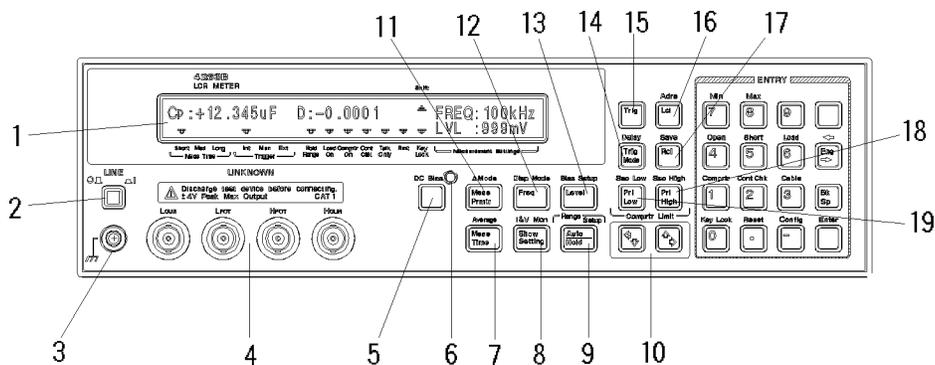

1. **Display** displays measurement result, instrument states, and messages.
2. **LINE Switch** turns the 4263B ON and OFF.
3. **Chassis Terminal** is tied to ground through the instrument's chassis.
4.  **UNKNOWN Terminals** is the connection point for test fixtures. BNC connectors are used for the UNKNOWN Terminals.

Caution

Do *not* apply DC voltage or current to the UNKNOWN terminals. Doing so will damage the 4263B. Before you measure a capacitor, be sure the capacitor is fully discharged.



5. **DC Bias Key** enables or disables DC Bias output.
6. **DC Bias ON/OFF Indicator** turns ON when DC bias output is enabled, and OFF when it is disabled.
7. **Measurement Time Key** selects the measurement time mode from Short, Medium, or Long.
(Shift) **Average Key** sets the averaging rate used to average the measurement result.
8. **Show Setting Key** - changes the mode of the Measurement Settings display.
(Shift) **Current / Voltage Monitor (I&V Mon) Key** - sets the monitor function for the current and voltage.
9. **Auto/Hold Range Key** toggles the measurement range mode between Auto and Hold.
(Shift) **Range Setup Key** selects the measurement range.
10. **Left / Down Arrow (←/↓) Keys and Up / Right Arrow (↑/→) Keys**- each increases or decreases the setting.

4263B

11. **Measurement Parameter Key** selects the measurement parameter to be displayed.
(Shift) Deviation Measurement Mode (Δ Mode) Key - advances the display page when the measurement parameters are being set.
12. **Frequency Key** sets the test signal frequency.
(Shift) Display Mode Key selects the display mode.
13. **Level Key** sets the test signal level.
(Shift) Bias Setup Key selects the DC bias voltage.
14. **Trigger Mode Key** selects the trigger mode from Internal, Manual, or External.
(Shift) Delay Key sets the trigger delay time.
15. **Trigger Key** triggers a measurement in the Manual trigger mode.
16. **Local Key** returns the 4263B to the Local mode from the GPIB Remote mode.
(Shift) Address Key sets the GPIB address.
17. **Recall Key** recalls the instrument state data from internal memory.
(Shift) Save Key stores the instrument state data to internal memory.
18. **Primary Parameter Upper Limit (Pri High) Key** - sets the upper comparator limit for the primary parameter.
(Shift) Secondary Parameter Upper Limit (Sec High) Key - sets the upper comparator limit for the secondary parameter.
19. **Primary Parameter Lower Limit (Pri Low) Key** - sets the lower comparator limit for the primary parameter.
(Shift) Secondary Parameter Lower Limit (Sec Low) Key - sets the lower comparator limit for the secondary parameter.

height

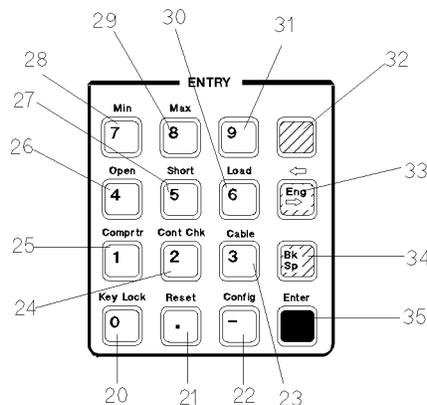

- **0 Key** / (Shift) **Key Lock Key** locks out any key input except for this key.
- **. Key** / (Shift) **Reset Key** resets the 4263B to the default state.
- **- Key** / (Shift) **Configuration Key** sets the beeper setting and the power line frequency, and executes the internal test.
- **3 Key** / (Shift) **Cable Key** sets the cable length.
- **2 Key** / (Shift) **Contact Check Key** toggles the contact check function between ON and OFF.
- **1 Key** / (Shift) **Comparator Key** toggles the comparator function between ON and OFF.
- **4 Key** / (Shift) **Open Key** executes an OPEN correction.
- **5 Key** / (Shift) **Short key** executes a SHORT correction.
- **6 Key** / (Shift) **Load Key** execute a LOAD correction.
- **7 Key** / (Shift) **Minimum key** inputs the minimum value when setting a parameter.
- **8 Key** / (Shift) **Maximum Key** inputs the maximum value when setting a parameter.
- **9 Key**
- **Blue Shift Key** activates the secondary functions printed above the front-panel keys.

Note



In this manual, the blue Shift key is expressed as , even though the top of the key is not labeled with “blue”.

- **Engineering Unit Key** enters the engineering units: p, n, μ , m, k, and M.
- **Back Space Key** erases the last character entered when entering numeric values.
- **Enter Key** enters an input value to the 4263B and terminates the key entry for the current input function.

Display

This section introduces the display. For a more detailed description of each display field, refer to Chapter 3.

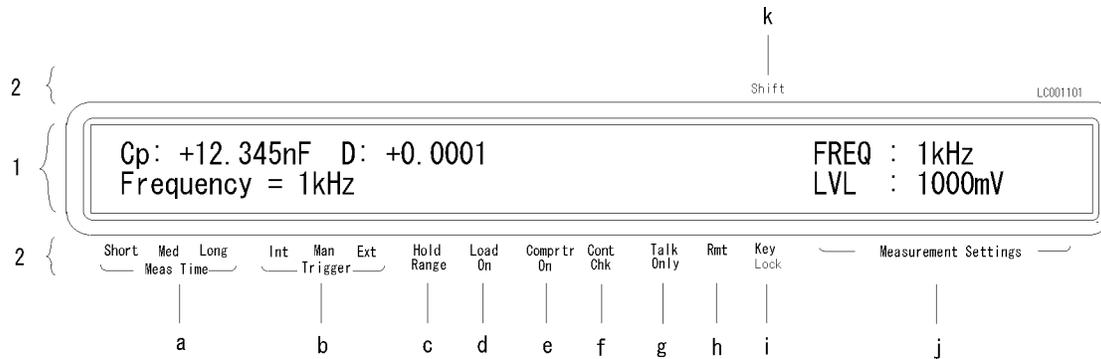

1. **Character Display Area** displays the measurement result, instrument setting, and instrument messages.
2. **Annunciator (▼)** points to the currently selected instrument setting. The Annunciator labels are as follows:
 - a. **Measurement Time** indicates the current measurement time.
 - b. **Trigger** indicates the current trigger mode.
 - c. **Hold Range** indicates that the 4263B is in the Hold range mode. When in the Auto range mode, the Hold range annunciator is not displayed.
 - d. **Load On** indicate that LOAD correction function is ON.
 - e. **Comparator On** indicates that comparator function is ON.
 - f. **Contact Check** indicates that the contact check function is ON.
 - g. **Talk Only** indicates that the 4263B is in the talk only mode.
 - h. **Remote** indicates that the 4263B is in the GPIB remote mode.
 - i. **Key Lock** indicates that the 4263B's front-panel keys are locked out.
 - j. **Measurement Settings** displays the 4263B's settings such as measurement voltage level, test signal frequency. The annunciator(▼) is not displayed here.
 - k. **Shift** indicates that the shift toggle is activated.

Rear Panel

This section gives a tour of the rear panel. For a more detailed description of each item on the rear panel, refer to Chapter 3.

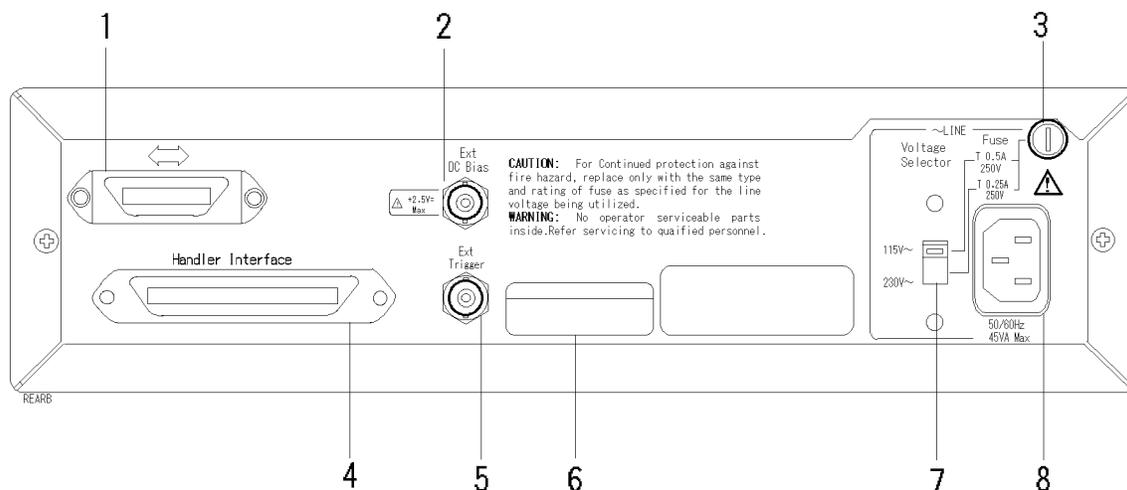

Caution Do not apply External DC bias voltage more than +2.5 V. Doing so will damage the 4263B



1. **GPIB Interface** is used to control the 4263B from an external controller by using the General Purpose Interface Bus (GPIB).
2.  **External DC Bias Terminal** is used to input an external DC bias.
3. **LINE Fuse Holder**
4. **Handler Interface** is used to synchronize timing with an external handler.
5. **External Trigger Terminal** is used to trigger a measurement using an external signal.
6. **Serial Number Plate** gives the instrument's manufacturing information.
7. **LINE Voltage Selector** sets the 4263B to the voltage of the AC power source.
8. **Power Cord Receptacle**

Incoming Inspection

Warning

To avoid hazardous electrical shock, do not turn on the 4263B when there are signs of shipping damage to any portion of the outer enclosure (for example, covers, panel, or display)

Inspect the shipping container for damage. If the shipping container or cushioning material is damaged, it should be kept until the contents of the shipment have been checked for completeness and the 4263B has been checked mechanically and electrically. The contents of the shipment are as follows:

- 4263B LCR Meter
- Power Cable
- Operation Manual(This Book)
- User's Guide

If the contents are incomplete, if there is mechanical damage or defect, or if the analyzer does not pass the power-on selftests, notify the nearest Agilent Technologies office. If the shipping container is damaged, or the cushioning material shows signs of unusual stress, notify the carrier as well as the Agilent Technologies office. Keep the shipping materials for the carrier's inspection.

Providing clearance to dissipate heat at installation site

To ensure the specifications and measurement accuracy of the product, you must keep ambient temperature around the product within the specified range by providing appropriate cooling clearance around the product or, for the rackmount type, by forcefully air-cooling inside the rack housing. For information on ambient temperature to satisfy the specifications and measurement accuracy of the product, refer to Specifications, and "Measurement Accuracy" in Chapter 8.

When the ambient temperature around the product is kept within the temperature range of the operating environment specification, the product conforms to the requirements of the safety standard. Furthermore, under that temperature environment, it has been confirmed that the product still conforms to the requirements of the safety standard when it is enclosed with cooling clearance as follows:

	Conditions
Rear	400 mm
Side	100 mm
Upper	15 mm

Instruction for Cleaning

For cleaning, wipe with soft cloth that is soaked with water and wrung tightly without undue pressure.

Power Cable

In accordance with international safety standards, this instrument is equipped with a three-wire power cable. When connected to an appropriate ac power outlet, this cable grounds the instrument frame. The type of power cable shipped with each instrument depends on the country of destination. Refer to Figure 1-1 for the part numbers of the power cables available.

Warning



For protection from electrical shock, the power cable ground must not be defeated. The power plug must be plugged into an outlet that provides a protective earth ground connection.

<p>OPTION 900</p>  <p>Plug : BS 1363A, 250V Cable : 8120-1351</p>	<p>OPTION 901</p>  <p>Plug : NZSS 198/AS C112, 250V Cable : 8120-1369</p>
<p>OPTION 902</p>  <p>Plug : CEE-VII, 250V Cable : 8120-1689</p>	<p>OPTION 903</p>  <p>Plug : NEMA 5-15P, 125V, 15A Cable : 8120-1378</p>
<p>OPTION 904</p>  <p>Plug : NEMA 6-15P, 250V, 15A Cable : 8120-0698</p>	<p>OPTION 906</p>  <p>Plug : SEV 1011.1959-24507 Type 12, 250V Cable : 8120-2104</p>
<p>OPTION 912</p>  <p>Plug : DHCR 107, 220V Cable : 8120-2956</p>	<p>OPTION 917</p>  <p>Plug : SABS 164, 250V Cable : 8120-4211</p>
<p>OPTION 918</p>  <p>Plug : JIS C 8303, 125V, 15A Cable : 8120-4753</p>	<p>OPTION 922</p>  <p>Plug : GB 1002, 250V Cable : 8120-8376</p>
<p>NOTE: Each option number includes a 'family' of cords and connectors of various materials and plug body configurations (straight, 90° etc.).</p>	

Figure 1-1. Power Cable Supplied

Preparation for Turning On

Before you use the 4263B, you must set it to match the available power line voltage and frequency.

- Set power line voltage – refer to “Setting the Line Voltage”.
- Set power line frequency – refer to “Turning On the 4263B and Setting the Line Frequency”.

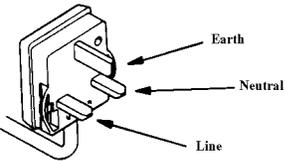
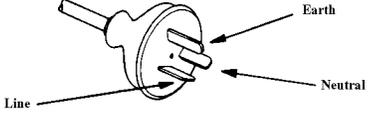
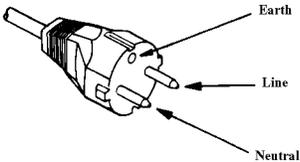
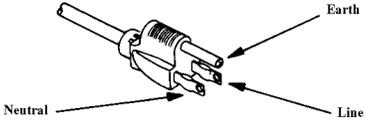
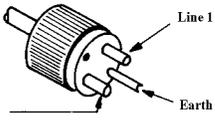
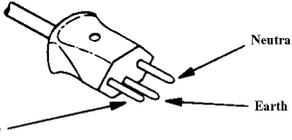
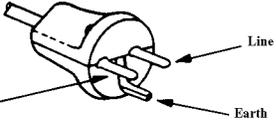
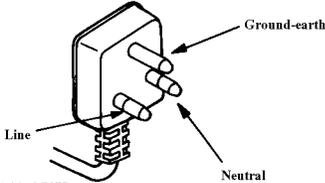
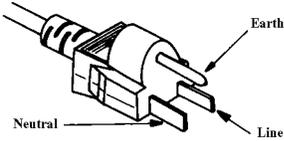
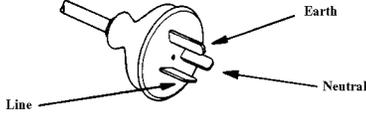
Setting the Line Voltage

The 4263B’s power source requirements are as follows:

Power Line Voltage : 100/120/220/240 Vac($\pm 10\%$)

Power Line Frequency : 47 to 66Hz

Power Consumption : 45 VA maximum

Confirm that the LINE Voltage Selector on rear panel is set to match the power line voltage before plugging in the 4263B. Refer to Figure 1-2

1. Confirm that the power cable is disconnected.
2. Slide the LINE Voltage Selector on the rear panel to match your power line voltage. When your power line voltage is 100/120 Vac($\pm 10\%$), slide the Selector to 115 V. When your power line voltage is 220/240 Vac($\pm 10\%$), slide the Selector to 230 V. See Figure 1-2.

Fuse

Use the fuse shown in Table 1-1. If you require the fuse, contact the nearest Agilent Technologies sales office.

The fuse can be replaced by turning the fuse holder shown in Figure 1-2 counterclockwise until the fuse holder pops out with a minus screw driver.

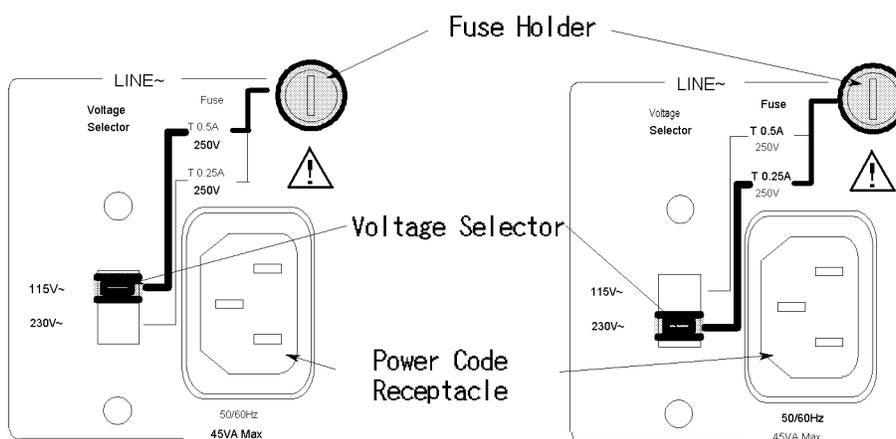

Figure 1-2. Voltage Selector and Fuse

Table 1-1. Line Voltage Selection

Voltage Selector	Power Line Voltage	Required Fuse
115V	100/120Vac($\pm 10\%$)	UL/CSA type, Time delay 0.5A 250V (Agilent part number 2110-0202)
230V	220/240Vac($\pm 10\%$)	UL/CSA type, Time delay 0.25A 250V (Agilent part number 2110-0201)

4263B

Turning On the 4263B and Setting the Line Frequency

1. Connect the power cable to Power Cord Receptacle on the rear panel.
2. Push the LINE switch in and the 4263B will emit a beep when it turns on. (If any message is displayed after the power-on self-test, refer to Messages back of this manual.) The 4263B will be ready for operation after a message similar to the one shown in the following figure.

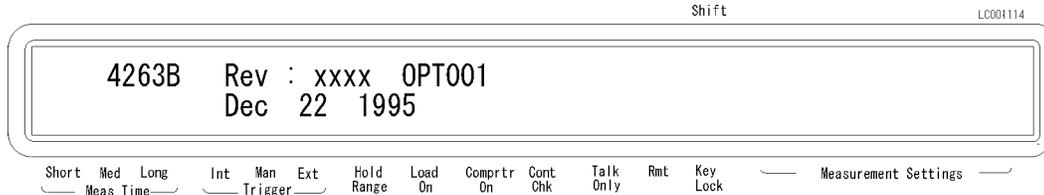

3. Confirm that the power line frequency is set correctly.

a. press  . The following is displayed.

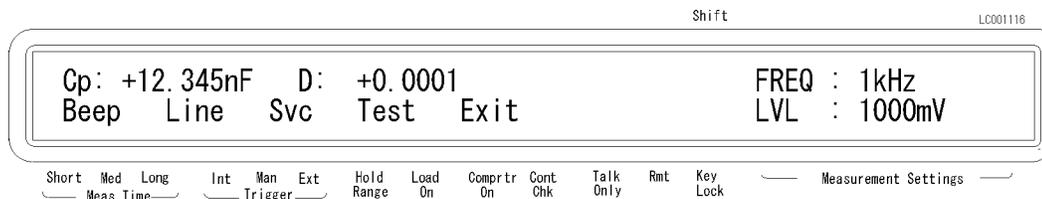

b. Press  until Line blinks, then press .



A blinking item means that it is currently selected.

c. If the setting does not match the power line frequency, press  to toggle the setting between 50Hz and 60Hz.

d. Press  to set the AC power line frequency. Press  until Exit blinks, and then press  again to exit this menu.

Note



The power line frequency setting is stored and is not changed after reset or power-off. Once you set it, you do not need to set the line frequency again as long as the same power line frequency is being used.

Using the Front-Panel Keys

The 4263B has four types of key operations as follows:

- Direct Execution Type Keys
- Toggle Type Keys
- Selection Type Keys
- Value Setup Type Keys

This section shows the operation procedures for the 4263B when the front panel keys are used.

Note



If you want to exit an operation and go back to the measurement mode, press  several times until you are back to the measurement mode.

Direct Execution Type Keys

Pressing a direct execution type key performs the pressed key's function immediately.

Pressing  applies DC bias.

Toggle Type Keys

Pressing a toggle type key switches the setting. An annunciator indicates the current setting.

Pressing  switches the measurement time. The Measurement Time annunciator (▼) moves, and the current setting for measurement time is shown.

Selection Type Keys

Pressing a selection type key will display a menu or choices available for that key. The blinking item is the one currently selected. By using  , or the selection key itself, the item selected can be changed.

For example, to perform the self test,

1. Press  . Exit is blinking.

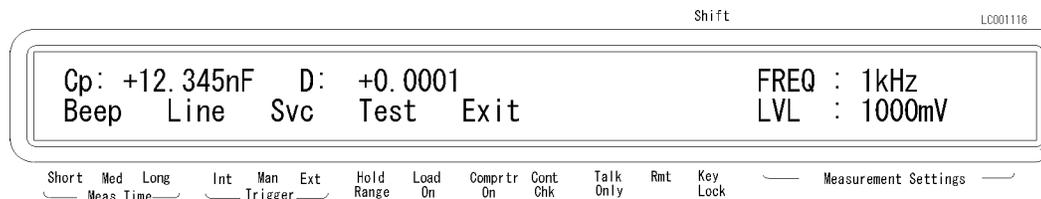

2. Press  to select Test.
3. Press . The self-test will start immediately. After the test is finished, the 4263B displays any existing error code, and returns to the menu.
4. Exit the menu by pressing  after making Exit blink.

4263B

Value Setup Type Keys

Pressing a value setup type key will display the parameter entry display and prompt you to enter a value.

For example,

1. Press   . The display is shown below.

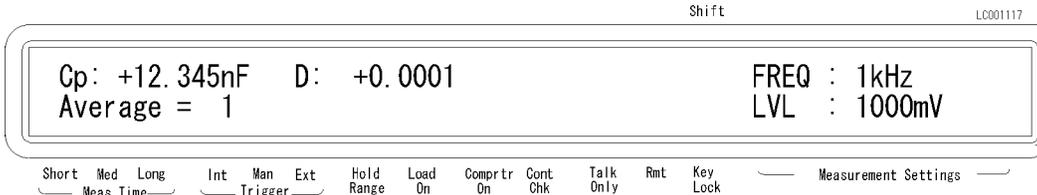

The displayed value can be altered by using the following keys:

- Numeric Keys
- Maximum and Minimum Keys
- Back Space Key
- Down and Up Arrow Keys

Numeric Keys

Input the value which the 4263B will actually use. For example, to set the averaging rate to 10,

1. Press     .

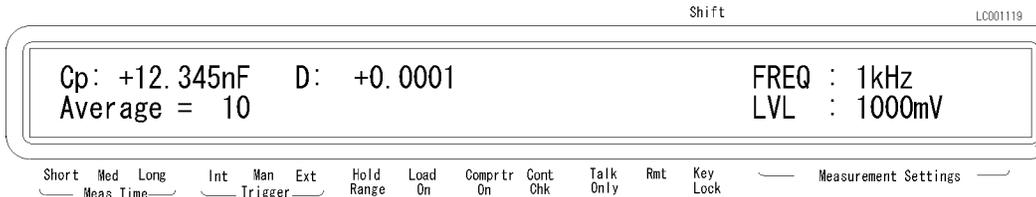

2. Press  .

You can also enter numeric parameters using engineering units. For example,

1. Press      . 100pF will be displayed.

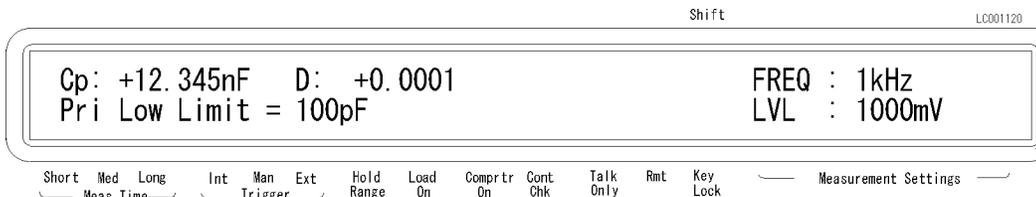

2. Press  again. 100nF will be displayed.

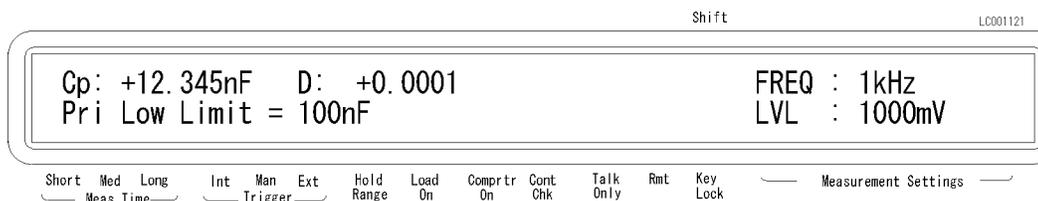

3. Press   . 100pF will be displayed again.

4. Press  to exit.

Note  Before you press  , the previous setting is still the current setting, even if the displayed value has changed. If you press a key other than one of the keys in the ENTRY block before pressing  , the setting will not change and the displayed value will be discarded.

Minimum and Maximum Keys

These keys enter the maximum and minimum numeric value in place of having to use the numeric keys. For example,

1. Press     . The maximum value of averaging rate is displayed.

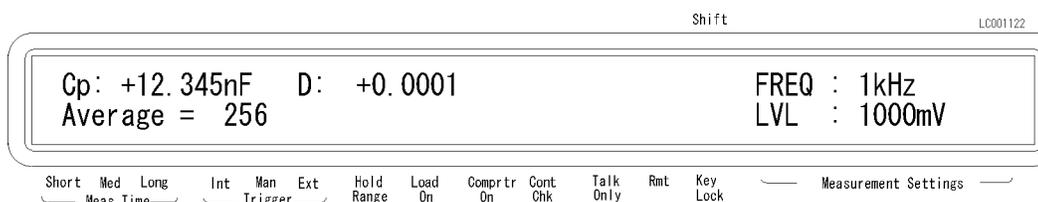

2. Press  to enter the value and exit.

Up/Right, Down/Left Arrow Keys

Increases or decreases the numeric entry. For example,

1. Press   to display GPIB address setting menu.
2. Press  several times and confirm that the value changed.
3. Press  to exit the menu.

4263B

Back Space Key

Erases the last entered character, and cancels the input value. For example,

1. Press  to select the comparator limit menu.

2. Press     .

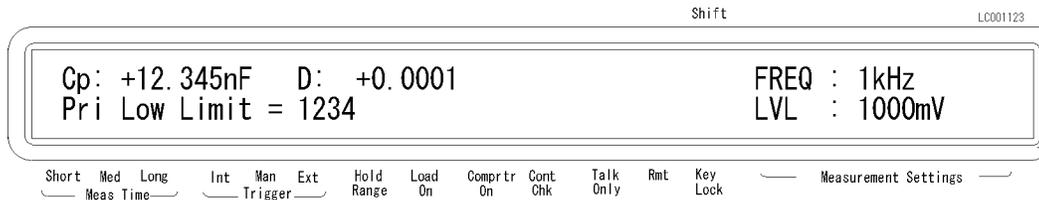

3. Press  .

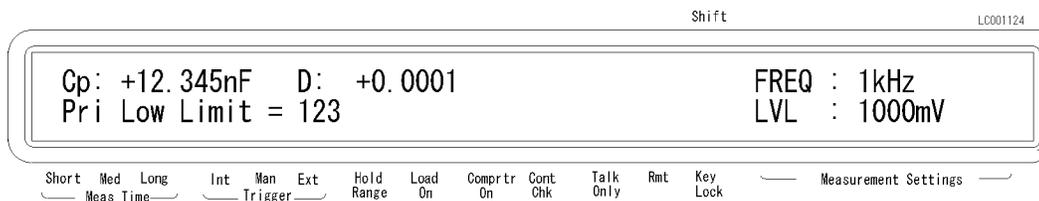

The number 4 which was entered last is erased.

Basic Operation

The following procedure is commonly used to perform a measurement using the 4263B:

1. Configuration setup
2. Turning on the 4263B
3. Setting parameters
4. Error correction
5. Connecting the DUT to the test fixture
6. Measurement

This section provides the basic measurement procedure of the 4263B. Follow the instructions and become familiar with the 4263B's operation.

- Connecting a Test Fixture
- Resetting the 4263B
- Selecting the Measurement Parameter
- Selecting the Test Signal Frequency
- Selecting the Measurement Range
- Setting the Test Voltage
- Matching the Cable Length of Test Fixture
- Performing the OPEN, SHORT and LOAD Correction

Caution  Do *not* apply DC voltage or current to the UNKNOWN terminals. Doing so will damage the 4263B. Before you measure a capacitor, be sure the capacitor is fully discharged.



Note  If you have any problems operating the 4263B, refer to “If You Have a Problem” in Chapter 2.

Connecting a Test Fixture

Use the test fixture suitable for your DUT type. The available fixtures are shown in “Accessories Available”.

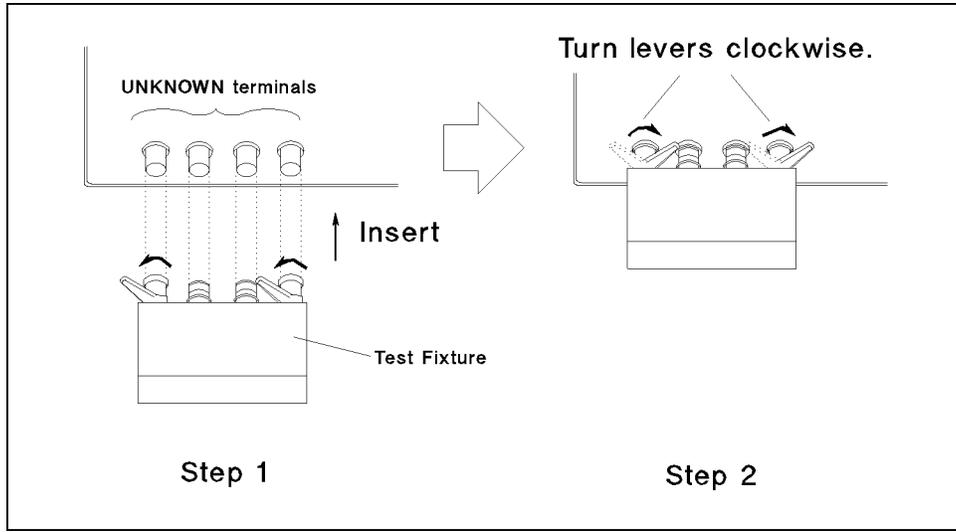

Figure 1-3. Connecting a Test Fixture

Resetting the 4263B

Resetting the 4263B changes its settings to their default states.

The 4263B's settings are held in backup memory for about 72 hours after the 4263B is turned OFF. So resetting is recommended when you start new measurements, even if you have just turned ON the 4263B.

1. Press   to select the reset menu.

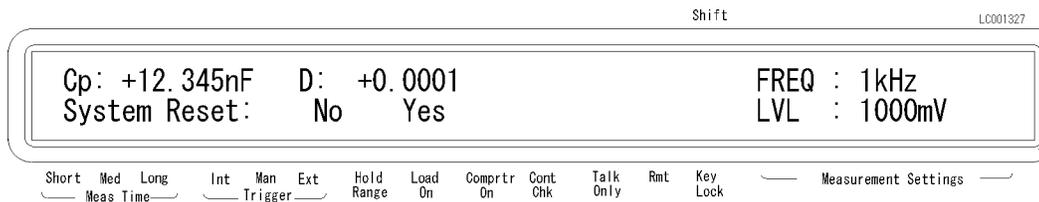

2. Press  until Yes is blinking, then press .

For more information about the default state settings of the 4263B, refer to “Reset Key   ” in Chapter 3.

4263B

Selecting the Measurement Parameter

The 4263B can measure the following parameters:

Primary	Secondary
Z	θ
Y	θ
R	X
G	B
Cp	D, Q, G, Rp
Cs	D, Q, Rs
Lp	D, Q, G, Rp, Rdc
Ls	D, Q, Rs, Rdc
L2	N, 1/N, M, R2

Note



The primary parameter L2 and the secondary parameters Rdc, N, 1/N, M, and R2 can be selected only with Option 001 (Add N/M/DCR measurement function). These parameters are not displayed when the 4263B is not equipped with Option 001.

1. Press  . Primary parameters are displayed.

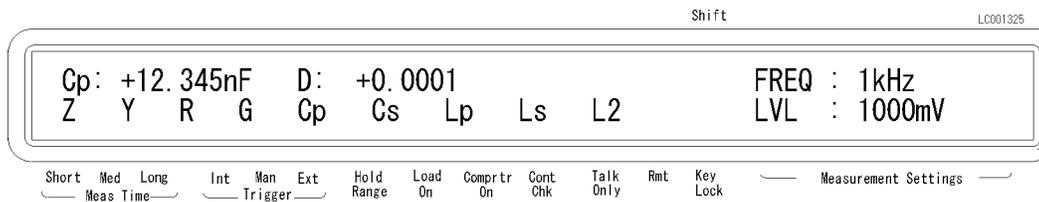

2. Press  or  to select the desired parameter.

3. Press .

4. The secondary parameters will be displayed. Select the desired secondary parameter by pressing  or , in the same manner as the primary parameter.

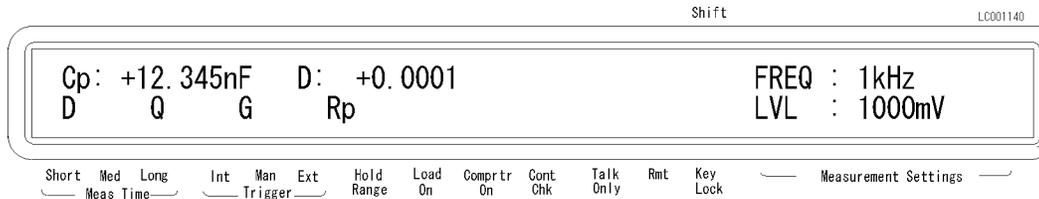

5. Press .

Setting the Test Signal Frequency

1. Press . The test signal frequency setting menu appears.
2. Select the desired frequency using  , or press  until the desired frequency is displayed.
3. Press .

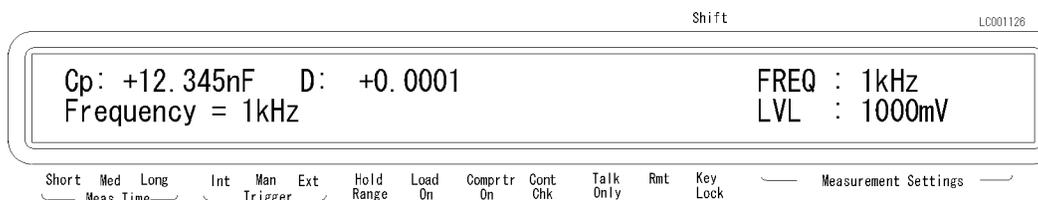

Selecting the Measurement Range

The 4263B has two measurement range modes: Auto and Hold. The Auto mode changes measurement range automatically to fit the measured value. The Hold mode fixes the measurement range. The **Hold Range** annunciator turns ON when in the Hold Range mode.

Auto Range mode

To select the Auto range mode, press  until the **Hold Range** annunciator turns OFF.

Hold Range mode

When the Hold Range annunciator () is shown, the measurement range is set to hold mode. To set the measurement range, press  or  while in this state, and pick a range above or below the current range. Or,

1. Press  . Measurement range menu is displayed.



2. Press  or  until the desired range is displayed. Or, input the impedance value to be measured, and the 4263B selects the optimum measurement range setting.
3. Press .

4263B

Setting the Test Signal Level

1. Press  Bias Setup

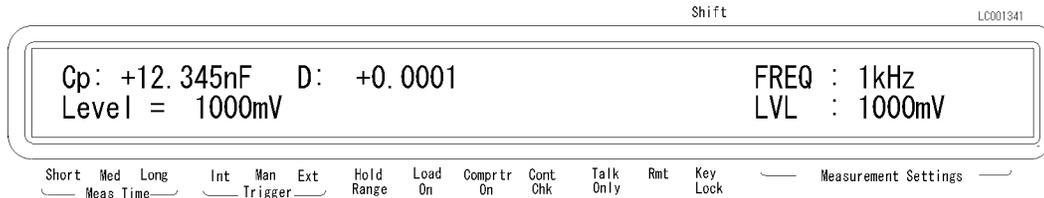

2. Enter the desired value using the numeric key and the engineering key . Or press

 , or  until the desired test signal level is displayed.

When using the numeric key, the value can be set in 5 mV step. When using  or

, the level varies by 50 mV step.

3. Press  Enter

Matching the Cable Length

You can select four test cable lengths: 0 m, 1 m, 2 m, and 4 m.

- 0 m When not using a test lead (connecting the fixture directly to the UNKNOWN terminal)
- 1 m When using the 16048A, 16089A/B/C/D test lead
- 2 m When using the 16048D test lead
- 4 m When using the 16048E test lead

To select cable length,

1. Press  . Cable lengths will be displayed. The blinking value is the current setting.

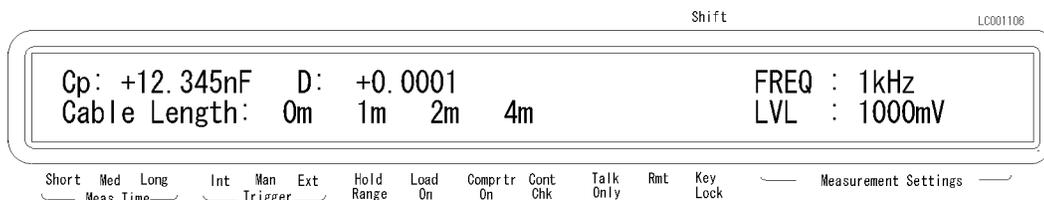

2. Select the desired cable length using  or .

3. Press  Enter.

Performing the OPEN Correction

Before connecting the Device Under Test (DUT) to the test fixture, it is necessary to remove residual errors of the fixture by performing the error correction function.

The OPEN correction is for canceling the stray admittance in parallel with the DUT. To perform the OPEN correction,

1. Confirm that nothing is connected to the test fixture.
2. Press   . The OPEN correction menu is displayed.

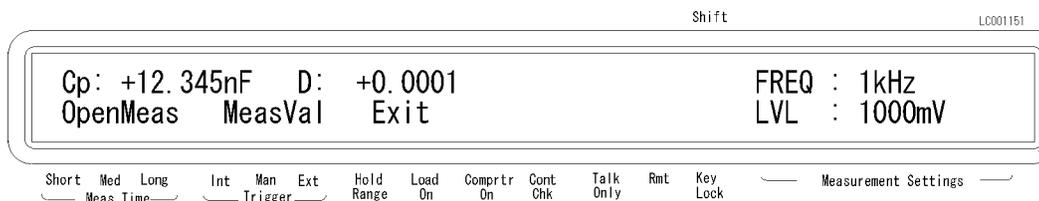

3. Select OpenMeas using  or  , and press  .

The OPEN correction is performed with the following message.

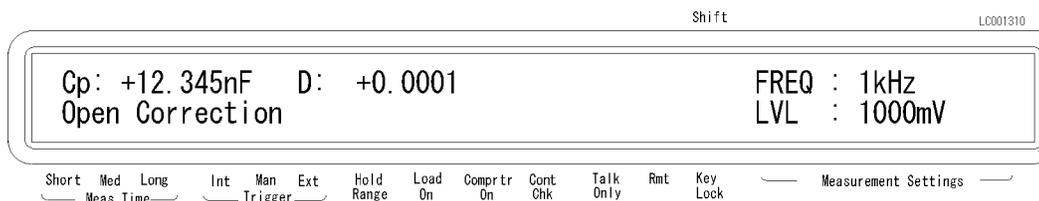

After a while, the 4263B completes OPEN correction with the message Open Correction Complete.

If you select MeasVal  in the OPEN correction menu, the 4263B displays the OPEN admittance measurement value (OPEN correction data).

1. Select MeasVal and press  . The 4263B displays the primary parameter G.
2. Press  The 4263B displays the secondary parameter B.
3. Press  to return to the OPEN correction menu.

The following warning message is displayed when the OPEN admittance $|Y_o|$ is not less than $100 \mu\text{S}$ and is unsuitable for the OPEN correction data.

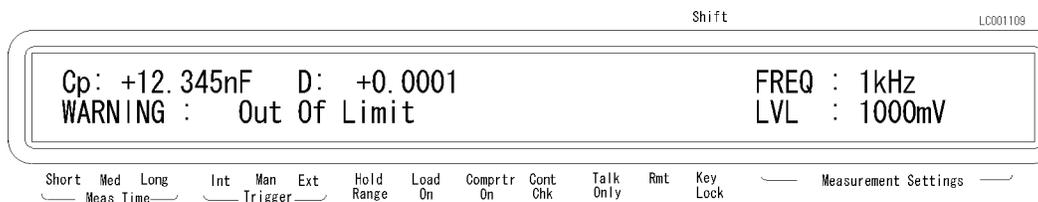

Even if this warning message is displayed, the OPEN correction data will be used. However, it would be better to verify that there is no error in the connection between the test fixture and the UNKNOWN terminal, and in the OPEN correction procedure.

Performing the SHORT Correction

The SHORT correction is for canceling the effects of the residual impedance in series with the DUT. To perform the SHORT correction,

1. Configure the test electrodes in a SHORT configuration by connecting the High and Low electrodes to each other, or by connecting a shorting bar to the test fixture.

2. Press  . The SHORT correction menu is displayed.

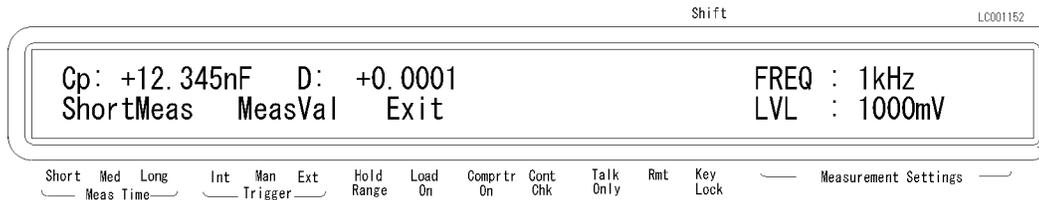

3. Select ShortMeas using  or , and press .

The SHORT correction is performed with the following message.

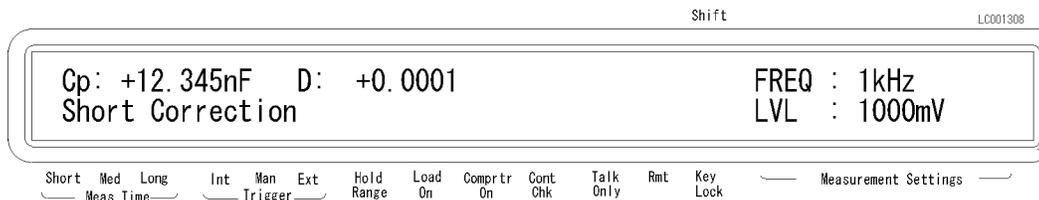

After a while, the 4263B completes SHORT correction with the message Short Correction Complete.

If you select MeasVal in the SHORT correction menu, the 4263B displays the SHORT impedance measurement value (SHORT correction data).

1. Select MeasVal and press . The 4263B displays the primary parameter R.
2. Press . The 4263B displays the secondary parameter X.
3. Press  to return to the SHORT correction menu.

The following warning message is displayed when the SHORT impedance $|Z_s|$ is not less than 10Ω and is unsuitable for the SHORT correction data.

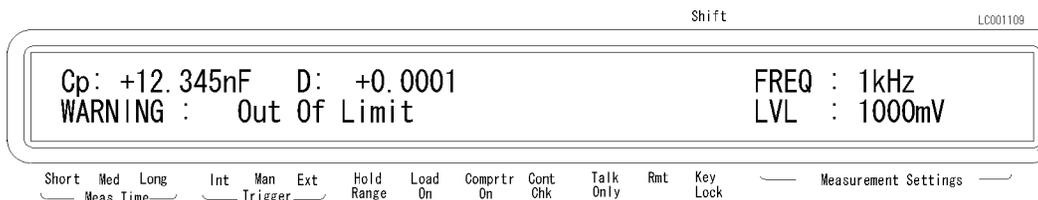

Even if this warning message is displayed, the SHORT correction data will be used. However, it would be better to verify that there is no error in the connection between the test fixture and the UNKNOWN terminal, and in the SHORT correction procedure.

Performing the LOAD Correction

The LOAD correction is for removing the complicated residual error that cannot be removed by the OPEN/SHORT correction. (The LOAD correction is not necessary when using an Agilent direct-connecting test fixture.) The LOAD correction requires a LOAD standard device whose impedance value (reference value) is accurately known. For how to select the LOAD standard device and how to measure the LOAD standard's reference value, refer to "Standard for the LOAD Correction" in Chapter 7.

The LOAD correction is performed as follows:

1. Connect the LOAD standard device to the test fixture.
2. Press   **6** . The following menu is displayed.

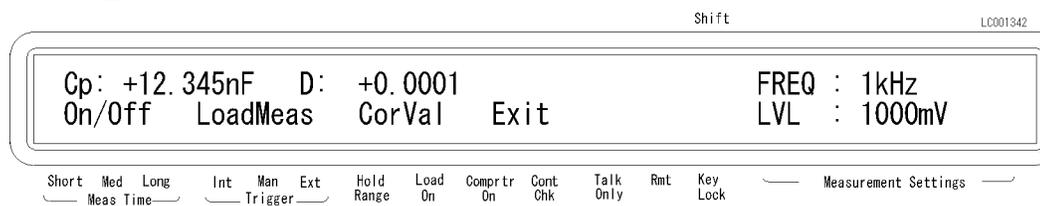

3. Select CorVal using  or  , and press  . The following menu is displayed.

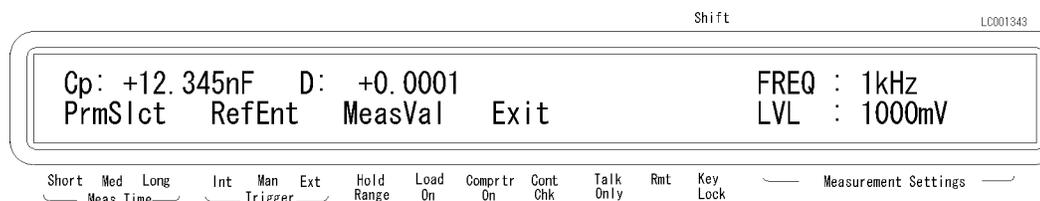

4. Select PrmSlct using  or  , and press  . The menu for selecting the LOAD standard's parameter type is displayed. For example, if the LOAD standard's reference value is in "Cp-D", select Cp in the following menu and press  .

After selecting the primary parameter, the menu for selecting the secondary parameter will appear. Select D in the same manner as the primary parameter Cp.

When the parameter selection is completed, the 4263B will return to the menu of step-3.

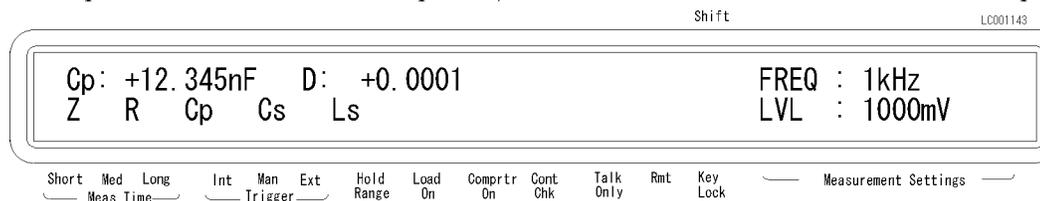

5. Select RefEnt using  or  , and press  . The menu for entering the LOAD standard's reference value is displayed as shown below. In this menu, enter the primary reference value using the numeric key, and press  .

Then the menu for entering the secondary reference value will appear. Enter the secondary reference value in the same manner as the primary.

When the reference value entry is completed, the 4263B will return to the menu of step-3.

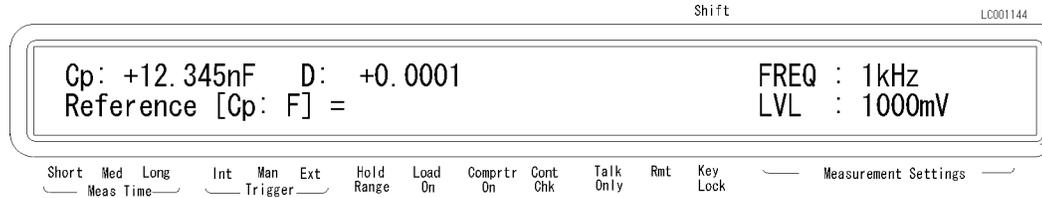

6. Select **Exit** using or and press . The 4263B returns to the menu of step-2.

7. Select **LoadMeas** using or , and press . The LOAD measurement is performed with the following message. When the LOAD measurement is completed, the 4263B returns to the measurement display.

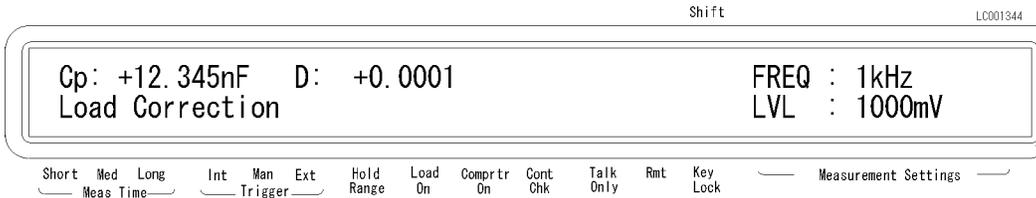

To turn ON the LOAD correction data,

8. Press to display the LOAD correction main menu again.

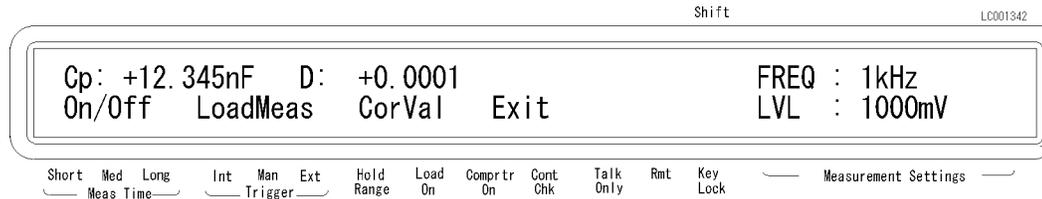

9. Select **On/Off** using or , and press . The following menu is displayed.

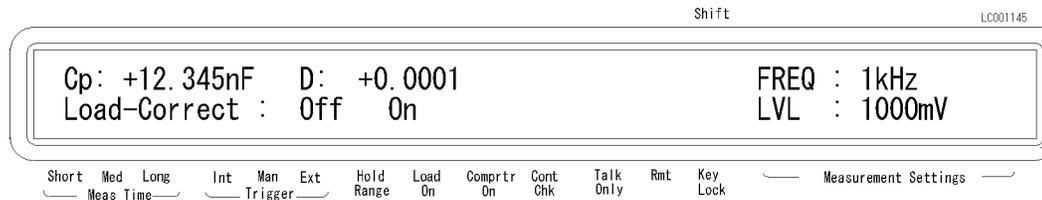

10. Select **On** using or , and press . The LOAD correction data is turned on, and the 4263B returns to the previous menu. Select **Exit** to return to the measurement display.

If you select MeasVal in the menu of step-3, the 4263B displays the LOAD measurement value (LOAD correction data).

1. Select MeasVal and press  . The 4263B displays the primary parameter of the LOAD measurement data.
2. Press  . The 4263B displays the secondary parameter of the LOAD measurement data.
3. Press  to return to the previous menu.

The following warning message is displayed when the difference between the LOAD measurement value and the reference value is more than 20%.

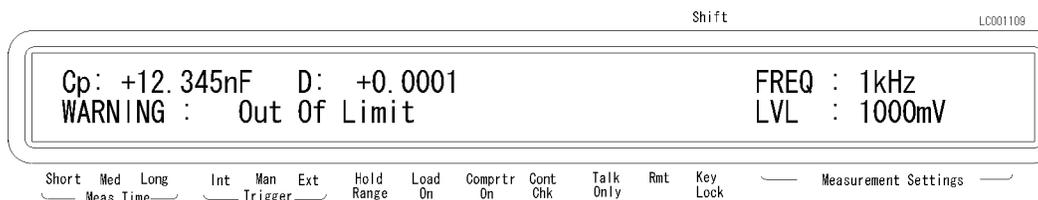

Even if this warning message is displayed, the LOAD correction data will be used. However, it would be better to verify that there is no error in the connection between the test fixture and the UNKNOWN terminal, and in the LOAD correction procedure.

Operating the 4263B

This chapter provides step-by-step instructions for using the 4263B LCR Meter.

This chapter includes the following sections:

- Measurement Configuration
- Triggering a Measurement
- Applying the DC Bias
- Using the Comparator
- Display Configuration
- Locking Out the Front Panel keys
- Returning the Local Mode (Exiting the Remote Mode)
- Saving and Recalling Instrument Settings
- Printing Measurement Data
- Testing the 4263B
- If You Have a Problem

Refer to Chapter 3 for the description of each front panel key's function.

Measurement Configuration

This section discusses the 4263B's general configuration topics that apply to many or all measurement functions.

Selecting Measurement Time Mode

To select measurement time mode, press . The annunciator(▼) displays the current settings (Short, Med or Long).

Setting the Averaging Rate

To set the averaging time:

1. Press  .

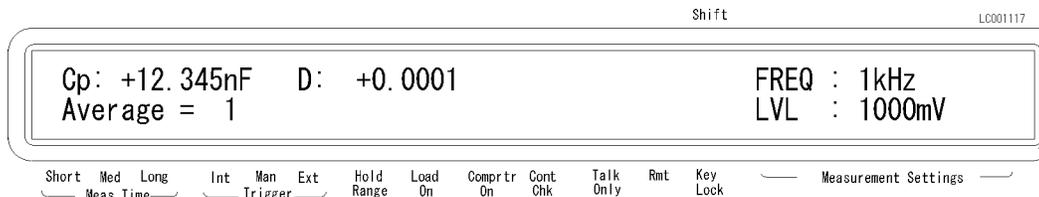

2. Enter the desired value.
3. Press  to set the value and to exit.

Setting Trigger Delay Time

To set the trigger delay time:

1. Press  .

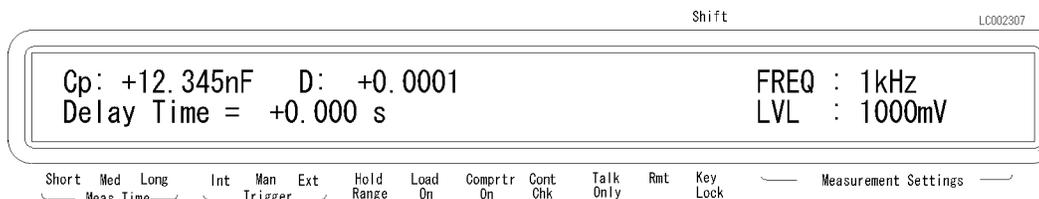

2. Enter the desired value.
3. Press  to set the value and to exit.

Setting Contact Check

The **Cont Chk** annunciator tells whether the contact check function is set or not.

Note



When the measurement parameter is L2-N, L2-1/N, L2-M, or L2-R2, the contact check function can not be set.

Before performing the contact check, perform OPEN and SHORT correction to measure the reference values for the contact check.

- To turn ON the contact check function.

Press  .

- To turn OFF the contact check function.

Press   again.

4263B

Setting the Beeper Mode

To change the beeper mode for comparator result reporting;

1. Press   .

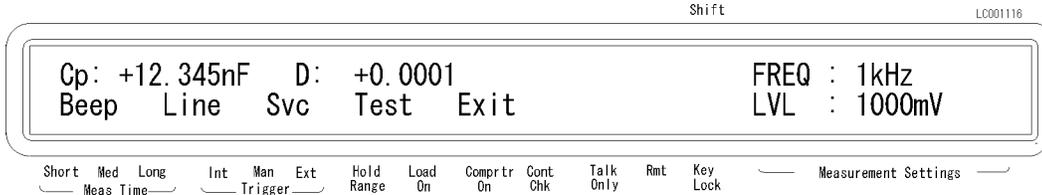

2. Select Beep using  or  , and press  .

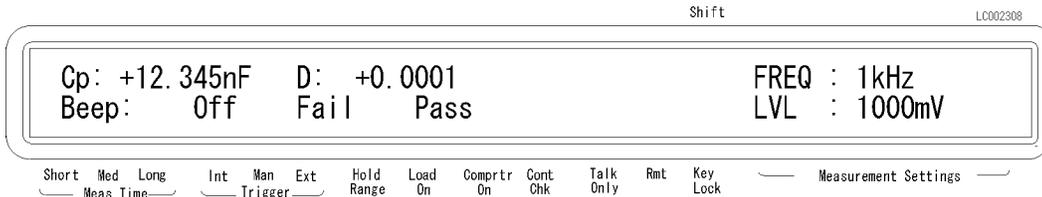

3. Select the desired Beep mode using  or  , and press  . When the Beep mode selection is completed, the 4263B returns to the previous menu.
4. To exit, select Exit using  or  , and press  .

Setting the Level Monitor Mode

To set the level monitor mode:

- Press   .

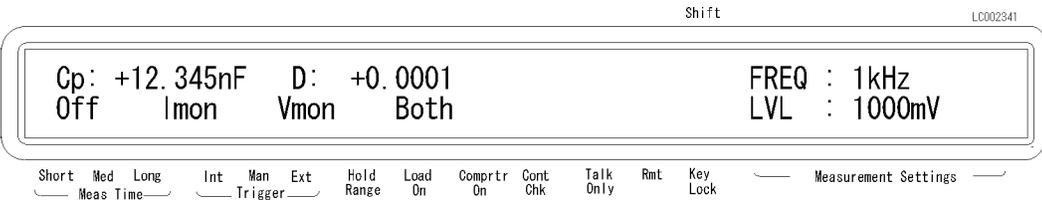

- Select the desired mode using   , and press  .

Triggering a Measurement

The 4263B has four trigger source modes: Internal, Manual, External, or Bus. The **Trigger** annunciator shows which trigger source is selected.

Note

When the bus trigger mode is selected, none of the **Trigger** annunciators are ON. The bus trigger mode can be set by GPIB commands only.



■ To Trigger Internally

1. Press  until the **Int** trigger annunciator is ON.

■ To Trigger Manually

1. Press  until the **Man** trigger annunciator is ON.
2. Press  to trigger a measurement.

■ To Trigger Externally

1. Connect an external trigger source to the Ext Trigger terminal on the 4263B's rear panel.
2. Press  until the **Ext** trigger annunciator is ON.
3. Apply a TTL level trigger signal to trigger a measurement.

Applying the DC Bias

The **DC Bias ON/OFF** indicator tells whether the DC bias is applied or not.

Using the Internal DC Bias Source

1. Press  .

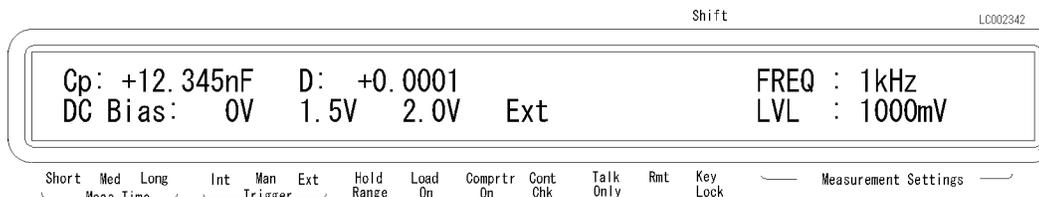

2. Select the desired DC voltage value using  or .
3. Press  to enter the value and exit.
4. Press  to apply the DC bias. The DC Bias ON/OFF indicator is ON.

4263B

5. Press  again to turn OFF the DC bias. The DC Bias ON/OFF indicator is OFF.

Using an External DC Bias Source

1. Connect an external DC bias source to the Ext DC Bias Terminal on the 4263B's rear panel.
For details about the external DC bias voltage, refer to “ External DC Bias Terminal” in Chapter 3

2. Press  .

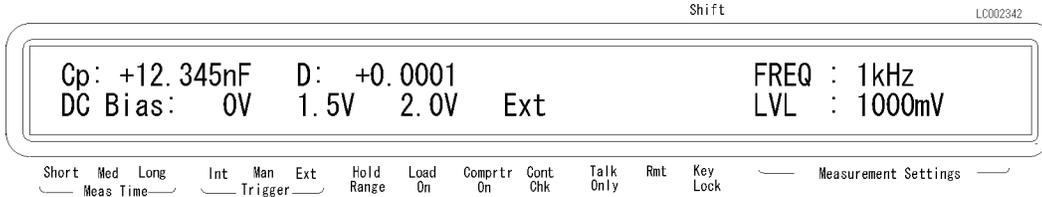

3. Select Ext using  or , and press .
4. Press  to apply the DC bias. The DC Bias ON/OFF indicator will turn ON.
5. Press  again to turn OFF the DC bias. The DC Bias ON/OFF indicator will turn OFF.

Using the Comparator Function

The comparator function is for sorting DUTs based on their parameter values. The **Comprtr On** annunciator tells whether the comparator function is set to ON or OFF.

- To set the limit values

1. Select the limit to be set by pressing  or  for the primary parameter, and   or   for the secondary parameter.

For example, if you want to set the lower limit of the primary parameter, press . The following menu is displayed.

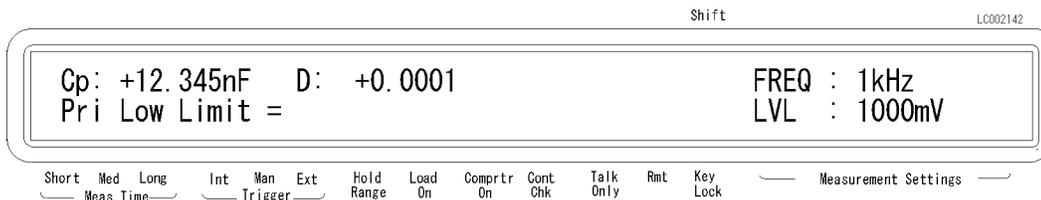

2. Enter the desired limit value, and press .

Note

If you do not want to set a limit value for either the upper or lower limit of the primary/secondary parameters, set a maximum or minimum value for that value.

- To start sorting

Press shift; .

- To display the sorting results

Pressing . The menu for selecting the display mode appears as follows.



If Comprtr is selected in this menu, the comparison result is displayed as follows.

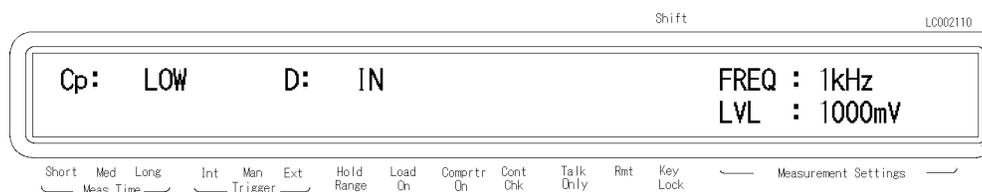

- To stop sorting:

Press .

Display Configuration

Displaying Deviation Data

The Δ before the measurement parameter on the LCD display tells that the displayed value for the parameter is the deviation value.

Setting the Reference Value

1. Press .

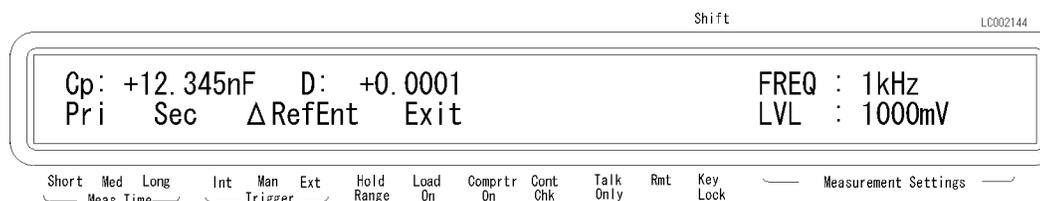

4263B

2. Select ΔRefEnt using  or , and press . The 4263B displays the menu for entering the primary parameter's reference value ($\Delta\text{Ref Primary}=\text{}$).

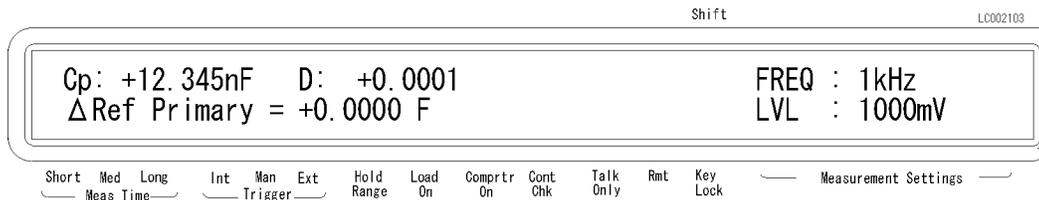

- To set by measuring a reference DUT:
 - a. Press  regardless of the trigger mode. The primary parameter is measured and the measurement result is displayed. Press  to enter the measurement value as the primary reference.
 - b. Then the 4263B displays the menu for entering the secondary parameter's reference value ($\Delta\text{Ref Secondary}=\text{}$). Press  in the same manner as the primary parameter. The secondary parameter is measured and the measurement result is displayed. Press  to enter the measurement value as the secondary reference.
- To set by entering a value:
 - a. Enter the primary parameter's reference value using the numeric key, and press .
 - b. Then the prodno; displays the menu for entering the secondary parameter's reference value ($\Delta\text{Ref Secondary}=\text{}$). Enter the secondary parameter's reference value using the numeric key, and press .

Selecting the Deviation Display Mode

To select the deviation display mode (Off, Δ , or $\Delta\%$),

3. To select the deviation display mode for the primary parameter, press  or  to select Pri, and press . The following menu is displayed. Select the desired mode (ΔABS , $\Delta\%$, or Off) using  or , then press .

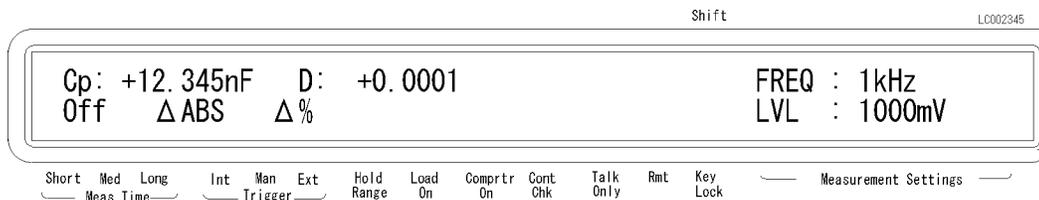

4. To select the deviation display mode for the secondary parameter, press  or  to select Sec, and press . The same menu as above figure is displayed. Select the mode for the secondary parameter in the same manner as the primary parameter.

Changing the Measurement Settings Display Mode

Each time  is pressed, the current settings of the 4263B are displayed one after another on the right side of the LCD. The information displayed and the order of display is as follows:

1. Test signal frequency and Test signal level

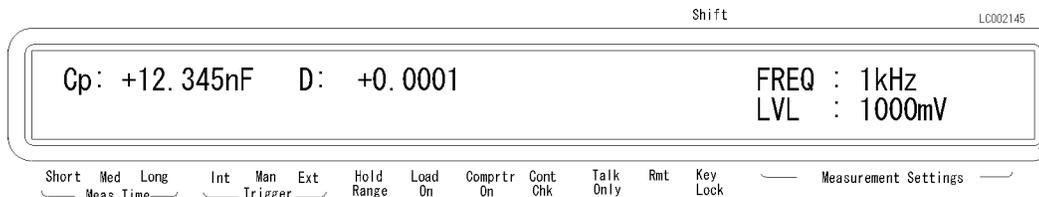

2. DC bias and Averaging rate



3. Trigger delay and Cable length

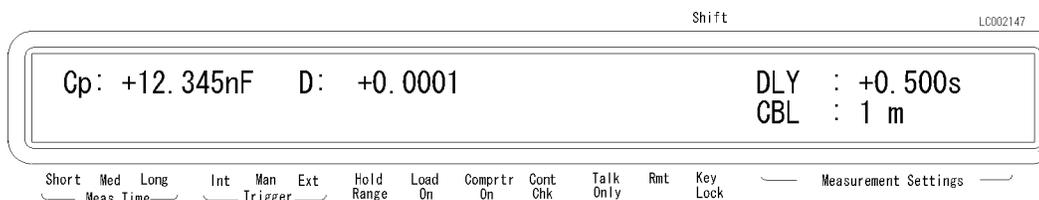

4. Comparator limit of the primary parameter

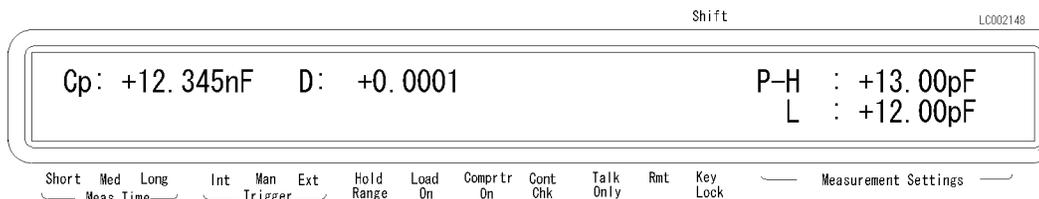

5. Comparator limit of the secondary parameter

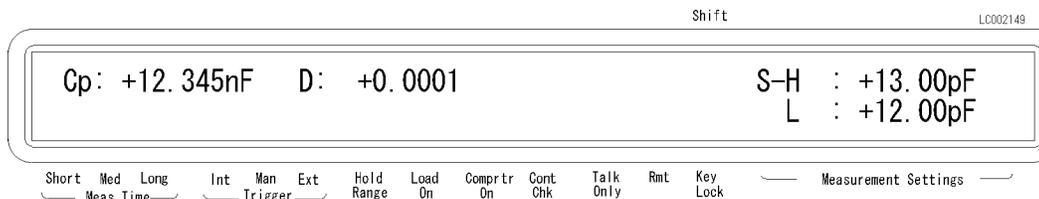

6. Level monitor value

When both the current and voltage monitor are turned on, the 4263B displays them as shown in the following figure. When either of the current or voltage monitor is turned off, the test signal frequency is displayed instead. When both of them are turned off, the 4263B displays Vmon: OFF, Imon: OFF.

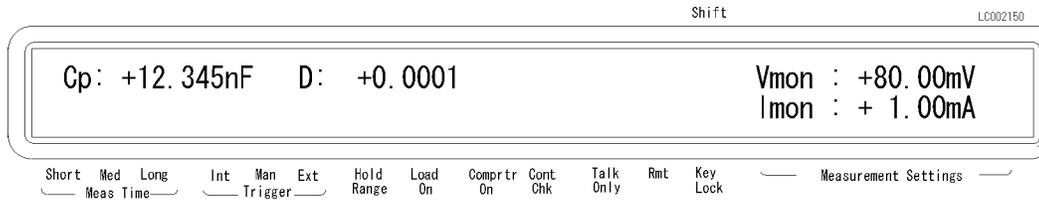

If you press  again after the level monitor value is displayed, the 4263B will return to the test signal frequency and test signal level display.

Setting the Display Digit and Display Mode

If you press  , the display mode selecting menu appears. Select the desired display mode using  or . (Data: displays the measurement data, Comprtr: displays the result of the comparator, Off: turns the display OFF.). You can exit this menu by selecting Exit.

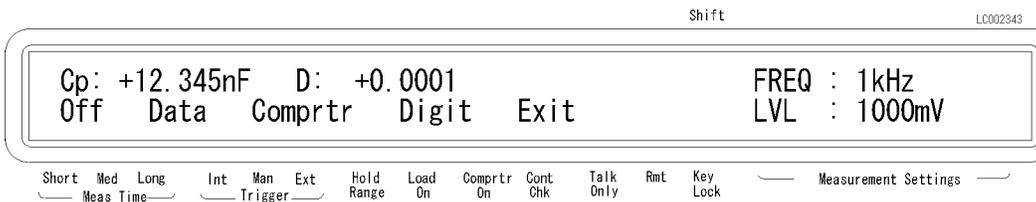

If you select Digit, the menu for setting display digit appears. Select the desired digit using  or , and press . After setting the digit, the 4263B will return to the previous menu.

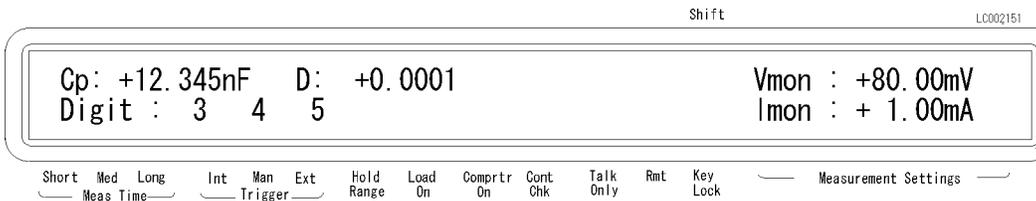

Locking Out the Front Panel Keys

To lockout the keys:

Press  .

To unlock the keys:

Press   again.

Returning the Local Mode (Exiting the Remote Mode)

To return the 4263B to local mode from GPIB remote mode:

Press  .

Setting the GPIB Address

1. Press   .

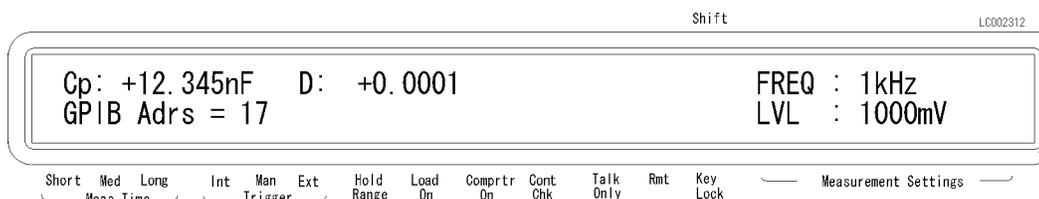

2. Enter the desired value, then press  to set the value and to exit.

Saving and Recalling Instrument Settings

The 4263B can save and recall the instrument's settings. Saved items are same as ones stored in the back-up memory listed in "LINE Switch" in Chapter 3 description.

■ To save the current settings:

1. Press   .

2. Enter the register number (0 to 9) that you want to save the settings into.

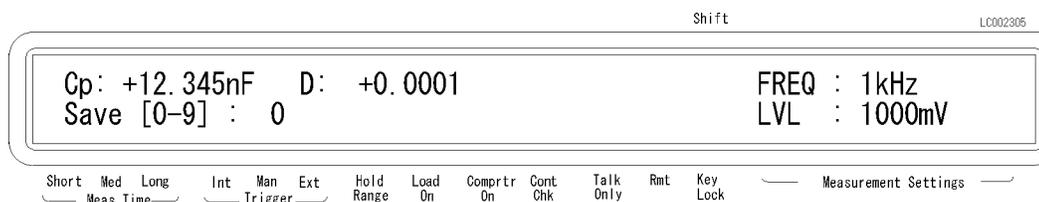

3. Press  to save.

Note Record the register number that you used for future reference.



■ To recall a setting.

1. Press  .
2. Enter the register number (0 to 9) that you want to recall the settings from.

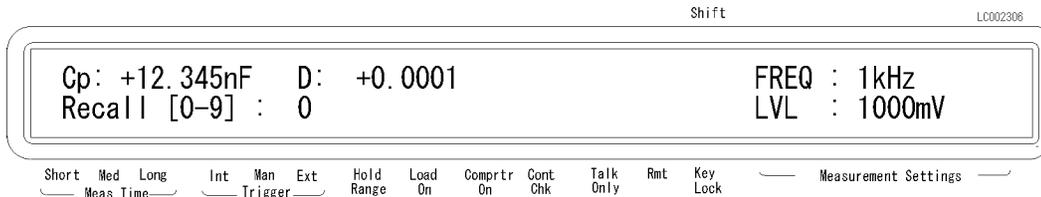

3. Press  to recall.

Printing Measurement Data

The 4263B can print measurement data to an GPIB compatible printer without using an external controller. To print measurement data,

1. Set the printer to listen-always mode.
2. Connect the printer to the 4263B's GPIB port.
3. Turn the printer ON.
4. Set the 4263B's GPIB address to 31 (talk only mode).

Press      .

The printer will automatically begin printing the measurement data.

5. To stop printing, change the 4263B's GPIB address to an address other than 31 (for example, 17, which is the default setting).

Press      .

Testing the 4263B

Performing a Self-Test

The 4263B has a self-test function to check its basic performance.

1. Press  .

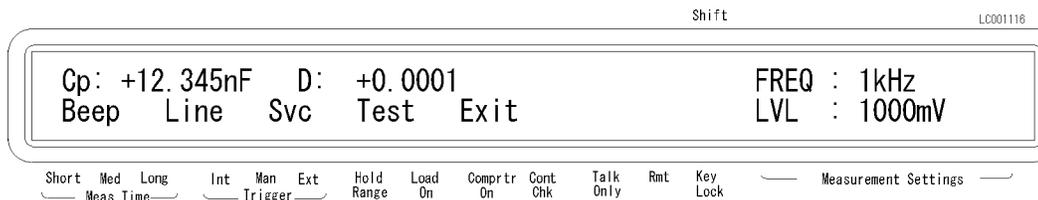

2. Select Test using  or , then press  to execute the self test. If any error message is displayed, refer to “Messages” back of this manual.
3. Select Exit and press  to exit.

Testing the Front Panel Keys’ Functionality

The 4263B has a service function to test the functionality of the front panel keys, the handler interface, the ROM, the RAM, and the EEPROM).

This section describes how to test the front panel keys’ functionality.

Note For the handler interface test, refer to Chapter 9 for the procedure. The other tests are for use by service personnel only.



1. Press  .

2. Select Svc using  or  and press .

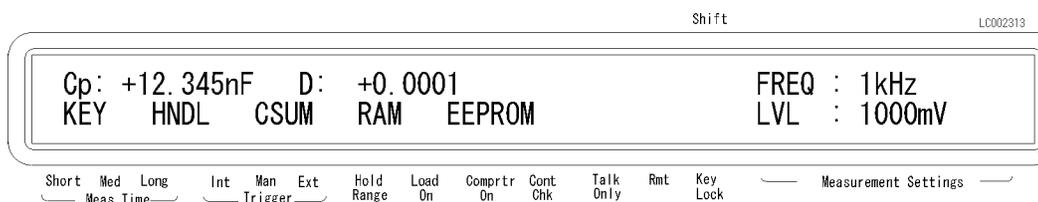

3. Select KEY using  or  and press .

4. Press the front panel key that you want to test.

For example, if you want to test , then press .

When the key functions properly, KEY CODE:5 TRIGGER is displayed. Otherwise, there will be no such display, and the key is not functioning correctly. Contact your nearest Agilent Technologies office.

4263B

5. To exit the front panel key test, press  twice.
6. Select `Exit` and press  to exit.

If You Have a Problem

If the Display is Blank and the 4263B Appears Dead

If the display is blank, and even the annunciators are not ON:

- Check the fuse.

If an Error Message is Displayed

- Refer to “Messages.”

If the 4263B does not Accept Any Key Input

- Check whether the **Rmt** annunciator is ON.
 - Check whether the external controller is disabling all the front-panel controls using the LOCAL LOCKOUT command.

If so, send the LOCAL command from the external controller.

- Press  .
- Check whether the **Key Lock** annunciator is ON.
 - Check whether the handler or the 16064B LED display/trigger box is connected to the 4263B and it locks out the keys.

If so, unlock the keys from the handler or the 16064B.
- Press   .

Function Reference and Technical Information

This chapter provides information on all of the 4263B's functions.

- Front Panel
- Rear Panel
- Technical Information

Front Panel

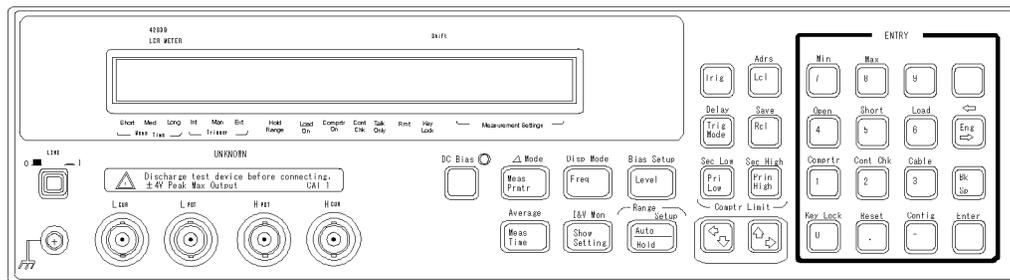

Figure 3-1. Front Panel

Note



In this manual, the blue shift key is expressed as , even though the top of the key is not labeled with the word “blue.”

Display

The display serves two functions — character display and annunciator display. The character display shows the measurement result, instrument setting information, and instrument messages. The 4263B has four measurement display modes. For details about the display mode, refer to “Display Mode Key  ”.

The annunciators (▼) point to the currently selected instrument settings. The annunciator labels are as follows:

Meas Time	Displays the measurement time mode.
Trigger	Indicates the trigger mode setting: Int (Internal trigger mode), Man (Manual trigger mode), or Ext (External trigger mode).
Hold Range	Indicates that the 4263B is in Hold range mode. When this annunciator is not displayed, the 4263B is in Auto range mode.
Load On	Indicates that the LOAD correction is turned ON.
Comprtr On (Comparator On)	Indicates that the comparator function is ON.
Cont Chk (Contact Check)	Indicates that the contact check function is ON.
Talk Only	Indicates that the 4263B is in the Talk Only mode.
Rmt (Remote)	Indicates that the 4263B is in the GPIB remote mode.
Key Lock	Indicates that the 4263B’s front panel keys are locked out.
Shift	Indicates that the  is pressed. (Shift is active.)

4263B

LINE Switch

The LINE Switch turns the 4263B ON or OFF. In the 1(ON) position, power is applied and all operating voltages are applied to the instrument. In the 0(OFF) position, no power is applied and no operating voltages are applied to the instrument.

The 4263B's settings are held in backup memory for about 72 hours after power is turned OFF. The following settings are backed up:

- Test signal frequency
- Test signal level
- DC bias source selection (internal or external)
- DC bias voltage setup
- Measurement parameters
- Deviation measurement mode
- Measurement range mode - Auto or Hold
- Measurement range
- Measurement time
- Averaging rate
- Cable length
- Trigger mode
- Trigger delay
- Contact check function ON/OFF state
- Comparator function ON/OFF state
- Comparator limit value
- Level monitor setting
- Display mode
- Display digits setting

Note



The DC bias ON/OFF state is not saved. At power on, the 4263B sets the DC bias output to OFF.

Note



The 4263B has non-volatile memory (EEPROM) in addition to the backup memory. The data saved to EEPROM such as OPEN/SHORT/LOAD correction data and the beeper mode is not lost when the power is turned off.

Chassis Terminal

The Chassis terminal is tied to the instrument's chassis and can be used for measurements that require guarding.



UNKNOWN Terminals

These are the terminals used to connect a four-terminal-pair test fixture or test leads for measuring DUTs. The connector type is BNC.

Caution



Do *not* apply DC voltage or current to the UNKNOWN terminals. Doing so will damage the 4263B. Before you measure a capacitor, be sure the capacitor is fully discharged.

DC Bias Key

The DC Bias key enables or disables DC Bias output. When DC Bias output is enabled by either the internal DC bias source or the external bias source, the DC Bias ON/OFF indicator turns ON. DC Bias voltage is set using the DC Bias Setup key (refer to “DC Bias Setup Key  ”).

Note The DC bias function is inhibited automatically when the measurement parameter is LS-Rdc, LP-Rdc, or L2-R2 (Option 001 only).



Measurement Parameter Key

Sets the measurement parameters. The measurement parameters are as follows:

Primary	Secondary
Z	θ
Y	θ
R	X
G	B
Cp	D, Q, G, Rp
Cs	D, Q, Rs
Lp	D, Q, G, Rp, Rdc
Ls	D, Q, Rs, Rdc
L2	N, 1/N, M, R2

where,

Z : Absolute value of impedance	Cs : Equivalent series capacitance
Y : Absolute value of admittance	Lp : Equivalent parallel inductance
R : Resistance	Ls : Equivalent series inductance
G : Conductance	L2 : Inductance ¹
Cp : Equivalent parallel capacitance	

¹ These parameters are measured using two-terminal configuration. Use the 16060A Transformer Test Fixture.

Secondary Parameters

θ : Phase angle	Rs : Equivalent series resistance
X : Reactance	Rdc: DC resistance
B : Susceptance	N : Turn ratio of transformer ¹
D : Dissipation factor	1/N: Reciprocal of N ¹
Q : Quality factor	M : Mutual inductance ¹
G : Conductance	R2 : DC resistance ¹
Rp: Equivalent parallel resistance	

¹ These parameters are measured using two-terminal configuration. Use the 16060A Transformer Test Fixture.

Note

- The primary parameter L2 and the secondary parameters Rdc, N, 1/N, M, and R2 can be set only with Option 001 (N / M / DCR measurement function addition) is present. These parameters cannot be set if the 4263B is not equipped with Option 001.
- When performing a measurement with the primary parameter L2 and the corresponding secondary parameters N, 1/N, M, and R2, the transformer measurement setup is required. Refer to “N / M / DCR Parameter Measurement” later in this chapter.

Deviation (Δ) Mode Key

The Deviation (Δ) Mode key selects the deviation measurement mode which displays the difference between the measured value and a reference value. This key is also used for entering the deviation reference value.

The available deviation modes are as follows:

ΔABS mode Displays the difference between the measured value and a reference value. The value is calculated by

$$\text{MeasuredValue} - \text{ReferenceValue}$$

Δ% mode Displays the difference between the measurement value and the reference value as a percentage of the reference value. The value is calculated by

$$\frac{\text{MeasuredValue} - \text{ReferenceValue}}{\text{ReferenceValue}} \times 100$$

Off Turns the deviation measurement mode OFF. (default)

Note

Changing the measurement parameter sets the deviation mode of both the primary and secondary parameters to OFF.

Measurement Time Key

The Measurement Time key sets measurement time mode: SHORT, MED (Medium), or LONG. A longer measurement time produces a more accurate measurement result. The default setting is MED (Medium).

Average Key

The Average key sets the measurement averaging rate. The 4263B automatically averages the measurement result by this rate. The averaging rate can be set from 1 to 256. The default setting is 1.

Frequency Key

The Frequency key sets the test signal frequency value. Available frequency values are:

- 100 Hz
- 120 Hz
- 1 kHz (default)
- 10 kHz (Not available when the cable length setting is 4 m)
- 20 kHz (Not available when the cable length setting is 4 m; Option 002 only)
- 100 kHz (Not available when the cable length setting is 2 m or 4 m)

Display Mode Key

The Display Mode key selects the display mode. The available display modes are as follows:

- Data** Displays the measurement data. (default) When the contact check function is ON and the contact check result fails, N.C. (no-contact) will be displayed instead of the measurement data.
- Comprtr** (When comparator function is ON) Displays the result of the comparison as HI (greater than upper limit), IN (passed), LO (less than lower limit), or N.C. (contact check failed).
(When comparator function is OFF) Displays COMP OFF.
- Off** Turns the display OFF.

Also, if you select **Digit** in this menu, the menu for setting the display digits appears. You can set the display digits of the measurement data to 3, 4 or 5.

Measurement Settings Display Key

Displays the current settings of the 4263B. The settings are sequentially displayed on the right side of the LCD display each time  is pressed. The following information is displayed:

- Test signal frequency and Test signal level
- DC bias value and Averaging rate
- Trigger delay time and Cable length
- Comparator Upper / Lower Limits
- Level monitor value

Level Monitor Key

The level monitor function monitors the actual signal current flowing through the DUT and the actual signal voltage across the DUT. The following four modes are available:

- Off** Does not monitor current or voltage.
- Imon** Monitors current only.
- Vmon** Monitors voltage only.
- Both** Monitors both current and voltage.

4263B

Level Key

Sets the test signal level in the range of 0.02 V to 1 V. If using   or , the test signal level can be set in 0.05 V step. If using the numeric keys, the test signal level can be set in 0.005 V step.

Note If the measurement range is set to 0.1 Ω and the test signal level is changed to less than 0.315 V, the range will be changed to 1 Ω automatically.



DC Bias Setup Key

The DC Bias Setup key sets the DC bias voltage level. The available DC Bias voltage levels are 0 V, 1.5 V, 2 V, and EXT (External source; input from the Ext DC Bias terminal on the rear panel; 0 to 2.5 V).

For details about the external DC bias terminal, refer to “ External DC Bias Terminal”.

Auto/Hold Range Key

The Auto/Hold Range key toggles the measurement range mode between Auto or Hold. The Auto mode allows the instrument to select the optimum range automatically within 5 measurement cycles. In the Hold mode, the 4263B's measurement range is fixed at the range you select. The default setting is Auto. The **Hold Range** annunciator indicates the current mode.

Range Setup Key

The Range Setup key sets the measurement range, according to the following table.

Table 3-1. Measurement Range Selection

Range Setup	Optimum Measurement Range	Measurable Range ¹
1 M Ω ²	1 M Ω \leq Z < 10 M Ω	Z \geq 900k Ω
100 k Ω ²	100 k Ω \leq Z < 1 M Ω	Z \geq 90 k Ω
10 k Ω	10 k Ω \leq Z < 100 k Ω	Z \geq 9 k Ω
1 k Ω	1 k Ω \leq Z < 10 k Ω	Z \geq 900 Ω
100 Ω	10 Ω < Z < 1 k Ω	All
10 Ω	1 Ω < Z \leq 10 Ω	Z \leq 11 Ω
1 Ω	100 m Ω < Z \leq 1 Ω	Z \leq 1.1 Ω
0.1 Ω ³	Z \leq 100 m Ω	Z \leq 110 m Ω

1 Accuracy *not* specified across this full range.

2 Not available when the test signal frequency is 100 kHz.

3 Not available when the test signal level is less than 315 mV.

“OVLD” is displayed on the LCD display when the measured impedance is out of the measurable range.

The 4263B can display measurement result in the following ranges:

Table 3-2. Displayable Range

Parameter	Displayable Range	Parameter	Displayable Range
Z	0.01 m Ω ~ 999.99 M Ω	LS, LP, L1, L2, M	\pm 0.1 nH ~ \pm 999.99 kH
RS, RP, DCR, X	\pm 0.01 m Ω ~ \pm 999.99 M Ω	D	\pm 0.0001 ~ \pm 9.9999
Y	0.1 ns~9999.9 s	Q	\pm 0.1 ~ \pm 9999.9
GS, GP, B	\pm 0.1 ns ~ \pm 9999.9 s	θ	- 180 $^{\circ}$ ~ + 180 $^{\circ}$
CS, CP	\pm 1 fF ~ \pm 9.9999 F	N	\pm 0.9 ~ 999.99

“-----” is displayed on the LCD display when the measurement result is out of the displayable range.

Trigger Key

The Trigger key triggers a measurement when the 4263B is in the Manual trigger mode. See also “Trigger Mode Key  ”.

4263B

Trigger Mode Key

The Trigger Mode key selects the trigger source which is the input that will generate the measurement. The available trigger sources are as follows:

- Int** (Internal) The 4263B is triggered automatically and continuously. (Default)
- Man** (Manual) The 4263B is triggered when the  key is pressed.
- Ext** (External) The 4263B is triggered by a pulse input through the External Trigger terminal or through the handler interface. Refer to “External Trigger Terminal” or “Handler Interface” for detail.
- Bus** (Available only in the GPIB remote mode.) The 4263B is triggered by the GET or *TRG commands through the GPIB.

The trigger mode setting is indicated by the **Trigger** annunciator. (In the Bus trigger mode, the annunciator is not displayed.)

Delay Key

The Delay key sets the trigger delay time between the trigger event and the start of the actual measurement. The available trigger delay time value ranges from 0 to 9.999 s.

Note The delay time definition is different for DC resistance measurement (Ls-Rdc, Lp-Rdc, and L2-R2: Option 001 only). For details, see “Test Current Transient” in this chapter.



Local Key

The Local key returns the 4263B to the local (front-panel) operation from the remote (computer controlled) operation mode. The Local key is the only active front-panel key while the 4263B is in the GPIB remote mode.

Address Key

The Address key sets the 4263B's GPIB address. The available GPIB addresses are the integer numbers 0 to 30, and address 31 is the Talk Only mode in which the 4263B only outputs data through the GPIB interface.

Resetting or powering off doesn't affect the 4263B's address setting.

In Talk Only Mode, the output data format is,

<stat>, *<data1>*, *<data2>*, *<comp1>*, *<comp2>*

Where, *<stat>* : Measurement status

- 0 : Normal
- 1 : Overload
- 2 : No-Contact

<data1> : Measurement data of the primary parameter

<data2> : Measurement data of the secondary parameter

<comp1> : Comparison result of the primary parameter (no output when the comparator is OFF)

<comp2> : Comparison result of the secondary parameter (no output when the comparator is OFF)

- 0 : OFF
- 1 : In
- 2 : High
- 4 : Low
- 8 : No-Contact

Save Key

The Save Key stores the instrument's current settings into non-volatile memory (EEPROM). Saved items are same as ones stored in the back-up memory listed in "LINE Switch" description. Up to 10 sets of instrument settings can be saved. You must enter the register number, 0 to 9, to assign the register into which the settings will be saved.

Caution



The 4263B overwrites the instrument's settings into the assigned register without warning. If settings are already stored in the assigned register, they will be lost.

Recall Key

The Recall Key is used to recall instrument settings saved in non-volatile memory (EEPROM) (see "Save Key  "). You must enter the register number, 0 to 9, from which to recall the settings. If the register selected is empty, the error message "RECALL FAILED" is displayed.

Note



Recalling an 4263B setting doesn't affect the DC bias ON/OFF state.

4263B

Comparator Limit Keys

These keys sets the upper/lower limit for the comparator Pass/Fail test. If  /  is pressed, the menu for setting the primary parameter's lower / upper limit appears.

If   /   is pressed, the menu for setting the secondary parameter's lower / upper limit appears.

Left/Down Arrow Key and Up/Right Arrow Key,

These keys have the following three functions:

- When you enter a setting value, these keys increase or decrease the setting value.
- When you select an item in the selection menu, these keys are used to select the item (the selected item blinks).

0,1,...,9,(Point),-(Minus) Keys, ...

These keys are used to enter parameter values.

Enter Key

The Enter key terminates data input or setting, and returns to the measurement mode.

Shift Key

The Shift key activates the secondary functions printed above the keys.

The shift key toggle is cleared a single execution of a shifted function or by pressing the shift key again.

For example, if   is pressed, the OPEN correction menu is displayed.

The **Shift** annunciator is displayed when the shift key is toggled to the active mode.

Engineering Units Key

The Engineering Units key enters engineering units. The available units are:

f (femto) :	$\times 10^{-15}$	k (kilo) :	$\times 10^3$
p (pico) :	$\times 10^{-12}$	M (mega) :	$\times 10^6$
n (nano) :	$\times 10^{-9}$	G (giga) :	$\times 10^9$
μ (micro) :	$\times 10^{-6}$	T (tera) :	$\times 10^{12}$
m (milli) :	$\times 10^{-3}$		

Pressing  changes the units in increasing order. Pressing   changes the units in decreasing order.

Back Space key 

The Back Space Key deletes a single preceding character of an input value.

Minimum Key  

The Minimum key enters the minimum value during a parameter setting operation.

Maximum Key  

The Maximum key enters the maximum value during a setting operation.

4263B

Open Key



The Open key executes the OPEN correction measurement to obtain the OPEN correction data (OPEN admittance). The 4263B uses this data to cancel the measurement errors due to the stray admittance of the test fixture. The data is stored in non-volatile memory (EEPROM). The OPEN measurement must be done with nothing connected to the test fixture.

The following OPEN correction menu is displayed when   is pressed.

- **OpenMeas** — Performs the OPEN measurement to get the OPEN correction data.
- **MeasVal** — Displays the measured OPEN correction data.
When MeasVal is selected and  is pressed, the 4263B displays the primary parameter G (conductance). Then the 4263B displays the secondary parameter B (susceptance) when  is pressed again.
- **Exit** — Exits the OPEN correction menu.

The OPEN correction data is taken at the following instrument settings:

Test signal frequency :	Sweeping all frequency points (include DC)
Test signal level :	Current setting
DC bias :	OFF
Measurement range :	Auto
Measurement time :	Long
Averaging rate :	1
Trigger delay :	0 s
Cable length :	Current setting

If the OPEN admittance is *not* less than 100 μ S, the 4263B displays

“WARNING: Out Of Limit”

This is only a WARNING message, so the OPEN Correction data will still be used.

OPEN correction data is saved in non-volatile memory (EEPROM), and is cleared when 4263B is reset. It is not cleared when the *RST command was executed from GPIB.

You cannot disable the correction function using the front-panel keys, but you can using the GPIB command. Refer to “[:SENSE]:CORRection[:STATE] { ON | OFF | 1 | 0 }” in Chapter 5.

Short Key

The Short key executes the SHORT correction measurement to obtain the SHORT correction data (SHORT impedance). The 4263B uses this data to cancel the measurement errors due to the residual impedance of the test fixture. The data is stored in non-volatile memory (EEPROM). The SHORT measurement must be done with the high and low terminals shorted together.

If you press   , The following SHORT correction menu is displayed when   is pressed.

- **ShortMeas** — Performs the SHORT measurement to get the SHORT correction data.
- **MeasVal** — Displays the measured SHORT correction data.
When MeasVal is selected and  is pressed, the 4263B displays the primary parameter R (resistance). Then the 4263B displays the secondary parameter X (reactance) when  is pressed again.
- **Exit** — Exits the SHORT correction menu.

The SHORT correction data is taken at the following instrument settings:

Test signal frequency :	Sweeping all frequency points (include DC)
Test signal level :	Current setting
DC Bias :	OFF
Measurement range :	Auto
Measurement time :	Long
Averaging rate :	1
Trigger delay :	0 s
Cable length :	Current setting

If the SHORT impedance is *not* less than 10 Ω , the 4263B displays

“WARNING: Out Of Limit”

This is only a WARNING message, so the SHORT correction data will still be used.

SHORT correction data is saved in non-volatile memory (EEPROM), and is cleared when 4263B is reset. It is not cleared when the *RST command was executed from GPIB.

You cannot disable the Correction function using the front-panel keys, but you can using the GPIB commands. Refer to “[:SENSe]:CORRection[:STATe] { ON | OFF | 1 | 0 }” in Chapter 5.

Note



When performing transformer measurement (L2-N, L2-1/N, L2-M, or L2-R2), the SHORT correction function does not work effectively. For details, refer to “Transformer Parameters Measurement”.

4263B

Load Key

The Load Key executes the LOAD correction. The LOAD correction is performed by connecting a LOAD standard device which has been previously measured. By performing the LOAD correction in addition to the OPEN/SHORT correction, the 4263B can remove measurement error resulting from the complex residual impedance which cannot be completely removed by the OPEN/SHORT correction.

The LOAD correction is not necessary when performing a measurement by directly connecting an Agilent test fixture to the 4263B.

The following LOAD correction menu is displayed when   is pressed.

- **On/Off** – The menu to toggle ON/OFF of the LOAD correction

If you select On/Off, the following menu appears.

- On** Turns ON the LOAD correction. **Load On** annunciator appears.
- Off** Turns OFF the LOAD correction. **Load On** annunciator disappears.

- **LoadMeas** – Measures the LOAD standard to get the LOAD correction data.

- **Corval** – The menu for entering the LOAD standard's reference value

If you select CorVal, the following menu appears.

- PrmSlct** The menu for selecting the parameter model of the LOAD standard
If you select PrmSlct, the menu for selecting the primary parameter and the secondary parameter will appear in turn.
For example, when the LOAD standard has been assigned a value of Cp-D, Cp is selected here for the primary parameter, and D is selected here for the secondary parameter.
- RefEnt** The menu for entering the LOAD reference value
If you select RefEnt, the menu for entering the reference value of the primary parameter and the secondary parameter will appear in turn. Enter the LOAD reference value here.
- MeasVal** Displays the measured LOAD correction data.
If you select MeasVal, the primary and secondary parameters of the measured LOAD correction data will be displayed in turn.
- Exit** Exits this menu and return to the LOAD correction main menu.

- **Exit** – Exits the LOAD correction main menu.

The LOAD standard measurement is executed with the following settings.

Test Signal Frequency	Current setting
Test Signal Level	Current setting
DC Bias	OFF
Measurement Range	Auto
Measurement Time	LONG
Averaging Rate	1
Trigger Delay Time	0s
Cable Length	Current setting

If the difference between the LOAD measurement value and reference value is more than 20 %, the 4263B displays

“WARNING: Out Of Limit”

This is only a WARNING message, so the LOAD correction data will still be used.

The LOAD correction data is saved in non-volatile memory (EEPROM), and is cleared when the 4263B is reset. It is not cleared when the *RST command was executed from GPIB.

Comparator Key

The Comparator key toggles the comparator function ON and OFF. The comparator determines whether the measurement result (displayed value) is within the upper and lower limits set by the Primary and Secondary Comparator Limit keys. When the comparator function is ON, the **Comptr On** annunciator will be displayed. The comparison results can be displayed on the LCD display, can be output to the handler interface, or can be revealed by the beeper.

The comparator will yield one of the following results:

HI (high) : Greater than upper limit
 IN (in) : Between the upper limit and lower limit
 LO (low) : Less than lower limit
 N.C. (no-contact) : Contact check failed (at contact check ON state)

In addition, these results are transmitted to the following destinations:

Destination	Condition
Comparison Display :	HI, IN, LO, N.C.
Handler Interface :	HI, IN, LO, N.C.
Beep (FAIL mode) :	HI, LO, N.C.
(PASS mode) :	IN

Note When the measurement parameter or the deviation mode is changed, the comparator function is automatically turned OFF.



Contact Check Key

The Contact Check key toggles the contact check function ON and OFF. This function monitors whether the DUT is properly connected to the test electrodes.

When the contact check fails,

- N.C. (No-Contact) will be displayed on the LCD display.
- The measurement status of the GPIB output data is set to 2 (No-Contact). Refer to “Address Key   ” for the GPIB output data.
- The /NO CONTACT pin of the handler interface is asserted. Refer to “Handler Interface” for the pin assignment of the handler interface.
- The measurement is still performed, but the measurement result is output to the GPIB interface and the handler interface.

To detect a no-contact condition correctly, the OPEN and SHORT corrections must be performed properly. Because the contact check function uses the values taken by the OPEN and SHORT corrections as reference values.

The available range of the contact check function is restricted as follows:

Measurement Range Setup	Contact Check Available Range
0.1 Ω	5 m Ω < Z < 0.11 Ω
1 Ω	50 m Ω < Z < 1.1 Ω
10 Ω	500 m Ω < Z < 11 Ω
100 Ω	5 Ω < Z < 2 k Ω
1 k Ω	900 Ω < Z < 20 k Ω
10 k Ω	9 k Ω \leq Z < 200 k Ω
100 k Ω	90 k Ω \leq Z < 2 M Ω
1 M Ω	900 k Ω < Z < 20 M Ω

For the DUTs which are out of these ranges, the contact check result will always be N.C..

Note

The contact check function is not available with the transformer measurement parameters, L2-N, L2-1/N, L2-M, and L2-R2 (parameters available with Option 001 only).

Cable Key

The Cable key allows you to accurately extend your measurement or reference plane. Parasitics and phase shift due to the cable are automatically removed with the Cable key. The 4263B has four reference plane as follows:

Cable Length	Reference Plane	Available Frequency Range
0 m ¹	UNKNOWN Terminal	100 Hz, 120 Hz, 1 kHz, 10 kHz, 20 kHz ² , 100 kHz
1 m	Termination of 16089A/B/C/D	100 Hz, 120 Hz, 1 kHz, 10 kHz, 20 kHz ² , 100 kHz
2 m	Termination of 16048D	100 Hz, 120 Hz, 1 kHz, 10 kHz, 20 kHz ²
4 m	Termination of 16048E	100 Hz, 120 Hz, 1 kHz

1 Default

2 Option 002 only

Note



- In the 2 m and 4 m settings, the 4263B has limits on the usable test signal frequency. If changing the cable length causes the frequency limits to be exceeded, the 4263B will set the frequency to the maximum frequency which is within the frequency limits for the selected cable length.
- To use this function, you must use the Agilent's test leads. Refer to "Accessories Available" in Chapter 1 for applicable test leads and their length.

Key Lock Key

The Key lock key locks out all front panel keys input except for this key. To cancel the key lock condition, press   again. The key lock state is indicated by the annunciator.

Note



The Key lock state can also be controlled from the handler interface. When the Key lock state is set by the handler, all front panel keys, including   , will be locked. In this case, the Key lock state can only be released by the handler.

4263B

Reset Key  

The Reset key resets all instrument settings and Correction data to the default values. The default settings are as follows:

Item	Reset key	:SYST:PRES ¹	*RST ¹	Stored in
Test signal frequency	1 kHz	←	←	Back-up memory
Test signal level	1 V	←	←	Back-up memory
Measurement parameter	Cp-D	←	←	Back-up memory
Deviation measurement	OFF	←	←	Back-up memory
Deviation reference values	Cleared	←	←	Back-up memory
Measurement range	Auto	←	←	Back-up memory
Measurement time mode	Medium	←	←	Back-up memory
Averaging rate	1	←	←	Back-up memory
Trigger mode	Internal	←	←	Back-up memory
Trigger delay time	0 s	←	←	Back-up memory
Contact Check ON/OFF state	OFF	←	←	Back-up memory
Comparator ON/OFF state	OFF	←	←	Back-up memory
Comparator limits	Cleared	←	←	Back-up memory
Display mode	Measure Display	←	←	Back-up memory
DC bias source	Internal	←	←	Back-up memory
DC bias setup	0 V	←	←	Back-up memory
DC bias ON/OFF state	OFF	←	←	None
Correction ON/OFF state	ON	←	OFF	None
Correction method	OPEN/SHORT	←	←	EEPROM
Correction data	Cleared	←	No effect	EEPROM
Cable length	0 m	←	←	EEPROM
Beep ON/OFF state	ON	←	←	EEPROM
Beep mode	FAIL mode	←	←	EEPROM
Data transfer format	ASCII	←	←	EEPROM
Power line frequency	No effect	←	←	EEPROM
GPIB Address	No effect	←	←	EEPROM
Key lock	N/A	No effect	OFF	None
:INIT:CONT	ON	←	OFF	None

¹ “←” indicates the value is the same as what’s indicated to the left.

Configuration Key

The Configuration key allows you to set the beeper mode, choose the power line frequency and to execute service functions and the self-test.

- **Beep** — Comparison results output to the beeper are classified into following modes:

OFF	Does not emit a beep (no output to beeper).
PASS	Emits a beep when the comparison result is IN.
FAIL	Emits a beep when the comparison result is HI, LO, or N.C.. (default)

Note In the OFF mode, the 4263B does *not* emit a beep when the system error or operation error occurs.



- **Line** — Available power line frequencies are 50 Hz and 60 Hz.
- **Svc** — There are five service functions.

KEY	Tests the front-panel keys.
HNDL	Tests the handler output signal.
CSUM	Runs ROM check sum program.
RAM	Tests RAM (the read-write test). After the test, the 4263B resets the instrument's settings.
EEPROM	Tests EEPROM. The data stored in EEPROM is not affected when no error is detected. If errors are detected, the 4263B clears the data and restores the default data.
- **Test (Self-test)** — The self-test tests the 4263B's basic performance and displays the results as the sum of the error codes of each existing error. The 4263B also executes its self-test when it is turned ON (power-on test). The settings of the 4263B are not affected by the self-test, except when errors occur (See below).

Item	Result	Error Code
1. Beeper	Emits a beep	—
2. Display	Display all digits and segments	—
3. RAM	Displays an error message if an error occurs ¹	1
4. EPROM	Displays an error message if an error occurs ¹	2
5. Calibration data (EEPROM)	Displays an error message if an error occurs ¹	4
6. User's data (EEPROM)	Displays an error message if an error occurs ²	8
7. AD converter	Displays an error message if an error occurs ¹	16
8. Backup RAM	Displays an error message if an error occurs ²	32

¹ During the power-on test, the 4263B stops operation if an error occurs.

² During the power-on test, the 4263B takes its default values, and continues the test

Rear Panel

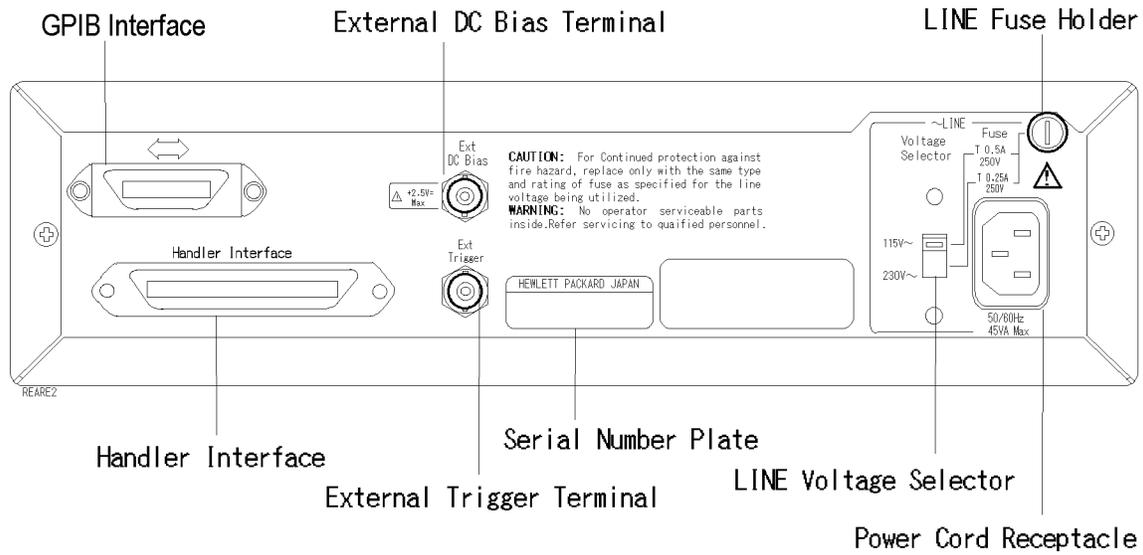

Figure 3-2. Rear Panel

External Trigger Terminal

The Ext (External) Trigger terminal is used to trigger 4263B by inputting a positive-going TTL pulse, when the 4263B is set to external trigger mode. Figure 3-3 shows the specifications required for the TTL pulse.

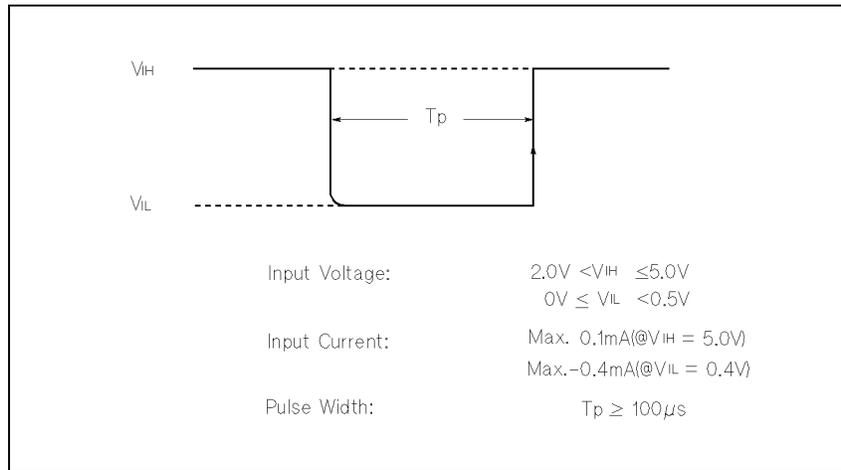

Figure 3-3. Required External Trigger Pulse Specification

External DC Bias Terminal

The Ext (External) DC Bias terminal is used to input a DC bias from an external source when DC bias setup is set to Ext. The external voltage range is 0 V to +2.5 V.

Caution Do not apply External DC bias voltage more than +2.5 V. Doing so will damage the 4263B



LINE Fuse Holder

The 4263B's line fuse is selected depending on the LINE Voltage selection. Refer to Table 3-3

LINE Voltage Selector

The Line Voltage Selector is used to match the 4263B to the power line voltage being used. The line voltage selections are as follows:

Table 3-3. Line Voltage selection

Voltage Selector	Line Voltage	Required Fuse
115V	100/120Vac($\pm 10\%$)	UL/CSA type, Time delay 0.5A 250V (Agilent part number 2110-0202)
230V	220/240Vac($\pm 10\%$)	UL CSA type, Time delay 0.25A 250V (Agilent part number 2110-0201)

Serial Number Plate

The Serial Number Plate provides manufacturing information about the instrument. For details, see "Serial Number" in Figure A-1.

Power Cord Receptacle

The Power Cord Receptacle is used to plug in the power cord.

Power Code

The 4263B is equipped with a three-conductor power cord that, when plugged into the appropriate AC power receptacle, grounds the instrument. The offset pin on the power cord is the safety ground.

Handler Interface

The handler interface is used to synchronize timing with an external handler.

Before using the handler interface, you must connect pull-up resistors to enable the output signals and set the dip switch to select the voltage level to match the input signals. Refer to Appendix B for these procedures.

Specification

Output signal: Negative TRUE, open collector, opto-isolated

Decision output:

Primary parameter comparator: High (HI), In (IN), Low (LO)

Secondary parameter comparator: High (HI), In (IN), Low (LO)

DUT and test electrode's contact failed (N.C.).

Index: Analog measurement complete

Measurement complete: Full measurement complete

Alarm: Notification that a momentary power failure or an error was detected.

Input Signal: Opto-isolated

Keylock: Front panel keyboard lockout

External Trigger: Pulse width $\geq 1 \mu s$

Note



The comparator output signals High, In, Low, and the control signals /INDEX, /EOM are available when the comparator function is ON. And the contact check output signal N.C. is available when both the comparator and contact check functions are ON.

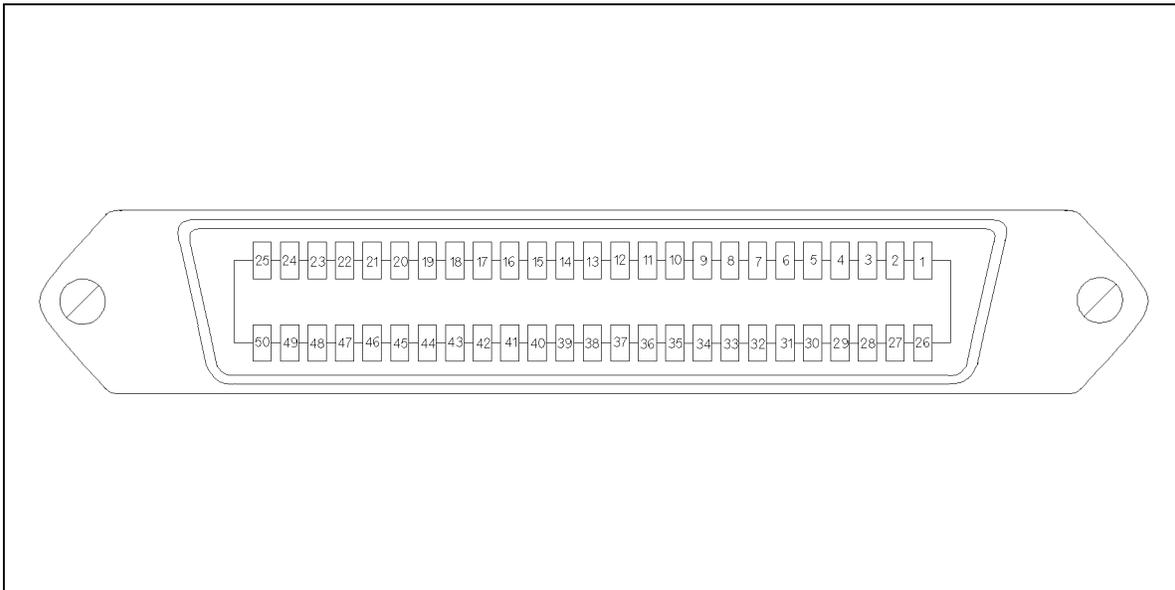

L5003006

Figure 3-4. Pin Assignment of Handler Interface Connector

Table 3-4. Pin Assignment of Handler Interface Connector

Pin No.	Signal Name ¹	Description
1 2	EXT DCV1 EXT DCV1	External DC Voltage 1 : DC Voltage supply pins for DC isolated open collector outputs (/PHI, /SHI, /PIN, /SIN, /PLO, /SLO, /NO CONTACT). Maximum voltage is +24 V, minimum +5 V.
18	/KEY LOCK	Key Lock : When this line is asserted, all of the 4263B's front panel key functions are disabled.
19	/EXT TRIG	External Trigger : 4263B is triggered on the rising edge of a pulse applied to this pin, when the trigger mode is set to External. ²
20 21	EXT DCV2 EXT DCV2	External DC voltage 2 : DC voltage supply pins for DC Isolated inputs (/EXT TRIG, /KEY LOCK) and DC Isolated outputs (/ALARM, /INDEX, /EOM). The maximum voltage is +15 V, minimum +5 V.
24 25	+5 V +5 V	Internal voltage supply (max. output 0.1 A): Exceeding 0.1 A will cause the internal voltage output and the output signals to go to zero.
26 27	COM1 COM1	Common for EXT DCV1.
28	/PHI	This signal is asserted, when the comparison result of the primary parameter is High. ³
29	/PIN	This signal is asserted, when the comparison result of the primary parameter is In. ³
30	/PLO	This signal is asserted, when the comparison result of the primary parameter is Low. ³
31	/SHI	This signal is asserted, when the comparison result of the secondary parameter is High. ³
32	/SIN	This signal is asserted, when the comparison result of the secondary parameter is In. ³
33	/SLO	This signal is asserted, when the comparison result of the secondary parameter is Low. ³
37	/NO CONTACT	This signal is asserted, when the contact check failed. ³
42	/ALARM	Alarm : This signal is asserted, when a power failure occurs or the error (E11, E12, E13, E14, E15, E20, or E-313) occurs.
43	/INDEX	Index : This signal is asserted, when an analog measurement is complete and the 4263B is ready for the next DUT to be connected to the UNKNOWN terminals. The measurement data, however, is not valid until the line /EOM is asserted. ³
44	/EOM	End of Measurement : This signal is asserted, when the measurement data and comparison results are valid. ³
45 46	COM2 COM2	Common for EXT DCV2.
49 50	GND GND	Ground tied to chassis.

1 The / (slash) means that the signal is asserted when LOW.

2 If an error occurs and the 4263B stops operation, the 4263B will not trigger a measurement if it receives the /EXT TRIG signal.

3 If an error occurs and the 4263B stops operation, these lines retain the condition that existed just before the error occurs.

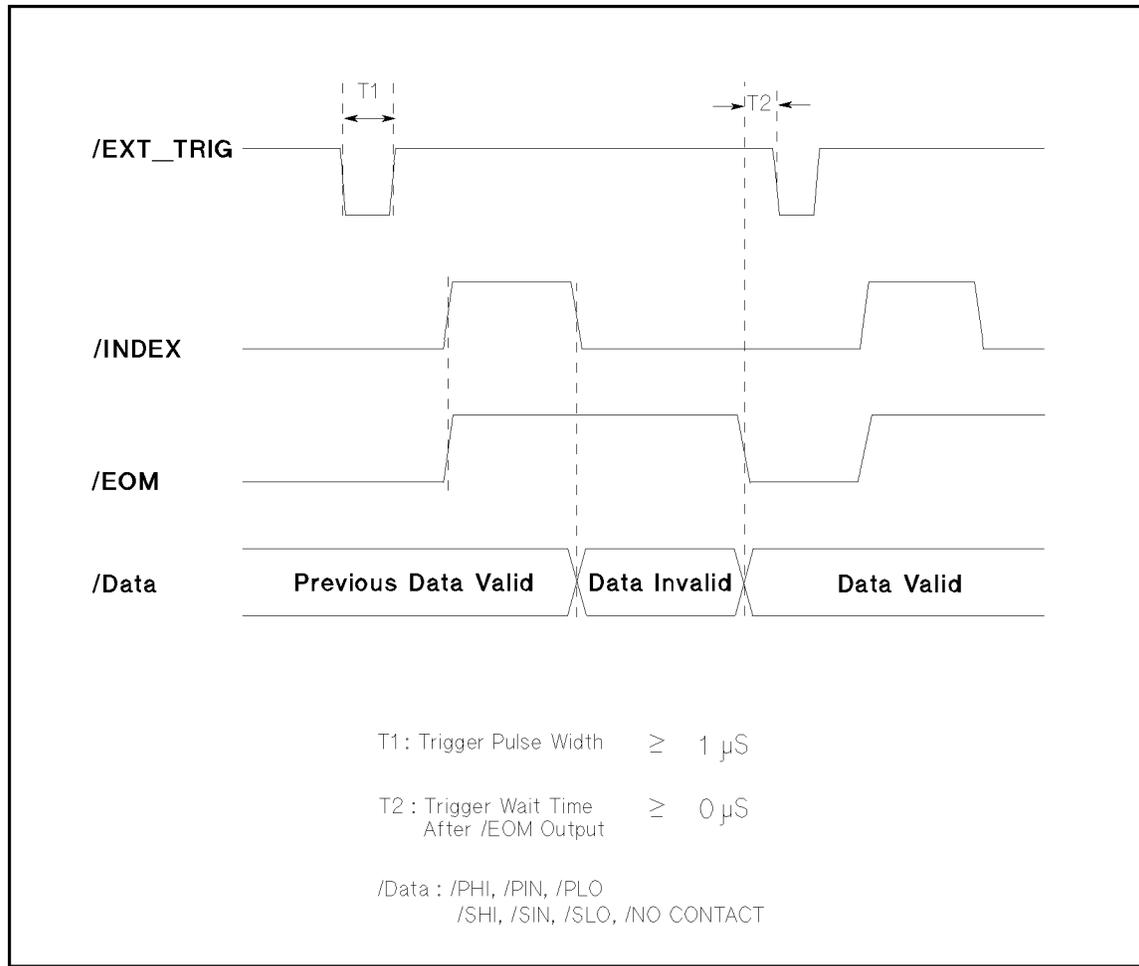

Figure 3-5. Timing Diagram

Note



This timing diagram is also applied when the contact check fails. Because the measurement is performed and the measurement result is output, even if the contact check fails.

GPIB Interface

GPIB Interface is used for remote control of the 4263B using the General Purpose Interface Bus (GPIB).

GPIB is a standard for interfacing instruments to computers, and supports for IEEE 488.1, IEEE 788.2, IEC-625, and JIS-C1901. GPIB allows instruments to be controlled by an external computer which sends commands or instructions to and receives data from the instrument.

With the GPIB system, many different types of devices including instruments, computers, plotters and printers can be connected in parallel. When configuring an GPIB system, the following restrictions must be adhered to:

- The length of cable between one device and another must be less than or equal to four meters. The total length of cables in one bus system must be less than or equal to two meters times the number of devices connected on the bus (the GPIB controller counts as one device), and must not exceed 20 meters.
- A maximum of 15 devices can be connected on one bus system.
- There are no restrictions on how the cables are connected together. However, it is recommended that no more than four piggyback connectors be stacked together on any one device, or else the resulting structure could exert enough force on the connectors mounting to damage it.

Every GPIB device has its own unique identification address. The available GPIB addresses are the integer numbers from 0 to 30. Every device on an GPIB bus must have a unique address.

All devices on the GPIB must be able to perform one or more of the following interface functions:

Talker	When specified to talk, a talker transmits device dependent data. There can only be one active talker in an GPIB system at any given time.
Listener	When specified to listen, a listener receives device dependent data. There can be multiple active listeners in an GPIB system simultaneously.
Controller	A controller manages the bus, and specifies talkers and listeners. There can only be one active controller in an GPIB system at any given time.

Table 3-5 lists the 4263B capability and functions. These functions provide the means for an instrument to receive, process, and transmit commands, data, and status over the GPIB bus.

Table 3-5. GPIB Interface Capability

Cord	Function
SH1	Complete source handshake capability
AH1	Complete acceptor handshake capability
T5	Basic Talker; Serial poll; Unaddressed if MLA; Talk Only
L4	Basic listener; Unaddressed if MTA; No Listen Only
SR1	Service request capability
RL1	Remote/local capability
DC1	Device Clear capability
DT1	Device trigger capability
C0	No controller capability
E1	Drivers are open-collector

Technical Information

This section discusses the 4263B's theory of operation and the technical information.

Overall Impedance Measurement Theory

The 4263B measures the impedance of the Device Under Test (DUT) in the following manner:

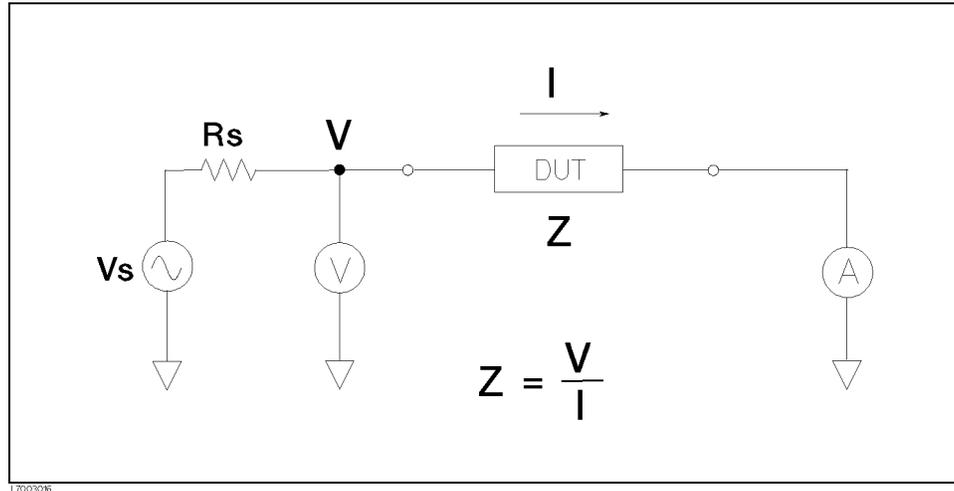

Figure 3-6. Simplified Model of Impedance Measurement

Figure 3-6 shows the simplified model of the 4263B impedance measurement. V_s is the test signal level (voltage) and R_s is the source resistance. If the current across the DUT is I when a test signal voltage V is applied, the DUT's impedance, Z , is expressed by,

$$Z = \frac{V}{I}$$

About the current level across the DUT, I , refer to "Test Current Level".

Impedance, Z , contains real and imaginary parts. Figure 3-7 shows vector representation of impedance.

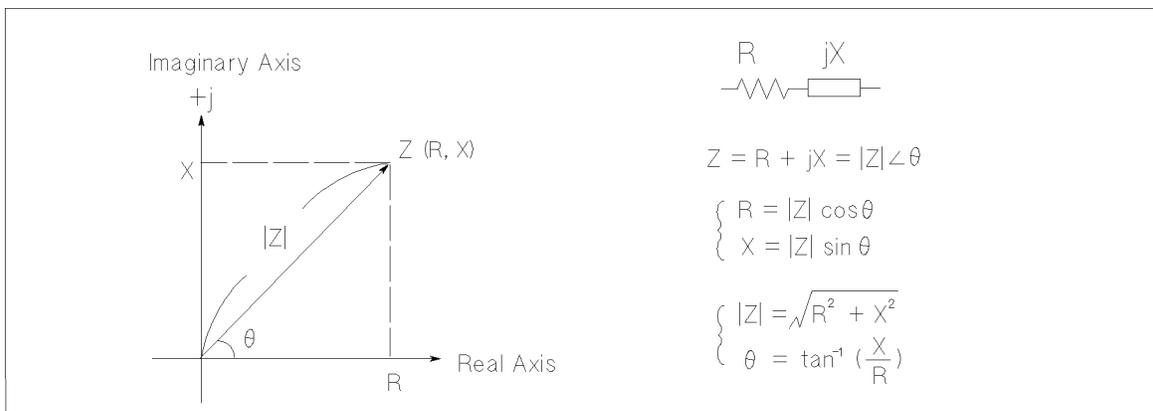

Figure 3-7. Vector Representation of Impedance

In Figure 3-7,

- | | | | |
|-----|------------|------------|-----------------------------|
| R : | Resistance | Z : | Absolute value of impedance |
| X : | Reactance | θ : | Phase of impedance |

Note The 4263B denotes the absolute value |Z| of impedance with Z.



Impedance, Z, can also be expressed as admittance, Y. Admittance is expressed in terms of impedance, Z, as follows:

$$Y = \frac{1}{Z}$$

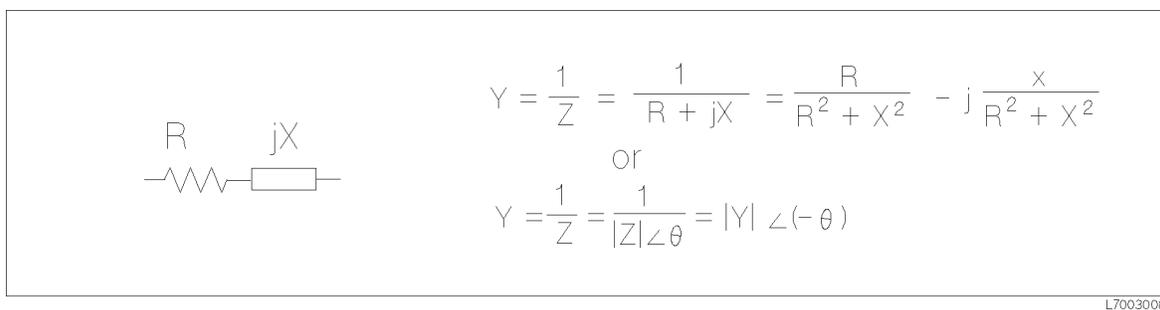

Figure 3-8. Relationship Between Impedance and Admittance

For parallel connected circuits, it is better to use admittance, Y.

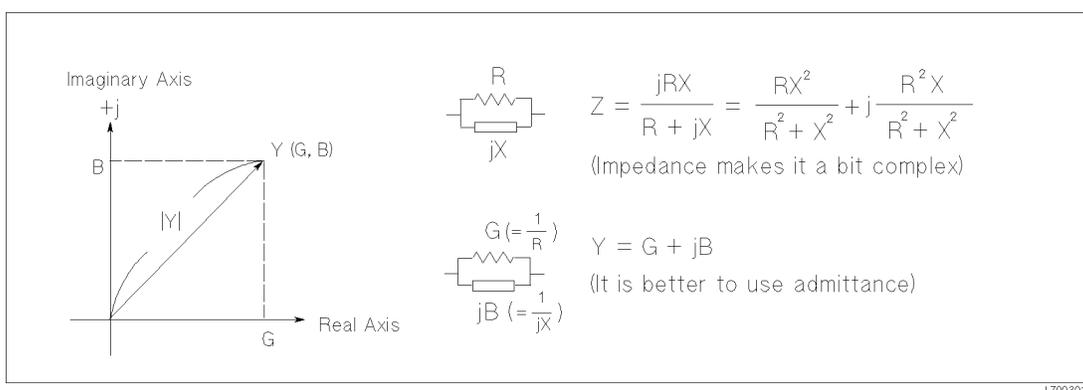

Figure 3-9. Vector Representation of Admittance

In Figure 3-9,

- | | | | |
|-----|-------------|------|------------------------------|
| G : | Conductance | Y : | Absolute value of admittance |
| B : | Susceptance | | |

Note

The 4263B denotes the absolute value $|Y|$ of admittance with Y.



The 4263B measures a DUT's impedance, Z, which is a vector value, and gives the result using the following equivalent circuits:

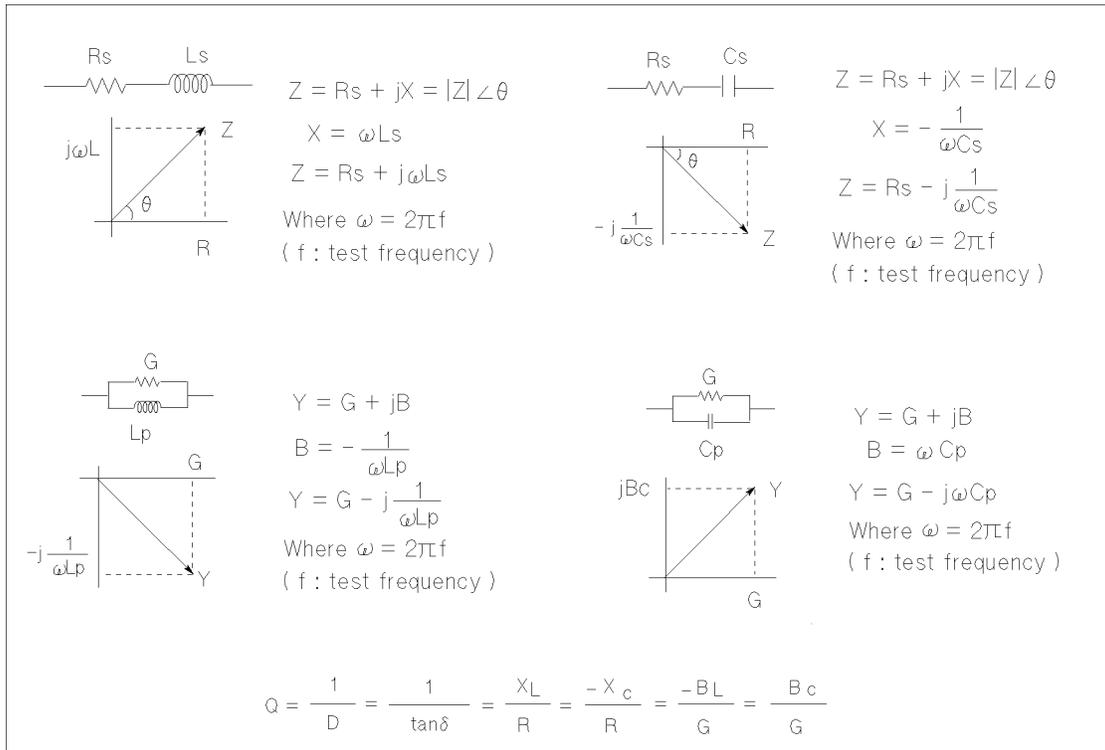

Figure 3-10. Relationship between Measurement Parameters

In Figure 3-10,

- | | | | |
|------|--------------------------------|------|---------------------------------|
| Ls : | Equivalent series inductance | Cp : | Equivalent parallel capacitance |
| Lp : | Equivalent parallel inductance | Q : | Quality factor |
| Cs : | Equivalent series capacitance | D : | Dissipation Factor |

Transformer Parameters Measurement

Note This function only applies to the 4263B with option 001.



- DCR measurement — L_s -Rdc, L_p -Rdc

Where,

L_s : Equivalent series inductance Rdc : DC resistance
 L_p : Equivalent parallel inductance

The 4263B has an internal DC voltage source for DCR measurement. The DC voltage level is 2 V. The 4263B switches test signal source to DC for DC Resistance measurement, and to AC for LS or LP measurement.

- Transformer measurement — L_2 -N, L_2 -1/N, L_2 -M, L_2 -R2

Where,

L_2 : Inductance¹ M : Mutual inductance¹
 R_2 : DC resistance¹ N : Turns ratio¹

¹ These parameters are measured using two-terminal configuration.

L_2 and R_2 represents the characteristics of the inductor connected to H_{CUR} shown in Figure 3-11. The DC voltage level for measurement of R_2 is 2 V, same as DCR measurement described above.

For the transformer parameters measurement, the following measurement configuration is required:

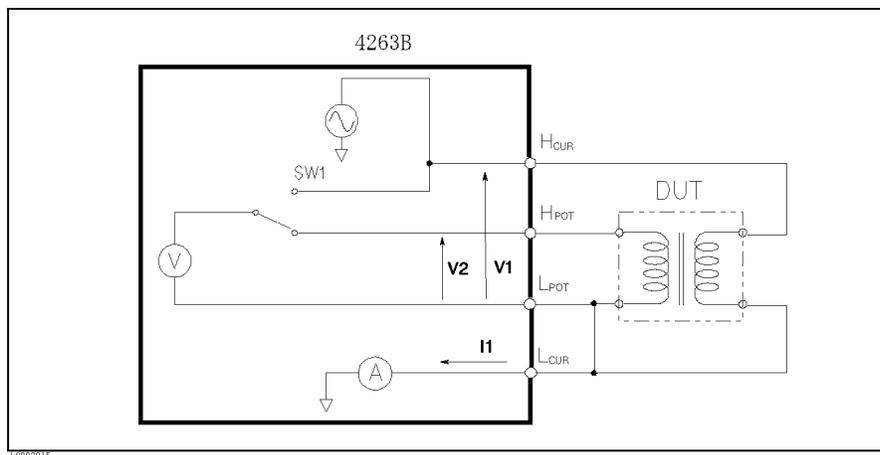

Figure 3-11. Basic Transformer Measurement Setup

Warning

While H_{CUR} terminal of the 4263B is connected to a terminal of the transformer, high-voltage can be induced at the other terminals. For safe operation, when connecting or disconnecting a transformer, connect the transformer leads in the following order:

- Connect transformer, first to L_{POT} , L_{CUR} , and H_{POT} terminals, and then connect the H_{CUR} terminal last.
- Disconnect the transformer from the H_{CUR} terminal first, and then the H_{POT} , L_{POT} , and L_{CUR} terminals.

In Figure 3-11, one side of the transformer is connected to H_{CUR} and L_{CUR} terminals, and the other side to the H_{POT} and L_{POT} terminals. The L_{CUR} and L_{POT} terminals are connected in common. You can get this configuration conveniently when using the 16060A Transformer Test Fixture.

When measuring N , the 4263B measures both voltages at H_{CUR} ($V1$) and at H_{POT} ($V2$), while applying an AC voltage to H_{CUR} . For both voltage measurements, SW1 switches (in Figure 3-11) to H_{CUR} and H_{POT} . The 4263B calculates N from the ratio of these two voltages.

When measuring M , the 4263B measures the voltage at H_{POT} ($V2$) and the current input to L_{CUR} ($I1$). The 4263B calculates M from the ratio of $V2$ and $I1$.

Note

The 4263B can only measure $N \geq 1$. So, to measure N , connect the transformer side with the more turns to the H_{CUR} terminal.

Note

The configuration shown in Figure 3-11 is a two-terminal configuration, while the 4263B's normal measurement configuration is a four-terminal pair (for details, refer to "Four-Terminal Pair Configuration" in Chapter 7).

Note

The 4263B's correction function is designed for four-terminal pair configurations. For transformer measurements, which uses a two-terminal configuration, the SHORT correction does not work effectively. In place of the SHORT correction, you can use the deviation measurement to cancel the test leads residual impedance.

The effective measurement error correction methods selection are as follows:

Parameter	OPEN Correction	SHORT Correction	(Deviation Measurement ¹)	LOAD Correction
L2	effective	not so effective	(more effective)	effective
R2	effective	not so effective	(more effective)	not effective
M	effective	effective	—	effective
N	not effective	not effective	—	not effective

¹ Take SHORT measurement data as the reference value of the deviation measurement and display the deviation.

For an example using the deviation measurement, refer to "Measuring Transformers" in Chapter 6.

Test Current Level

Figure 3-6 shows the 4263B's simplified model. The actual current level applied to a DUT depends on the test signal level (V_s), the DUT's impedance value (Z), and the 4263B's source resistance (R_s) which is in series with the DUT. The actual current level (I) through the DUT is calculated using the following equations.

There are two different equations according to which voltage source is used: AC or DC.

- Impedance Measurement — The test signal source is AC, and the actual test current level can be obtained as follows:

R_s is selected by the 4263B's measurement range setting.

Measurement Range Setting	R_s
0.1 Ω and 1 Ω	25 Ω
10 Ω to 1 M Ω	100 Ω

I is calculated using following equation:

$$I = \frac{V_s}{Z + R_s}$$

- DC Resistance Measurement (Option 001 only) — When doing the DC Resistance measurement (LS-DCR, LP-DCR, or L2-R2), the 4263B switches the test signal source from AC to DC (the DC voltage source is ± 2 V).

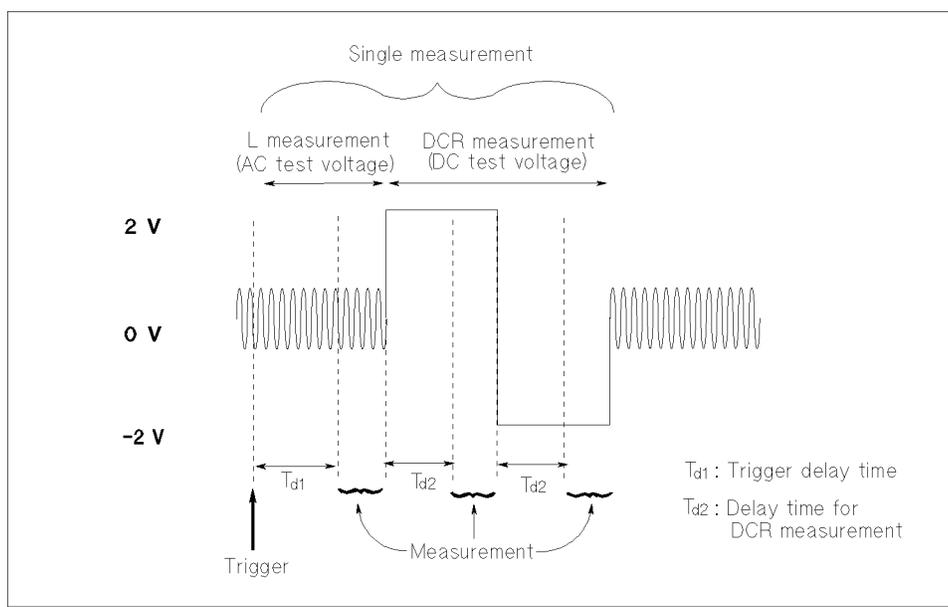

Figure 3-12. Test Signal for DCR Measurement

Figure 3-12 shows the test signal for a DC resistance measurement. For a DC resistance measurement, the 4263B measures inductance, LS, LP, or L2, while applying an AC test signal, and then measures the DC resistance, DCR or R2, while applying a DC test signal. The 4263B measures DC resistances two times, switching the test signal level to +2 V and then to -2 V, and then calculates the DC resistance value. This method cancels the offset error of the DC voltage source.

4263B

When measuring DCR or R2, the actual test current level through the DUT can be obtained as follows:

The source resistance, R_s , is selected by measured the DUT's resistance value, R_{DUT} .

DC Resistance Value	R_s
$0 \Omega \leq R_{DUT} \leq 1 \Omega$	25 Ω
$1 \Omega < R_{DUT}$	100 Ω

The actual current value, I , is calculated using the following equation:

$$I = \frac{\pm 2}{R_{DUT} + R_s}$$

Test Current Transient

When measuring the DC resistance of a DUT that has reactive characteristics, you must pay attention to the transient phenomena of the measurement circuit.

Figure 3-13 shows the transient current of L - DC Resistance measurement.

The measurement circuit for a inductance measurement is shown in simplified form in Figure 3-13 (a). The equivalent model of the DUT is series R-L.

The test signal, $E(t)$, shown in Figure 3-13 (b), is applied to the measurement circuit and test current $I(t)$ flows as shown in Figure 3-13 (b).

If the DUT's time constant, which is obtained by $\frac{L}{R}$, is large, it will take a long time for the test signal to reach a steady state, which is expressed by the dotted line in Figure 3-13 (b).

The 4263B has measurement delay times, Td_1 or Td_2 , at each point when the test signal level changes. Td_1 is the trigger delay time, which is set by the delay key (refer to "Delay Key



”). Td_2 is decided as follows:

Trigger Delay Setting (Td_1)	Delay Time in DC Resistance Measurement (Td_2)
$0 \leq td_1 \leq 40 \text{ ms}$	40 ms
$40 \text{ ms} < td_1$	$Td_2 = Td_1$

You must set the delay time so that the measurement will be started when the test signal has reached a steady state. For selection of delay time, depending on the L, refer to "Measuring High Inductance Transformers" in Chapter 6.

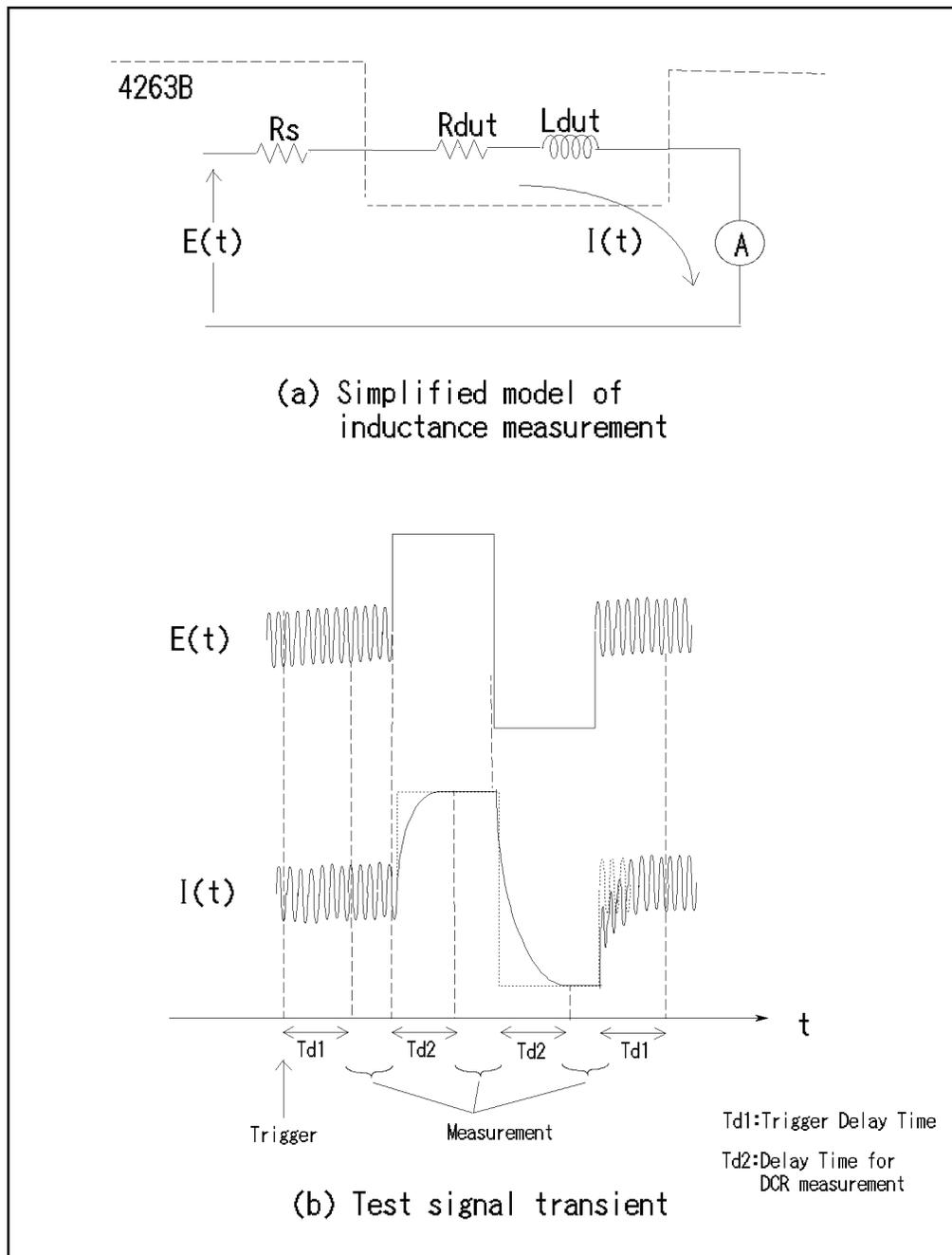

LC0E3117

Figure 3-13. Test Signal Transient in DC Resistance Measurement

Remote Operation (To Control from a Computer)

This chapter provides step-by-step instructions for controlling the 4263B using GPIB remote mode. The examples in this manual use the HP 9000 series 200 or 300 BASIC language. This chapter covers the following:

- Getting started
- Setting up the 4263B
- Triggering a measurement
- Retrieving measurement data
- Other features
- If you have a problem

Refer to Chapter 5 for the description of each GPIB command.

Note



This chapter is not intended to teach BASIC programming language or the Standard Commands for Programmable Instruments (SCPI) programming, or to discuss GPIB theory; refer to the following documents which are better suited for these tasks.

For more information concerning BASIC, refer to the manual set for the BASIC version being used:

BASIC Programming Techniques
BASIC Language Reference

For more information concerning SCPI, refer to the following:

Beginner's Guide to SCPI

For more information concerning GPIB operation, refer to the following:

BASIC Interfacing Techniques
Tutorial Description of the General Purpose Interface Bus
Condensed Description of the General Purpose Interface Bus

Getting Started

This section will teach you the basics of operating the 4263B in GPIB remote mode (from now on referred to as remote). This includes reading the GPIB address, sending commands to the 4263B, and retrieving data from the 4263B.

Input/Output Statements

The statements used to operate the 4263B in remote depend on the computer and the programming language being used. In particular, you need to know the statements the language uses to input and output information. For example, the input statements for the HP 9000 series 200 or 300 BASIC language are:

ENTER or TRANSFER

The output statement is:

OUTPUT

Read your computer manuals to find out which statements you need to use.

Reading the GPIB Address

Before you can operate the 4263B in remote, you need to know its GPIB address (factory setting=17). To check the address, press  . A typical display is:

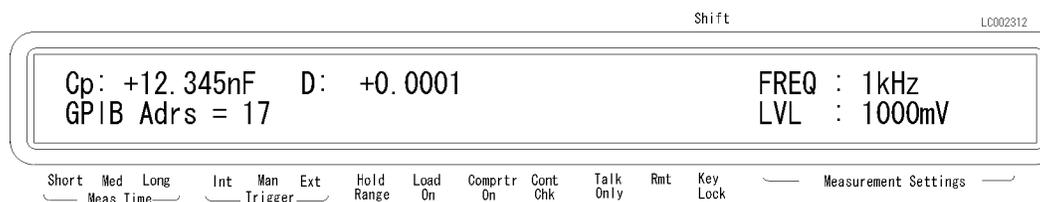

The displayed response is the device address. When sending a remote command, you append this address to the GPIB interface's select code (normally 7). For example, if the select code is 7 and the device address is 17, the appended combination is 717.

Every device on the GPIB bus must have a unique address. You can assign new GPIB addresses.

Sending a Remote Command

To send a remote command to the 4263B, combine the computer's output statement with the GPIB select code, the device address, and finally the 4263B command. For example, to reset the 4263B, send:

```
OUTPUT 717;"*RST"
```

Notice that the **Rmt** annunciator is ON. This means the 4263B is in the remote mode.

4263B

Returning to Local Mode

When you press a key on the 4263B's keyboard while operating in remote, the 4263B does not respond. This is because in remote (as indicated by the display's **Rmt** annunciator) the 4263B ignores all front panel inputs except the  key. To return the 4263B to the Local mode,

press the  .

Query Commands

There are several commands in the alphabetic command directory that end with a question mark. These commands are called query commands because each returns a response to a particular question.

In addition to the queries described above, you can create others by appending a question mark to most commands.

Getting Data from the 4263B

The 4263B can output readings and responses to query commands. As an example, have the 4263B generate a response to a query command by sending:

```
OUTPUT 717;"*IDN?"
```

When you send a query from remote, the 4263B does not display the response as it did when you executed the command from its front panel. Instead, the 4263B sends the response to its output buffer. The output buffer is a register that holds a query response or data for a single measurement until it is read by the computer or replaced by new information. Use the computer's input statement to get the response from the output buffer. For example, the following program reads the response (4263B) and prints it.

```
10 ENTER 717;A$  
20 PRINT A$  
30 END
```

Remote Operation

Most measurements can be modeled by the following simple three step sequence:

1. Set up the instrument.

Typically, you begin the setup step by sending `*RST` to set the instrument to its default settings. Next, if you need values different from the default settings, change the settings one by one as required.

2. Trigger the measurement.

The trigger may be generated automatically by steps taken in your setup commands, or you can send an explicit trigger command. To select the trigger source, send the `:TRIG:SOUR` command with the trigger source parameter. When you select `BUS` as the trigger source, sending `*TRG` triggers a measurement and retrieves the measurement data.

3. Retrieve the data.

Figure 4-1 shows a simple capacitance measurement program.

<code>OUTPUT 717;"*RST"</code>	<i>Step 1; Resetting</i>
<code>OUTPUT 717;" :INIT:CONT ON"</code>	<i>Step 1; Initiating trigger system</i>
<code>OUTPUT 717;" :SENS:FUNC 'FIMP' "</code>	<i>Step 1; Impedance measurement</i>
<code>OUTPUT 717;" :CALC1:FORM CS"</code>	<i>Step 1; Primary Parameter: CS</i>
<code>OUTPUT 717;" :CALC2:FORM D"</code>	<i>Step 1; Secondary Parameter: D</i>
<code>OUTPUT 717;" :SOUR:FREQ 100"</code>	<i>Step 1; Test Signal Frequency: 100 Hz</i>
<code>OUTPUT 717;" :TRIG:SOUR BUS"</code>	<i>Step 2; Trigger Source: Bus</i>
<code>OUTPUT 717;"*TRG"</code>	<i>Step 2; Triggering</i>
<code>ENTER 717;S,D1,D2</code>	<i>Step 3; Retrieving Readings</i>
<code>PRINT "CS:";D1,"D:";D2</code>	
<code>END</code>	

Figure 4-1. Simple Program Example

The following sections describe how to perform specific tasks.

4263B

To Set Up the 4263B

To Reset the 4263B

The following commands reset the 4263B:

- *RST
- :SYST:PRES

Note *RST initiates the trigger system also.



For example,

```
OUTPUT 717; "*RST"
```

To Set the Power Line Frequency

The following command sets the power line frequency:

- :SYST:LFR

For example, to set the power line frequency to 50 Hz,

```
OUTPUT 717; ":SYST:LFR 50"
```

To Match Cable Length of the Test Fixture

The following command matches the instrument's cable setting to the cable length of the test fixture:

- :CAL:CABL

For example, to select 1 m for the cable length,

```
OUTPUT 717; ":CAL:CABL 1"
```

To Select the Measurement Parameter

The following commands select the measurement parameter:

- :SENS:FUNC
- :SENS:FUNC:CONC
- :CALC1:FORM
- :CALC2:FORM

To set a parameter, send one of the following sets of statements:

Note



When your 4263B is equipped with Option 001 and you sent ":SENS:FUNC:CONC ON" to measure the transformer parameters, send ":SENS:FUNC:CONC OFF" before selecting the one of the measurement parameters 1 to 6.

1. To select the Z- θ mode,
 OUTPUT 717;":SENS:FUNC 'FIMP'"
 OUTPUT 717;":CALC1:FORM MLIN"
 OUTPUT 717;":CALC2:FORM PHAS"

To select the R-X mode,
 OUTPUT 717;":SENS:FUNC 'FIMP'"
 OUTPUT 717;":CALC1:FORM REAL"
 OUTPUT 717;":CALC2:FORM IMAG"

2. To select the Y- θ mode,
 OUTPUT 717;":SENS:FUNC 'FADM'"
 OUTPUT 717;":CALC1:FORM MLIN"
 OUTPUT 717;":CALC2:FORM PHAS"

To select the G-B mode,
 OUTPUT 717;":SENS:FUNC 'FADM'"
 OUTPUT 717;":CALC1:FORM REAL"
 OUTPUT 717;":CALC2:FORM IMAG"

3. To select the Cp-D mode,
 OUTPUT 717;":SENS:FUNC 'FADM'"
 OUTPUT 717;":CALC1:FORM CP"
 OUTPUT 717;":CALC2:FORM D"

To select the Cp-Q mode,
 OUTPUT 717;":SENS:FUNC 'FADM'"
 OUTPUT 717;":CALC1:FORM CP"
 OUTPUT 717;":CALC2:FORM Q"

To select the Cp-G mode,
 OUTPUT 717;":SENS:FUNC 'FADM'"
 OUTPUT 717;":CALC1:FORM CP"
 OUTPUT 717;":CALC2:FORM REAL"

To select the Cp-Rp mode,
 OUTPUT 717;":SENS:FUNC 'FADM'"
 OUTPUT 717;":CALC1:FORM CP"
 OUTPUT 717;":CALC2:FORM RP"

4. To select the Cs-D mode,
 OUTPUT 717;":SENS:FUNC 'FIMP'"
 OUTPUT 717;":CALC1:FORM CS"
 OUTPUT 717;":CALC2:FORM D"

To select the Cs-Q mode,
 OUTPUT 717;":SENS:FUNC 'FIMP'"
 OUTPUT 717;":CALC1:FORM CS"
 OUTPUT 717;":CALC2:FORM Q"

To select the Cs-Rs mode,
 OUTPUT 717;":SENS:FUNC 'FIMP'"
 OUTPUT 717;":CALC1:FORM CS"
 OUTPUT 717;":CALC2:FORM REAL"

5. To select the Lp-D mode,
 OUTPUT 717;":SENS:FUNC 'FADM'"
 OUTPUT 717;":CALC1:FORM LP"
 OUTPUT 717;":CALC2:FORM D"

To select the Lp-Q mode,
 OUTPUT 717;":SENS:FUNC 'FADM'"
 OUTPUT 717;":CALC1:FORM LP"
 OUTPUT 717;":CALC2:FORM Q"

To select the Lp-G mode,
 OUTPUT 717;":SENS:FUNC 'FADM'"
 OUTPUT 717;":CALC1:FORM LP"
 OUTPUT 717;":CALC2:FORM REAL"

To select the Lp-Rp mode,
 OUTPUT 717;":SENS:FUNC 'FADM'"
 OUTPUT 717;":CALC1:FORM LP"
 OUTPUT 717;":CALC2:FORM RP"

6. To select the Ls-D mode,
 OUTPUT 717;":SENS:FUNC 'FIMP'"
 OUTPUT 717;":CALC1:FORM LS"
 OUTPUT 717;":CALC2:FORM D"

To select the Ls-Q mode,
 OUTPUT 717;":SENS:FUNC 'FIMP'"
 OUTPUT 717;":CALC1:FORM LS"
 OUTPUT 717;":CALC2:FORM Q"

To select the Ls-Rs mode,
 OUTPUT 717;":SENS:FUNC 'FIMP'"
 OUTPUT 717;":CALC1:FORM LS"
 OUTPUT 717;":CALC2:FORM REAL"

4-6 Remote Operation (To Control from a Computer)

4263B

7. (Option 001 only)

To select the Ls-Rdc mode,
OUTPUT 717;":SENS:FUNC:CONC ON"
OUTPUT 717;":SENS:FUNC 'FIMP', 'FRES' "
OUTPUT 717;":CALC1:FORM LS"
OUTPUT 717;":CALC2:FORM REAL"

To select the Lp-Rdc mode,
OUTPUT 717;":SENS:FUNC:CONC ON"
OUTPUT 717;":SENS:FUNC 'FADM', 'FRES' "
OUTPUT 717;":CALC1:FORM LP"
OUTPUT 717;":CALC2:FORM REAL"

8. (Option 001 only)

To select the L2-N mode,
OUTPUT 717;":SENS:FUNC:CONC ON"
OUTPUT 717;":SENS:FUNC 'IMP', 'VOLT:AC' "
OUTPUT 717;":CALC1:FORM LS"
OUTPUT 717;":CALC2:FORM REAL"

To select the L2-1/N mode,
OUTPUT 717;":SENS:FUNC:CONC ON"
OUTPUT 717;":SENS:FUNC 'IMP', 'VOLT:AC' "
OUTPUT 717;":CALC1:FORM LS"
OUTPUT 717;":CALC2:FORM INV"

To select the L2-M mode,
OUTPUT 717;":SENS:FUNC:CONC ON"
OUTPUT 717;":SENS:FUNC 'IMP', 'FADM' "
OUTPUT 717;":CALC1:FORM LS"
OUTPUT 717;":CALC2:FORM LP"

To select the L2-R2 mode,
OUTPUT 717;":SENS:FUNC:CONC ON"
OUTPUT 717;":SENS:FUNC 'IMP', 'RES' "
OUTPUT 717;":CALC1:FORM LS"
OUTPUT 717;":CALC2:FORM REAL"

To Select the Test Signal Frequency

The following command selects the test signal frequency:

■ :SOUR:FREQ

For example, to select 100 Hz as the test signal frequency,

```
OUTPUT 717;":SOUR:FREQ 100"
```

To Select the Test Signal Level

The following command selects the test signal level:

■ :SOUR:VOLT

For example, to select 1 V as the test signal level,

```
OUTPUT 717;":SOUR:VOLT 1"
```

To Select Measurement Range

The following commands select the measurement range:

■ :SENS:FIMP:RANG

■ :SENS:FIMP:RANG:AUTO

For example, to select the Auto range mode,

```
OUTPUT 717;":SENS:FIMP:RANG:AUTO ON"
```

For example, to select the 1 M Ω range,

```
OUTPUT 717;":SENS:FIMP:RANG:AUTO OFF"  
OUTPUT 717;":SENS:FIMP:RANG 1E6"
```

To Apply a DC Bias

The following commands are used to apply a dc bias voltage:

- :SOUR:VOLT:OFFS
- :SOUR:VOLT:OFFS:SOUR
- :SOUR:VOLT:OFFS:STAT

For example, to apply 1.5 V DC bias using the internal bias source,

```
OUTPUT 717;":SOUR:VOLT:OFFS:SOUR INT"
OUTPUT 717;":SOUR:VOLT:OFFS 1.5"
OUTPUT 717;":SOUR:VOLT:OFFS:STAT ON"
:
OUTPUT 717;":SOUR:VOLT:OFFS:STAT OFF"
```

To Perform Correction

The following commands perform the correction function:

- :SENS:CORR
- :SENS:CORR:COLL
- :SENS:CORR:COLL:METH
- :SENS:CORR:CKIT:STAN3

There are two correction methods as follows:

OPEN and SHORT correction

To correct for stray admittance and residual impedance due to the test fixture.

OPEN, SHORT, and LOAD correction

To correct for any error due to the test fixture and test leads by using a standard (LOAD).

Refer to “Correction Functions of the 4263B” in Chapter 7 for more information.

Note



When the measurement parameter is Ls-Rdc, Lp-Rdc, L2-N, or L2-R2, the LOAD correction can correct only the errors for Ls, Lp, or L2.

4263B

- To perform OPEN and SHORT correction

```
:
OUTPUT 717;":SENS:CORR:COLL:METH REFL2"
DISP "Connect the test fixture without a DUT, then press 'Continue'."
PAUSE
OUTPUT 717;":SENS:CORR:COLL STAN1"
OUTPUT 717;"*OPC?"
ENTER 717;A
!
DISP "Connect the shorting bar to the test fixture, then press 'Continue'."
PAUSE
OUTPUT 717;":SENS:CORR:COLL STAN2"
OUTPUT 717;"*OPC?"
ENTER 717;A
:
```

- To perform OPEN, SHORT, and LOAD correction.

```
:
OUTPUT 717;":SENS:CORR:COLL:METH REFL3"
DISP "Connect the test fixture without a DUT, then press 'Continue'."
PAUSE
OUTPUT 717;":SENS:CORR:COLL STAN1"
OUTPUT 717;"*OPC?"
ENTER 717;A
!
DISP "Connect the shorting bar to the test fixture, then press 'Continue'."
PAUSE
OUTPUT 717;":SENS:CORR:COLL STAN2"
OUTPUT 717;"*OPC?"
ENTER 717;A
!
DISP "Connect the LOAD standard to the test fixture, then press 'Continue'."
PAUSE
OUTPUT 717;":SENS:CORR:CKIT:STAN3 1,-1000"
OUTPUT 717;":SENS:CORR:COLL STAN3"
OUTPUT 717;"*OPC?"
ENTER 717;A
:
```

To Select Measurement Time Mode

The following command selects measurement time mode:

■ :SENS:FIMP:APER

To set measurement time mode to Short:

```
OUTPUT 717;":SENS:FIMP:APER 0.025"
```

To set measurement time mode to Medium:

```
OUTPUT 717;":SENS:FIMP:APER 0.065"
```

To set measurement time mode to Long:

```
OUTPUT 717;":SENS:FIMP:APER 0.5"
```

To Set the Averaging Rate

The following commands set the averaging rate:

- :SENS:AVER
- :SENS:AVER:COUN

For example, to set the averaging rate to 4,

```
OUTPUT 717;":SENS:AVER:COUN 4"
```

To Set Trigger Delay Time

The following command sets trigger delay time:

- :TRIG:DEL

For example, to set trigger delay time to 10 ms,

```
OUTPUT 717;":TRIG:DEL 1E-2"
```

To Set Beeper Mode

The following commands set beeper mode:

- :SYST:BEEP
- :SYST:BEEP:STAT
- :CALC1:LIM:BEEP
- :CALC1:LIM:BEEP:COND

For example, to set beeper mode to emit a beep when comparison result is PASS.

```
OUTPUT 717;":CALC1:LIM:BEEP:COND PASS"
```

To Lock Out the Front Panel Keys

The following command locks out the front panel keys:

- :SYST:KLOC

For example, to lock out the front panel keys,

```
OUTPUT 717;":SYST:KLOC ON"
```

To Check Contact Integrity at the Test Fixture

The following command checks contacts at the test fixture:

- :SENS:FIMP:CONT:VER

For example, to enable the contact check function,

```
OUTPUT 717;":SENS:FIMP:CONT:VER ON"
```

To Use the Comparator Function

The following commands control the comparator function:

- :CALC{1|2}:LIM:CLE
- :CALC{1|2}:LIM:FAIL?
- :CALC{1|2}:LIM:LOW
- :CALC{1|2}:LIM:LOW:STAT
- :CALC{1|2}:LIM:UPP
- :CALC{1|2}:LIM:UPP:STAT
- :CALC{1|2}:LIM:STAT

4263B

{1|2} means that one of the two numbers must be attached to the root mnemonic, that is, the word "CALC"; 1 means the primary parameter and 2 means the secondary parameter.

For example, to set the limit values both for the primary and the secondary parameter, and to enable the comparator function,

```
OUTPUT 717;":CALC1:LIM:LOW 1E-5"  
OUTPUT 717;":CALC1:LIM:UPP 1E-4"  
OUTPUT 717;":CALC2:LIM:LOW 1E-5"  
OUTPUT 717;":CALC2:LIM:UPP 1E-4"  
OUTPUT 717;":CALC1:LIM:STAT ON"
```

To Display a Deviation Measurement

The following commands displays a deviation measurement:

- :DATA
- :CALC-{1|2}:MATH:EXPR:NAME
- :CALC-{1|2}:MATH:EXPR:CAT?
- :CALC-{1|2}:MATH:STAT

{1|2} means that one of the two numbers must be attached to the root mnemonic, that is, the word "CALC"; 1 means the primary parameter and 2 means the secondary parameter.

For example, to set the reference values using the measured values, to set to calculate the absolute value of deviation for the primary parameter, and to set to calculate the percent of deviation for the secondary parameter,

```
:  
OUTPUT 717;":FETC?"  
ENTER 717;s1,d1,d2  
OUTPUT 717;":DATA REF1,";d1  
OUTPUT 717;":DATA REF2,";d2  
OUTPUT 717;":CALC1:MATH:EXPR:NAME DEV"  
OUTPUT 717;":CALC2:MATH:EXPR:NAME PCNT"  
OUTPUT 717;":CALC1:MATH:STAT ON"  
OUTPUT 717;":CALC2:MATH:STAT ON"  
:
```

To Wait Until Previously Sent Commands are Completed

The following commands make the 4263B wait until the previously sent commands are completed:

- *OPC
- *OPC?
- *WAI

For example, to wait until the OPEN correction is completed,

```
OUTPUT 717;":SENS:CORR:COLL STAN1"  
OUTPUT 717;":*OPC?"  
ENTER 717;A
```

To Get the Current Instrument Settings

The following command gets the current instrument settings:

- *LRN?

For example,

```
DIM A$[1000]
:
OUTPUT 717;"*LRN?"
ENTER 717;A$
PRINT A$
```

To Save and Recall Instrument Settings

The following commands save and recall instrument settings:

- *SAV
- *RCL

To save the instrument settings to register no. 1,

```
OUTPUT 717;"*SAV 1"
```

To recall the instrument settings from register no. 1,

```
OUTPUT 717;"*RCL 1"
```

To Trigger a Measurement

The following commands are used to trigger measurements and retrieve measurement data. Refer to “Trigger System” in Chapter 5 for information about the 4263B’s trigger system.

- :TRIG
- :TRIG:SOUR
- :INIT
- :INIT:CONT
- :ABOR
- *TRG
- :FETC?
- Group Execution Trigger (GET)

Follow the procedure below to perform successive measurements automatically (initial setup).

1. Set the trigger mode to the internal trigger with the **:TRIG:SOUR** command.
2. If the trigger system has not started up (in the idle state), use the **:INIT:CONT** command to turn ON the continuous activation of the trigger system.

Two methods to perform a measurement at your desired time:

Triggering the instrument at your desired time

1. Use the **:TRIG:SOUR** command to set the trigger mode to the GPIB mode.
2. If the trigger system has not started up (in the idle state), use the **:INIT:CONT** command to turn ON the continuous activation of the trigger system.
3. Trigger the instrument at your desired time. An external controller can trigger the instrument with one of the following two commands:

Command	Query response	Applicable trigger mode
*TRG	Yes (The measured result is read out.)	GPIB trigger
:TRIG	No	All

4. To repeat measurement, repeat Step 3.

Starting up the trigger system at your desired time

1. If the trigger system has started up (in a state other than the idle state), use the **:INIT:CONT** command to turn OFF the continuous activation of the trigger system and then use the **:ABOR** command to stop the trigger system.
2. Set the trigger mode to the internal trigger with the **:TRIG:SOUR** command.
3. Start up the trigger system with the **:INIT** command at your desired time. The instrument will be automatically triggered by the internal trigger and measurement will be performed once.
4. To repeat measurement, repeat Step 3.

Waiting For Completion Of Measurement (detecting completion of measurement)

You can detect the status of the 4263B by using the status register, as described in this section. For information on the entire status report system (for example, information on each bit of the status register), refer to Chapter 5, "GPIB Reference."

The measurement state is indicated by the operation status register (refer to Table 5-6 and Table 5-7). An SRQ (service request) is useful for detecting the completion of measurement in your program by using the information indicated by this register.

To detect the completion of measurement using SRQ, use the following commands.

- *SRE
- :STAT:OPER:ENAB

The procedure is given below.

1. Make the setup so that the 4263B generates an SRQ if bit 4 of the operation status event register is set to 1.
2. Trigger the instrument to start a measurement.
3. Perform interrupt handling in the program when the SRQ occurs.

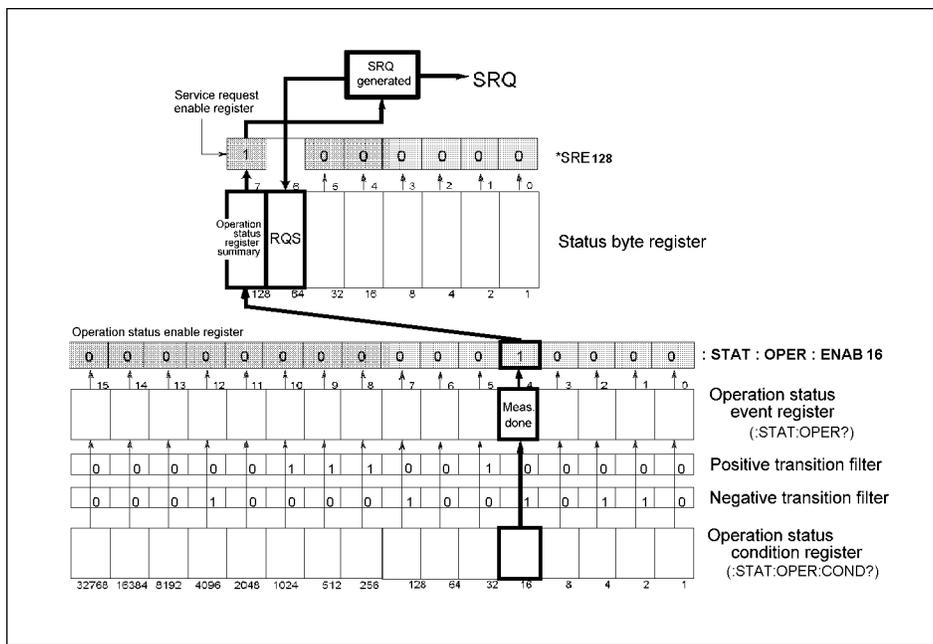

Figure 4-2. SRQ generation sequence (when measurement finishes)

4263B

Sample program

Figure 4-3 shows a sample program to detect the completion of measurement using an SRQ.

This program stops the trigger system, sets up SRQ, and then starts up the trigger system once. When an SRQ of the completion of the measurement occurs, it displays a "Measurement Complete" message and finishes.

The program is detailed below.

Line 20	Sets the GPIB address.
Lines 40 to 60	Stops the trigger system and sets the trigger mode to the internal trigger.
Lines 80 to 90	Enables bit 4 of the operation status event register and enables bit 7 of the status byte register.
Lines 100 to 120	Clears the status byte register and operation status event register.
Lines 140 to 150	Sets the branch destination of the SRQ interrupt and enables the SRQ interrupt.
Lines 160 to 180	Starts up the trigger system once to start the measurement and waits for the completion of the measurement.
Line 230	Displays "Measurement Complete" message.

```
10    DIM Buff$(9)
20    ASSIGN @Agt4263b TO 717
30    !
40    OUTPUT @Agt4263b ; " : INIT:CONT OFF"
50    OUTPUT @Agt4263b ; " : ABOR"
60    OUTPUT @Agt4263b ; " : TRIG:SOUR INT"
70    !
80    OUTPUT @Agt4263b ; " : STAT:OPER:ENAB 16"
90    OUTPUT @Agt4263b ; " * SRE 128"
100   OUTPUT @Agt4263b ; " * CLS"
110   OUTPUT @Agt4263b ; " * OPC?"
120   ENTER @Agt4263b ; Buff$
130   !
140   ON INTR 7 GOTO Meas_end
150   ENABLE INTR 7 ; 2
160   OUTPUT @Agt4263b ; " : INIT"
170   PRINT "Waiting . . ."
180 Meas_wait : GOTO Meas_wait
190 Meas_end : OFF INTR 7
200   PRINT "Measurement Complete"
210   END
```

Figure 4-3. Detecting the completion of measurement using SRQ

Reading Out Measured Result

This section describes how to read out the measured result.

You can read out the measured result in two ways: reading out data for each measurement or reading out data of several measurements in batch.

The three commands shown in the table below can be used to read out the measured data for each measurement.

	Available trigger mode	Readout procedure
Using the *TRG command	GPIB trigger (Bus)	Executing *TRG ↓ Readout
Using the :FETC? command	All	Triggering the instrument ↓ Executing :FETC? ↓ Readout

When you want to read out the data of several measurements in batch, use the data buffer.

Note



The TRIGGER command of HT BASIC has the same function as the ***TRG** command.

Reading out measured result using *TRG command

This command actually performs two tasks: it triggers the instrument and returns the results. It is useful, for example, when you want to retrieve measurement results immediately after triggering the instrument from an external controller.

The readout procedure using the *TRG command is described below.

1. Use the **:TRIG:SOUR** command to set up the trigger mode to the GPIB trigger (Bus).
2. Execute the ***TRG** command.
3. Read out the measured result. To repeat the measurement, repeat Steps 2 and 3.
Figure 4-4 and Figure 4-5 show sample programs using the ***TRG** command. Figure 4-4 is for the ASCII transfer format and Figure 4-5 is for the binary transfer format.

These programs read out the measurement status, measured primary parameter result, measured secondary parameter result, and comparator sorting result (when the comparator function is ON) and then display this information.

The program of Figure 4-4 is detailed below.

Line 60	Sets the GPIB address.
Line 70	Sets the data transfer format to the ASCII format.
Lines 90 to 100	Turns ON the trigger system continuous startup and sets the trigger mode to the GPIB trigger.
Lines 120 to 130	Reads out the ON/OFF state of the comparator function and assigns it to the Comp_flag variable.
Lines 170 to 210	After the trigger system state transitions to the trigger wait state, triggers the instrument.
Line 230	If the Comp_flag value is 1 (the comparator function is ON), reads out the measurement status, measured primary parameter result, measured secondary parameter result, and comparator sorting result.
Line 250	If the Comp_flag value is not 1 (the comparator function is OFF), reads out the measurement status, measured primary parameter result, and measured secondary parameter result.
Lines 300 to 320	Displays the measurement status, measured primary parameter result, and measured secondary parameter result.
Line 340 to 350	If the Comp_flag value is 1 (the comparator function is ON), displays the comparator sorting result.
Line 370	If the Comp_flag value is not 1 (the comparator function is OFF), displays "Comparator : OFF."

```

10 DIM Buff$ [9]
20 REAL Pri_para, Sec_para
30 INTEGER Meas_stat, Comp1, Comp2
40 INTEGER Comp_flag, Cond_reg
50 !
60 ASSIGN @Agt4263b TO 717
70 OUTPUT @Agt4263b ; " : FORM ASC"
80 !
90 OUTPUT @Agt4263b ; " : INIT:CONT ON"
100 OUTPUT @Agt4263b ; " : TRIG:SOUR BUS"
110 !
120 OUTPUT @Agt4263b ; " : CALC : LIM : STAT?"
130 ENTER @Agt4263b ; Comp_flag
140 !
150 ! Triggering and data read
160 !
170 REPEAT
180     OUTPUT @Agt4263b ; " : STAT : OPER : COND?"
190     ENTER @Agt4263b ; Cond_reg
200     UNTIL BIT(Cond_reg,5)
210     OUTPUT @Agt4263b ; " *TRG"
220     IF Comp_flag=1 THEN
230         ENTER @Agt4263b ; Meas_stat, Pri_para, Sec_para, Comp1, Comp2
240     ELSE
250         ENTER @Agt4263b ; Meas_stat, Pri_para, Sec_para
260     END IF
270 !
280 ! Display results
290 !
300 PRINT USING "15A, X, D" ; "Meas . status : ", Meas_stat
310 PRINT USING "15A, X, SD . 5DE" ; "Pri . parameter : ", Pri_para
320 PRINT USING "15A, X, SD . 5DE" ; "Sec . parameter : ", Sec_para
330 IF Comp_flag=1 THEN
340     PRINT USING "15A, X, K" ; "Primary Comparator : ", Comp1
350     PRINT USING "15A, X, K" ; "Secondary Comparator : ", Comp2
360 ELSE
370     PRINT USING "19A " ; "Comparator : OFF"
380 END IF
390 END

```

Figure 4-4.

Reading out the measured result in ASCII transfer format by using the *TRG command

4263B

The program of Figure 4-5 is detailed below.

Lines 50 to 60	Sets the GPIB address.
Line 70	Sets the data transfer format to the binary format.
Lines 90 to 100	Turns ON the trigger system continuous startup and sets the trigger mode to the GPIB trigger.
Lines 120 to 130	Reads out the ON/OFF state of the comparator function and assigns it to the Comp_flag variable.
Lines 170 to 210	After the trigger system state transitions to the trigger wait state, triggers the instrument.
Lines 220 to 250	Reads out the header part.
Line 270	If the Comp_flag value is 1 (the comparator function is ON), reads out the measurement status, measured primary parameter result, measured secondary parameter result, and comparator sorting result.

Note



Binary data must be read out without formatting. Therefore, use an I/O path (@Binary) set up for such readout. This is also applicable to Line 290.

Line 290	If the Comp_flag value is not 1 (the comparator function is OFF), reads out the measurement status, measured primary parameter result, and measured secondary parameter result.
Line 310	Reads out the message terminator at the end of the data.
Lines 350 to 370	Displays the measurement status, measured primary parameter result, and measured secondary parameter result.
Line 390 to 400	If the Comp_flag value is 1 (the comparator function is ON), displays the comparator sorting result.
Line 420	If the Comp_flag value is not 1 (the comparator function is OFF), displays "Comparator : OFF."

```

10   DIM Buff$ [9], Digit$ [1], Read_form$ [9], Num_of_byte$ [9]
20   REAL Pri_para, Sec_para
30   REAL Meas_stat, Comp1, Comp2
40   INTEGER Comp_flag, Cond_reg
50   ASSIGN @Binary TO 717 ; FORMAT OFF
60   ASSIGN @Agt4263b TO 717
70   OUTPUT @Agt4263b ; " : FORM REAL"
80   !
90   OUTPUT @Agt4263b ; " : INIT : CONT ON"
100  OUTPUT @Agt4263b ; " : TRIG : SOUR BUS"
110  !
120  OUTPUT @Agt4263b ; " : CALC : LIM : STAT?"
130  ENTER @Agt4263b ; Comp_flag
140  !
150  ! Triggering and data read
160  !
170  REPEAT
180    OUTPUT @Agt4263b ; " : STAT:OPER:COND?"
190    ENTER @Agt4263b ; Cond_reg
200  UNTIL BIT(Cond_reg, 5)
210  OUTPUT @Agt4263b ; " *TRG"
220  ENTER @Agt4263b USING "#, A" ; Buff$
230  ENTER @Agt4263b USING "#, A" ; Digit$
240  Read_form$="#, "&Digit$& "A"
250  ENTER @Agt4263b USING Read_form$ ; Num_of_byte$
260  IF Comp_flag=1 THEN
270    ENTER @Binary ; Meas_stat, Pri_para, Sec_para, Comp1, Comp2
280  ELSE
290    ENTER @Binary ; Meas_stat, Pri_para, Sec_para
300  END IF
310  ENTER @Agt4263b USING "#, A" ; Buff$
320  !
330  ! Display results
340  !
350  PRINT USING "15A, X, D" ; "Meas . status : " , Meas_stat
360  PRINT USING "15A, X, SD . 5DE" ; "Pri. parameter : " , Pri_para
370  PRINT USING "15A, X , SD . 5DE" ; "Sec . parameter : " , Sec_para
380  IF Comp_flag=1 THEN
390    PRINT USING "15A, X, K" ; "Primary Comparator  : " , Comp1
400    PRINT USING "15A, X, K" ; "Secondary Comparator  : " , Comp2
410  ELSE
420    PRINT USING "19A" ; "Comparator  : OFF"
430  END IF
440  END

```

Figure 4-5.

Reading out the measured result in binary transfer format using *TRG command

Reading out measured result using :FETC? command

You can use this readout method when you want to trigger the instrument from any source other than an external controller or when you want to perform a process that is between triggering the instrument and reading out the measured result.

The readout procedure using the **:FETC?** command is described below.

1. Set up the trigger mode as necessary.
2. Trigger the instrument by using the method for the trigger mode.

Note

To trigger the instrument from an external controller in this procedure, use the **:TRIG** command.



3. Execute the **:FETC?** command at the completion of the measurement.
4. Read out the measured result. To repeat the measurement, repeat Steps 2 to 4.

Figure 4-6 and Figure 4-7 show sample programs using the **:FETC?** command. Figure 4-6 is for the ASCII transfer format and Figure 4-7 is for the binary transfer format.

These programs, when an external trigger is inputted and the measurement finishes, read out the measurement status, measured primary parameter result, measured secondary parameter result, and comparator sorting result (when the comparator function is ON) and display them.

The program of Figure 4-6 is detailed below.

Line 60	Sets the GPIB address.
Line 70	Sets the data transfer format to the ASCII format.
Lines 90 to 100	Turns ON the trigger system continuous startup and sets the trigger mode to the external trigger.
Lines 120 to 130	Reads out the ON/OFF state of the comparator function and assigns it into the Comp_flag variable.
Lines 170 to 210	Makes the setup generate an SRQ when measurement finishes and clears the status byte register and operation status event register.
Lines 250 to 260	Sets the branch destination of the SRQ interrupt and enables the SRQ interrupt.
Lines 270 to 280	Displays the message to prompt the user to input an external trigger and then waits until the external trigger is inputted and the measurement finishes.
Line 300	Executes the measured result readout command (:FETC?).
Line 320	If the Comp_flag value is 1 (the comparator function is ON), reads out the measurement status, measured primary parameter result, measured secondary parameter result, and comparator sorting result.
Line 340	If the Comp_flag value is not 1 (the comparator function is OFF), reads out the measurement status, measured primary parameter result, and measured secondary parameter result.
Lines 390 to 410	Displays the measurement status, measured primary parameter result, and measured secondary parameter result.
Line 430 to 440	If the Comp_flag value is 1 (the comparator function is ON), displays the comparator sorting result.
Line 460	If the Comp_flag value is not 1 (the comparator function is OFF), displays "Comparator : OFF."

```

10 DIM Buff$ [9]
20 REAL Pri_para,Sec_para
30 INTEGER Meas_stat,Comp1, Comp2
40 INTEGER Comp_flag
50 !
60 ASSIGN @Agt4263b TO 717
70 OUTPUT @Agt4263b ; " : FORM ASC"
80 !
90 OUTPUT @Agt4263b ; " : INIT : CONT ON"
100 OUTPUT @Agt4263b ; " : TRIG : SOUR EXT"
110 !
120 OUTPUT @Agt4263b ; " : CALC : LIM : STAT?"
130 ENTER @Agt4263b ; Comp_flag
140 !
150 ! SRQ setting
160 !
170 OUTPUT @Agt4263b ; " : STAT : OPER : ENAB 16"
180 OUTPUT @Agt4263b ; " *SRE 128"
190 OUTPUT @Agt4263b ; " *CLS"
200 OUTPUT @Agt4263b ; " *OPC?"
210 ENTER @Agt4263b ; Buff$
220 !
230 ! Triggering and data read
240 !
250 ON INTR 7 GOTO Meas_end
260 ENABLE INTR 7 ; 2
270 PRINT "Waiting for External Trigger!"
280 Meas_wait : GOTO Meas_wait
290 Meas_end : OFF INTR 7
300 OUTPUT @Agt4263b ; " : FETC?"
310 IF Comp_flag=1 THEN
320     ENTER @Agt4263b ; Meas_stat, Pri_para, Sec_para, Comp1, Comp2
330 ELSE
340     ENTER @Agt4263b ; Meas_stat, Pri_para, Sec_para
350 END IF
360 !
370 ! Display results
380 !
390 PRINT USING "15A, X, D" ; "Meas. status : ", Meas_stat
400 PRINT USING "15A, X, SD . 5DE" ; "Pri. parameter : ", Pri_para
410 PRINT USING "15A, X, SD . 5DE" ; "Sec . parameter : ", Sec_para
420 IF Comp_flag=1 THEN
430     PRINT USING "15A, X, K" ; "Primary Comparator : ", Comp1
440     PRINT USING "15A, X, K" ; "Secondary Comparator : ", Comp2
450 ELSE
460     PRINT USING "19A" ; "Comparator : OFF"
470 END IF
480 END

```

Figure 4-6.

Reading out the measured result in ASCII transfer format using the :FETC? command

4263B

The program of Figure 4-7 is detailed below.

Lines 50 to 60	Sets the GPIB address.
Line 70	Sets the data transfer format to the binary format.
Lines 90 to 100	Turns ON the trigger system continuous startup and sets the trigger mode to the external trigger.
Lines 120 to 130	Reads out the ON/OFF state of the comparator function and assigns it to the Comp_flag variable.
Lines 170 to 210	Makes the setup generate an SRQ when measurement finishes and clears the status byte register and operation status event register.
Lines 250 to 260	Sets the branch destination of the SRQ interrupt and enables the SRQ interrupt.
Lines 270 to 280	Displays the message to prompt the user to input an external trigger and then waits until the external trigger is inputted and the measurement finishes.
Line 300	Executes the measured result readout command (:FETC?).
Lines 310 to 340	Reads out the header part.
Line 360	If the Comp_flag value is 1 (the comparator function is ON), reads out the measurement status, measured primary parameter result, measured secondary parameter result, and comparator sorting result.

Note

Binary data must be read out without formatting. Therefore, use an I/O path (@Binary) set up as such for readout. This is also applicable to Line 380.



Line 380	If the Comp_flag value is not 1 (the comparator function is OFF), reads out the measurement status, measured primary parameter result, and measured secondary parameter result.
Line 400	Reads out the message terminator at the end of the data.
Lines 440 to 460	Displays the measurement status, measured primary parameter result, and measured secondary parameter result.
Line 480 to 490	If the Comp_flag value is 1 (the comparator function is ON), displays the comparator sorting result.
Line 510	If the Comp_flag value is not 1 (the comparator function is OFF), displays "Comparator : OFF."

```

10   DIM Buff$ [9] , Digit$ [1] , Read_form$ [9] , Num_of_byte$ [9]
20   REAL Pri_para, Sec_para
30   REAL Meas_stat, Comp1, Comp2
40   INTEGER Comp_flag
50   ASSIGN @Binary TO 717 ; FORMAT OFF
60   ASSIGN @Agt4263b TO 717
70   OUTPUT @Agt4263b ; " : FORM REAL"
80   !
90   OUTPUT @Agt4263b ; " : INIT:CONT ON"
100  OUTPUT @Agt4263b ; " : TRIG:SOUR EXT"
110  !
120  OUTPUT @Agt4263b ; " : CALC : LIM : STAT?"
130  ENTER @Agt4263b ; Comp_flag
140  !
150  ! SRQ setting
160  !
170  OUTPUT @Agt4263b ; " : STAT : OPER : ENAB 16"
180  OUTPUT @Agt4263b ; " *SRE 128"
190  OUTPUT @Agt4263b ; " *CLS"
200  OUTPUT @Agt4263b ; " *OPC?"
210  ENTER @Agt4263b ; Buff$
220  !
230  ! Triggering and data read
240  !
250  ON INTR 7 GOTO Meas_end
260  ENABLE INTR 7 ; 2
270  PRINT "Waiting for External Trigger!"
280  Meas_wait: GOTO Meas_wait
290  Meas_end: OFF INTR 7
300  OUTPUT @Agt4263b ; " : FETC?"
310  ENTER @Agt4263b USING "# , A" ; Buff$
320  ENTER @Agt4263b USING "# , A" ; Digit$
330  Read_form$="# , " &Digit$&"A"
340  ENTER @Agt4263b USING Read_form$ ; Num_of_byte$
350  IF Comp_flag=1 THEN
360      ENTER @Binary ; Meas_stat, Pri_para, Sec_para, Comp1, Comp2
370  ELSE
380      ENTER @Binary ; Meas_stat, Pri_para, Sec_para
390  END IF
400  ENTER @Agt4263b USING "# , A" ; Buff$
410  !
420  ! Display results
430  !
440  PRINT USING "15A, X, D" ; "Meas . status : " , Meas_stat
450  PRINT USING "15A, X, SD . 5DE" ; "Pri . parameter : " , Pri_para
460  PRINT USING "15A, X, SD . 5DE" ; "Sec . parameter : " , Sec_para
470  IF Comp_flag=1 THEN
480      PRINT USING "15A, X, K" ; "Primary Comparator  : " , Comp1
490      PRINT USING "15A, X, K" ; "Secondary Comparator  : " , Comp2
500  ELSE
510      PRINT USING "19A" ; "Comparator  : OFF"
520  END IF
530  END

```

Figure 4-7.
Reading out measured result in binary transfer format using :FETC? command

To Retrieve Data Efficiently

The basic procedure to retrieve measurement data is described in "To Trigger a Measurement". This section describes how to retrieve the measurement data efficiently.

To Use a Data Buffer

You can use the data buffer to temporarily store the results of several measurements and then later read out these results in batch.

The following commands use the data buffer function:

- :DATA?
- :DATA:POIN
- :DATA:FEED
- :DATA:FEED:CONT

For example,

```

:
OPTION BASE 1
DIM D(600)
:
OUTPUT 717;":TRIG:SOUR BUS"
!
OUTPUT 717;":DATA:POIN BUF1,200"
OUTPUT 717;":DATA:FEED BUF1,'CALC1'"
OUTPUT 717;":DATA:FEED:CONT BUF1,ALW"
!
FOR I=1 TO 200
  OUTPUT 717;":TRIG"
NEXT I
!
OUTPUT 717;":DATA? BUF1"
ENTER 717;D(*)
PRINT D(*)
:

```

Other Features

To Test the 4263B

The following command runs the 4263B's internal self test:

- *TST?

For example,

```

:
OUTPUT 717;"*TST?"
ENTER 717;A
IF A<>0 THEN PRINT "Self Test:Error"
:

```

To Report the Instrument's Status

The following commands report the instrument's status:

- *CLS
- *ESE
- *ESR?
- *SRE
- *STB?
- :STAT:OPER?
- :STAT:OPER:COND?
- :STAT:OPER:ENAB
- :STAT:QUES?
- :STAT:QUES:COND?
- :STAT:QUES:ENAB
- :STAT:PRES
- HP BASIC SPOLL command

For example, to always generate a service request when an error enters the error queue, use as follows:

```
OUTPUT 717;"*ESE 52; *SRE 32"
```

For example, to detect the measurement completion:

```

OUTPUT 717;":STAT:OPER:ENAB 16"      Enable Measuring bit of Operation Status Register
OUTPUT 717;"*SRE 128"                Enable Operation Status Register Summary bit
REPEAT                                Wait until the Operation Status Register Summary
  A=SPOLL(717)                        bit is set
UNTIL BIT(A,7)

```

For example, to generate an interrupt when an error occurs in the 4263B

```

:                                Clears status byte register
DIM Err$(50)
!
:
OUTPUT 717;"*CLS"
OUTPUT 717;"*ESE 48"              Sets Command Error Bit and Execution Error Bit
OUTPUT 717;"*SRE 32"              Sets Standard Event Status register Summary Bit
!                                  Tells where to branch when interrupted
ON INTR 7 GOSUB Err_report
ENABLE INTR 7;2                    Enable an interrupt from GPIB interface

```

4263B

```
!                               Clear the SRQ Bit
:
LOOP
:
END LOOP
STOP
!
Err_report;!
Stat=SPOLL(717)
OUTPUT 717;"*ESR?"           Asks contents of the Standard Event Status Register
ENTER 717;Estat             Asks to output error number and message
PRINT "Syntaz Error detected."
!
OUTPUT 717;"SYST:ERR?"
ENTER 717;Err,Err$
PRINT Err,Err$
!
ENABLE INTR 7
RETURN
END
```

If You Have a Problem

Check all GPIB addresses and connections; most GPIB problems are caused by an incorrect address and bad or loose GPIB cables.

If the 4263B Hangs Up When You Send the :ABORt Command

- Send the device clear command to the 4263B:

For example,

```
CLEAR(717)
```

GPIB Reference

This chapter provides a reference for the General Purpose Interface Bus (GPIB) commands used to control the 4263B in the GPIB remote mode.

- GPIB Command reference
- Status Reporting Structure
- Trigger System
- Data Transfer Format

4263B's GPIB commands are compatible with the Standard Commands for Programmable Instruments (SCPI). SCPI is the instrument command language for controlling instrument that goes beyond IEEE 488.2 standard to address a wide variety of instrument functions in a standard manner.

GPIB Commands

GPIB commands can be separated into two groups: common commands and subsystem commands.

Common Commands

Common Commands are generally not measurement related, but are used to manage macros, status registers, synchronizations, are data storage. All common commands begin with an asterisk (*). Common commands are defined in the IEEE 488.2 standard.

The common commands which can be used on the 4263B are shown below.

Common Command List		
*CLS	*OPC	*SRE<numeric_value>
*ESE<numeric_value>	*OPC?	*SRE?
*ESE?	*OPT?	*STB?
*ESR?	*RCL<numeric_value>	*TRG
*IDN?	*RST	*TST?
*LRN?	*SAV<numeric_value>	*WAI

Subsystem Commands

Subsystem Commands include all measurement functions and some general purpose functions. Each subsystem is a set of commands that roughly corresponds to a functional block inside the instrument. For example, the commands comprising the SOURce (power) subsystem are for signal generation, and the commands comprising the STATus subsystem are for status register access.

Subsystem commands have a hierarchical structure, called a **command tree**, which consists of several key words separated by a colon between each word.

Subsystem Command List

COMMAND	PARAMETER	NOTE
ABORt		[No Query]
CALCulate{1 2}		
:FORMat	{REAL MLINear CP CS LP LP IMAGinary PHASe D Q REAL\LP}	
:LIMit		
:BEEPer		
:CONDition	{FAIL PASS}	
[:STATe]	<Boolean>	
:CLEar		[No Query]
:FAIL?		[Query Only]
:LOWer		
[:DATA]	<numeric_value>	
:STATe	<Boolean>	
:STATe	<Boolean>	
:UPPer		
[:DATA]	<numeric_value>	
:STATe	<Boolean>	
:MATH		
:EXPRession		
:CATalog?		[Query Only]
:NAME	{DEV PCNT}	
:STATe	<Boolean>	
:PATH?		[Query Only]
CALCulate{3 4}		
:MATH		
:STATe	<Boolean>	
CALibration		
:CABLe	<numeric_value>	
DATA		
[:DATA]	{REF1 REF2},<numeric_value>	
[:DATA]?	{BUF1 BUF2}	[Query Only]
:FEED	{IMON VMON}	[Query Only]
:CONTRol	{BUF1 BUF2},<data_handle>	
:POINTs	{BUF1 BUF2},{ALWays NEVer}	
:FEED	{BUF1 BUF2},<numeric_value>	
DISPlay		
[:WINDow]		
[:STATe]	<Boolean>	
:TEXT1		
:DIGit	<numeric_value>	
:PAGE	<numeric_value>	
:TEXT2		
:PAGE	<numeric_value>	
FETCh?		[Query Only]
FORMat		
[:DATA]	{ASCIi REAL[,64]}	
INITiate		
:CONTinuous	<Boolean>	[No Query]
[:IMMediate]		[No Query]

Subsystem Command List (continued)

COMMAND	PARAMETER	NOTE
[SENSe]		
:AVERage		
:COUNT	<numeric_value>	
[:STATe]	<Boolean>	
:CORRection		
:CKIT		
:STNdard3	<numeric_value>, <numeric_value>	
:COLLect		
[:ACQuire]	STANdard{1 2 3}	[No Query]
:METHod	{REFL2 REFL3}	
:DATA?	STANdard{1 2 3}	[Query Only]
[:STATe]	<Boolean>	
:FIMPedance		
:APERTure	<numeric_value> [MS S]	
:CONTact		
:VERify	<Boolean>	
:RANGe		
:AUTO	<Boolean>	
[:UPPer]	<numeric_value> [MOHM OHM KOHM MAOHM]	
:FUNCTion		
:CONCurent	<Boolean>	
:COUNT?		[Query Only]
[:ON]	<sensor_function>	
SOURce		
:FREQuency		
:CW	<numeric_value> [HZ KHZ]	
:VOLTage		
[:LEVel]		
[:IMMediate]		
[:AMPLitude]	<numeric_value> [MV V]	
:OFFSet	<numeric_value> [MV V]	
:SOURce	{INTernal EXTernal}	
:STATe	<Boolean>	
STATus		
:OPERation		
:CONDition?		[Query Only]
:ENABle	<numeric_value>	
[:EVENT]?		[Query Only]
:PRESet		
:QUEStionable		
:CONDition?		[Query Only]
:ENABle	<numeric_value>	
[:EVENT]?		[Query Only]
SYSTem		
:BEEPer		
[:IMMediate]		[No Query]
:STATe	<Boolean>	
:ERRor?		[Query Only]
:KLOCK	<Boolean>	
:LFRequency	<numeric_value>	
:PRESet		[No Query]
:VERSion?		[Query Only]
TRIGger		
:DELay	<numeric_value> [MS S]	
[:IMMediate]		[No Query]
:SOURce	{BUS EXTernal MANual INTernal}	

Concept of Subsystem Command Tree

The top of the subsystem command tree is called the **root command**, or simply the **root**. To reach the low-level commands, you must specify a particular **path** (like DOS file directory path). After Power ON or after *RST, the current path is set to the root. The path settings are changed as follows:

- Message Terminator** A message terminator, such as < new line> character, sets the current path to the root.
- Colon (:)** When a colon is placed between two command mnemonics, the colon moves the current path down one level on the command tree. When the colon is the first character of a command, it specifies that the following command mnemonics are root-level commands.
- Semicolon (;)** A semicolon separates two commands in the same message without changing the current path.

Common commands, such as *RST, are not part of any subsystem. The 4263B interprets them in the same way, regardless of the current path setting.

Figure 5-1 shows examples of how to use the colon and semicolon to navigate efficiently through the command tree.

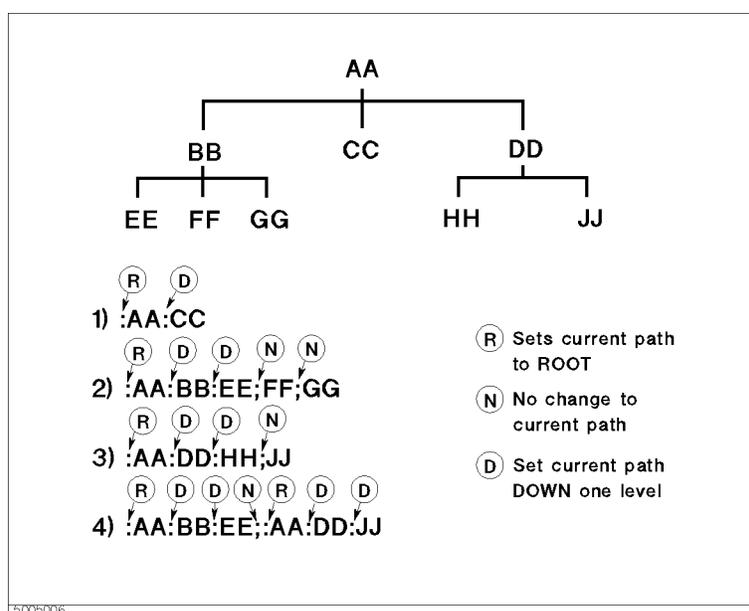

Figure 5-1. Proper Use of the Colon and Semicolon

Figure 5-1 shows how character input time can be saved by properly using semicolons. Sending the message

```
:AA:BB:EE; FF; GG
```

is equivalent to sending the following three messages.

```
:AA:BB:EE
:AA:BB:FF
:AA:BB:GG
```

Program Message Syntax

This section provides the construction of SCPI program message. A program message is the message that you send from computer to an instrument. Program message consist of commands combined with appropriate punctuation and program message terminators.

Case

Letter cases (upper and lower) are ignored.

Program Message Terminator

A program message must end with one of the three **program message terminators** , <new line>, <^END>, or <new line><^END>. <^END> means that End Of Identify (EOI) is asserted on the GPIB interface at the same time the preceding data byte is sent. For example, the HP BASIC OUTPUT statement is automatically sent after last data byte.

Subsystem Command Syntax

Subsystem commands consist of the mnemonic separated by colons. For example, the command format for APERTure of the [SENSE]:FIMPedance subsystem is as follows:

```
:FIMPedance:APERture
```

Mnemonics which are contractions of commands can also be used as commands. In the above example, :FIMP:APER can also be typed.

Common Command Syntax

Common commands do not have a hierarchical structure. They are just sent as follows:

```
*CLS
```

Parameters

There must be a <space> between the last command mnemonic and the first parameter in a subsystem command.

```
:FIMUP:APER␣ parameter
```

␣ means a space (ASCII character (decimal 32)).

If you send more than one parameter with a single command, each parameter must be separated by a comma. For example, two parameters are sent following the DATA subsystem's :POINts command as shown below.

```
:DATA:POIN␣<parameter>,<parameter>
```

Parameter Types

SCPI defines different data formats for use in program message and query responses. The 4263B accepts commands and parameters in various formats and responds to a particular query in a predefined and fixed format. Each command reference contains information about the parameter types available for the individual commands.

- *<numeric_value>* is used in both common commands and subsystem commands. *<numeric_value>* represents numeric parameters as follows:

100	no decimal point required
100.	fractional digits optional
-1.23, +235	leading signs allowed
4.56e \square 3	space allowed after e in exponentials
-7.89E-01	use either E or e in exponentials
.5	digits left of decimal point optional

The 4263B setting programmed with a numeric parameter can assume a finite number of values, so the 4263B automatically rounds off the parameter. For example, the 4263B has a programmable power line frequency of 50 or 60 Hz. If you specified 50.1, it would be rounded off to 50.

The subsystem commands can use extended numeric parameters. Extended numeric parameters accept all numeric parameter values and other special values, for instance, MAXimum, MINimum, or UP, DOWN. The special values available are described in the command's reference description.

Query response of *<numeric_value>* is always a numeric value.

- *<Boolean>* represents a single binary condition that is either ON or OFF. *<Boolean>* allows the following parameters:

ON, OFF In a program message
1, 0 In a program message and query response

- *<sensor_function>* and *<data_handle>* are string parameter which contain ASCII characters. A string must begin with a single quote (ASCII 39 decimal) or a double quote (ASCII 34 decimal) and end with the same corresponding character, a single or double quote. The quote to mark the beginning and end of the string is called the delimiter. You can include the delimiter as part of the string by typing it twice without any characters in between.

Example of *<sensor_function>* 'FIMP',

```
10 OUTPUT @Meter;":FUNC 'FIMP' "           using single quote
20 OUTPUT @Meter;":FUNC ""FIMP""          using double quote
```

The query response is the string between double quote delimiters.

Units

Units can be used with *numeric_value* parameters when so documented in the Command Reference.

Table 5-1. Usable Units

Definition	Mnemonic	Usable Unit
10^6 (Mega)	MA	Hz
10^3 (kilo)	K	V
10^{-3} (Milli)	M	OHM
		S

The suffix is optional and can be omitted.

Multiple Messages

To send more than one command in the same message, you must separate them with a semicolon:

```
*CLS; :INIT
```

Query and Response Message Syntax

All subsystem commands can be queried except for the commands described as “no query” in the command reference. To send a query message, and ? after the last command mnemonic.

```
:FIMP:APER?
```

A response message may contain both commas and semicolons as separators. When a single query command returns multiple values, a comma is used to separate each item. When multiple queries are sent in the same message, the group of data items corresponding to each query are separated by a semicolon. For example, the fictitious query :QUERY?;QUERY2? might return a response message of:

```
<data1>,<data1>;<data2>,<data2>
```

After the message, <new line><END> is always sent as a response message terminator.

Command Reference

In this section, all the commands which are available with the 4263B are listed in alphabetical order.

Notations

The following conventions and definition are used in this chapter to describe GPIB operation.

:CALClate{1|2};LIMit:LOWer[:DATA] <numeric_value>

Sets or queries the lower limit of the specified parameter.

:CALClate{1|2};LIMit:LOWer:STATe{ON|OFF|1|0}

Sets or queries if the lower limit of the specified parameter is enabled.

< > Angular brackets enclose words or characters that are used to symbolize a program code parameter or an GPIB command.

[] Square brackets indicate that the enclosed items are optional.

{ } When several items are enclosed by braces, one and only one of these elements may be selected. A vertical bar can be read as “or” and is used to separate alternative parameter options.

for example,

:CALCulate {1|2} means :CALC1 or :CALC2.

[DATA] is optional. This keyword can be omitted as in :CALC1:LIM:LOW <numeric_value>.

ABORt Command

:ABORt

The ABORt command resets the trigger system and places all trigger sequences in the Idle state. Any actions related to the trigger system that are in progress, such as acquiring a measurement, are aborted immediately. The execution of an :ABORt command will set any pending operation flag to FALSE, for example flags that were set by the initiation of the trigger system. Refer to “Trigger System”.

Unlike *RST, :ABORt does not alter the settings programmed by other commands. (No query)

Note



After the :FETCh?query, the *TRG command, or the BASIC command TRIGGER command, the :ABORt command will cause the GPIB bus to hang up. To avoid this, clear the GPIB bus by sending the BASIC command CLEAR (address) before sending the :ABORt command.

CALCulate Subsystem

The CALCulate subsystem controls the measurement-data processing as listed below:

1. To select measurement parameter (:CALCulate{1|2}:FORMat subsystem) with the [:SENSe]:FUNCTion[:ON] subsystem
2. To control the level monitor function (:CALCulate{3|4}:MATH subsystem)
3. To control deviation measurement mode (:CALCulate{1|2}:MATH subsystem)
4. To control comparator function (:CALCulate{1|2}:LIMit subsystem)

The 4263B performs data processing in the order as listed.

The CALCulate subsystem is logically positioned between the SENSe subsystem and the data output to the bus and display. The CALCulate subsystem, the SENSe subsystem, the DATA subsystem, and FETCh? Query are used together to capture the measurement data.

COMMAND	PARAMETER
CALCulate{1 2}	
:FORMat	{REAL MLINear CP CS LP LS IMAGinary PHASe D Q REAL LP RP INV}
:LIMit	
:BEEPer	
:CONDition	{FAIL PASS}
[:STATe]	<Boolean>
:CLEar	
:FAIL?	
:LOWer	
[:DATA]	<numeric_value>
:STATe	<Boolean>
:STATe	<Boolean>
:UPPer	
[:DATA]	<numeric_value>
:STATe	<Boolean>
:MATH	
:EXPRession	
:CATalog?	
:NAME	{DEV PCNT}
:STATe	<Boolean>
:PATH?	
CALCulate{3 4}	
:MATH	
:STATe	<Boolean>

Note CALCulate{1|2} means CALCulate1 for the primary parameter or CALCulate2 for the secondary parameter.



4263B

:CALCulate1:FORMat { **REAL** | **MLINear** | **CP** | **CS** | **LP** | **LS** }
:CALCulate2:FORMat { **IMAGinary** | **PHASe** | **D** | **Q** | **REAL** | **LP** | **RP** | **INV** }

Sets or queries the measurement parameter.

This command works with the [:SENSe]:FUNctioN[:ON] subsystem. The 4263B makes a vector measurement of the DUT, using the method specified by the SENSe subsystem. After the measurement, the scalar measurement parameter specified by :CALCulate{1|2}:FORMat command is calculated from the measured vector value.

REAL	Real part of the vector
IMAGinary	Imaginary part of the vector
MLINear	Absolute value of the vector
PHASe	Phase of impedance
CP	Equivalent parallel capacitance
CS	Equivalent series capacitance
LP	Equivalent parallel inductance
LS	Equivalent series inductance
D	Dissipation factor
Q	Quality factor
RP	Equivalent parallel resistance
INV	1/N (Reciprocal of turns ratio N)

For information on the selection of measurement parameters, refer to “To Select the Measurement Parameter” in Chapter 4.

Note



The SENSe:FUNctioN subsystem has priority over the CALCulate{1|2}:FORMat command. That is,

- When setting the SENS:FUNC:ON command, the setting of the CALC {1|2}:FORM command is restricted. When the settings of these two commands do not match any measurement parameter shown in Table 5-2, the setting of CALC{1|2}:FORM is automatically changed to a measurement parameter which matches SENS:FUNC:ON.
- When setting the CALC{1|2}:FORM command, if the current setting of the SENS:FUNC:ON command does not match any measurement parameter shown in Table 5-2, the CALC{1|2}:FORM command is rejected, and an error occurs.

Therefore, before setting the CALC {1|2}:FORM command, the [SENSe]:FUNctioN:ON command must be set correctly.

Table 5-2. Measurement Parameter Choices

Measurement Parameter	SENS:FUNC:ON ¹	CALC1:FORM	CALC2:FORM
Z- θ R-X	"FIMPedance"	MLINear REAL	PHASe IMAGinary
Y- θ G-B	"FADMittance"	MLINear REAL	PHASe IMAGinary
C _P -D C _P -Q C _P -G C _P -R _P	"FADMittance"	CP	D Q REAL RP
C _S -D C _S -Q C _S -R _S	"FIMPedance"	CS	D Q REAL
L _P -D L _P -Q L _P -G L _P -R _P	"FADMittance"	LP	D Q REAL RP
L _S -D L _S -Q L _S -R _S	"FIMPedance"	LS	D Q REAL
L _S -Rdc ² L _P -Rdc ²	"FIMPedance", "FRESistance" "FADMittance", "FRESistance"	LS LP	REAL REAL
L2-N ² L2-1/N ² L2-M ² L2-R2 ²	"IMPedance", "VOLTage:AC" "IMPedance", "VOLTage:AC" "IMPedance", "FADMittance" "IMPedance", "RESistance"	LS	REAL INV LP REAL

¹ The SENSE:FUNCTION:ON command is documented in the "SENSE Subsystem" section.

² Can be used only on a 4263B which is equipped with Option 001 (N / M / DCR measurement function addition).

:CALCulate{1|2}:LIMit:BEEPer:CONDition {FAIL|PASS}

Defines comparator output to beeper.

FAIL Emits a beep when comparison result is FAIL (High, Low or No-contact).
PASS Emits a beep when comparison result is PASS (In).

This command is effective, when :SYSTEM:BEEPer:STATE and
":CALCulate{1|2}:LIMit:BEEPer:STATE" command is set to ON.

Query response is FAIL or PASS.

Note



The comparator output states of each parameter link together. So the CALCulate{1|2}:LIMit:BEEPer command toggles the comparator function of both parameters PASS or FAIL.

:CALCulate{1|2}:LIMit:BEEPer[:STATE] { ON | OFF | 1 | 0 }

Sets or queries if the comparator output to beeper is enabled.

OFF or 0 Disables comparator output to beeper.
ON or 1 Enables comparator output to beeper as defined by
:CALCulate{1|2}:LIMit:BEEPer:CONDition command.

4263B

When you enable the beep function, :SYSTem:BEEPer:STATe command is automatically set to ON.

Query response is 0 or 1.

Note



The comparator output states of each parameter link together. So the CALCulate{1|2}:LIMit:BEEPer command toggles the comparator function of both parameter ON or OFF.

:CALCulate{1|2}:LIMit:CLEAr

Clears the data which is reported by :CALCulate{1|2}:LIMit:FAIL? command. (no query)

:CALCulate{1|2}:LIMit:FAIL?

Returns the comparison result of the selected parameter. (query only)

Query response is 0 or 1. Where,

0 : Comparison result is PASS.
1 : Comparison result is FAIL.

:CALCulate{1|2}:LIMit:LOWer[:DATA] <numeric_value>

Sets or queries the lower limit value of the selected parameter.

<numeric_value> is,

<i>numeric</i>	-9.9999×10^{13} to 9.9999×10^{13}
MINimum	-9.9999×10^{13}
MAXimum	9.9999×10^{13}

Query response is a numeric value in <NR3> format.

:CALCulate{1|2}:LIMit:LOWer:STATe { ON | OFF | 1 | 0 }

Sets or queries if the lower limit of the selected parameter is enabled.

OFF or 0 Disables the lower limit.
ON or 1 Enables the lower limit.

Query response is 0 or 1.

:CALCulate{1|2}:LIMit:STATe { ON | OFF | 1 | 0 }

Sets or queries if the comparator function is enabled.

OFF or 0 Sets the comparator function OFF.
ON or 1 Sets the comparator function ON.

Query response is 0 or 1.

:CALCulate{1|2}:LIMit:UPPer[:DATA] <numeric_value>

Sets or queries the upper limit value of the selected parameter.

<numeric_value> is,

<i>numeric</i>	-9.9999×10^{13} to 9.9999×10^{13}
MINimum	-9.9999×10^{13}
MAXimum	9.9999×10^{13}

Query response is a numeric value in <NR3> format.

:CALCulate{1|2}:LIMit:UPPer:STATe { ON | OFF | 1 | 0 }

Sets or queries if the upper limit of the selected parameter is enabled.

OFF or 0 Disables the upper limit.
ON or 1 Enables the upper limit.

Query response is 0 or 1.

:CALCulate{1|2}:MATH:EXPReSSion:CATalog?

Returns available parameters which can be used with the
:CALCulate{1|2}:MATH:EXPReSSion:NAME command. (query only)

Query response is always DEV,PCNT.

:CALCulate{1|2}:MATH:EXPReSSion:NAME { DEV | PCNT }

Defines or queries the expression used for the deviation measurement, which is enabled by
:CALCulate{1|2}:MATH:STATe. The reference value is defined using the :DATA[:DATA]
command.

DEV Absolute value of deviation
PCNT Percentage of deviation

Query response is DEV or PCNT.

:CALCulate{1|2}:MATH:STATe { ON | OFF | 1 | 0 }

Sets or queries if math processing defined by the :CALCulate{1|2}:MATH:EXPReSSion:NAME is
enabled or not.

OFF or 0 Disables math processing.
ON or 1 Enables math processing.

Query response is 0 or 1.

:CALCulate{1|2}:PATH?

Returns the CALCulate subsystems in the order in which they are to be performed. (query
only)

The 4263B always processes measured data in order of :CALCulate{1|2}:FORMat subsystem,
:CALCulate{1|2|3|4}:MATH subsystem, and :CALCulate{1|2}:LIMit subsystem.

Query response is always FORM,MATH,LIM.

:CALCulate{3|4}:MATH:STATe {ON|OFF|1|0}

Sets or queries if the level monitor function is ON or OFF.

CALCulate3 Specifies the current monitor.
CALCulate4 Specifies the voltage monitor.

ON or 1 Turns ON the level monitor function.
OFF or 0 Turns OFF the level monitor function.

Query response is 0 or 1.

4263B

CALibration Subsystem

COMMAND

CALibration
:CABLe

PARAMETER

<numeric_value>

:CALibration:CABLe <numeric_value>

Sets or queries the cable length which extends the reference plane to which the phase shift measurement error is corrected.

<numeric_value> is,

- 0 0 m cable length
- 1 1 m cable length
- 2 2 m cable length
- 4 4 m cable length

The 4263B has four reference planes as follows:

Cable Length	Available Frequency Range
0 m	100 Hz, 120 Hz, 1 kHz, 10 kHz, 20 kHz ¹ , 100 kHz
1 m	100 Hz, 120 Hz, 1 kHz, 10 kHz, 20 kHz ¹ , 100 kHz
2 m	100 Hz, 120 Hz, 1 kHz, 10 kHz, 20 kHz ¹
4 m	100 Hz, 120 Hz, 1 kHz

¹ Option 002 only

Query response is a numeric value in <NR1> format.

DATA Subsystem

The DATA subsystem commands are used for the following data processing:

1. Storing the data to the 4263B data buffer.
2. Reading the data from the 4263B data buffer.
3. Reading the level monitor value.

COMMAND	PARAMETER
DATA	
[:DATA]	{REF1 REF2},<numeric_value>
[:DATA]?	{BUF1 BUF2}
	{IMON VMON}
:POINTs	{BUF1 BUF2},<numeric_value>
:FEED	{BUF1 BUF2},<data_handle>
:CONTrol	{BUF1 BUF2},{ALWays NEVer}

:DATA[:DATA] { REF1 | REF2 },<numeric_value>

Enters or queries the reference value for the deviation measurement, which is controlled by the :CALCulate{1|2}:MATH subsystem command.

REF1 and REF2 can store only one value for each buffer, and this command will overwrite the value.

REF1 Reference value for the primary parameter
REF2 Reference value for the secondary parameter

Query response of :DATA[:DATA]? retrieves REF1 or REF2, according to the format determined by the FORMat subsystem commands. :DATA[:DATA]? query needs parameter, REF1 or REF2, which is the name of the data buffer to be used. So, the query form is :DATA[:DATA]? REF1 or :DATA[:DATA]? REF2.

4263B

:DATA[:DATA]? { BUF1 | BUF2 }

Returns the data in a data buffer, BUF1 or BUF2, according to the format determined by the FORMat subsystem commands. (query only)

BUF1 and BUF2 are used to store up to 200 measurement results in each. The size of the data buffer is specified by the :DATA:POINts command.

This query needs parameter BUF1 or BUF2, which is the name of the data buffer to be read. So, the query form is :DATA[:DATA]? BUF1 or :DATA[:DATA]? BUF2.

Reading the data buffer returns its pointer to the head of the buffer. After that, data will be stored from the head of the buffer.

Query response is <set1>,<set2>, ... <setn>

Where,

<set1> : Data set of the first measured point
<set2> : Data set of the second measured point
:
:
<setn> : Data set of the last measured point

Every data sets contains the following data: <stat>,<data>,<comp>

Where, <stat> Measurement status
0 : Normal
1 : Overload
2 : No-contact

<data> Measurement data

<comp> Comparison result
0 : Comparator OFF
1 : In
2 : High
4 : Low
8 : No-contact

:DATA[:DATA]? { IMON|VMON }

Reads the level monitor value. (query only)

IMON Reads the current monitor.
VMON Reads the voltage monitor.

Query response is a numeric value in <NR3> format.

:DATA:FEED { BUF1 | BUF2 },<data_handle>

Sets or queries which of the primary or secondary parameter's measurement data is fed into the data buffer.

:DATA:FEED? query needs parameter, BUF1 or BUF2, which is the name of data buffer to be read. So, the query form is :DATA:FEED? BUF1 or :DATA:FEED? BUF2.

<data_handle> is,

- 'CALCulate1' Sets to feed the primary parameter's measurement data specified the :CALCulate1:FORMat command.
- 'CALCulate2' Sets to feed the secondary parameter's measurement data specified :CALCulate2:FORMat command.
- '' (null string) Sets not to feed data into the data buffer.

Query response is "CALC1", "CALC2", or "".

:DATA:FEED:CONTRol { BUF1 | BUF2 },{ ALWays | NEVer }

Sets or queries whether or not data is fed into the data buffer. The data fed by this command is specified by :DATA:FEED command. This control has no effect if :DATA:FEED is set to '' (null string).

:DATA:FEED:CONTRol? query needs the parameter, BUF1 or BUF2, which is the name of the data buffer to be read. So, the query form is :DATA:FEED:CONTRol? BUF1 or :DATA:FEED:CONTRol? BUF2.

- ALWays Feeds data into the data buffer whenever new data is available.
- NEVer Does not feed the data into the data buffer.

Query response is ALW or NEV.

:DATA:POINts { BUF1 | BUF2 },<numeric_value>

Sets or queries the size of data buffer, BUF1 or BUF2. You can store as many measurement point data sets into BUF1 or BUF2 as defined by this command.

This command returns the data buffer pointer to the head of the buffer. After that, data will be stored from the head of the buffer.

:DATA:POINts? query needs the parameter, BUF1 or BUF2, which is the name of data buffer to be read. So, the query form is :DATA:POINts? BUF1, or :DATA:POINts? BUF2.

<numeric_value> is,

numeric 1 to 200

Query response is a numeric value in <NR1> format.

DISPlay Subsystem

The DISPlay subsystem controls the selection of displayed mode.

COMMAND	PARAMETER
DISPlay	
[:WINDow]	
[:STATe]	<Boolean>
:TEXT1	
:DIGit	{ 3 4 5 }
:PAGE	{ 1 2 }
:TEXT2	
:PAGE	{ 1 2 3 4 5 6 }

:DISPlay[:WINDow][:STATe] { ON | OFF | 1 | 0 }

Sets the display ON or OFF, or queries whether the display is set to ON or OFF.

OFF or 0 Sets the display OFF (blank).

ON or 1 Set the display ON.

Query response is 0 or 1.

:DISPlay[:WINDow]:TEXT1:DIGit { 3|4|5 }

Sets the number of display digits.

3 3 digits display

4 4 digits display

5 5 digits display

Query response is 3, 4 or 5.

:DISPlay[:WINDow]:TEXT1:PAGE { 1|2 }

Selects the displayed data.

1 Measurement Display.

2 Comparison Display.

Query response is 1 or 2.

:DISPlay[:WINDow]:TEXT2:PAGE {1|2|3|4|5|6}

Selects the mode of Measurement Settings display.

- | | |
|---|--|
| 1 | Displays the test signal frequency and level. |
| 2 | Displays the DC bias setting and averaging rate. |
| 3 | Displays the trigger delay and cable length. |
| 4 | Displays the comparator limit for the primary parameter. |
| 5 | Displays the comparator limit for the secondary parameter. |
| 6 | Displays the level monitor value. |

Query response is 0, 1, 2, 3, 4, or 5.

4263B

FETCh? Query

:FETCh?

Retrieves the measurements taken by the INITiate subsystem commands and places them into the 4263B's output buffer. (query only)

Query response is, *<stat>*,*<data1>*,*<data2>*,*<comp1>*,*<comp2>*

Where,

<stat> Measurement status

0 : Normal

1 : Overload

2 : No-Contact

<data1> Measurement data of the primary parameter

<data2> Measurement data of the secondary parameter

<comp1> Comparison result of the primary parameter (no output when comparator is OFF)

<comp2> Comparison result of the secondary parameter (no output when comparator is OFF)

1 : In

2 : High

4 : Low

8 : No-Contact

Data format is specified by FORMat subsystem.

For more information, refer to "To Trigger a Measurement" in Chapter 4.

FORMat Subsystem**COMMAND**

FORMat

[:DATA]

PARAMETER

{ASCIi|REAL[,64]}

:FORMat[:DATA] {ASCIi|REAL[,64]}

Sets the data format for transferring numeric and array information.

ASCIi Sets the data transfer format to ASCII.

AL[,64] Sets the data transfer format to IEEE 754 floating point numbers of the specified length of 64-bit.

For details on data transfer formats, see “Data Transfer Format”.

Query response is ASK or REAL,64.

4263B

INITiate Subsystem

The INITiate subsystem controls the initiation of the trigger system. All trigger sequences are indicated as a group. The detailed description of the trigger system is given in “Trigger System”.

COMMAND	PARAMETER
INITiate	
:CONTinuous	<Boolean>
[:IMMediate]	

:INITiate[:IMMediate]

Causes all sequences to exit Idle state and enter Initiate state. This command causes the trigger system to initiate and complete one full trigger cycle, returning to Idle state on completion. (No query)

If the 4263B is not in Idle state or if :INITiate:CONTinuous is set to ON, an :INITiate:IMMediate command has no effect on the trigger system and an error -213 is generated.

:INITiate:CONTinuous {ON|OFF|1|0}

Sets or queries whether the trigger system is continuously initiated or not.

OFFor0 Does not initiate the trigger system continuously.
ONor1 Initiates the trigger system continuously.

Query response is 0 or 1.

SENSE Subsystem

COMMAND	PARAMETER
[SENSe]	
:AVERage	
:COUNT	<numeric_value>
[:STATe]	<Boolean>
:CORRection	
:CKIT	
:STANdard3	<numeric_value>,<numeric_value>
:COLLect	
[:ACQuire]	STANdard{1 2 3}
:METhod	{REFL2 REFL3}
:DATA?	STANdard{1 2 3}
[:STATe]	<Boolean>
:FIMPedance	
:APERture	<numeric_value>[MS S]
:CONtact	
:VERify	<Boolean>
:RANGe	
:AUTO	<Boolean>
[:UPPer]	<numeric_value>[MOHM OHM KOHM MAOHM]
:FUNction	
:CONCurrent	<Boolean>
:COUNT?	
[:ON]	<sensor_function>

[[:SENSe]:AVERage:COUNT <numeric_value>

Sets or queries the averaging rate.

<numeric_value> is,

<i>numeric</i>	1 to 256
MINimum	1
MAXimum	256

Query response is a numeric value in <NR1> format.

[[:SENSe]:AVERage[:STATe] { ON | OFF | 1 | 0 }

Sets or queries if averaging is enabled.

OFF or 0 Disables averaging.

ON or 1 Enables averaging.

Query response is 0 or 1.

4263B

[[:SENSe]:CORRection:CKIT:STANdard3 <numeric_value>,<numeric_value>

Enters or queries the reference value for the LOAD correction. The reference value must be in R-X (resistance-reactance) parameter form; the first <numeric_value> represents R, and the second <numeric_value> represents X. To calculate the R-X parameter from other parameters, see Figure 3-10.

Note



The 4263B's test signal frequency at the 120 Hz setting is actually 119.048 Hz, and it is specified as 120 Hz \pm 1%. When you calculate the R-X parameter from other parameters, use 119.048 for frequency value at the 120 Hz setting.

<numeric_value> is,

numeric -1.0×10^9 to -1.0×10^{-7} , 1.0×10^{-7} to 1.0×10^9

The short form of :STANdard3 is :STAN3. (3 must *not* be omitted.)

Query response is two numeric values (separated by a comma) in <NR3> format.

[[:SENSe]:CORRection:COLLect[:ACQuire] STANdard{1|2|3}

Performs the OPEN, SHORT, or LOAD correction. (no query)

The 4263B has three correction functions as follows:

STANdard1 Performs the OPEN correction.

STANdard2 Performs the SHORT correction.

STANdard3 Performs the LOAD correction. The reference value of the LOAD correction is defined by [[:SENSe]:CORRection:CKIT:STANdard3 command.

The short forms of STANdard1, STANdard2, and STANdard3 are STAN1, STAN2, and STAN3 respectively.

This command sets [[:SENSe]:]CORRection[:STATe] ON, which enables the correction function.

The instrument settings in which each correction is performed are as follows:

Setting	STANdard1 (OPEN correction)	STANdard2 (SHORT correction)	STANdard3 (LOAD correction)
Test Signal Frequency	Sweep of all frequency points (including DC)		Current setting
Test Signal Level	Current setting		
DC Bias	OFF		Current setting
Measurement Range	Auto range		Current setting
Measurement Time Mode	Long		
Averaging Rate	1		
Trigger Delay Time	0 s		
Cable Length	Current setting		

[:SENSe]:CORRection:COLLect:METhod { REFL2 | REFL3 }

Sets or queries the measurement error correction method.

REFL2 OPEN/SHORT correction
REFL3 OPEN/SHORT/LOAD correction

You must take the required correction data using the
[:SENSe]:CORRection:COLLect[:ACQuire] command.

For details, see “To Perform Correction” in Chapter 4 and “Correction Functions of the 4263B” in Chapter 7.

* [:SENSe]:CORRection:COLLect:METhod is set to REFL2 by *RST.

Query response is REFL2 or REFL3.

[:SENSe]:CORRection:DATA? STANdard{1|2|3}

Returns the correction data. (Query Only)

STANdard1 OPEN correction data
STANdard2 SHORT correction data
STANdard3 LOAD correction data

Query response is two numeric values (separated by a comma) in <NR3> format.

[:SENSe]:CORRection[:STATe] { ON | OFF | 1 | 0 }

Sets or queries if the measurement error correction function is enabled.

OFF or 0 Disables the correction function.
ON or 1 Enables the correction function.

Query response is 0 or 1.

[:SENSe]:FIMPedance:APERTure <numeric_value>[MS|S]

Sets or queries measurement time mode: Short, Medium, or Long.

<numeric_value> is,

numeric 0.025 (Short), 0.065 (Medium), or 0.500 (Long) (s)

Query response is a numeric value in <NR3> format.

[:SENSe]:FIMPedance:CONtact:VERify { ON | OFF | 1 | 0 }

Sets or queries if the contact check function is enabled.

OFF or 0 disables the contact check function.
ON or 1 enables the contact check function.

The reference data for the contact check is taken by the OPEN/SHORT correction.

Query response is 0 or 1.

[:SENSe]:FIMPedance:RANGe:AUTO { ON | OFF | 1 | 0 }

Sets or queries if the auto range measurement mode is enabled.

OFF or 0 Hold range mode
ON or 1 Auto range mode

Query response is 0 or 1.

4263B

[[:SENSe]:FIMPedance:RANGe[:UPPer]
<numeric_value>[MOHM|OHM|KOHM|MAOHM]

Sets or queries the measurement range.

<numeric_value> is,

<i>numeric</i>	0.1 (= 100 m)(Allows above 315 mV), 1, 10, 100, 1000 (= 1 k), 10000 (= 10 k), 100000 (= 100 k)(Not allows at 100 kHz), 1000000 (= 1 M) (Ω)(Not allows at 100 kHz)
MINimum	0.1 (Ω)
MAXimum	1000000 (=1 M) (Ω)
UP	Moves to an upper range.
DOWN	Moves to a lower range.

Query response is a numeric value in <NR3> format.

[[:SENSe]:FUNctIon:CONCurrenT { ON | OFF | 1 | 0 }

(Option 001 only)

Indicates whether the [[:SENSe]:FUNctIon[:ON] command allows up to two <sensor_function>s at the same time. Two <sensor_function>s are required to measure the transformer parameters (DCR, L2, N, M, and R2). For details, see “To Select the Measurement Parameter” in Chapter 4.

OFF or 0	Allows only one <sensor_function> at a time.
ON or 1	Allows up to two <sensor_function>s at a time.

This command works with the [[:SENSe]:FUNctIon[:ON] command and the :CALCulate{1|2}:FORMat command to select measurement parameter.

When setting [[:SENSe]:FUNctIon:CONCurrenT from OFF to ON, or ON to OFF, the [[:SENSe]:FUNctIon[:ON], :CALCulate{1|2}:FORMat settings are affected as follows.

Command	[[:SENSe]:FUNctIon:CONCurrenT	
	OFF to ON	ON to OFF
[[:SENSe]:FUNctIon[:ON]	Not affected.	'FIMPedance'
:CALCulate1:FORMat	Not affected.	LS
:CALCulate2:FORMat	Not affected.	Q

Query response is 0 or 1.

[[:SENSe]:FUNctIon:COUnT?

(Option 001 only)

Returns the number of <sensor_function>s which are set by [[:SENSe]:FUNctIon[:ON] command. (query only)

Query response is 1 or 2.

[[:SENSe]:FUNctIon[:ON] <sensor_function>

Sets the specified measurement function ON. Or, queries which measurement function is ON. The measurement functions of 4263B are shown in Table 5-3.

Please refer to Table 5-2 of the “CALCulate Subsystem” regarding the selection of measurement parameters.

Table 5-3. Measurement Function Selection

When SENSE:FUNCTION:CONCurrent is OFF	
<sensor_function>	Measurement Function
'FIMPedance'	Impedance measurement (equivalent series circuit)
'FADMittance'	Admittance measurement (equivalent parallel circuit)
When SENSE:FUNCTION:CONCurrent is ON ¹	
<sensor_function>	Measurement Function
'FIMPedance', 'FRESistance'	DCR measurement (equivalent series circuit) ²
'FADMittance', 'FRESistance'	DCR measurement (equivalent parallel circuit) ²
'VOLTage:AC', 'IMPedance'	Transformer winding ratio measurement ²
'IMPedance', 'FADMittance'	Transformer mutual inductance measurement ²
'IMPedance', 'RESistance'	Transformer resistance measurement ²

¹ Only with Option 001. In all other cases, the SENSE:FUNCTION:CONCurrent command is always OFF.

² Only valid when Option 001 is present.

The [:SENSE]:FUNCTION[:ON] command is used in collaboration with the [:SENSE]:FUNCTION:CONCurrent command.

- When SENS:FUNC:CONC is set to OFF, the SENS:FUNC:ON command selects only one <sensor_function>. That is, when any one <sensor_function> is selected, the others will all be cancelled automatically.
- When SENS:FUNC:CONC is set to ON, the SENS:FUNC:ON command selects two <sensor_function>s. For example, when

```
SENS:FUNC "FRES","FIMP" <set to equivalent series circuit DCR measurement>
```

is sent, "FRESistance" and "FIMPedance" become valid, and the other <sensor_function>s are all cancelled. Regardless of the <sensor_function> transmission sequence, the same state is obtained.

- When SENS:FUNC:CONC is set from ON to OFF, SENS:FUNC:ON is also automatically set to "FIMPedance". (The other <sensor_function>s are all cancelled.)

Query response is "FADM", or "FIMP", or "IMP", "VOLT:AC", or "FIMP", "FRES", or "FADM", "FRES", or "IMP", "FADM", or "IMP", "RES".

SOURCE Subsystem

COMMAND	PARAMETER
SOURCE	
:FREQUENCY	
[:CW]	<numeric_value> [HZ KHZ]
:VOLTAGE	
[:LEVEL]	
[:IMMEDIATE]	
[:AMPLITUDE]	<numeric_value> [MV V]
:OFFSET	<numeric_value> [MV V]
:SOURCE	{INTERNAL EXTERNAL}
:STATE	<Boolean>

:SOURCE:FREQUENCY[:CW] <numeric_value> [HZ|KHZ]

Sets or queries the test signal frequency.

<numeric_value> is,

<i>numeric</i>	100, 120, 1000 (= 1 k), 10000 (= 10 k), 20000 (= 20 k; option 002 only), 100000 (= 100 k) (Hz)
MINimum	100 (Hz)
MAXimum	100000 (= 100 k) (Hz)

Query response is a numeric value in <NR3> format.

:SOURCE:VOLTAGE[:LEVEL][:IMMEDIATE][:AMPLITUDE] <numeric_value> [MV|V]

Sets or queries the test signal level.

<numeric_value> is,

<i>numeric</i>	20 to 1000 (mV), (5 mV step)
MINimum	20 (mV)
MAXimum	1 (V)

Query response is a numeric value in <NR3> format.

:SOURCE:VOLTAGE[:LEVEL][:IMMEDIATE]:OFFSET <numeric_value> [MV|V]

Sets or queries the DC bias voltage.

<numeric_value> is,

<i>numeric</i>	0, 1.5, 2 (V)
MINimum	0 (V)
MAXimum	2 (V)

Query response is a numeric value in <NR3> format.

:SOURCE:VOLTAGE[:LEVEL][:IMMEDIATE]:OFFSET:SOURCE { INTERNAL | EXTERNAL }

Sets or queries the DC bias voltage source: Internal or External.

INTERNAL	Internal voltage source.
EXTERNAL	External voltage source.

Query response is INT or EXT.

:SOURce:VOLTage[:LEVel][:IMMediate]:OFFSet:STATe { ON | OFF | 1 | 0 }

Sets or queries whether or not DC bias output is enabled.

OFF or 0 Disables DC bias output.

ON or 1 Enables DC bias output.

Query response is 0 or 1.

STATus Subsystem

The STATus Subsystem commands controls the Operation Status and Questionable Status registers in the status-reporting structures (See “Status Reporting Structure”).

COMMAND	PARAMETER
STATus	
:OPERation	
:CONDition?	
:ENABle	<numeric_value>
[:EVENTt]?	
:PRESet	
:QUEStionable	
:CONDition?	
:ENABle	<numeric_value>
[:EVENTt]?	

:STATus:OPERation[:EVENTt]?

Returns the contents of the event register of the Operation Status Register group. Reading the event register clears it. (Query only)

Query response is a numeric value in <NR1> format.

:STATus:OPERation:CONDition?

Returns the contents of the condition register of the Operation Status Register group. Reading the condition register does not clear it. (Query only)

Query response is a numeric value in <NR1> format.

:STATus:OPERation:ENABle <numeric_value>

Sets the enable register of the Operation Status Register Group.

<numeric_value>:

numeric Decimal expression of the contents of the register

Query response is a numeric value in <NR1> format.

:STATus:PRESet

Clears the Operation Status and Questionable Status groups. Both the event and enable registers are cleared. (No query)

:STATus:QUEStionable[:EVENTt]?

Returns the contents of the event register of the Questionable Status Register group. (Query only)

Query response is always , because the 4263B has no operation to report the event to the Questionable Status Event Register.

:STATus:QUEStionable:CONDition?

Returns the contents of the condition register of the Standard Questionable Status Register group. (Query only)

Query response is always , because the 4263B has no operation to report the event to the Questionable Status Event Register.

:STATus:QUESTionable:ENABle<numeric_value>

Sets or queries the enable register of the Questionable Status Register group.

<numeric_value> is,

numeric_value Decimal expression of the contents of the register.

The 4263B has no operation to report the event to the Questionable Status Event Register.

Query response is a numeric value in <NR1> format.

4263B

SYSTEM Subsystem

The SYSTEM subsystem reports the firmware version and error, sets the beeper, locks the front-panel keys, and defines the power line frequency.

COMMAND	PARAMETER
SYSTEM	
:BEEPer	
[:IMMediate]	
:STATe	<Boolean>
:ERRor?	
:KLOCK	<Boolean>
:LFRequency	<numeric_value>
:PRESet	
:VERSion?	

:SYSTEM:BEEPer[:IMMediate]

Produces a beep immediately. (no query)

:SYSTEM:BEEPer:STATe {ON|OFF|1|0}

Sets or queries if the beeper is enabled.

ONor1 Enables the beeper. The beeper mode is defined by :CALCulate
 {1|2}:LIMit:BEEPer

OFFor 0 Disables all beeper functions, including the error beep.

Query response is 0 or 1.]

:SYSTEM:ERRor?

Return the number and message of existing error in the 4263B's error queue. (Query only)

:SYSTEM:KLOCK {ON|OFF|1|0}

Sets or queries whether the front-panel keys of the 4263B are locked,

ONor 1 Locks the front-panel keys.

OFFor 0 Does not lock the front-panel keys.

Query response is 0 or 1.

:SYSTEM:LFRequency <numeric_value>

Sets or queries the 4263B's operating power line frequency. <numeric_value>: is,

numeric 50,60 (Hz)

Query response is a numeric value in <NR3> format.

:SYSTEM:PRESet

Reset the 4263B to the default state. (no query)

The reset state is as follows.

Item	Reset key	:SYST:PRES ¹	*RST ¹	Stored in
Test signal frequency	1 kHz	←	←	Back-up memory
Test signal level	1 V	←	←	Back-up memory
Measurement parameter	Cp-D	←	←	Back-up memory
Deviation measurement	OFF	←	←	Back-up memory
Deviation reference values	Cleared	←	←	Back-up memory
Measurement range	Auto	←	←	Back-up memory
Measurement time mode	Medium	←	←	Back-up memory
Averaging rate	1	←	←	Back-up memory
Trigger mode	Internal	←	←	Back-up memory
Trigger delay time	0 s	←	←	Back-up memory
Contact Check ON/OFF state	OFF	←	←	Back-up memory
Comparator ON/OFF state	OFF	←	←	Back-up memory
Comparator limits	Cleared	←	←	Back-up memory
Display mode	Measure Display	←	←	Back-up memory
DC bias source	Internal	←	←	Back-up memory
DC bias setup	0 V	←	←	Back-up memory
DC bias ON/OFF state	OFF	←	←	None
Correction ON/OFF state	ON	←	OFF	None
Correction method	OPEN/SHORT	←	←	EEPROM
Correction data	Cleared	←	No effect	EEPROM
Cable length	0 m	←	←	EEPROM
Beep ON/OFF state	ON	←	←	EEPROM
Beep mode	FAIL mode	←	←	EEPROM
Data transfer format	ASCII	←	←	EEPROM
Power line frequency	No effect	←	←	EEPROM
GPIB Address	No effect	←	←	EEPROM
Key lock	N/A	No effect	OFF	None
:INIT:CONT	ON	←	OFF	None

¹ “←” indicates the value is the same as what’s indicated to the left.

:SYSTem:VERSion?

Returns the value corresponding to the SCPI version to which the instrument complies. (Query only)

The query response is YYYY.V.

Where,

YYYY Year-version
V Revision number for the year

TRIGger subsystem

The TRIGger subsystem controls the measurement trigger functions.

COMMAND	PARAMETER
TRIGger	
:DElay	<numeric_value> [MS S]
[:IMMediated]	
:SOURce	{BUS EXTErnal INTernAl MANual}

:TRIGger:DElay <numeric_value> [MS|S]

Sets or queries the trigger delay time.

<numeric_value> is,

numeric 0 to 9.999 (s)

MINimum 0 (s)[

MAXimum 9.999 (s)

The following units can be used for <numeric_value>.

 MS:millisecond S:second

Query response is a numeric value in <NR3> format.

:TRIGger[:IMMediate]

Causes the trigger to execute a measurement, regardless of the trigger state. (No query)

:TRIGger:SOURce {BUS|EXTErnal|INTernAl|MANual}

Sets or queries the trigger mode.

BUS Sets the BUS trigger mode.

EXTErnal Sets the External trigger mode.

INTernAl Sets the Internal trigger mode.

MANual Sets the Manual trigger mode,

Query response is BUS,EXT',INT,or MAN.

Common Commands

*CLS

Clears the Status Byte Register, the Standard Event Status Enable Register.

*ESE<numeric_value>

Sets or queries the bits of the Standard Event Status Register. (Query only)

Query response is a numeric value in <NR1> format.

*ESE?

*The ESE? (Event Status Enable) Query reads the bits of the Standard Event Status Enable Register.

Query response is a decimal register value in <NR1> format.

*ESR?

Queries an identification string which consists of four fields separated by commas. (Query only)

If the Standard Event Status Register is read with this query, its contents are cleared.

Query response is a numeric value in <NR1> format.

*IDN?

Queries an identification string which consists of four fields separated by commas. (Query only)

Query response is <field 1>, <field 2>, <field 3>, <field 4>.

where,

<i>field 1</i>	Manufacturer
<i>field 2</i>	Model number (always 4263B)
<i>field 33</i>	Serial number is HP format (like 2419J00100)
<i>field 44</i>	Firmware version number (like 01.00)

*LRN?

Returns a sequence of commands which defines the 4263B's current state. (Query only)

*OPC

Tells the 4263B to set bit 0 (OPC bit) in the Standard Event Status Register when it completes all pending operations.

*OPC?

Tells the 4263B to place an ASCII character 1 into the Output Queue when it completes all pending operations.

*OPT?

Queries the options installed. (Query only)

*RCL<numeric_value>

Recall the instrument state which was stored in the specified register number. The 4263B has 10 available storage registers. (No query)

4263B

*<numeric_value>*is,
numeric_value 0 to 9

*RST

Returns the 4263B to the default state and sets the following commands:

```
INITiate:CONTInuous OFF  
[SENSe]:CORRection[:STATe] OFF  
SYSTem:KLOCK OFF
```

(No query)

*SAV<numeric_value>

Saves the instrument state in the specified register number. The 4263B has 10 available storage registers. (No query)

*<numeric_value>*is,
numeric_value 0 to 9

*SRE<numeric_value>

Sets the bits of the Status Byte Enable Register.

<numeric_value>:

numeric_value A decimal expression of the contents of the Status Byte Enable Register
(Bit 6 must always be set to 0)

*SRE?

Queries the contents of the Status Byte Enable Register.

Query response is a numeric value in <NR1> format.

*STB?

Queries the contents of the Status Byte Register. (Query only) Query response is a numeric value in <NR1> format.

*TRG

Triggers the 4263B when the trigger mode is set to Bus trigger mode. (No query)

*TST?

Executes an internal self-test and the test result as the sum of the error cords of all existing errors. If there is no error the 4263B returns a 0.

Test Item	Error Code
1. RAM	1
2. EPROM	2
3. Calibration data (EEPROM)	4
4. User's data (EEPROM)	8
5. A/D converter	16
6. Backup RAM	32

Query response is a numeric value in <NR1> format.

***WAI**

Makes the 4263B wait until all previously sent commands are completed. (No query)

Status Reporting Structure

This section provides information about the status reporting structure for Service Request functions which correspond to SCPI.

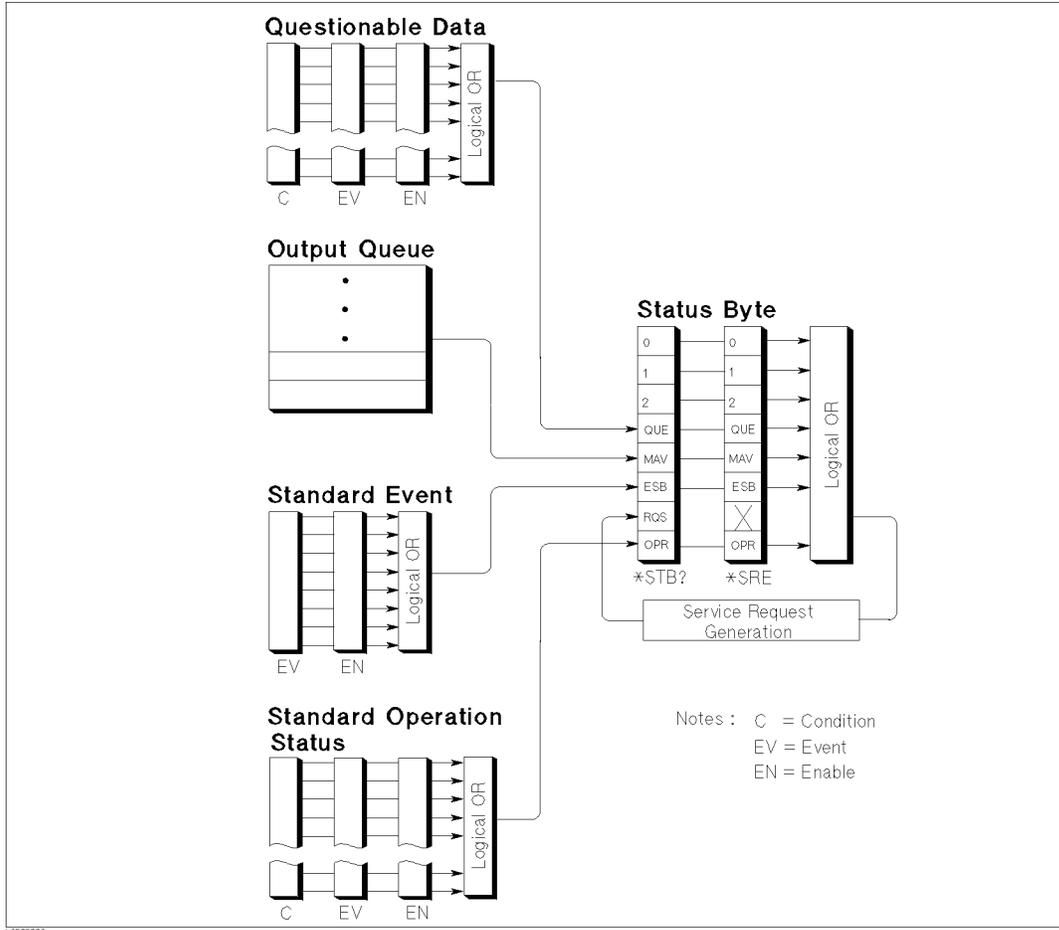

Figure 5-2. Status Reporting Structure

Service Request (SRQ)

The 4263B can send an SRQ (Service Request) control signal when it requires the controller to perform a task. When the 4263B generates an SRQ, it also sets Bits 6 of the Status Byte Register, RQS (Request Service) bit. Service Request Enable Register allows an application programmer to select which summary messages in the Status Byte Register may cause service requests. (Illustrates in status-byte.)

Status Byte Register

The Status Byte Register is composed of eight bits that summarize an overlaying status data structure.

The Status Byte Register can be read using either *STB? or SPOLL, which return a decimal expression of the contents of the register (equal to the sum of the total bit weights of all the bits set to “1”).

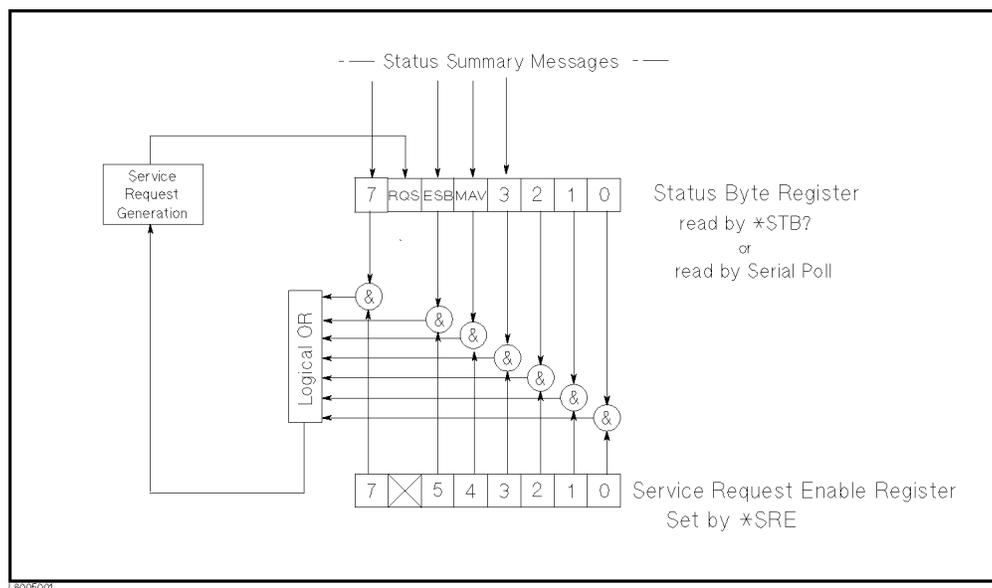

Figure 5-3. Status Byte Register

Table 5-4. Status Byte Assignments

Bit No.	Bit Weight	Description
7	128	Operation Status Register Summary Bit
6	64	Request Service Bit — This bit is set when any enabled bit of the Status Byte Register has been set, which indicates 4263B has at least one reason for requesting service. SPOLL resets this bit.
5	32	Standard Event Status Register Summary Bit
4	16	Message Available Bit — This bit is set whenever the 4263B has data available in the Output Queue, and is reset when the available data is read.
3	8	Questionable Status Register Summary Bit.
2~0		Always 0 (zero)

Standard Event Status Register

The Standard Event Status Register is frequently used and is one of the simplest. You can program it using GPIB common commands, *ESE and *ESR?. Refer to *ESE command and *ESR? command in “Command Reference”.

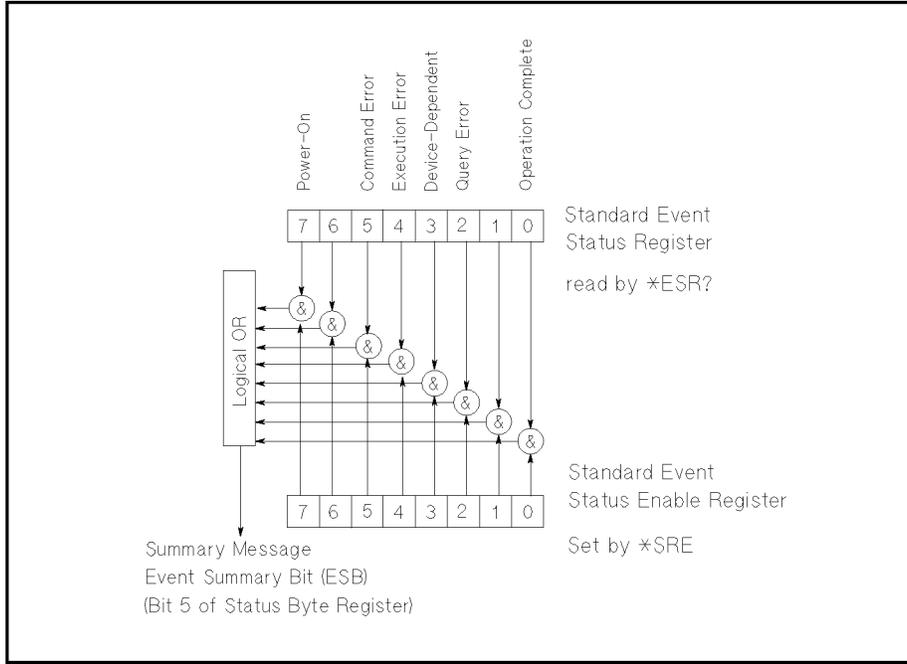

Figure 5-4. Standard Event Status Register

Table 5-5. Standard Event Status Register Assignments

Bit No.	Bit Weight	Description
7	128	Power-On Bit — This bit is set when the 4263B has been turned OFF and then ON since the last time this register was read.
6		Always 0 (zero)
5	32	Command Error Bit — This bit is set if the following command errors occur. <ul style="list-style-type: none"> • An IEEE 488.2 syntax error occurred. • The 4263B received a Group Execute Trigger (GET) inside a program message.
4	16	Execution Error Bit — This is set when a parameter of a GPIB command was outside of its legal input range or was otherwise inconsistent with the 4263B's capabilities.
3	8	Device-Dependent Error Bit — This bit is set when so many errors have occurred that the error queue is full.
2	4	Query Error Bit — This bit is set when reading data from the output buffer and no data was present, or when the data was lost.
1		Always (zero)
0	1	Operation Complete Bit — This bit is set when the 4263B has completed all selected pending operations before sending the *OPC command.

Standard Operation Status Group

The 4263B provides two Standard Operation Status group — Operation Status Register group and Questionable Status Register group — which can be accessed using the STATUS subsystem commands. (Refer to STATUS subsystem in “GPIB Commands”.) As a beginner, you will rarely need to use this group. The individual bit assignment of these registers are given in “Operation Status Register” and “Questionable Status Register” later in this section.

Each group includes a condition register an event register, and an enable register. (Illustrated in Figure 5-5.)

The condition register reflects the internal states of the 4263B. So each time the 4263B's condition is changed, its condition bit is changed from “0” to “1”, or from “1” to “0”.

The event register's bits correspond to the register's bits. A transition filter reports an event to the event register, when a condition register bit changes from “1” to “0” for all bits except for bit no. 8 and 9. For bit no's 8 and 9, when a condition register bit changes from “0” to “1”.

The enable register enable the corresponding bit in the event register to set the status summary bit, bit 7 or bit 3, of the Status Byte Register.

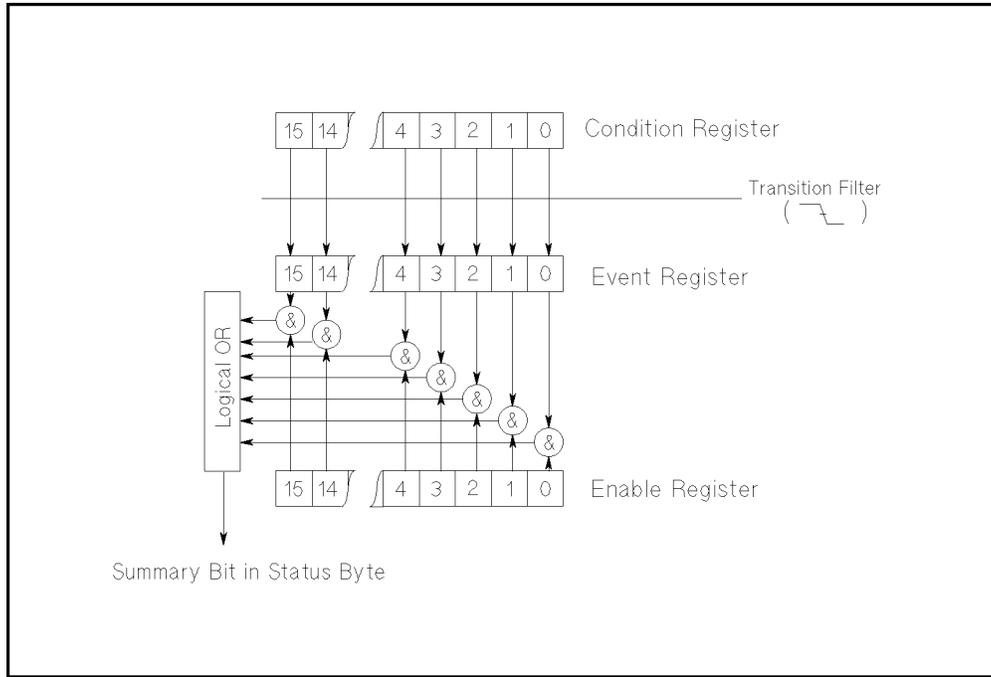

L8005002

Figure 5-5. Standard Operation Status Group Structure

Operation Status Register

The Operational Status Register group provides information about the state of the 4263B measurement system.

Table 5-6. Operation Status Condition Register Assignments

Bit No.	Bit Weight	Description
10-15		Always 0 (zero)
9	512	BUF2 fullness — This bit is set when the BUF2 is full.
8	256	BUF1 fullness — This bit is set when the BUF1 is full.
7	128	Correcting — This bit is set when the correction data measurement is in progress.
6		Always 0 (zero)
5	32	Waiting for Trigger — This bit is set when the 4263B can accept a trigger.
4	16	Measuring — This bit is set when the 4263B is actively measuring.
3		Always 0 (zero)
2	4	Ranging — This bit is set when the 4263B is currently changing its range.
1	2	Settling — The 4263B is waiting for signals it controls to stabilize enough to begin a measurement.
0		Always 0 (zero)

Table 5-7. Operation Status Event Register Assignments

Bit No.	Bit Weight	Description
10 - 15		Always 0 (zero)
9	512	This bit is set when the BUF2 has become full.
8	256	This bit is set when the BUF1 has become full.
7	128	This bit is set when the correction data measurement has completed.
6		Always 0 (zero)
5	32	This bit is set when the 4263B has become able to accept a trigger.
4	16	This bit is set when the measurement has completed.
3		Always 0 (zero)
2	4	This bit is set when the ranging has completed.
1	2	This bit is set when the settling has completed.
0		Always 0 (zero)

Questionable Status Register

The 4263B has no operation to report the event to the Questionable Status Register group, all of whose bits are always 0. This register is available to keep consistency with other SCPI compatible instruments.

Table 5-8. Questionable Status Register Assignments

Bit No.	Bit Weight	Description
15~0		Always 0 (Zero)

Trigger System

This section provides information about trigger system of the 4263B. SCPI defines a common trigger model for several types of instruments.

Information on the trigger system requires more technical expertise than most other topics covered in this chapter. But you can avoid having to learn the information in this section by using the `:INITiate` commands to make your measurements.

4263B Trigger System Configuration

The trigger system synchronizes the 4263B measurement with specified events.. Event includes GPIB trigger command or input pulse on Ext Trigger terminal. The trigger system also allows you to specify the number of times to repeat a measurement and the delays between measurements.

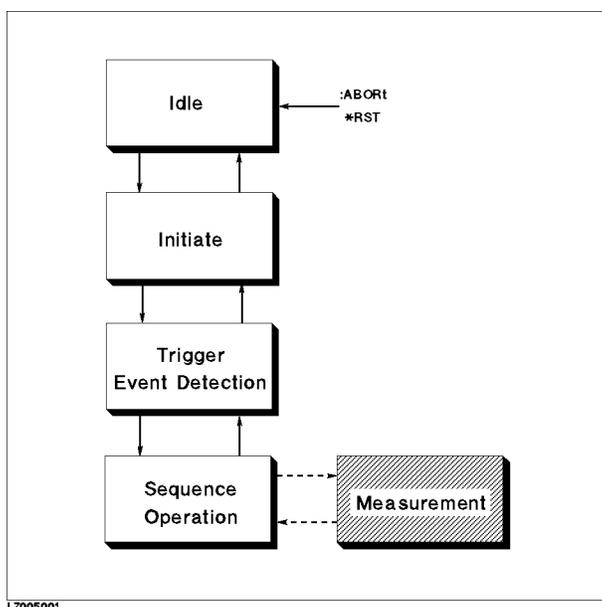

Figure 5-6. Trigger System Configuration

Figure 5-6 shows the configuration of the 4263B trigger system. Each undashed block is called a **trigger state**. The 4263B moves between adjacent states depending on its conditions. The power ON state is called the **Idle** state. You can force the 4263B to the idle state using the `:ABORT` or `*RST` command. The **Initiate** and **Trigger Event Detection** state branches to next state, regardless of whether the 4263B satisfies the specified conditions or not. The **Sequence Operation** state signals the instrument hardware to take a measurement and listens for a signal saying that measurement has been taken.

IDLE State

The trigger system remains in the Idle state until it is initiated by `:INITiate:IMMediate` or `:INITiate;CONTinuous` ON. Once one of these conditions is satisfied, the trigger system exits downward to the Initiate state. Note that `*RST` sets `:INITiate:CONTinuous` OFF.

4263B

Initiate State

If the trigger system is on a downward path, it travels directly through the Initiate state without restrictions. If the trigger system is on an upward path, and :INITiate:CONTinuous is ON, then it exits downward to an Trigger Event Detection state. If the trigger system is on an upward path and :INITiate:CONTinuous is OFF, then it exits upward to the idle state.

Trigger Event Detection State

If the trigger system is on a downward path, it branches as follows.

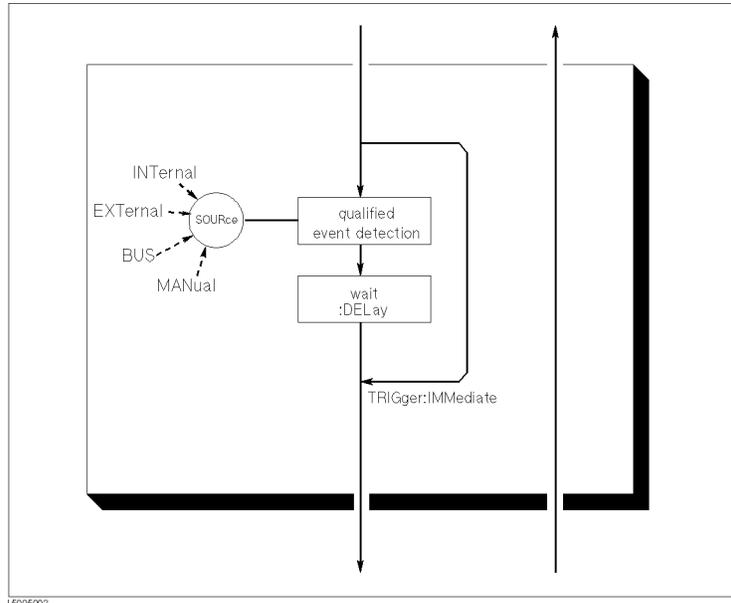

Figure 5-7. Inside an Trigger Event Detection State

SOURCE	The :TRIGger:SOURce command specifies which particular input can generate the event required to continue the downward path.
DELay	The TRIGger:DELay command allows you to specify a time delay after trigger signal is detected. For example, you may want to delay acquiring data until 5 ms after the positive edge to allow the measured signal to settle. Sending *RST sets :TRUGger:DELay to zero.
IMMediate	The :TRIGger:IMMediate command bypasses event detection, DELay qualifications one time. The upward path through the Trigger Event Detection state contains only one condition. If the condition is satisfied, the trigger system exits upward.

Sequence Operation State

The downward entrance to the Sequence Operation state forces the 4263B to start a measurement. An upward exit is not allowed until the measurement is complete.

Data Transfer Format

AScii

Numeric data is transferred as ASCII bytes in <NR1> (integer), <NR2> (fixed point) or <NR3> (floating point) formats, as appropriate. The numbers are separated by commas as specified in IEEE 488.2.

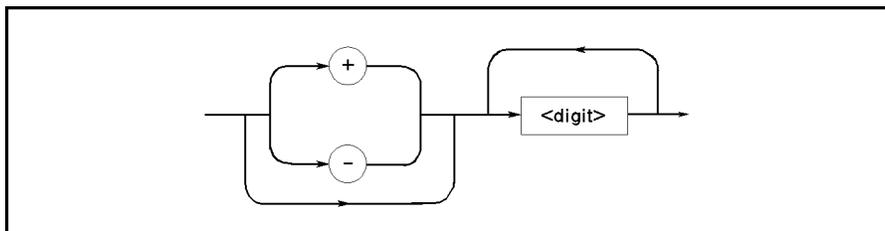

Figure 5-8. NR1 Format

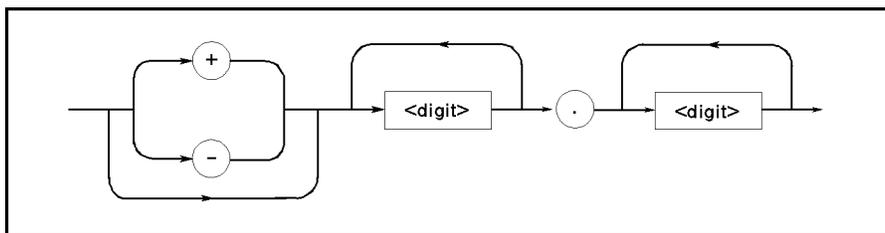

Figure 5-9. NR2 Format

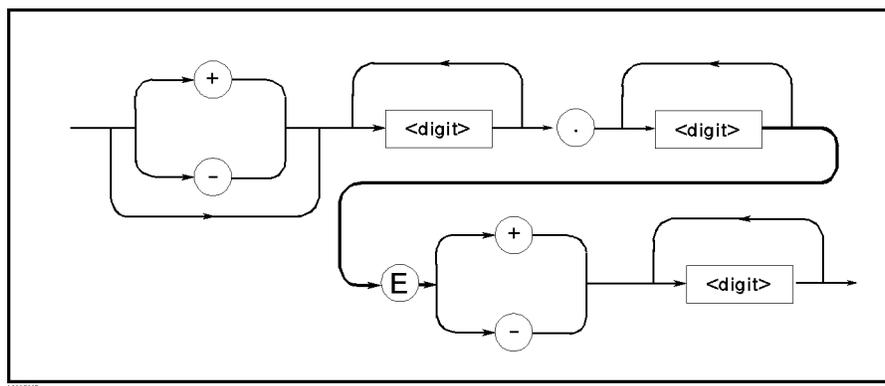

Figure 5-10. NR3 Format

For example, expressions for “1000” are,

1000	<NR1> format
1000.0	<NR2> format
1.0E3	<NR3> format

REAL

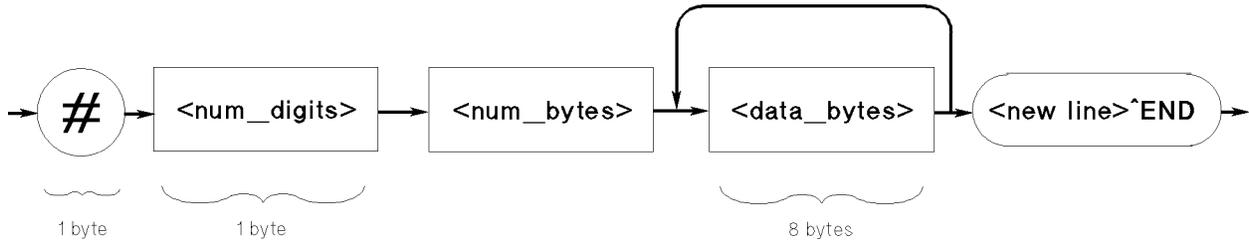
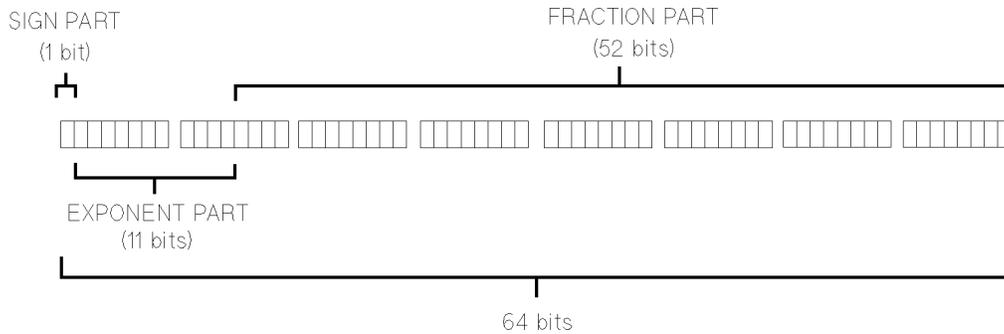

Figure 5-11. REAL Data Format

This data field is initiated by a unique code, the number sign (#). The second byte, “<num_digits>” designates the number of the bytes for the “<num_bytes>”, “<num_bytes>” designates “<data_bytes>” length. “<new line>&END” is the response message terminator.

“<data_bytes>” contains the data in IEEE 754 floating point numbers of 64-bits. This is the same data format used by the HP Technical computers, such as the HP 9000 series 200/300 computers.



The real number RN represented in floating point format is provided by the following format.

- When $0 < e < 2047$ (11111111111₂)
 $RN = (-1)^s \times 2^{(EXP-1023)} \times (1 + f/2^{52})$
- When $e = 0$
 $RN = (-1)^s \times 2^{-1022} \times (f/2^{52})$
- When $e = 0, f = 0$
 $RN = 0$

Where,

- s Value of sign part (binary)
- e Value of exponential part (binary)
- EXP Decimal expression of exponential part
- f Decimal expression of fractional part

Application Measurement

This chapter provides actual measurement examples as follows:

- Measuring Electrolytic Capacitors
- Measuring Transformers

Measuring Electrolytic Capacitors (Sample Program)

This example shows how to measure electrolytic capacitors using a handler.

1. Set up the measurement system. The following figure shows a typical system.

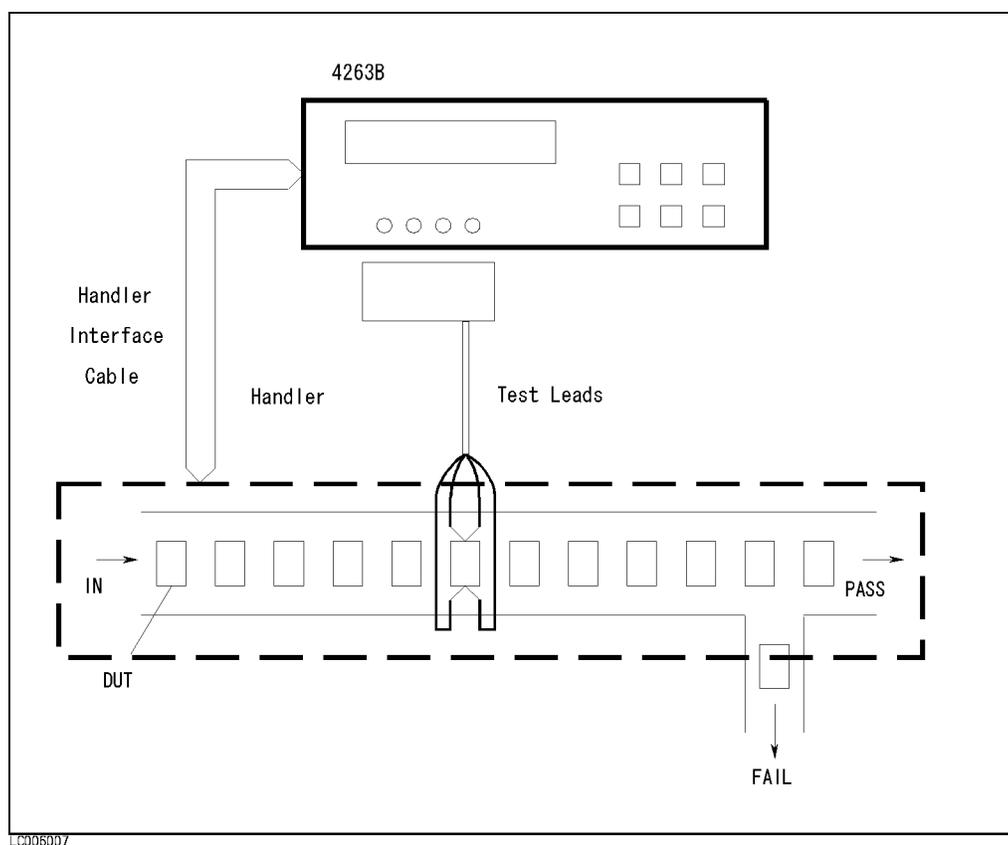

Figure 6-1. Measuring Electrolytic Capacitors

2. Run the following sample program.

```

10      !
20      OPTION BASE 1
30      DIM St(2,200),Dat(2,200),Comp(2,200)
40      Hp_ib=7
50      ASSIGN @Hp4263 TO 717
60      ASSIGN @Binary TO 717;FORMAT OFF
70      !
80      OUTPUT @Hp4263;"*RST"
90      OUTPUT @Hp4263;"*CLS"
100     !
110     OUTPUT @Hp4263;":SENS:FUNC 'FIMP'"
120     OUTPUT @Hp4263;":CALC1:FORM CS"
130     OUTPUT @Hp4263;":CALC2:FORM D"
140     !
150     OUTPUT @Hp4263;":SOUR:VOLT 1"
160     OUTPUT @Hp4263;":SOUR:FREQ 120"
170     OUTPUT @Hp4263;":FIMP:APER 0.025"
180     OUTPUT @Hp4263;":SENS:FIMP:RANG:AUTO OFF"
190     OUTPUT @Hp4263;":SENS:FIMP:RANG 1E3"
200     !
210     DISP "Open the test leads, then press the 'Continue'."
220     PAUSE
230     DISP "OPEN Correction"
240     OUTPUT @Hp4263;":SENS:CORR:COLL STAN1"
250     OUTPUT @Hp4263;"*0PC?"
260     ENTER @Hp4263;A
270     !
280     DISP "Short the test leads, then press the 'Continue'."
290     PAUSE
300     DISP "SHORT Correction"
310     OUTPUT @Hp4263;":SENS:CORR:COLL STAN2"
320     OUTPUT @Hp4263;"*0PC?"
330     ENTER @Hp4263;A
340     !
350     DISP "Connect DUT, then press the 'Continue'."
360     PAUSE
370     DISP
380     !
390     OUTPUT @Hp4263;":CALC1:LIM:UPP 1.05E-6; LOW 0.95E-6"
400     OUTPUT @Hp4263;":CALC2:LIM:UPP 0.1; LOW:STAT OFF"
410     OUTPUT @Hp4263;":CALC1:LIM:STAT ON"
420     OUTPUT @Hp4263;":DISP OFF"
430     OUTPUT @Hp4263;":TRIG:SOUR EXT"
440     OUTPUT @Hp4263;":FORM REAL"
450     !
460     OUTPUT @Hp4263;":DATA:POIN BUF1,200"
470     OUTPUT @Hp4263;":DATA:POIN BUF2,200"
480     OUTPUT @Hp4263;":DATA:FEED BUF1,'CALC1'"
490     OUTPUT @Hp4263;":DATA:FEED BUF2,'CALC2'"
500     OUTPUT @Hp4263;":DATA:FEED:CONT BUF1,ALW"
510     OUTPUT @Hp4263;":DATA:FEED:CONT BUF2,ALW"
520     !

```

4263B

```
530 OUTPUT @Hp4263;":STAT:OPER:ENAB ";DVAL("0000001000000000",2)
540 OUTPUT @Hp4263;":*SRE ";DVAL("10000000",2)
550 OUTPUT @Hp4263;":INIT:CONT ON"
560 !
570 ! Triggering
580 !
590 ON INTR Hp_ib GOTO Buffer_full
600 ENABLE INTR Hp_ib;2
610 LOOP
620 END LOOP
630 !
640 Buffer_full:OFF INTR
650 DISP "Buffer full."
660 OUTPUT @Hp4263;":DATA? BUF1"
670 ENTER @Binary USING "#,6A";A$
680 FOR I=1 TO 200
690     ENTER @Binary;St(1,I),Dat(1,I),Comp(1,I)
700 NEXT I
710 ENTER @Binary USING "#,A";A$
720 !
730 OUTPUT @Hp4263;":DATA? BUF2"
740 ENTER @Binary USING "#,6A";A$
750 FOR I=1 TO 200
760     ENTER @Binary;St(2,I),Dat(2,I),Comp(2,I)
770 NEXT I
780 ENTER @Binary USING "#,A";A$
790 !
800 FOR I=1 TO 200
810     PRINT "CS: ";Dat(1,I),"Comp: ";Comp(1,I),"D: ";Dat(2,I),"Comp: ";Comp(2,I)
820 NEXT I
830 END
```

Figure 6-2. Sample Program to Measure Electrolytic Capacitors

Lines 80 and 90	Reset the 4263B and clears the status byte register.
Lines 110 to 130	Set measurement parameters to Cs-D.
Line 150	Sets test signal level to 1 V.
Line 160	Sets test signal frequency to 100 Hz.
Line 170	Sets measurement time mode to Short.
Line 180 and 190	Set measurement range to 1 k Ω .
Lines 210 to 260	Perform an OPEN correction.
Lines 280 to 330	Perform a SHORT correction.
Lines 350 to 370	Prompt the operator to connect the DUT.

Caution



Before you measure a capacitor, be sure the capacitor is fully discharged. Internal input circuit of the 4263B is protected when a charged capacitor is connected. However the protection is not perfect, that is, the maximum capacitor voltage is limited (see Figure 8-2). A capacitor is charged for a insertion resistance measurement that is usually performed before C and ESR measurements. If the capacitor is not fully discharged after the insertion

resistance measurement, the 4263B may be broken down at the C and ESR measurements. To avoid the breakdown of the 4263B, add double (or triple) processes for discharging the capacitor in an automatic measurement system using a handler.

Line 390	Sets the comparator limit values for the primary parameter (Cs); the lower limit to 95 μ F and the upper limit to the 105 μ F.
Line 400	Sets the comparator limit values for the secondary parameter (D); the lower limit to OFF and the upper limit to 0.1.
Line 410	Enables the comparator function.
Line 420	Clears the LCD display.
Line 430	Sets trigger source mode to External.
Line 440	Sets data transfer format to 64-bit real transfer format.
Lines 460 to 510	Set size of data buffers BUF1 and BUF2 to 200, set to feed the Cs to BUF1 and D to BUF2, and set to feed data into the data buffers whenever new data is available.
Lines 530 and 540	Enable the BUF1 and BUF2 full bits of the operation status register, and the operation status register summary bit of the status byte register.
Line 570	Triggers the measurement from the external trigger source.
Lines 590 to 650	Wait until the data buffers are full.
Lines 660 to 710	Retrieve Cs data which is held in BUF1.
Lines 730 to 780	Retrieve D data which is held in BUF2.
Lines 800 to 820	Print the measurement data.

Note



When measuring capacitance of large valued capacitors, set the trigger delay time to prevent the transient caused by the DUT (capacitor) and the test signal source resistor.

For example, when the test signal frequency is 100/120 Hz and the measurement time mode is Short, the following figure shows the relation between the trigger delay time and the additional error.

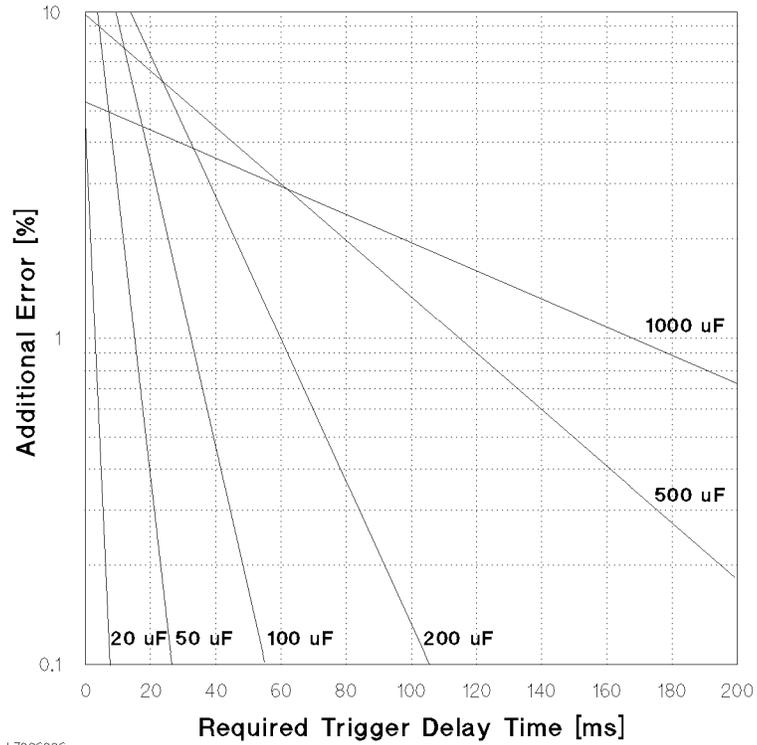

L7006006

Measuring Transformers

This example shows how to measure transformers.

1. Connect the 16060A test fixture to the UNKNOWN terminals. Connect the furnished BNC test leads to the 16060A.

2. Reset the 4263B.

Press   to display the reset menu. Select **Yes** using  or , and press .

3. Select test signal frequency.

Press  to display the frequency setting menu. Select the desired frequency using  or  (for example, 1kHz), and press .

4. Select test signal level.

Press  to display the level setting menu. Set the desired level using the numeric key and the engineering key (or  ) , and press .

5. Select the L2-N measurement mode.

Press  . Select L2 using  or , and press .

Then select N using  or , and press .

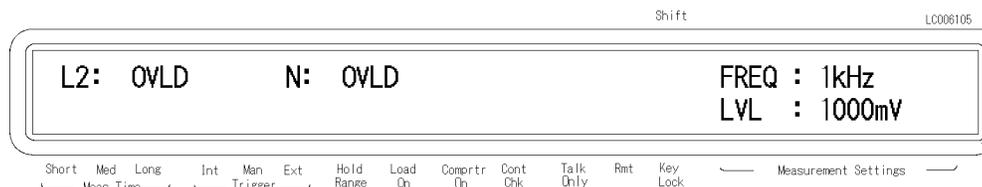

- a. Perform the OPEN correction to cancel the test fixture's stray admittance.

- i. Short the test leads corresponding to the "A" and "B" terminals of the 16060A. Short the test leads corresponding to the "COMMON" terminals of the 16060A.

- ii. Press   to display the OPEN correction menu. Select **OpenMeas** using  or , and press .

- b. Cancel the test fixture's residual impedance using the deviation measurement function.

Note When using the 16060A, do not use the 4263B's SHORT correction function.



4263B

- i. Short all the test leads connected to the 16060A's "A", "B", and "COMMON" terminals.
 - ii. Press   to display the deviation measurement menu. Select Δ RefEnt using  or  , and press  .
 - iii. Press  to measure the reference value of the primary parameter, and press  to set the measurement result as the reference.
 - iv. Press  to measure the reference value of the secondary parameter, and press  to set the measurement result as the reference.
 - v. Select Prim, and select Δ ABS. Then exit the deviation measurement menu by selecting Exit.
- c. Connect the alligator clips to the transformer to be measured as shown in Figure 6-3.

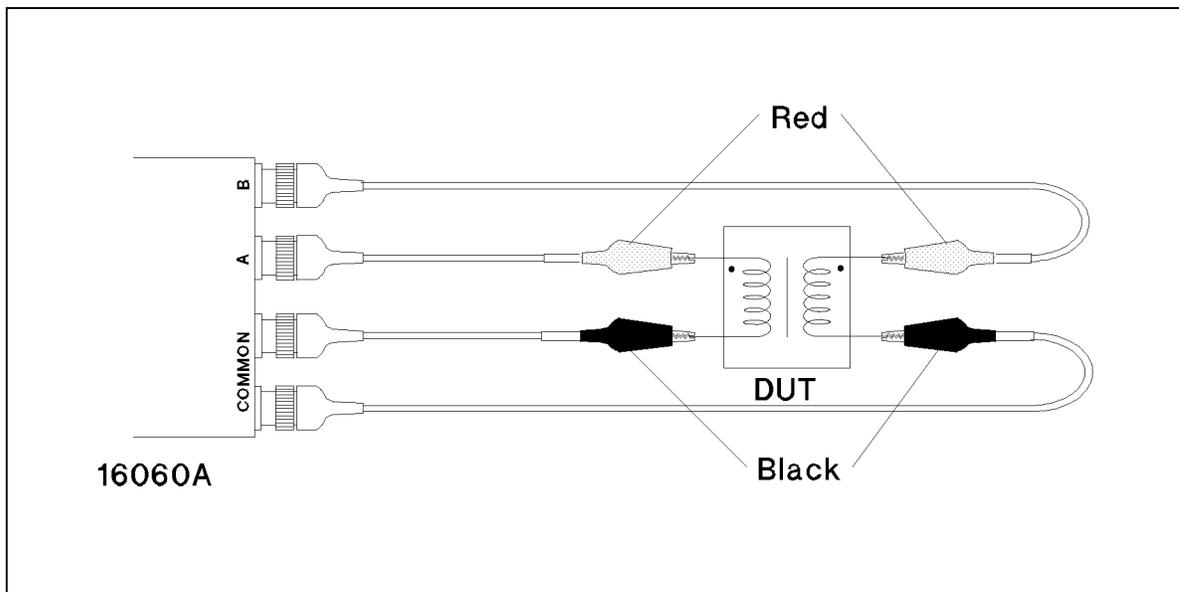

A9403003

Figure 6-3. Connecting a Transformer

The measurement results are shown below. In this example, the A:B switch was on the N:1 setting. This means that the displayed L2 value is the inductance of the winding on the side of the transformer that is connected to the "A" terminal. To obtain the inductance of the other side of the transformer, change the A:B switch setting to the 1:N setting. (N reading invalid)

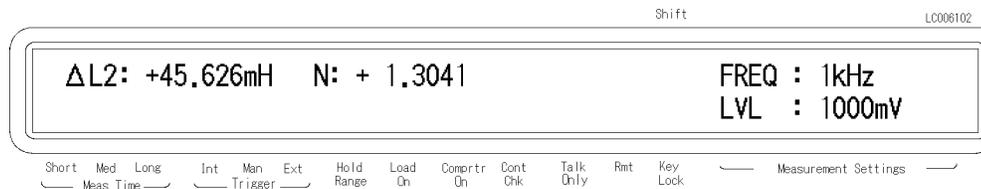

Note When “-----” is displayed as the measured value of N, change the A:B switch setting on the 16060A.



6. Measure L2-M.

- Press . Select L2 and press . Then select M and press .
- Set the deviation measurement function to cancel the residual impedance again, because changing the measurement parameter resets the deviation measurement function.
 - Press . Select Prim, and select ΔABS.
 - Exit the deviation measurement menu by selecting Exit.
- The measurement results are shown below. Again, L2 corresponds to the side of the transformer connected to the “A” terminal, since the A:B switch is on N:1.



7. Measure L2-R2.

- Press . Select L2 and press . Then select R2 and press .
- Set the deviation measurement function to cancel the residual impedance again, because changing the measurement parameter resets the deviation measurement function.
 - Press . Select Prim, and select ΔABS.
 - Exit the deviation measurement menu by selecting Exit.

4263B

- The measurement results are shown below. R2, like L2, corresponds to the side of the transformer connected to the “A” terminal. To obtain the resistance of the other side of the transformer, change the A:B switch setting to 1:N.

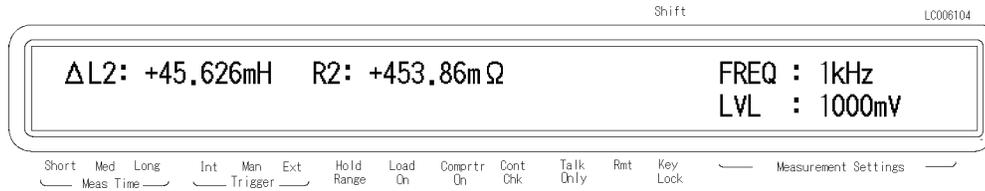

Measuring High Inductance Transformers

When measuring the DCR or R2 of a high inductance coil or transformer, set the trigger delay time (T_w) to prevent a transient of the test signal due to the inductance of the DUT and the resistance of the DUT and the test signal source.

$$T_w = \frac{k \times L}{25 + DCR}$$

where,

k is the constant (5 to 20).

L is the measured inductance value [H].

DCR is the measured DC Resistance value (Rdc or R2) [Ω].

Refer to “Test Current Level” in Chapter 3 for more information.

Impedance Measurement Basics

This chapter contains more detailed information on measurements using the 4263B, that should help you to work more efficiently. The following sections are included.

- Characteristics Example
- Parallel/Series Circuit Mode
- Four-Terminal Pair Configuration
- Measurement Contacts
- Correction Function of the 4263B

Characteristics Example

Figure 7-1 shows typical characteristics of various components.

As can be seen in the figure, a component can have different effective parameter values dependent upon its operating conditions. The measured values most useful in actual applications are obtained from precise measurement under the actual operating conditions.

DUT	Characteristics Example	Measurement Functions
Large C		CS-D, CS-Q, CS-RS Z- \angle , R-X
Small C		CP-D, CP-Q, CP-G Y- \angle , G-B
Large L		LP-D, LP-Q, LP-G, Y- \angle , G-B
Small L		LS-D, LS-Q, LS-RS, Z- \angle , R-X
Large R		CP-G, Y- \angle , G-B
Small R		LS-RS, Z- \angle , R-X

L7007013

Figure 7-1. Typical Characteristics of Components

Parallel/Series Circuit Mode

There are two equivalent circuit models used to measure L, C, or R components. They are the parallel and series models as shown in Table 7-1.

Table 7-1. Parallel/Series Circuit Model

Circuit Model	Measurement Function	Definition of D, Q, and G
C _p Model	Cp-D Cp-Q Cp-G	$D = \frac{1}{2\pi f C_p R_p} = \frac{1}{Q}$
C _s Model	Cs-D Cs-Q Cs-Rs	$D = 2\pi f C_s R_s = \frac{1}{Q}$
L _p Model	Lp-D Lp-Q Lp-G	$Q = \frac{R_p}{2\pi f L_p} = \frac{1}{D}$
L _s Model	Ls-D Ls-Q Ls-Rs	$Q = \frac{2\pi f L_s}{R_s} = \frac{1}{D}$

Selecting Circuit Model for Capacitance Measurement

The following description gives some practical guide lines for selecting the appropriate capacitance measurement circuit model.

Small Capacitance Values

Small capacitance yields a large reactance, which implies that the effect of the large value parallel resistance (R_p) has relatively more significance than that of the low value series resistance (R_s). So the parallel circuit model (Cp-D, Cp-Q, or Cp-G) is the one to use. (Refer to Figure 7-2 (a).)

Large Capacitance Values

When the measurement involves a large value of capacitance (low reactance), R_s has relatively more significance than R_p , so the series circuit model (Cs-D, Cs-Q, or Cs-Rs) is the one to use. (Refer to Figure 7-2 (b).)

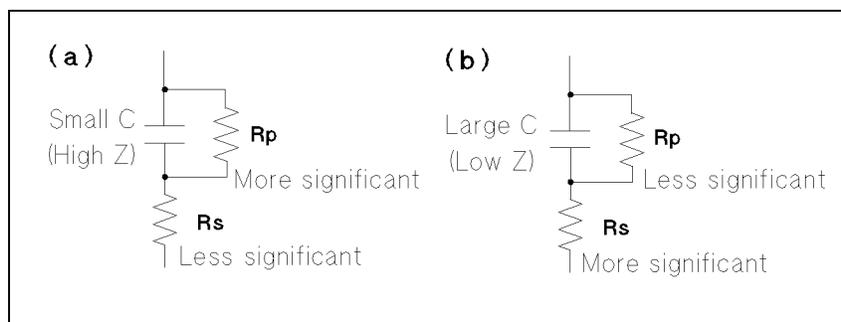

Figure 7-2. Capacitance Circuit Model Selection

The following are rules of thumb for selecting the circuit model according to the reactance of the capacitor.

- Above approx. $10\text{ k}\Omega$: Use parallel circuit model
- Below approx. $10\ \Omega$: Use series circuit model
- Between above values : Follow the manufacturer's recommendation

For example, to measure a 20 nF capacitor at 100 Hz (reactance is approximately $80\text{ k}\Omega$), the parallel circuit model is suitable.

Selecting Circuit Model for Inductance Measurement

The following description gives some practical guide lines for selecting the appropriate inductance measurement circuit model.

Small Inductance Values

For low values of inductance the reactance is typically small so R_s is more significant. Therefore, the series circuit model (Ls-D, Ls-Q, or Ls-Rs) is appropriate. (Refer to Figure 7-3 (a).)

Large Inductance Values

Conversely for large inductances, the reactance is typically large, so R_p becomes more significant than R_s . So, a measurement in the parallel circuit model (Lp-D, Lp-Q, or Lp-G) is more suitable. (Refer to Figure 7-3 (b).)

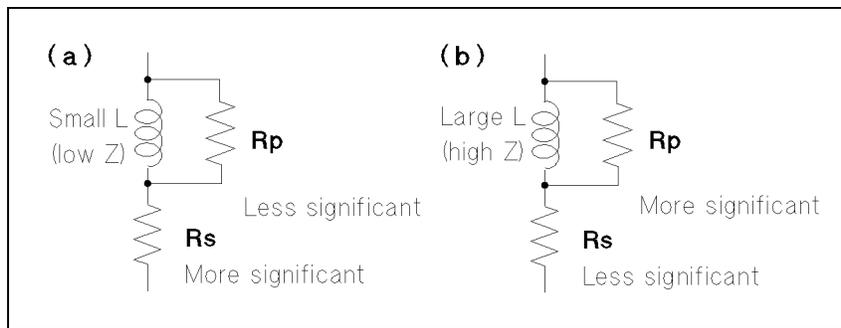

Figure 7-3. Inductance Circuit Model Selection

The following are rules of thumb for selecting the circuit model according to the reactance of the inductor.

- Above approx. $10\text{ k}\Omega$: Use the parallel circuit model
- Below approx. $10\ \Omega$: Use the series circuit model
- Between above values : Follow the manufacturer's recommendation

For example, to measure a $1\ \mu\text{H}$ inductor at $1\ \text{kHz}$ (reactance is approximately $6.3\ \text{m}\Omega$), the series circuit model is suitable.

Four-Terminal Pair Configuration

The 4263B uses the four-terminal pair measurement configuration which permits easy, stable, and accurate measurements and avoids the measurement limitations due to factors such as mutual inductance, interference of the measurement signals, and unwanted residual in the test connections.

Figure 7-4 shows the four-terminal pair measurement principle. The UNKNOWN terminals consists of four coaxial connectors.

- H_{CUR} : High current
- H_{POT} : High potential
- L_{POT} : Low potential
- L_{CUR} : Low current

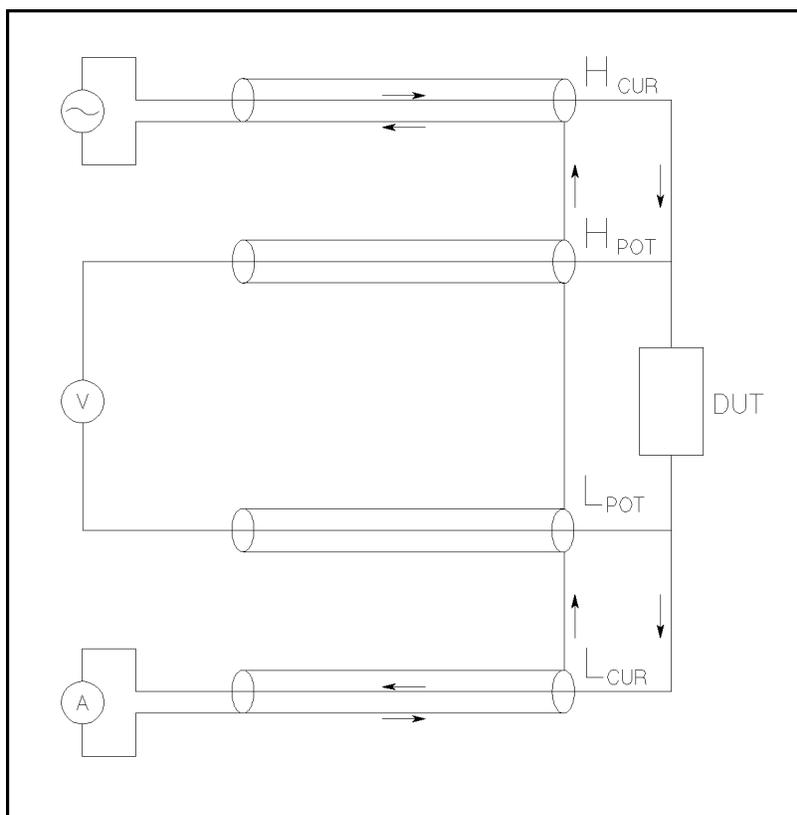

Figure 7-4. Four-Terminal Pair Measurement Principle

The four-terminal pair measurement method has the advantage in both low and high impedance measurements. The outer shield conductors work as the return path for the measurement signal current (they are not grounded). The same current flows through both the center conductors and outer shield conductors (in opposite directions), so no external magnetic fields are generated around the conductors (the magnetic fields produced by the inner and outer currents completely cancel each other). Therefore, test leads do not contribute additional errors due to self or mutual inductance between the individual leads.

Measurement Contacts

To realize accurate measurements using the four-terminal pair measurement technique, the following two conditions are required: (Refer to Figure 7-5 for each numbered point.)

1. The signal path between the LCR Meter and DUT should be as short as possible.
2. For a four-terminal pair measurement circuit configuration, the outer shields of H_{CUR} and H_{POT} , L_{CUR} , and L_{POT} terminals must all be connected together at a point as near as possible to the DUT.

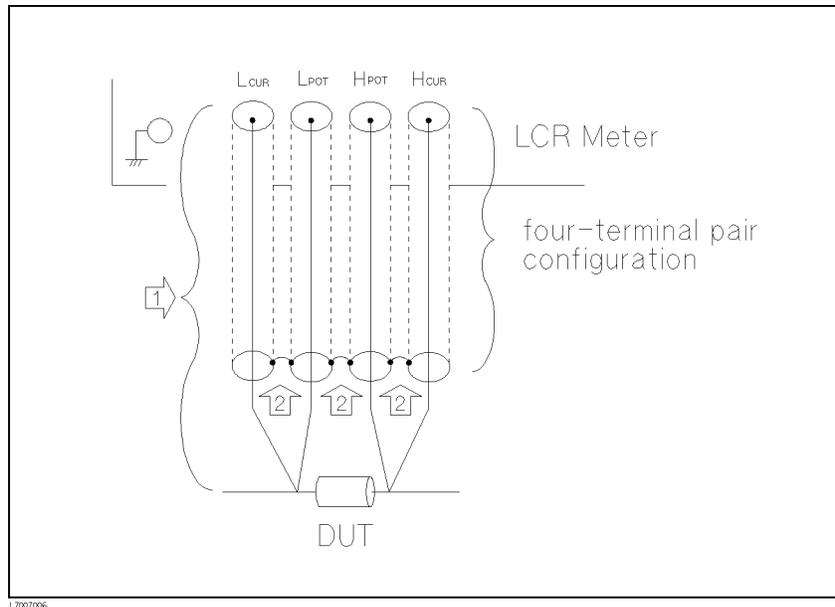

Figure 7-5. Measurement Contacts

Capacitance to Ground

To measure capacitors of 10 pF or less, the stray capacitance between the measurement contacts and the conductors near the capacitor will influence the measurement, as shown in Figure 7-6.

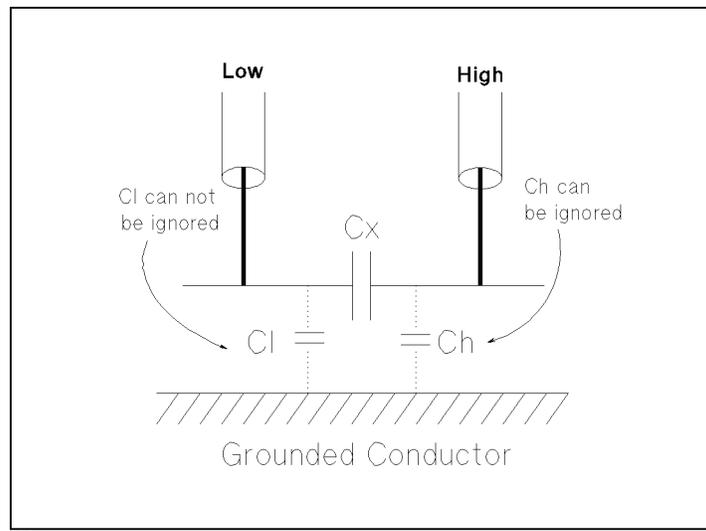

Figure 7-6. Model of Capacitance to Ground

To minimize the stray capacitance of the test leads, the center conductor of the test leads should be kept as short as possible, as shown in Figure 7-7, (A). If four-terminal pair connections are close to the point where contact is made with the DUT, interconnect the shields of the measurement terminals to the conductor to reduce the influence of the stray capacitance to ground, as shown in Figure 7-7, (b).

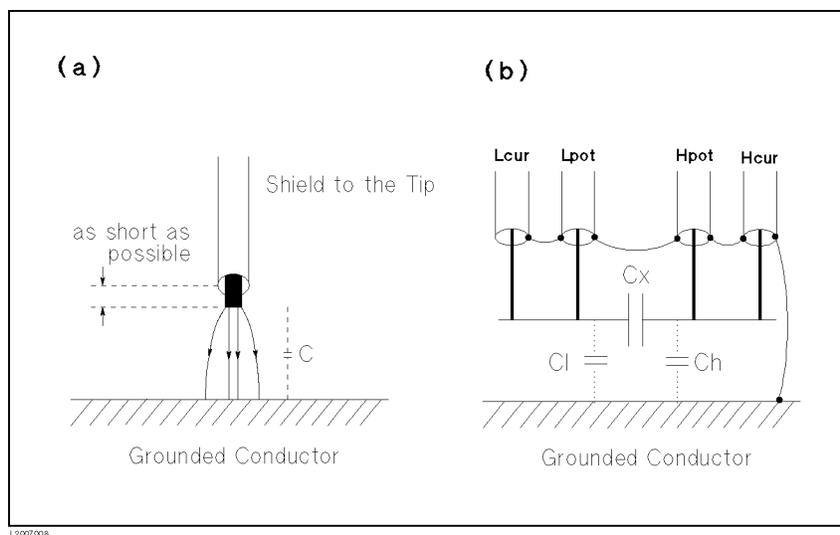

Figure 7-7. Reducing Capacitance to Ground

Contact Resistance

Contact resistance between the contacting terminals and the DUT causes measurement error when measuring large values of capacitance, especially in D (dissipation factor) measurements.

When measuring large capacitance values, the four-terminal measurement contacts have the advantage of less measurement error as compared to the two terminal method. Select a test fixture which can hold the DUT tight to stabilize the connection and to give the lowest contact resistance.

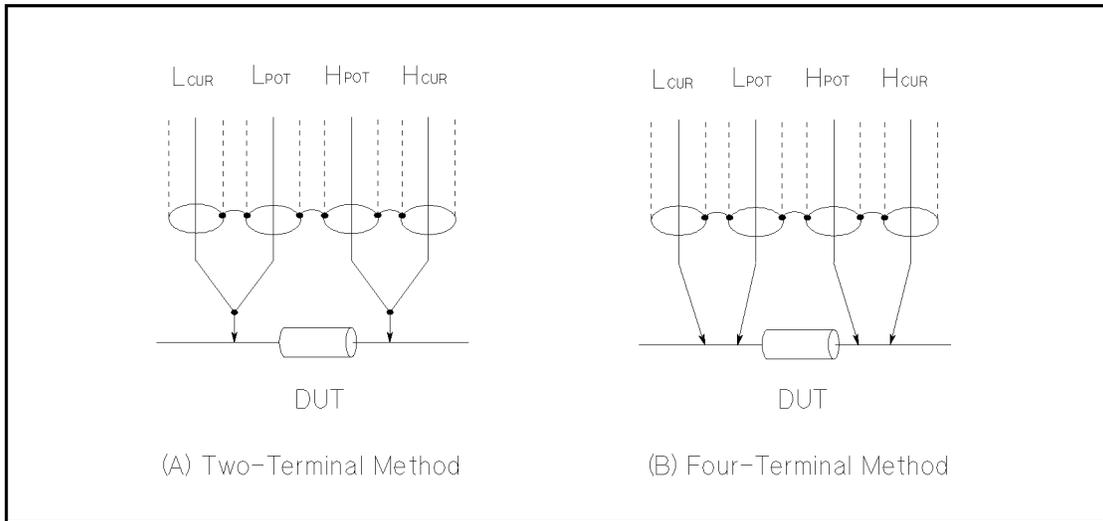

Figure 7-8. Contact Configuration

Extending Test Leads

If you need to extend your test leads and measurement contact cannot be made using the four-terminal pair configuration, use the connection shown in Figure 7-9.

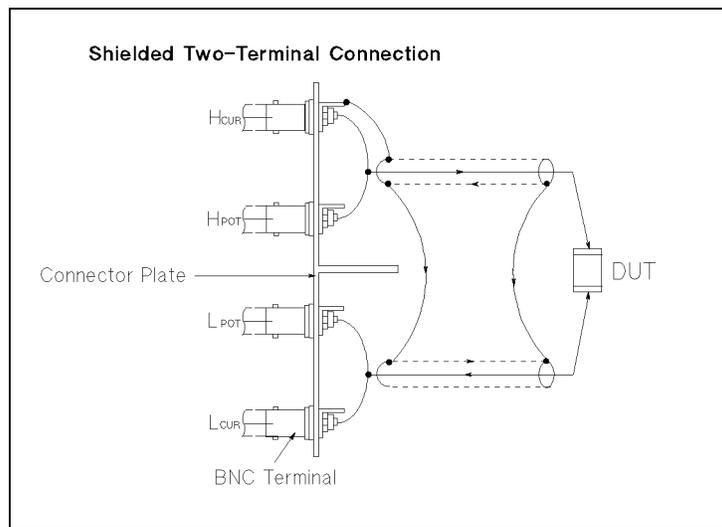

Figure 7-9. Measurement Contacts for Test Lead Extension

Using a Guard Plate for Low Capacitance Measurements

Use a guard plate to minimize measurement errors caused by stray capacitance when measuring low capacitance values, such as chip capacitors. See Figure 7-10.

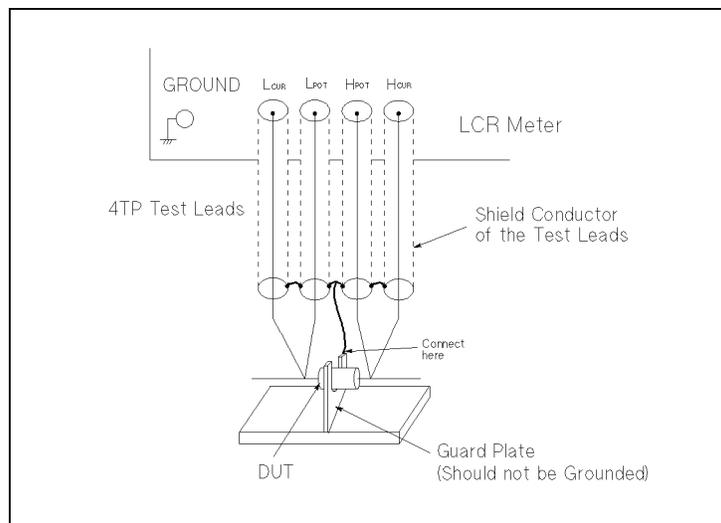

Figure 7-10. Example of DUT Guard Plate Connection

Shielding

Shielding minimizes the effects of electrical noise picked up by the test leads. So, provide a shield plate and connect it to the outer shield conductors of the four-terminal pair test leads as shown in Figure 7-11.

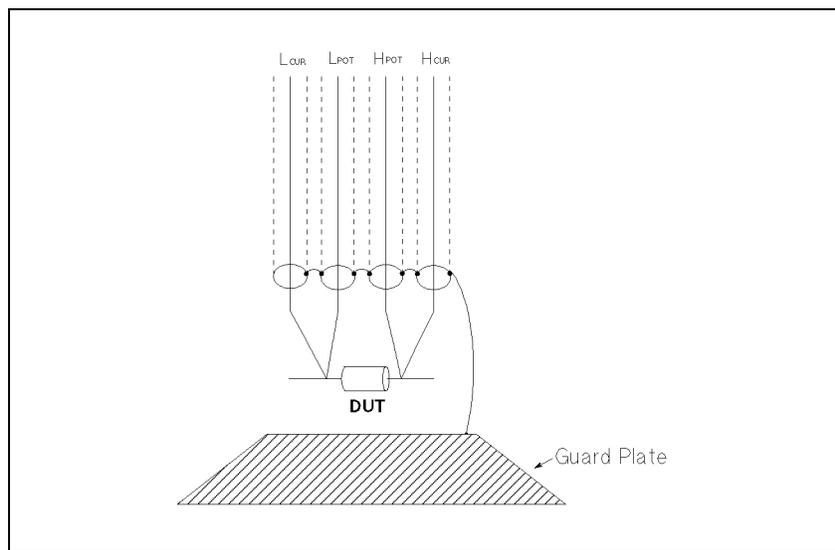

Figure 7-11. Guard Shield

Contact Check

To realize accurate measurements and to make the contact check function work correctly, use the following guide lines.

- Using the four-terminal pair configuration, place your test leads as near as possible to the DUT.
- Minimize C_{HL} and C_{PC} by arranging your test leads as shown in Figure 7-12.
 - If C_{HL} is large, the valid range of the contact check is reduced.
 - If C_{PC} is larger than about 3 pF, the contact check function may perceive that the DUT is connected even if it is not.

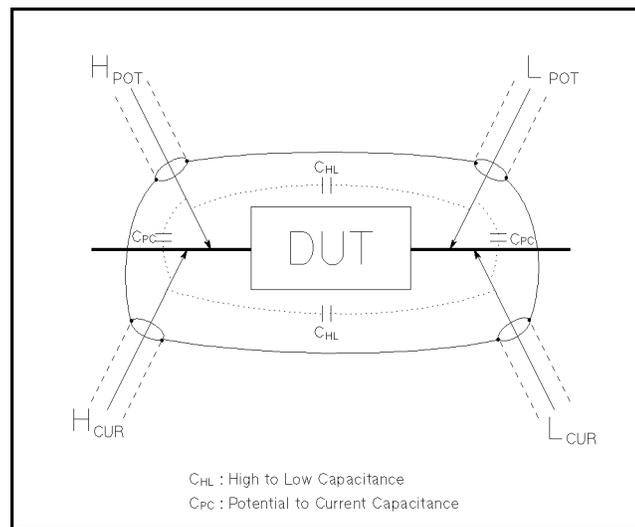

Figure 7-12. Stray Capacitance Causing Contact Check Error

Correction Functions of the 4263B

The 4263B has the following correction functions, Cable Length correction, OPEN, SHORT, and LOAD corrections. These correction functions are used to correct errors due to test fixtures and test leads. Table 7-2 lists these correction functions with a brief description of each.

Table 7-2. Correction Functions

Correction Selection	Description	Typical Usage
Cable Length Correction	Correct phase shift error due to the test leads.	<ul style="list-style-type: none"> Measurements using the 16048A/D/E, 16089A/B/C/D
OPEN/SHORT Correction	Correct for stray admittance and residual impedance of the test fixture.	<ul style="list-style-type: none"> Measurements using an Agilent test fixture directly connected to the UNKNOWN terminals
OPEN/SHORT/LOAD Correction	Correct complicated errors that cannot be removed by the OPEN/SHORT correction.	<ul style="list-style-type: none"> Measurements using a test fixture that has complicated residuals (such as custom made fixtures) Measurement using a non-Agilent extension cable

Examples:

- Simple measurements using an Agilent direct connecting test fixture.

In this case, the LOAD correction is not required. The OPEN/SHORT correction is enough to correct the residual errors.

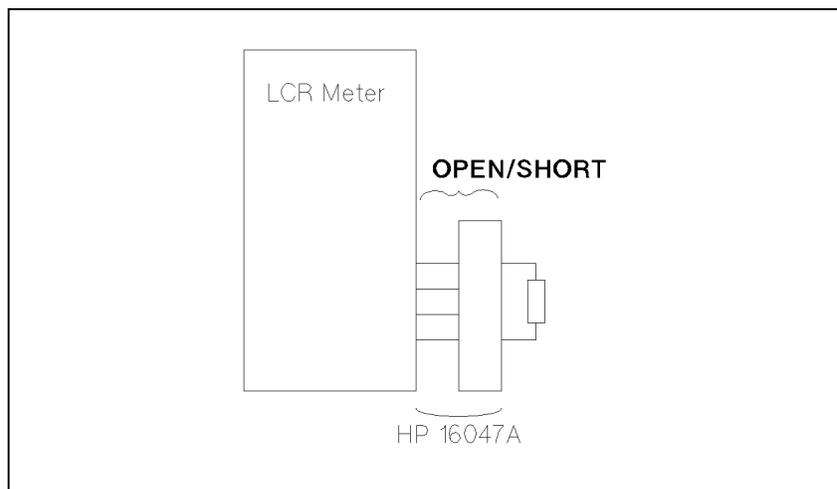

4263B

- Measurements using Agilent test leads and a test fixture.

In this case, the Cable Length correction and the OPEN/SHORT correction are used.

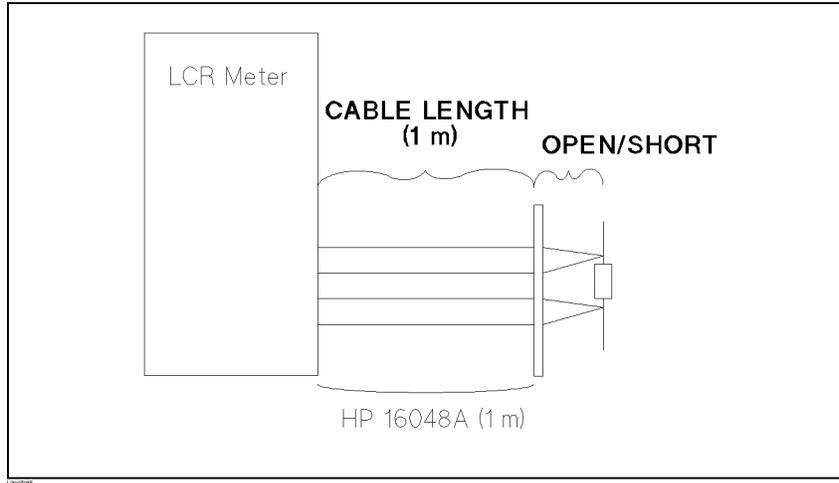

- Measurement using a fixture that has complicated residual errors.

Perform the OPEN/SHORT/LOAD correction using a LOAD standard.

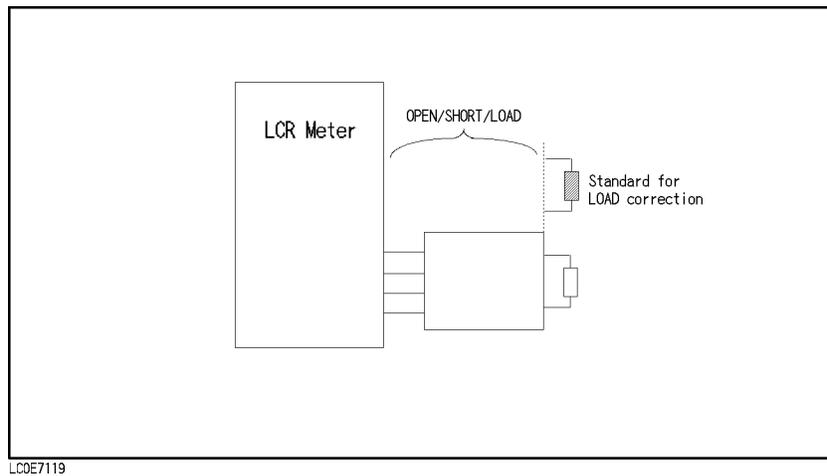

Standard for the LOAD Correction

You need a standard to do the LOAD correction. This can be any standard which has specified reference values. The type of standard does *not* have to be same as the device to be measured. That is, a capacitor standard can be used when you want to measure inductors.

Using a Standard Supplied by a Component Manufacturer

Use the manufacturer specified values of the standard as the reference values for the LOAD correction.

Using Your Own Standard

If you do not have a standard with specified reference values, you can use a device such as a general purpose capacitor or resistor. To use such a device, it is necessary to measure its impedance value accurately. The measured impedance value is used as the reference value for the LOAD correction.

Selecting the LOAD standard. The criteria for selecting the LOAD standard is as follows:

- When measuring DUTs of various impedance values, it is recommended to use a 100 Ω to 1 k Ω device as the LOAD standard. It can be measured accurately by LCR meters.

When measuring a DUT of one impedance value, it is recommended that the LOAD standard have a impedance value close to that of the DUT.

- It is important to use the stable LOAD standard not susceptible to influences of environment such as temperature or magnetic fields. From this viewpoint, capacitors or resistors are better suited than inductors.

Measuring the LOAD reference value. Use the following procedure to measure the LOAD standard's value accurately.

1. Connect the Agilent direct-connect test fixture (such as 16047A) to a high accuracy LCR meter, and perform the OPEN/SHORT correction.
2. Set the test frequency. It should be same as the frequency for measuring the DUT.
3. Set the LCR meter's measurement conditions (such as integration time or averaging time) so that it can measure as accurately as possible.
4. Connect the LOAD standard to the test fixture, and measure its impedance value.

This measurement value is used as a LOAD reference value.

Specifications

This chapter describes general information regarding the 4263B. This chapter is made up of the following sections.

- Specifications
- Supplemental Performance Characteristics

Specifications

Measurement Parameters

Z ($|Z|$) : Absolute value of impedance
 Y ($|Y|$) : Absolute value of admittance
 \angle (θ) : Phase angle
 R : Resistance
 X : Reactance
 G : Conductance
 B : Susceptance
 L : Inductance (four-terminal pair configuration)
 C : Capacitance
 Q : Quality factor
 D : Dissipation factor
 Rs (ESR) : Equivalent series resistance
 Rp : Parallel resistance

Option 001: Add the following parameters:

L2 : Inductance (two-terminal configuration)
 N : Turns ratio
 1/N : Reciprocal of N
 M : Mutual inductance
 Rdc : DC resistance (four-terminal pair configuration)
 R2 : DC resistance (two-terminal configuration)

Measurement Conditions

■ Test Signal

- Test Signal Frequency
100 Hz, 120 Hz, 1 kHz, 10 kHz, 20 kHz (option 002 only), and 100 kHz
- Test Signal Frequency Accuracy
 $\pm 0.01\%$ (@ 100 Hz, 1 kHz, 10 kHz, 20 kHz, and 100 kHz)
 $\pm 1\%$ (@ 120 Hz)
- Test Signal Level V_{OSC}
20 mV to 1 V_{rms} , 5 mV resolution
- Test Signal Accuracy
 $\pm(10\% + 10 \text{ mV})$, @ $50 \text{ mV} \leq V_{osc} \leq 1 \text{ V}$
(Test Signal Accuracy at $V_{osc} < 50 \text{ mV}$ is typical data.)
- Internal DC Bias Level
0 V, 1.5 V, and 2 V
- Internal DC Bias Accuracy
 $\pm(5\% + 2 \text{ mV})$
- External DC Bias
0 to +2.5 V

4263B

■ Test Cable Lengths

0 m, 1 m, 2 m, 4 m (@ 100 Hz, 120 Hz, 1 kHz)
0 m, 1 m, 2 m (@ 10 kHz, 20 kHz)
0 m, 1 m (@ 100 kHz)

■ Measurement Time Mode

Short, Medium, and Long

■ Ranging

Auto and Hold (manual)

■ Averaging

1 to 256

■ Trigger Mode

Internal, Manual, External, and Bus

■ Trigger Delay Time

0 to 9.999 seconds in 0.001 seconds steps

Measurement Range

Parameter	Measurement Range	Parameter	Measurement Range
Z, R, X	1 m Ω to 100 M Ω	D	0.0001 to 9.9999
Y, G, B	10 nS to 1000 S	Q	0.1 to 9999.9
C	1 pF to 1 F	\angle (θ)	-180 ° to 180 °
L	10 nH to 100 kH	Rdc	1 m Ω to 100 M Ω

Measurement Accuracy

The following conditions must be met:

1. Warm up time: \geq 15 min
2. OPEN and SHORT corrections have been performed.
3. Test Signal Level $V_{osc} = 50$ mV, 100 mV, 250 mV, 500 mV, 1 V
(Measurement accuracy at V_{osc} other than above listed points is typical data.)
4. Ambient temperature: 23 ± 5 °C

Within the temperature (T) range of 0 to 45 °C, multiply the basic accuracy by the following temperature induced error,

8 °C \leq T < 18 °C, or 28 °C < T \leq 38 °C : \times 2
 0 °C \leq T < 8 °C, or 38 °C < T \leq 45 °C : \times 4

■ $|Z|$, $|Y|$, L, C, R, X, G, B, and Rdc accuracy (A_e [%])

□ When $|Z_x| > 100 \Omega$

$$A_e = A + B \times C \times |Z_x| / Z_s + D / |Z_x| + |Z_x| / E$$

□ When $|Z_x|$ or DCR $\leq 100 \Omega$

$$A_e = A + B \times C \times Z_s / |Z_x| + D / |Z_x| + |Z_x| / E$$

where, $|Z_x|$ is the measured $|Z|$ value.

When measuring Y, L, C, R, X, G, B, or Rdc, convert the value to the impedance value using Figure 8-1.

Z_s is the setup range value and is given in Table 8-1. A, B, and C are given in Table 8-1.

D is given in Table 8-2.

E is given in Table 8-3.

L, C, X, B accuracies apply when D_x (measured D value) ≤ 0.1 .

When $D_x > 0.1$, multiply A_e by $\sqrt{1 + D_x^2}$.

R, G accuracies apply when Q_x (measured Q value) ≤ 0.1 .

When $Q_x > 0.1$, multiply A_e by $\sqrt{1 + Q_x^2}$.

The accuracy of G above applies when in G-B mode.

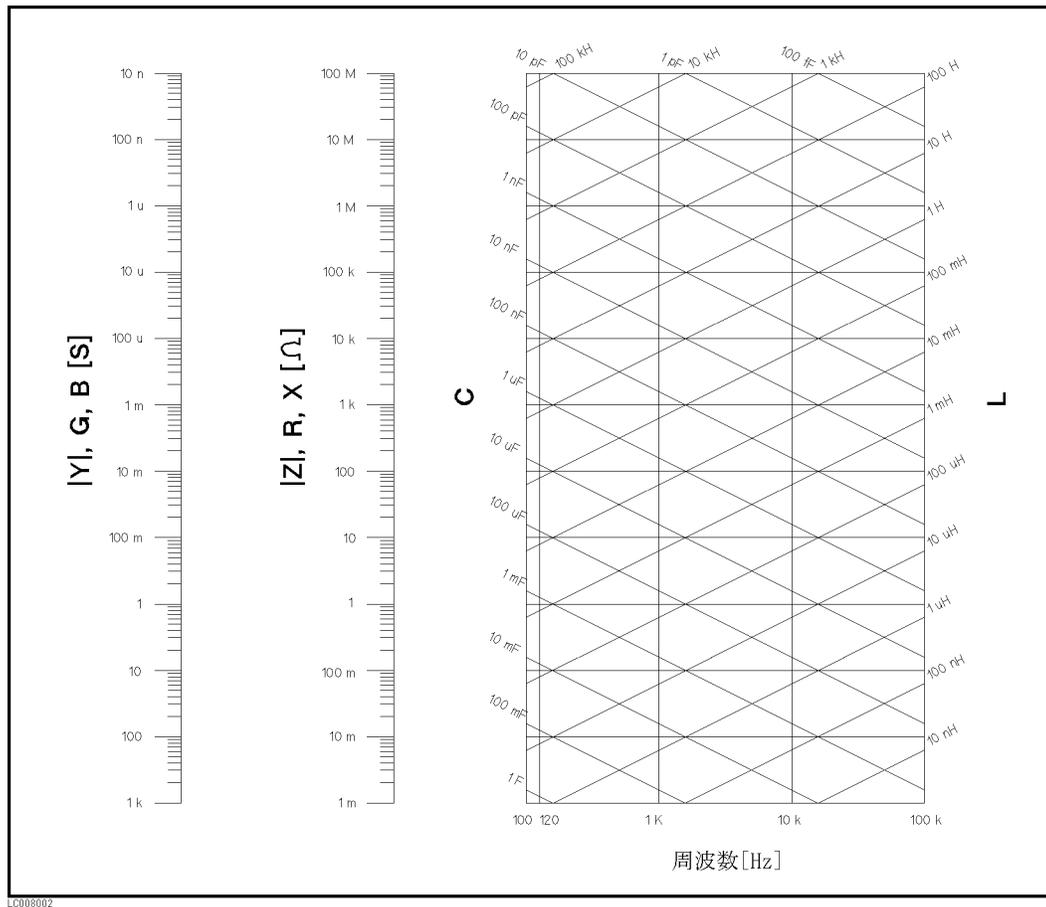

Figure 8-1. Conversion Diagram

Table 8-1. Measurement Accuracy Parameter: A, B, and C

$ Z_x $	Z_s	A [%] (Short / Medium, Long) B [%] (Short / Medium, Long)			
		Test Signal Frequency			
		DC	100/120 Hz	1 kHz	10 kHz
$1 \text{ M}\Omega \leq Z_x \leq 100 \text{ M}\Omega$	1 M Ω	0.85 / 0.85 0.075 / 0.025	0.48 / 0.15 0.075 / 0.025 ¹	0.13 / 0.1 0.04 / 0.02	0.48 / 0.48 0.04 ² / 0.02 ²
$100 \text{ k}\Omega \leq Z_x < 1 \text{ M}\Omega$	100 k Ω	0.85 / 0.85 0.055 / 0.02	0.48 / 0.15 0.055 / 0.02 ³	0.13 / 0.095 0.02 / 0.01	0.36 / 0.36 0.02 ² / 0.015 ²
$10 \text{ k}\Omega \leq Z_x < 100 \text{ k}\Omega$	10 k Ω			0.11 / 0.09 0.02 / 0.01	0.16 / 0.16 0.02 / 0.015
$1 \text{ k}\Omega \leq Z_x < 10 \text{ k}\Omega$	1 k Ω				
$100 \Omega < Z_x \leq 1 \text{ k}\Omega$	100 Ω				
$10 \Omega < Z_x \leq 100 \Omega$	100 Ω				
$1 \Omega < Z_x \leq 10 \Omega$	10 Ω		0.5 / 0.17 0.055 / 0.02	0.13 / 0.12 0.02 / 0.01	0.2 / 0.2 0.02 / 0.015
$100 \text{ m}\Omega < Z_x \leq 1 \Omega$	1 Ω	0.85 / 0.85 0.09 / 0.02	0.5 / 0.4 0.09 / 0.02	0.4 / 0.4 0.03 / 0.01	0.4 / 0.4 0.03 / 0.015
$1 \text{ m}\Omega \leq Z_x \leq 100 \text{ m}\Omega$	100 m Ω	0.85 / 0.85 0.29 / 0.1	0.5 / 0.4 0.29 / 0.1	0.4 / 0.4 0.095 / 0.03	0.4 / 0.4 0.075 / 0.03

1 When the DC Bias is set to ON, 0.075 / 0.045

2 Multiply the number by the following error, when the cable length is 1 m or 2m.

1 m : $\times 2.5$

2 m : $\times 4$

3 When the DC bias is set to ON, 0.055 / 0.040

Table 8-1. Measurement Accuracy Parameter: A, B, and C (continued)

$ Z_x $	Z_s	A [%] (Short / Medium, Long) B [%] (Short / Medium, Long)		C
		Test Signal Frequency		
		20 kHz	100 kHz	
$1 \text{ M}\Omega \leq Z_x \leq 100 \text{ M}\Omega$	1 M Ω	1.9 / 1.9 0.12 ¹ / 0.06 ¹	Not Specified	1 (@ 1 V, DC) 5 (@ 500 mV) 10 (@ 250 mV) 25 (@ 100 mV) 50 (@ 50 mV)
$100 \text{ k}\Omega \leq Z_x < 1 \text{ M}\Omega$	100 k Ω	1.4 / 1.4 0.05 ¹ / 0.03 ¹	1.15 ² / 1.15 ² 0.11 ² / 0.1 ²	1 (@ 1 V, DC) 2 (@ 500 mV) 4 (@ 250 mV) 8 (@ 100 mV) 15 (@ 50 mV)
$10 \text{ k}\Omega \leq Z_x < 100 \text{ k}\Omega$	10 k Ω	0.8 / 0.8 0.05 / 0.03		
$1 \text{ k}\Omega \leq Z_x < 10 \text{ k}\Omega$	1 k Ω	0.7 / 0.7 0.05 / 0.03	1.12 / 1.12 0.11 / 0.1	1 (@ 1 V, DC) 1 (@ 500 mV) 2 (@ 250 mV) 5 (@ 100 mV) 10 (@ 50 mV)
$100 \Omega < Z_x < 1 \text{ k}\Omega$	100 Ω	0.7 / 0.7 0.05 / 0.03	1.12 / 1.12 0.11 / 0.1	
$10 \Omega < Z_x \leq 100 \Omega$	100 Ω	0.5 / 0.5 0.05 / 0.03	0.83 / 0.83 0.11 / 0.1	
$1 \Omega < Z_x \leq 10 \Omega$	10 Ω	0.6 / 0.6 0.05 / 0.03	0.97 / 0.97 0.11 / 0.1	
$100 \text{ m}\Omega < Z_x \leq 1 \Omega$	1 Ω	0.6 / 0.6 0.05 / 0.03	0.97 / 0.97 0.11 / 0.1	
$1 \text{ m}\Omega \leq Z_x \leq 100 \text{ m}\Omega$	100 m Ω	0.6 / 0.6 0.14 / 0.06	0.97 / 0.97 0.14 / 0.1	

1 Multiply the number by the following error, when the cable length is 1 m or 2m.

1 m : $\times 2.5$

2 m : $\times 4$

2 Use 10 k Ω as the Z_s value, even if the $|Z_x|$ value is $100 \text{ k}\Omega \leq |Z_x| < 1 \text{ M}\Omega$.

Table 8-2. Measurement Accuracy Parameter: D

Cable Length	D				
	Test Signal Frequency				
	DC, 100/120 Hz	1 kHz	10 kHz	20 kHz	100 kHz
0 m	0.002 Ω	0.0045 Ω	0.025 Ω	0.05 Ω	0.25 Ω
1 m	0.01 Ω	0.0165 Ω	0.075 Ω	0.15 Ω	0.75 Ω
2 m	0.018 Ω	0.0285 Ω	0.125 Ω	0.25 Ω	—
4 m	0.034 Ω	0.0525 Ω	—	—	—

Table 8-3. Measurement Accuracy Parameter: E

E				
Test Signal Frequency				
DC, 100/120 Hz	1 kHz	10 kHz	20 kHz	100 kHz
$2.8 \times 10^8 \Omega$	$2.8 \times 10^7 \Omega$	$2.8 \times 10^6 \Omega$	$1.4 \times 10^6 \Omega$	$2.8 \times 10^5 \Omega$

4263B

■ D accuracy (D_e)

$$D_e = \pm \frac{A_e}{100}$$

Accuracy applies when D_x (measured D value) ≤ 0.1 .

When $D_x > 0.1$, multiply D_e by $(1 + D_x)$.

■ Q accuracy (Q_e)

$$Q_e = \pm \frac{Q_x^2 \times D_e}{1 \mp Q_x \times D_e}$$

where, Q_x is the measured Q value.
 D_e is the D accuracy.

Accuracy applies when $Q_x \times D_e < 0.1$

■ $\angle(\theta)$ accuracy (θ_e)

$$\theta_e = \frac{180}{\pi} \times A_e$$

■ G accuracy (G_e)

$$G_e = B_x \times D_e$$

Where, D_e is the D accuracy.
 B_x is given as

$$B_x = 2\pi f C_x = \frac{1}{2\pi f L_x}$$

Where, C_x is the measured C value [F].
 L_x is the measured L value [H].
 D_e is the D accuracy.
 f is the test signal frequency [Hz].

G accuracy described in this paragraph applies, when the Cp-G and Lp-G combinations and D_x (measured D value) ≤ 1 .

■ Rs Accuracy (RS_e [Ω])

$$RS_e = X_x \times D_e$$

Where, D_e is the D accuracy.
 X_x is given as,

$$X_x = 2\pi f L_x = \frac{1}{2\pi f C_x}$$

Where, C_x is the measured C value [F].
 L_x is the measured L value [H].
 D_e is the D accuracy.
 f is the measurement frequency [Hz].

Accuracy applies when D_x (measured D value) ≤ 0.1 .

■ Rp Accuracy (RP_e [Ω])

$$RP_e = \pm \frac{RP_x \times D_e}{D_x \mp D_e}$$

Where, RP_x is the measured Rp [Ω],
 D_e is the D accuracy.
 D_x is the measured D.

Accuracy applies when D_x (measured D value) ≤ 0.1 .

Measurement Support Functions

■ Correction Function

OPEN/SHORT correction:

Eliminates measurement errors due to stray parasitic impedance in the test fixtures.

LOAD correction:

Improves measurement accuracy by using a calibrated device as a reference.

■ Display

40-digit×2-lines LCD display. Capable of displaying: measurement values, comparator/contact check results, comparator limits, control settings, self test messages, and annunciators.

■ Mathematical Functions

The deviation and the percent deviation of measurement values from a programmable reference value.

■ Comparator Function

High/In/Low for each of the primary measurement parameters and the secondary measurement parameters.

■ Save/Recall

Ten instrument setups can be saved/recalled from the internal non-volatile memory.

■ Continuous Memory Capability

If the instrument is turned OFF, or if a power failure occurs, the instrument settings are automatically saved.

■ Key Lock

Disables key input from the front panel.

■ Contact Check Function

Detects contact failure between the test fixture and device to assure test integrity.

■ GPIB Interface

All control settings, measurement values, self-test results, and comparator information.

■ Handler Interface

All output signals are negative logic, opto-isolated open collector outputs.

□ Output Signals Include:

High/In/Low, No contact, index, end-of-measurement, and alarm.

□ Input Signals Include:

Keylock and external trigger

General

■ Power Requirements

100/120/220/240 V \pm 10%, 47 to 66 Hz
45 VA max

■ Operating Temperature, Humidity and Altitude

0 to 45 °C, \leq 95% RH @ 40 °C, 0 to 2000 meters

■ Storage Temperature, Humidity and Altitude

-40 to 70 °C, \leq 90% RH @ 65 °C, 0 to 4572 meters

■ EMC

Complies with CISPR 11 (1990) / EN 55011 (1991) : Group 1, Class A.

Complies with EN 61000-3-3 (1995) / IEC 1000-3-3 (1994)

Complies with EN 50082-1 (1992) / IEC 801-2 (1991) : 4 kV CD, 8 kV AD.

Complies with EN 50082-1 (1992) / IEC 801-3 (1984) : 3 V/m.

Complies with EN 50082-1 (1992) / IEC 801-4 (1988) : 0.5 kV Signal Lines, 1 kV Power Lines.

This ISM device complies with Canadian ICES-001.

Cet appareil ISM est conforme à la norme NMB-001 du Canada.

■ Dimensions

approximately 320 (W) by 100 (H) by 300 (D) mm

■ Weight

approximately 4.5 kg

Supplemental Performance Characteristics

The supplemental performance characteristics are listed below. These characteristics are not specifications but are typical characteristics included as additional information for the operator.

■ Test Signal Accuracy

$$\pm(10\% + 10 \text{ mV}), @ 20\text{mV} \leq V_{\text{osc}} < 50 \text{ mV}$$

■ Test Signal Output Impedance

$$25 \Omega \pm 10\% (\leq 1 \Omega \text{ Range})$$

$$100 \Omega \pm 10\% (\geq 10 \Omega \text{ Range})$$

■ Measurement Accuracy

When $V_{\text{osc}} \neq 50 \text{ mV}, 100 \text{ mV}, 250 \text{ mV}, 500 \text{ mV}, 1 \text{ V}$, multiply the A_e [%] value by the following K value.

Test Signal Level	K
$20 \text{ mV} \leq V_{\text{osc}} < 50 \text{ mV}$	$50 / V_{\text{osc}}[\text{mV}]$
$50 \text{ mV} < V_{\text{osc}} < 100 \text{ mV}$	$100 / V_{\text{osc}}[\text{mV}]$
$100 \text{ mV} < V_{\text{osc}} < 250 \text{ mV}$	$250 / V_{\text{osc}}[\text{mV}]$
$250 \text{ mV} < V_{\text{osc}} < 500 \text{ mV}$	$500 / V_{\text{osc}}[\text{mV}]$
$500 \text{ mV} < V_{\text{osc}} < 1 \text{ V}$	$1000 / V_{\text{osc}}[\text{mV}]$

■ Level Monitor Accuracy

Level monitor accuracy is calculated as follows:

$$\pm(\text{Test signal accuracy} + \text{Measurement accuracy} + 1) \%$$

Where,

$$\text{Test signal accuracy [\%]} : (V_{\text{osc}}[\text{mV}] \times 0.1 + 10 \text{ mV}) / V_{\text{osc}}[\text{mV}]$$

$$\text{Measurement accuracy [\%]} : A_e, @ V_{\text{osc}} = 50 \text{ mV}, 100 \text{ mV}, 250 \text{ mV}, 500 \text{ mV}, 1 \text{ V}$$

$$A_e \times K, @ V_{\text{osc}} \neq 50 \text{ mV}, 100 \text{ mV}, 250 \text{ mV}, 500 \text{ mV}, 1 \text{ V}$$

■ L2, M, R2 N Measurement Range

Parameter	Measurement Range
L2, M	1 μ H to 100 H
N	0.9 to 200
R2	1 m Ω to 100 M Ω

■ L2, M, R2, N Measurement Accuracy

L2 accuracy ($L2_e$ [%])

$$L2_e = A_e + AE_{L2}$$

where, AE_{L2} [%] is the additional error for L2.

$$AE_{L2} = (D'/L2_x + L2_x/E') \times 100$$

where, $L2_x$ is the measured L2 value [H].

D'					
Cable Length	Test Signal Frequency				
	100/120 Hz	1 kHz	10 kHz	20 kHz	100 kHz
0 m	20 μ H	2 μ H	2 μ H	2 μ H	2 μ H
1 m, 2 m, 4 m	200 μ H	20 μ H	20 μ H	20 μ H	20 μ H

E'				
Test Signal Frequency				
100/120 Hz	1 kHz	10 kHz	20 kHz	100 kHz
200 kHz	2.5 kHz	25 H	6.25 H	0.25 H

M accuracy (M_e [%])

$$M_e = L2_e + AE_M$$

where, AE_M [%] is the additional error for M:

$$AE_M = B \times (L2_x/M_x - 1)$$

where, B is given in Table 8-1.

$L2_x$ is the measured L2 value (the primary side) [H].

M_x is the measured M value [H].

4263B

R2 measurement accuracy ($R2_e$ [%])

$$R2_e = A_e + AE_{R2}$$

where, AE_{R2} [%] is the additional error for R2:

$$AE_{R2} = (D''/R2_x) \times 100$$

where, $R2_x$ is the measured R2 value [Ω].
 D'' is given in the following table.

Cable Length	D''
0 m	250 m Ω
1 m	500 m Ω
2 m	750 m Ω
4 m	1250 m Ω

N measurement accuracy (N_e [%])

$$N_e = F + 100 \times G/L2_x + (H + 100 \times I/L2_x) \times J \times N_x$$

where, N_x is the measured N value.

F, G, H, I and J are given in the following tables.

F					
Measurement Time Mode	Test Signal Frequency				
	100/120 Hz	1 kHz	10 kHz	20 kHz	100 kHz
Short	0.7%	0.3%	0.35%	0.7%	1.1%
Medium/Long	0.35%	0.3%	0.35%	0.7%	1.1%

G					
Cable Length	Test Signal Frequency				
	100/120 Hz	1 kHz	10 kHz	20 kHz	100 kHz
0 m	20 μ H	2 μ H	2 μ H	2 μ H	2 μ H
1 m, 2 m, 4 m	200 μ H	20 μ H	20 μ H	20 μ H	20 μ H

H¹					
Measurement Time Mode	Test Signal Frequency				
	100/120 Hz	1 kHz	10 kHz	20 kHz	100 kHz ²
Short	0.055%	0.02%	0.02%	0.05%	0.11%
Medium/Long	0.02%	0.01%	0.015%	0.03%	0.1%

1 When the test signal level is not 1 V, multiply the H value by the following value:

500 mV : \times 1, 250 mV : \times 2, 100 mV : \times 3, 50 mV : \times 6

2 When the cable length is not 0 m, add 0.01 per meter.

I ¹					
Measurement Time Mode	Test Signal Frequency				
	100/120 Hz	1 kHz	10 kHz	20 kHz	100 kHz
Short	90 μ H	7 μ H	0.7 μ H	0.5 μ H	0.2 μ H
Medium/Long	35 μ H	3.5 μ H	0.5 μ H	0.3 μ H	0.2 μ H

1 When the test signal level is not 1 V, multiply the I value by the following value:

500 mV : \times 1, 250 mV : \times 2, 100 mV : \times 3, 50 mV : \times 6

Test Signal Level	J
$20 \text{ mV} \leq V_{\text{osc}} \leq 50 \text{ mV}$	$(50 / V_{\text{osc}}[\text{mV}]) \times 6$
$50 \text{ mV} < V_{\text{osc}} \leq 100 \text{ mV}$	$(100 / V_{\text{osc}}[\text{mV}]) \times 3$
$100 \text{ mV} < V_{\text{osc}} \leq 250 \text{ mV}$	$(250 / V_{\text{osc}}[\text{mV}]) \times 2$
$250 \text{ mV} < V_{\text{osc}} \leq 500 \text{ mV}$	$500 / V_{\text{osc}}[\text{mV}]$
$500 \text{ mV} < V_{\text{osc}} \leq 1 \text{ V}$	$1000 / V_{\text{osc}}[\text{mV}]$

For example, the following figure shows the relation between the N value, the self-inductance (L2) value, and the measurement error, when the test signal frequency is 1 kHz and the measurement time is Medium/Long.

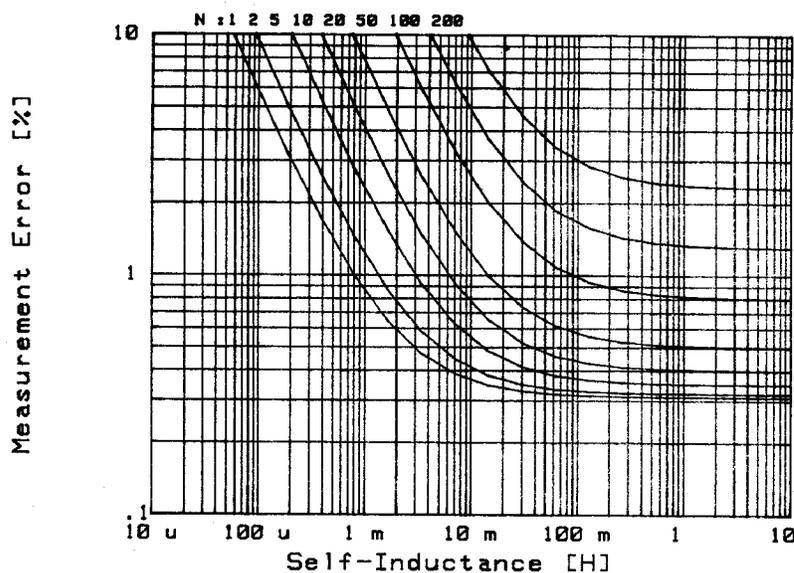

■ Measurement Time

The following shows typical measurement times when the level monitor is OFF.

For all the measurement modes except Ls-Rdc, Lp-Rdc, L2-R2, L2-N, L2-1/N, and L2-M

1. When DC bias is OFF

Total Measurement Time [ms] = Td + Tzm1

Where, Td is the trigger delay time [ms].

Tzm1 is given in Table 8-4, last column.

Table 8-4. Measurement Time (DC Bias: OFF)

Measurement Time Mode	Analog Measurement ¹	Digital Computation ¹	Tzm1 ¹ , (= Analog Meas. + Dig. Comput.) ²
Short	19 (21) ms	6 (9) ms	25 (30) ms
Medium	57 (59) ms	8 (11) ms	65 (70) ms
Long	490 (492) ms	10 (13) ms	500 (505) ms

1 Numbers in parenthesis indicate measurement times when the contact check is performed.

2 Time interval from a trigger command to EOM (end of measurement) signal output at the handler interface port. (Hold range mode, display mode: OFF)

2. When DC bias is ON

Total Measurement Time [ms] = Td + Tzm2

Where, Td is the trigger delay time [ms].

Tzm2 is given in Table 8-5, last column.

Table 8-5. Measurement Time (DC Bias: ON)

Measurement Time Mode	Test Signal Frequency	Test Signal Level	Tzm2 ¹
Short	1 kHz, 10 kHz, 100 kHz 100 Hz, 120 Hz	All	35 (40) ms
		500 mV, 1 V	90 (95) ms
		50 mV, 100 mV, 250 mV	130 (135) ms
Medium	1kHz, 10 kHz, 100 kHz 100 Hz, 120 Hz	All	75 (80) ms
		500 mV, 1 V	110 (115) ms
		50 mV, 100 mV, 250 mV	150 (155) ms
Long	1 kHz, 10 kHz, 100 kHz 100 Hz, 120 Hz	All	600 (605) ms
		500 mV, 1 V	850 (855) ms
		50 mV, 100 mV, 250 mV	1200 (1205) ms

1 Numbers in parenthesis indicate measurement times when the contact check is performed.

Ls-Rdc, Lp-Rdc, L2-R2 modes

Total Measurement Time [ms] = $T_d + 120 + T_{zm1} + T_{dcr}$ ($0 \leq T_d < 40$ ms)

Total Measurement Time [ms] = $4 \times T_d + T_{zm1} + T_{dcr}$ ($T_d \geq 40$ ms)

Where, T_d is the trigger delay time [ms].

T_{zm1} is given in Table 8-4.

T_{dcr} is given in Table 8-6.

Table 8-6. Additional Measurement Time for Rdc Measurement

Measurement Time Mode	T_{dcr}
Short	80 ms
Medium	400 ms
Long	1680 ms

L2-N, L2-1/N, L2-M modes

Total Measurement Time [ms] = $T_d + T_{zm1} + T_{nm}$

Where, T_d is the trigger delay time [ms].

T_{zm1} is given in Table 8-4.

T_{nm} is given in Table 8-7.

Table 8-7. Additional Measurement Time for N and M Measurement

Measurement Time Mode	T_{nm}	
	$N \leq \text{approx. } 10$	$N \geq \text{approx. } 10$
Short	30 ms	60 ms
Medium	80 ms	160 ms
Long	500 ms	1000 ms

■ Maximum DC Bias Current

Measurement Range	Maximum DC Bias Current
0.1 Ω to 100 Ω	100 mA
1 k Ω , 10 k Ω	1 mA
100 k Ω , 1 M Ω	10 μ A

■ DC Bias Settling Time

The time for the DUT to be charged 99.9% is as follows:

$35 + 700000 \times C$ [ms] (@ Measurement range ≥ 10 Ω)

$35 + 175000 \times C$ [ms] (@ Measurement range ≤ 1 Ω)

Where, C is the DUT's capacitance value [F].

■ Continuous Memory Duration

72 hours (@ 23 ± 5 $^{\circ}$ C)

4263B

■ Front-end Protection

Internal input circuit is protected, when a charged capacitor is connected to the Input terminals.

The maximum capacitor voltage is:

$$1000 \text{ V } (C < 2 \text{ } \mu\text{F})$$

$$\sqrt{2/C} \text{ V } (2 \text{ } \mu\text{F} \leq C < 32 \text{ } \mu\text{F})$$

$$250 \text{ V } (32 \text{ } \mu\text{F} \leq C < 128 \text{ } \mu\text{F})$$

$$\sqrt{8/C} \text{ V } (C \geq 128 \text{ } \mu\text{F})$$

(where, C is the capacitance value of capacitor (F))

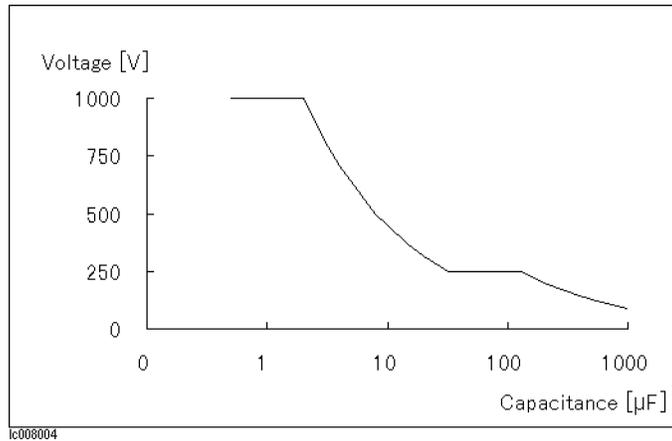

Figure 8-2. Maximum Capacitor Voltage

Caution



Do *not* apply DC voltage or current to the UNKNOWN terminals. Doing so will damage the 4263B. Before you measure a capacitor, be sure the capacitor is fully discharged.

- Recall time of the saved instrument setup
approx. 200 ms

Maintenance

This chapter provides information on how to maintain the 4263B. 4263B maintenance consists of performance tests and functional tests.

Test Equipment

Table 9-1 lists the recommended equipment for performing maintenance on the 4263B.

Table 9-1. Recommended Test Equipment

Equipment	Critical Specifications	Recommended Model	Qty.	Use ¹
Frequency Counter	Frequency: 100 Hz to 100 kHz Accuracy: < 25 ppm	5334B	1	P
RMS Voltmeter	Frequency: 100 Hz to 100 kHz Voltage Range: 50 mVrms to 1 Vrms Accuracy: < 1%	3458A	1	P
DC Voltmeter	Voltage Range: 1.5 V to 2 V Accuracy: < 0.1 %	3458A	1	P
100 mΩ Standard Resistor	No Substitute	42033A ²	1	P
10 kΩ Standard Resistor	No Substitute	42038A ²	1	F
100 kΩ Standard Resistor	No Substitute	16074A 42039A ²	1	P
Standard Capacitor Set	No Substitute	16074A 16380A	1	P
Standard Capacitor Set	No Substitute	16380C	1	P
OPEN Termination	No Substitute	42090A 16074A	1	P
SHORT Termination	No Substitute	42091A 16074A	1	P
Power Splitter	No Substitute	p/n 04192-61001	1	F
1 m Test Leads	No Substitute	16048A	1	P, F
2 m Test Leads	No Substitute	16048D	1	P
4 m Test Leads	No Substitute	16048E	1	P
Transformer Test Fixture	No Substitute	16060A	1	F
Interface Box	No Substitute	p/n 04284-65007	1	P
Adapter	BNC(f)-BNC(f)	p/n 1250-0080	4	P, F
	Dual Banana-BNC(f)	p/n 1251-2277	1	P
Cable	61 cm BNC(m)-BNC(m)	p/n 8120-1839	1	P
	30 cm BNC(m)-BNC(m)	p/n 8120-1838	3	F
Handler Interface Tester	No Substitute	p/n 04339-65007	1	F

1 P: Performance Tests, F: Functional Tests

2 Part of 42030A Standard Resistor Set

Performance Tests

Introduction

This section provides the test procedures used to verify that the 4263B's specifications listed in Chapter 8 are met. All tests can be performed without access to the interior of the instrument. The performance tests can also be used to perform incoming inspection, and to verify that the 4263B meets its performance specifications after troubleshooting or adjustment. If the performance tests indicate that the 4263B is *NOT* operating within the specified limits, check your test setup, then proceed with troubleshooting if necessary.

Note

Allow the 4263B to warm up for at least 15 minutes before you execute any of the performance tests.

Note

Perform all performance tests in ambient conditions of $23\text{ }^{\circ}\text{C} \pm 5\text{ }^{\circ}\text{C}$, $\leq 70\%$ RH.

Test Equipment

Table 9-1 lists the test equipment required to perform the tests described in this section. Use only calibrated test instruments when performance testing the 4263B. Equipment which equals or surpasses the key required specifications of the recommended equipment may be used as a substitute.

Calculation Sheet

The calculation sheet is used as an aid for recording raw measurement data, and for calculating the performance test results.

The performance test procedure gives the test sequence for performing a test, the complete set of measurement data are recorded on the calculation sheet, the results are calculated using the equations given on the calculation sheet, and the results are transcribed to the performance test record.

The procedure for using the calculation sheet is:

1. Photo copy the calculation sheet.
2. Follow the performance test procedure and record the measurement values, the 4263B's reading, etc., into the specified column on the calculation sheet.
3. Calculate the test result using the appropriate equation given on the calculation sheet, and record the test result into the Test Result column of the performance test record.

Performance Test Record

Record the performance test results in the test record at the end of this section (Photocopy the test record and use the photocopy). The test record lists all test specifications, their acceptable limits, and measurement uncertainties for the recommended test equipment. Test results recorded during incoming inspection can be used for comparison purposes during periodic maintenance, troubleshooting, and after repair or adjustment.

Calibration Cycle

The 4263B requires periodic performance tests. The frequency of performance testing depends on the operating and environmental conditions under which the 4263B is used. Verify the 4263B's performance at least once a year, using the performance tests described in this section.

How to Set the 4263B for the Performance Tests

This section shows the 4263B measurement condition setting procedures, which are used in the performance tests.

1. Resetting the 4263B

- a. Press   to display the reset menu.
- b. Select Yes using  or , and press .

2. Measurement Parameter Settings

- a. Press  to display the measurement parameter setting menu.
- b. Select the desired primary parameter using  or , and press .
- c. Select the desired secondary parameter using  or , and press .

3. Test Signal Frequency Setting

- a. Press  to display the frequency setting menu.
- b. Select the desired frequency using  or , and press .

4. Test Signal Level Setting

- a. Press  to display the test signal level setting menu.
- b. Select the desired level using  or , and press .

5. Measurement Time Mode Setting

- a. Press  to set the desired measurement time mode.

The current measurement time mode is displayed by the **Meas Time** annunciator.

4263B

Test Signal Frequency Accuracy Test

The 4263B's test signal frequency is measured with a frequency counter.

Specification

Test Signal Frequency Accuracy: $\pm 0.01\%$ ($\pm 1\%$ at 120 Hz)

Note

The 4263B's test signal frequency at the 120 Hz setting is actually 119.048Hz, and it is specified as 120 Hz $\pm 1\%$.



Test Equipment

Description	Recommended Model
Universal Counter	5334B
61 cm BNC(m)-BNC(m) Cable	p/n 8120-1839

Procedure

1. Reset the 4263B.
2. Set up the equipment as shown in Figure 9-1.

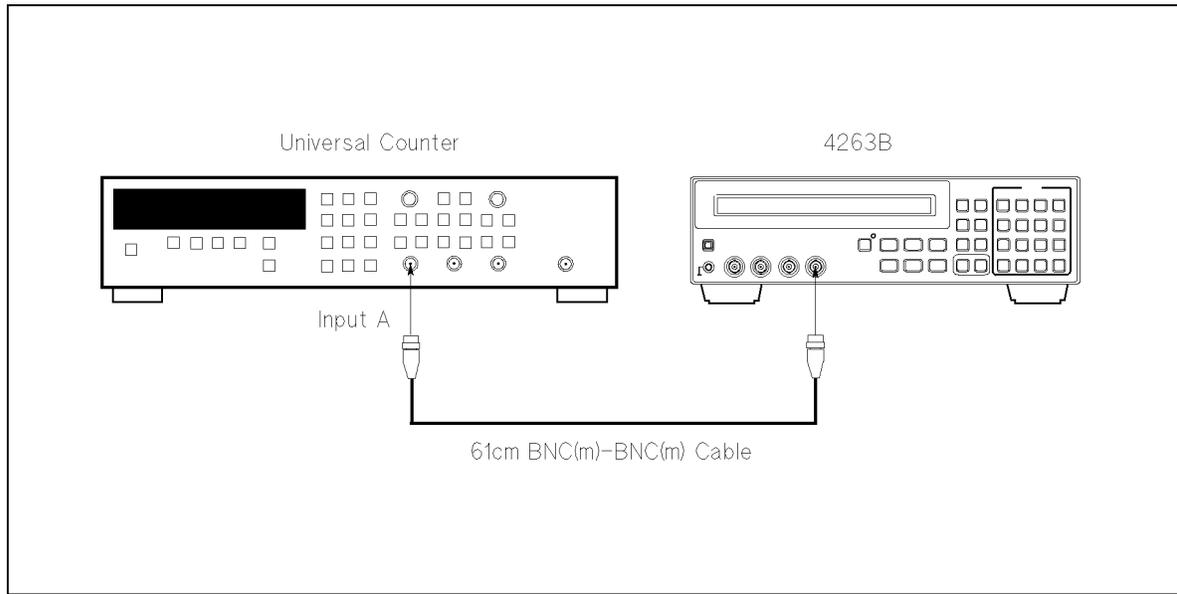

LCM01101

Figure 9-1. Test Signal Frequency Accuracy Test Setup

3. Set the test signal frequency to 100 Hz using  .
4. Record the universal counter reading on the calculation sheet.
5. Calculate the test result according to the calculation sheet, and record the result into the performance test record.
6. Press  to change the test signal frequency, and perform this test for all the frequency settings listed in Table 9-2.

Table 9-2. Frequency Accuracy Test Settings

Test Signal Frequency
100 Hz
120 Hz
1 kHz
10 kHz
20 kHz ¹
100 kHz

¹ Option 002 only.

4263B

Test Signal Level Accuracy Test

The 4263B's test signal level is measured with an AC voltmeter.

Specification

Test Signal Level Accuracy: $\pm (10 \% + 10 \text{ mV})$

Test Equipment

Description	Recommended Model
Multimeter	3458A
61 cm BNC(m)-BNC(m) Cable	p/n 8120-1839
Dual Banana-BNC(f) Adapter	p/n 1251-2277

Procedure

1. Reset the 4263B.
2. Set up the equipment as shown in Figure 9-2.

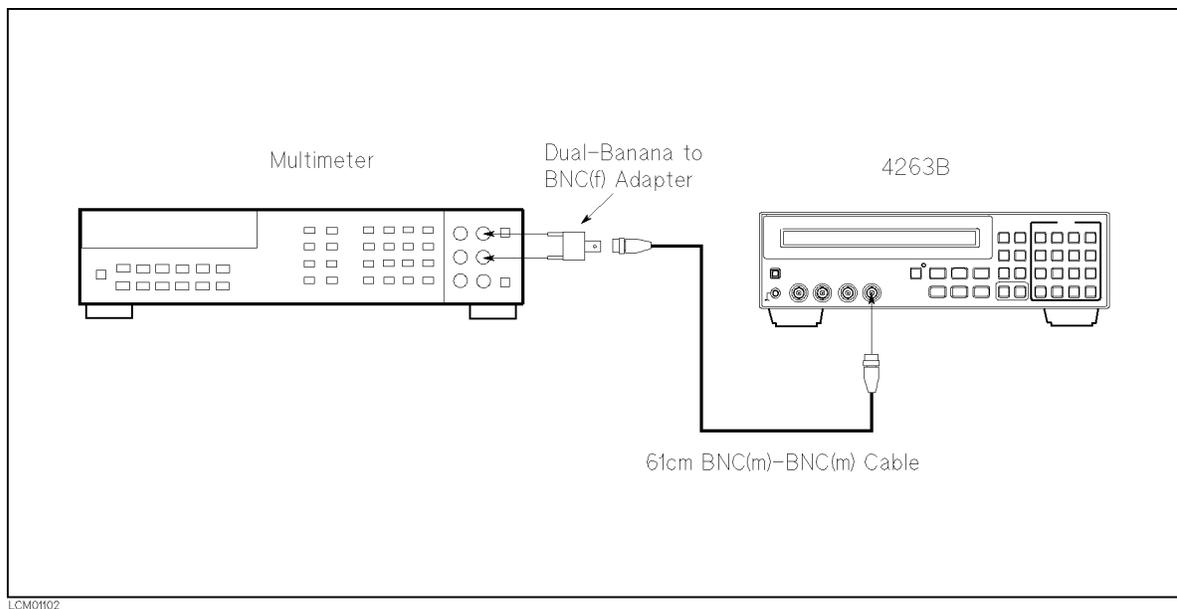

Figure 9-2. Test Signal Level Accuracy Test Setup

3. Set the 3458A Multimeter to the Synchronously Sub-sample AC voltage measurement mode using the following procedure:
 - a. Press **(ACV)** to set the measurement mode to AC voltage.
 - b. Press **(Shift) (S) (▼) (▼) (▼)** to display SETACV.
 - c. Press **(▶) (▼) (▼) (▼)** to display SYNC, then press **(Enter)**.
4. Set the test signal level to 50 mV using **(Bias Setup) (Level)**.

5. Set the test signal frequency to 100 Hz using  .
6. Record the Multimeter reading on the calculation sheet.
7. Calculate the test result according to the calculation sheet, and record the result into the performance test record.
8. Change the test signal settings by using  and  to perform this test for all settings listed in Table 9-3.

Table 9-3. Level Accuracy Test Settings

Test Signal Level	Test Signal Frequency
50 mV	100 Hz 20 kHz ¹ 100 kHz
250 mV	100 Hz 20 kHz ¹ 100 kHz
1 V	100 Hz 20 kHz ¹ 100 kHz

¹ Option 002 only.

4263B

DC Bias Level Accuracy Test

The 4263B's DC bias level is measured with a DC voltmeter.

Specification

DC Bias Level Accuracy: $\pm (5 \% + 2 \text{ mV})$

Test Equipment

Description	Recommended Model
DC Voltmeter	3458A
Interface Box	p/n 04284-65007
61 cm BNC(m)-BNC(m) Cable	p/n 8120-1839
Dual Banana-BNC(f) Adapter	p/n 1251-2277

Procedure

1. Reset the 4263B.
2. Set up the equipment as shown in Figure 9-3. If the Interface Box (p/n 04284-65007) is not available, use the following cables and adapters as a substitute and setup the equipment as shown in Figure 9-4.

Description	Recommended Model
30 cm BNC(m)-BNC(m) Cable	p/n 8120-1838, 2 ea.
2BNCs(m) to 3 Alligator Clips Test Lead	p/n 8120-1661
Tee, BNC(m)(f)(f) Adapter	p/n 1250-0781, 2 ea.

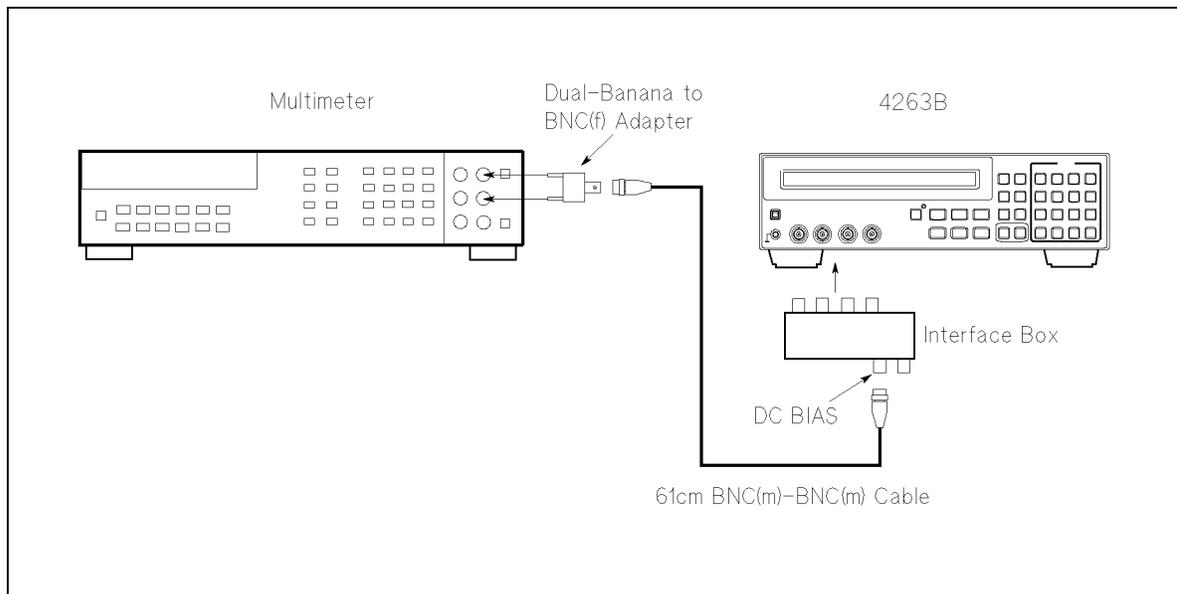

LCM01103

Figure 9-3. DC Bias Level Accuracy Test Setup

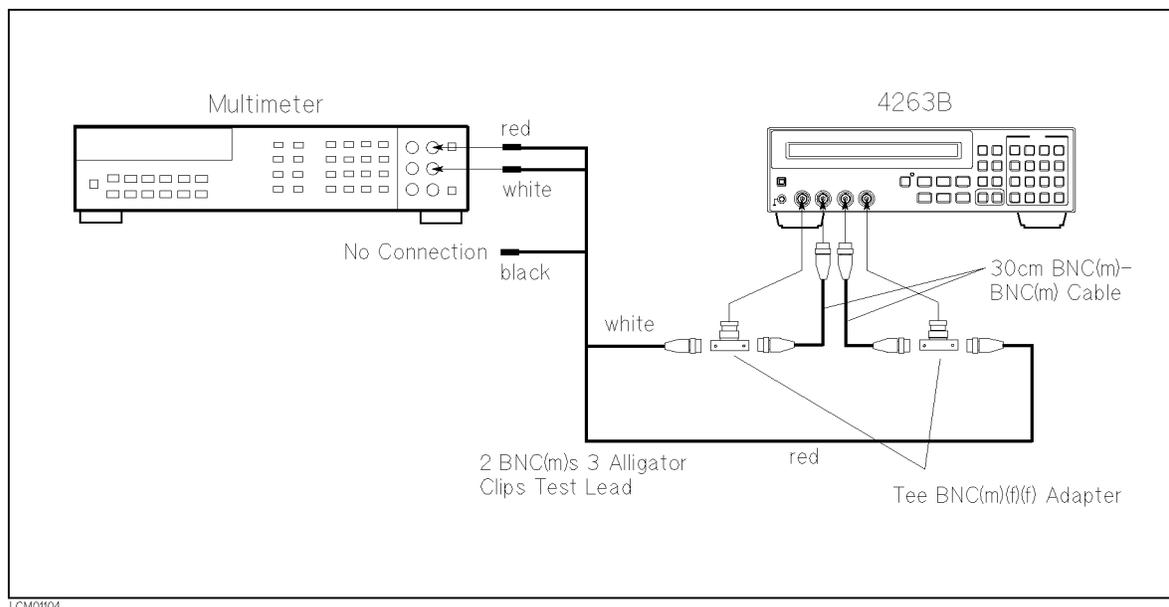

Figure 9-4. DC Bias Level Accuracy Test Setup Without The Interface Box

3. Press the 3458A Multimeter's **(DCV)** to set the measurement mode to DC voltage.
4. Press **DC Bias** to turn the DC Bias ON. (DC Bias indicator ON.)
5. Record the multimeter reading on the calculation sheet. (Default DC Bias setting is 0 V)
6. Calculate the test result according to the calculation sheet, and record the result into the performance test record.
7. Change the DC bias voltage using the following procedure to perform this test for all settings listed in Table 9-4.
 - a. Press **blue** **Bias Setup Level** to display the DC Bias Setting.
 - b. Select the desired DC bias voltage using **↑** or **↓**, and press **Enter**.

Table 9-4. Bias Level Accuracy Test Settings

DC Bias Level
0 V
1.5 V
2 V

4263B

0 m Impedance Measurement Accuracy Test

The 4263B measures the calibrated standard capacitors and resistors at the 4263B's front panel, and the measured values are compared with the standards' listed calibration values.

Specification

Basic Measurement Accuracy: $\pm 0.1\%$ (See Chapter 8 General Information for details.)

Test Equipment

Description	Recommended Model
Standard Capacitor Set	16380A
Standard Capacitor Set	16380C
100 m Ω Standard Resistor	42033A ¹
100 k Ω Standard Resistor	42039A ^{1, 2}
OPEN Termination	42090A ²
SHORT Termination	42091A ²

¹ Part of 42030A Standard Resistor Set

² 16074A can be used as a substitute.

Procedure

0 m Capacitance Measurement Accuracy Test (Meas. Time Mode: LONG).

1. Record the 16380A, 16380C, and 42030A calibration values on the calculation sheet.
2. Reset the 4263B.
3. Connect the OPEN termination to the 4263B's UNKNOWN terminals.

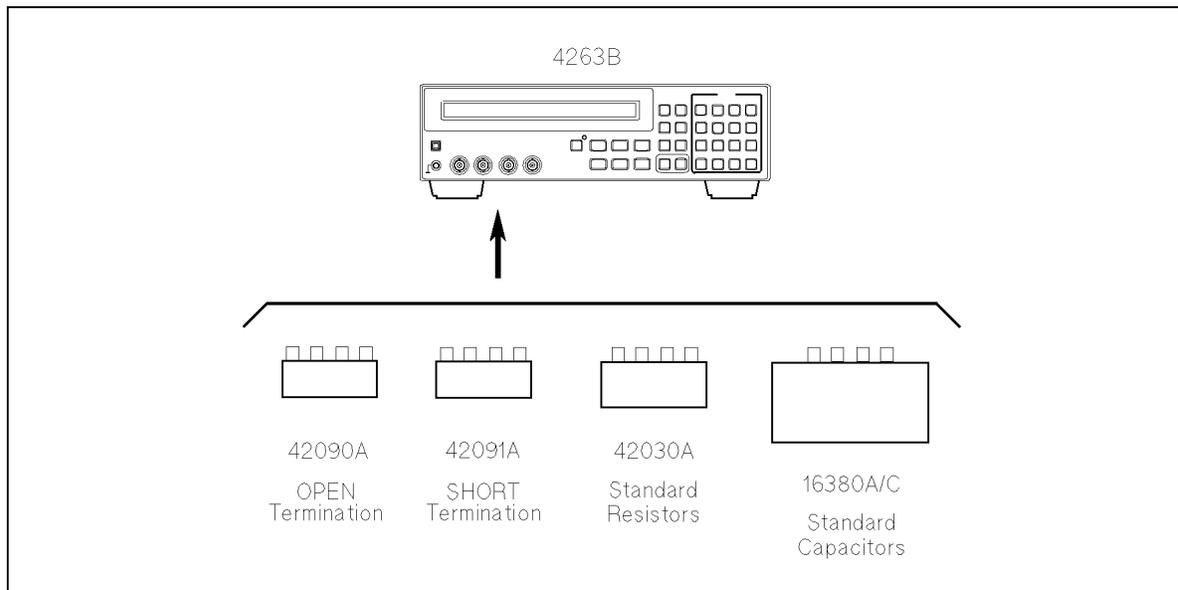

LCM01005

Figure 9-5. 0 m Impedance Measurement Accuracy Test Setup

4. Press   to display the OPEN correction menu.
5. Select **Open Meas** and press  . The OPEN correction is performed.
6. Connect the SHORT termination to the 4263B's UNKNOWN terminals.
7. Press   to display the SHORT correction menu.
8. Select **ShortMeas** and press  . The SHORT correction is performed.
9. Set the 4263B measurement conditions as follows:

Measurement Parameter:	Cp-D (Default Setting)
Measurement Time Mode:	LONG
Test Signal Level:	1 V (Default Setting)
Test Signal Frequency:	100 kHz
Trigger Mode:	Man

10. Connect the 10 pF Standard Capacitor to the 4263B's UNKNOWN terminals.
11. Press  to start the measurement.
12. Record the 4263B readings of Cp and D on the calculation sheet.
13. Calculate the test results according to the calculation sheet, and record the results into the performance test record.
14. Perform this test for all standards and frequency settings listed in Table 9-5.

Table 9-5. 0 m Capacitance Measurement Test (LONG) Settings

Standard	Test Signal Frequency
10 pF	100 kHz
100 pF	1 kHz 10 kHz 20 kHz ¹ 100 kHz
1000 pF	100 Hz 1 kHz 100 kHz
0.01 μ F	100 Hz 120 Hz 1 kHz 10 kHz 100 kHz
0.1 μ F	1 kHz 100 kHz
1 μ F	100 Hz 120 Hz 1 kHz 10 kHz 100 kHz

¹ Option 002 only.

0 m Capacitance Measurement Accuracy Test (Meas. Time Mode: MED).

15. Set the 4263B measurement conditions as follows:

Measurement Parameter:	Cp-D
Measurement Time Mode:	MED
Test Signal Level:	500 mV
Test Signal Frequency:	100 Hz
Trigger Mode:	Man

16. Connect the 0.01 μ F Standard Capacitor to the 4263B's UNKNOWN terminals.

17. Press  to start the measurement.

18. Record the 4263B readings of Cp and D on the calculation sheet.

19. Calculate the test results according to the calculation sheet, and record the results into the performance test record.

20. Perform the test at 100 kHz.

Table 9-6. 0 m Capacitance Measurement Test (MED) Settings

Standard	Test Signal Frequency
0.01 μ F	100 Hz 100 kHz

0 m Capacitance Measurement Accuracy Test (Meas. Time Mode: SHORT).

21. Set the 4263B measurement conditions as follows:

Measurement Parameter:	Cp-D
Measurement Time Mode:	SHORT
Test Signal Level:	500 mV
Test Signal Frequency:	100 Hz
Trigger Mode:	Man

22. Connect the 0.01 μ F Standard Capacitor to the 4263B's UNKNOWN terminals.

23. Press  to start the measurement.

24. Record the 4263B readings of Cp and D on the calculation sheet.

25. Calculate the test results according to the calculation sheet, and record the results into the performance test record.

26. Perform the test at 100 kHz.

Table 9-7. 0 m Capacitance Measurement Test (SHORT) Settings

Standard	Test Signal Frequency
0.01 μ F	100 Hz 100 kHz

0 m Capacitance Measurement Accuracy Test (DC Bias: ON).

27. Set the 4263B measurement conditions as follows:

Measurement Parameter:	Cp-D
Measurement Time Mode:	LONG
Test Signal Level:	1 V
Test Signal Frequency:	1 kHz
Trigger Mode:	Man

28. Connect the 1 μ F Standard Capacitor to the 4263B's UNKNOWN terminals.

4263B

29. Set the DC bias voltage to 2 V according to the following procedure:

a. Press   to display the DC Bias Setting.

b. Press  until 2 V blinks, and press .

c. Press  to turn the DC Bias ON. (DC Bias indicator ON.)

30. Press  to start the measurement.

31. Record the 4263B readings of Cp and D on the calculation sheet.

32. Calculate the test results according to the calculation sheet, and record the results into the performance test record.

33. Press  to turn the DC Bias off.

Table 9-8. 0 m Capacitance Measurement Test (DC Bias) Setting

Standard	Test Signal Frequency
1 μ F	1 kHz

0 m Resistance Measurement Accuracy Test (Meas. Time Mode: LONG).

34. Set the 4263B measurement conditions as follows:

Measurement Parameter:	R-X
Measurement Time Mode:	LONG
Test Signal Level:	1 V
Test Signal Frequency:	100 Hz
Trigger Mode:	Man

35. Connect the 100 m Ω Standard Resistor to the 4263B's UNKNOWN terminals.

36. Press  to start the measurement.

37. Record the 4263B readings of R on the calculation sheet.

38. Calculate the test results according to the calculation sheet, and record the result into the performance test record.

39. Perform the test at 1 kHz.

Table 9-9. 0 m Resistance Measurement Test (LONG) Settings

Standard	Test Signal Frequency
100 mΩ	100 Hz 1 kHz

0 m Resistance Measurement Accuracy Test (Meas. Time Mode: MED).

40. Set the 4263B measurement conditions as follows:

Measurement Parameter:	R-X
Measurement Time Mode:	MED
Test Signal Level:	500 mV
Test Signal Frequency:	100 Hz
Trigger Mode:	Man

41. Connect the 100 mΩ Standard Resistor to the 4263B's UNKNOWN terminals.

42. Press  to start the measurement.

43. Record the 4263B readings of R on the calculation sheet.

44. Calculate the test results according to the calculation sheet, and record the result into the performance test record.

Table 9-10. 0 m Resistance Measurement Test (MED) Settings

Standard	Test Signal Frequency
100 mΩ	100 Hz

0 m Resistance Measurement Accuracy Test (Meas. Time Mode: SHORT).

45. Set the 4263B measurement conditions as follows:

Measurement Parameter:	R-X
Measurement Time Mode:	SHORT
Test Signal Level:	500 mV
Test Signal Frequency:	100 Hz
Trigger Mode:	Man

46. Connect the 100 mΩ Standard Resistor to the 4263B's UNKNOWN terminals.

47. Press  to start the measurement.

48. Record the 4263B readings of R on the calculation sheet.

49. Calculate the test results according to the calculation sheet, and record the result into the performance test record.

4263B

Table 9-11. 0 m Resistance Measurement Test (SHORT) Settings

Standard	Test Signal Frequency
100 mΩ	100 Hz

0 m DC Resistance Measurement Accuracy Test (Opt. 001 Only).

50. Set the 4263B measurement conditions as follows:

Measurement Parameter:	Ls-Rdc
Measurement Time Mode:	LONG
Test Signal Level:	1 V
Trigger Mode:	Man

51. Connect the 100 mΩ Standard Resistor to the 4263B's UNKNOWN terminals.

52. Press  to start the measurement.

53. Record the 4263B readings of Rdc on the calculation sheet.

54. Calculate the test results according to the calculation sheet, and record the result into the performance test record.

55. Perform this test for the 100 kΩ Standard Resistor.

1 m Impedance Measurement Accuracy Test

The 4263B measures the calibrated standard capacitors and resistors while using the 1 m test leads, and the measured values are compared with the standards' listed calibration values.

Specification

Basic Measurement Accuracy: $\pm 0.1\%$ (See Chapter 8 General Information for details.)

Test Equipment

Description	Recommended Model
Standard Capacitor Set	16380A
Standard Capacitor Set	16380C
100 m Ω Standard Resistor	42033A ¹
100 k Ω Standard Resistor	42039A ^{1,2}
OPEN Termination	42090A ²
SHORT Termination	42091A ²
Test Leads, 1 m	16048A
Adapter BNC(f)-BNC(f)	p/n 1250-0080, 4 ea.

¹ Part of 42030A Standard Resistor Set

² 16074A can be used as a substitute.

Procedure

1 m Capacitance Measurement Accuracy Test.

- Record the 16380A, the 16380C, and the 42030A calibration values on the calculation sheet.
- Reset the 4263B.
- Set the cable length to 1 m using the following procedure:
 - Press   to display the cable length setting menu.
 - Select 1 m using  or , and press .
- Connect the OPEN termination to the 4263B's UNKNOWN terminals using the 1 m test leads and four BNC(f)-BNC(f) adapters.

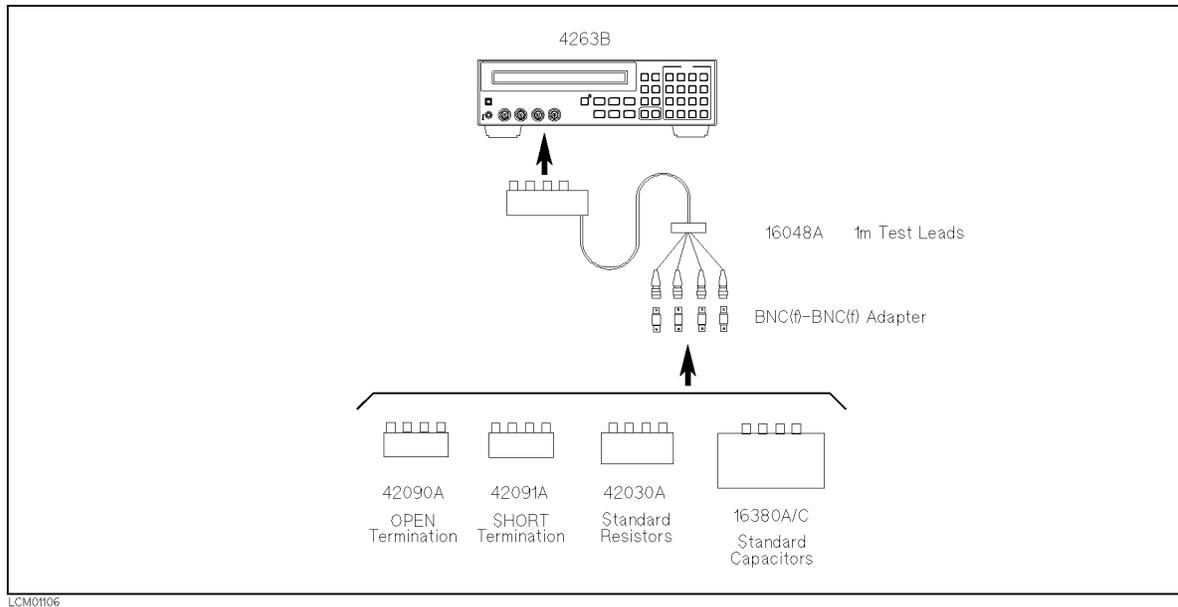

Figure 9-6. 1 m Impedance Measurement Accuracy Test Setup

5. Press   to display the OPEN correction menu.
6. Select **OpenMeas** and press . The OPEN correction is performed.
7. Connect the SHORT termination instead of the OPEN termination.
8. Press   to display the SHORT correction menu.
9. Select **ShortMeas** and press . The SHORT correction is performed.
10. Set the 4263B measurement conditions as follows:

Measurement Parameter:	Cp-D (Default Setting)
Measurement Time Mode:	LONG
Test Signal Level:	1 V (Default Setting)
Test Signal Frequency:	1 kHz (Default Setting)
Trigger Mode:	Man
11. Connect the 100 pF Standard Capacitor to the 4263B's UNKNOWN terminals using the 1 m Test Leads and four BNC(f)-BNC(f) Adapters.
12. Press  to start the measurement.
13. Record the 4263B readings of Cp and D on the calculation sheet.

14. Calculate the test results according to the calculation sheet, and record the results into the performance test record.
15. Perform this test for all standards and frequency settings listed in Table 9-12.

Table 9-12. 1 m Capacitance Measurement Test Settings

Standard	Test Signal Frequency
100 pF	1 kHz 10 kHz 20 kHz ¹ 100 kHz
1000 pF	100 Hz
1 μ F	100 Hz 1 kHz 10 kHz 100 kHz

¹ Option 002 only.

1 m Resistance Measurement Accuracy Test.

16. Set the 4263B measurement conditions as follows:

Measurement Parameter:	R-X
Measurement Time Mode:	LONG
Test Signal Level:	1 V
Test Signal Frequency:	100 Hz
Trigger Mode:	Man

17. Connect the 100 m Ω Standard Resistor to the 4263B's UNKNOWN terminals using the 1 m test leads and four BNC(f)-BNC(f) adapters.
18. Press  to start the measurement.
19. Record the 4263B readings of R on the calculation sheet.
20. Calculate the test results according to the calculation sheet, and record the result into the performance test record.
21. Perform this test at 1 kHz.

Table 9-13. 1 m Resistance Measurement Test Settings

Standard	Test Signal Frequency
100 m Ω	100 Hz 1 kHz

4263B

1 m DC Resistance Measurement Accuracy Test (Opt. 001 Only).

22. Set the 4263B measurement condition as follows.

Measurement Parameter:	Ls-Rdc
Measurement Time Mode:	LONG
Test Signal Level:	1 V
Trigger Mode:	Man

23. Connect the 100 m Ω Standard Resistor to the 4263B's UNKNOWN terminals using the 1 m test leads and four BNC(f)-BNC(f) adapters.

24. Press  to start the measurement.

25. Record the 4263B readings of Rdc on the calculation sheet.

26. Calculate the test results according to the calculation sheet, and record the result into the performance test record.

27. Perform this test for the 100 k Ω standard resistor.

2 m Impedance Measurement Accuracy Test

The 4263B measures the calibrated standard capacitors and resistors while using the 2 m test leads, and the measured values are compared with the standards' listed calibration values.

Specification

Basic Measurement Accuracy: $\pm 0.1\%$ (See Chapter 8 General Information for details.)

Test Equipment

Description	Recommended Model
Standard Capacitor Set	16380A
Standard Capacitor Set	16380C
100 m Ω Standard Resistor	42033A ¹
100 k Ω Standard Resistor	42039A ^{1, 2}
OPEN Termination	42090A ²
SHORT Termination	42091A ²
Test Leads, 2m	16048D
Adapter BNC(f)-BNC(f)	p/n 1250-0080, 4 ea.

¹ Part of 42030A Standard Resistor Set

² 16074A can be used as a substitute.

Procedure

2 m Capacitance Measurement Accuracy Test.

- Record the 16380A, 16380C and 42030A calibration values on the calculation sheet.
- Reset the 4263B.
- Set the cable length to 2 m using the following procedure:
 - Press   to display the cable length setting menu.
 - Select 2 m using  or , and press .
- Connect the OPEN termination to the 4263B's UNKNOWN terminals using the 2 m test leads and four BNC(f)-BNC(f) adapters.

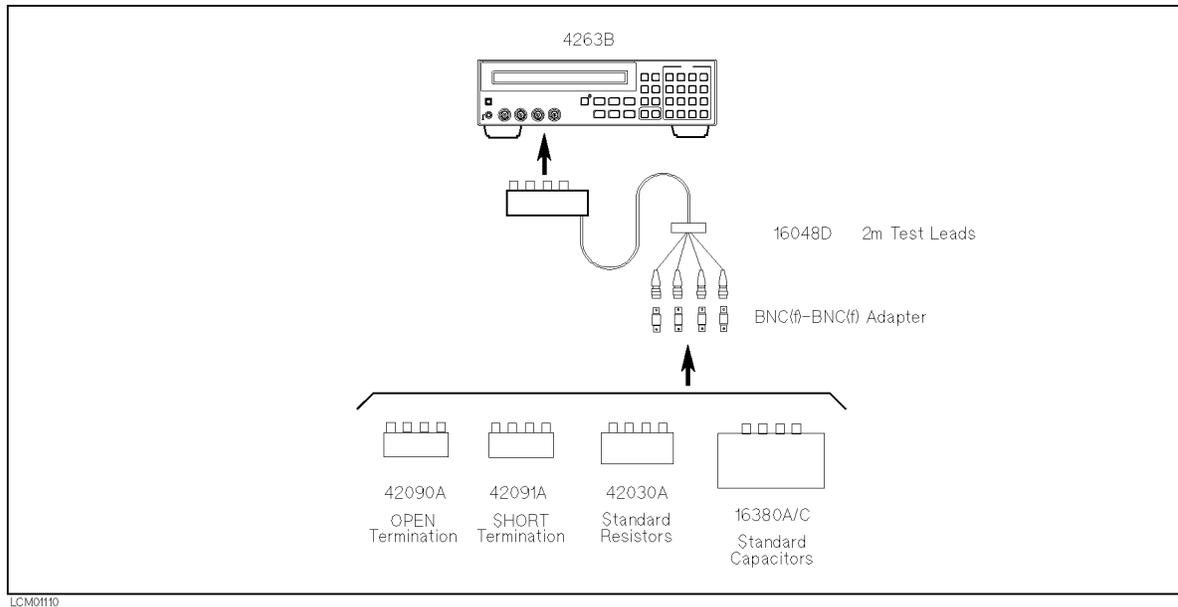

Figure 9-7. 2 m Impedance Measurement Accuracy Test Setup

5. Press   to display the OPEN correction correction menu.
6. Select **Open Meas** and press . The OPEN correction is performed.
7. Connect the SHORT termination instead of the OPEN termination.
8. Press   to display the SHORT correction menu.
9. Select **ShortMeas** and press . The SHORT correction is performed.
10. Set the 4263B measurement conditions as follows:

Measurement Parameter:	Cp-D (Default Setting)
Measurement Time Mode:	LONG
Test Signal Level:	1 V (Default Setting)
Test Signal Frequency:	1 kHz (Default Setting)
Trigger Mode:	Man
11. Connect the 100 pF Standard Capacitor to the 4263B's UNKNOWN terminals using the 2 m test leads and four BNC(f)-BNC(f) adapters.
12. Press  to start the measurement.
13. Record the 4263B readings of Cp and D on the calculation sheet.

14. Calculate the test results according to the calculation sheet, and record the results into the performance test record.
15. Perform this test for all standards and frequency settings listed in Table 9-14.

Table 9-14. 2 m Capacitance Measurement Test Settings

Standard	Test Signal Frequency
100 pF	1 kHz 10 kHz 20 kHz ¹
1000 pF	100 Hz
1 μ F	100 Hz 1 kHz 10 kHz

¹ Option 002 only.

2 m Resistance Measurement Accuracy Test.

16. Set the 4263B measurement conditions as follows:

Measurement Parameter:	R-X
Measurement Time Mode:	LONG
Test Signal Level:	1 V
Test Signal Frequency:	100 Hz
Trigger Mode:	Man

17. Connect the 100 m Ω Standard Resistor to the 4263B's UNKNOWN terminals using the 2 m test leads and four BNC(f)-BNC(f) adapters.
18. Press  to start the measurement.
19. Record the 4263B readings of R on the calculation sheet.
20. Calculate the test results according to the calculation sheet, and record the result into the performance test record.
21. Perform this test at 1 kHz.

Table 9-15. 2 m Resistance Measurement Test Settings

Standard	Test Signal Frequency
100 m Ω	100 Hz 1 kHz

4263B

2 m DC Resistance Measurement Accuracy Test (Opt. 001 Only).

22. Set the 4263B measurement condition as follows.

Measurement Parameter:	Ls-Rdc
Measurement Time Mode:	LONG
Test Signal Level:	1 V
Trigger Mode:	Man

23. Connect the 100 m Ω Standard Resistor to the 4263B's UNKNOWN terminals using the 2 m test leads and four BNC(f)-BNC(f) adapters.

24. Press  to start the measurement.

25. Record the 4263B readings of DCR on the calculation sheet.

26. Calculate the test results according to the calculation sheet, and record the result into the performance test record.

27. Perform this test for the 100 k Ω standard resistor.

4 m Impedance Measurement Accuracy Test

The 4263B measures the calibrated standard capacitors and resistors while using the 4 m test leads, and the measured values are compared with the standards' listed calibration values.

Specification

Basic Measurement Accuracy: $\pm 0.1\%$ (See Chapter 8 General Information for details.)

Test Equipment

Description	Recommended Model
Standard Capacitor Set	16380A
Standard Capacitor Set	16380C
100 m Ω Standard Resistor	42033A ¹
100 k Ω Standard Resistor	42039A ^{1, 2}
OPEN Termination	42090A ²
SHORT Termination	42091A ²
Test Leads, 4 m	16048E
Adapter BNC(f)-BNC(f)	p/n 1250-0080, 4 ea.

¹ Part of 42030A Standard Resistor Set

² 16074A can be used as a substitute.

Procedure

4 m Capacitance Measurement Accuracy Test.

- Record the 16380A, 16380C, and 42030A calibration values on the calculation sheet.
- Reset the 4263B.
- Set the cable length to 4 m using the following procedure:
 - Press   to display the cable length setting menu.
 - Select 4 m using  or , and press .
- Connect the OPEN termination to the 4263B's UNKNOWN terminals using the 4 m Test Leads and four BNC(f)-BNC(f) Adapters.

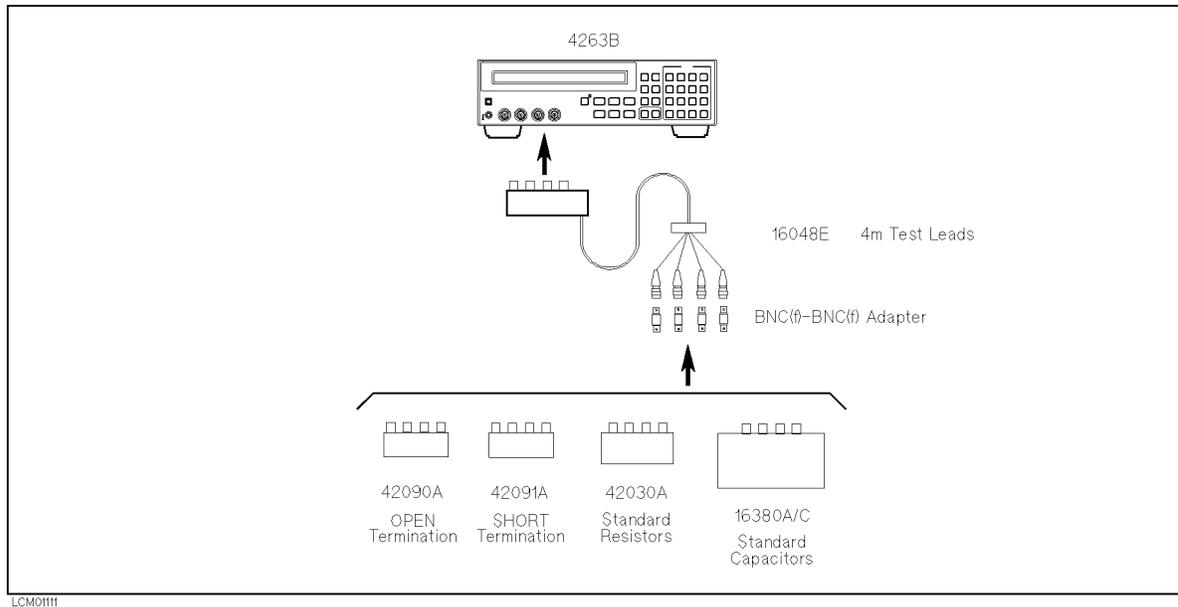

Figure 9-8. 4 m Impedance Measurement Accuracy Test Setup

5. Press   to display the OPEN correction menu.
6. Select **OpenMeas** and press . The OPEN correction is performed.
7. Connect the SHORT termination instead of the OPEN termination.
8. Press   to display the SHORT correction menu.
9. Select **ShortMeas** and press . The SHORT correction is performed.
10. Set the 4263B measurement conditions as follows:

Measurement Parameter:	Cp-D (Default Setting)
Measurement Time Mode:	LONG
Test Signal Level:	1 V (Default Setting)
Test Signal Frequency:	1 kHz (Default Setting)
Trigger Mode:	Man
11. Connect the 100 pF Standard Capacitor to the 4263B's UNKNOWN terminals using the 4 m test leads and four BNC(f)-BNC(f) adapters.
12. Press  to start the measurement.
13. Record the 4263B readings of Cp and D on the calculation sheet.

14. Calculate the test results according to the calculation sheet, and record the results into the performance test record.
15. Perform this test for all standards and frequency settings listed in Table 9-16.

Table 9-16. 4 m Capacitance Measurement Test Settings

Standard	Test Signal Frequency
100 pF	1 kHz
1000 pF	100 Hz
1 μ F	100 Hz 1 kHz

4 m Resistance Measurement Accuracy Test.

16. Set the 4263B measurement conditions as follows:

Measurement Parameter:	R-X
Measurement Time Mode:	LONG
Test Signal Level:	1 V
Test Signal Frequency:	100 Hz
Trigger Mode:	Man

17. Connect the 100 m Ω Standard Resistor to the 4263B's UNKNOWN terminals using the 4 m test leads and four BNC(f)-BNC(f) adapters.
18. Press  to start the measurement.
19. Record the 4263B readings of R on the calculation sheet.
20. Calculate the test results according to the calculation sheet, and record the result into the performance test record.
21. Perform this test at 1 kHz.

Table 9-17. 4 m Resistance Measurement Test Settings

Standard	Test Signal Frequency
100 m Ω	100 Hz 1 kHz

4263B

4 m DC Resistance Measurement Accuracy Test (Opt. 001 Only).

22. Set the 4263B measurement condition as follows.

Measurement Parameter:	Ls-Rdc
Measurement Time Mode:	LONG
Test Signal Level:	1 V
Trigger Mode:	Man

23. Connect the 100 m Ω Standard Resistor to the 4263B's UNKNOWN terminals using the 4 m test leads and four BNC(f)-BNC(f) adapters.

24. Press  to start the measurement.

25. Record the 4263B readings of Rdc on the calculation sheet.

26. Calculate the test results according to the calculation sheet, and record the result into the performance test record.

27. Perform this test for the 100 k Ω standard resistor.

Calculation Sheet

Test Signal Frequency Accuracy Test

Test Signal Frequency	Counter Reading [a]	Test Result Equation
100 Hz	_____ Hz	a – 100.000 Hz
120 Hz	_____ Hz	a – 120.000 Hz
1 kHz	_____ kHz	a – 1.00000 kHz
10 kHz	_____ kHz	a – 10.0000 kHz
20 kHz ¹	_____ kHz	a – 20.0000 kHz
100 kHz	_____ kHz	a – 100.000 kHz

¹ Option 002 only.

Test Signal Level Accuracy Test

Test Signal Level	Test Signal Frequency	Multimeter Reading [a]	Test Result Equation
50 mV	100 Hz	_____ mV	a – 50.0 mV
50 mV	20 kHz ¹	_____ mV	a – 50.0 mV
50 mV	100 kHz	_____ mV	a – 50.0 mV
250 mV	100 Hz	_____ mV	a – 250 mV
250 mV	20 kHz ¹	_____ mV	a – 250 mV
250 mV	100 kHz	_____ mV	a – 250 mV
1 V	100 Hz	_____ V	a – 1.00 V
1 V	20 kHz ¹	_____ V	a – 1.00 V
1 V	100 kHz	_____ V	a – 1.00 V

¹ Option 002 only.

DC Bias Level Accuracy Test

DC Bias Level	Multimeter Reading [a]	Test Result Equation
0 V	_____ V	a
1.5 V	_____ V	a – 1.500 V
2 V	_____ V	a – 2.000 V

4263B

Standards' Calibration Values

This table is used in the 0 m, 1 m, 2 m, and 4 m Impedance Measurement Accuracy Tests.

Standard	Frequency	Parameter	Calibration Value	Reference Designation
10 pF	1 kHz	Cp	_____ pF	cv1
		D	_____	cv2
100 pF	1 kHz	Cp	_____ pF	cv3
		D	_____	cv4
1000 pF	1 kHz	Cp	_____ pF	cv5
		D	_____	cv6
0.01 μ F	120 Hz	Cp	_____ nF	cv7
		D	_____	cv8
0.01 μ F	1 kHz	Cp	_____ nF	cv9
		D	_____	cv10
0.01 μ F	10 kHz	Cp	_____ nF	cv11
		D	_____	cv12
0.01 μ F	100 kHz	Cp	_____ nF	cv13
		D	_____	cv14
0.1 μ F	1 kHz	Cp	_____ nF	cv15
		D	_____	cv16
0.1 μ F	100 kHz	Cp	_____ nF	cv17
		D	_____	cv18
1 μ F	120 Hz	Cp	_____ μ F	cv19
		D	_____	cv20
1 μ F	1 kHz	Cp	_____ μ F	cv21
		D	_____	cv22
1 μ F	10 kHz	Cp	_____ μ F	cv23
		D	_____	cv24
1 μ F	100 kHz	Cp	_____ μ F	cv25
		D	_____	cv26
100 m Ω	DC	R	_____ m Ω	cv27
100 k Ω	DC	R	_____ k Ω	cv28

0 m Impedance Measurement Accuracy Test

0 m Capacitance Measurement Accuracy Test (Meas. Time Mode: LONG)

Standard	Test Signal Frequency	Parameter Measured	4263B Reading [a]	Test Result Equation
10 pF	100 kHz	Cp	_____ pF	a – cv1
		D	_____	a – cv2
100 pF	1 kHz	Cp	_____ pF	a – cv3
		D	_____	a – cv4
100 pF	10 kHz	Cp	_____ pF	a – cv3
		D	_____	a – cv4
100 pF	20 kHz ¹	Cp	_____ pF	a – cv3
		D	_____	a – cv4
100 pF	100 kHz	Cp	_____ pF	a – cv3
		D	_____	a – cv4
1000 pF	100 Hz	Cp	_____ pF	a – cv5
		D	_____	a – cv6
1000 pF	1 kHz	Cp	_____ pF	a – cv5
		D	_____	a – cv6
1000 pF	100 kHz	Cp	_____ pF	a – cv5
		D	_____	a – cv6
0.01 μ F	100 Hz	Cp	_____ nF	a – cv7
		D	_____	a – cv8
0.01 μ F	120 Hz	Cp	_____ nF	a – cv7
		D	_____	a – cv8
0.01 μ F	1 kHz	Cp	_____ nF	a – cv9
		D	_____	a – cv10
0.01 μ F	10 kHz	Cp	_____ nF	a – cv11
		D	_____	a – cv12
0.01 μ F	100 kHz	Cp	_____ nF	a – cv13
		D	_____	a – cv14
0.1 μ F	1 kHz	Cp	_____ nF	a – cv15
		D	_____	a – cv16
0.1 μ F	100 kHz	Cp	_____ nF	a – cv17
		D	_____	a – cv18
1 μ F	100 Hz	Cp	_____ μ F	a – cv19
		D	_____	a – cv20
1 μ F	120 Hz	Cp	_____ μ F	a – cv19
		D	_____	a – cv20

¹ Option 002 only.

0 m Capacitance Measurement Accuracy Test (Meas. Time Mode: LONG)

Standard	Test Signal Frequency	Parameter Measured	4263B Reading [a]	Test Result Equation
1 μ F	1 kHz	Cp	_____ μ F	a – cv21
		D	_____	a – cv22
1 μ F	10 kHz	Cp	_____ μ F	a – cv23
		D	_____	a – cv24
1 μ F	100 kHz	Cp	_____ μ F	a – cv25
		D	_____	a – cv26

0 m Capacitance Measurement Accuracy Test (Meas. Time Mode: MED)

Standard	Test Signal Frequency	Parameter Measured	4263B Reading [a]	Test Result Equation
0.01 μ F	100 Hz	Cp	_____ nF	a – cv7
		D	_____	a – cv8
0.01 μ F	100 kHz	Cp	_____ nF	a – cv13
		D	_____	a – cv14

0 m Capacitance Measurement Accuracy Test (Meas. Time Mode: SHORT)

Standard	Test Signal Frequency	Parameter Measured	4263B Reading [a]	Test Result Equation
0.01 μ F	100 Hz	Cp	_____ nF	a – cv7
		D	_____	a – cv8
0.01 μ F	100 kHz	Cp	_____ nF	a – cv13
		D	_____	a – cv14

0 m Capacitance Measurement Accuracy Test (DC Bias: ON)

Standard	Test Signal Frequency	Parameter Measured	4263B Reading [a]	Test Result Equation
1 μ F	1 kHz	Cp	_____ μ F	a – cv21
		D	_____	a – cv22

0 m Resistance Measurement Accuracy Test (Meas. Time Mode: LONG)

Standard	Test Signal Frequency	Parameter Measured	4263B Reading [a]	Test Result Equation
100 m Ω	100 Hz	R	_____ m Ω	a – cv27
100 m Ω	1 kHz	R	_____ m Ω	a – cv27

0 m Resistance Measurement Accuracy Test (Meas. Time Mode: MED)

Standard	Test Signal Frequency	Parameter Measured	4263B Reading [a]	Test Result Equation
100 mΩ	100 Hz	R	_____ mΩ	a – cv27

0 m Resistance Measurement Accuracy Test (Meas. Time Mode: SHORT)

Standard	Test Signal Frequency	Parameter Measured	4263B Reading [a]	Test Result Equation
100 mΩ	100 Hz	R	_____ mΩ	a – cv27

0 m DC Resistance Measurement Accuracy Test

Standard	4263B Reading [a]	Test Result Equation
100 mΩ	_____ mΩ	a – cv27
100 kΩ	_____ kΩ	a – cv28

1 m Impedance Measurement Accuracy Test

1 m Capacitance Measurement Accuracy Test

Standard	Test Signal Frequency	Parameter Measured	4263B Reading [a]	Test Result Equation
100 pF	1 kHz	Cp	_____ pF	a – cv3
		D	_____	a – cv4
100 pF	10 kHz	Cp	_____ pF	a – cv3
		D	_____	a – cv4
100 pF	20 kHz ¹	Cp	_____ pF	a – cv3
		D	_____	a – cv4
100 pF	100 kHz	Cp	_____ pF	a – cv3
		D	_____	a – cv4
1000 pF	100 Hz	Cp	_____ pF	a – cv5
		D	_____	a – cv6
1 μF	100 Hz	Cp	_____ μF	a – cv19
		D	_____	a – cv20
1 μF	1 kHz	Cp	_____ μF	a – cv21
		D	_____	a – cv22
1 μF	10 kHz	Cp	_____ μF	a – cv23
		D	_____	a – cv24
1 μF	100 kHz	Cp	_____ μF	a – cv25
		D	_____	a – cv26

¹ Option 002 only.

1 m Resistance Measurement Accuracy Test

Standard	Test Signal Frequency	Parameter Measured	4263B Reading [a]	Test Result Equation
100 mΩ	100 Hz	R	_____ mΩ	a – cv27
100 mΩ	1 kHz	R	_____ mΩ	a – cv27

1 m DC Resistance Measurement Accuracy Test

Standard	4263B Reading [a]	Test Result Equation
100 mΩ	_____ mΩ	a – cv27
100 kΩ	_____ kΩ	a – cv28

2 m Impedance Measurement Accuracy Test

2 m Capacitance Measurement Accuracy Test

Standard	Test Signal Frequency	Parameter Measured	4263B Reading [a]	Test Result Equation
100 pF	1 kHz	Cp	_____ pF	a – cv3
		D	_____	a – cv4
100 pF	10 kHz	Cp	_____ pF	a – cv3
		D	_____	a – cv4
100 pF	20 kHz ¹	Cp	_____ pF	a – cv3
		D	_____	a – cv4
1000 pF	100 Hz	Cp	_____ pF	a – cv5
		D	_____	a – cv6
1 μF	100 Hz	Cp	_____ μF	a – cv19
		D	_____	a – cv20
1 μF	1 kHz	Cp	_____ μF	a – cv21
		D	_____	a – cv22
1 μF	10 kHz	Cp	_____ μF	a – cv23
		D	_____	a – cv24

¹ Option 002 only.

2 m Resistance Measurement Accuracy Test

Standard	Test Signal Frequency	Parameter Measured	4263B Reading [a]	Test Result Equation
100 mΩ	100 Hz	R	_____ mΩ	a – cv27
100 mΩ	1 kHz	R	_____ mΩ	a – cv27

2 m DC Resistance Measurement Accuracy Test

Standard	4263B Reading [a]	Test Result Equation
100 mΩ	_____ mΩ	a – cv27
100 kΩ	_____ kΩ	a – cv28

4263B

4 m Impedance Measurement Accuracy Test

4 m Capacitance Measurement Accuracy Test

Standard	Test Signal Frequency	Parameter Measured	4263B Reading [a]	Test Result Equation
100 pF	1 kHz	Cp	_____ pF	a – cv3
		D	_____	a – cv4
1000 pF	100 Hz	Cp	_____ pF	a – cv5
		D	_____	a – cv6
1 μF	100 Hz	Cp	_____ μF	a – cv19
		D	_____	a – cv20
1 μF	1 kHz	Cp	_____ μF	a – cv21
		D	_____	a – cv22

4 m Resistance Measurement Accuracy Test

Standard	Test Signal Frequency	Parameter Measured	4263B Reading [a]	Test Result Equation
100 mΩ	100 Hz	R	_____ mΩ	a – cv27
100 mΩ	1 kHz	R	_____ mΩ	a – cv27

4 m DC Resistance Measurement Accuracy Test

Standard	4263B Reading [a]	Test Result Equation
100 mΩ	_____ mΩ	a – cv27
100 kΩ	_____ kΩ	a – cv28

Performance Test Record

Agilent 4263B LCR Meter

Serial No.: _____

Date: _____

Temperature: _____

Tested by: _____

Humidity: _____

Test Signal Frequency Accuracy Test

Test Signal Frequency	Test Limits	Test Result ¹	Measurement Uncertainty
100 Hz	±0.010 Hz	_____ Hz	± 0.0010 Hz
120 Hz	±1.200 Hz	_____ Hz	±0.0012 Hz
1 kHz	±0.00010 kHz	_____ kHz	±0.0000088 kHz
10 kHz	±0.0010 kHz	_____ kHz	±0.000086 kHz
20 kHz ²	±0.0010 kHz	_____ kHz	±0.000086 kHz
100 kHz	±0.010 kHz	_____ kHz	±0.00086 kHz

1 Test Result = Measured Value – Setting Value

2 Option 002 only.

Test Signal Level Accuracy Test

Test Signal Level	Test Signal Frequency	Test Limits	Test Result ¹	Measurement Uncertainty
50 mV	100 Hz	± 15.0 mV	_____ mV	± 0.025 mV
50 mV	20 kHz ²	± 15.0 mV	_____ mV	± 0.010 mV
50 mV	100 kHz	± 15.0 mV	_____ mV	± 0.062 mV
250 mV	100 Hz	± 35.0 mV	_____ mV	± 0.041 mV
250 mV	20 kHz ²	± 35.0 mV	_____ mV	± 0.059 mV
250 mV	100 kHz	± 35.0 mV	_____ mV	± 0.22 mV
1 V	100 Hz	± 0.11 V	_____ V	± 0.0001 V
1 V	20 kHz ²	± 0.11 V	_____ V	± 0.0008 V
1 V	100 kHz	± 0.11 V	_____ V	± 0.0008 V

1 Test Result = Measured Value – Setting Value

2 Option 002 only.

4263B

DC Bias Level Accuracy Test

DC Bias Level	Test Limits	Test Result¹	Measurement Uncertainty
0 V	±0.002 V	_____ V	±0.000002 V
1.5 V	±0.077 V	_____ V	±0.000027 V
2 V	±0.102 V	_____ V	±0.000035 V

¹ Test Result = Measured Value – Setting Value

0 m Impedance Measurement Accuracy Test

0 m Capacitance Measurement Accuracy Test (Meas. Time Mode: LONG)

1 of 2

Standard	Test Signal Frequency	Parameter Measured	Test Limits	Test Result ¹	Measurement Uncertainty
10 pF	100 kHz	Cp	± 0.331 pF	_____ pF	± 0.0029 pF
		D	± 0.0331	_____	± 0.0002
100 pF	1 kHz	Cp	± 0.19 pF	_____ pF	± 0.018 pF
		D	± 0.0019	_____	± 0.0001
100 pF	10 kHz	Cp	± 0.44 pF	_____ pF	± 0.029 pF
		D	± 0.0044	_____	± 0.0002
100 pF	20 kHz ²	Cp	± 1.10 pF	_____ pF	± 0.029 pF
		D	± 0.0110	_____	± 0.0002
100 pF	100 kHz	Cp	± 1.37 pF	_____ pF	± 0.029 pF
		D	± 0.0137	_____	± 0.0002
1000 pF	100 Hz	Cp	± 2.0 pF	_____ pF	± 0.18 pF
		D	± 0.0020	_____	± 0.0001
1000 pF	1 kHz	Cp	± 1.2 pF	_____ pF	± 0.18 pF
		D	± 0.0012	_____	± 0.0001
1000 pF	100 kHz	Cp	± 12.8 pF	_____ pF	± 0.52 pF
		D	± 0.0128	_____	± 0.0002
0.01 μF	100 Hz	Cp	± 0.018 nF	_____ nF	± 0.0031 nF
		D	± 0.0018	_____	± 0.0001
0.01 μF	120 Hz	Cp	± 0.018 nF	_____ nF	± 0.0031 nF
		D	± 0.0018	_____	± 0.0001
0.01 μF	1 kHz	Cp	± 0.011 nF	_____ nF	± 0.0020 nF
		D	± 0.0011	_____	± 0.0001
0.01 μF	10 kHz	Cp	± 0.018 nF	_____ nF	± 0.0031 nF
		D	± 0.0018	_____	± 0.0002
0.01 μF	100 kHz	Cp	± 0.128 nF	_____ nF	± 0.0053 nF
		D	± 0.0128	_____	± 0.0003
0.1 μF	1 kHz	Cp	± 0.11 nF	_____ nF	± 0.020 nF
		D	± 0.0011	_____	± 0.0001
0.1 μF	100 kHz	Cp	± 1.47 nF	_____ nF	± 0.053 nF
		D	± 0.0147	_____	± 0.0005

1 Test Result = Measured Value – Standard's Calibration Value

2 Option 002 only.

0 m Capacitance Measurement Accuracy Test (Meas. Time Mode: LONG)
2 of 2

Standard	Test Signal Frequency	Parameter Measured	Test Limits	Test Result ¹	Measurement Uncertainty
1 μF	100 Hz	Cp	$\pm 0.0018 \mu\text{F}$	_____ μF	$\pm 0.00044 \mu\text{F}$
		D	± 0.0018	_____	± 0.00015
1 μF	120 Hz	Cp	$\pm 0.0018 \mu\text{F}$	_____ μF	$\pm 0.00044 \mu\text{F}$
		D	± 0.0018	_____	± 0.00015
1 μF	1 kHz	Cp	$\pm 0.0011 \mu\text{F}$	_____ μF	$\pm 0.00020 \mu\text{F}$
		D	± 0.0011	_____	± 0.0001
1 μF	10 kHz	Cp	$\pm 0.0026 \mu\text{F}$	_____ μF	$\pm 0.00044 \mu\text{F}$
		D	± 0.0026	_____	± 0.0004
1 μF	100 kHz	Cp	$\pm 0.0176 \mu\text{F}$	_____ μF	$\pm 0.0010 \mu\text{F}$
		D	± 0.0176	_____	± 0.0025

¹ Test Result = Measured Value – Standard's Calibration Value

0 m Capacitance Measurement Accuracy Test (Meas. Time Mode: MED)

Standard	Test Signal Frequency	Parameter Measured	Test Limits	Test Result ¹	Measurement Uncertainty
0.01 μF	100 Hz	Cp	$\pm 0.063 \text{ nF}$	_____ nF	$\pm 0.0031 \text{ nF}$
		D	± 0.0063	_____	± 0.0001
0.01 μF	100 kHz	Cp	$\pm 0.271 \text{ nF}$	_____ nF	$\pm 0.0053 \text{ nF}$
		D	± 0.0271	_____	± 0.0003

¹ Test Result = Measured Value – Standard's Calibration Value

0 m Capacitance Measurement Accuracy Test (Meas. Time Mode: SHORT)

Standard	Test Signal Frequency	Parameter Measured	Test Limits	Test Result ¹	Measurement Uncertainty
0.01 μF	100 Hz	Cp	$\pm 0.179 \text{ nF}$	_____ nF	$\pm 0.0031 \text{ nF}$
		D	± 0.0179	_____	± 0.0001
0.01 μF	100 kHz	Cp	$\pm 0.287 \text{ nF}$	_____ nF	$\pm 0.0053 \text{ nF}$
		D	± 0.0287	_____	± 0.0003

¹ Test Result = Measured Value – Standard's Calibration Value

0 m Capacitance Measurement Accuracy Test (DC Bias: ON)

Standard	Test Signal Frequency	Parameter Measured	Test Limits	Test Result ¹	Measurement Uncertainty
1 μF	1 kHz	Cp	$\pm 0.0011 \mu\text{F}$	_____ μF	$\pm 0.00020 \mu\text{F}$
		D	± 0.0011	_____	± 0.0001

¹ Test Result = Measured Value – Standard's Calibration Value

0 m Resistance Measurement Accuracy Test (Meas. Time Mode: LONG)

Standard	Test Signal Frequency	Parameter Measured	Test Limits	Test Result ¹	Measurement Uncertainty
100 mΩ	100 Hz	R	± 0.52 mΩ	_____ mΩ	± 0.10 mΩ
100 mΩ	1 kHz	R	± 0.48 mΩ	_____ mΩ	± 0.10 mΩ

¹ Test Result = Measured Value – Standard's Calibration Value

0 m Resistance Measurement Accuracy Test (Meas. Time Mode: MED)

Standard	Test Signal Frequency	Parameter Measured	Test Limits	Test Result ¹	Measurement Uncertainty
100 mΩ	100 Hz	R	± 0.62 mΩ	_____ mΩ	± 0.10 mΩ

¹ Test Result = Measured Value – Standard's Calibration Value

0 m Resistance Measurement Accuracy Test (Meas. Time Mode: SHORT)

Standard	Test Signal Frequency	Parameter Measured	Test Limits	Test Result ¹	Measurement Uncertainty
100 mΩ	100 Hz	R	± 1.10 mΩ	_____ mΩ	± 0.10 mΩ

¹ Test Result = Measured Value – Standard's Calibration Value

0 m DC Resistance Measurement Accuracy Test (Opt. 001 Only)

Standard	Test Limits	Test Result ¹	Measurement Uncertainty
100 mΩ	± 0.97 mΩ	_____ mΩ	± 0.10 mΩ
100 kΩ	± 0.87 kΩ	_____ kΩ	± 0.021 kΩ

¹ Test Result = Measured Value – Standard's Calibration Value

1 m Impedance Measurement Accuracy Test**1 m Capacitance Measurement Accuracy Test**

Standard	Test Signal Frequency	Parameter Measured	Test Limits	Test Result ¹	Measurement Uncertainty
100 pF	1 kHz	Cp	± 0.19 pF	_____ pF	± 0.018 pF
		D	± 0.0019	_____	± 0.0001
100 pF	10 kHz	Cp	± 0.48 pF	_____ pF	± 0.029 pF
		D	± 0.0048	_____	± 0.0002
100 pF	20 kHz ²	Cp	± 1.10 pF	_____ pF	± 0.029 pF
		D	± 0.0110	_____	± 0.0002
100 pF	100 kHz	Cp	± 1.37 pF	_____ pF	± 0.029 pF
		D	± 0.0137	_____	± 0.0002
1000 pF	100 Hz	Cp	± 2.0 pF	_____ pF	± 0.18 pF
		D	± 0.0020	_____	± 0.0001
1 μF	100 Hz	Cp	± 0.0018 μF	_____ μF	± 0.00044 μF
		D	± 0.0018	_____	± 0.00015
1 μF	1 kHz	Cp	± 0.0011 μF	_____ μF	± 0.00020 μF
		D	± 0.0011	_____	± 0.0001
1 μF	10 kHz	Cp	± 0.0026 μF	_____ μF	± 0.00044 μF
		D	± 0.0026	_____	± 0.0004
1 μF	100 kHz	Cp	± 0.0207 μF	_____ μF	± 0.0010 μF
		D	± 0.0207	_____	± 0.0025

1 Test Result = Measured Value – Standard's Calibration Value

2 Option 002 only.

1 m Resistance Measurement Accuracy Test

Standard	Test Signal Frequency	Parameter Measured	Test Limits	Test Result ¹	Measurement Uncertainty
100 mΩ	100 Hz	R	± 0.60 mΩ	_____ mΩ	± 0.10 mΩ
100 mΩ	1 kHz	R	± 0.60 mΩ	_____ mΩ	± 0.10 mΩ

1 Test Result = Measured Value – Standard's Calibration Value

1 m DC Resistance Measurement Accuracy Test (Opt. 001 Only)

Standard	Test Limits	Test Result ¹	Measurement Uncertainty
100 mΩ	± 1.05 mΩ	_____ mΩ	± 0.10 mΩ
100 kΩ	± 0.87 kΩ	_____ kΩ	± 0.021 kΩ

1 Test Result = Measured Value – Standard's Calibration Value

2 m Impedance Measurement Accuracy Test

2 m Capacitance Measurement Accuracy Test

Standard	Test Signal Frequency	Parameter Measured	Test Limits	Test Result ¹	Measurement Uncertainty
100 pF	1 kHz	Cp	± 0.19 pF	_____ pF	± 0.018 pF
		D	± 0.0019	_____	± 0.0001
100 pF	10 kHz	Cp	± 0.51 pF	_____ pF	± 0.029 pF
		D	± 0.0051	_____	± 0.0002
100 pF	20 kHz ²	Cp	± 1.10 pF	_____ pF	± 0.029 pF
		D	± 0.0110	_____	± 0.0002
1000 pF	100 Hz	Cp	± 2.0 pF	_____ pF	± 0.18 pF
		D	± 0.0020	_____	± 0.0001
1 μF	100 Hz	Cp	± 0.0018 μF	_____ μF	± 0.00044 μF
		D	± 0.0018	_____	± 0.00015
1 μF	1 kHz	Cp	± 0.0011 μF	_____ μF	± 0.00020 μF
		D	± 0.0011	_____	± 0.0001
1 μF	10 kHz	Cp	± 0.0026 μF	_____ μF	± 0.00044 μF
		D	± 0.0026	_____	± 0.0004

1 Test Result = Measured Value – Standard's Calibration Value

2 Option 002 only.

2 m Resistance Measurement Accuracy Test

Standard	Test Signal Frequency	Parameter Measured	Test Limits	Test Result ¹	Measurement Uncertainty
100 mΩ	100 Hz	R	± 0.68 mΩ	_____ mΩ	± 0.10 mΩ
100 mΩ	1 kHz	R	± 0.72 mΩ	_____ mΩ	± 0.10 mΩ

1 Test Result = Measured Value – Standard's Calibration Value

2 m DC Resistance Measurement Accuracy Test (Opt. 001 Only)

Standard	Test Limits	Test Result ¹	Measurement Uncertainty
100 mΩ	± 1.13 mΩ	_____ mΩ	± 0.10 mΩ
100 kΩ	± 0.87 kΩ	_____ kΩ	± 0.021 kΩ

1 Test Result = Measured Value – Standard's Calibration Value

4 m Impedance Measurement Accuracy Test**4 m Capacitance Measurement Accuracy Test**

Standard	Test Signal Frequency	Parameter Measured	Test Limits	Test Result¹	Measurement Uncertainty
100 pF	1 kHz	Cp	± 0.19 pF	_____ pF	± 0.018 pF
		D	± 0.0019	_____	± 0.0001
1000 pF	100 Hz	Cp	± 2.0 pF	_____ pF	± 0.18 pF
		D	± 0.0020	_____	± 0.0001
1 μF	100 Hz	Cp	± 0.0018 μF	_____ μF	± 0.00044 μF
		D	± 0.0018	_____	± 0.00015
1 μF	1 kHz	Cp	± 0.0011 μF	_____ μF	± 0.00020 μF
		D	± 0.0011	_____	± 0.0001

¹ Test Result = Measured Value – Standard's Calibration Value

4 m Resistance Measurement Accuracy Test

Standard	Test Signal Frequency	Parameter Measured	Test Limits	Test Result¹	Measurement Uncertainty
100 mΩ	100 Hz	R	± 0.84 mΩ	_____ mΩ	± 0.10 mΩ
100 mΩ	1 kHz	R	± 0.96 mΩ	_____ mΩ	± 0.10 mΩ

¹ Test Result = Measured Value – Standard's Calibration Value

4 m DC Resistance Measurement Accuracy Test (Opt. 001 Only)

Standard	Test Limits	Test Result¹	Measurement Uncertainty
100 mΩ	± 1.29 mΩ	_____ mΩ	± 0.10 mΩ
100 kΩ	± 0.87 kΩ	_____ kΩ	± 0.021 kΩ

¹ Test Result = Measured Value – Standard's Calibration Value

Functional Tests

Introduction

This section provides the test procedures used to verify that the 4263B performs its designed functions. The functional tests can be used for post repair function verification. The transformer measurement functional test is recommended to be performed during the 4263B performance testing. Record the transformer measurement functional test result in the test record at the end of this section.

Test Equipment

Table 9-1 lists the test equipment required to perform the tests described in this section. Equipment which equals or surpasses the key required specifications of the recommended equipment may be used.

4263B

Transformer Measurement Functional Test (Opt. 001 Only)

The 4263B's transformer measurement function is tested using a power splitter. The 4263B measures a transformer's turn ratio by stimulating a transformer and comparing the primary voltage to the secondary voltage. In this test, the 4263B stimulates the power splitter, instead of the transformer, and compares the two voltages across the power splitter.

Test Equipment

Description	Recommended Model
Transformer Test Fixture	16060A
30 cm BNC(m)-BNC(m) Cable	p/n 8120-1838, 3 ea.

Procedure

1. Reset the 4263B.
2. Set up the equipment as shown in Figure 9-9.

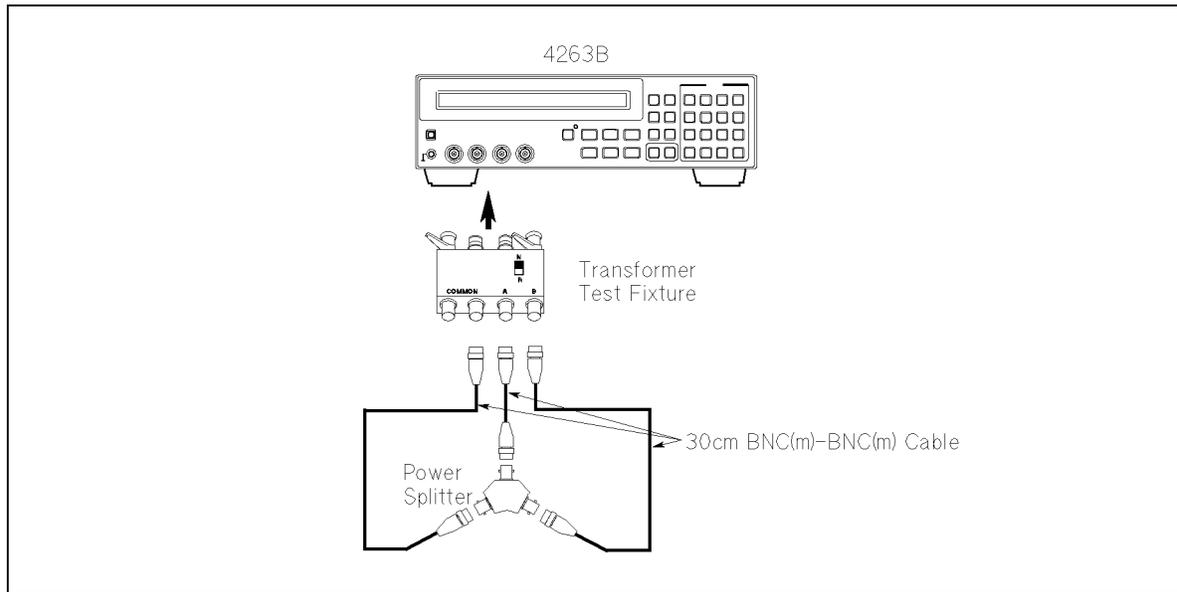

Figure 9-9. Transformer Measurement Functional Test Setup

3. Set the 4263B measurement conditions as follows:

Measurement Parameter:	L2-N
Measurement Time Mode:	LONG
Test Signal Level:	1 V (Default Setting)
Test Signal Frequency:	1 kHz (Default Setting)
Trigger Mode:	Man

4. Set the transformer test fixture's A:B switch to the 1:N position.

5. Press  to start the measurement.
6. Confirm that the N reading is within the limits listed in Table 9-18.
7. Perform this test for all settings listed in Table 9-18

Table 9-18. Transformer Measurement Test Limits

Switch Setting	Frequency Setting	Minimum Limit	Maximum Limit
1:N	1 kHz	1.980	2.020
1:N	100 kHz	1.970	2.030
N:1	1 kHz	0.985	1.015
N:N	100 kHz	0.980	1.020

4263B

Handler Interface Functional Test

The 4263B's handler interface function is tested using the built-in self-test and the handler interface tester.

Test Equipment

Description	Recommended Model
Handler Interface Tester	p/n 04339-65007

Procedure

Initial Setup.

1. Turn the 4263B OFF.
2. Set the LED_PW switch on the Handler Interface Tester to OFF, and set the IN1, IN2, IN3, and IN4 switches to 0.
3. Set up the equipment as shown in Figure 9-10

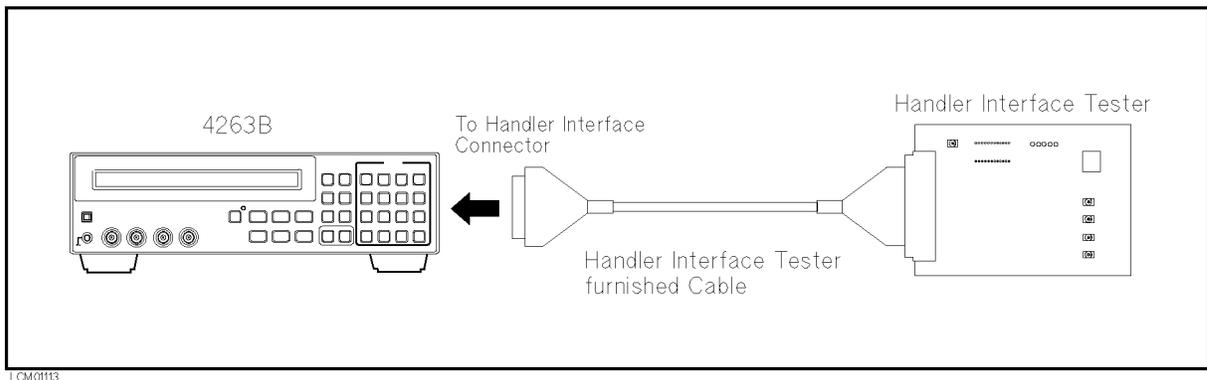

Figure 9-10. Handler Interface Functional Test Setup

4. Turn the 4263B ON.
5. Reset the 4263B.
6. Set the IN4 switch on the Handler Interface Tester to 1.
7. Confirm that the all keys on the 4263B's front panel are locked out.
8. Set the IN4 switch on the Handler Interface Tester to 0.

External Trigger Function Test.

9. Press  to set the trigger mode to External.
10. Press the IN5 switch on the Handler Interface Tester, and confirm that the 4263B is triggered.

Handler Interface Output Test.

11. Start the handler interface output test with the following procedure.

- a. Press   to display the configuration setting menu.
- b. Select SVC using  or , and press .
- c. Select HNDL using  or , and press .

12. Set the LED_PW switch on the Handler Interface Tester to ON.

Caution

Do not set the LED_PW switch to ON, except when doing the handler interface output test. The LEDs may cause the 4263B to shut-down during normal operation.

13. Confirm that the LEDs on the Handler Interface Tester light in the order shown in Figure 9-11, in accordance with the 4263B display.

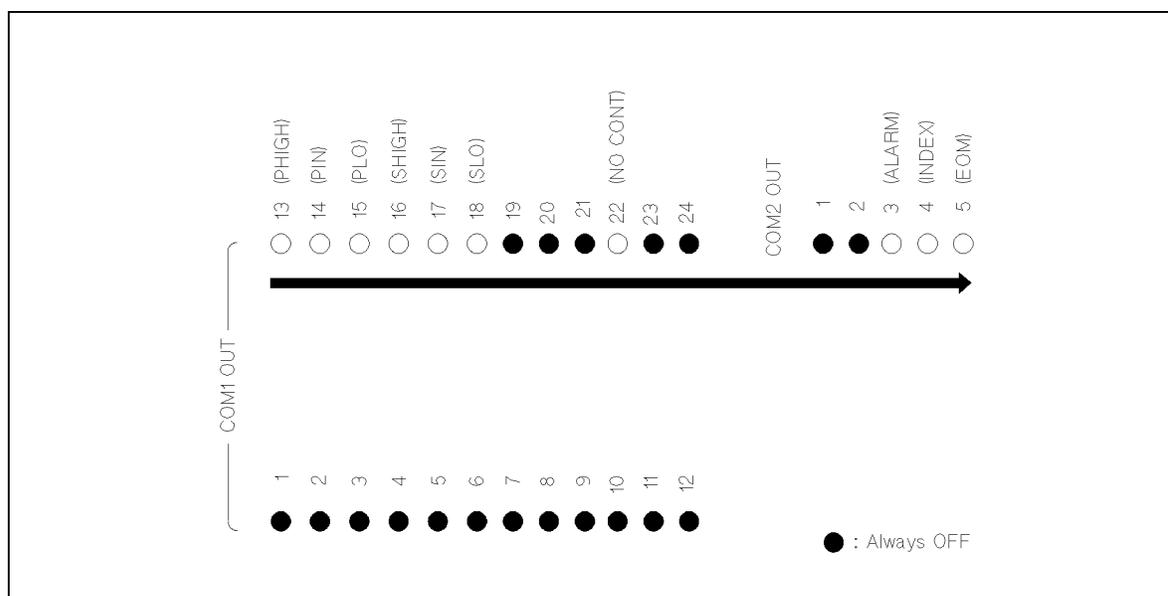

Figure 9-11. Handler interface Output Order

14. Set the LED_PW switch on the Handler Interface Tester to OFF.

15. Exit from the test mode by selecting **Exit**.

4263B

Contact Check Functional Test

The 4263B's contact check function is tested, by breaking contact at the Lpot terminal. When the 4263B measures impedance correctly, the contact check function for the other three terminals will operate correctly.

Test Equipment

Description	Recommended Model
10 k Ω Standard Resistor	42038A ^{1, 2}
OPEN Termination	42090A ²
Test Leads, 1 m	16048A
Adapter BNC(f)-BNC(f)	p/n 1250-0080, 4 ea.

1 Part of 42030A Standard Resistor Set

2 16074A can be used as a substitute

Procedure

1. Reset the 4263B.
2. Set the cable length to 1 m using the following procedure:
 - a. Press   to display the cable length setting menu.
 - b. Select 1 m using  or , and press .
3. Connect the OPEN termination to the 4263B's UNKNOWN terminals using the 1 m test leads and four BNC(f)-BNC(f) adapters.

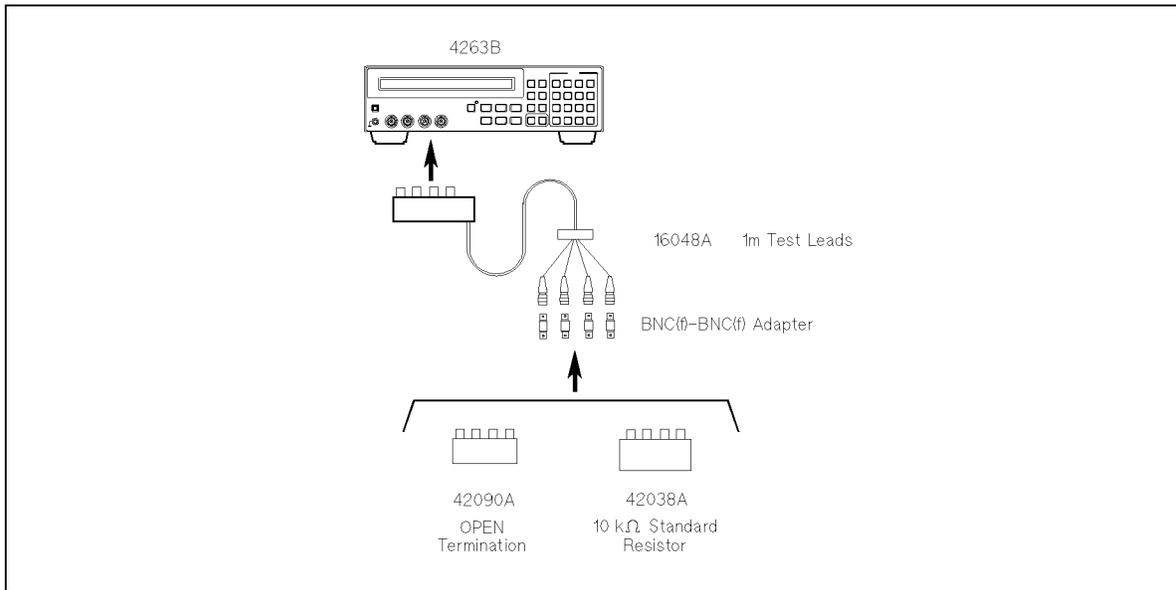

LCM01115

Figure 9-12. Contact Check Functional Test Setup

4. Press   to display the OPEN correction menu.

5. Select `OpenMeas` and press . The OPEN correction is performed.
6. Set the measurement parameter to R-X.
7. Connect the 10 k Ω standard resistor instead of the OPEN termination.
8. Press  to hold the measurement range.
9. Press   to activate the contact check function.
10. Confirm that the 4263B displays the measurement values.
11. Remove the test leads BNC connector from the Lpot terminal of the standard resistor.
12. Confirm that the 4263B displays N.C. (No Contact).

4263B

Functional Test Record

Agilent 4263B LCR Meter

Serial No.: _____

Date: _____

Temperature: _____

Tested by: _____

Humidity: _____

Transformer Measurement Functional Test (Opt. 001 Only)

Pass

Fail

[]

[]

Manual Changes

Introduction

This appendix contains the information required to adapt this manual to earlier versions or configurations of the 4263B than the current printing date of this manual. The information in this manual applies directly to an 4263B whose serial number prefix is listed on the title page of this manual.

Manual Changes

To adapt this manual to your 4263B, refer to Table A-1, and make all of the manual changes listed opposite your instrument's serial number.

Instruments manufactured after the printing of this manual may be different than those documented in this manual. Later instrument versions will be documented in a manual change supplement that will accompany the manual shipped with that instrument. If your instrument serial number is not listed on the title page of this manual or in Table A-1, it may be documented in a yellow *MANUAL CHANGES* supplement.

Besides change information, the manual change sheet also includes corrections to the operation manual. To always keep the operation manual correct, we recommend that you periodically request the manual change sheet from Agilent Technologies Japan, Ltd.

Table A-1. Manual Changes by Serial Number

Serial Prefix or Number	Make Manual Changes

Serial Number

Agilent Technologies uses a two-part, ten-character serial number that is stamped on the serial number plate (see Figure A-1). The first five characters are the serial prefix and the last five digits are the suffix.



Figure A-1. Serial Number Plate

Handler Interface Installation

Introduction

This appendix describes the electrical characteristics of each signal line of the handler interface.

Electrical Characteristics

Output Signals

Each DC output is isolated using open collector output opto-isolators. The output voltage of each line is enabled by putting pull-up resistors on the main board, and by connecting the pull-up resistors to an externally applied DC voltage.

The electrical circuits of the DC isolated outputs are divided into two groups to be able to separate power supplies (refer to Table B-1).

A simplified diagram of the output signals is shown in Figure B-1 for comparison signals and Figure B-2 for control signals.

Table B-1. Handler Output Electrical Characteristics

Output Signals	Voltage Output Rating		Maximum Current	External Voltage / Circuit Common
	Low	High		
Comparison Signals /PHI, /PIN, /PLO /SHI, /SIN, /SLO /NO CONTACT	≤ 0.5 V	5 V to 24 V	6 mA	EXT DCV1 COM1
Control Signals /ALARM /INDEX /EOM	≤ 0.5 V	5 V to 15 V	5 mA	EXT DCV2 COM2

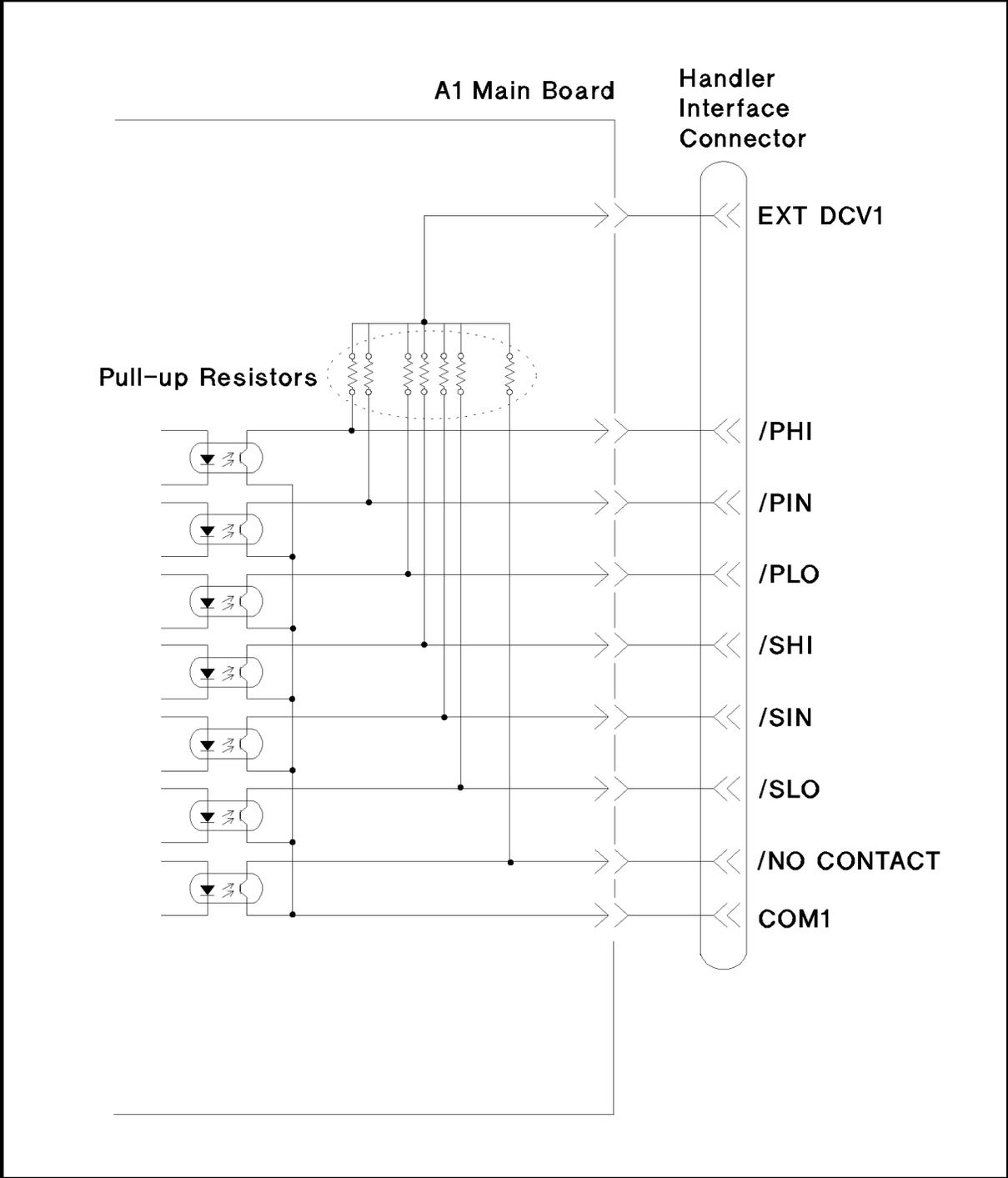

L700B001

Figure B-1. Handler Interface Comparison Output Signals Diagram

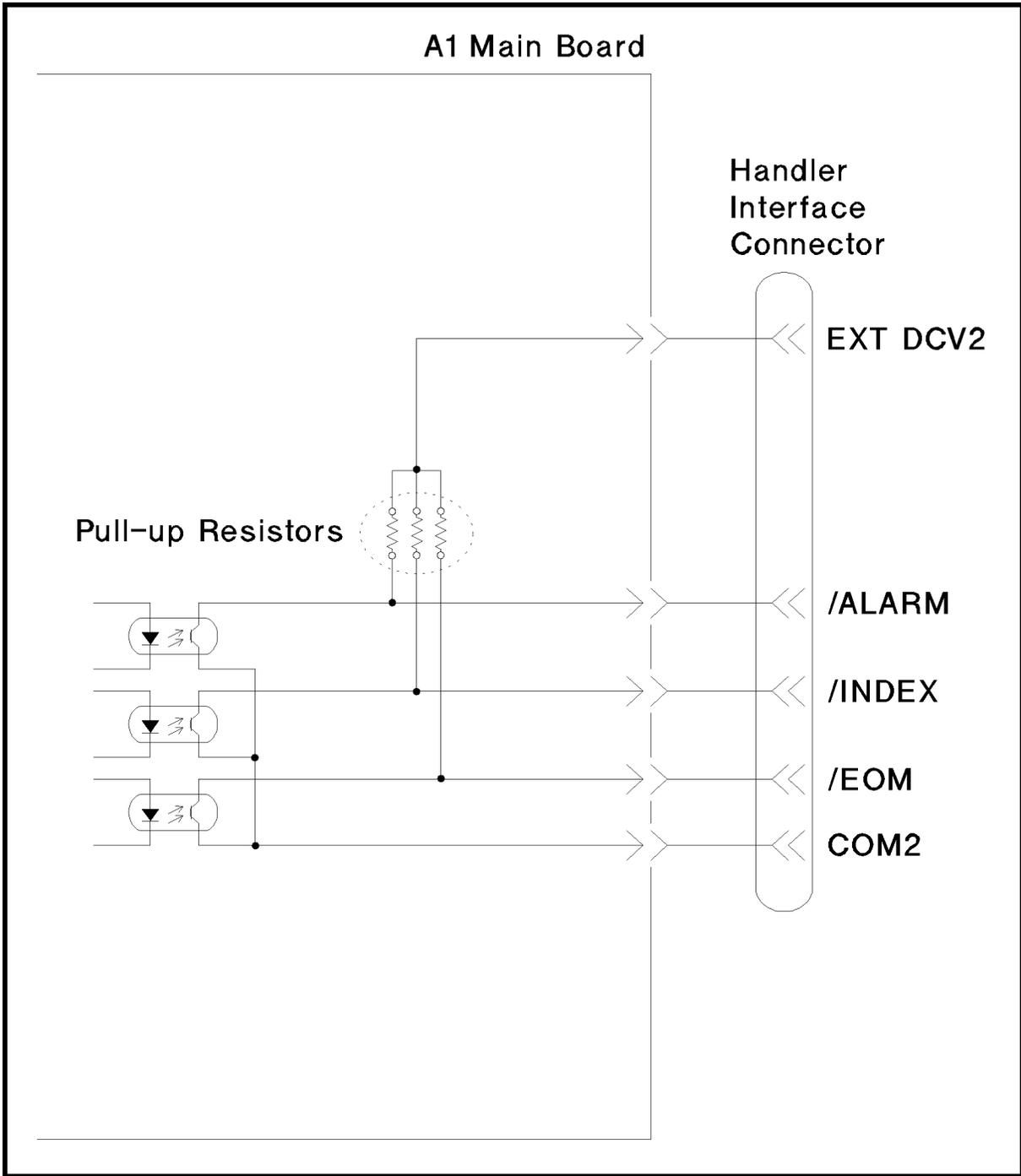

L600B003

Figure B-2. Handler Interface Control Output Signals Diagram

Input Signals

The DC isolated input signals are connected to the cathodes of the LEDs in the opto-isolators. The anodes of the LEDs are powered by an external voltage source (EXT DCV2). The OFF state voltage (high level) of the DC isolated input signals depends on the pull-up voltage powered by an external voltage source (EXT DCV2). (The input current is restricted by using a switch on the main board.)

The electrical characteristics of the input signals are listed in Table B-2. A diagram for the input signals is shown in Figure B-3.

Table B-2. Handler Interface Input Electrical Characteristics

Signal	Input Voltage		Input Current (Low)			Circuit Common
	Low	High	Pull-up Voltage			
			5 V	12 V	15 V	
/EXT TRIG	≤ 1 V	5 V to 15 V	8.7 mA	10.5 mA	13.5 mA	COM2
/KEY LOCK	≤ 1 V	5 V to 15 V	7.7 mA	10.8 mA	13.6 mA	COM2

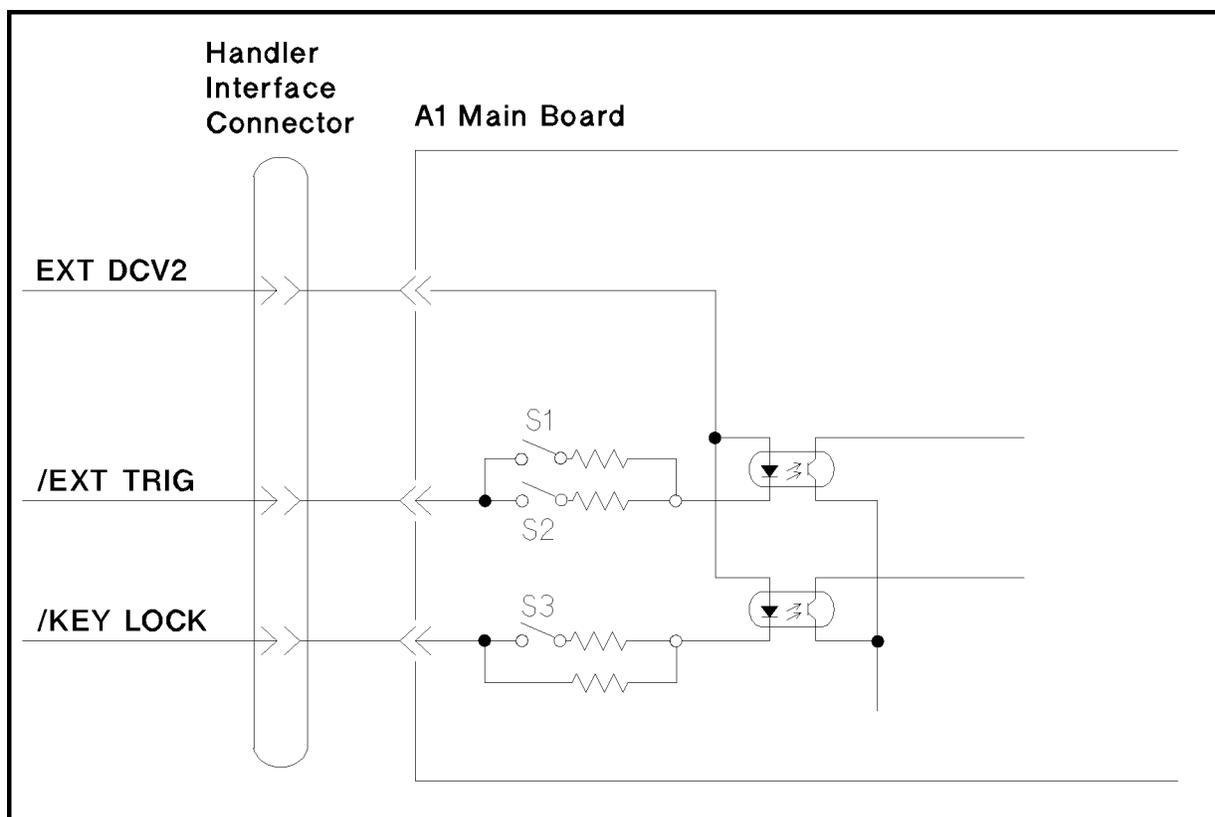

L600B002

Figure B-3. Handler Interface Input Signal Diagram

Handler Interface Board Setup

Before using the handler interface, connect the pull-up resistors to enable the output signals and set the dip switch to select the voltage level for the input signals.

Caution SUSCEPTIBLE TO DAMAGE FROM ESD.



Perform the following procedures only at a static-safe workstation and wear a grounding strap.

Tools and Fasteners

The 4263B mechanical components are secured using metric threaded fasteners. Many fasteners in the 4263B may appear to be Phillips type, but they are Pozidrive type fasteners. To avoid damaging them, use only Pozidrive screwdrivers to remove or tighten pozidrive type fasteners.

Procedure

1. Disconnect the power cable from the 4263B and allow enough time (10 minutes) for the internal capacitors to discharge.
-

Warning **Dangerous energy and voltage levels exist within the 4263B when it is in operation and just after it is powered down. Allow 10 minutes for the 4263B's internal capacitors to discharge before starting to work on it.**



2. Remove the two screws which fasten the cover to the chassis rear panel.
 3. Slide the cover toward the rear while holding the front panel bezel.
-

The following figure shows the location of the A1 main board and the A2 CPU board.

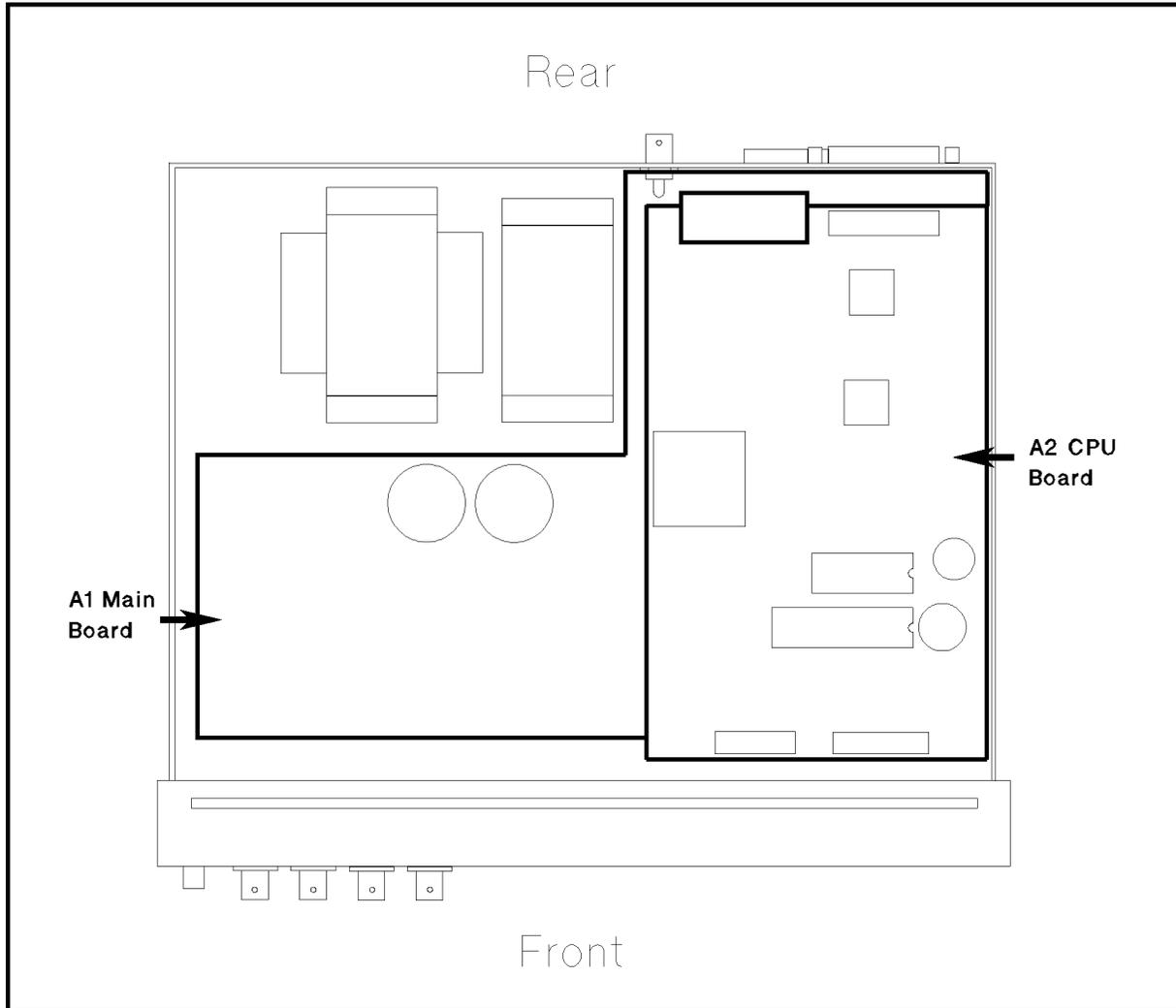

L700B005

4. Remove the A2 CPU board assembly.
 - a. Disconnect two flatcable assemblies from the front side of the A2 assembly.
 - b. Disconnect the flatcable assembly, which is connected to the GPIB connector on the rear panel, from the rear right side of the A2 assembly.
 - c. Remove the four screws that secure the A2 assembly to the stud.
 - d. Remove the flat cable assembly which is connected to the A1 main board assembly on the bottom, while sliding the A2 assembly toward front.
 - e. Remove the A2 assembly from the chassis.

4263B

5. Remove the A1 main board assembly.
 - a. Disconnect the following cable assemblies and wire assemblies from the A1 assembly.
 - i. The four cable assemblies marked “A”, “B”, “C”, and “D” which are connected to the UNKNOWN connectors on the Front Panel
 - ii. The wire assembly which is connected to the transformer
 - iii. The two wire assemblies which are connected to the DC-DC Converter
 - iv. The wire assembly which is connected to the Ext DC Bias terminal
 - b. Remove the nut which fasten the Ext Trigger terminal to the rear panel.
 - c. Remove the four studs, that secure the A1 assembly to the chassis, by rotating them with a flat bladed screwdriver.
 - d. Remove the three screws that secure the A1 assembly to the chassis.
 - e. Remove the A1 assembly from the chassis by sliding the assembly toward forward before lifting.

Figure B-4 shows the location of the socket to mount the pull-up resistors (J5) and the switch to select the voltage value of EXT DCV2. Table B-3 lists the socket numbers to mount the pull-up resistors for each control signals and comparison signals.

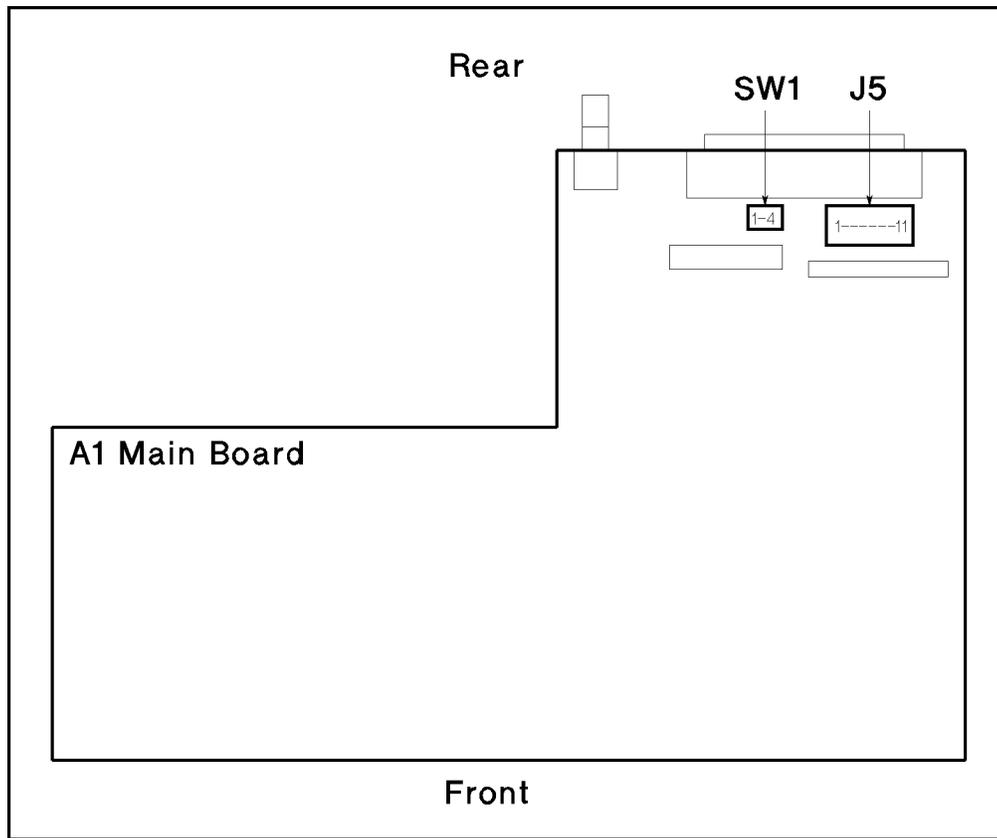

Figure B-4. A1 Main Board

Table B-3. Pull-up Resistor Location

Socket No.	Signal Name	Signal Type
J5-1	/EOM	Control Signal (5 V to 15 V)
J5-2	/INDEX	
J5-3	/PIN	Comparison Signal (5 V to 24 V)
J5-4	/PHI	
J5-5	/PLO	
J5-6	/SIN	
J5-7	/SHI	
J5-8	/SLO	
J5-9	/NO CONTACT	
J5-10	/ALARM	Control Signal (5 V to 15 V)
J5-11	Not used	

6. Mount the pull-up resistors for the comparison output signals. (Refer to Figure B-4 and Table B-3 for the location of the pull-up resistors for the comparison output signals.) Use the following equation to determine the value of the pull-up resistors (R).

$$R [k\Omega] \simeq V_p [V] / 3$$

where, V_p is the pull-up voltage.

The typical pull-up resistor values are:

Pull-up Voltage	Pull-up Resistor Agilent Part Number
5 V	0757-0278 (1.78 k Ω)
12 V	0757-0279 (3.16 k Ω)
24 V	0757-0441 (8.25 k Ω)

7. Mount the pull-up resistors for the control output signals. (Refer to Figure B-4 and Table B-3 for the location of the pull-up resistors for the control output signals.) Use the following equation to determine the value of the pull-up resistors (R).

$$R [k\Omega] \simeq V_p [V] / 2.5$$

where, V_p is the pull-up voltage.

The typical pull-up resistor values are:

Pull-up Voltage	Pull-up Resistor Agilent Part Number
5 V	0757-0278 (1.78 k Ω)
9 V	0757-0279 (3.16 k Ω)
12 V	0698-3154 (4.22 k Ω)
15 V	0757-0438 (5.11 k Ω)

4263B

8. Set SW1 according to the voltage value of EXT DCV2.

EXT DCV2	EXT TRIG		KEY LOCK
	SW1-1	SW1-2	SW1-3
5 V to 6 V	Close	Close	Close
6 V to 9 V	Close	Open	Close
9 V to 15 V	Open	Close	Open

9. Reinstall the A1 main board, the A2 CPU board, and the cover.

Overload/No-Contact Operations

Table C-1 shows the summary of operations, when the 4263B detects OVLD (Overload), or N.C. (No-Contact).

Table C-1. OVLD/N.C. Condition

	Display		Handler Output	GPIB Output ¹	Solutions
	Data Mode	Comprtr Mode			
OVLD (Overload)	OVLD	High ⁴	/PHI and /SHI	<State> ² :1 <Data> :9.9E37 <Comp> ³ :2	Select an appropriate measurement range.
		Low ⁴	/PLO and /SLO	<State> ² :1 <Data> :9.9E37 <Comp> ³ :4	
N.C. (No-Contact)	N.C.	N.C.	/NO CONTACT	<State> ² :2 <Data> :9.9E37 <Comp> ³ :8	Cancel the bad contact between the DUT and the contact-pin.

1. Refer to the :FETCh? Command in Chapter 5.
2. Measurement Status : (0 : Normal, 1 : Overload, 2 : No-Contact)
3. Comparison result : (1 : IN, 2 : HIGH, 4 : LOW, 8 : No-Contact)
4. Comparison display : Depends on the relation between the 4263B measurement range and the impedance of the DUT.

When the OVLD and N.C. are detected at the same time, Display, Handler output and GPIB output of the 4263B depend on the impedance value of the DUT, the selected measurement range and the connection between DUT and the contact-pin. The 4263B performs one of following cases in the Table C-2.

Table C-2. Simultaneous OVLD and N.C. Condition

Condition	Display		Handler Output	GPIB Output ¹	Solutions
	Data Mode	Comprtr Mode			
OVLD & N.C.	N.C.	N.C.	/NO CONTACT	<State> ² :2 <Data> :9.9E37 <Comp> ³ :8	Select an appropriate measurement range. Change to the appropriate signal level. Cancel the bad contact between the DUT and the contact-pin.
	OVLD	High	/PHI and /SHI	<State> ² :1 <Data> :9.9E37 <Comp> ³ :2	
		Low	/PLO and /SLO	<State> ² :1 <Data> :9.9E37 <Comp> ³ :4	

1. Refer to the :FETCh? Command in Chapter 5.
2. Measurement Status : (0 : Normal, 1 : Overload, 2 : No-Contact)
3. Comparison result : (1 : IN, 2 : HIGH, 4 : LOW, 8 : No-Contact)

Messages

This section lists the messages that are displayed on the 4263B's LCD display or transmitted by the instrument over GPIB in numerical order.

Instrument Errors

11 ADC FAILURE

The A/D conversion failed. The 4263B stops operation and the /ALARM signal on the handler interface . Contact your nearest Agilent Technologies office.

12 ROM TEST FAILED

Contact your nearest Agilent Technologies office.

13 RAM TEST FAILED

Contact your nearest Agilent Technologies office.

14 EEPROM R/W FAILEDx

Contact your nearest Agilent Technologies office.

15 USER DATA LOST

Correction data and instrument settings saved in EEPROM have been lost. Contact your nearest Agilent Technologies office.

16 PREV SETTING LOST

Instrument setting in the backup memory have been lost. The instrument keeps instrument settings in backup memory for 72 hours after being turned OFF.

17 SAVE FAILED

Contact your nearest Agilent Technologies office.

18 RECALL FAILED

No instrument settings saved in the EEPROM.

19 PRINTER NO RESPONSE

Check the following items.

- Check that the printer is turned on.
- Check that the GPIB cable is connected between the printer and the instrument.
- Check that the printer is set to "Listen Always."

20 A1 BD TEST FAILED

The A1 board failed. Contact your nearest Agilent Technologies office.

21 LOCKOUT BY HANDLER

Front panel key input is disabled by the handler. The front panel key input can not be enabled by the front panel keys or by GPIB commands when disabled by the handler.

4263B

31 OPT NOT INSTALLED

The :SENS:CONC command is received even though the 4263B is not equipped with Option 001 (Add N/M/DCR measurement function).

32 ILLEGAL MEAS FUNC

Illegal parameters combination for :SENS:FUNC command is received while the :SENS:FUNC:CONC is set to ON; For example, FIMP and VOLT:AC are illegal.

GPIB Errors

-100 Command error

This is a generic syntax error that the 4263B cannot detect more specific errors. This code indicates only that a command error, as defined in IEEE 488.2, 115.1.1.4, has occurred.

-101 Invalid character

A syntax element contains a character which is invalid for that type; for example, a header containing an ampersand, SENSE&

-102 Syntax error

An unrecognized command or data type was encountered; for example, a string was received when the 4263B was not expecting to receive a string.

-103 Invalid separator

The syntax analyzer was expecting a separator and encountered an illegal character; for example, the semicolon was omitted after a program message unit, *RST:TRIG.

-104 Data type error

The syntax analyzer recognized an unallowed data element; for example, numeric or string data was expected but block data was encountered.

-105 GET not allowed

A group Execute Trigger (GET) was received within a program message (see IEEE488.2,7.7).

-108 Parameter not allowed

More parameter were received than expected for the header; for example, the AVER command only accepts one parameter, so receiving AVER 2,4 is not allowed.

-109 Missing parameter

Fewer parameters were received than required for the header; for example, the AVER commands requires one parameter, so receiving AVER is not allowed.

-112 Program mnemonic too long

The header contains more than twelve characters (see IEEE 488.2,7.6.1.4.1).

-113 Undefined header

The header is syntactically correct, but it is undefined for the 4263B for example, *XYZ is not defined for the 4263B.

-121 Invalid character in number

An invalid character for the data type being parsed was encountered; for example, an alpha character in a decimal number or a "9" in octal data.

-123 numeric overflow

The magnitude of exponent was larger than 32000 (see IEEE488.2,7.7.2.4.1).

-124 Too many digits

The mantissa of a decimal numeric data element contains more than 255 digits excluding leading zeros (see IEEE 488.2,7.7.2.4.1)

-128 Numeric data not allowed

Legal numeric data element was received, but the 4263B does not accept it in this position for a header.

-131 Invalid suffix

The suffix does not follow the syntax described in IEEE 788.2,7.7.3.2, or the suffix is inappropriate for the 4263B.

-138 Suffix not allowed

A suffix was encountered after a numeric element which does not allow suffixes.

-140 Character data error

This error, as well as errors -141 through -148, are generated analyzing the syntax of a character data element. This particular error message is used if the 4263B cannot detect a more specific error.

-141 Invalid character data

Either the character data element contains an invalid character or the particular element received is not valid for the header.

-144 Character data too long

The character data element contains more than twelve characters (see IEEE 488.2, 7.7.1.4).

-148 Character data not allowed

A legal character data element was encountered that's prohibited by the 4263B.

-150 String data error

This error as well as errors -151 through -158, are generated when analyzing the syntax of a string data element. This particular error message is used if the 4263B cannot detect a more specific error.

4263B

-151 Invalid string data

A string data element was expected, but was invalid for some reason (see IEEE 488.2, 7.7.5.2); for example, an END message was received before the terminal quote character.

-158 String data not allowed

A string data element was encountered but was not allowed by the 4263B at this point in the syntax analysis process.

-160 Block data error

This error as well as errors -161 through -168, are generated when analyzing the syntax of a block data element. This particular error message is used if the 4263B cannot detect a more specific error.

-161 Invalid block data

A block data element was expected, but was invalid for some reason (see IEEE 488.2, 7.7.6.2); for example, an END message was received before the length was satisfied.

-168 Block data not allowed

A legal block data element was encountered but was not allowed by the 4263B at this point in the syntax analysis process.

-170 Expression error

This error as well as errors -171 through -178, are generated when analyzing the syntax of an expression data element. This particular error message is used if the 4263B cannot detect a more specific error.

-171 Invalid expression

The expression data element was invalid (see IEEE 488.2, 7.7.7.2); for example, unmatched parentheses or an illegal character.

-178 Expression data not allowed

A legal expression data was encountered but was not allowed by the 4263B at this point in the syntax analysis process.

-200 Execution error

This is the generic syntax error that the 4263B cannot detect more specific errors. This code indicates only that an execution error as defined in IEEE 488.2, 11.5.1.1.5 has occurred.

-211 Trigger ignored

A GET, *TRG, or triggering signal was received and recognized by the 4263B but was ignored because of 4263B timing considerations,\; for example, the 4263B was not ready to respond.

-213 Init ignored

A request for a measurement initiation was ignored as another measurement was already in progress.

-221 Setting conflict

A legal program data element was parsed but could not be executed due to the current device state (see IEEE 488.2, 6.4.5.3 and 11.5.1.1.5).

-222 Data out of range

A legal program data element was parsed but could not be executed because the interpreted value was outside the legal range as defined by the 4263B (see IEEE 488.2, 11.5.1.1.5).

-223 Too much data

A legal program data element of block, expression, or string type was received that contained more data than the 4263B could handle due to memory or related device-specific.

-230 Data corrupt or stale

Possibly invalid data; new reading started but not completed since access.

-241 Hardware missing

A legal program command or query could not be executed because of missing 4263B hardware; for example, an option was not installed.

-310 System error

Some error, termed "system error" by the 4263B, has occurred.

-311 Memory error

An error was detected in the 4263B's memory.

-313 Calibration memory lost

The nonvolatile calibration data has lost.

-350 Queue overflow

A specific code entered into the queue in lieu of the code that caused the error. This code indicates that there is no room in the queue and an error occurred but was not recorded.

-400 Query error

This is the generic query error that the 4263B cannot detect more specific errors. This code indicates only that a error as defined in IEEE 488.2, 11.5.1.1.7 and 6.3 has occurred.

-410 Query INTERRUPTED

A condition causing an interrupted error occurred (see IEEE 488.1, 6.3.2.3); for example, a query followed by DAB or GET before a response was completely sent.

-420 Query UNTERMINATED

A condition causing an unterminated query error occurred (see IEEE 488.2, 6.3.2); for example, the 4263B was addressed to talk and an incomplete program message was received.

4263B

-430 Query DEADLOCKED

A condition causing an deadlocked query error occurred (see IEEE 488.2, 6.3.1.7); for example, both input buffer and output buffer are full and the 4263B cannot continue.

-440 Query UNTERMINATED after indefinite response

A query was received in the same program message after an query requesting an indefinite response was executed (see IEEE 488.2, 6.5.7.5.7).

Index

Special characters

:, 5-4

;;, 5-4

0

0 m impedance measurement accuracy test,
9-11

1

1 m impedance measurement accuracy test,
9-18

2

2 m impedance measurement accuracy test,
9-22

4

4 m impedance measurement accuracy test,
9-26

A

:ABORt, 4-13, 5-9

ABORt Command , 5-9

accessory, 1-3

Address key, 3-10

Altitude

Operating, 8-10

Storage, 8-10

$\angle(\theta)$, 8-7

annunciator, 3-2

Arrow key , 3-11

ASCII , 5-22, 5-48

Auto/Hold key, 3-7

auto range, 3-7

Auto Range mode, 1-22

:AVERAge:COUNt, 4-10, 5-24

Average key, 3-5

:AVERAge[:STATe], 4-10, 5-24

averaging

specifications, 8-3

averaging rate, 3-5

GPIB command, 5-24

how to set, 2-1, 4-10

B

Back Space Key, 1-17, 3-12

Basic Operation, 1-18

beeper, 3-20

GPIB command , 5-12, 5-33

how to set, 2-3, 4-10

BUF1, 5-16

BUF2, 5-16

bus trigger mode, 3-9

C

cable extension, 7-9

Cable key, 3-18

cable length, 3-18

GPIB command, 5-15

how to match, 4-5

how to select, 1-23

cable length correction, 7-12

:CALCulate{1|2}:FORMat, 4-5, 5-11

:CALCulate{1|2}:LIMit:BEEPer

:CONDition, 4-10

:CALCulate{1|2}:LIMit:BEEPer:CONDition,
5-12

:CALCulate{1|2}:LIMit:BEEPer[:STATe],
4-10, 5-12

:CALCulate{1|2}:LIMit:CLEar, 4-10, 5-13

:CALCulate{1|2}:LIMit:FAIL?, 4-10, 5-13

:CALCulate{1|2}:LIMit:LOWer[:DATA],
4-10, 5-13

:CALCulate{1|2}:LIMit:LOWer:STATe,
4-10, 5-13

:CALCulate{1|2}:LIMit:STATe, 4-10, 5-13

:CALCulate{1|2}:LIMit:UPPer[:DATA],
4-10, 5-13

:CALCulate{1|2}:LIMit:UPPer:STATe,
4-10, 5-14

:CALCulate{1|2}:MATH:EXPRession
:CATalog?, 4-11, 5-14

:CALCulate{1|2}:MATH:EXPRession:NAME,
4-11, 5-14

:CALCulate{1|2}:MATH:STATe, 4-11, 5-14

:CALCulate{3|4}:MATH:STATe, 5-14

CALCulate subsystem, 5-10

calculation sheet, 9-30

Calculation Sheet, 9-3

:CALibration:CABLe, 4-5, 5-15

- Calibration Cycle, 9-4
- CALibration subsystem, 5-15
- capacitance measurement accuracy test
 - 0 m DC Bias:ON, 9-14
 - 0 m DC Bias:ON calculation sheet, 9-33
 - 0 m LONG, 9-11
 - 0 m LONG calculation sheet, 9-32
 - 0 m MED, 9-13
 - 0 m MED calculation sheet, 9-33
 - 0 m SHORT, 9-14
 - 0 m SHORT calculation sheet, 9-33
 - 1 m, 9-18
 - 1 m calculation sheet, 9-35
 - 2 m , 9-22
 - 2 m calculation sheet, 9-36
 - 4 m, 9-26
 - 4 m calculation sheet, 9-37
- capacitance to ground, 7-8
- characteristics example, 7-2
- Chassis Terminal, 3-3
- circuit mode, 7-3
- cleaning , 1-9
- *CLS, 5-36
- colon, 5-4
- Command Error Bit , 5-41
- command reference
 - notations, 5-8
- common commands, 5-1
 - syntax, 5-5
- comparator
 - GPIB command, 5-13
 - how to use, 2-5, 4-10
 - on/off, 3-16
- Comparator Function, 8-9
- Comparator key, 3-16
- Comparator Limit Keys, 3-11
- Configuration key, 3-20
- contact check, 3-17, 7-11
 - GPIB command, 5-26
 - how to perform, 4-10
 - how to set, 2-2
- Contact Check Function, 8-9
- contact check functional test, 9-51
- Contact Check key, 3-17
- contact resistance, 7-9
- Continuous Memory Capability, 8-9
- Controller , 3-26
 - :CORRection:CKIT:STANdard3, 4-8, 5-25
 - :CORRection:COLLect[:ACQuire], 4-8, 5-25
 - :CORRection:COLLect:METHod, 4-8, 5-26
 - :CORRection:DATA? SENSE, 5-26
- correction function, 4-8, 7-12
- Correction Function, 8-9

- :CORRection[:STATe], 4-8, 5-26
- Current Instrument Settings
 - how to get, 4-12

D

- D accuracy, 8-7
- :DATA, 4-11
- data buffer, 4-25, 5-16
 - :DATA[:DATA], 5-16
 - :DATA[:DATA]?, 4-25, 5-17
 - :DATA[:DATA]? {IMON|VMON}, 5-17
 - :DATA:FEED, 4-25, 5-18
 - :DATA:FEED:CONTroL, 4-25, 5-18
 - <data_handle>, 5-18
 - :DATA:POINts, 4-25, 5-18
- DATA subsystem, 5-16
- data transfer format, 5-48
 - ASCII , 5-48
 - REAL , 5-49
- DC bias
 - GPIB command, 5-29, 5-30
 - how to apply, 2-4, 4-8
 - on/off, 2-5, 3-4
 - source, 3-7
- DC Bias key, 3-4
- DC bias level accuracy test, 9-9
- DC Bias Settling Time, 8-16
- DC Bias Setup key, 3-7
- DC resistance measurement accuracy test
 - 0 m Opt. 001 Only, 9-17
 - 0 m Opt. 001 Only calculation sheet, 9-34
 - 1 m calculation sheet, 9-35
 - 1 m Opt. 001 Only, 9-21
 - 2 m calculation sheet, 9-36
 - 2 m Opt. 001 Only, 9-25
 - 4 m calculation sheet, 9-37
 - 4 m Opt. 001 Only, 9-29
- Delay key, 3-9
- deviation display mode
 - how to select, 2-7
- deviation measurement, 3-5, 4-11
 - GPIB command, 5-14
 - how to display, 2-6
- Deviation (Δ) Mode key, 3-5
- Dimensions, 8-10
- Direct Execution Type Keys, 1-14
- Display, 1-7, 3-2, 8-9
- Display Digit, 2-9
- display mode, 3-6
 - GPIB command, 5-19
- Display Mode, 2-9
- Display Mode key, 3-6
- DISPlay subsystem, 5-19
 - :DISPlay[:WINDow] [:STATe], 5-19
 - :DISPlay[:WINDow]:TEXT1:DIGit, 5-19

:DISPlay[:WINDow]:TEXT1:PAGE, 5-19
:DISPlay[:WINDow]:TEXT2:PAGE, 5-20
Down/Left Arrow Keys, 1-16
DUT characteristics, 7-2

E

electrolytic capacitor measurement, 6-1
EMC, 8-10
Engineering Units key, 3-11
Enter Key, 3-11
*ESE , 4-26, 5-36
*ESE? , 5-36
*ESR? , 4-26, 5-36
external DC bias
 specifications, 8-2
External DC bias Terminal, 3-22
external trigger mode, 2-4, 3-9
External Trigger Terminal , 3-21

F

:FETCh?, 4-13, 5-21
FETCh? query, 5-21
:FIMPedance:APERture, 4-9, 5-26
:FIMPedance:CONTact:VERify, 4-10, 5-26
:FIMPedance:RANGe:AUTO, 4-7, 5-26
:FIMPedance:RANGe[:UPPer], 4-7, 5-27
FORMat Subsystem, 5-22
four-terminal pair configuration, 7-6
Frequency key, 3-6
Front-end Protection, 8-17
Front Panel, 1-4, 3-2
Front-Panel Keys, 1-14
functional test record, 9-53
Functional Tests, 9-46
:FUNctIon:CONCurent, 4-5, 5-27
:FUNctIon:COUNt?, 5-27
:FUNctIon[:ON], 4-5, 5-27
Fuse, 1-12

G

G accuracy, 8-7
GET, 4-13
Getting Data from the 4263B, 4-3
GPIB address, 3-10
 how to set, 2-10
GPIB Address
 how to read, 4-2
GPIB Interface, 3-26, 8-9
group execution trigger, 4-13
guarding, 7-10

H

handler interface, 3-23
 board setup, B-5
 electrical characteristics, B-1
 installation, B-1
 pin assignment, 3-23
 specification, 3-23
Handler Interface, 8-9
handler interface functional test, 9-49
Hold Range mode, 1-22
Humidity
 Operating, 8-10
 Storage, 8-10

I

IDLE State, 5-46
*IDN? , 5-36
incoming inspection , 1-9
:INITiate:CONTinuous, 4-13
:INITiate[:IMMediate], 4-13
Initiate State, 5-47
INITiate subsystem, 5-23
Input Statements, 4-2
Instrument Settings
 how to save and recall, 4-12
internal DC bias accuracy
 specifications, 8-2
internal DC bias level
 specifications, 8-2
internal trigger mode, 2-4, 3-9

K

key lock, 2-9, 4-10
 GPIB command , 5-33
Key Lock, 8-9
Key Lock key, 3-18

L

L2, M, R2, N measurement accuracy, 8-12
L2, M, R2 N measurement range, 8-12
Left/Down Arrow key , 3-11
Level key , 3-7
level monitor, 3-6
 GPIB command, 5-14, 5-17
 how to set, 2-3
level monitor accuracy, 8-11
LINE Fuse Holder, 3-22
LINE Switch, 3-3
LINE Voltage Selector, 3-22
Listener , 3-26
LOAD correction, 3-15
 GPIB command, 5-25
 how to perform, 1-26, 4-9
Load key , 3-15
Local key, 3-9

local mode, 2-10

Local Mode

how to return, 4-3

*LRN?, 4-12, 5-36

M

manual changes, A-1

manual trigger mode, 2-4, 3-9

Mathematical Functions, 8-9

Maximum DC Bias Current, 8-16

Maximum Key, 3-12

Maximum Keys, 1-16

measurement accuracy, 8-11

specifications, 8-3

measurement accuracy parameter, 8-4

Measurement Configuration, 2-1

measurement contacts, 7-7

measurement parameter

 GPIB command, 5-11

 how to select, 1-21, 4-5

Measurement Parameter key , 3-4

Measurement Parameters, 8-2

measurement range, 3-8

 GPIB command, 5-27

 how to select, 1-22, 4-7

 specifications, 8-3

Measurement Settings

 GPIB command, 5-20

 how to change, 2-8

Measurement Settings , 1-7

Measurement Settings Display key , 3-6

Measurement Time key, 3-5

measurement time mode, 3-5

 GPIB command, 5-26

 how to select, 2-1, 4-9

 specifications, 8-3

message terminators, 5-5

Minimum Key, 3-12

Minimum Keys, 1-16

Mmeasurement time, 8-15

multiple messages, 5-7

N

numeric keys, 3-11

Numeric Keys, 1-15

O

*OPC, 4-11, 5-36

*OPC?, 5-36

OPEN correction, 3-13

 GPIB command, 5-25

 how to perform, 1-24, 4-9

Open key, 3-13

OPEN/SHORT correction, 7-12

OPEN/SHORT/LOAD correction, 7-12

Operation, 1-18

Operation Complete Bit , 5-41

operation status event register, 5-44

operation status register, 5-44

*OPT?, 5-36

option, 1-3

Output Statements, 4-2

OVL D , 3-8

P

parallel circuit mode, 7-3

parameters, 5-5

 <Boolean>, 5-6

 <data_handle>, 5-6

 <numeric_value>, 5-6

 <sensor_function>, 5-6

 types, 5-6

performance test record, 9-4, 9-38

Performance Tests, 9-3

power cable , 1-10

Power Consumption, 1-12

Power Cord Receptacle, 3-22

power line frequency, 3-20

 how to set, 1-13, 4-5

Power Line Frequency, 1-12

Power Line Voltage, 1-12

Power Requirements, 1-12, 8-10

program message terminators, 5-5

Q

Q accuracy, 8-7

query

 syntax, 5-7

Query Commands, 4-3

Query Error Bit , 5-41

Questionable Status Register, 5-44

R

Range Setup key, 3-8

ranging

 specifications, 8-3

*RCL, 4-12

*RCL<numeric_value>, 5-36

REAL , 5-22, 5-49

Rear Panel, 1-8, 3-21

recall

 instrument settings, 2-10

Recall Key, 3-10

recommended equipment, 9-2

REF1, 5-16

REF2, 5-16

Remote Command

 how to send, 4-2

reset, 3-19

 GPIB command , 5-33

- how to, 1-20, 4-5
- Reset key, 3-19
- resistance measurement accuracy test
 - 0 m LONG, 9-15
 - 0 m LONG calculation sheet, 9-33
 - 0 m MED, 9-16
 - 0 m MED calculation sheet, 9-33
 - 0 m SHORT, 9-16
 - 0 m SHORT calculation sheet, 9-34
 - 1 m, 9-20
 - 1 m calculation sheet, 9-35
 - 2 m, 9-24
 - 2 m calculation sheet, 9-36
 - 4 m, 9-28
 - 4 m calculation sheet, 9-37
- response message
 - syntax, 5-7
- Rp Accuracy, 8-8
- Rs Accuracy, 8-7
- *RST, 4-5, 5-37

S

- *SAV, 4-12, 5-37
- save
 - instrument settings, 2-10
- Save Key , 3-10
- Save/Recall, 8-9
- Selection Type Keys, 1-14
- self-test, 3-20
 - GPIB command , 5-37
 - how to perform, 2-12
- self test, 4-26
- semicolon, 5-4
- [:SENSe]:AVERage:COUNT, 4-10, 5-24
- [:SENSe]:AVERage[:STATe], 4-10, 5-24
- [:SENSe]:CORRection:CKIT:STANdard3, 4-8, 5-25
- [:SENSe]:CORRection:COLLect[:ACQuire], 4-8, 5-25
- [:SENSe]:CORRection:COLLect:METhod, 4-8, 5-26
- [:SENSe]:CORRection:DATA?, 5-26
- [:SENSe]:CORRection[:STATe], 4-8, 5-26
- [:SENSe]:FIMPedance:APERture, 4-9, 5-26
- [:SENSe]:FIMPedance:CONtact:VERify, 4-10, 5-26
- [:SENSe]:FIMPedance:RANGe:AUTO, 4-7, 5-26
- [:SENSe]:FIMPedance:RANGe[:UPPER], 4-7, 5-27
- [:SENSe]:FUNction:CONCurrenT, 4-5, 5-27
- [:SENSe]:FUNction:COUNT?, 5-27
- [:SENSe]:FUNction[:ON], 4-5, 5-27
- SENSe subsystem, 5-24
- <sensor_function>, 5-27

- sequence operation state, 5-47
- Serial Number Plate, 3-22
- series circuit mode, 7-3
- Service Request (SRQ) , 5-39
- set up
 - how to, 4-5
- shielding, 7-10
- Shift Key, 3-11
- SHORT correction, 3-14
 - GPIB command, 5-25
 - how to perform, 1-25, 4-9
- Short key, 3-14
- :SOURce:FREQuency[:CW], 4-7, 5-29
- SOURce subsystem, 5-29
- :SOURce:VOLTagE[:LEVEl]
 - [:IMMediate][:AMPLitude], 4-7, 5-29
 - [:IMMediate]:OFFSet, 4-8, 5-29
 - [:IMMediate]:OFFSet:SOURce, 4-8, 5-29
 - [:IMMediate]:OFFSet:STATe, 4-8, 5-30
- specifications, 8-2
- SPOLL , 4-26
- *SRE, 5-37
- *SRE?, 5-37
- standard, 7-14
- Standard Event Status Register , 5-41
- Standard Operation Status Group, 5-42
- Standards' Calibration Values, 9-31
- Status Byte Register, 5-40
- :STATus:OPERation:CONDition?, 4-26, 5-31
- :STATus:OPERation:ENABle, 4-26, 5-31
- :STATus:OPERation[:EVENT]?, 4-26, 5-31
- :STATus:PRESet, 4-26, 5-31
- :STATus:QUEStionable:CONDition?, 4-26, 5-31
- :STATus:QUEStionable:ENABle, 4-26, 5-31
- :STATus:QUEStionable[:EVENT]?, 4-26, 5-31
- Status Reporting Structure, 5-39
- STATus Subsystem , 5-31
- *STB?, 5-37
- stray capacitance, 7-10
- subsystem commands, 5-2
 - syntax, 5-5
- supplemental performance characteristics, 8-11
- :SYSTem:BEEPer[:IMMediate], 4-10, 5-33
- :SYSTem:BEEPer:STATe, 4-10, 5-33
- :SYSTem:ERRor?, 5-33
- :SYSTem:KLOCk, 4-10, 5-33
- :SYSTem:LFRequency, 4-5, 5-33
- :SYSTem:PRESet, 4-5, 5-33
- SYSTem Subsystem , 5-33
- :SYSTem:VERSion? , 5-34

T

- Talker , 3-26
- talk only mode, 2-11, 3-10
- Temperature
 - Operating, 8-10
 - Storage, 8-10
- test cable configuration, 7-6
- test cable lengths
 - specifications, 8-3
- test current transient, 3-33
- test equipment, 9-2
- test fixture, 1-3
 - how to connect, 1-19
- test leads, 1-3
 - configuration, 7-6
 - extension, 7-9
- test signal
 - specifications, 8-2
- test signal accuracy, 8-11
 - specifications, 8-2
- test signal frequency, 3-6
 - GPIB command, 5-29
 - how to select, 1-22, 4-7
 - specifications, 8-2
- test signal frequency accuracy
 - specifications, 8-2
- test signal frequency accuracy test, 9-5
 - calculation sheet, 9-30
- test signal level, 3-7
 - GPIB command, 5-29
 - how to select, 4-7
 - how to set, 1-23
 - specifications, 8-2
- test signal level accuracy test, 9-7
 - calculation sheet, 9-30
- test signal output impedance, 8-11

- Toggle Type Keys, 1-14
- transformer measurement, 6-6
- transformer measurement functional test, 9-47
- *TRG, 4-13, 5-37
- trigger
 - how to, 2-4
 - how to trigger, 4-13
- TRIGGER , 4-13
- :TRIGger:DELAy, 4-10, 5-35
- trigger delay time, 3-9
 - how to set, 2-2, 4-10
 - specifications, 8-3
- Trigger Event Detection State, 5-47
- :TRIGger[:IMMediate], 4-13, 5-35
- Trigger key, 3-8
- trigger mode, 3-9
 - specifications, 8-3
- Trigger Mode key, 3-9
- :TRIGger:SOURce, 4-13, 5-35
- TRIGger subsystem , 5-35
- Trigger System, 5-46
- *TST?, 5-37
- Turning On, 1-13

U

- Units, 5-6
- UNKNOWN terminals, 3-3
- Up/Right Arrow key , 3-11
- Up/Right Arrow Keys, 1-16

V

- Value Setup Type Keys, 1-15

W

- *WAI, 4-11, 5-38
- Weight, 8-10

REGIONAL SALES AND SUPPORT OFFICES

For more information about Agilent Technologies test and measurement products, applications, services, and for a current sales office listing, visit our web site: <http://www.agilent.com/find/tmdir>. You can also contact one of the following centers and ask for a test and measurement sales representative. 11/29/99

United States:

Agilent Technologies
Test and Measurement Call Center
P.O.Box 4026
Englewood, CO 80155-4026
(tel) 1 800 452 4844

(fax) (61 3) 9272 0749
(tel) 0 800 738 378 (New Zealand)
(fax) (64 4) 802 6881

Canada:

Agilent Technologies Canada Inc.
5150 Spectrum Way
Mississauga, Ontario
L4W 5G1
(tel) 1 877 894 4414

Asia Pacific:

Agilent Technologies
24/F, Cityplaza One, 1111 King's Road,
Taikoo Shing, Hong Kong
(tel) (852)-3197-7777
(fax) (852)-2506-9284

Europe:

Agilent Technologies
Test & Measurement
European Marketing Organization
P.O.Box 999
1180 AZ Amstelveen
The Netherlands
(tel) (31 20) 547 9999

Japan:

Agilent Technologies Japan Ltd.
Call Center
9-1, Takakura-Cho, Hachioji-Shi,
Tokyo 192-8510, Japan
(tel) (81) 426 56 7832
(fax) (81) 426 56 7840

Latin America:

Agilent Technologies
Latin American Region Headquarters
5200 Blue Lagoon Drive, Suite #950
Miami, Florida 33126
U.S.A.
(tel) (305) 267 4245
(fax) (305) 267 4286

Australia/New Zealand:

Agilent Technologies Australia Pty Ltd
347 Burwood Highway
Forest Hill, Victoria 3131
(tel) 1-800 629 485 (Australia)