

Agilent 35670A Installation & Verification Guide

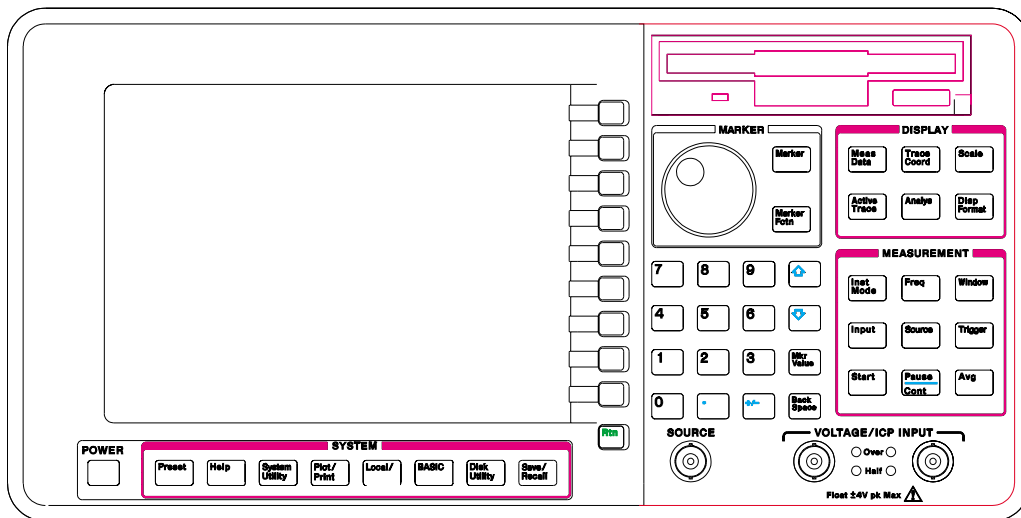

Agilent Technologies

Agilent Part Number 35670-90065

For instruments with firmware version A.00.00

Printed in Malaysia

Print Date: March 2001

Copyright © Agilent Technologies, Inc. 1992, 1994, 2000, 2001.

All rights reserved.

8600 Soper Hill Road Everett, Washington 98205-1209 U.S.A.

The Agilent 35670A at a Glance (Front Panel)

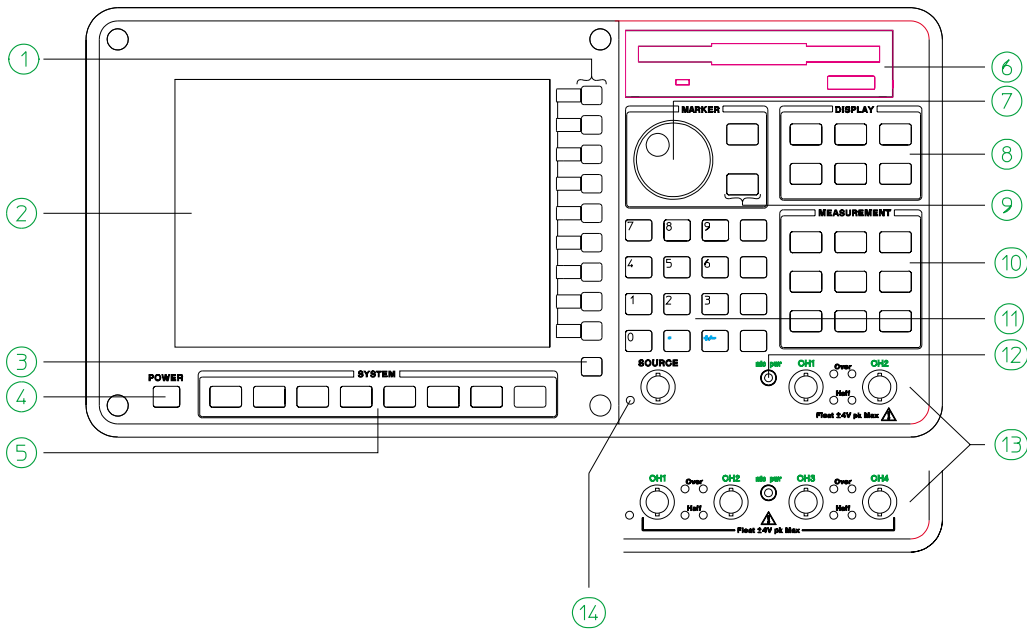

Agilent 35670A Front Panel

1-Use the softkeys to select items from the current menu. A softkey's function is indicated by a video label on the analyzer's screen. Throughout this book, softkeys are printed like this: [FFT ANALYSIS].

Hardkeys are front-panel buttons whose functions are always the same. They have a label printed directly on the key itself. Throughout this book, hardkeys are printed like this: [Inst Mode].

2-The analyzer's screen is divided into the menu area and the display area. The menu area displays video labels for the softkeys. The data area displays measurement data and information about the parameter settings.

3-The [Rtn] key returns the menu to the previous level.

4 -The POWER switch turns on the analyzer.

5 -Use the SYSTEM keys to control various system-level functions. These functions include saving files, plotting measurement data, and accessing online help.

6 -Use the disk drive to save your work on 3.5 inch flexible disks.

7-The knob moves the markers and the cursor. It also steps through numeric values and scrolls through online help.

8 -Use the DISPLAY keys to control what appears on the analyzer's traces. They only affect how data is displayed; DISPLAY keys do not change measurement parameters. *You can press keys in the DISPLAY menus without losing measurement parameters.*

9 -Use the MARKER keys to select a variety of marker features.

10-Use the MEASUREMENT keys to control the analyzer's source and inputs. They also control measurement parameters. *You must make a new measurement if you change a MEASUREMENT parameter.*

11-Use the numeric-entry keys to enter a numeric value.

12-The microphone power connector provides power (8 Vdc) for the Microphone Adapter Kit (Option UK4).

13-The connector area of the front panel has two different configurations. The standard analyzer has a source output connector and two input connectors. The 4-channel analyzer (Option AY6) has four input connectors.

Range indicators are located next to each input connector. The upper LED is the over-range indicator (the signal level exceeds the current range setting). The lower LED is the half range indicator (the signal level exceeds half the current range setting).

14-A source on/off indicator is located at the left edge of the connector area.

The standard Agilent 35670A (2-channel) has a source connector on the front panel.

The Agilent 35670A at a Glance (Rear Panel)

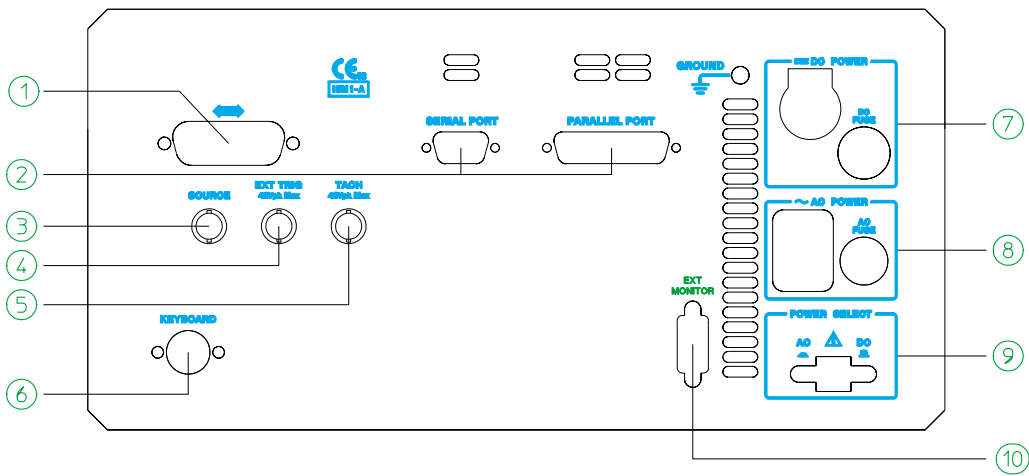

Agilent 35670A Rear Panel

1-The GPIB connector links the Agilent 35670A to other GPIB devices. GPIB parameters are set in the [**Local/GPIB**] and [**Plot/Print**] menus.

2-The SERIAL PORT and the PARALLEL PORT link the analyzer to plotters and printers. These parameters are set in the [**Plot/Print**] menu.

3-The SOURCE connector outputs the analyzer's source signal. An LED on the front panel indicates if the source is on or off. The source parameters are set in the [Source] menu.

The standard Agilent 35670A (2-channel) also has a source connector on the front panel.

4-The EXT TRIG connector links the analyzer to an external trigger signal. The external trigger parameters are set in the [**Trigger**] menu.

5-The TACH connector links the analyzer to a tachometer. The tachometer parameters are set in the [Input] menu.

6-The KEYBOARD connector attaches an optional keyboard to the analyzer.

7-The DC POWER connector accepts DC power levels from 12 - 28 Vdc (nominal).

8-The AC POWER connector accept a wide range of ac voltage levels.

9-The POWER SELECT switch determines whether the analyzer is powered via the AC POWER connector or the DC POWER connector.

10-The EXT MONITOR port links the analyzer to multi-sync monitors.

Safety Summary

The following general safety precautions must be observed during all phases of operation of this instrument. Failure to comply with these precautions or with specific warnings elsewhere in this manual violates safety standards of design, manufacture, and intended use of the instrument. Agilent Technologies, Inc. assumes no liability for the customer's failure to comply with these requirements.

GENERAL

This product is a Safety Class 1 instrument (provided with a protective earth terminal). The protective features of this product may be impaired if it is used in a manner not specified in the operation instructions.

All Light Emitting Diodes (LEDs) used in this product are Class 1 LEDs as per IEC 60825-1.

ENVIRONMENTAL CONDITIONS

This instrument is intended for indoor use in an installation category II, pollution degree 2 environment. It is designed to operate at a maximum relative humidity of 95% and at altitudes of up to 2000 meters. Refer to the specifications tables for the ac mains voltage requirements and ambient operating temperature range.

BEFORE APPLYING POWER

Verify that the product is set to match the available line voltage, the correct fuse is installed, and all safety precautions are taken. Note the instrument's external markings described under Safety Symbols.

GROUND THE INSTRUMENT

To minimize shock hazard, the instrument chassis and cover must be connected to an electrical protective earth ground. The instrument must be connected to the ac power mains through a grounded power cable, with the ground wire firmly connected to an electrical ground (safety ground) at the power outlet. Any interruption of the protective (grounding) conductor or disconnection of the protective earth terminal will cause a potential shock hazard that could result in personal injury.

FUSES

Only fuses with the required rated current, voltage, and specified type (normal blow, time delay, etc.) should be used. Do not use repaired fuses or short-circuited fuse holders. To do so could cause a shock or fire hazard.

DO NOT OPERATE IN AN EXPLOSIVE ATMOSPHERE

Do not operate the instrument in the presence of flammable gases or fumes.

DO NOT REMOVE THE INSTRUMENT COVER

Operating personnel must not remove instrument covers. Component replacement and internal adjustments must be made only by qualified service personnel.

Instruments that appear damaged or defective should be made inoperative and secured against unintended operation until they can be repaired by qualified service personnel.

WARNING

The WARNING sign denotes a hazard. It calls attention to a procedure, practice, or the like, which, if not correctly performed or adhered to, could result in personal injury. Do not proceed beyond a WARNING sign until the indicated conditions are fully understood and met.

Caution

The CAUTION sign denotes a hazard. It calls attention to an operating procedure, or the like, which, if not correctly performed or adhered to, could result in damage to or destruction of part or all of the product. Do not proceed beyond a CAUTION sign until the indicated conditions are fully understood and met.

Safety Symbols



Warning, risk of electric shock



Caution, refer to accompanying documents



Alternating current



Both direct and alternating current



Earth (ground) terminal



Protective earth (ground) terminal



Frame or chassis terminal



Terminal is at earth potential.



Standby (supply). Units with this symbol are not completely disconnected from ac mains when this switch is off

Options and Accessories

The accessories listed in the following table are supplied with the Agilent 35670A.

Supplied Accessories	Part Number
Line Power Cable	See page 2-4
Standard Data Format Utilities	HP 5061-8042
<i>Agilent 35670A Operator's Guide</i>	Agilent 35670-90053
<i>Agilent 35670A Quick Start</i>	Agilent 35670-90056
<i>Agilent 35670A Installation and Verification Guide</i>	Agilent 35670-90054
<i>Agilent 35670A GPIB Command Reference</i>	Agilent 35670-90057
<i>GPIB Programmer's Guide</i>	Agilent 5960-5708
<i>Agilent 35670A GPIB Commands: Quick Reference</i>	Agilent 35670-90048

The accessories listed in the following table are available for the Agilent 35670A.

Available Accessories	Part Number
DC Power Cable, 3 meter	HP 35250A
DC Power Cable with Cigarette Lighter Adapter	HP 35251A
Box of ten 3.5-inch double-sided, double-density disks	HP 92192A
<i>Using Instrument Basic with the Agilent 35670A</i>	Agilent 35670-90049
<i>Instrument Basic User's Handbook</i>	HP E2083-90000
HP Thinkjet Printer	HP 2225A
HP Quietjet Printer	HP 2227A
HP Jet Paper, 2500 sheets	HP 92261N
GPIB Cable, 1 meter	HP 10833A
GPIB Cable, 2 meter	HP 10833B
GPIB Cable, 4 meter	HP 10833C
GPIB Cable, 0.5 meter	HP 10833D

In This Book

This guide provides instructions for installing and verifying the performance of the Agilent 35670A Dynamic Signal Analyzer.

Chapter 1, “Specifications,” lists the specifications for the Agilent 35670A and the specifications for the required test equipment.

Chapter 2, “Preparing the Agilent 35670A for Use,” provides step-by-step instructions for getting the analyzer ready to use and instructions on cleaning the screen, storing, and transporting.

Chapter 3, “Verifying Specifications,” provides step-by-step instructions for installing and running the semiautomated performance test software. This chapter also provides illustrations that show the equipment set up for each test and a copy of the test records.

Table of Contents

1 Specifications

Frequency	1-3
Single Channel Amplitude	1-4
FFT Dynamic Range	1-5
Input Noise	1-6
Window Parameters	1-6
Single Channel Phase	1-6
Cross Channel Amplitude	1-7
Cross Channel Phase	1-7
Input	1-8
Time Domain	1-9
Trigger	1-9
Tachometer	1-10
Source Output	1-11
Digital Interfaces	1-12
General Specifications	1-13
Order Tracking — Option 1D0	1-14
Swept Sine Measurements —Option 1D2	1-15
Arbitrary Waveform Source—Option 1D4	1-15
Real Time Octave Analysis — Option 1D1	1-16
Recommended Test Equipment	1-17

2 Preparing the Analyzer for Use

- To do the incoming inspection 2-5
- To install the analyzer 2-7
- To connect the analyzer to a dc power source 2-8
- To change the fuses 2-10
- To connect the analyzer to a serial device 2-11
- To connect the analyzer to a parallel device 2-11
- To connect the analyzer to an GPIB device 2-12
- To connect the analyzer to an external monitor 2-13
- To connect the optional keyboard 2-14
- To connect the microphone adapter 2-16
- To clean the screen 2-17
- To store the analyzer 2-17
- To transport the analyzer 2-18
- If the analyzer will not power up 2-19
- If the analyzer operates intermittently on dc power 2-20

3 Verifying Specifications

- To load the program 3-7
- To run the program in semiautomated mode 3-8
- To run the program without a printer 3-10
- To run the program in manual mode 3-12
- To set up the self test 3-13
- To set up the dc offset test 3-14
- To set up the noise test 3-15
- To set up the spurious signals test 3-16
- To set up the amplitude accuracy test 3-17
- To set up the flatness test 3-18
- To set up the amplitude linearity test 3-19
- To set up the A-weight filter test 3-20
- To set up the channel match test 3-21
- To set up the frequency accuracy test 3-22

Table of Contents (continued)

To set up the anti-alias filter test	3-23
To set up the input coupling test	3-24
To set up the harmonic distortion test	3-25
To set up the intermodulation distortion test	3-28
To set up the cross talk test	3-30
To set up the single channel phase accuracy test	3-34
To set up the external trigger test	3-35
To set up the input resistance test	3-37
To set up the ICP supply test	3-39
To set up the source amplitude accuracy test	3-43
To set up the source output resistance test	3-44
To set up the source dc offset test	3-46
To set up the source flatness test	3-47
To set up the source distortion test	3-48
Measurement Uncertainty	3-54

Performance Test Record-Two Channel

Performance Test Record-Four Channel

Operation Verification Test Record-Two Channel

Operation Verification Test Record-Four Channel

Index

Guide to Agilent 35670A Documentation

Need Assistance?

1

Specifications

Specifications

This chapter contains the specifications for the Agilent 35670A Dynamic Signal Analyzer and the critical specifications for the equipment required to test the Agilent 35670A.

Instrument specifications apply after 15 minutes warm-up and within 2 hours of the last self-calibration. When the internal cooling fan has been turned OFF, specifications apply within 5 minutes of the last self-calibration. All specifications are with 400 line frequency resolution and with anti-alias filters enabled unless stated otherwise.

Abbreviations

dBVrms = dB relative to 1 Volt rms.

dBfs = dB relative to full scale amplitude range. Full scale is approximately 2 dB below ADC overload.

FS or fs Full scale; synonymous with input range.

Real Time or Online = Refer to the collecting and displaying of information with no dropouts or missing information.

Rload = Load resistance connected to the analyzer's source.

Typical = Typical, non-warranted, performance specification included to provide general product information.

Vpk = Peak of the ac voltage.

Frequency

Maximum range

1 channel mode	102.4 kHz, 51.2 kHz (option AY6†)
2 channel mode	51.2 kHz
4 channel mode (option AY6 only)	25.6 kHz

Spans

1 channel mode	195.3 mHz to 102.4 kHz
2 channel mode	97.7 mHz to 51.2 kHz
4 channel mode (option AY6 only)	48.8 mHz to 25.6 kHz

Minimum resolution

1 channel mode	122 mHz (1600 line display)
2 channel mode	61 mHz (1600 line display)
4 channel mode (option AY6 only)	61 mHz (800 line display)

Maximum real-time bandwidth (FFT span for continuous data acquisition) (preset, fast averaging)

1 channel mode	25.6 kHz
2 channel mode	12.8 kHz
4 channel mode (option AY6 only)	6.4 kHz

Measurement rate (typical) (preset, fast averaging)

1 channel mode	≥70 averages/second (≥170 with 100 line display)
2 channel mode	≥33 averages/second
4 channel mode (option AY6 only)	≥15 averages/second

Display update rate (typical) (preset, fast average off)	5 updates/second 9 updates/second (single channel, single display, undisplayed traces set with static data: e.g., data register)
---	---

Accuracy	±30 ppm (±0.003%)
----------	-------------------

† Option AY6 single channel maximum range extends to 102.4 kHz without anti-alias filter protection.

Single Channel Amplitude

Absolute amplitude accuracy (FFT) (A combination of full scale accuracy, full scale flatness, and amplitude linearity.)	$\pm 2.92\%$ (0.25 dB) of reading $\pm 0.025\%$ of full scale
FFT full scale accuracy at 1 kHz (0 dBfs)	± 0.15 dB (1.74%)
FFT full scale flatness (0 dBfs) relative to 1 kHz	± 0.2 dB (2.33%)
FFT amplitude linearity at 1 kHz Measured on +27 dBVrms range with time average, 0 to -80 dBfs.	$\pm 0.58\%$ (0.05 dB) of reading $\pm 0.025\%$ of full scale
Amplitude resolution (16 bits less 2 dB over-range) with averaging	0.0019% of full scale (typical)
Residual dc response FFT mode frequency display (excludes A-weight filter)	< -30 dBfs or -66 dBvdc (.5mVdc)(whichever is greater)

FFT Dynamic Range

Spurious free dynamic range <-80 dBfs (90 dB typical)
(Includes spurs, harmonic distortion, intermodulation distortion, alias products)
Excludes alias responses at extremes of span.
Source impedance = 50 Ω

FFT noise floor (typical)
Flat top window, 64 RMS averages

Typical Noise Floor vs. Range for Different Frequency Spans

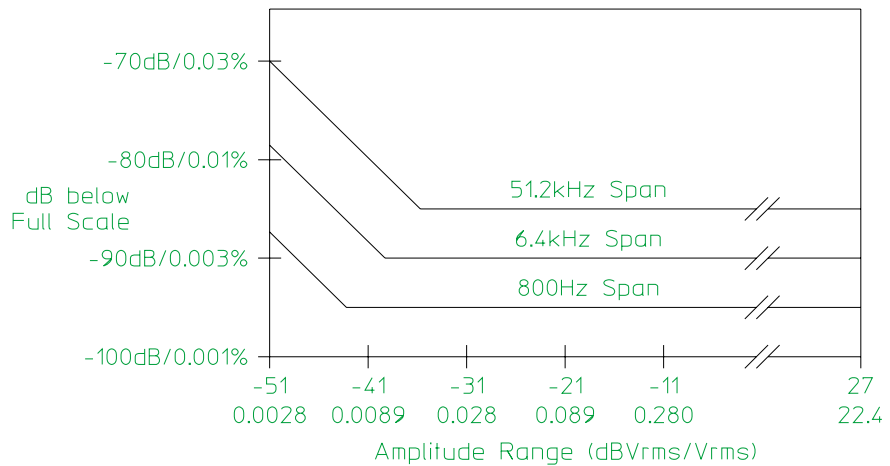

Harmonic distortion <-80 dBfs
Single tone (in band), ≤0 dBfs

Post-filter harmonic distortion (alias responses) of a single tone ≤102.4 kHz, ≤0 dBfs <-80 dBfs

Intermodulation distortion <-80 dBfs
Two tones (in-band), each ≤-6.02 dBfs

Spurious and residual responses <-80 dBfs
Source impedance = 50 Ω

Frequency alias responses
Single tone (out of displayed range), ≤0 dBfs, ≤1 MHz (≤200 kHz with ICP on)
2.5% to 97.5% of the frequency span <-80 dBfs
Lower and upper 2.5% of frequency span <-65 dBfs

Input Noise

Input noise level

Flat top window, -51 dBVrms range, source impedance = 50 Ω, 32 rms averages

Above 1280 Hz	<-140 dBVrms/√Hz
160 Hz to 1.28 kHz (6.4 kHz span)	<-130 dBVrms/√Hz

Note: To calculate noise as dB below full scale:

$$\text{Noise [dBfs]} = \text{Noise [dBVrms}/\sqrt{\text{Hz}}] + 10\text{LOG}(\text{NEBW}) - \text{Range [dBVrms]}.$$

See "Window Parameters," below, for noise equivalent bandwidths (NEBW).

Window Parameters

	Uniform	Hann	Flat Top
-3 dB bandwidth †	0.125% of span	0.185% of span	0.450% of span
Noise equivalent bandwidth †	0.125% of span	0.1875% of span	0.4775% of span
Attenuation at ± 1/2 bin	4.0 dB	1.5 dB	0.01 dB
Shape factor (-60 dB BW/-3 dB BW)	716	9.1	2.6

† For 800 line displays. With 400, 200, or 100 line displays, multiply bandwidths by 2, 4, and 8, respectively. With 1600 line displays (only available in 1 or 2 channel mode), divide bandwidths by 2.

Single Channel Phase

Phase accuracy relative to external trigger ±4.0 degree
 16 RMS averages, center of bin, dc coupled,
 0 dBfs to -50 dBfs, 0 Hz < freq ≤ 10.24 kHz
 only

For Hann and flat top windows, phase is referenced to a cosine wave at the center of the time record. For the uniform, force, and exponential windows, phase is referenced to a cosine wave at the beginning of the time record.

Cross Channel Amplitude

FFT cross channel gain accuracy
Frequency response mode, same amplitude range (AC coupled, periodic chirp, uniform window, $\geq 4\text{Hz}$)

At full scale: Tested with 10 rms averages $\pm 0.04\text{ dB}$ (0.46%)
on the -11 to +27 dBVrms ranges, and 100
rms averages on the -51 dBVrms range

At -20 dBfs: Tested with 200 rms averages $\pm 0.08\text{ dB}$ (0.92%)
on the -11 to +27 dBVrms ranges, and 2000
rms averages on the -51 dBVrms range

Cross Channel Phase

Cross channel phase accuracy $\pm 0.5\text{ degree}$
(same conditions as cross-channel amplitude, $\geq 12\text{Hz}$)

Input

Input ranges (full scale) (auto-range capability)	+27 dBVrms (31.7 Vpk) to -51 dBVrms (3.99 mVpk) in 2 dB steps
Maximum input levels	42 Vpk
Input impedance	1 M Ω \pm 10%, 90 pF nominal
Low side to chassis impedance	
Floating mode	1 M Ω \pm 30%, <0.010 μ F (typical)
Grounded mode	\leq 100 Ω
AC coupling rolloff	<3 dB rolloff at 1 Hz
Common mode rejection ratio Single tone at or below 1 kHz	
-51 dBVrms to -11 dBVrms ranges	>75 dB typical
-9 dBVrms to +9 dBVrms ranges	>60 dB typical
+11 dBVrms to +27 dBVrms ranges	>40 dB typical
Note: CM dBfs = CM signal input [dBVrms] - CMRR [dB] - range [dBVrms]	
Common mode range (floating mode)	\pm 4 Vpk
Amplitude over-range detection	+3 dB typical
ICP signal conditioning	
Current source	4.25 \pm 1.5 mA
Open circuit voltage	+26 to +32 Vdc
A-weight filter Conforms to ANSI Standard S1.4-1983; and to IEC 651-1979; 10 Hz to 25.6 kHz	Type 0 Tolerance
Crosstalk Between input channels, and source-to-input (receiving channel source impedance = 50 Ω)	<-135 dB below signal or <-80 dBfs of receiving channel, whichever response is greater in amplitude

Time Domain

Specifications apply in histogram/time mode, unfiltered time display

DC amplitude accuracy	$\pm 5.0\%$ fs
Rise time of -1 V to 0 V test pulse	$< 11.4\ \mu\text{s}$
Settling time of -1 V to 0 V test pulse	$< 16\ \text{ms}$ to 1%
Pulse aberrations (peak overshoot) of -1 V to 0 V test pulse Peak aberration relative to the mode-to-mode difference (most common values)	$< 3\%$
Sampling period	
1 channel mode	3.815 μs (1/262144 Hz) to 2 s in 2 \times steps
2 channel mode	7.629 μs (1/131072 Hz) to 4 s in 2 \times steps
4 channel mode (option AY6 only)	15.26 μs (1/65536 Hz) to 8 s in 2 \times steps

Trigger

Trigger modes	Internal trigger External trigger Source trigger GPIB trigger
Maximum trigger delay	
Post trigger	8191 seconds
Pre trigger	8191 sample periods
No two channels can be further than ± 7168 samples from each other.	
External trigger maximum input	$\pm 42\ \text{Vpk}$
External trigger range	
Low range	-2 V to +2 V
High range	-10 V to +10 V
External trigger resolution	
Low range	15.7 mV
High range	78 mV

Tachometer

Pulses per revolution	0.5 to 2048
RPM accuracy	± 100 ppm (0.01%) (typical)
Tachometer level range	
Low range	-4 V to +4 V
High range	-20 V to +20 V
Tachometer level resolution	
Low range	100 mV
High range	500 mV
Maximum tachometer input level	± 42 V _{pk}
Minimum tachometer pulse width	600 ns
Maximum tachometer pulse rate	400 kHz

Source Output

Source types	Sine, random noise, chirp, pink noise, burst random, burst chirp
Amplitude range	ac: ± 5 V peak † dc: ± 10 V † † $V_{acpk} + V_{dc} \leq 10$ V
AC amplitude resolution	
Voltage ≥ 0.2 Vrms	2.5 mVpk
Voltage < 0.2 Vrms	0.25 mVpk
DC offset accuracy	± 15 mV $\pm 3\%$ of ($ V_{dc} + V_{acpk}$) settings
Pink noise adder	Add 600 mV typical when using pink noise
Output impedance	$< 5 \Omega$
Maximum loading	
Current	± 20 mA peak
Capacitance	0.01 μ F
Sine amplitude accuracy at 1 kHz Rload $> 250 \Omega$ 0.1 Vpk to 5 Vpk	$\pm 4\%$ (0.34 dB) of setting
Sine flatness (relative to 1 kHz) 0.1 V to 5 V peak, 0 Hz to 102.4 kHz	± 1 dB
Harmonic and sub-harmonic distortion and spurious signals (in band) 0.1 Vpk to 5 Vpk sine wave	
Fundamental < 30 kHz	< -60 dBc
Fundamental ≥ 30 kHz	< -40 dBc

Digital Interfaces

External keyboard	Compatible with PC-style 101-key keyboard model number HP C1405A (#ABA) and HP keyboard cable part number 5081-2249 (DIN connector).
GPIB	Conforms to the following standards: IEEE 488.1 (SH1, AH1, T6, TEO, L4, LE0, RS1, RL1, PP0, DC1, DT1, C1, C2, C3, C12, E2) IEEE 488.2-1987 Complies with SCPI 1992 Factory set address: 11
Data transfer rate (REAL 64 Format)	<45 ms for a 401 point trace
Serial port (printing, plotting)	300 baud to 9600 baud
Parallel port (printing, plotting)	

General Specifications

Safety Standards CSA Certified for Electronic Test and Measurement Equipment per CSA C22.2, No. 231

This product is designed for compliance to:
UL1244, Fourth Edition
IEC 348, Second Edition, 1978

EMI/RFI Standards CISPR 11

Acoustics LpA <55 dB (cooling fan at high speed setting)
<45 dB (auto speed setting at 25° C)

Fan speed setting of high, automatic, and off are available. The fan off setting can be enabled for a short period of time, except at higher ambient temperatures where the fan will stay on.

Environmental operating restrictions	Operating: disk in drive	Operating: no disk in drive	Storage and transport
--------------------------------------	-----------------------------	--------------------------------	--------------------------

Ambient temperature	4° to 45° C	0° to 55° C	-40° to 70° C
---------------------	-------------	-------------	---------------

Relative humidity (non-condensing)	Operating: disk in drive	Operating: no disk in drive	Storage and transport
minimum	20%	15%	5%
maximum	80% at 32° C	95% at 40° C	95% at 50° C

Vibration (5 - 500 Hz)	0.6 Grms	2.1 Grms	3.41 Grms
------------------------	----------	----------	-----------

Shock	5 G (10 ms 1/2 sine)	5 G (10 ms 1/2 sine)	40 G (3 ms 1/2 sine)
-------	-------------------------	-------------------------	-------------------------

Maximum altitude	4600 meters (15,000 feet)
------------------	---------------------------

AC power	90 Vrms to 264 Vrms (47 to 440 Hz) 350 VA maximum
----------	--

DC power	12 Vdc to 28 Vdc nominal 200 VA maximum
----------	--

DC current at 12 V (typical)	10 A (standard) 12 A (4 channel, option AY6)
------------------------------	---

Warm-up time	15 minutes
--------------	------------

Weight	15 kg (33 lb) net 29 kg (64 lb) shipping
--------	---

Dimensions (Excluding bail handle and impact cover)	Height: 190 mm (7.5 in) Width: 340 mm (13.4 in) Depth: 465 mm (18.3 in)
--	---

IEC 801-3 (Radiated Immunity) Performance degradation may occur at Severity Level 2.

Order Tracking — Option 1D0

$$\frac{\text{Max Order} \times \text{Max RPM}}{60} \leq$$

Real time (online)	
1 channel mode	25,600 Hz
2 channel mode	12,800 Hz
4 channel mode	6,400 Hz
<hr/>	
Capture playback †	
1 channel mode	102,400 Hz, 51,200 Hz (option AY6)
2 channel mode	51,200 Hz
4 channel mode	25,600 Hz
<hr/>	
Number of orders ≤ 200	
5 \leq RPM \leq 491,519 (Maximum useable RPM is limited by resolution, tach pulse rate, pulses/revolution, and average mode settings.)	
<hr/>	
Delta order	1/128 to 1/1
<hr/>	
Resolution (maximum order)/(delta order)	≤ 200
<hr/>	
Maximum RPM ramp rate	750 RPM/second (typical for real time)
1000 to 10,000 RPM run up	
maximum order = 10	
delta order = 0.1	
RPM step = 30 (1 channel)	
= 60 (2 channel)	
= 120 (4 channel)	
<hr/>	
Order track amplitude accuracy	± 1 dB (typical)

Real Time Octave Analysis — Option 1D1

Standards	Conforms to ANSI Standard S1.11 - 1986, Order 3, Type 1-D, Extended and Optional Frequency Ranges
	Conforms to IEC 651-1979 Type 0 Impulse, and ANSI S1.4

Frequency ranges (at centers)

Online (real time)

	1 channel	2 channel	4 channel
1/1 octave	0.063 Hz to 16 kHz	0.063 Hz to 8 kHz	0.063 Hz to 4 kHz
1/3 octave	0.08 Hz to 40 kHz	0.08 Hz to 20 kHz	0.08 Hz to 10 kHz
1/12 octave	0.0997 Hz to 12.338 kHz	0.0997 Hz to 6.169 kHz	0.0997 Hz to 3.084 kHz

Capture playback

	1 channel	2 channel	4 channel
1/1 octave	0.063 Hz to 16 kHz	0.063 Hz to 16 kHz	0.063 Hz to 16 kHz
1/3 octave	0.08 Hz to 31.5 kHz	0.08 Hz to 31.5 kHz	0.08 Hz to 31.5 kHz
1/12 octave	0.0997 Hz to 49.35 kHz	0.0997 Hz to 49.35 kHz	0.0997 Hz to 49.35 kHz

1 to 12 octaves can be measured and displayed.

1/1, 1/3, and 1/12 octave true center frequencies related by the formula:

$$\frac{f(i+1)}{f(i)} = 2^{1/n}; n=1, 3, \text{ or } 12;$$

Where 1000 Hz is the reference for 1/1, 1/3 octave, and $1000 \times 2^{(1/24)}$ Hz is the reference for 1/12 octave. The marker returns the ANSI standard preferred frequencies.

Accuracy	±0.2 dB
1 second stable average single tone at band center	

Readings are taken from the linear total power spectrum bin. It is derived from sum of each filter.

1/3 octave dynamic range 2 second stable average, limited by input noise level	>80 dB (typical) per ANSI S1.11 - 1986
--	--

Swept Sine Measurements —Option 1D2

Dynamic range	130 dB typical
Default span: 51.2 Hz to 51.2 kHz	
Fast average ON, 101 point log sweep	
Tested with 11 dBVrms source level at 100 ms integration (approximately 60 second sweep)	

Arbitrary Waveform Source—Option 1D4

Amplitude Range	Arb: ± 5 Vpk † dc: ± 10 V † † Vpk + Vdc ± 10 V
Record Length Depends on measurement resolution (100, 200, 400, 800, and 1600 lines)	# of points = $2.56 \times$ lines of resolution, or # of complex points = $1.28 \times$ lines of resolution
Point spacing	Matches the measurement sample rate.
DAC Resolution	
0.2828 Vpk to 5 Vpk	2.5 mV
<0.2828 Vpk	0.25 mV

Recommended Test Equipment

The following table lists the recommended equipment needed to test the performance of the Agilent 35670A Dynamic Signal Analyzer. The table on page 1-20 lists additional equipment needed to adjust and troubleshoot the analyzer. Other equipment may be substituted for the recommended model if it meets or exceeds the listed critical specifications. When substitutions are made, you may have to modify the procedures to accommodate the different operating characteristics.

Recommended Test Equipment

Instrument	Critical Specifications	Recommended Model
AC Calibrator	10 Hz to 102.4 kHz; 1 mV to 10 V Amplitude Amplitude Accuracy: $\pm 0.1\%$ phase locking capability	Fluke 5700A † Alternate Fluke 5200A † Datron 4200, 4700, or 4708 ‡ HP 745A
Frequency Synthesizer	Frequency Range: 10 Hz to 1 MHz Frequency Accuracy: ≤ 5 ppm Amplitude Accuracy: 0.2 dB from 1 Hz to 100 kHz 1 dB from 100 kHz to 1 MHz Harmonic Distortion: ≤ -70 dBc Spurious: ≤ -70 dBc $< \pm 1$ deg phase shift between output and sync	HP 3326A Alternate (2) HP 3325A/B Opt 001
Low Distortion Oscillator	Frequency Range: 10 Hz to 100 kHz Harmonic Distortion: ≤ -93 dB, 10 Hz to 20 kHz	HP 339A †† Alternate HP 3326A with notch filter †† HP 3325A/B with notch filter††
Digital Multimeter	5 1/2 digit True rms ac Voltage: 30 Hz to 100 kHz; 0.1 to 500 V; $\pm 0.1\%$; ≥ 1 M Ω input impedance dc Voltage: 1 V to 300 V; $\pm 0.1\%$	HP 3458A Alternate HP 3456A , HP 3455A HP 3478A
Feedthrough Termination (2) (4 for option AY6)	50 Ω : $\pm 2\%$ at dc	Pomona Elect Model 4119-50 ‡‡ Alternate HP 11048C, HP 10100C

† John Fluke Manufacturing Co., Inc., PO Box C9090, Everett, WA 98206 U.S.A. (206) 347-6100

‡ Wavetek, 5808 Churchman Bypass, Indianapolis, IN 46203 U.S.A.

†† This equipment is not required for Operation Verification. The parts and schematic for the notch filter are shown on page 1-19.

‡‡ ITT Pomona Electronics, 1500 East Ninth Street, Pomona, CA 91769 U.S.A. (714) 469-2900
FAX (206) 629-3317

Recommended Test Equipment (continued)

Instrument	Critical Specifications	Recommended Model
Cables	BNC-to-Dual Banana (6) BNC-to-BNC 30 cm BNC-to-BNC 122 cm	HP 11001-60001 HP 8120-1838 HP 8120-1840
Adapters	BNC (m)-to-Dual Banana Plug BNC (f)-to-Dual Banana Plug BNC (f)-to-BNC (f) (4) BNC Tee (m)(f)(f)	HP 10110B HP 1251-2277 HP 1250-0080 HP 1250-0781
Resistor (2)†	Value: 1 kΩ Accuracy: 1% Power: 0.25W	HP 0757-0280

† See the following for suggested assembly.

Suggested Assembly for Series Resistor

The following is a suggested assembly for the 1 kΩ series resistor. Two 1 kΩ series resistors are required for the Intermodulation Distortion performance test.

- 1** Cut resistor leads to 12 mm on each end.
- 2** Solder one resistor lead to the center conductor of the BNC female connector.
- 3** Solder the conductor center pin to the other lead of the resistor.
- 4** Screw the sleeve and the BNC male connector into place. Tighten securely.

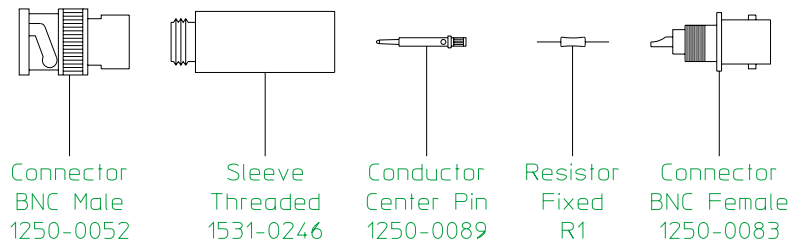

Schematic and Parts List for Notch Filter

The Harmonic Distortion performance test requires either an HP 339A or an HP 3326A or HP 3325A/B with notch filter. The following shows the schematic and parts list for the notch filter.

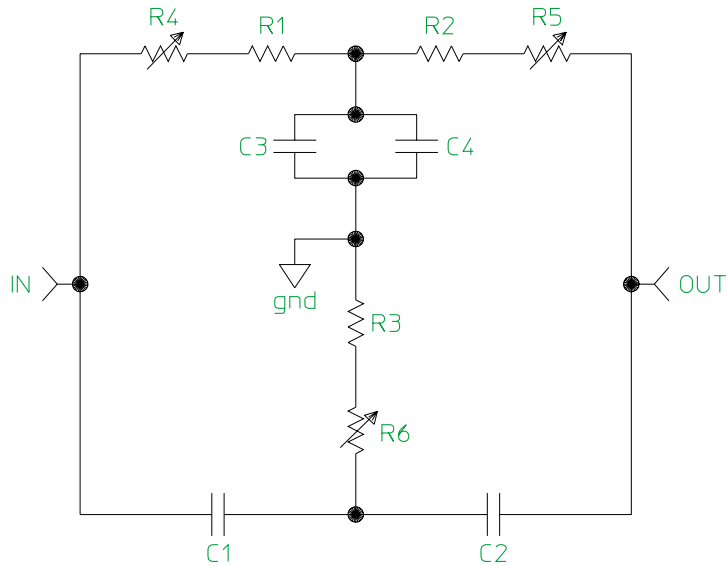

Reference	Description	HP Part Number
C1 - C4	0.025 μ F \pm 2.5%, 100 V polypropelene-metalized	HP 0160-6809
R1 - R2	249 Ω \pm 1% metal film, 0.125 W	HP 0698-4421
R3	118 Ω \pm 1% metal film, 0.125 W	HP 0698-4407
R4 - R6	20 Ω trimmer, 1 turn	HP 2100-3409

Specifications
Recommended Test Equipment

Agilent 35670A

Additional Recommended Test Equipment

Instrument	Critical Specifications	Recommended Model
Frequency Counter	Frequency Range: 0 Hz to 100 MHz Frequency Accuracy: 7.5 ppm or better at 20 MHz	HP 5350B Alternate HP 5351B, HP 5335A
Oscilloscope	Bandwidth: >50 MHz Two Channel; External Trigger; 1 M Ω Input	HP 54111D Alternate HP 1980B, HP 1740
Oscilloscope Probe	Impedance: ≥ 1 M Ω Division Ratio: 10:1 Maximum Voltage: ≥ 20 Vdc	HP 10431A
Oscilloscope Probe	Impedance: ≥ 1 M Ω Division Ratio: 1:1	HP 10438A
Spectrum Analyzer	Frequency Range: 10 Hz to 100 kHz Dynamic Range: ≥ 70 dB	HP 3562A Alternate HP 3561A, HP 3585A/B
Serial Port Connector	RS-232-C, 9-pin male	HP 1251-0216
Parallel Port Connector	Centronics, 25-pin male	HP 1251-0063
Capacitive Load	Value: 3300 pF	HP 35660-64401
Coaxial Adapter	BNC(f)-to-minigrabber	Pomona 3788 †

† ITT Pomona Electronics, 1500 East Ninth Street, Pomona, CA 91769 U.S.A. (714) 469-2900
FAX (206) 629-3317

2

Preparing the Analyzer for Use

Preparing the Analyzer for Use

This chapter contains instructions for inspecting and installing the Agilent 35670A Dynamic Signal Analyzer. This chapter also includes instructions for cleaning the screen, transporting and storing the analyzer.

DC Power Requirements

The analyzer can operate from a dc power source supplying a true range of 10.8 to 30.8 Vdc. With all options installed, power consumption is less than 200 VA. The following table shows typical current requirements at different operating voltages for the standard two-channel analyzer and for the optional four-channel analyzer.

Operating Voltage	Typical Current	
	Standard 2 channel Agilent 35670A	Optional 4 channel Agilent 35670A
12 Vdc	8.0 amps	11.0 amps
24 Vdc	4.0 amps	5.5 amps

AC Power Requirements

The analyzer can operate from a 47 to 440 Hz, single-phase, ac power source supplying 90 to 264 Vrms. With all options installed, power consumption is less than 350 VA.

Warning

Only a qualified service person, aware of the hazards involved, should measure the line voltage.

DC Power Cable and Grounding Requirements

The negative side of the dc input connector is not connected to chassis ground. In dc mode operation, the chassis will float. The chassis ground lug on the rear panel and the negative side of the dc input connector should both be connected to a known reference potential.

Two dc power cables are available—the HP 35250A dc power cable and the HP 35251A dc power cable with cigarette lighter adapter. Both cables contain a 30 amp, 32 volt fuse (HP 2110-0920).

Warning

The tip of the cigarette lighter adapter may get hot during use. After unplugging the adapter, be careful of the heat from the adapter's tip.

Caution

Although shorter cables may reduce dc voltage loss, use the standard cables. The dc inrush current may pit the connector contacts in shorter cables.

AC Power Cable and Grounding Requirements

On the GPIB connector, pin 12 and pins 18 through 24 are tied to chassis ground and the GPIB cable shield. The instrument frame, chassis, and covers are connected to chassis ground. The input BNCs are floating unless ground mode is selected.

The analyzer is equipped with a three-conductor power cord that grounds the analyzer when plugged into an appropriate receptacle. The type of power cable plug shipped with each analyzer depends on the country of destination. The following figure shows available power cables and plug configurations.

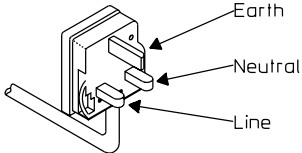
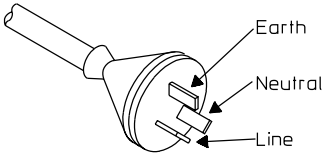
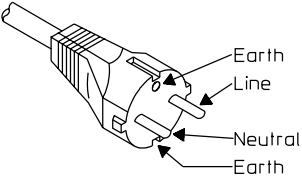
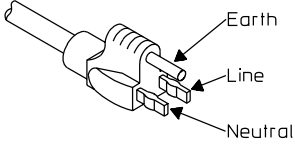
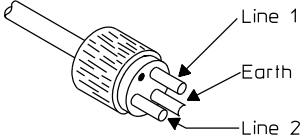
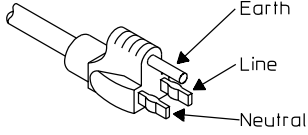
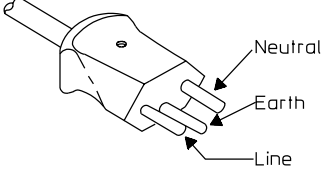
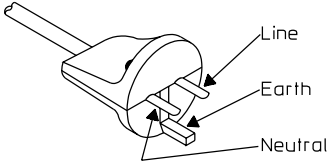
<p>United Kingdom Option 900</p>  <p>PLUG*: BS 1363A CABLE*: HP 8120-1703</p> <p>220V-5A OPERATION</p>	<p>Australia/New Zealand Option 901</p>  <p>PLUG*: NZSS 198/AS C112 CABLE*: HP 8120-0696</p> <p>220V-6A OPERATION</p>
<p>Continental Europe Option 902</p>  <p>PLUG*: CEE7-V11 CABLE*: HP 8120-1692</p> <p>220V-6A OPERATION</p>	<p>North America Option 903</p>  <p>PLUG*: NEMA 5-15P CABLE*: HP 8120-1521</p> <p>125V-10A** OPERATION</p>
<p>North America Option 904</p>  <p>PLUG*: NEMA-G-15P CABLE*: HP 8120-0698</p> <p>250V-6A** OPERATION</p>	<p>Japan Option 918</p>  <p>PLUG*: MITI 41-9692 CABLE*: HP 8120-4754</p> <p>125V-12A OPERATION</p>
<p>Switzerland Option 906</p>  <p>PLUG*: SEV 1011.1959-24507 TYPE 12 CABLE*: HP 8120-2296</p> <p>220V-6A OPERATION</p>	<p>Denmark Option 912</p>  <p>PLUG*: DHCR 107 CABLE*: HP 8120-2957</p> <p>220V-6A OPERATION</p>

*The number shown for the plug is the industry identifier for the plug only, the number shown for the cable is an HP part number for a complete cable including the plug.

**UL listed for use in the United States of America.

Warning

The power cable plug must be inserted into an outlet provided with a protective earth terminal. Defeating the protection of the grounded analyzer cabinet can subject the operator to lethal voltages.

To do the incoming inspection

The Agilent 35670A Dynamic Signal Analyzer was carefully inspected both mechanically and electrically before shipment. It should be free of marks or scratches, and it should meet its published specifications upon receipt.

- 1 Inspect the analyzer for physical damage incurred in transit. If the analyzer was damaged in transit, do the following:
 - Save all packing materials.
 - File a claim with the carrier.
 - Call your Hewlett-Packard sales and service office.

Warning

If the analyzer is mechanically damaged, the integrity of the protective earth ground may be interrupted. Do not connect the analyzer to power if it is damaged.

- 2 Check that the POWER SELECT switch on the analyzer's rear panel is set to the AC position.
The switch is in the AC position when in the "in" position.

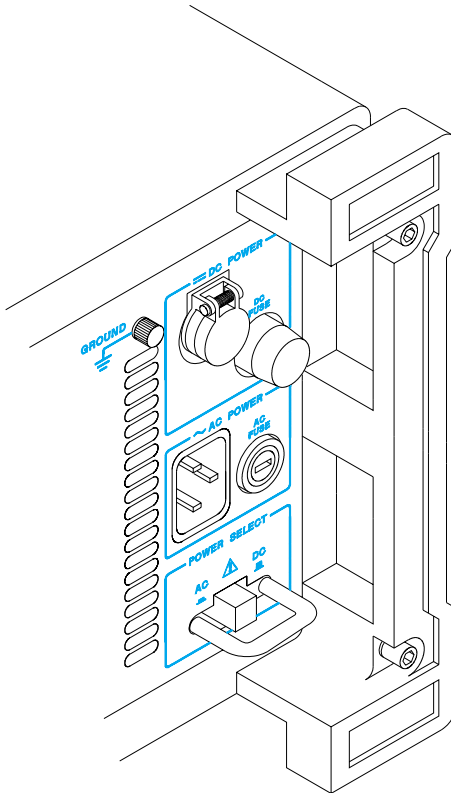

- 3** Check that the correct fuses are installed in the fuse holders.
An 8 amp, 250 volt, normal blow fuse is required for ac operation. A 30 amp, 32 volt, normal blow fuse is required for dc operation. Both fuses are installed at the factory. For instructions on removing the fuses or fuse part numbers, see "To change the fuses."
- 4** Using the supplied power cord, connect the analyzer to an appropriate receptacle.
The analyzer is shipped with a three-conductor power cord that grounds the analyzer when plugged into an appropriate receptacle. The type of power cable plug shipped with each analyzer depends on the country of destination.
- 5** Set the analyzer's power switch to on.
Press the switch located on the analyzer's lower left-hand corner. The switch is in the on (I) position when in the "in" position. The analyzer requires about 20 seconds to complete its power-on routine.
- 6** Test the electrical performance of the analyzer using the operation verification or the performance tests in chapter 3, "Verifying Specifications."
The operation verification tests verify the basic operating integrity of the analyzer; these tests take about 1½ hours to complete and are a subset of the performance tests. The performance tests verify that the analyzer meets all the performance specifications; these tests take about 2½ hours to complete.

To install the analyzer

The analyzer is shipped with rubber feet and bail handle in place, ready for use as a portable or bench analyzer.

- Install the analyzer to allow free circulation of cooling air.
Cooling air enters the analyzer through the right side and exhausts through the left side and rear panel.
- To install the analyzer in an equipment cabinet, follow the instructions shipped with the rack mount kit.

Warning

To prevent potential fire or shock hazard, do not expose the analyzer to rain or other excessive moisture.

- Protect the analyzer from moisture and temperatures or temperature changes that cause condensation within the analyzer.
The operating environment specifications for the analyzer are listed in chapter 1, "Specifications."
- Protect the analyzer's disk drive from dirt and dust.
Remove the screw to the right of the disk drive and use it to attach the supplied disk drive cover. The disk drive cover is located inside the front-panel impact cover.

Caution

Use of the equipment in an environment containing dirt, dust, or corrosive substances will drastically reduce the life of the disk drive and the flexible disks. To minimize damage, use the disk drive cover and store the flexible disks in a dry, static-free environment.

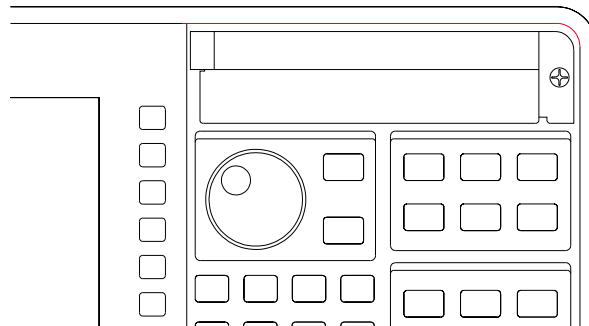

To connect the analyzer to a dc power source

In applications requiring a portable dc power source, use a properly protected dc power system. The dc system should contain a deep cycle battery rather than a standard automobile battery. A standard automobile battery will fail prematurely if repeatedly discharged. Also, select a battery that provides the best compromise between operation time and portability.

- 1 Set the analyzer's power switch to off (O).
- 2 Set the analyzer's POWER SELECT switch to the DC position.
The switch is in the DC position when in the "out" position.
- 3 Connect the dc power cable to the dc power source.
Using the dc power cable (HP 35250A), attach the black cable to the common terminal and the red cable to the positive terminal of the dc power source. Using the dc power cable with cigarette lighter adapter (HP 35251A), plug the cigarette lighter adapter into an automotive cigarette lighter receptacle.
- 4 Connect the analyzer's ground terminal to the same reference potential as the common terminal of the dc power source.
Using a wire, connect the analyzer's GROUND terminal to the common terminal of the dc source. If you are using the dc power cable with cigarette lighter adapter, connect the GROUND terminal to the automobile chassis.
- 5 Plug the dc power cable into the analyzer's DC POWER receptacle. Make sure to align the red dot on the plug with the red dot on the receptacle.

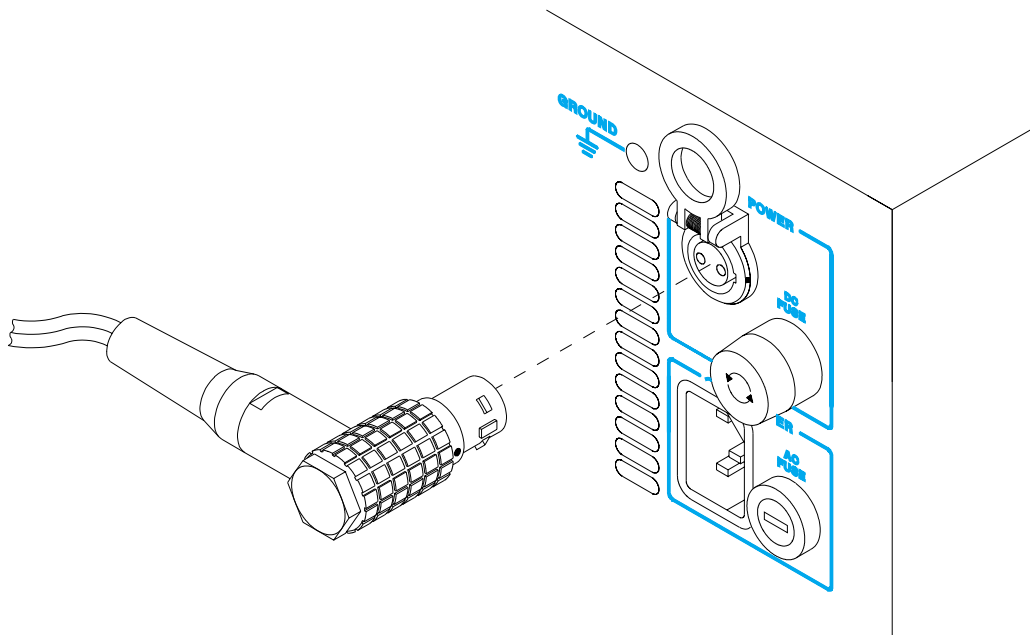

6 Turn on the dc power source.

If the dc power source is supplied by an automobile, start the automobile. The automobile must be running to provide adequate dc power.

Warning

The tip of the cigarette lighter adapter may get hot during use. After unplugging the adapter, be careful of the heat from the adapter's tip.

7 Set the analyzer's power switch to on (I).

If the analyzer will not power up or operates intermittently on dc power, see "If the analyzer will not power up" or "If the analyzer operates intermittently on dc power" at the end of this chapter.

To change the fuses

Both fuses are installed at the factory.

- 1 Unplug the power cord from the analyzer.
- 2 Press in and turn the appropriate fuse holder cap counter-clockwise (use a small screw driver for the ac fuse). Remove when the fuse cap is free from the housing.
- 3 Pull the fuse from the fuse holder cap.
- 4 To reinstall, select the proper fuse and place in the fuse holder cap.

DC Fuse

HP 2110-0920 30 A 32 V Normal Blow

AC Fuse

HP 2110-0342 8 A 250 V Normal Blow

- 5 Place the fuse holder cap in the housing. Press in and turn clockwise.

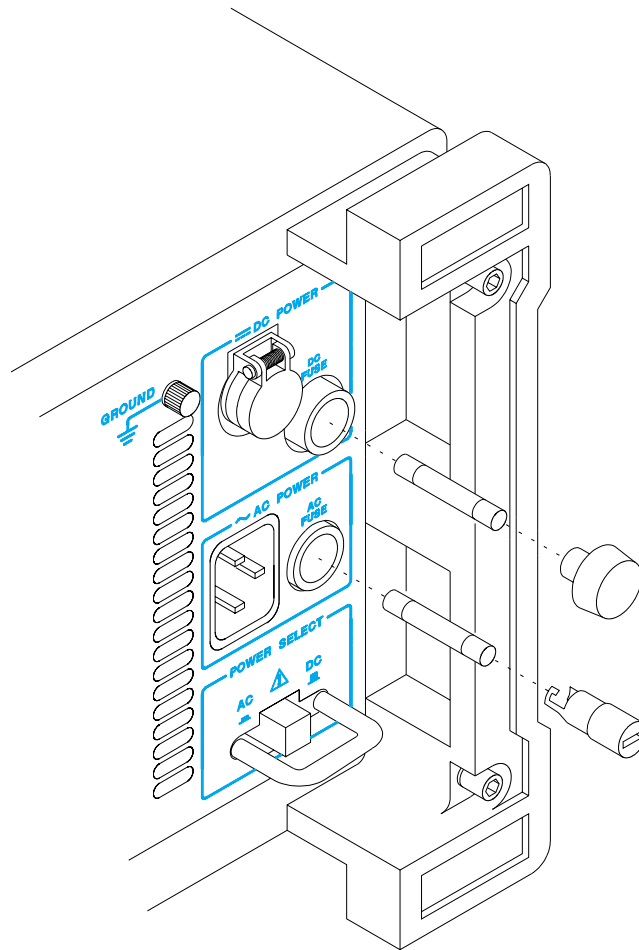

To connect the analyzer to a serial device

The Serial Port is a 9-pin, EIA-574 port that is only available using Instrument Basic. The total allowable transmission path length is 50 feet.

- Connect the analyzer's rear panel SERIAL PORT to a serial device using a 9-pin female to 25-pin RS-232-C cable.

Part Number	Cable Description
HP 24542G	9-pin female to 25-pin male RS-232
HP 24542H	9-pin female to 25-pin female RS-232

For additional information, see chapter 9 in the *Agilent 35670A Service Guide*.

To connect the analyzer to a parallel device

The Parallel Port is a 25-pin, Centronics port. The Parallel Port can interface with PCL printers or HP-GL plotters.

- Connect the analyzer's rear panel PARALLEL PORT connector to a plotter or printer using a Centronics interface cable.
For additional information, see chapter 9 in the *Agilent 35670A Service Guide*.

To connect the analyzer to an GPIB device

The analyzer is compatible with the Hewlett-Packard Interface Bus (GPIB). The GPIB is Hewlett-Packard's implementation of IEEE Standard 488.1. Total allowable transmission path length is 2 meters times the number of devices or 20 meters, whichever is less. Operating distances can be extended using an GPIB Extender.

GPIB peripherals include HP-GL plotters, PCL printers, and SS-80 external disks.

- Connect the analyzer's rear panel GPIB connector to an GPIB device using an GPIB interface cable.

Caution

The analyzer contains metric threaded GPIB cable mounting studs as opposed to English threads. Use only metric threaded GPIB cable lockscrews to secure the cable to the analyzer. Metric threaded fasteners are black, while English threaded fasteners are silver.

For GPIB programming information, see the *Agilent 35670A GPIB Programming Reference*.

To connect the analyzer to an external monitor

The External Monitor connector is a 9-pin D female miniature connector that can interface with an external, multisync monitor. The monitor must be compatible with the 24.8 kHz line rate, 55 Hz frame rate, and TTL signals provided by the Agilent 35670A. A SONY CPD-1302 monitor and a NEC Multisync 3D monitor with EZPIXpc† driver has been checked and found compatible with the Agilent 35670A external monitor mode operation.

1 Set the analyzer’s power switch to on (I).

2 Set the monitor’s power switch to on and configure the input and timing mode if necessary.

See the manual supplied with the monitor for information on configuring the monitor’s input and timing mode.

3 Connect the external monitor’s input cable to the analyzer’s rear panel EXT MONITOR connector.

A cable with a 9-pin connector option or an adapter to a 9-pin connector is required to connect the monitor to the Agilent 35670A.

4 Press the following keys to enable external mode:

- [**Disp Format**]
- [MORE]
- [MORE]
- [EXT MON ON OFF]

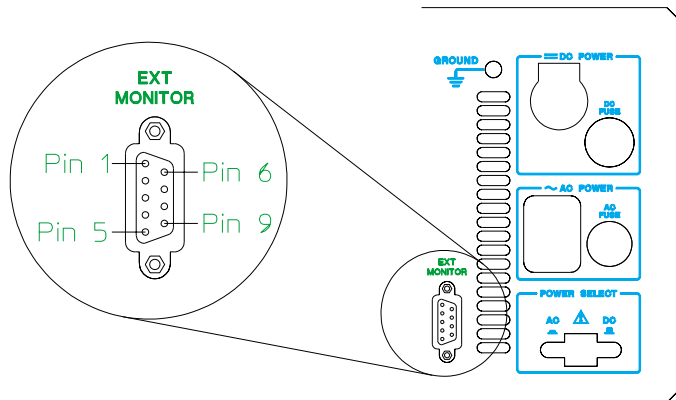

Pin Number	Signal Name	Pin Number	Signal Name
3	R	8	HSYNC
4	G	9	VSYNC
5	B	1, 2, 6	GND

† The EZPIXpc driver converts TTL video signals into RGB analog signals, drives 75 ohm coax cable, provides RGB composite sync or RGB sync on green, for monitors with RGB input capability. EZPIXpc, Covid, Inc., 1725 West 17th St, Tempe, Arizona 85281, 800-638-6104

To connect the optional keyboard

The analyzer may be connected to an optional external keyboard. The keyboard remains active even when the analyzer is not in alpha entry mode. This means that you can operate the analyzer using the external keyboard rather than the front panel. Pressing the appropriate keyboard key does the same thing as pressing a hardkey or a softkey on the analyzer's front panel.

- 1 Set the power switch to off (O).

Caution

Do not connect or disconnect the keyboard cable with the line power turned on (I). Connecting or disconnecting the keyboard while power is applied may damage the keyboard or the analyzer.

- 2 Connect the round plug on the keyboard cable to the KEYBOARD connector on the analyzer's rear panel. Make sure to align the plug with the connector pins.

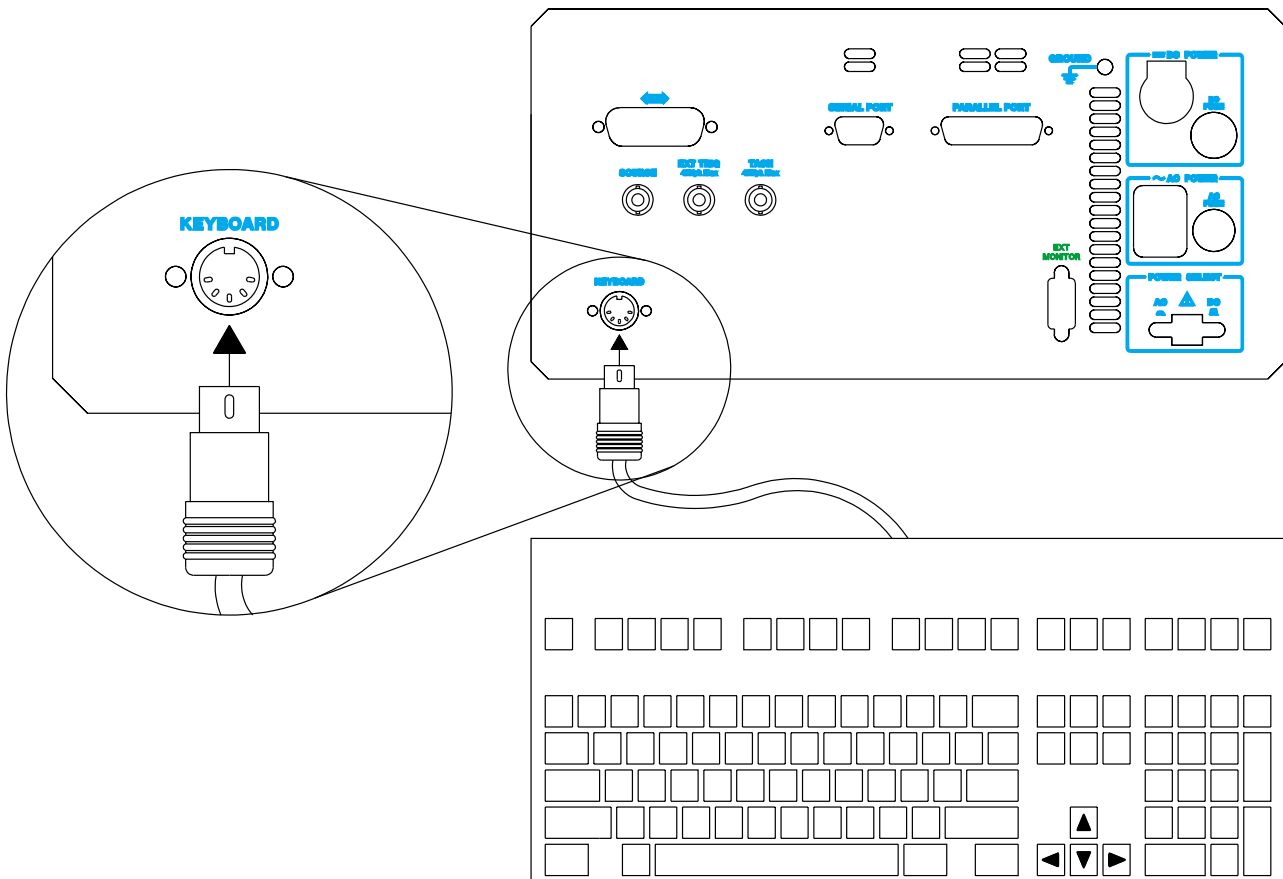

3 Connect the other end of the keyboard cable to the keyboard.

Caution

In addition to the U.S. English keyboard, the Agilent 35670A Dynamic Signal Analyzer supports U.K. English, German, French, Italian, Spanish, and Swedish. Use only the Hewlett-Packard approved keyboard for this product. Hewlett-Packard does not warrant damage or performance loss caused by a non-approved keyboard. See the beginning of this guide for part numbers of approved Hewlett-Packard keyboards.

- 4** To configure your analyzer for a keyboard other than U.S. English, press [**System Utility**] [**KEYBOARD SETUP**]. Then press the appropriate softkey to select the language.
- Configuring your analyzer to use a keyboard other than U.S. English only ensures that the analyzer recognizes the proper keys for that particular keyboard. Configuring your analyzer to use another keyboard *does not* localize the on-screen annotation or the analyzer's online HELP facility.

To connect the microphone adapter

The Microphone Adapter and Power Supply (option UK4) simplifies microphone connections. The mic connector on the analyzer's front panel provides 8 Vdc to power the adapter. The adapter's internal power supply uses a step-up converter to provide 28 V and 200 V on the seven-pin input connectors. The 28 V pins power the microphone pre-amplifiers. The 200 V pins polarize the condenser microphone cartridges.

- 1** Flip the bail handle down to support the front of the analyzer.
- 2** Insert the threaded ends of the adapter's two knurled knobs into the standoffs on the bottom of the analyzer's case, then tighten the knobs with your fingers.
- 3** Attach the adapter's mic cable to mic connector on the analyzer's front panel.
- 4** Connect the adapter's BNCs to the corresponding BNCs on the analyzer's front panel.

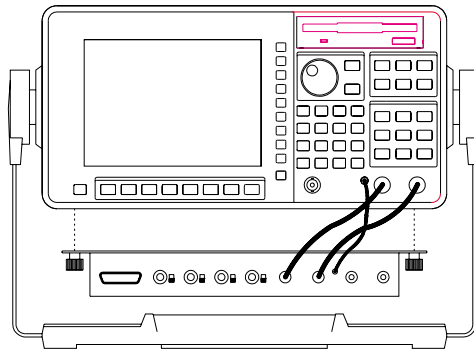

Standard 2 channel Agilent 35670A

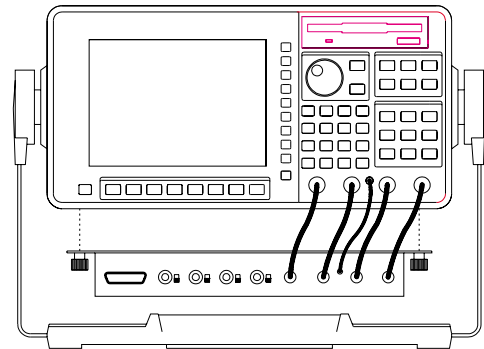

Optional 4 channel Agilent 35670A

To clean the screen

The analyzer's display is covered with a plastic diffuser screen (this is not removable by the operator). Under normal operating conditions, the only cleaning required will be an occasional dusting. However, if a foreign material adheres itself to the screen, do the following:

- 1** Set the power switch to off (O).
- 2** Remove the power cord.
- 3** Dampen a soft, lint-free cloth with a mild detergent mixed in water.
- 4** Carefully wipe the screen.

Caution

Do not apply any water mixture directly to the screen or allow moisture to go behind the front panel. Moisture behind the front panel will severely damage the instrument.

To prevent damage to the screen, do not use cleaning solutions other than the above.

To store the analyzer

- Store the analyzer in a clean, dry, and static free environment. For other requirements, see environmental specifications in chapter 1, "Specifications."

To transport the analyzer

- Package the analyzer using the original factory packaging or packaging identical to the factory packaging.

Containers and materials identical to those used in factory packaging are available through Hewlett-Packard offices.

- If returning the analyzer to Hewlett-Packard for service, attach a tag describing the following:
 - Type of service required
 - Return address
 - Model number
 - Full serial number

In any correspondence, refer to the analyzer by model number and full serial number.

- Mark the container FRAGILE to ensure careful handling.
- If necessary to package the analyzer in a container other than original packaging, observe the following (use of other packaging is not recommended):
 - Snap the impact cover in place to protect the front panel.
 - Wrap the analyzer in heavy paper or anti-static plastic.
 - Use a double-wall carton made of at least 350-pound test material.
 - Cushion the analyzer to prevent damage.

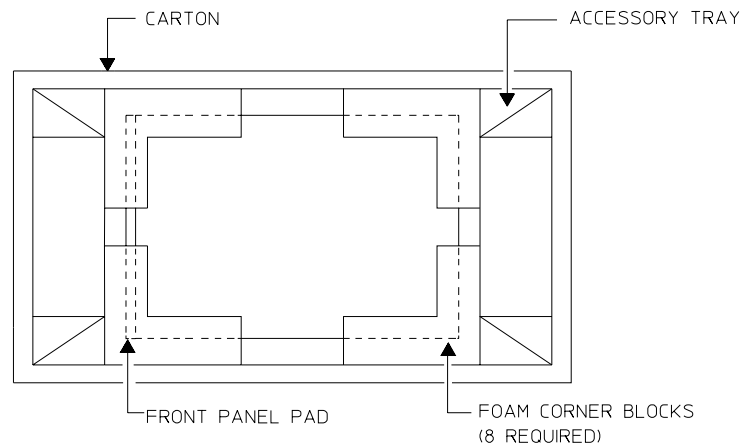

Caution

Do not use styrene pellets in any shape as packing material for the analyzer. The pellets do not adequately cushion the analyzer and do not prevent the analyzer from shifting in the carton. In addition, the pellets create static electricity which can damage electronic components.

If the analyzer will not power up

Check that the power cord is connected to the Agilent 35670A and to a live power source.

Check that the front-panel switch is on (I).

Check that the rear-panel AC/DC power select switch is properly set.

Check that the fuse is good.

See "To change the fuses" on page 2-10.

Check that the analyzer's air circulation is not blocked.

Cooling air enters the analyzer through the right side and exhausts through the left side and rear panel. If the analyzer's air circulation is blocked, the analyzer powers down to prevent damage from excessive temperatures. The analyzer remains off until it cools down and its power switch is set to off (O) then to on (I).

Obtain Agilent service, if necessary. See "Need Assistance?" at the end of this guide.

If the analyzer operates intermittently on dc power

The analyzer powers down when operating on dc power if no measurement has been made within 30 minutes.

Check that the dc power source can supply the required power.

The dc power source must have a true range of 10.8 to 30.8 Vdc. At the minimum voltage of 10.8 Vdc, the dc power source must be able to supply approximately 8.7 amps for a two-channel analyzer and 12.2 amps for a four-channel analyzer. The voltage loss through an automotive cigarette lighter system can cause the dc voltage to go below 10.8 Vdc.

Check that power transients are not causing the dc voltage to go below 10.8 Vdc.

The dc voltage provided by an automobile is susceptible to power transients. For example, power transients may occur when lights or fans turn on or off, when power door locks engage or disengage, and when windshield wipers operate. If the dc supply voltage falls below 10.8 V, the analyzer automatically turns off. However, the analyzer is not affected by power transients that occur within the range of 10.8 to 30.8 Vdc.

Check that the cable connections are not loose.

Obtain Agilent service, if necessary. See "Need Assistance?" at the end of this guide.

3

Verifying Specifications

Verifying Specifications

This chapter tells you how to use the *Agilent 35670A Semiautomated Performance Test Disk*. The performance test disk contains a program that semiautomates the operation verification tests and performance tests.

After you review this chapter, follow the directions in “To load the program” then continue with one of the following:

- “To run the program in semiautomated mode”
- “To run the program without a printer”
- “To run the program in manual mode”

Caution

Before applying line power to the analyzer or testing its electrical performance, see chapter 2, “Preparing the Analyzer for Use.”

Overview

The *Semiautomated Performance Test Disk* contains a program (ITM_35670A) and two procedure files (OP_VERIFY and PERFORMAN). ITM_35670A is the test manager program. OP_VERIFY is the operation verification procedure file and PERFORMAN is performance test procedure file. The procedure files contain an ordered list of tests, and each test contains one or more measurements. Since ITM_35670A reads the procedure files, the disk must remain in the disk drive during testing.

If you do not have a keyboard connected to the analyzer, use the numeric key pad and the alpha keys when the program prompts you to type in information. See the analyzer’s help text for a description of the alpha keys.

If a test fails, contact your local Agilent Technologies sales and service office or have a qualified service technician see chapter 4, “Troubleshooting the Analyzer,” in the *Agilent 35670A Service Guide*.

Features of the Program

- The program can automatically create a printout similar to the test records at the back of this chapter.
- The program can beep when equipment connections need to be changed.
- The program can start the test sequence at any test in the operation verification or performance test list.
- The program can stop after each measurement or alternatively, only if a failure occurs.
- The program can be run in manual mode.

Test Duration

In semiautomated mode, the operation verification tests require approximately 1½ hours and the performance tests require approximately 2½ hours.

Calibration Cycle

To verify the Agilent 35670A Dynamic Signal Analyzer is meeting its published specifications, do the performance tests every 12 months.

Recommended Test Equipment

The equipment needed for operation verification and performance tests is listed on page 1-17. Other equipment may be substituted for the recommended model if it meets or exceeds the listed critical specifications.

Also, if you want the test record to be automatically printed, you need an GPIB printer. If you want the printer to automatically leave top and bottom margins on every page, enable perforation skip mode (see your printer's manual for directions). If you do not have an GPIB printer you must record the results of each test in the test records. These test records may be reproduced without written permission of Agilent Technologies.

Program Controlled Test Equipment

This program automatically controls the instruments listed in the following table using GPIB commands. If you use a test instrument other than those shown in the table, the program prompts you to set the instrument state during testing.

Test Equipment	Program Controlled Model
AC Calibrator	Fluke 5700A Alternate Fluke 5200A Datron 4200, 4707, 4708
Frequency Synthesizer	HP 3326A Alternate (2) HP 3325A/B
Digital Multimeter	HP 3458A Alternate HP 3455A HP 3456A HP 3478A

Measurement Uncertainty

A table starting on page 3-54 lists the measurement uncertainty and ratio for each performance test using the recommended test equipment. Except for the External Trigger test, the ratios listed for the recommended test equipment meet or exceed the measurement uncertainty ratio required by U.S. MIL-STD-45662A. The table also provides a place to record the measurement uncertainty and ratio for each performance test using equipment other than the recommended test equipment. The table may be reproduced without written permission of Agilent Technologies.

Operation Verification and Performance Tests

The operation verification tests give a high confidence level (>90%) that the Agilent 35670A Dynamic Signal Analyzer is operating properly and within specifications. The operation verification tests are a subset of the performance tests. The operation verification tests should be used for incoming and after-repair inspections. The performance tests provide the highest level of confidence and are used to verify that the Agilent 35670A Dynamic Signal Analyzer conforms to its published specifications. Some repairs require a performance test to be done after the repair (see chapter 6, "Replacing Assemblies" in the *Agilent 35670A Service Guide* for this information). The following table lists the operation verification and performance tests.

Operation Verification Tests	Performance Tests
Self Test	Self Test
DC Offset	DC Offset
Noise	Noise
Spurious Signals	Spurious Signals
Amplitude Accuracy	Amplitude Accuracy
Flatness	Flatness
Amplitude Linearity	Amplitude Linearity
A-Weight Filter	A-Weight Filter
Channel Match	Channel Match
Frequency Accuracy	Frequency Accuracy
Single Channel Phase Accuracy	Anti-Alias Filter
ICP Supply	Input Coupling
Source Amplitude Accuracy	Harmonic Distortion
Source Flatness	Intermodulation Distortion
Source Distortion	Cross Talk
	Single Channel Phase Accuracy
	External Trigger
	Input Resistance
	ICP Supply
	Source Amplitude Accuracy
	Source Output Resistance
	Source DC Offset
	Source Flatness
	Source Distortion

Specifications and Performance Tests

The following table lists specifications and the performance test or tests that verify each specification.

Specification	Performance Test
Frequency Accuracy	Frequency Accuracy
Single Channel Amplitude	
Residual dc response	DC Offset
FFT full scale accuracy at 1 kHz	Amplitude Accuracy
FFT full scale flatness	Flatness
FFT amplitude linearity at 1 kHz	Amplitude Linearity
FFT Dynamic Range	
Frequency alias responses	Anti-Alias Filter
Harmonic distortion	Harmonic Distortion
Intermodulation distortion	Intermodulation Distortion
Spurious and residual responses	Spurious Signals
Input Noise	Noise
Single Channel Phase	Single Channel Phase Accuracy
Cross Channel Amplitude	Channel Match
Cross Channel Phase	Channel Match
Input	
ac coupling rolloff	Input Coupling
Cross talk	Cross Talk
Input impedance	Input Resistance
ICP signal conditioning	ICP Supply
A-weight filter	A-Weight Filter
Trigger	
External trigger	External Trigger
Source Output	
Sine flatness	Source Flatness
Harmonic and sub-harmonic distortion	Source Distortion
Sine amplitude accuracy at 1 kHz	Source Amplitude Accuracy
Resistance	Source Output Resistance
dc offset accuracy	Source DC Offset

To load the program

For information about the program's softkeys, see the menu descriptions starting on page 3-49.

- 1** Set the Agilent 35670A Dynamic Signal Analyzer's power switch to off (O), then connect the analyzer, test instruments, and printer using GPIB cables.
- 2** If you have the PC Style Keyboard, option 1CL, connect the keyboard to the analyzer using the keyboard cable (see "To connect the optional keyboard" in chapter 2).
- 3** Insert the *Semiautomated Performance Test Disk* into the analyzer's disk drive, then set the power switch to on (I).
- 4** After the analyzer finishes its power-up calibration routine, press the following keys:
 - [**Local/GPIB**]
 - [SYSTEM CONTROLLR]
 - [**System Utility**]
 - [MEMORY USAGE]
 - [REMOVE WATERFALL]
 - [CONFIRM REMOVE]
 - [RETURN]
 - [MORE]
 - [SERVICE TESTS]
 - [PERFRMANC TEST]
- 5** Now go to one of the following procedures to continue:
 - "To run the program in semiautomated mode"
 - "To run the program without a printer"
 - "To run the program in manual mode"

To run the program in semiautomated mode

You must have an GPIB printer connected to your system to run the program in semiautomated mode. If you do not have a printer, see "To run the program without a printer" later in this chapter.

- 1 Press the following keys and when the program prompts you, type in the information for the title page of the test record and press [ENTER]:

[TITLE PAGE]
[TEST FACILITY]
[FACILITY ADDRESS]
[TESTED BY]
[REPORT NUMBER]
[CUSTOMER]
[MORE]
[TEMP]
[HUMIDITY]
[LINE FREQUENCY]
[RETURN]

- 2 Press the following keys and when the program prompts you, type in the equipment configuration information:

[EQUIP CONFIG]
[AC CALIBRATO]
[SYNTH. 1]
[SYNTH. 2] (If needed)
[LOW-D OSCILLATO] (If needed)
[MULTIMETER]
[RETURN]

The GPIB address is $100 \times (\text{interface select code}) + (\text{primary address})$. The interface select code for the test equipment and printer is 7 (for example, if the primary address is 8, the GPIB address is 708).

When entering the calibration due date, only four characters are displayed on the screen. However, you can enter up to nine characters and they will be printed.

3 Press the following keys and type in the printer address when the program prompts you:

[TEST CONFIG]
[PRINTER ADDRESS]
[PROCEDURE]
[OP_VERIFY] or [PERFORMAN]
[STOP AFTER]
[LIMIT FAILURE] or [NONE]
[RETURN]

4 Press the following keys to start the test:

[START TESTING]
[START BEGINNING]

When you select [START BEGINNING], the data is written to a file on the disk and printed only after all tests are done. When you select [START MIDDLE] or [ONE TEST], the data is printed immediately after each measurement.

5 Follow the directions on the display.

Warning

During the test, the program prompts you to change the test equipment connections. Always turn the ac calibrator output to OFF or STANDBY before changing test equipment connections. The ac calibrator can produce output voltages that could result in injury or death to personnel.

The directions on the display briefly tell you how to connect test equipment. For detailed illustrations of equipment setup, see the setup illustrations starting on page 3-13.

If you want to pause the program and return the Agilent 35670A Dynamic Signal Analyzer to front panel control, press [BASIC]. To continue the program, press [BASIC] [DISPLAY SETUP] [LOWER] [RETURN] [CONTINUE]. If you changed any instrument setup states, press [RESTART TEST] instead of [CONTINUE] to ensure accurate measurement results.

To run the program without a printer

Use this procedure if you do not have an GPIB printer connected to your system.

- 1** Write in the information needed on the title page of the selected test record.

The test records are located near the back of this chapter and may be copied without written permission of Agilent Technologies.

- 2** Press the following keys and when the program prompts you, type in the model number and GPIB address:

[EQUIP CONFIG]
[AC CALIBRATO]
[SYNTH. 1]
[SYNTH. 2] (If needed)
[LOW-D OSCILLATO] (If needed)
[MULTIMETER]
[RETURN]

The GPIB address equals $100 \times (\text{interface select code}) + (\text{primary address})$. The interface select code for the test equipment is 7 (for example, if the primary address is 8, the GPIB address is 708).

- 3** Press the following keys:

[TEST CONFIG]
[PROCEDURE]
[OP_VERIFY] or [PERFORMAN]
[STOP AFTER]
[EACH MEASUREMENT]
[RETURN]

- 4** Press the following keys to start the test:

[START TESTING]
[START BEGINNING]

- 5** Now follow the directions on the display and record every measurement result in the selected test record.

Warning

During the test, the program prompts you to change the test equipment connections. Always turn the ac calibrator output to OFF or STANDBY before changing test equipment connections. The ac calibrator can produce output voltages that could result in injury or death to personnel.

The directions on the display briefly tell you how to connect test equipment. For detailed illustrations of equipment setup, see the setup illustrations starting on page 3-13.

If you want to pause the program and return the Agilent 35670A Dynamic Signal Analyzer to front panel control, press [**BASIC**]. To continue the program, press [**BASIC**] [**DISPLAY SETUP**] [**LOWER**] [**RETURN**] [**CONTINUE**]. If you changed any instrument setup states, press [**RESTART TEST**] instead of [**CONTINUE**] to ensure accurate measurement results.

To run the program in manual mode

Use this procedure if you want to run the program in manual mode. You will be prompted to set up all test equipment and you can check the analyzer's setup state after each measurement.

- 1 Write in the information needed on the title page of the selected test record.

The test records are located near the back of this chapter and may be copied without written permission of Agilent Technologies.

- 2 Press the following keys and when the program prompts you, set all GPIB addresses to 0:

[EQUIP CONFIG]
[AC CALIBRATO]
[SYNTH. 1]
[SYNTH. 2] (If needed)
[LOW-D OSCILLATO] (If needed)
[MULTIMETER]
[RETURN]

- 3 Press the following keys:

[TEST CONFIG]
[PROCEDURE]
[OP_VERIFY] or [PERFORMAN]
[STOP AFTER]
[EACH MEASUREMENT]
[RETURN]

- 4 Press the following keys to start the test:

[START TESTING]
[START BEGINNING]

- 5 Now follow the directions on the display and record the measurement result in the selected test record after every measurement.

If you want to view the analyzer's setup state, press [BASIC] [**Disp Format**] [MEASURMNT STATE] or [INPUT STATE]. To continue the program, press [BASIC] [DISPLAY SETUP] [LOWER] [RETURN] [CONTINUE]. If you changed any instrument setup states, press [RESTART TEST] instead of [CONTINUE] to ensure accurate measurement results.

Warning

During the test, the program prompts you to change the test equipment connections. Always turn the ac calibrator output to OFF or STANDBY before changing test equipment connections. The ac calibrator can produce output voltages that could result in injury or death to personnel.

The directions on the display briefly tell you how to connect test equipment. For detailed illustrations of equipment setup, see the setup illustrations starting on the next page.

To set up the self test

Performance Test and Operation Verification

This test checks the measurement hardware in the Agilent 35670A. No performance tests should be attempted until the analyzer passes this test. This test takes approximately one minute to complete, and requires no external equipment.

1

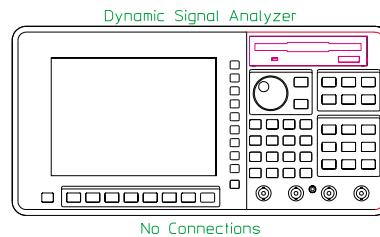

To set up the dc offset test

Performance Test and Operation Verification

This test verifies that the Agilent 35670A meets its single channel amplitude specification for residual dc responses. In this test, the Agilent 35670A measures its internal residual dc offset at two amplitudes.

1 2 ch

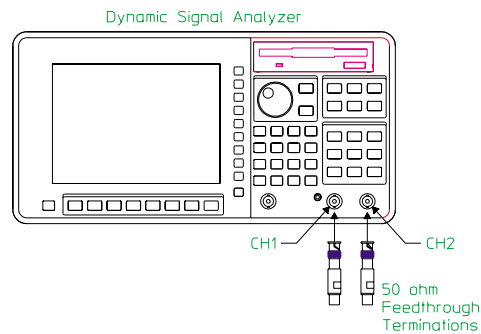

1 4 ch

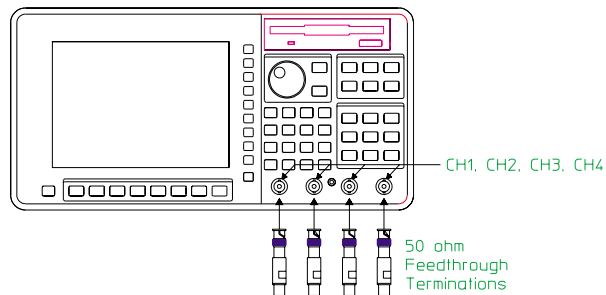

To set up the noise test

Performance Test and Operation Verification

This test verifies that the Agilent 35670A meets its input noise specification. In this test, the Agilent 35670A measures its internal noise level.

1 2 ch

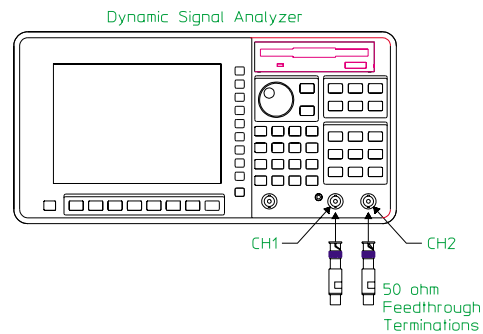

1 4 ch

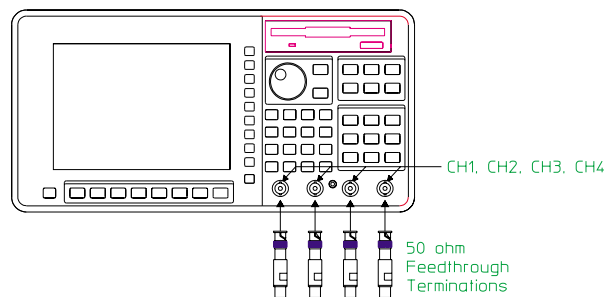

To set up the spurious signals test

Performance Test and Operation Verification

This test verifies that the Agilent 35670A meets its FFT dynamic range specification for spurious and residual responses. In this test, the Agilent 35670A measures its internal spurious signals. The test records at the end of this chapter list the frequencies that are checked.

1 2 ch

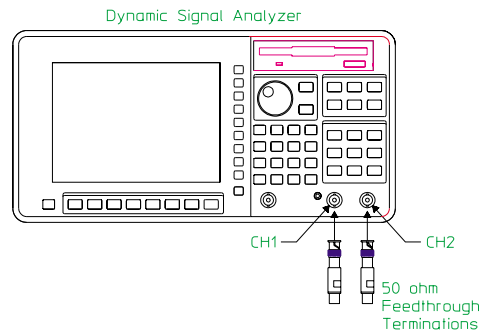

1 4 ch

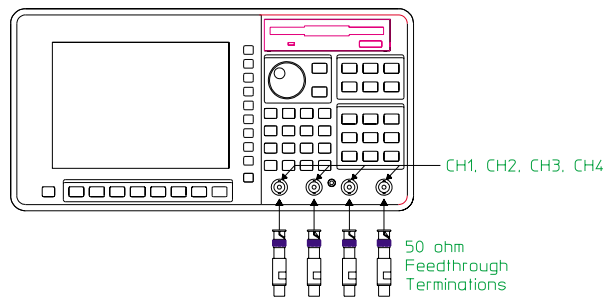

To set up the amplitude accuracy test

Performance Test and Operation Verification

This test verifies that the Agilent 35670A meets its single channel amplitude specification for FFT full scale accuracy at 1 kHz. In this test, an ac calibrator outputs a 1 kHz signal with an exact amplitude to all channels. This test checks amplitude accuracy at 27, 19, 9, 1, -11, -27, -35, -43, and -51 dBVrms.

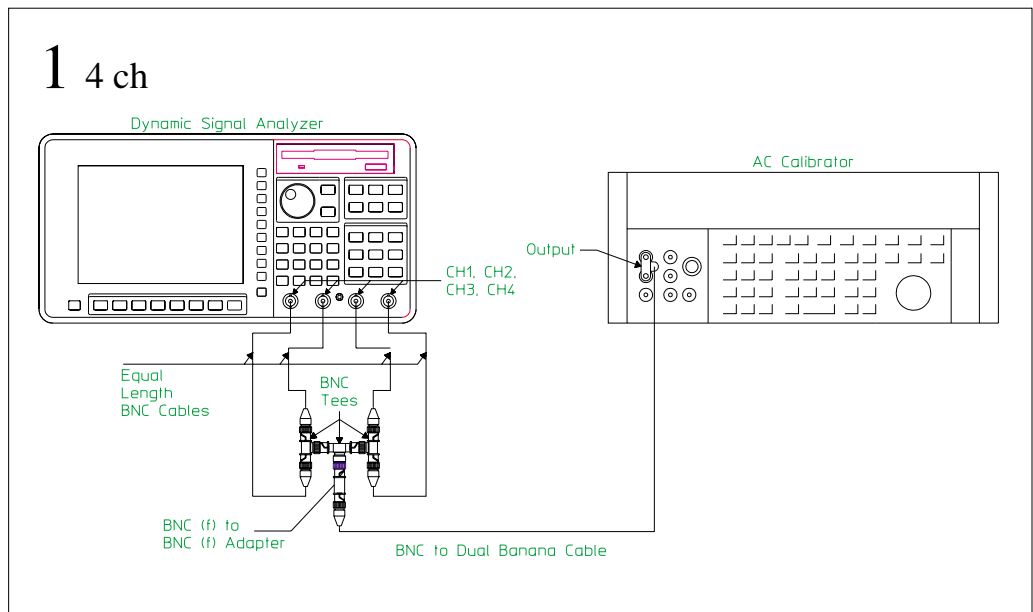
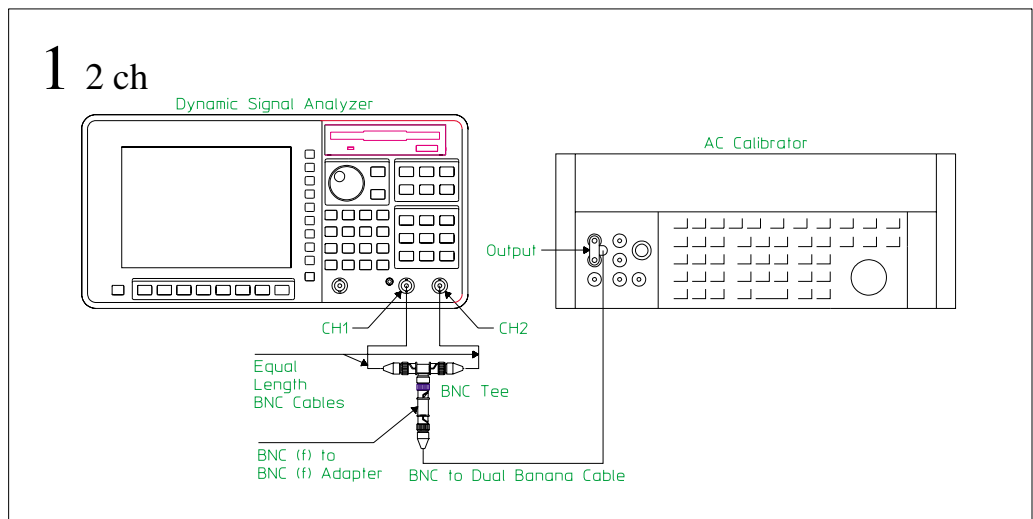

To set up the flatness test

Performance Test and Operation Verification

This test verifies that the Agilent 35670A meets its single channel amplitude specification for FFT full scale flatness relative to 1 kHz. In this test, the ac calibrator outputs a signal with an exact amplitude to all channels. The test records at the end of this chapter list the amplitudes and frequencies that are checked.

1 2 ch

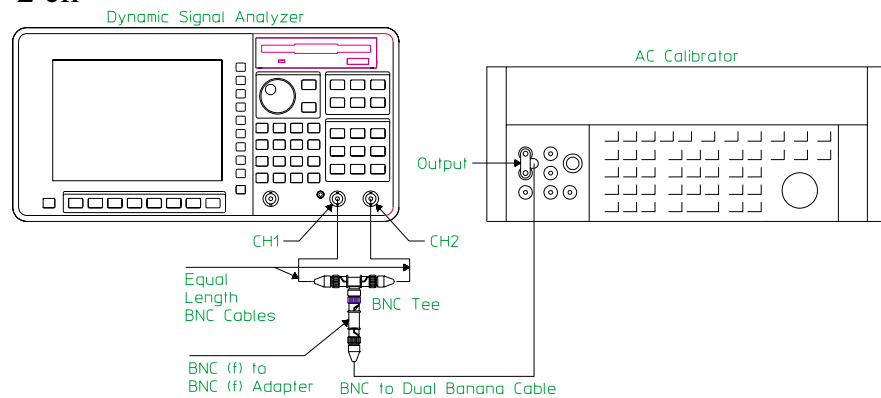

1 4 ch

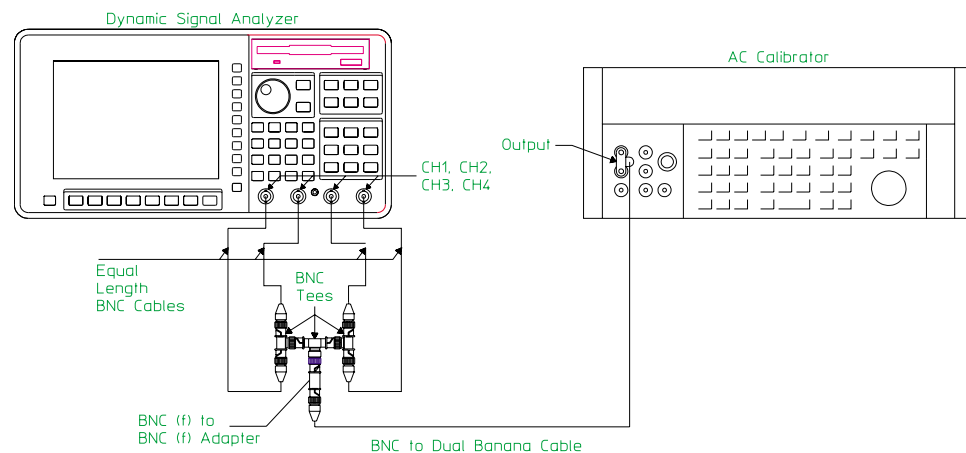

To set up the amplitude linearity test

Performance Test and Operation Verification

This test verifies that the Agilent 35670A meets its single channel amplitude specification for FFT amplitude linearity at 1 kHz. In this test, the ac calibrator outputs a 1 kHz signal with an exact amplitude to all channels. This test checks amplitude linearity at 27, 13, -1, -15, -29, -43, and -53 dBVrms.

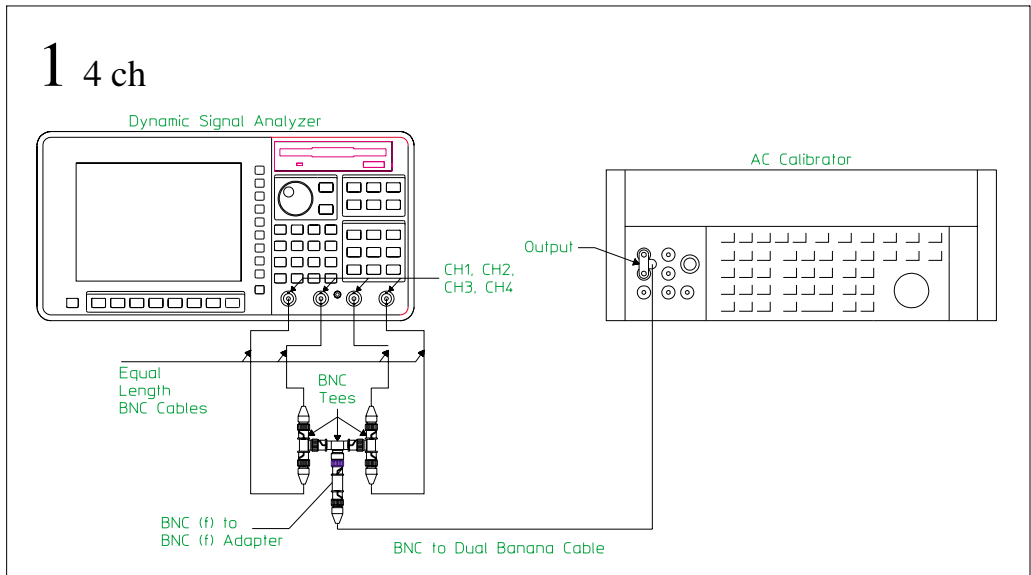
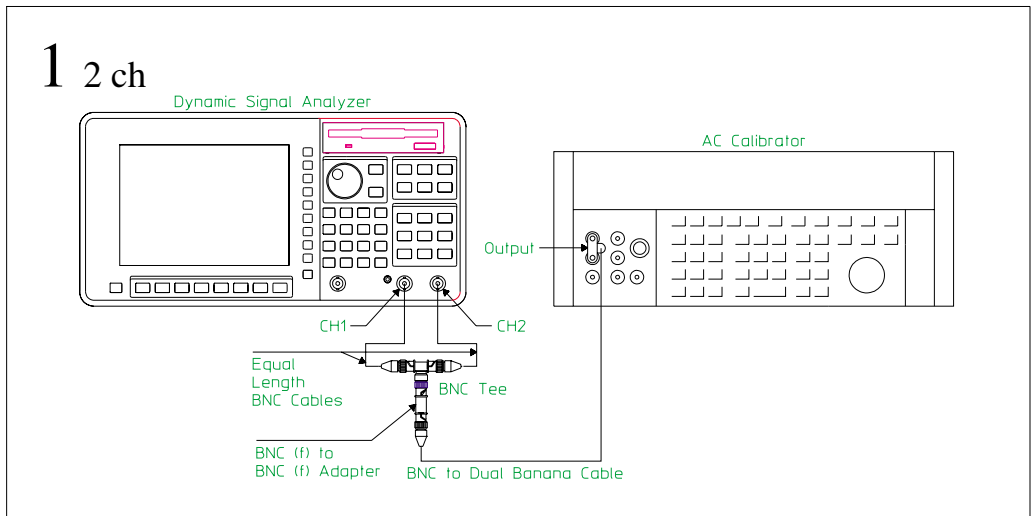

To set up the A-weight filter test

Performance Test and Operation Verification

This test verifies that the Agilent 35670A meets its input specification for A-weight filter. In this test, an ac calibrator outputs a 1 dBVrms signal with an exact amplitude to all channels. The test records at the end of this chapter list the frequencies that are checked.

1 2 ch

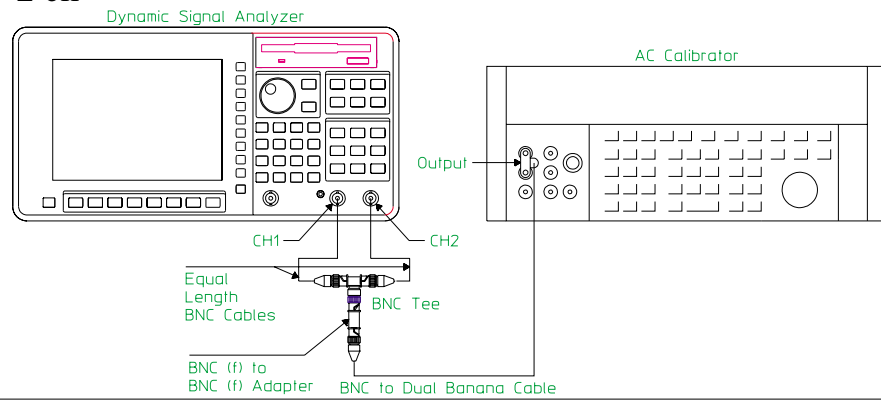

1 4 ch

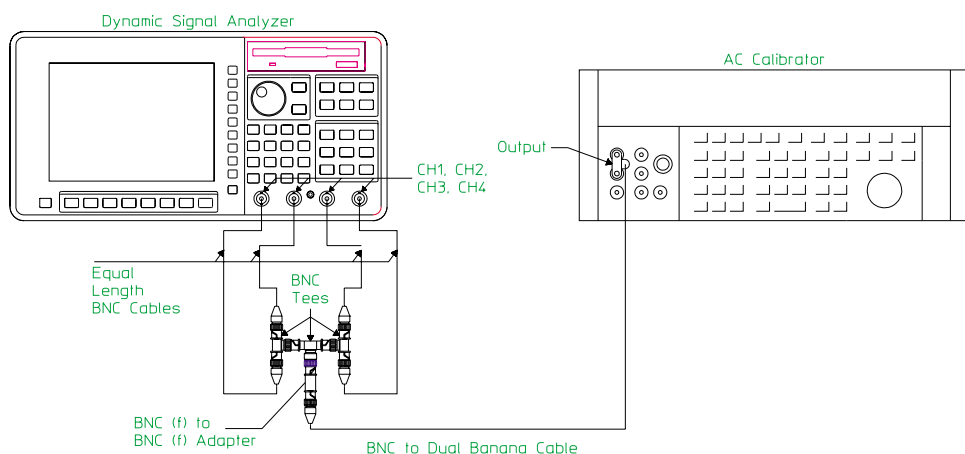

To set up the channel match test

Performance Test and Operation Verification

This test verifies that the Agilent 35670A meets its cross channel amplitude and cross channel phase specification. In this test, the Agilent 35670A's source outputs an identical signal to all channels. The Agilent 35670A measures the amplitude and phase of the signal and compares the values measured on one channel to the values measured on another channel.

1 2 ch

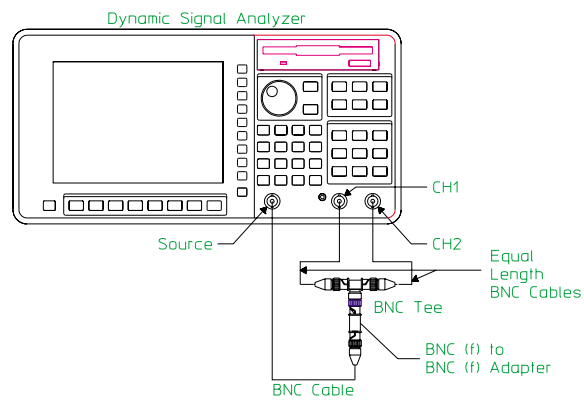

1 4 ch

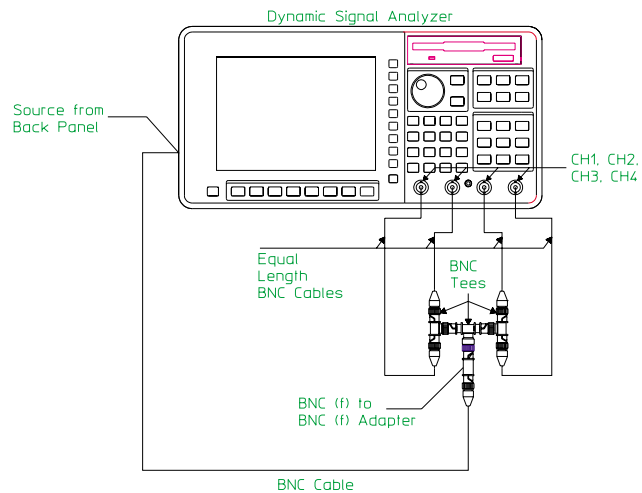

To set up the frequency accuracy test

Performance Test and Operation Verification

This test verifies that the Agilent 35670A meets its frequency accuracy specification. In this test, the analyzer measures the frequency of an accurate 50 kHz signal.

1 2 ch

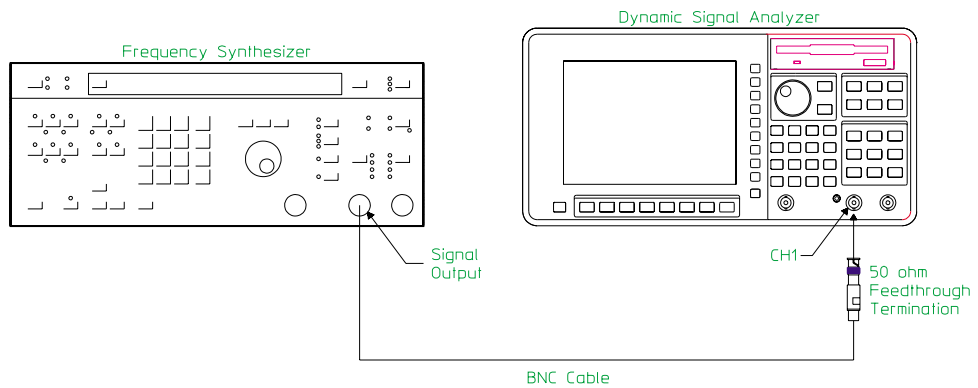

1 4 ch

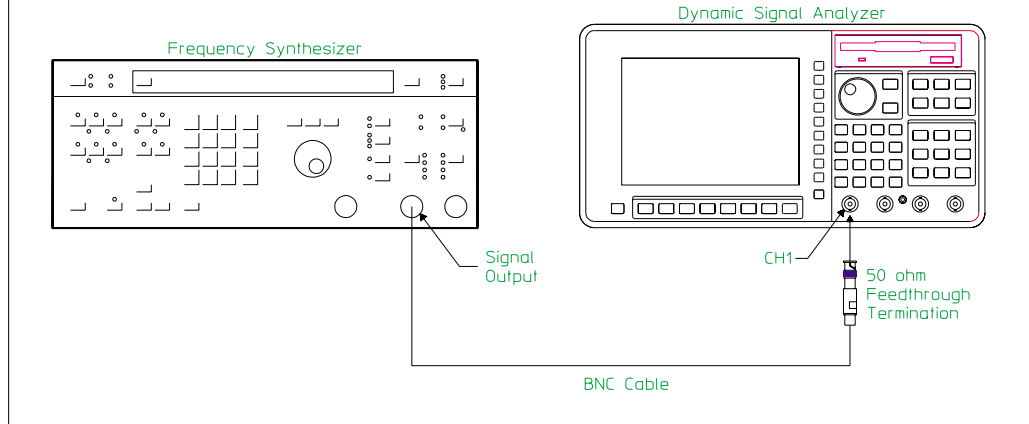

To set up the anti-alias filter test

Performance Test only

This test verifies that the Agilent 35670A meets its FFT dynamic range specification for frequency alias responses. In this test, a frequency synthesizer outputs a -9 dBVrms signal known to cause an alias frequency to all channels. The Agilent 35670A then measures the alias frequency to determine how well the alias frequency was rejected. The test records at the end of this chapter list the frequencies that are checked.

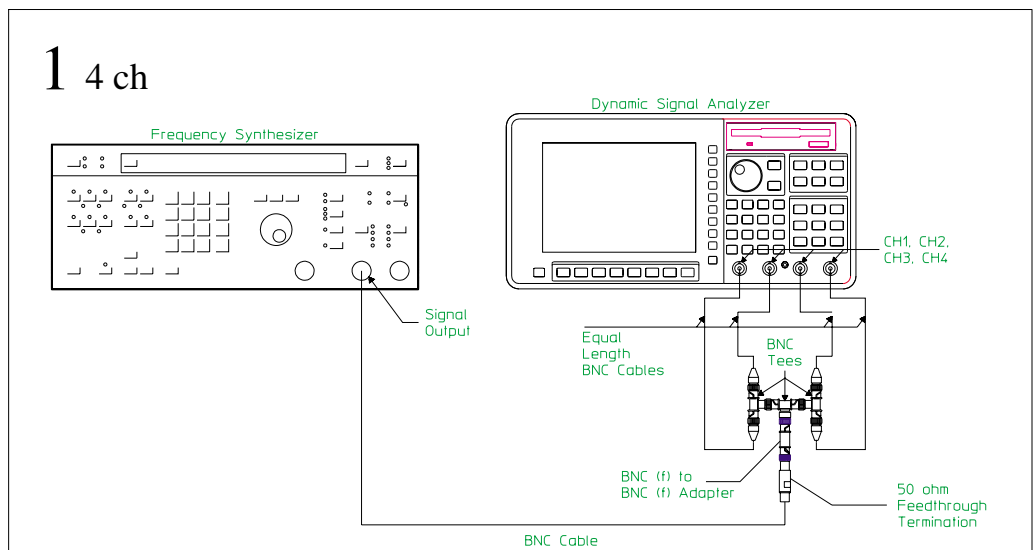
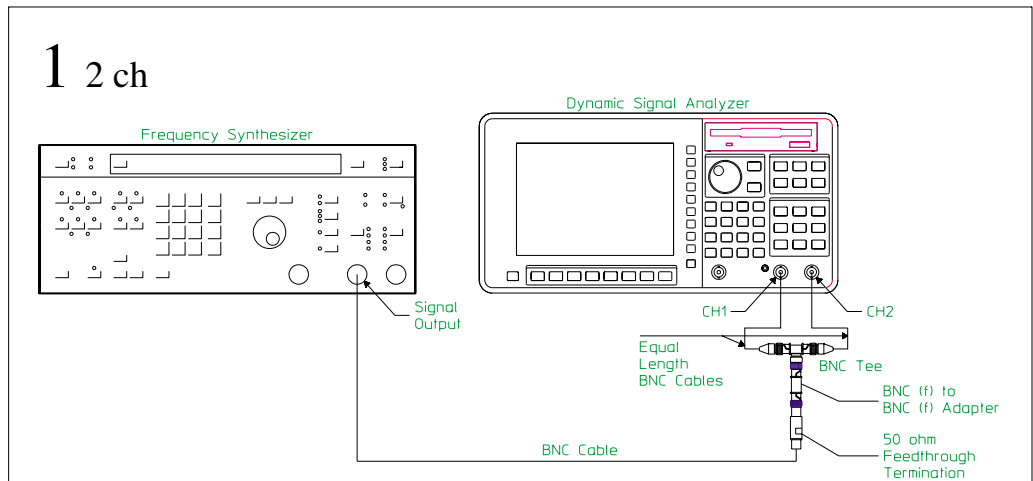

To set up the input coupling test

Performance Test only

This test verifies that the Agilent 35670A meets its input specification for ac coupling rolloff. In this test, a frequency synthesizer outputs a 1 Hz signal to all channels. The signal is measured in both ac and dc coupled modes. The value measured in ac coupled mode is subtracted from the value measured in dc coupled mode to determine the ac coupling rolloff.

1 2 ch

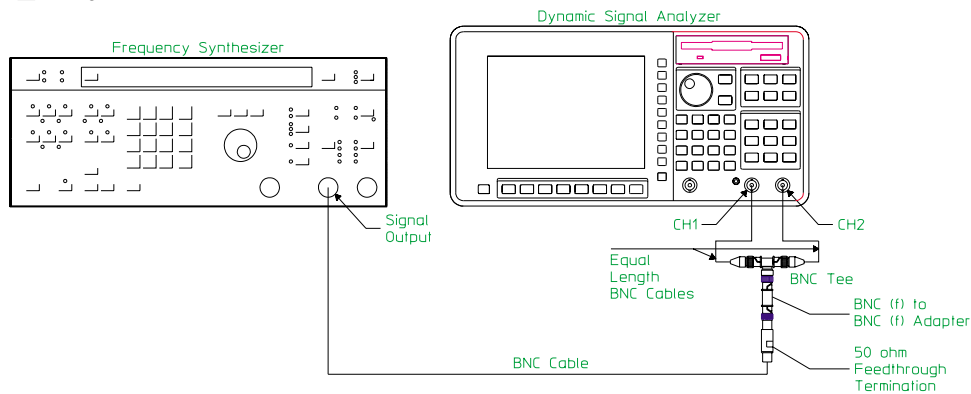

1 4 ch

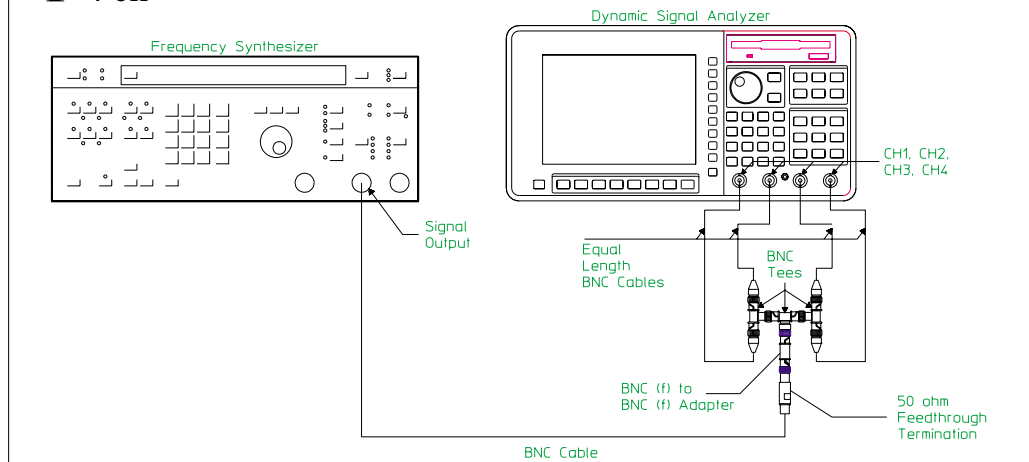

To set up the harmonic distortion test

Performance Test only

This test verifies that the Agilent 35670A meets its FFT dynamic range specification for harmonic distortion. In this test, a low distortion oscillator or a frequency synthesizer and 24.5kHz notch filter outputs a signal to all channels. The second, third, fourth, or fifth harmonic is then measured. If the harmonic falls outside the analyzer's frequency range, the analyzer measures the alias frequencies. The test records at the end of this chapter list the fundamental frequencies. If you are using the synthesizer and notch filter, the frequencies listed in the test record are approximate.

1 2 ch Using an HP 339A

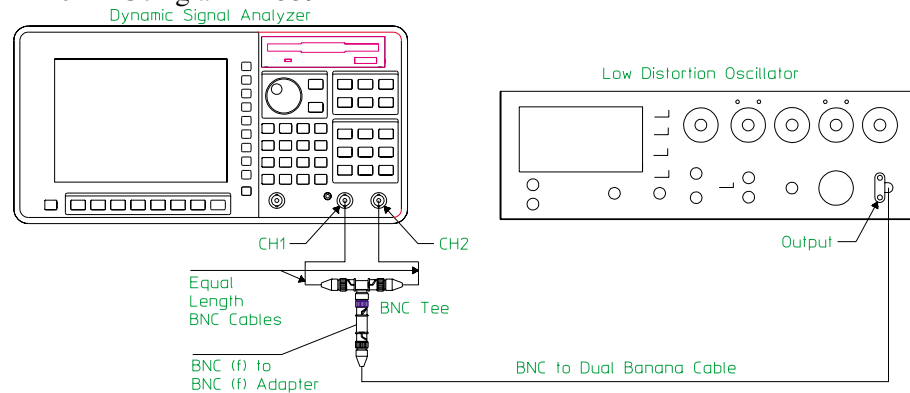

1 4 ch Using an HP 339A

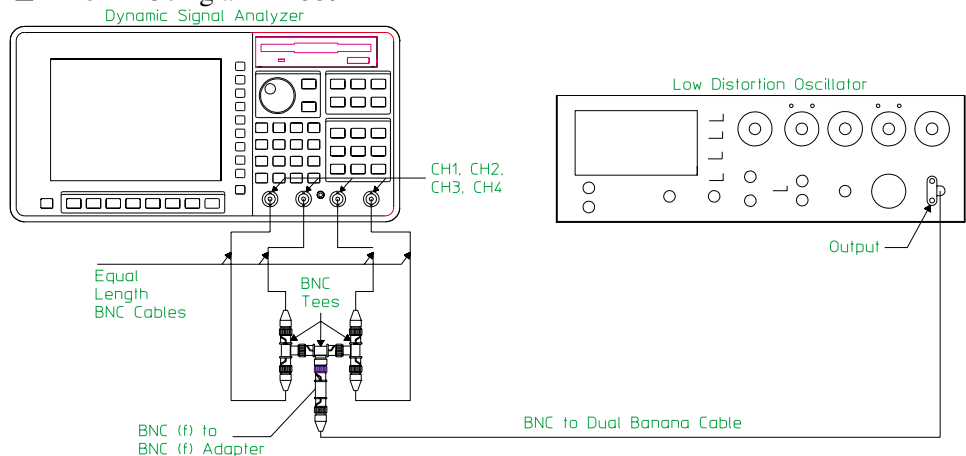

1A 2 ch Using a synthesizer and notch filter

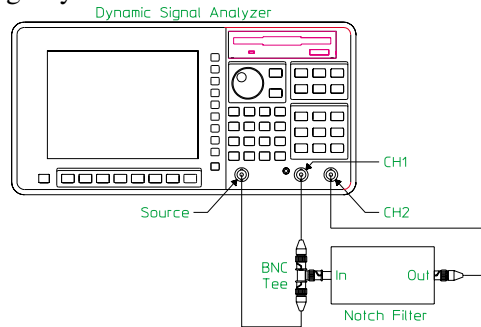

2A 2 ch Using a synthesizer and notch filter

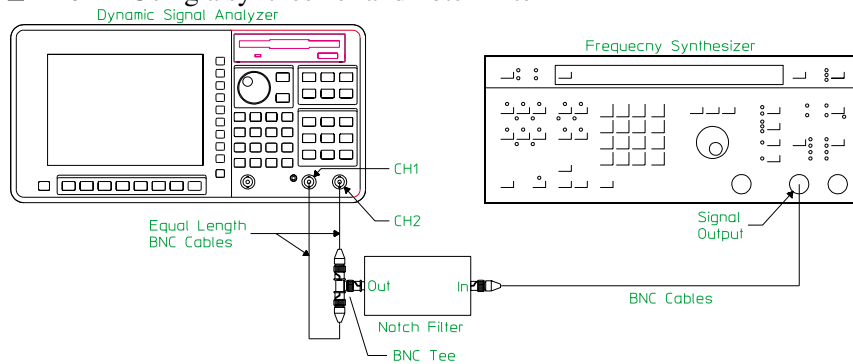

1A 4 ch Using a synthesizer and notch filter

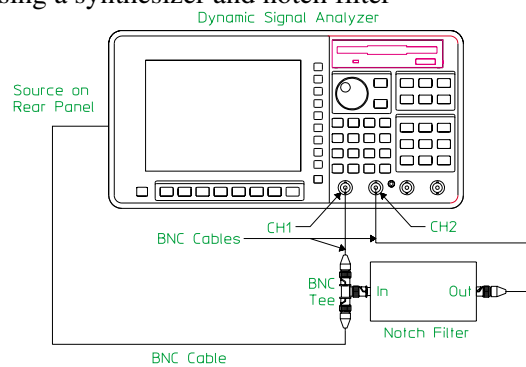

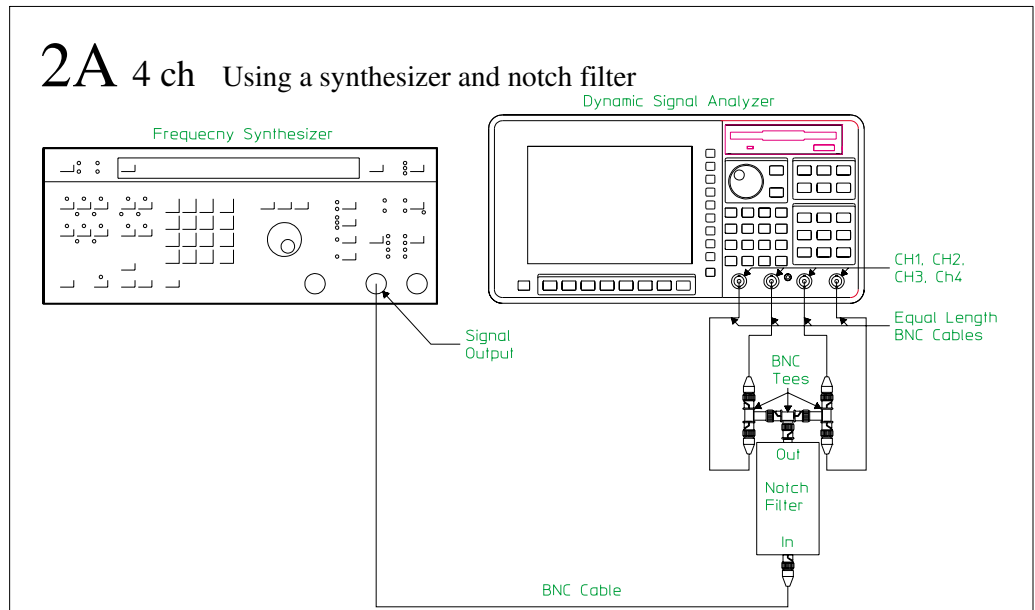

To set up the intermodulation distortion test

Performance Test only

This test verifies that the Agilent 35670A meets its FFT dynamic range specification for intermodulation distortion. In this test, two signals are combined to provide a composite signal to all channels. The intermodulation products are found at the sum ($F1 + F2$) and difference ($F1 - 2F2$) frequencies. The analyzer measures the amplitude of each intermodulation product.

1 2 ch Using an HP 3326A

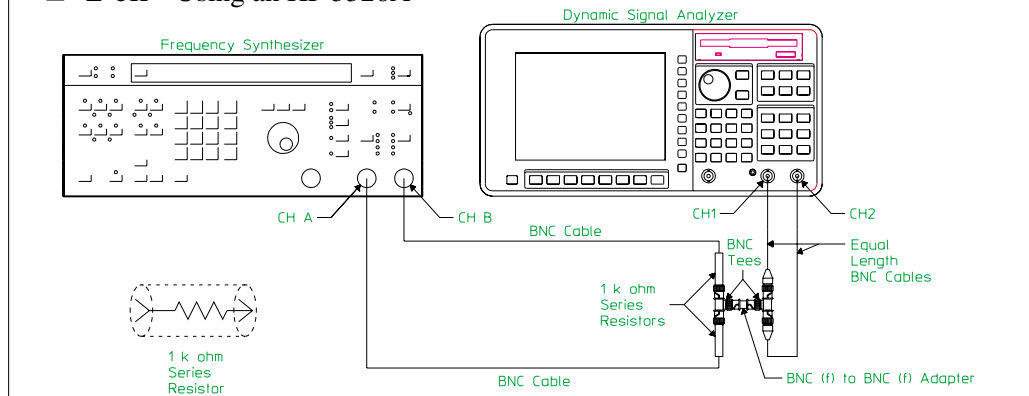

1 4 ch Using an HP 3326A

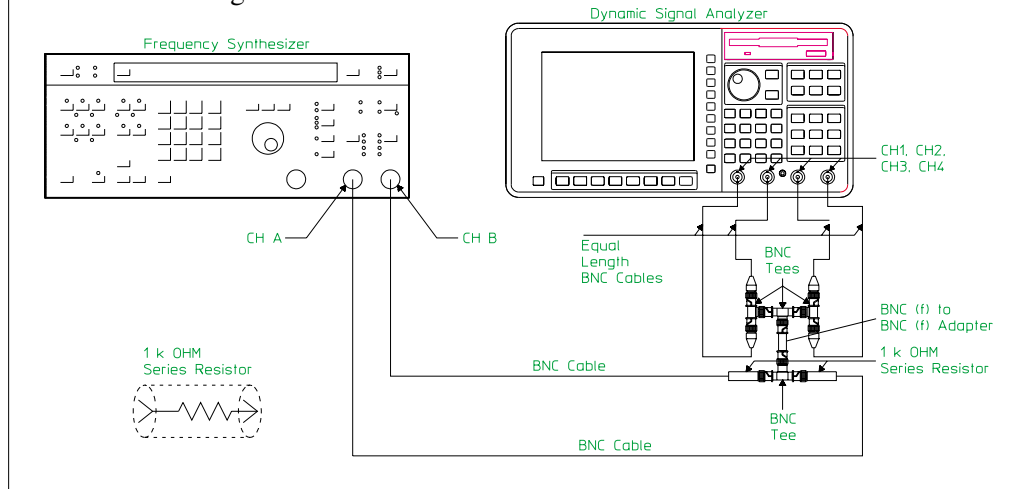

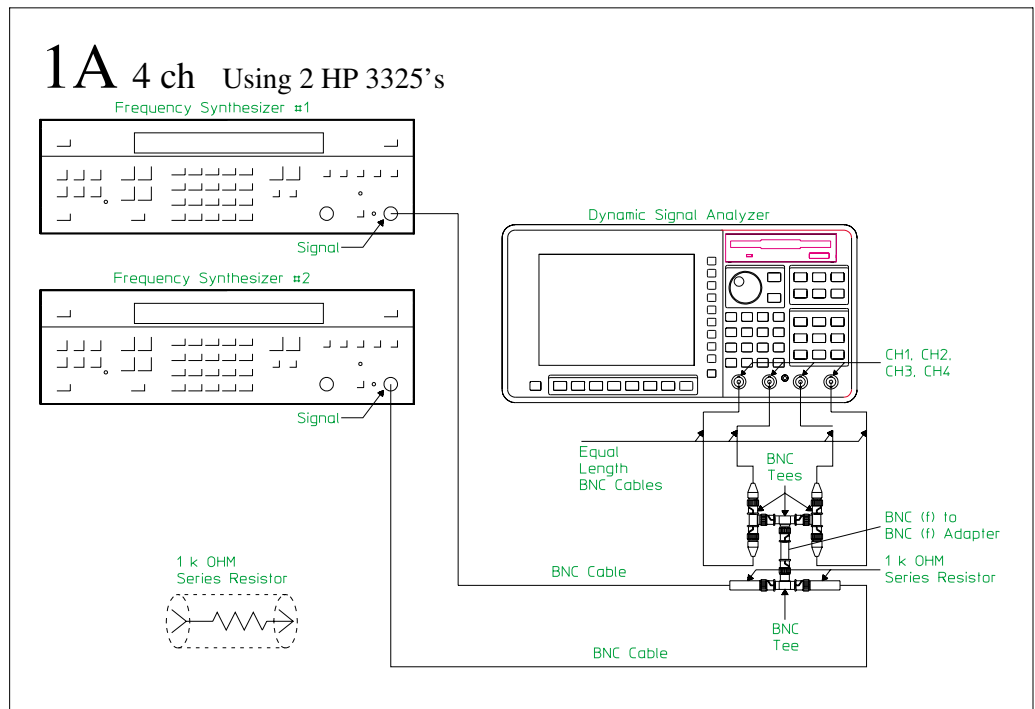
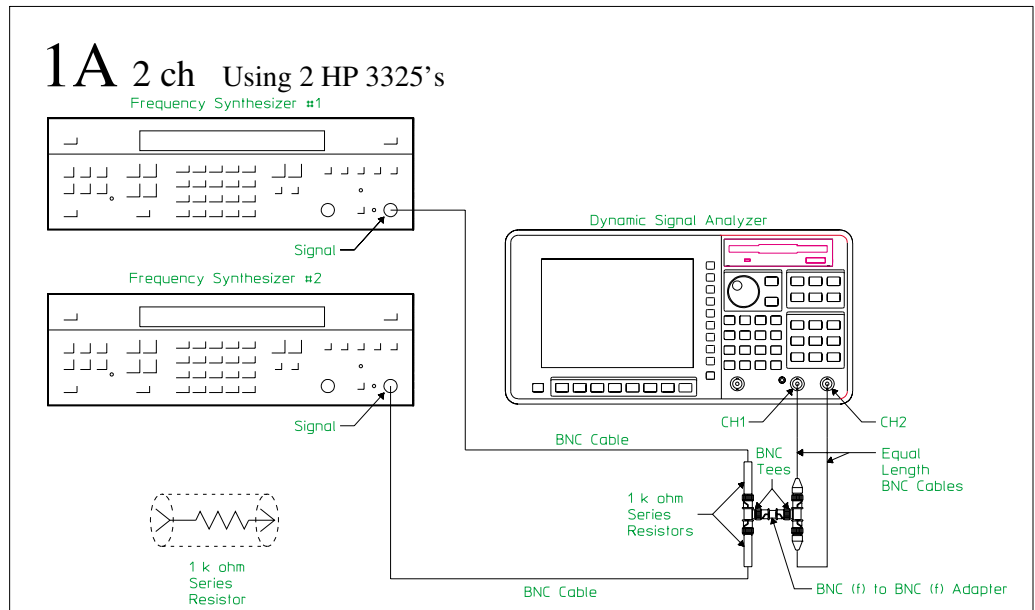

To set up the cross talk test

Performance Test only

This test verifies that the Agilent 35670A meets its input specification for channel-to-channel and channel-to-source cross talk. In this test, the Agilent 35670A measures the amount of energy induced from the source or input channel to another input channel. For source-to-channel crosstalk, the analyzer's source is set for 25.6kHz, 9 dBVrms and the signal level at the input channels is measured. For channel-to-channel crosstalk, the frequency synthesizer outputs a 25.6kHz or 51.2kHz, 9dBVrms signal to all but one input channel and the signal level at the unused input channel is measured.

1 2 ch

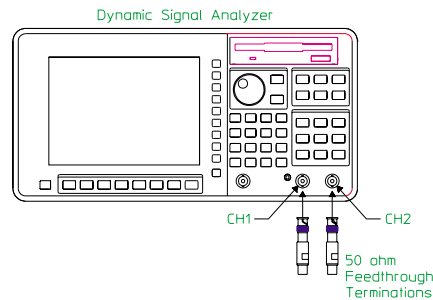

2 2 ch

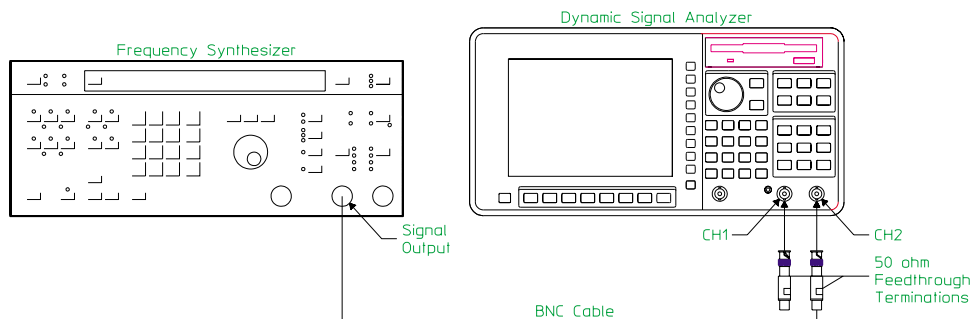

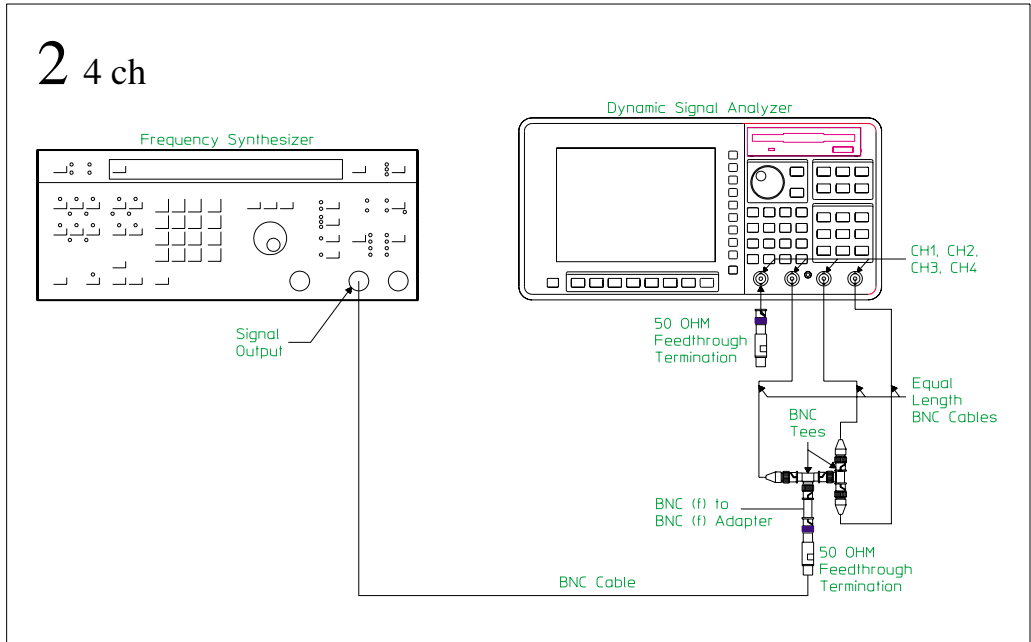
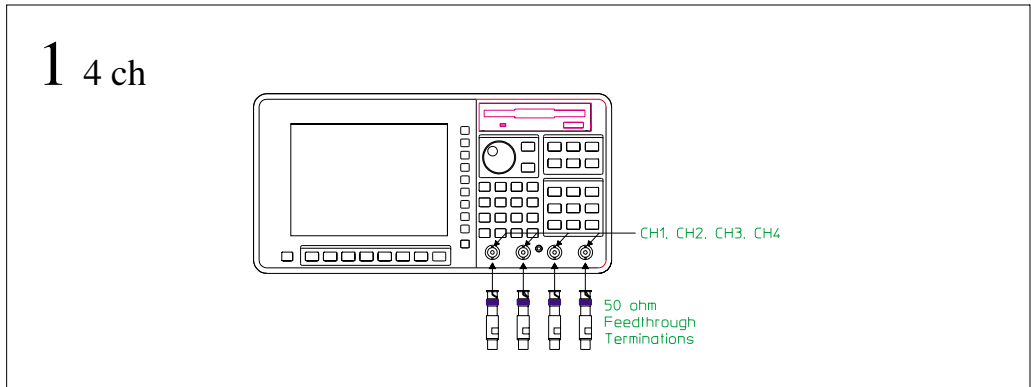
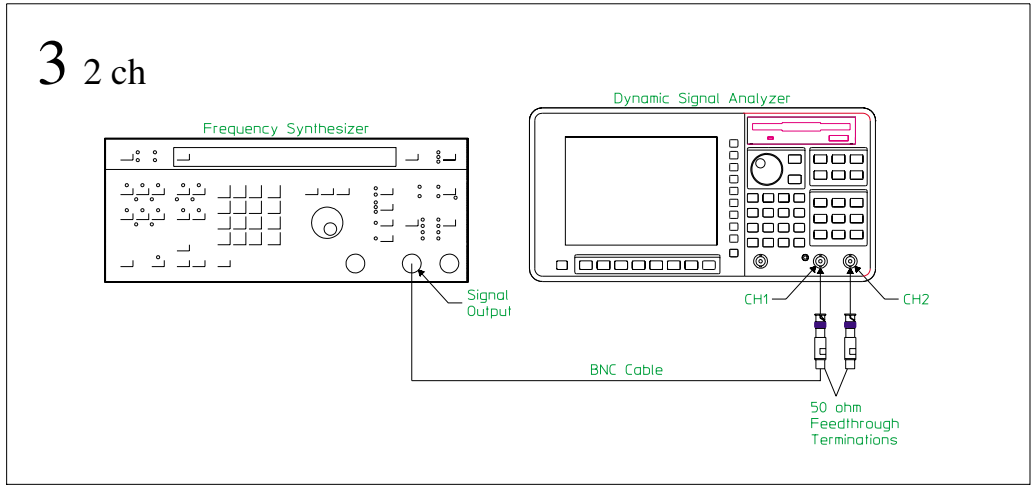

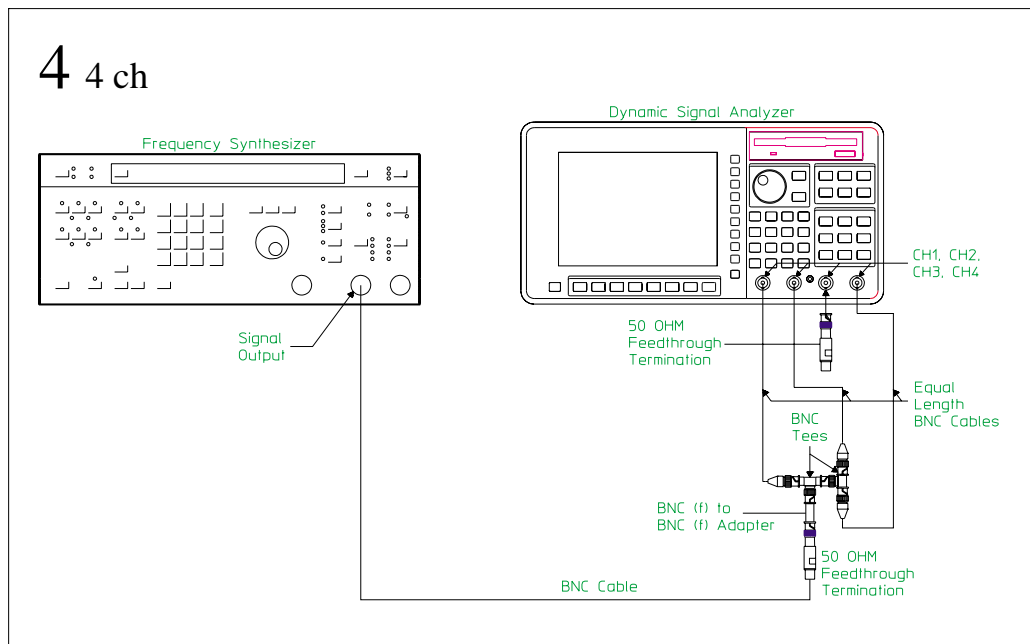
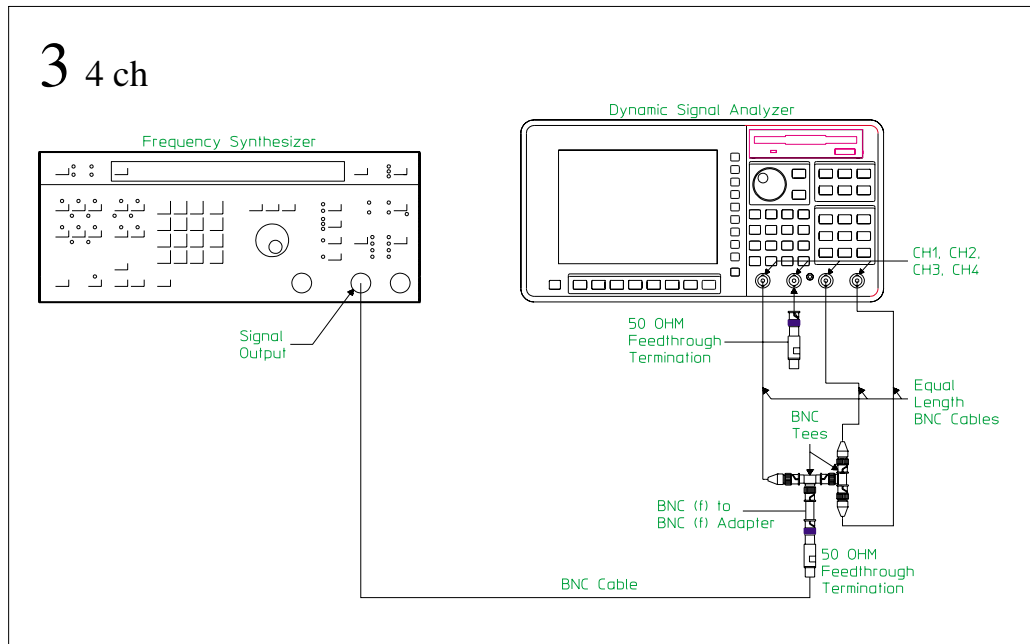

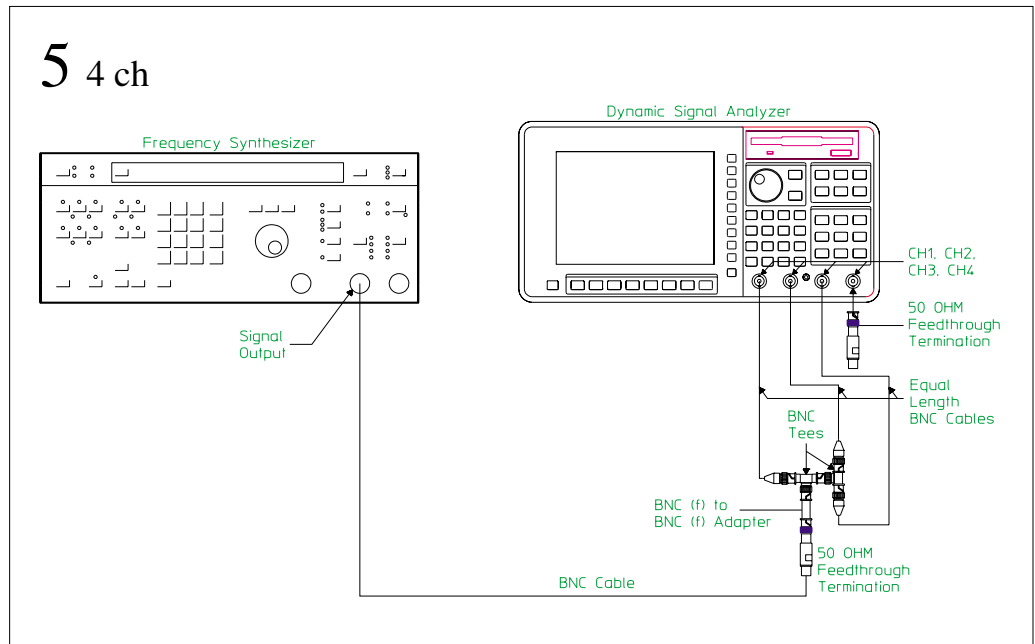

To set up the single channel phase accuracy test

Performance Test and Operation Verification

This test verifies that the Agilent 35670A meets its single channel phase accuracy specification. In this test, a frequency synthesizer outputs an identical square wave to all channels and a synchronized TTL-level signal to the trigger input. The phase difference between the trigger and each channel is measured to determine phase accuracy.

1 2 ch

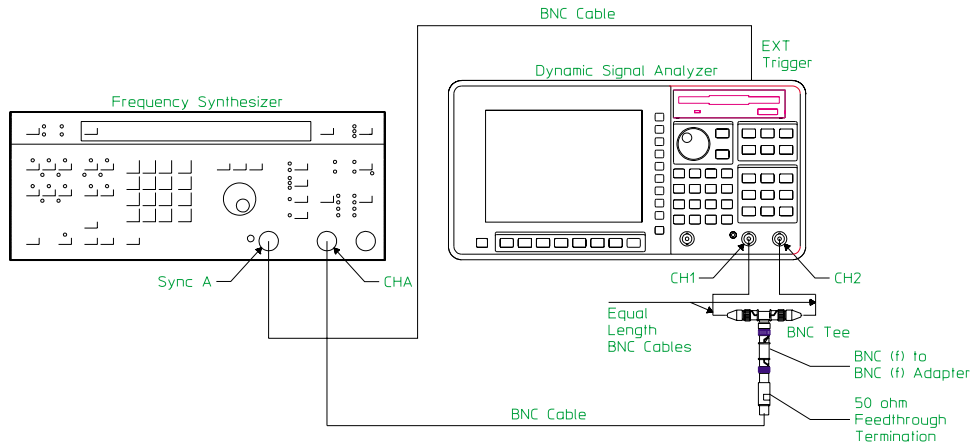

1 4 ch

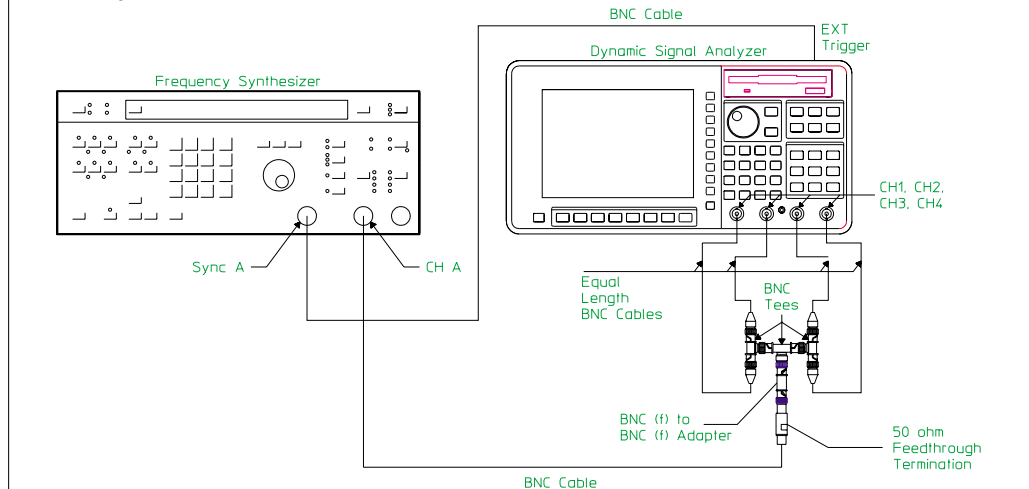

To set up the external trigger test

Performance Test only

This test verifies that the Agilent 35670A meets its trigger specification for external trigger level accuracy. In this test, a frequency synthesizer outputs a 1kHz signal to the external trigger input and a 12.8 kHz signal to channel 1. The analyzer makes an accurate triggered measurement on channel 1 to verify the trigger level and slope.

1 2 ch Using an HP 3326A

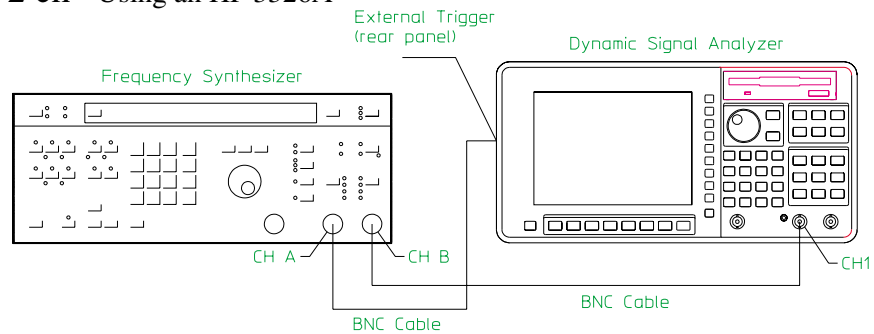

1 4 ch Using an HP 3326A

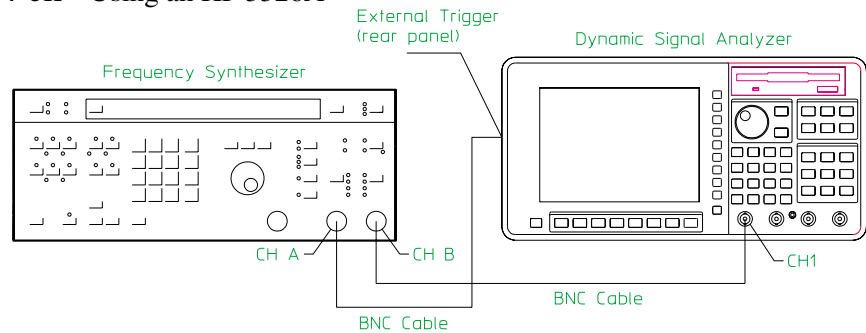

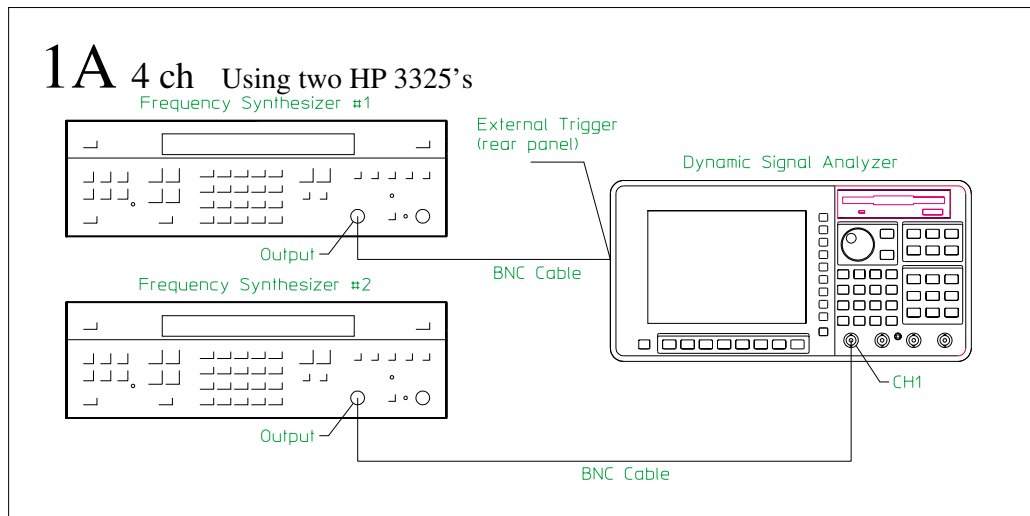
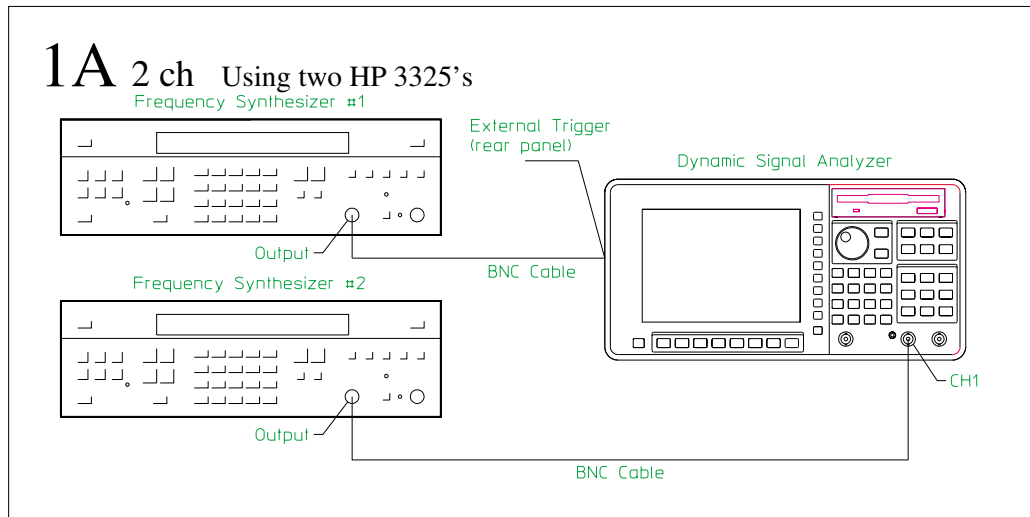

To set up the input resistance test

Performance Test only

This test verifies that the Agilent 35670A meets its input resistance specification. In this test, a digital multimeter directly measures the input resistance of each channel. The digital multimeter is set to the 1 M Ω range.

1 2 ch

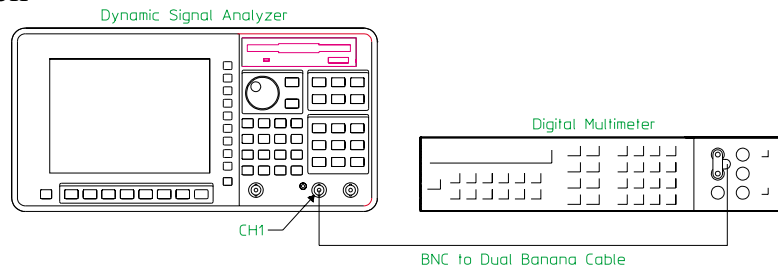

2 2 ch

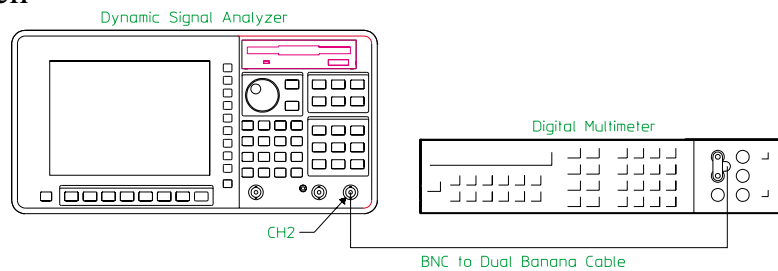

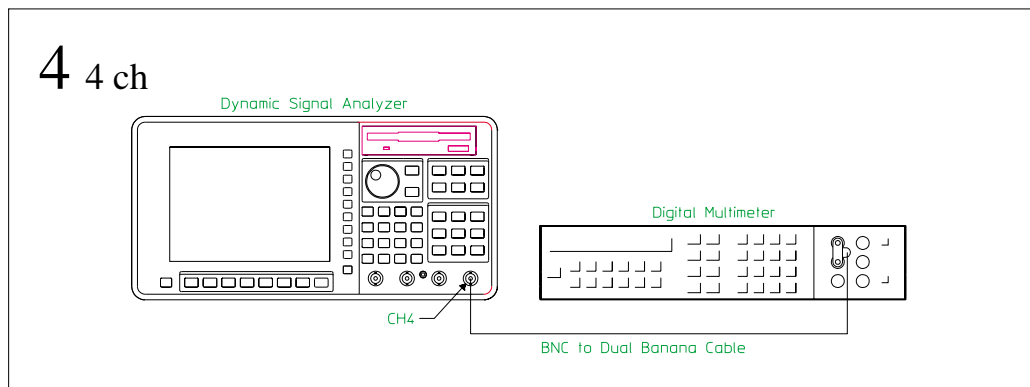
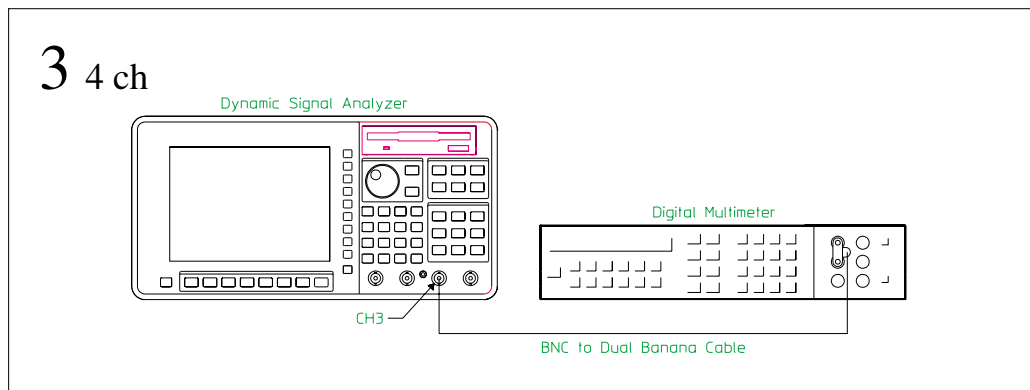
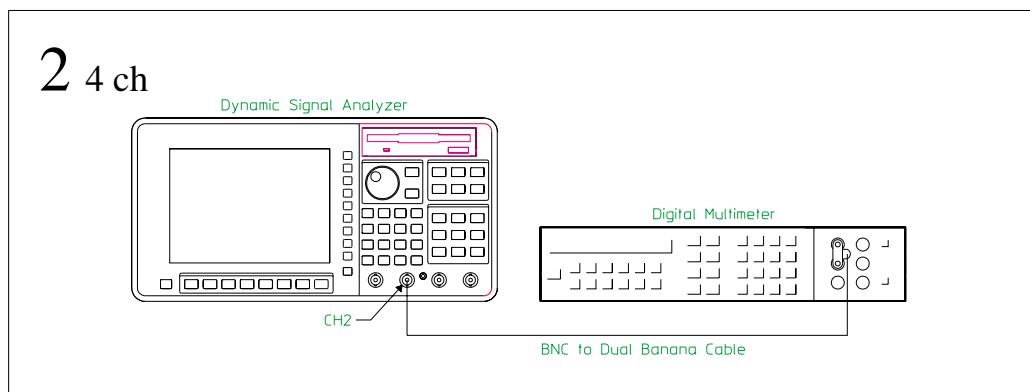
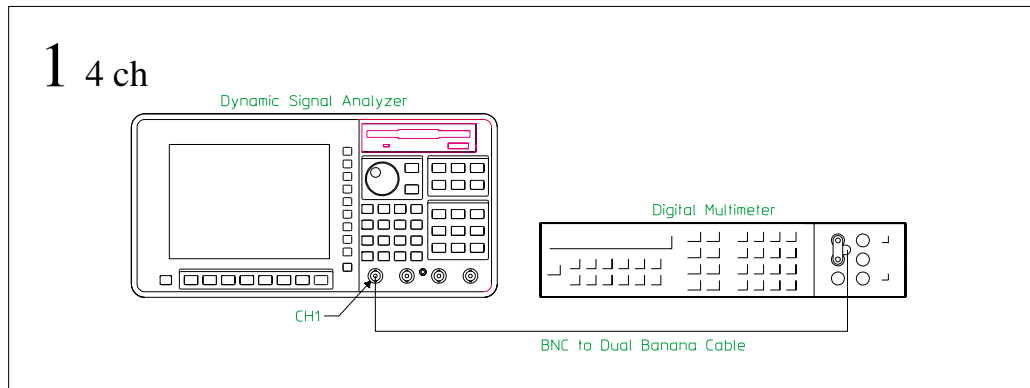

To set up the ICP supply test

Performance Test and Operation Verification

This test verifies that the Agilent 35670A meets its input specification for ICP signal conditioning. In this test, a digital multimeter directly measures the open circuit voltage of each channel. The digital multimeter measures the current source of each channel by measuring the voltage across a 50 Ω feedthrough termination. The digital multimeter is set to the 100 V range to measure open circuit voltage and set to the 1 V range to measure the current source.

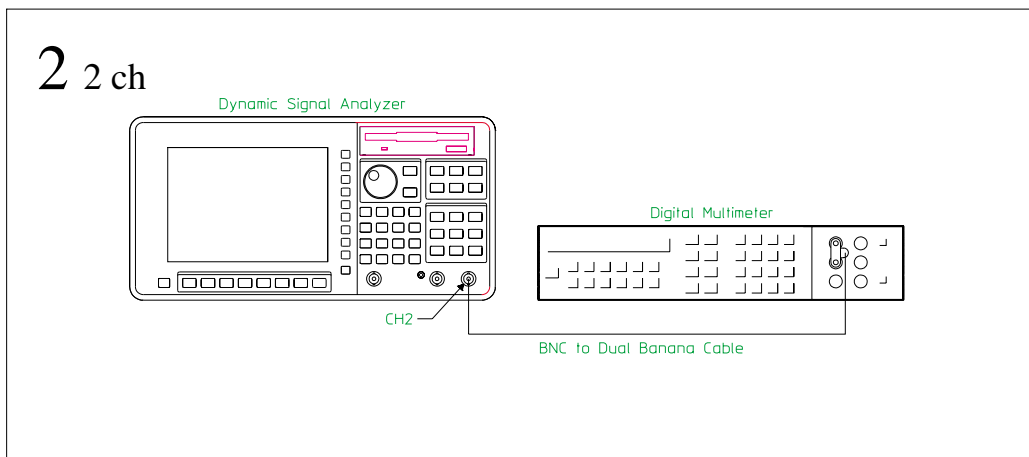
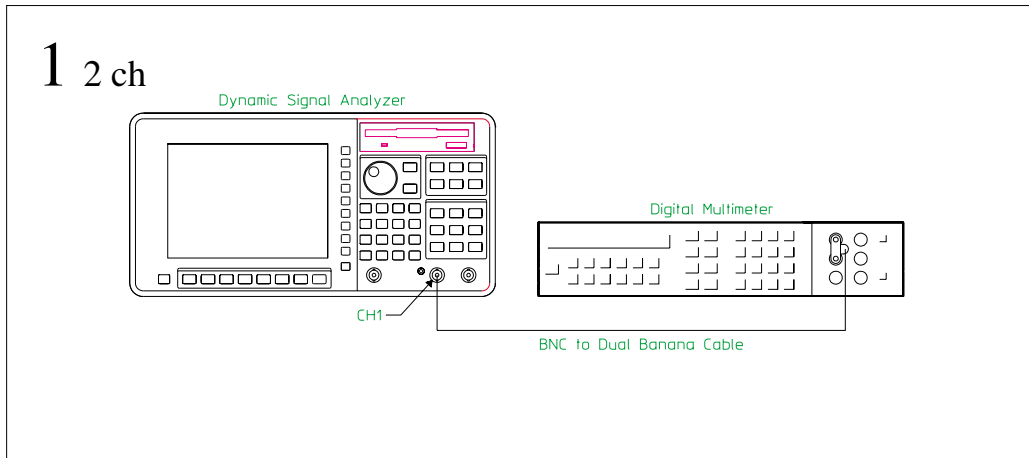

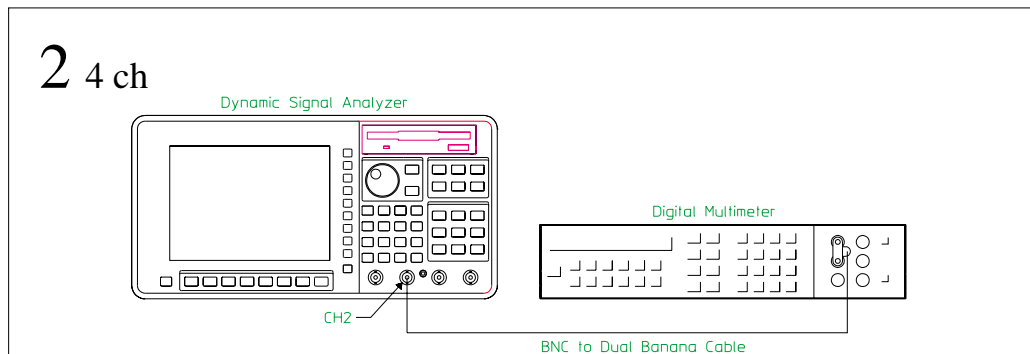
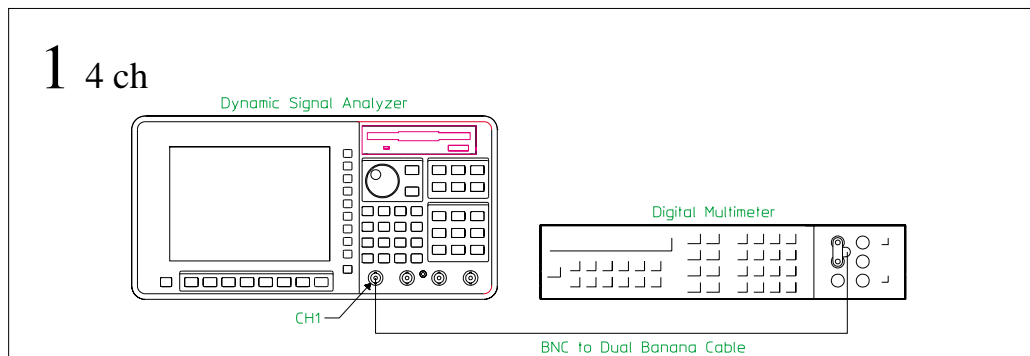
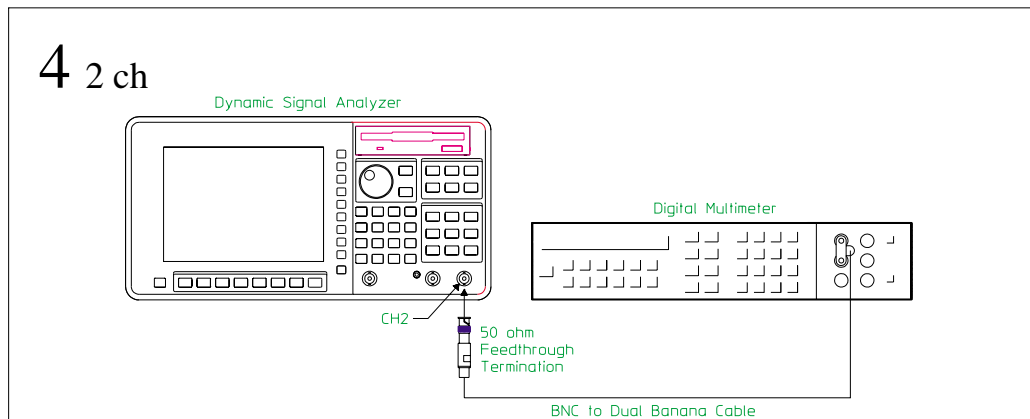
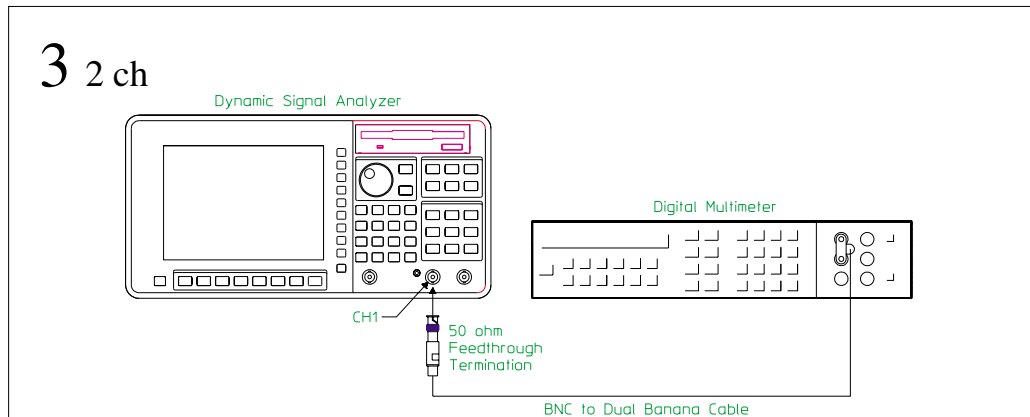

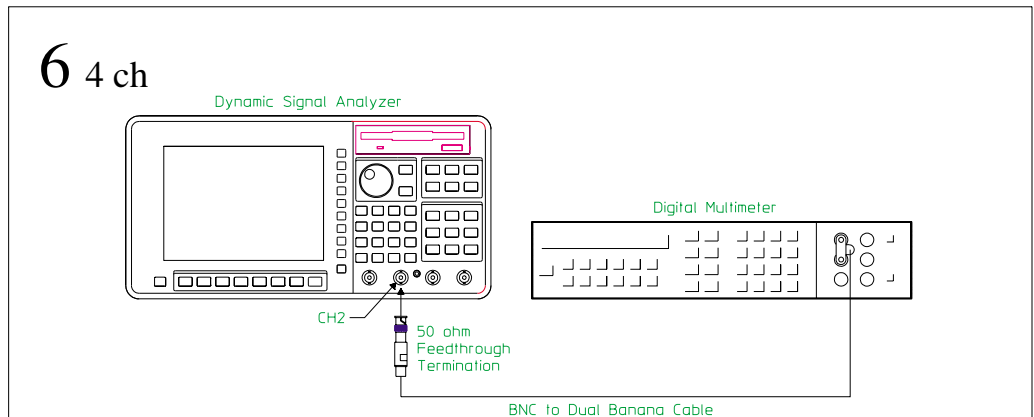
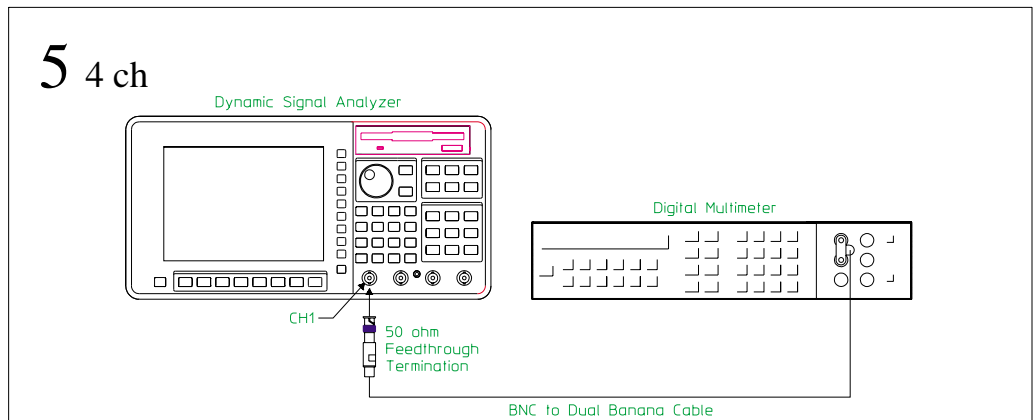
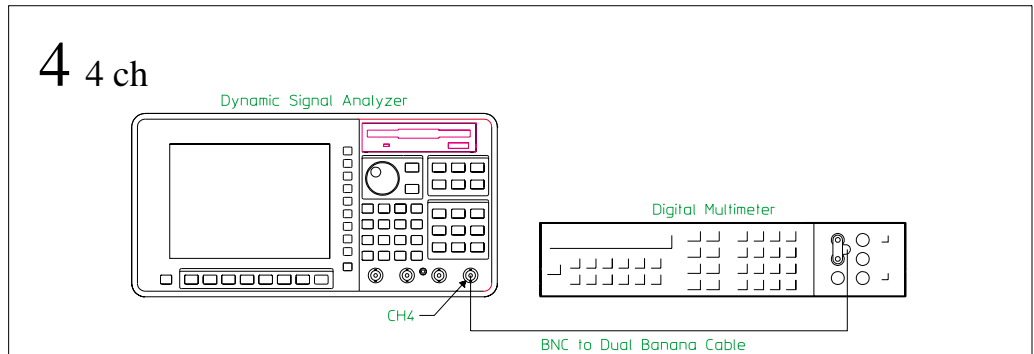
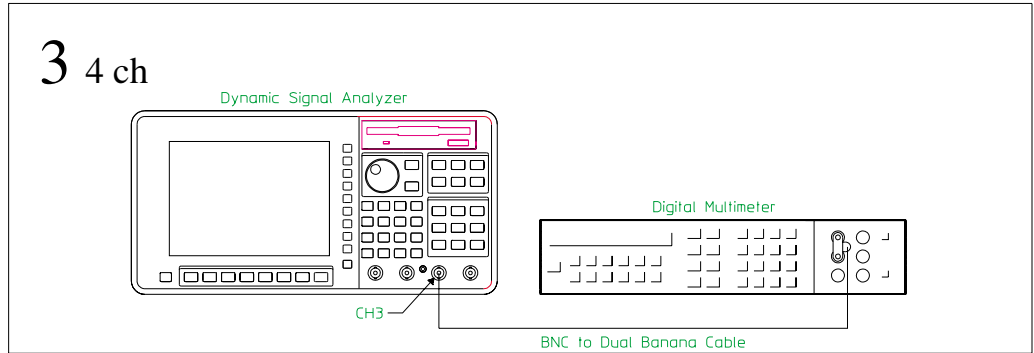

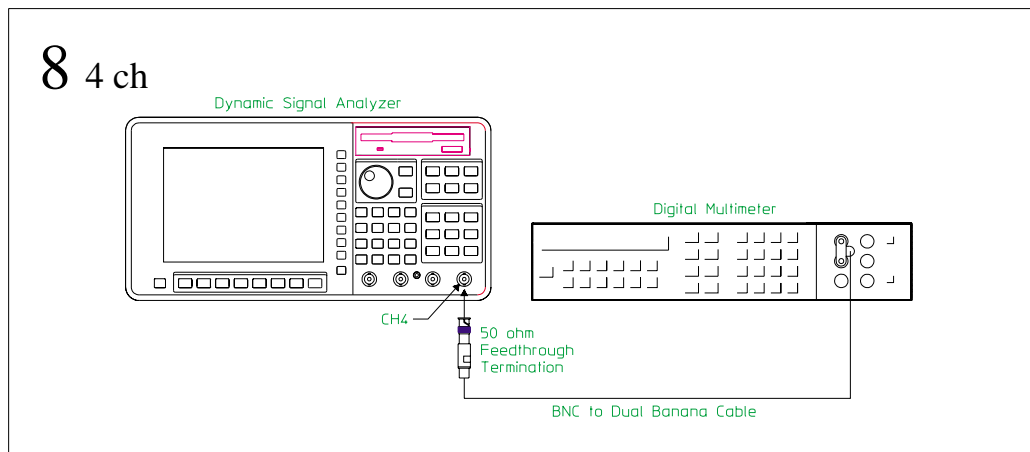
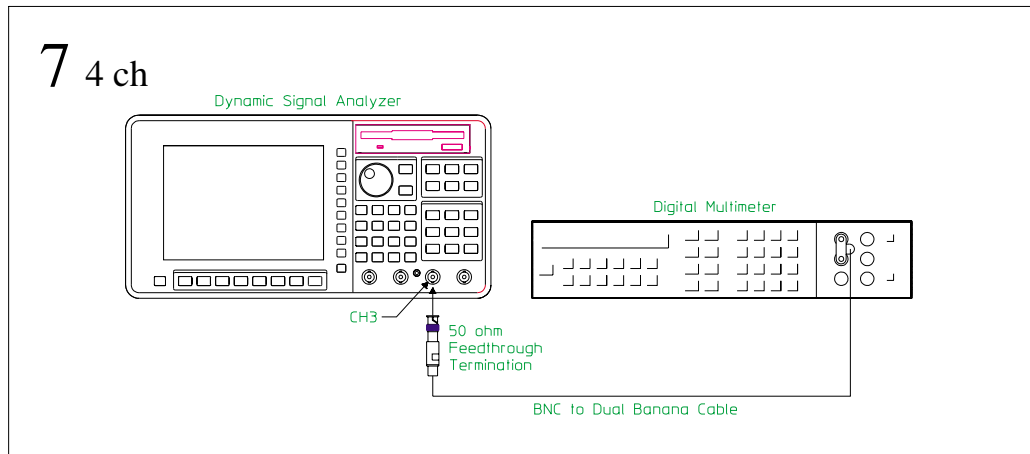

To set up the source amplitude accuracy test

Performance Test and Operation Verification

This test verifies that the Agilent 35670A meets its source output specification for sine amplitude accuracy at 1 kHz. In this test, a digital multimeter measures the amplitude accuracy of the source. Source amplitude accuracy is checked at 0.1 Vpk with the digital multimeter set to the 100 mVrms range and at 3.0 and 5.0 Vpk with the digital multimeter set to the 10 Vrms range. For the standard two channel analyzer, the digital multimeter is connected to the rear panel source connector instead of the front panel source connector. This is the only test that verifies the rear panel source port on the standard two channel analyzer.

1 2 ch

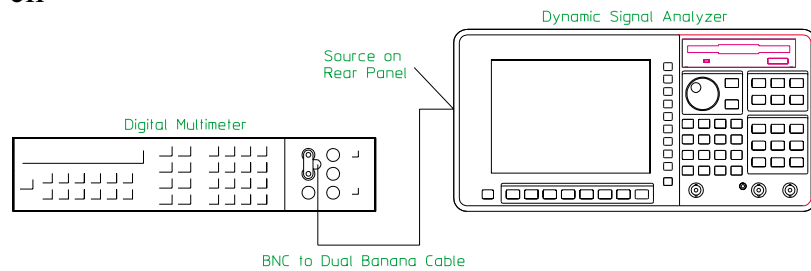

1 4 ch

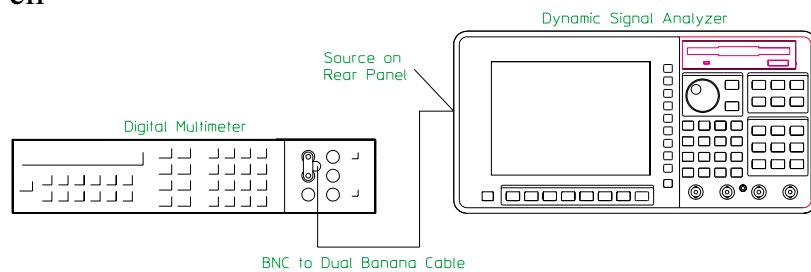

To set up the source output resistance test

Performance Test only

This test verifies that the Agilent 35670A meets its source output specification for resistance. In this test, a digital multimeter measures the 50 Ω feedthrough termination. The channel 1 input then measures the source output across the feedthrough termination, then in an open circuit condition. The resistance is calculated using the following formula:

$$R_s = R_1((V_{open} - V_{load})/V_{load})$$

Note: Use the same 50 Ω feedthrough termination for steps 1 and 2.

1 2 ch

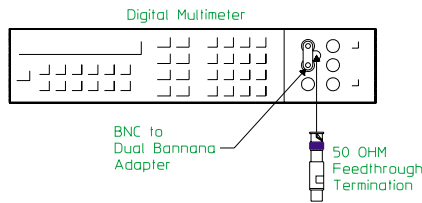

2 2 ch

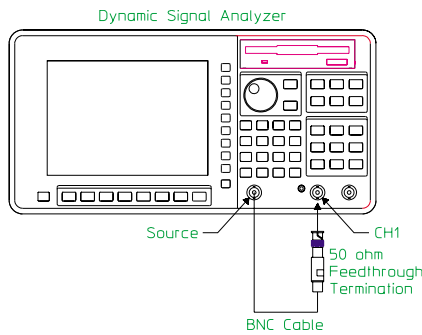

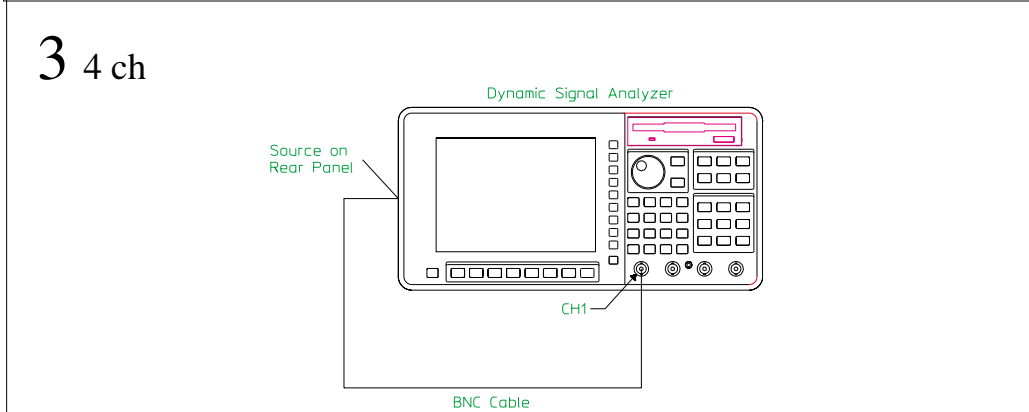
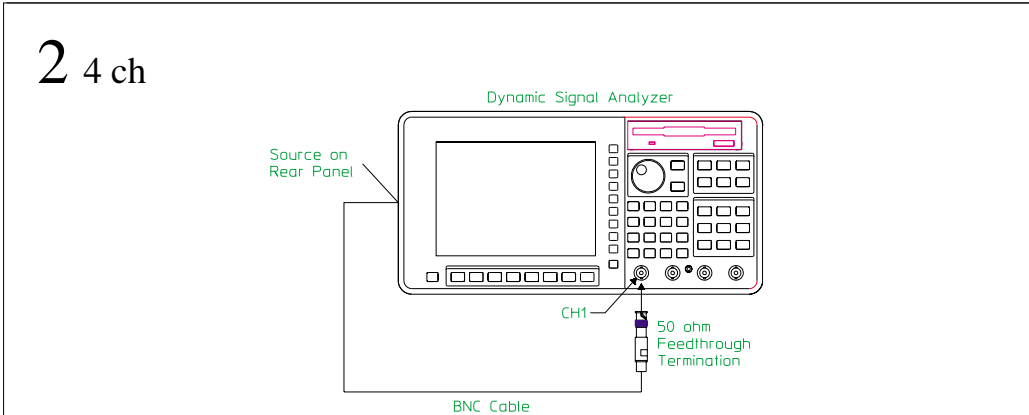
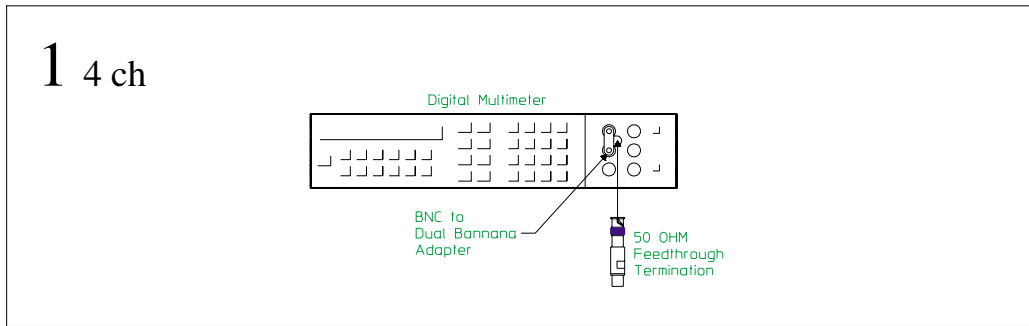
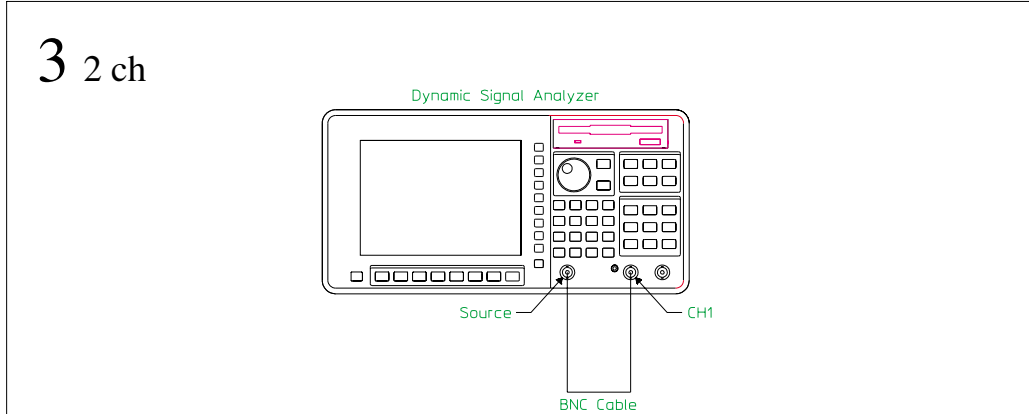

To set up the source dc offset test

Performance Test only

This test verifies that the Agilent 35670A meets its source output specification for dc offset accuracy. In this test, a digital multimeter measures the dc offset voltage of the source with and without an ac component. The frequency of the ac component is 96 kHz. The test records at the end of this chapter list the voltages that are checked.

1 2 ch

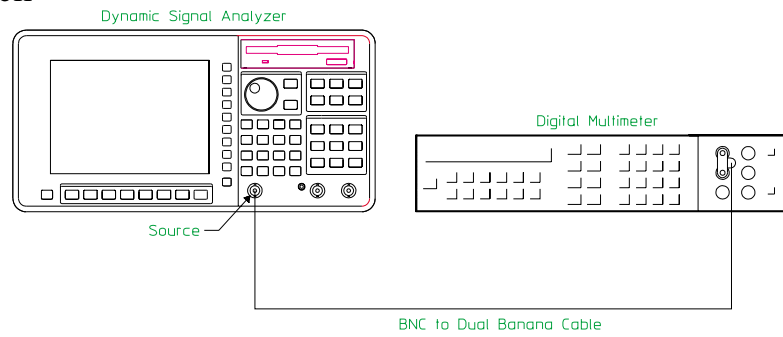

1 4 ch

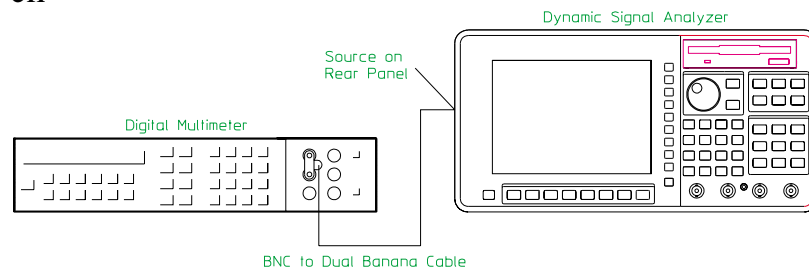

To set up the source flatness test

Performance Test and Operation Verification

This test verifies that the Agilent 35670A meets its source output specification for sine flatness. In this test, the analyzer's channel 1 input measures the flatness of its source.

1 2 ch

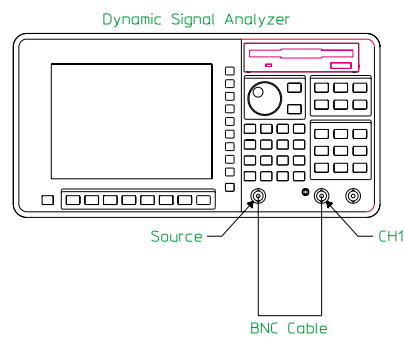

1 4 ch

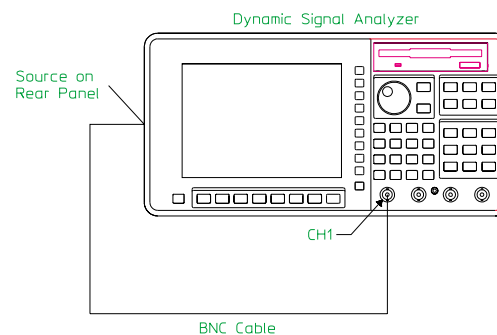

To set up the source distortion test

Performance Test and Operation Verification

This test verifies that the Agilent 35670A meets its source output specification for harmonic and sub-harmonic distortion and spurious signals. In this test, the analyzer's source is connected to its channel 1 input. The source is set for a maximum output level (5 Vpk) and the input range is set equal to the source level. The fundamental and harmonic is measured. The test records at the end of this chapter list the fundamental frequencies that are checked.

1 2 ch

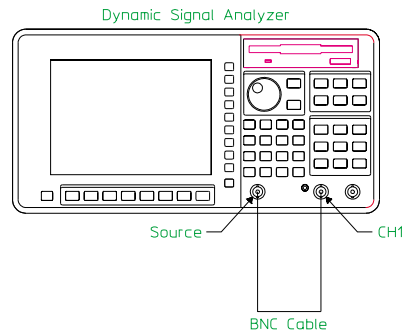

1 4 ch

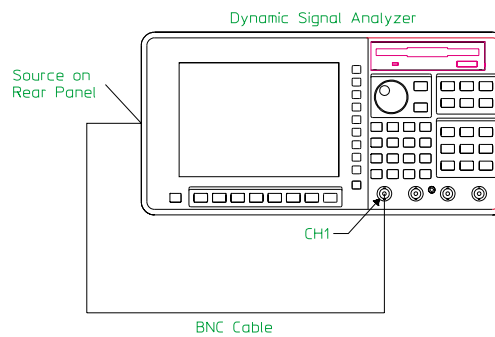

ITM_35670A Main Menu Descriptions

If you do not have a keyboard connected to the analyzer, use the numeric key pad and the alpha keys to enter names or numbers. See the analyzer's help text for a description of the alpha keys.

Load and run the ITM_35670A program to display the following softkeys:

[START TESTING]

Displays a menu that allows you to start testing with any test or to select just one test in the list. Before pressing this softkey, use [TEST CONFIG] and [EQUIP CONFIG].

[TEST CONFIG]

Displays the test configuration and a menu that allows you to enter the procedure, stop conditions, beeper prompt, and GPIB address for the analyzer and printer.

[EQUIP CONFIG]

Displays the test equipment configuration and a menu that allows you to enter the model number, calibration due date, serial number, and GPIB address for each test instrument.

[TITLE PAGE]

Displays the test record title page information and a menu that allows you to enter information for the analyzer.

[STOP ITM]

Stops the ITM_35670A program.

Start Testing Menu Descriptions

Press [START TESTING] to display the following softkeys:

[START BEGINNING]

Prints the test record title page information and starts the selected test procedure at the beginning. When you select [START BEGINNING], the data is written to a file on the disk and printed only after all tests are done.

[START MIDDLE]

Displays a list of all the tests in the selected procedure. Testing starts with the test you select and continues through the remainder of the tests in the list. When you select [START MIDDLE], the data is printed immediately after each measurement.

[ONE TEST]

Displays all the tests in the selected procedure. The test you select is the only test performed. When you select [ONE TEST], the data is printed immediately after each measurement.

[RETURN]

Returns to the ITM_35670A main menu.

Start a test to display the following softkeys:

[STOP TESTING]

Stops the test and returns to the ITM_35670A main menu.

[RESTART TEST]

Starts the current test over. Any connection prompts are repeated.

[RESTART MEAS]

Starts the current measurement over.

The following softkeys also appear when the program is waiting for you to press [CONTINUE]:

[STOP BEEPING]

Turns off the beeper prompt for the remainder of this measurement.

[CONTINUE]

Continues the test. Press this key after following the directions on the display.

Test Configuration Menu Descriptions

Press [TEST CONFIG] to display the test configuration and the following softkeys:

[Agilent 35670A ADDRESS]

Prompts you to enter the GPIB address for the Agilent 35670A Dynamic Signal Analyzer.

The GPIB address equals 100 ö (interface select code) + (primary address). The interface select code for the printer and test equipment is 7 (for example, if the primary address is 8, the GPIB address is 708).

[PRINTER ADDRESS]

Prompts you to enter the GPIB address for the printer. To disable the printer, set the printer address to 0.

[PROCEDURE]

Prompts you to select the operation verification procedure (OP_VERIFY) or the performance test procedure (PERFORMAN).

[BEEPER]

Toggles the beeper on and off. When the beeper is on, the program beeps approximately every 2 minutes while waiting for you to follow the directions on the display and press [CONTINUE].

[RETURN]

Returns to the ITM_35670A main menu.

[STOP AFTER]

Prompts you to select stop after limit failure, stop after each measurement, or do not stop after a limit failure or measurement. If [Limit Failure] is selected, the program stops after the failing measurement is displayed but before it is printed. At this point you can continue on and print the failing measurement or restart the measurement.

Equipment Configuration Menu Descriptions

Press [EQUIP CONFIG] to display the test equipment configuration and the following softkeys:

[AC CALIBRATO]

Prompts you to enter the model, serial number, GPIB address, and calibration due date for the ac calibrator.

If you select [Other] for model, the program prompts you to type in a model, serial number, and calibration due date but not an GPIB address.

When entering the calibration due date, only four characters are displayed on the screen. However, you can enter up to nine characters and they will be printed.

[SYNTH. 1]

Prompts you to enter the model, serial number, GPIB address, and calibration due date for the synthesizer.

[SYNTH. 2]

Prompts you to enter the model, serial number, GPIB address, and calibration due date for the second synthesizer. If the first synthesizer is an HP 3326A or if you are only performing the operation verification tests, you do not need a second synthesizer.

[LOW-D. OSCILLATO]

Prompts you to enter the model, serial number, and calibration due date for the low-distortion oscillator. If you have a 24.5 kHz notch filter or if you are only performing the operation verification tests, you do not need a low-distortion oscillator.

[MULTIMETER]

Prompts you to enter the model, serial number, GPIB address, and calibration due date for the multimeter.

[SAVE SETUP]

Saves the current equipment configuration to a file for future recall.

[RECALL SETUP]

Recalls an equipment configuration that was previously saved using [SAVE SETUP].

[RETURN]

Returns to the ITM_35670A main menu.

Title Page Menu Descriptions

Press [TITLE PAGE] to display the title page information and the following softkeys:

[TEST FACILITY]

Prompts you to enter the name or number of the testing entity.

[FACILITY ADDRESS]

Prompts you to enter the address of the testing entity.

[TESTED BY]

Prompts you to enter the name or number of the person performing the test.

[REPORT NUMBER]

Prompts you to enter the analyzer's report number.

[CUSTOMER]

Prompts you to enter the name or number of the person requesting the test.

[SERIAL NUMBER]

Prompts you to enter the analyzer's serial number.

[MORE]

Displays the next page.

[RETURN]

Returns to the ITM_35670A main menu.

[OPTIONS]

Prompts you to enter the analyzer's options.

[DATE]

Prompts you to enter the test date.

[TEMP]

Prompts you to enter the temperature of the environment during the test.

[HUMIDITY]

Prompts you to enter the humidity of the environment during the test.

[LINE FREQUENCY]

Prompts you to enter the power line frequency.

[MORE]

Displays the first page.

[RETURN]

Returns to the ITM_35670A main menu.

The title page information is printed at the beginning of the test procedure.

Measurement Uncertainty

The following table lists the measurement uncertainty and ratio for each performance test using the recommended test equipment. Except for the External Trigger test, the ratios listed for the recommended test equipment meet or exceed the measurement uncertainty ratio required by U.S. MIL-STD-45662A.

- If you are using equipment other than the recommended test equipment, you may calculate and record the measurement uncertainty and ratio for each performance test. The table may be reproduced without written permission of Agilent.

Performance Test	Using Recommended Test Equipment		Using Other Test Equipment	
	Measurement Uncertainty	Ratio	Measurement Uncertainty	Ratio
Self Test	NA	NA	NA	NA
DC Offset	NA	NA	NA	NA
Noise	NA	NA	NA	NA
Spurious Signals	NA	NA	NA	NA
Amplitude Accuracy				
-51 dBVrms	±0.020 dB	7.7:1		
-43 dBVrms	±0.0084 dB	>10:1		
-35 dBVrms	±0.004 dB	>10:1		
-27 dBVrms	±0.003 dB	>10:1		
-11 dBVrms	±0.001 dB	>10:1		
1 dBVrms	±0.0008 dB	>10:1		
9 dBVrms	±0.001 dB	>10:1		
19 dBVrms	±0.00081 dB	>10:1		
27 dBVrms	±0.00117 dB	>10:1		
Flatness				
25.6 kHz, 27 dBVrms	±0.01487 dB	>10:1		
25.6 kHz, 9 dBVrms	±0.01277 dB	>10:1		
25.6 kHz, -11 dBVrms	±0.01277 dB	>10:1		
51.2 kHz, 27 dBVrms	±0.02025 dB	10:1		
51.2 kHz, 9 dBVrms	±0.01460 dB	>10:1		
51.2 kHz, -11 dBVrms	±0.01583 dB	>10:1		
99.84 kHz, 27 dBVrms	±0.02025 dB	10:1		
99.84 kHz, 9 dBVrms	±0.01460 dB	>10:1		
99.84 kHz, -11 dBVrms	±0.01583 dB	>10:1		

NA (not applicable) internal test

Performance Test	Using Recommended Test Equipment		Using Other Test Equipment	
	Measurement Uncertainty	Ratio	Measurement Uncertainty	Ratio
Amplitude Linearity				
13 dBVrms	±0.0020 dB	>10:1		
-1 dBVrms	±0.0020 dB	>10:1		
-15 dBVrms	±0.0026 dB	>10:1		
-29 dBVrms	±0.0046 dB	>10:1		
-43 dBVrms	±0.0096 dB	>10:1		
-53 dBVrms	±0.0255 dB	>10:1		
A-Weight Filter				
10 Hz	0.016 dB	>10:1		
31.62 Hz	0.012 dB	>10:1		
100 Hz	0.012 dB	>10:1		
1 kHz	0.011 dB	>10:1		
10 kHz	0.011 dB	>10:1		
25.120 kHz	0.012 dB	>10:1		
Channel Match				
magnitude	±0.00001 dB	>10:1		
phase	±0.01 mdeg	>10:1		
Frequency Accuracy				
	±6.25 ppm	4.8:1		
Anti-Alias Filter				
<100 kHz	± 0.1 dB	>10:1		
<1 MHz	± 0.3 dB	>10:1		
Input Coupling				
	± 0.001 dB	>10:1		
Harmonic Distortion				
using HP 339A	±0.184 dB	4.46:1		
using HP 3326A with filter	±0.92 dB	10:1		
Intermodulation Distortion				
	±0.83 dB	10:1		
Cross Talk				
channel to channel	± 0.1 dB	>10:1		
source to input	±1.34 dB	6:1		
Single Channel Phase Accuracy				
	± 0.25 deg †	>10:1		
External Trigger				
	280 mVpk	3.6:1 ‡		
Input Resistance				
	±17Ω	>10:1		
ICP Supply				
oven circuit voltage	±320 mV	>10:1		
current	±132 mA	>10:1		

† The sync output to signal output phase error was determined to be less than 0.25 degrees.

‡ If measured value is within ±3% of specification, verify synthesizer level accuracy. Note: Without 50 Ω termination, observed levels are twice the setting into high impedance.

Performance Test	Using Recommended Test Equipment		Using Other Test Equipment	
	Measurement Uncertainty	Ratio	Measurement Uncertainty	Ratio
Source Amplitude Accuracy				
0.1 Vpk	± 9.83 mVpk	>10:1		
3.0 Vpk	± 492.9 mVpk	>10:1		
5.0 Vpk	± 633.0 mVpk	>10:1		
Source Output Resistance	± 0.15 Ω	>10:1		
Source DC Offset				
0 Vdc, 0 Vac-pk	± 238 nV	>10:1		
± 10 Vdc, 0 Vac-pk	± 84 mV	>10:1		
0 Vdc, 5 Vac-pk	± 2.123 mV	>10:1		
± 5 Vdc, 5 Vac-pk	± 43 mV	>10:1		
Source Flatness	± 0.2 dB	5.24:1		
Source Distortion				
fundamental <30 kHz	± 0.5 dB	6.3:1		
fundamental ≥ 30 kHz	± 0.5 dB	>10:1		

Performance Test Record - Two Channel

Test Facility _____

Facility Address _____

Tested By _____

Report Number _____

Customer Name _____

Serial Number _____

Installed Options _____

Date _____

Temperature _____

Humidity _____

Power Line Frequency _____

Test Instruments Used

Instrument	Model	ID or Serial Number	Calibration Due
AC Calibrator			
Synthesizer 1			
Synthesizer 2			
Low-D Oscillator			
Multimeter			

Serial Number: _____ **Report Number:** _____
Test Date: ___/___/___

Self Test

Measurement	Lower Limit	Upper Limit	Measured Value	Pass/Fail
Long Confidence				

DC Offset

Measurement	Lower Limit	Upper Limit (dBfs)	Measured Value (dBfs)	Pass/Fail
-51 dBVrms, Ch 1		-15		
-51 dBVrms, Ch 2		-15		
-35 dBVrms, Ch 1		-30		
-35 dBVrms, Ch 2		-30		

Noise

Measurement	Lower Limit	Upper Limit (dBV/\sqrt{Hz})	Measured Value (dBV/\sqrt{Hz})	Pass/Fail
Two Ch, 6.4 kHz Span, Ch 1		-130		
Two Ch, 6.4 kHz Span, Ch 2		-130		
Two Ch, 51.2 kHz Span, Ch 1		-140		
Two Ch, 51.2 kHz Span, Ch 2		-140		
One Ch, 102.4 kHz Span, Ch 1		-140		

Serial Number: _____ *Report Number:* _____
Test Date: ___/___/___

Spurious Signals

Measurement	Lower Limit	Upper Limit (dBfs)	Measured Value (dBfs)	Pass/Fail
Two Ch, 0 Hz Start, Ch 1		-80		
Two Ch, 0 Hz Start, Ch 2		-80		
Two Ch, 200 Hz Start, Ch 1		-80		
Two Ch, 200 Hz Start, Ch 2		-80		
Two Ch, 400 Hz Start, Ch 1		-80		
Two Ch, 400 Hz Start, Ch 2		-80		
Two Ch, 600 Hz Start, Ch 1		-80		
Two Ch, 600 Hz Start, Ch 2		-80		
Two Ch, 800 Hz Start, Ch 1		-80		
Two Ch, 800 Hz Start, Ch 2		-80		
Two Ch, 1000 Hz Start, Ch 1		-80		
Two Ch, 1000 Hz Start, Ch 2		-80		
Two Ch, 1200 Hz Start, Ch 1		-80		
Two Ch, 1200 Hz Start, Ch 2		-80		
Two Ch, 1400 Hz Start, Ch 1		-80		
Two Ch, 1400 Hz Start, Ch 2		-80		
Two Ch, 1600 Hz Start, Ch 1		-80		
Two Ch, 1600 Hz Start, Ch 2		-80		
Two Ch, 3200 Hz Start, Ch 1		-80		
Two Ch, 3200 Hz Start, Ch 2		-80		
Two Ch, 4800 Hz Start, Ch 1		-80		
Two Ch, 4800 Hz Start, Ch 2		-80		
Two Ch, 6400 Hz Start, Ch 1		-80		
Two Ch, 6400 Hz Start, Ch 2		-80		
Two Ch, 8000 Hz Start, Ch 1		-80		
Two Ch, 8000 Hz Start, Ch 2		-80		
Two Ch, 9600 Hz Start, Ch 1		-80		

Serial Number: _____ *Report Number:* _____
Test Date: ___/___/___

Spurious Signals (continued)

Measurement	Lower Limit	Upper Limit (dBfs)	Measured Value (dBfs)	Pass/Fail
Two Ch, 9600 Hz Start, Ch 2		-80		
Two Ch, 11200 Hz Start, Ch 1		-80		
Two Ch, 11200 Hz Start, Ch 2		-80		
Two Ch, 12800 Hz Start, Ch 1		-80		
Two Ch, 12800 Hz Start, Ch 2		-80		
Two Ch, 14400 Hz Start, Ch 1		-80		
Two Ch, 14400 Hz Start, Ch 2		-80		
Two Ch, 16000 Hz Start, Ch 1		-80		
Two Ch, 16000 Hz Start, Ch 2		-80		
Two Ch, 17600 Hz Start, Ch 1		-80		
Two Ch, 17600 Hz Start, Ch 2		-80		
Two Ch, 19200 Hz Start, Ch 1		-80		
Two Ch, 19200 Hz Start, Ch 2		-80		
Two Ch, 20800 Hz Start, Ch 1		-80		
Two Ch, 20800 Hz Start, Ch 2		-80		
Two Ch, 22400 Hz Start, Ch 1		-80		
Two Ch, 22400 Hz Start, Ch 2		-80		
Two Ch, 24000 Hz Start, Ch 1		-80		
Two Ch, 24000 Hz Start, Ch 2		-80		
Two Ch, 25600 Hz Start, Ch 1		-80		
Two Ch, 25600 Hz Start, Ch 2		-80		
Two Ch, 27200 Hz Start, Ch 1		-80		
Two Ch, 27200 Hz Start, Ch 2		-80		
Two Ch, 28800 Hz Start, Ch 1		-80		
Two Ch, 28800 Hz Start, Ch 2		-80		
Two Ch, 30400 Hz Start, Ch 1		-80		
Two Ch, 30400 Hz Start, Ch 2		-80		

Serial Number: _____ *Report Number:* _____
Test Date: ___/___/___

S purious Signals (continued)

Measurement	Lower Limit	Upper Limit (dBfs)	Measured Value (dBfs)	Pass/Fail
Two Ch, 32000 Hz Start, Ch 1		-80		
Two Ch, 32000 Hz Start, Ch 2		-80		
Two Ch, 33600 Hz Start, Ch 1		-80		
Two Ch, 33600 Hz Start, Ch 2		-80		
Two Ch, 35200 Hz Start, Ch 1		-80		
Two Ch, 35200 Hz Start, Ch 2		-80		
Two Ch, 36800 Hz Start, Ch 1		-80		
Two Ch, 36800 Hz Start, Ch 2		-80		
Two Ch, 38400 Hz Start, Ch 1		-80		
Two Ch, 38400 Hz Start, Ch 2		-80		
Two Ch, 40000 Hz Start, Ch 1		-80		
Two Ch, 40000 Hz Start, Ch 2		-80		
Two Ch, 41600 Hz Start, Ch 1		-80		
Two Ch, 41600 Hz Start, Ch 2		-80		
Two Ch, 43200 Hz Start, Ch 1		-80		
Two Ch, 43200 Hz Start, Ch 2		-80		
Two Ch, 44800 Hz Start, Ch 1		-80		
Two Ch, 44800 Hz Start, Ch 2		-80		
Two Ch, 46400 Hz Start, Ch 1		-80		
Two Ch, 46400 Hz Start, Ch 2		-80		
Two Ch, 48000 Hz Start, Ch 1		-80		
Two Ch, 48000 Hz Start, Ch 2		-80		
Two Ch, 49600 Hz Start, Ch 1		-80		
Two Ch, 49600 Hz Start, Ch 2		-80		
One Ch, 79200 Start, Ch 1		-80		
One Ch, 80800 Start, Ch 1		-80		
One Ch, 85600 Start, Ch 1		-80		

Serial Number: _____ *Report Number:* _____
Test Date: ___/___/___

Measurement	Lower Limit	Upper Limit (dBfs)	Measured Value (dBfs)	Pass/Fail
One Ch, 87200 Start, Ch 1		-80		
One Ch, 88800 Start, Ch 1		-80		
One Ch, 97000 Start, Ch 1		-80		
One Ch, 98600 Start, Ch 1		-80		
One Ch, 100200 Start, Ch 1		-80		
One Ch, 101800 Start, Ch 1		-80		

Amplitude Accuracy

Measurement	Lower Limit (dBVrms)	Upper Limit (dBVrms)	Measured Value (dBVrms)	Pass/Fail
-51 dBVrms, Ch 1	-51.15	-50.85		
-51 dBVrms, Ch 2	-51.15	-50.85		
-43 dBVrms, Ch 1	-43.15	-42.85		
-43 dBVrms, Ch 2	-43.15	-42.85		
-35 dBVrms, Ch 1	-35.15	-34.85		
-35 dBVrms, Ch 2	-35.15	-34.85		
-27 dBVrms, Ch 1	-27.15	-26.85		
-27 dBVrms, Ch 2	-27.15	-26.85		
-11 dBVrms, Ch 1	-11.15	-10.85		
-11 dBVrms, Ch 2	-11.15	-10.85		
1 dBVrms, Ch 1	0.85	1.15		
1 dBVrms, Ch 2	0.85	1.15		
9 dBVrms, Ch 1	8.85	9.15		
9 dBVrms, Ch 2	8.85	9.15		
19 dBVrms, Ch 1	18.85	19.15		
19 dBVrms, Ch 2	18.85	19.15		
27 dBVrms, Ch 1	26.85	27.15		
27 dBVrms, Ch 2	26.85	27.15		

Serial Number: _____ **Report Number:** _____
Test Date: ___/___/___

Flatness

Measurement	Lower Limit (dB)	Upper Limit (dB)	Measured Value (dB)	Pass/Fail
27 dBVrms, 99.84 kHz, One Ch, Ch 1	-0.2	0.2		
9 dBVrms, 99.84 kHz, One Ch, Ch 1	-0.2	0.2		
-11 dBVrms, 99.84 kHz, One Ch, Ch 1	-0.2	0.2		
27 dBVrms, 51.2 kHz, Two Ch, Ch 1	-0.2	0.2		
27 dBVrms, 51.2 kHz, Two Ch, Ch 2	-0.2	0.2		
9 dBVrms, 51.2 kHz, Two Ch, Ch 1	-0.2	0.2		
9 dBVrms, 51.2 kHz, Two Ch, Ch 2	-0.2	0.2		
-11 dBVrms, 51.2 kHz, Two Ch, Ch 1	-0.2	0.2		
-11 dBVrms, 51.2 kHz, Two Ch, Ch 2	-0.2	0.2		

Amplitude Linearity

Measurement	Lower Limit (dB)	Upper Limit (dB)	Measured Value (dB)	Pass/Fail
13 dBVrms, Ch 1	-0.0615	0.061		
13 dBVrms, Ch 2	-0.0615	0.061		
-1 dBVrms, Ch 1	-0.105	0.104		
-1 dBVrms, Ch 2	-0.105	0.104		
-15 dBVrms, Ch 1	-0.33	0.318		
-15 dBVrms, Ch 2	-0.33	0.318		
-29 dBVrms, Ch 1	-1.551	1.316		
-29 dBVrms, Ch 2	-1.551	1.316		
-43 dBVrms, Ch 1	-13.823	5.088		
-43 dBVrms, Ch 2	-13.823	5.088		
-53 dBVrms, Ch 1	-30.116	10.896		
-53 dBVrms, Ch 2	-30.116	10.896		

Serial Number: _____ Report Number: _____
Test Date: __/__/__

A-Weight Filter

Measurement	Lower Limit (dB)	Upper Limit (dB)	Measured Value (dB)	Pass/Fail
Ch 1, 10 Hz	-5	2		
Ch 2, 10 Hz	-5	2		
Ch 1, 31.62 Hz	-1	1		
Ch 2, 31.62 Hz	-1	1		
Ch 1, 100 Hz	-0.7	0.7		
Ch 2, 100 Hz	-0.7	0.7		
Ch 1, 1000 Hz	-0.7	0.7		
Ch 2, 1000 Hz	-0.7	0.7		
Ch 1, 10000 Hz	-3	2		
Ch 2, 10000 Hz	-3	2		
Ch 1, 25120 Hz	-4.5	2.4		
Ch 2, 25120 Hz	-4.5	2.4		

Channel Match

Measurement	Lower Limit	Upper Limit	Measured Value	Pass/Fail
Two Ch, 2/1, 7 dBV FS Mag	-0.04 dB	0.04 dB	dB	
Two Ch, 2/1, 7 dBV FS Phs	-0.5 deg	0.5 deg	deg	
Two Ch, 2/1, -13 dBV FS Mag	-0.04 dB	0.04 dB	dB	
Two Ch, 2/1, -13 dBV FS Phs	-0.5 deg	0.5 deg	deg	
Two Ch, 2/1, -33 dBV FS Mag	-0.04 dB	0.04 dB	dB	
Two Ch, 2/1, -33 dBV FS Phs	-0.5 deg	0.5 deg	deg	
Two Ch, 2/1, 7 dBV -20dBfs Mag	-0.08 dB	0.08 dB	dB	
Two Ch, 2/1, 7 dBV -20dBfs Phs	-0.5 deg	0.5 deg	deg	

Serial Number: _____ **Report Number:** _____
Test Date: ___/___/___

Frequency Accuracy

Measurement	Lower Limit (kHz)	Upper Limit (kHz)	Measured Value (kHz)	Pass/Fail
50 kHz	49.9985	50.0015		

Anti-Alias Filter

Measurement	Lower Limit (dBfs)	Upper Limit (dBfs)	Measured Value (dBfs)	Pass/Fail
One Ch, Ch 1, 102.4 kHz		-80		
Two Ch, Ch 1, 51.2 kHz		-80		
Two Ch, Ch 2, 51.2 kHz		-80		

Input Coupling

Measurement	Lower Limit (dB)	Upper Limit (dB)	Measured Value (dB)	Pass/Fail
dc - ac, Ch 1		3		
dc - ac, Ch 2		3		

Serial Number: _____ *Report Number:* _____
Test Date: ___/___/___

Harmonic Distortion

Measurement	Lower Limit	Upper Limit (dBfs)	Measured Value (dBfs)	Pass/Fail
Single, 12.25 kHz 2nd, Ch 1		-80		
Two Ch, 12.25 kHz 2nd, Ch 1		-80		
Two Ch, 12.25 kHz 2nd, Ch 2		-80		
Single, 8.167 kHz 3rd, Ch 1		-80		
Two Ch, 8.167 kHz 3rd, Ch 1		-80		
Two Ch, 8.167 kHz 3rd, Ch 2		-80		
Single, 6.125 kHz 4th, Ch 1		-80		
Two Ch, 6.125 kHz 4th, Ch 1		-80		
Two Ch, 6.125 kHz 4th, Ch 2		-80		
Single, 4.9 kHz 5th, Ch 1		-80		
Two Ch, 4.9 kHz 5th, Ch 1		-80		
Two Ch, 4.9 kHz 5th, Ch 2		-80		

Serial Number: _____ **Report Number:** _____
Test Date: ___/___/___

Intermodulation Distortion

Measurement	Lower Limit	Upper Limit (dBfs)	Measured Value (dBfs)	Pass/Fail
One Ch, F1+F2, 102.4 kHz, Ch 1		-80		
One Ch, F1+F2, 64.096 kHz, Ch 1		-80		
One Ch, F1-2F2, 99.096 kHz, Ch 1		-80		
Two Ch, F1+F2, 1952 Hz, Ch 1		-80		
Two Ch, F1+F2, 1952 Hz, Ch 2		-80		
Two Ch, F1-2F2, 1048 Hz, Ch 1		-80		
Two Ch, F1-2F2, 1048 Hz, Ch 2		-80		
Two Ch, F1+F2, 48.048 kHz, Ch 1		-80		
Two Ch, F1+F2, 48.048 kHz, Ch 2		-80		
Two Ch, F1+F2, 33.024 kHz, Ch 1		-80		
Two Ch, F1+F2, 33.024 kHz, Ch 2		-80		
Two Ch, F1-2F2, 49.096 kHz, Ch 1		-80		
Two Ch, F1-2F2, 49.096 kHz, Ch 2		-80		

Cross Talk

Measurement	Lower Limit	Upper Limit (dBVrms)	Measured Value (dBVrms)	Pass/Fail
Source-to-Ch 1		-126		
Source-to-Ch 2		-126		
Receiver Ch 1, Driver Ch 2		-126		
Receiver Ch 2, Driver Ch 1		-126		

Serial Number: _____ **Report Number:** _____
Test Date: ___/___/___

Single Ch Phase Accuracy

Measurement	Lower Limit (deg)	Upper Limit (deg)	Measured Value (deg)	Pass/Fail
Positive slope, Ch 1	-4	4		
Positive slope, Ch 2	-4	4		
Negative slope, Ch 1	-4	4		
Negative slope, Ch 2	-4	4		

External Trigger

Measurement	Lower Limit (%)	Upper Limit (%)	Measured Value (%)	Pass/Fail
8 V Pos	-10	10		
8 V Neg	-10	10		
-8 V Pos	-10	10		
-8 V Neg	-10	10		

Input Resistance

Measurement	Lower Limit (%)	Upper Limit (%)	Measured Value (%)	Pass/Fail
27 dBVrms, Ch 1	-10	10		
9 dBVrms, Ch 1	-10	10		
-11 dBVrms, Ch 1	-10	10		
27 dBVrms, Ch 2	-10	10		
9 dBVrms, Ch 2	-10	10		
-11 dBVrms, Ch 2	-10	10		

Serial Number: _____ **Report Number:** _____
Test Date: ___/___/___

ICP Supply

Measurement	Lower Limit	Upper Limit	Measured Value	Pass/Fail
Ch 1 Open Circuit Voltage	26 Vdc	32 Vdc	Vdc	
Ch 2 Open Circuit Voltage	26 Vdc	32 Vdc	Vdc	
Ch 1 Current	2.75 mA	5.75 mA	mA	
Ch 2 Current	2.75 mA	5.75 mA	mA	

Source Amplitude Accuracy

Measurement	Lower Limit (%)	Upper Limit (%)	Measured Value (%)	Pass/Fail
1 kHz, 0.1 Vpk	-4	4		
1 kHz, 3.0 Vpk	-4	4		
1 kHz, 5.0 Vpk	-4	4		

Source Output Resistance

Measurement	Lower Limit	Upper Limit (ohm)	Measured Value (ohm)	Pass/Fail
Resistance		5		

Serial Number: _____ Report Number: _____
Test Date: __/__/__

Source DC Offset

Measurement	Lower Limit (mVdc)	Upper Limit (mVdc)	Measured Value (mVdc)	Pass/Fail
0 Vdc, 0 Vac(pk)	-15	15		
-10 Vdc, 0 Vac(pk)	-315	315		
+10 Vdc, 0 Vac(pk)	-315	315		
-5 Vdc, 5 Vac(pk)	-315	315		
+5 Vdc, 5 Vac(pk)	-315	315		
0 Vdc, 5 Vac(pk)	-165	165		

Source Flatness

Measurement	Lower Limit (dB)	Upper Limit (dB)	Measured Value (dB)	Pass/Fail
12.8 kHz	-1	1		
25.6 kHz	-1	1		
51.2 kHz	-1	1		
102.4 kHz	-1	1		

Source Distortion

Measurement	Lower Limit	Upper Limit (dBc)	Measured Value (dBc)	Pass/Fail
12.8 kHz		-60		
51.2 kHz		-40		
102.4 kHz		-40		

Performance Test Record - Four Channel

Test Facility _____

Facility Address _____

Tested By _____

Report Number _____

Customer Name _____

Serial Number _____

Installed Options _____

Date _____

Temperature _____

Humidity _____

Power Line Frequency _____

Test Instruments Used

Instrument	Model	ID or Serial Number	Calibration Due
AC Calibrator			
Synthesizer 1			
Synthesizer 2			
Low-D Oscillator			
Multimeter			

Serial Number: _____ **Report Number:** _____
Test Date: ___/___/___

Self Test

Measurement	Lower Limit	Upper Limit	Measured Value	Pass/Fail
Long Confidence				

DC Offset

Measurement	Lower Limit	Upper Limit (dBfs)	Measured Value (dBfs)	Pass/Fail
-51 dBVrms, Ch 1		-15		
-51 dBVrms, Ch 2		-15		
-51 dBVrms, Ch 3		-15		
-51 dBVrms, Ch 4		-15		
-35 dBVrms, Ch 1		-30		
-35 dBVrms, Ch 2		-30		
-35 dBVrms, Ch 3		-30		
-35 dBVrms, Ch 4		-30		

Noise

Measurement	Lower Limit	Upper Limit (dBV/√Hz)	Measured Value (dBV/√Hz)	Pass/Fail
Four Ch, 6.4 kHz Span, Ch 1		-130		
Four Ch, 6.4 kHz Span, Ch 2		-130		
Four Ch, 6.4 kHz Span, Ch 3		-130		
Four Ch, 6.4 kHz Span, Ch 4		-130		
Four Ch, 25.6 kHz Span, Ch 1		-140		
Four Ch, 25.6 kHz Span, Ch 2		-140		
Four Ch, 25.6 kHz Span, Ch 3		-140		
Four Ch, 25.6 kHz Span, Ch 4		-140		
Two Ch, 51.2 kHz Span, Ch 1		-140		
Two Ch, 51.2 kHz Span, Ch 2		-140		

Spurious Signals

Serial Number: _____ **Report Number:** _____
Test Date: ___/___/___

Measurement	Lower Limit	Upper Limit (dBfs)	Measured Value (dBfs)	Pass/Fail
Four Ch, 0 Hz Start, Ch 1		-80		
Four Ch, 0 Hz Start, Ch 2		-80		
Four Ch, 0 Hz Start, Ch 3		-80		
Four Ch, 0 Hz Start, Ch 4		-80		
Four Ch, 200 Hz Start, Ch 1		-80		
Four Ch, 200 Hz Start, Ch 2		-80		
Four Ch, 200 Hz Start, Ch 3		-80		
Four Ch, 200 Hz Start, Ch 4		-80		
Four Ch, 400 Hz Start, Ch 1		-80		
Four Ch, 400 Hz Start, Ch 2		-80		
Four Ch, 400 Hz Start, Ch 3		-80		
Four Ch, 400 Hz Start, Ch 4		-80		
Four Ch, 600 Hz Start, Ch 1		-80		
Four Ch, 600 Hz Start, Ch 2		-80		
Four Ch, 600 Hz Start, Ch 3		-80		
Four Ch, 600 Hz Start, Ch 4		-80		
Four Ch, 800 Hz Start, Ch 1		-80		
Four Ch, 800 Hz Start, Ch 2		-80		
Four Ch, 800 Hz Start, Ch 3		-80		
Four Ch, 800 Hz Start, Ch 4		-80		
Four Ch, 1000 Hz Start, Ch 1		-80		
Four Ch, 1000 Hz Start, Ch 2		-80		
Four Ch, 1000 Hz Start, Ch 3		-80		
Four Ch, 1000 Hz Start, Ch 4		-80		
Four Ch, 1200 Hz Start, Ch 1		-80		
Four Ch, 1200 Hz Start, Ch 2		-80		
Four Ch, 1200 Hz Start, Ch 3		-80		
Four Ch, 1200 Hz Start, Ch 4		-80		

Serial Number: _____ *Report Number:* _____
Test Date: ___/___/___

Spurious Signals (continued)

Measurement	Lower Limit	Upper Limit (dBfs)	Measured Value (dBfs)	Pass/Fail
Four Ch, 1400 Hz Start, Ch 1		-80		
Four Ch, 1400 Hz Start, Ch 2		-80		
Four Ch, 1400 Hz Start, Ch 3		-80		
Four Ch, 1400 Hz Start, Ch 4		-80		
Four Ch, 1600 Hz Start, Ch 1		-80		
Four Ch, 1600 Hz Start, Ch 2		-80		
Four Ch, 1600 Hz Start, Ch 3		-80		
Four Ch, 1600 Hz Start, Ch 4		-80		
Four Ch, 3200 Hz Start, Ch 1		-80		
Four Ch, 3200 Hz Start, Ch 2		-80		
Four Ch, 3200 Hz Start, Ch 3		-80		
Four Ch, 3200 Hz Start, Ch 4		-80		
Four Ch, 4800 Hz Start, Ch 1		-80		
Four Ch, 4800 Hz Start, Ch 2		-80		
Four Ch, 4800 Hz Start, Ch 3		-80		
Four Ch, 4800 Hz Start, Ch 4		-80		
Four Ch, 6400 Hz Start, Ch 1		-80		
Four Ch, 6400 Hz Start, Ch 2		-80		
Four Ch, 6400 Hz Start, Ch 3		-80		
Four Ch, 6400 Hz Start, Ch 4		-80		
Four Ch, 8000 Hz Start, Ch 1		-80		
Four Ch, 8000 Hz Start, Ch 2		-80		
Four Ch, 8000 Hz Start, Ch 3		-80		
Four Ch, 8000 Hz Start, Ch 4		-80		
Four Ch, 9600 Hz Start, Ch 1		-80		
Four Ch, 9600 Hz Start, Ch 2		-80		
Four Ch, 9600 Hz Start, Ch 3		-80		

Serial Number: _____ **Report Number:** _____
Test Date: __/__/__

Spurious Signals (continued)

Measurement	Lower Limit	Upper Limit (dBfs)	Measured Value (dBfs)	Pass/Fail
Four Ch, 9600 Hz Start, Ch 4		-80		
Four Ch, 11200 Hz Start, Ch 1		-80		
Four Ch, 11200 Hz Start, Ch 2		-80		
Four Ch, 11200 Hz Start, Ch 3		-80		
Four Ch, 11200 Hz Start, Ch 4		-80		
Four Ch, 12800 Hz Start, Ch 1		-80		
Four Ch, 12800 Hz Start, Ch 2		-80		
Four Ch, 12800 Hz Start, Ch 3		-80		
Four Ch, 12800 Hz Start, Ch 4		-80		
Four Ch, 14400 Hz Start, Ch 1		-80		
Four Ch, 14400 Hz Start, Ch 2		-80		
Four Ch, 14400 Hz Start, Ch 3		-80		
Four Ch, 14400 Hz Start, Ch 4		-80		
Four Ch, 16000 Hz Start, Ch 1		-80		
Four Ch, 16000 Hz Start, Ch 2		-80		
Four Ch, 16000 Hz Start, Ch 3		-80		
Four Ch, 16000 Hz Start, Ch 4		-80		
Four Ch, 17600 Hz Start, Ch 1		-80		
Four Ch, 17600 Hz Start, Ch 2		-80		
Four Ch, 17600 Hz Start, Ch 3		-80		
Four Ch, 17600 Hz Start, Ch 4		-80		
Four Ch, 19200 Hz Start, Ch 1		-80		
Four Ch, 19200 Hz Start, Ch 2		-80		
Four Ch, 19200 Hz Start, Ch 3		-80		
Four Ch, 19200 Hz Start, Ch 4		-80		
Four Ch, 20800 Hz Start, Ch 1		-80		
Four Ch, 20800 Hz Start, Ch 2		-80		

Serial Number: _____ Report Number: _____
Test Date: __/__/__

Spurious Signals (continued)

Measurement	Lower Limit	Upper Limit (dBfs)	Measured Value (dBfs)	Pass/Fail
Four Ch, 20800 Hz Start, Ch 3		-80		
Four Ch, 20800 Hz Start, Ch 4		-80		
Four Ch, 22400 Hz Start, Ch 1		-80		
Four Ch, 22400 Hz Start, Ch 2		-80		
Four Ch, 22400 Hz Start, Ch 3		-80		
Four Ch, 22400 Hz Start, Ch 4		-80		
Four Ch, 24000 Hz Start, Ch 1		-80		
Four Ch, 24000 Hz Start, Ch 2		-80		
Four Ch, 24000 Hz Start, Ch 3		-80		
Four Ch, 24000 Hz Start, Ch 4		-80		
Two Ch, 25600 Hz Start, Ch 1		-80		
Two Ch, 25600 Hz Start, Ch 2		-80		
Two Ch, 27200 Hz Start, Ch 1		-80		
Two Ch, 27200 Hz Start, Ch 2		-80		
Two Ch, 28800 Hz Start, Ch 1		-80		
Two Ch, 28800 Hz Start, Ch 2		-80		
Two Ch, 30400 Hz Start, Ch 1		-80		
Two Ch, 30400 Hz Start, Ch 2		-80		
Two Ch, 32000 Hz Start, Ch 1		-80		
Two Ch, 32000 Hz Start, Ch 2		-80		
Two Ch, 33600 Hz Start, Ch 1		-80		
Two Ch, 33600 Hz Start, Ch 2		-80		
Two Ch, 35200 Hz Start, Ch 1		-80		
Two Ch, 35200 Hz Start, Ch 2		-80		
Two Ch, 36800 Hz Start, Ch 1		-80		
Two Ch, 36800 Hz Start, Ch 2		-80		
Two Ch, 38400 Hz Start, Ch 1		-80		

Serial Number: _____ Report Number: _____
 Test Date: __/__/__

Spurious Signals (continued)

Measurement	Lower Limit	Upper Limit (dBfs)	Measured Value (dBfs)	Pass/Fail
Two Ch, 38400 Hz Start, Ch 2		-80		
Two Ch, 40000 Hz Start, Ch 1		-80		
Two Ch, 40000 Hz Start, Ch 2		-80		
Two Ch, 41600 Hz Start, Ch 1		-80		
Two Ch, 41600 Hz Start, Ch 2		-80		
Two Ch, 43200 Hz Start, Ch 1		-80		
Two Ch, 43200 Hz Start, Ch 2		-80		
Two Ch, 44800 Hz Start, Ch 1		-80		
Two Ch, 44800 Hz Start, Ch 2		-80		
Two Ch, 46400 Hz Start, Ch 1		-80		
Two Ch, 46400 Hz Start, Ch 2		-80		
Two Ch, 48000 Hz Start, Ch 1		-80		
Two Ch, 48000 Hz Start, Ch 2		-80		
Two Ch, 49600 Hz Start, Ch 1		-80		
Two Ch, 49600 Hz Start, Ch 2		-80		

Amplitude Accuracy

Measurement	Lower Limit (dBVrms)	Upper Limit (dBVrms)	Measured Value (dBVrms)	Pass/Fail
-51 dBVrms, Ch 1	-51.15	-50.85		
-51 dBVrms, Ch 2	-51.15	-50.85		
-51 dBVrms, Ch 3	-51.15	-50.85		
-51 dBVrms, Ch 4	-51.15	-50.85		
-43 dBVrms, Ch 1	-43.15	-42.85		
-43 dBVrms, Ch 2	-43.15	-42.85		
-43 dBVrms, Ch 3	-43.15	-42.85		
-43 dBVrms, Ch 4	-43.15	-42.85		
-35 dBVrms, Ch 1	-35.15	-34.85		

Serial Number: _____ Report Number: _____
Test Date: __/__/__

Amplitude Accuracy (continued)

Measurement	Lower Limit	Upper Limit (dBfs)	Measured Value (dBfs)	Pass/Fail
-35 dBVrms, Ch 2	-35.15	-34.85		
-35 dBVrms, Ch 3	-35.15	-34.85		
-35 dBVrms, Ch 4	-35.15	-34.85		
-27 dBVrms, Ch 1	-27.15	-26.85		
-27 dBVrms, Ch 2	-27.15	-26.85		
-27 dBVrms, Ch 3	-27.15	-26.85		
-27 dBVrms, Ch 4	-27.15	-26.85		
-11 dBVrms, Ch 1	-11.15	-10.85		
-11 dBVrms, Ch 2	-11.15	-10.85		
-11 dBVrms, Ch 3	-11.15	-10.85		
-11 dBVrms, Ch 4	-11.15	-10.85		
1 dBVrms, Ch 1	0.85	1.15		
1 dBVrms, Ch 2	0.85	1.15		
1 dBVrms, Ch 3	0.85	1.15		
1 dBVrms, Ch 4	0.85	1.15		
9 dBVrms, Ch 1	8.85	9.15		
9 dBVrms, Ch 2	8.85	9.15		
9 dBVrms, Ch 3	8.85	9.15		
9 dBVrms, Ch 4	8.85	9.15		
19 dBVrms, Ch 1	18.85	19.15		
19 dBVrms, Ch 2	18.85	19.15		
19 dBVrms, Ch 3	18.85	19.15		
19 dBVrms, Ch 4	18.85	19.15		
27 dBVrms, Ch 1	26.85	27.15		
27 dBVrms, Ch 2	26.85	27.15		
27 dBVrms, Ch 3	26.85	27.15		
27 dBVrms, Ch 4	26.85	27.15		

Serial Number: _____ **Report Number:** _____
Test Date: ___/___/___

Flatness

Measurement	Lower Limit (dB)	Upper Limit (dB)	Measured Value (dB)	Pass/Fail
27 dBVrms, 51.2 kHz, One Ch, Ch 1	-0.2	0.2		
9 dBVrms, 51.2 kHz, One Ch, Ch 1	-0.2	0.2		
-11 dBVrms, 51.2 kHz, One Ch, Ch 1	-0.2	0.2		
27 dBVrms, 51.2 kHz, Two Ch, Ch 1	-0.2	0.2		
27 dBVrms, 51.2 kHz, Two Ch, Ch 2	-0.2	0.2		
9 dBVrms, 51.2 kHz, Two Ch, Ch 1	-0.2	0.2		
9 dBVrms, 51.2 kHz, Two Ch, Ch 2	-0.2	0.2		
-11 dBVrms, 51.2 kHz, Two Ch, Ch 1	-0.2	0.2		
-11 dBVrms, 51.2 kHz, Two Ch, Ch 2	-0.2	0.2		
27 dBVrms, 25.6 kHz, Four Ch, Ch 1	-0.2	0.2		
27 dBVrms, 25.6 kHz, Four Ch, Ch 2	-0.2	0.2		
27 dBVrms, 25.6 kHz, Four Ch, Ch 3	-0.2	0.2		
27 dBVrms, 25.6 kHz, Four Ch, Ch 4	-0.2	0.2		
9 dBVrms, 25.6 kHz, Four Ch, Ch 1	-0.2	0.2		
9 dBVrms, 25.6 kHz, Four Ch, Ch 2	-0.2	0.2		
9 dBVrms, 25.6 kHz, Four Ch, Ch 3	-0.2	0.2		
9 dBVrms, 25.6 kHz, Four Ch, Ch 4	-0.2	0.2		
-11 dBVrms, 25.6 kHz, Four Ch, Ch 1	-0.2	0.2		
-11 dBVrms, 25.6 kHz, Four Ch, Ch 2	-0.2	0.2		
-11 dBVrms, 25.6 kHz, Four Ch, Ch 3	-0.2	0.2		
-11 dBVrms, 25.6 kHz, Four Ch, Ch 4	-0.2	0.2		

Serial Number: _____ Report Number: _____
Test Date: __/__/__

Amplitude Linearity

Measurement	Lower Limit (dB)	Upper Limit (dB)	Measured Value (dB)	Pass/Fail
13 dBVrms, Ch 1	-0.0615	0.061		
13 dBVrms, Ch 2	-0.0615	0.061		
13 dBVrms, Ch 3	-0.0615	0.061		
13 dBVrms, Ch 4	-0.0615	0.061		
-1 dBVrms, Ch 1	-0.105	0.104		
-1 dBVrms, Ch 2	-0.105	0.104		
-1 dBVrms, Ch 3	-0.105	0.104		
-1 dBVrms, Ch 4	-0.105	0.104		
-15 dBVrms, Ch 1	-0.33	0.318		
-15 dBVrms, Ch 2	-0.33	0.318		
-15 dBVrms, Ch 3	-0.33	0.318		
-15 dBVrms, Ch 4	-0.33	0.318		
-29 dBVrms, Ch 1	-1.551	1.316		
-29 dBVrms, Ch 2	-1.551	1.316		
-29 dBVrms, Ch 3	-1.551	1.316		
-29 dBVrms, Ch 4	-1.551	1.316		
-43 dBVrms, Ch 1	-13.823	5.088		
-43 dBVrms, Ch 2	-13.823	5.088		
-43 dBVrms, Ch 3	-13.823	5.088		
-43 dBVrms, Ch 4	-13.823	5.088		
-53 dBVrms, Ch 1	-30.116	10.896		
-53 dBVrms, Ch 2	-30.116	10.896		
-53 dBVrms, Ch 3	-30.116	10.896		
-53 dBVrms, Ch 4	-30.116	10.896		

Serial Number: _____ **Report Number:** _____
Test Date: ___/___/___

A-Weight Filter

Measurement	Lower Limit (dB)	Upper Limit (dB)	Measured Value (dB)	Pass/Fail
Ch 1, 10 Hz	-5	2		
Ch 2, 10 Hz	-5	2		
Ch 3, 10 Hz	-5	2		
Ch 4, 10 Hz	-5	2		
Ch 1, 31.62 Hz	-1	1		
Ch 2, 31.62 Hz	-1	1		
Ch 3, 31.62 Hz	-1	1		
Ch 4, 31.62 Hz	-1	1		
Ch 1, 100 Hz	-0.7	0.7		
Ch 2, 100 Hz	-0.7	0.7		
Ch 3, 100 Hz	-0.7	0.7		
Ch 4, 100 Hz	-0.7	0.7		
Ch 1, 1000 Hz	-0.7	0.7		
Ch 2, 1000 Hz	-0.7	0.7		
Ch 3, 1000 Hz	-0.7	0.7		
Ch 4, 1000 Hz	-0.7	0.7		
Ch 1, 10000 Hz	-3	2		
Ch 2, 10000 Hz	-3	2		
Ch 3, 10000 Hz	-3	2		
Ch 4, 10000 Hz	-3	2		
Ch 1, 25120 Hz	-4.5	2.4		
Ch 2, 25120 Hz	-4.5	2.4		
Ch 3, 25120 Hz	-4.5	2.4		
Ch 4, 25120 Hz	-4.5	2.4		

Serial Number: _____ Report Number: _____
Test Date: ___/___/___

Channel Match

Measurement	Lower Limit	Upper Limit	Measured Value	Pass/Fail
Two Ch, 2/1, 7 dBV FS Mag	-0.04	0.04		
Two Ch, 2/1, 7 dBV FS Phs	-0.5	0.5		
Two Ch, 2/1, -13 dBV FS Mag	-0.04	0.04		
Two Ch, 2/1, -13 dBV FS Phs	-0.5	0.5		
Two Ch, 2/1, -33 dBV FS Mag	-0.04	0.04		
Two Ch, 2/1, -33 dBV FS Phs	-0.5	0.5		
Two Ch, 2/1, 7 dBV -20 dBfs Mag	-0.08	0.08		
Two Ch, 2/1, 7 dBV -20 dBfs Phs	-0.5	0.5		
Four Ch, 2/1, 7 dBV FS Mag	-0.04	0.04		
Four Ch, 2/1, 7 dBV FS Phs	-0.5	0.5		
Four Ch, 2/1, -13 dBV FS Mag	-0.04	0.04		
Four Ch, 2/1, -13 dBV FS Phs	-0.5	0.5		
Four Ch, 2/1, -33 dBV FS Mag	-0.04	0.04		
Four Ch, 2/1, -33 dBV FS Phs	-0.5	0.5		
Four Ch, 2/1, 7 dBV -20 dBfs Mag	-0.08	0.08		
Four Ch, 2/1, 7 dBV -20 dBfs Phs	-0.5	0.5		
Four Ch, 3/1, 7 dBV FS Mag	-0.04	0.04		
Four Ch, 3/1, 7 dBV FS Phs	-0.5	0.5		
Four Ch, 3/1, -13 dBV FS Mag	-0.04	0.04		
Four Ch, 3/1, -13 dBV FS Phs	-0.5	0.5		
Four Ch, 3/1, -33 dBV FS Mag	-0.04	0.04		
Four Ch, 3/1, -33 dBV FS Phs	-0.5	0.5		
Four Ch, 3/1, 7 dBV -20 dBfs Mag	-0.08	0.08		
Four Ch, 3/1, 7 dBV -20 dBfs Phs	-0.5	0.5		
Four Ch, 4/1, 7 dBV FS Mag	-0.04	0.04		
Four Ch, 4/1, 7 dBV FS Phs	-0.5	0.5		
Four Ch, 4/1, -13 dBV FS Mag	-0.04	0.04		

Serial Number: _____ **Report Number:** _____
Test Date: ___/___/___

Measurement	Lower Limit	Upper Limit	Measured Value	Pass/Fail
Four Ch, 4/1, -13 dBV FS Phs	-0.5	0.5		
Four Ch, 4/1, -33 dBV FS Mag	-0.04	0.04		
Four Ch, 4/1, -33 dBV FS Phs	-0.5	0.5		
Four Ch, 4/1, 7 dBV -20 dBfs Mag	-0.08	0.08		
Four Ch, 4/1, 7 dBV -20 dBfs Phs	-0.5	0.5		
Four Ch, 4/3, 7 dBV FS Mag	-0.04	0.04		
Four Ch, 4/3, 7 dBV FS Phs	-0.5	0.5		
Four Ch, 4/3, -13 dBV FS Mag	-0.04	0.04		
Four Ch, 4/3, -13 dBV FS Phs	-0.5	0.5		
Four Ch, 4/3, -33 dBV FS Mag	-0.04	0.04		
Four Ch, 4/3, -33 dBV FS Phs	-0.5	0.5		
Four Ch, 4/3, 7 dBV -20 dBfs Mag	-0.08	0.08		
Four Ch, 4/3, 7 dBV -20 dBfs Phs	-0.5	0.5		

Serial Number: _____ Report Number: _____
Test Date: __/__/__

Frequency Accuracy

Measurement	Lower Limit (kHz)	Upper Limit (kHz)	Measured Value (kHz)	Pass/Fail
50 kHz	49.9985	50.0015		

Anti-Alias Filter

Measurement	Lower Limit (dBfs)	Upper Limit (dBfs)	Measured Value (dBfs)	Pass/Fail
One Ch, Ch 1, 51.2 kHz		-80		
Two Ch, Ch 1, 51.2 kHz		-80		
Two Ch, Ch 2, 51.2 kHz		-80		
Four Ch, Ch 1, 25.6 kHz		-80		
Four Ch, Ch 2, 25.6 kHz		-80		
Four Ch, Ch 3, 25.6 kHz		-80		
Four Ch, Ch 4, 25.6 kHz		-80		

Input Coupling

Measurement	Lower Limit (dB)	Upper Limit (dB)	Measured Value (dB)	Pass/Fail
dc - ac, Ch 1		3		
dc - ac, Ch 2		3		
dc - ac, Ch 3		3		
dc - ac, Ch 4		3		

Serial Number: _____ *Report Number:* _____
Test Date: ___/___/___

Harmonic Distortion

Measurement	Lower Limit	Upper Limit (dBfs)	Measured Value (dBfs)	Pass/Fail
Two Ch, 12.25 kHz 2nd, Ch 1		-80		
Two Ch, 12.25 kHz 2nd, Ch 2		-80		
Four Ch, 12.25 kHz 2nd, Ch 1		-80		
Four Ch, 12.25 kHz 2nd, Ch 2		-80		
Four Ch, 12.25 kHz 2nd, Ch 3		-80		
Four Ch, 12.25 kHz 2nd, Ch 4		-80		
Two Ch, 8.167 kHz 3rd, Ch 1		-80		
Two Ch, 8.167 kHz 3rd, Ch 2		-80		
Four Ch, 8.167 kHz 3rd, Ch 1		-80		
Four Ch, 8.167 kHz 3rd, Ch 2		-80		
Four Ch, 8.167 kHz 3rd, Ch 3		-80		
Four Ch, 8.167 kHz 3rd, Ch 4		-80		
Two Ch, 6.125 kHz 4th, Ch 1		-80		
Two Ch, 6.125 kHz 4th, Ch 2		-80		
Four Ch, 6.125 kHz 4th, Ch 1		-80		
Four Ch, 6.125 kHz 4th, Ch 2		-80		
Four Ch, 6.125 kHz 4th, Ch 3		-80		
Four Ch, 6.125 kHz 4th, Ch 4		-80		
Two Ch, 4.9 kHz 5th, Ch 1		-80		
Two Ch, 4.9 kHz 5th, Ch 2		-80		
Four Ch, 4.9 kHz 5th, Ch 1		-80		
Four Ch, 4.9 kHz 5th, Ch 2		-80		
Four Ch, 4.9 kHz 5th, Ch 3		-80		
Four Ch, 4.9 kHz 5th, Ch 4		-80		

Serial Number: _____ Report Number: _____
Test Date: __/__/__

Intermodulation Distortion

Measurement	Lower Limit	Upper Limit (dBfs)	Measured Value (dBfs)	Pass/Fail
Two Ch, F1+F2, 1952 Hz, Ch 1		-80		
Two Ch, F1+F2, 1952 Hz, Ch 2		-80		
Two Ch, F1-2F2, 1048 Hz, Ch 1		-80		
Two Ch, F1-2F2, 1048 Hz, Ch 2		-80		
Two Ch, F1+F2, 48.048 kHz, Ch 1		-80		
Two Ch, F1+F2, 48.048 kHz, Ch 2		-80		
Two Ch, F1+F2, 33.024 kHz, Ch 1		-80		
Two Ch, F1+F2, 33.024 kHz, Ch 2		-80		
Two Ch, F1-2F2, 49.096 kHz, Ch 1		-80		
Two Ch, F1-2F2, 49.096 kHz, Ch 2		-80		
Four Ch, F1+F2, 1952 Hz, Ch 1		-80		
Four Ch, F1+F2, 1952 Hz, Ch 2		-80		
Four Ch, F1+F2, 1952 Hz, Ch 3		-80		
Four Ch, F1+F2, 1952 Hz, Ch 4		-80		
Four Ch, F1-2F2, 1048 Hz, Ch 1		-80		
Four Ch, F1-2F2, 1048 Hz, Ch 2		-80		
Four Ch, F1-2F2, 1048 Hz, Ch 3		-80		
Four Ch, F1-2F2, 1048 Hz, Ch 4		-80		
Four Ch, F1+F2, 24048 Hz, Ch 1		-80		
Four Ch, F1+F2, 24048 Hz, Ch 2		-80		
Four Ch, F1+F2, 24048 Hz, Ch 3		-80		
Four Ch, F1+F2, 24048 Hz, Ch 4		-80		
Four Ch, F1+F2, 17488 Hz, Ch 1		-80		
Four Ch, F1+F2, 17488 Hz, Ch 2		-80		
Four Ch, F1+F2, 17488 Hz, Ch 3		-80		
Four Ch, F1+F2, 17488 Hz, Ch 4		-80		
Four Ch, F1-2F2, 24096 Hz, Ch 1		-80		

Serial Number: _____ **Report Number:** _____
Test Date: ___/___/___

Measurement	Lower Limit	Upper Limit (dBfs)	Measured Value (dBfs)	Pass/Fail
Four Ch, F1-2F2, 24096 Hz, Ch 2		-80		
Four Ch, F1-2F2, 24096 Hz, Ch 3		-80		
Four Ch, F1-2F2, 24096 Hz, Ch 4		-80		

Cross Talk

Measurement	Lower Limit	Upper Limit (dBVrms)	Measured Value (dBVrms)	Pass/Fail
Source-to-Ch 1		-126		
Source-to-Ch 2		-126		
Source-to-Ch 3		-126		
Source-to-Ch 4		-126		
Receiver Ch 1, Driver Ch 2, 3, 4		-126		
Receiver Ch 2, Driver Ch 1, 3, 4		-126		
Receiver Ch 3, Driver Ch 1, 2, 4		-126		
Receiver Ch 4, Driver Ch 1, 2, 3		-126		

Single Ch Phase Accuracy

Measurement	Lower Limit (deg)	Upper Limit (deg)	Measured Value (deg)	Pass/Fail
Positive slope, Ch 1	-4	4		
Positive slope, Ch 2	-4	4		
Positive slope, Ch 3	-4	4		
Positive slope, Ch 4	-4	4		
Negative slope, Ch 1	-4	4		
Negative slope, Ch 2	-4	4		
Negative slope, Ch 3	-4	4		
Negative slope, Ch 4	-4	4		

Serial Number: _____ Report Number: _____
Test Date: __/__/__

External Trigger

Measurement	Lower Limit (%)	Upper Limit (%)	Measured Value (%)	Pass/Fail
8 V Pos	-10	10		
8 V Neg	-10	10		
-8 V Pos	-10	10		
-8 V Neg	-10	10		

Input Resistance

Measurement	Lower Limit (%)	Upper Limit (%)	Measured Value (%)	Pass/Fail
27 dBVrms, Ch 1	-10	10		
9 dBVrms, Ch 1	-10	10		
-11 dBVrms, Ch 1	-10	10		
27 dBVrms, Ch 2	-10	10		
9 dBVrms, Ch 2	-10	10		
-11 dBVrms, Ch 2	-10	10		
27 dBVrms, Ch 3	-10	10		
9 dBVrms, Ch 3	-10	10		
-11 dBVrms, Ch 3	-10	10		
27 dBVrms, Ch 4	-10	10		
9 dBVrms, Ch 4	-10	10		
-11 dBVrms, Ch 4	-10	10		

Serial Number: _____ Report Number: _____
 Test Date: __/__/__

ICP Supply

Measurement	Lower Limit	Upper Limit	Measured Value	Pass/Fail
Ch 1 Open Circuit Voltage	26 Vdc	32 Vdc	Vdc	
Ch 2 Open Circuit Voltage	26 Vdc	32 Vdc	Vdc	
Ch 31 Open Circuit Voltage	26 Vdc	32 Vdc	Vdc	
Ch 4 Open Circuit Voltage	26 Vdc	32 Vdc	Vdc	
Ch 1 Current	2.75 mA	5.75 mA	mA	
Ch 2 Current	2.75 mA	5.75 mA	mA	
Ch 3 Current	2.75 mA	5.75 mA	mA	
Ch 4 Current	2.75 mA	5.75 mA	mA	

Source Amplitude Accuracy

Measurement	Lower Limit (%)	Upper Limit (%)	Measured Value (%)	Pass/Fail
1 kHz, 0.1 Vpk	-4	4		
1 kHz, 3.0 Vpk	-4	4		
1 kHz, 5.0 Vpk	-4	4		

Source Output Resistance

Measurement	Lower Limit (ohm)	Upper Limit (ohm)	Measured Value (ohm)	Pass/Fail
Resistance		5		

Serial Number: _____ **Report Number:** _____
Test Date: ___/___/___

Source DC Offset

Measurement	Lower Limit (mVdc)	Upper Limit (mVdc)	Measured Value (mVdc)	Pass/Fail
0 Vdc, 0 Vac(pk)	-15	15		
-10 Vdc, 0 Vac(pk)	-315	315		
+10 Vdc, 0 Vac(pk)	-315	315		
-5 Vdc, 5 Vac(pk)	-315	315		
+5 Vdc, 5 Vac(pk)	-315	315		
0 Vdc, 5 Vac(pk)	-165	165		

Source Flatness

Measurement	Lower Limit (dB)	Upper Limit (dB)	Measured Value (dB)	Pass/Fail
12.8 kHz	-1	1		
25.6 kHz	-1	1		
51.2 kHz	-1	1		

Source Distortion

Measurement	Lower Limit	Upper Limit (dBc)	Measured Value (dBc)	Pass/Fail
12.8 kHz		-60		
51.2 kHz		-40		

Operation Verification Test Record - Two Channel

Test Facility _____

Facility Address _____

Tested By _____

Report Number _____

Customer Name _____

Serial Number _____

Installed Options _____

Date _____

Temperature _____

Humidity _____

Power Line Frequency _____

Test Instruments Used

Instrument	Model	ID or Serial Number	Calibration Due
AC Calibrator			
Synthesizer 1			
Synthesizer 2			
Low-D Oscillator			
Multimeter			

Serial Number: _____ **Report Number:** _____
Test Date: ___/___/___

Self Test

Measurement	Lower Limit	Upper Limit	Measured Value	Pass/Fail
Long Confidence				

DC Offset

Measurement	Lower Limit	Upper Limit (dBfs)	Measured Value (dBfs)	Pass/Fail
-51 dBVrms, Ch 1		-15		
-51 dBVrms, Ch 2		-15		
-35 dBVrms, Ch 1		-30		
-35 dBVrms, Ch 2		-30		

Noise

Measurement	Lower Limit	Upper Limit (dBV/\sqrt{Hz})	Measured Value (dBV/\sqrt{Hz})	Pass/Fail
Two Ch, 6.4 kHz Span, Ch 1		-130		
Two Ch, 6.4 kHz Span, Ch 2		-130		
Two Ch, 51.2 kHz Span, Ch 1		-140		
Two Ch, 51.2 kHz Span, Ch 2		-140		
One Ch, 102.4 kHz Span, Ch 1		-140		

Serial Number: _____ **Report Number:** _____
Test Date: ___/___/___

Spurious Signals

Measurement	Lower Limit	Upper Limit (dBfs)	Measured Value (dBfs)	Pass/Fail
Two Ch, 0 Hz Start, Ch 1		-80		
Two Ch, 0 Hz Start, Ch 2		-80		
Two Ch, 200 Hz Start, Ch 1		-80		
Two Ch, 200 Hz Start, Ch 2		-80		
Two Ch, 400 Hz Start, Ch 1		-80		
Two Ch, 400 Hz Start, Ch 2		-80		
Two Ch, 600 Hz Start, Ch 1		-80		
Two Ch, 600 Hz Start, Ch 2		-80		
Two Ch, 800 Hz Start, Ch 1		-80		
Two Ch, 800 Hz Start, Ch 2		-80		
Two Ch, 1000 Hz Start, Ch 1		-80		
Two Ch, 1000 Hz Start, Ch 2		-80		
Two Ch, 1200 Hz Start, Ch 1		-80		
Two Ch, 1200 Hz Start, Ch 2		-80		
Two Ch, 1400 Hz Start, Ch 1		-80		
Two Ch, 1400 Hz Start, Ch 2		-80		
Two Ch, 1600 Hz Start, Ch 1		-80		
Two Ch, 1600 Hz Start, Ch 2		-80		
Two Ch, 3200 Hz Start, Ch 1		-80		
Two Ch, 3200 Hz Start, Ch 2		-80		
Two Ch, 4800 Hz Start, Ch 1		-80		
Two Ch, 4800 Hz Start, Ch 2		-80		
Two Ch, 6400 Hz Start, Ch 1		-80		
Two Ch, 6400 Hz Start, Ch 2		-80		
Two Ch, 8000 Hz Start, Ch 1		-80		
Two Ch, 8000 Hz Start, Ch 2		-80		
Two Ch, 9600 Hz Start, Ch 1		-80		

Serial Number: _____ *Report Number:* _____
Test Date: __/__/__

Spurious Signals (continued)

Measurement	Lower Limit	Upper Limit (dBfs)	Measured Value (dBfs)	Pass/Fail
Two Ch, 9600 Hz Start, Ch 2		-80		
Two Ch, 11200 Hz Start, Ch 1		-80		
Two Ch, 11200 Hz Start, Ch 2		-80		
Two Ch, 12800 Hz Start, Ch 1		-80		
Two Ch, 12800 Hz Start, Ch 2		-80		
Two Ch, 14400 Hz Start, Ch 1		-80		
Two Ch, 14400 Hz Start, Ch 2		-80		
Two Ch, 16000 Hz Start, Ch 1		-80		
Two Ch, 16000 Hz Start, Ch 2		-80		
Two Ch, 17600 Hz Start, Ch 1		-80		
Two Ch, 17600 Hz Start, Ch 2		-80		
Two Ch, 19200 Hz Start, Ch 1		-80		
Two Ch, 19200 Hz Start, Ch 2		-80		
Two Ch, 20800 Hz Start, Ch 1		-80		
Two Ch, 20800 Hz Start, Ch 2		-80		
Two Ch, 22400 Hz Start, Ch 1		-80		
Two Ch, 22400 Hz Start, Ch 2		-80		
Two Ch, 24000 Hz Start, Ch 1		-80		
Two Ch, 24000 Hz Start, Ch 2		-80		
Two Ch, 25600 Hz Start, Ch 1		-80		
Two Ch, 25600 Hz Start, Ch 2		-80		
Two Ch, 27200 Hz Start, Ch 1		-80		
Two Ch, 27200 Hz Start, Ch 2		-80		
Two Ch, 28800 Hz Start, Ch 1		-80		
Two Ch, 28800 Hz Start, Ch 2		-80		
Two Ch, 30400 Hz Start, Ch 1		-80		
Two Ch, 30400 Hz Start, Ch 2		-80		

Serial Number: _____ **Report Number:** _____
Test Date: ___/___/___

Spurious Signals (continued)

Measurement	Lower Limit	Upper Limit (dBfs)	Measured Value (dBfs)	Pass/Fail
Two Ch, 32000 Hz Start, Ch 1		-80		
Two Ch, 32000 Hz Start, Ch 2		-80		
Two Ch, 33600 Hz Start, Ch 1		-80		
Two Ch, 33600 Hz Start, Ch 2		-80		
Two Ch, 35200 Hz Start, Ch 1		-80		
Two Ch, 35200 Hz Start, Ch 2		-80		
Two Ch, 36800 Hz Start, Ch 1		-80		
Two Ch, 36800 Hz Start, Ch 2		-80		
Two Ch, 38400 Hz Start, Ch 1		-80		
Two Ch, 38400 Hz Start, Ch 2		-80		
Two Ch, 40000 Hz Start, Ch 1		-80		
Two Ch, 40000 Hz Start, Ch 2		-80		
Two Ch, 41600 Hz Start, Ch 1		-80		
Two Ch, 41600 Hz Start, Ch 2		-80		
Two Ch, 43200 Hz Start, Ch 1		-80		
Two Ch, 43200 Hz Start, Ch 2		-80		
Two Ch, 44800 Hz Start, Ch 1		-80		
Two Ch, 44800 Hz Start, Ch 2		-80		
Two Ch, 46400 Hz Start, Ch 1		-80		
Two Ch, 46400 Hz Start, Ch 2		-80		
Two Ch, 48000 Hz Start, Ch 1		-80		
Two Ch, 48000 Hz Start, Ch 2		-80		
Two Ch, 49600 Hz Start, Ch 1		-80		
Two Ch, 49600 Hz Start, Ch 2		-80		
One Ch, 79200 Start, Ch 1		-80		
One Ch, 80800 Start, Ch 1		-80		
One Ch, 85600 Start, Ch 1		-80		

Serial Number: _____ *Report Number:* _____
Test Date: ___/___/___

Measurement	Lower Limit	Upper Limit (dBfs)	Measured Value (dBfs)	Pass/Fail
One Ch, 87200 Start, Ch 1		-80		
One Ch, 88800 Start, Ch 1		-80		
One Ch, 97000 Start, Ch 1		-80		
One Ch, 98600 Start, Ch 1		-80		
One Ch, 100200 Start, Ch 1		-80		
One Ch, 101800 Start, Ch 1		-80		

Amplitude Accuracy

Measurement	Lower Limit (dBVrms)	Upper Limit (dBVrms)	Measured Value (dBVrms)	Pass/Fail
-51 dBVrms, Ch 1	-51.15	-50.85		
-51 dBVrms, Ch 2	-51.15	-50.85		
-43 dBVrms, Ch 1	-43.15	-42.85		
-43 dBVrms, Ch 2	-43.15	-42.85		
-35 dBVrms, Ch 1	-35.15	-34.85		
-35 dBVrms, Ch 2	-35.15	-34.85		
-27 dBVrms, Ch 1	-27.15	-26.85		
-27 dBVrms, Ch 2	-27.15	-26.85		
-11 dBVrms, Ch 1	-11.15	-10.85		
-11 dBVrms, Ch 2	-11.15	-10.85		
1 dBVrms, Ch 1	0.85	1.15		
1 dBVrms, Ch 2	0.85	1.15		
9 dBVrms, Ch 1	8.85	9.15		
9 dBVrms, Ch 2	8.85	9.15		
19 dBVrms, Ch 1	18.85	19.15		
19 dBVrms, Ch 2	18.85	19.15		
27 dBVrms, Ch 1	26.85	27.15		
27 dBVrms, Ch 2	26.85	27.15		

Serial Number: _____ **Report Number:** _____
Test Date: ___/___/___

Flatness

Measurement	Lower Limit (dB)	Upper Limit (dB)	Measured Value (dB)	Pass/Fail
27 dBVrms, 99.84 kHz, One Ch, Ch 1	-0.2	0.2		
9 dBVrms, 99.84 kHz, One Ch, Ch 1	-0.2	0.2		
-11 dBVrms, 99.84 kHz, One Ch, Ch 1	-0.2	0.2		
27 dBVrms, 51.2 kHz, Two Ch, Ch 1	-0.2	0.2		
27 dBVrms, 51.2 kHz, Two Ch, Ch 2	-0.2	0.2		
9 dBVrms, 51.2 kHz, Two Ch, Ch 1	-0.2	0.2		
9 dBVrms, 51.2 kHz, Two Ch, Ch 2	-0.2	0.2		
-11 dBVrms, 51.2 kHz, Two Ch, Ch 1	-0.2	0.2		
-11 dBVrms, 51.2 kHz, Two Ch, Ch 2	-0.2	0.2		

Amplitude Linearity

Measurement	Lower Limit (dB)	Upper Limit (dB)	Measured Value (dB)	Pass/Fail
13 dBVrms, Ch 1	-0.0615	0.061		
13 dBVrms, Ch 2	-0.0615	0.061		
-1 dBVrms, Ch 1	-0.105	0.104		
-1 dBVrms, Ch 2	-0.105	0.104		
-15 dBVrms, Ch 1	-0.33	0.318		
-15 dBVrms, Ch 2	-0.33	0.318		
-29 dBVrms, Ch 1	-1.551	1.316		
-29 dBVrms, Ch 2	-1.551	1.316		
-43 dBVrms, Ch 1	-13.823	5.088		
-43 dBVrms, Ch 2	-13.823	5.088		
-53 dBVrms, Ch 1	-30.116	10.896		
-53 dBVrms, Ch 2	-30.116	10.896		

Serial Number: _____ Report Number: _____
 Test Date: __/__/__

A-Weight Filter

Measurement	Lower Limit (dB)	Upper Limit (dB)	Measured Value (dB)	Pass/Fail
Ch 1, 10 Hz	-5	2		
Ch 2, 10 Hz	-5	2		
Ch 1, 31.62 Hz	-1	1		
Ch 2, 31.62 Hz	-1	1		
Ch 1, 100 Hz	-0.7	0.7		
Ch 2, 100 Hz	-0.7	0.7		
Ch 1, 1000 Hz	-0.7	0.7		
Ch 2, 1000 Hz	-0.7	0.7		
Ch 1, 10000 Hz	-3	2		
Ch 2, 10000 Hz	-3	2		
Ch 1, 25120 Hz	-4.5	2.4		
Ch 2, 25120 Hz	-4.5	2.4		

Channel Match

Measurement	Lower Limit	Upper Limit	Measured Value	Pass/Fail
Two Ch, 2/1, 7 dBV FS Mag	-0.04 dB	0.04 dB	dB	
Two Ch, 2/1, 7 dBV FS Phs	-0.5 deg	0.5 deg	deg	
Two Ch, 2/1, -13 dBV FS Mag	-0.04 dB	0.04 dB	dB	
Two Ch, 2/1, -13 dBV FS Phs	-0.5 deg	0.5 deg	deg	
Two Ch, 2/1, -33 dBV FS Mag	-0.04 dB	0.04 dB	dB	
Two Ch, 2/1, -33 dBV FS Phs	-0.5 deg	0.5 deg	deg	
Two Ch, 2/1, 7 dBV -20dBfs Mag	-0.08 dB	0.08 dB	dB	
Two Ch, 2/1, 7 dBV -20dBfs Phs	-0.5 deg	0.5 deg	deg	

Serial Number: _____ **Report Number:** _____
Test Date: ___/___/___

Frequency Accuracy

Measurement	Lower Limit (kHz)	Upper Limit (kHz)	Measured Value (kHz)	Pass/Fail
50 kHz	49.9985	50.0015		

Single Ch Phase Accuracy

Measurement	Lower Limit (deg)	Upper Limit (deg)	Measured Value (deg)	Pass/Fail
Positive slope, Ch 1	-4	4		
Positive slope, Ch 2	-4	4		
Negative slope, Ch 1	-4	4		
Negative slope, Ch 2	-4	4		

ICP Supply

Measurement	Lower Limit	Upper Limit	Measured Value	Pass/Fail
Ch 1 Open Circuit Voltage	26 Vdc	32 Vdc	Vdc	
Ch 2 Open Circuit Voltage	26 Vdc	32 Vdc	Vdc	
Ch 1 Current	2.75 mA	5.75 mA	mA	
Ch 2 Current	2.75 mA	5.75 mA	mA	

Serial Number: _____ Report Number: _____
 Test Date: __/__/__

Source Amplitude Accuracy

Measurement	Lower Limit (%)	Upper Limit (%)	Measured Value (%)	Pass/Fail
1 kHz, 0.1 Vpk	-4	4		
1 kHz, 3.0 Vpk	-4	4		
1 kHz, 5.0 Vpk	-4	4		

Source Flatness

Measurement	Lower Limit (dB)	Upper Limit (dB)	Measured Value (dB)	Pass/Fail
12.8 kHz	-1	1		
25.6 kHz	-1	1		
51.2 kHz	-1	1		
102.4 kHz	-1	1		

Source Distortion

Measurement	Lower Limit (dBc)	Upper Limit (dBc)	Measured Value (dBc)	Pass/Fail
12.8 kHz		-60		
51.2 kHz		-40		
102.4 kHz		-40		

Operation Verification Test Record - Four Channel

Test Facility _____

Facility Address _____

Tested By _____

Report Number _____

Customer Name _____

Serial Number _____

Installed Options _____

Date _____

Temperature _____

Humidity _____

Power Line Frequency _____

Test Instruments Used

Instrument	Model	ID or Serial Number	Calibration Due
AC Calibrator			
Synthesizer 1			
Synthesizer 2			
Low-D Oscillator			
Multimeter			

Serial Number: _____ **Report Number:** _____
Test Date: ___/___/___

Self Test

Measurement	Lower Limit	Upper Limit	Measured Value	Pass/Fail
Long Confidence				

DC Offset

Measurement	Lower Limit	Upper Limit (dBfs)	Measured Value (dBfs)	Pass/Fail
-51 dBVrms, Ch 1		-15		
-51 dBVrms, Ch 2		-15		
-51 dBVrms, Ch 3		-15		
-51 dBVrms, Ch 4		-15		
-35 dBVrms, Ch 1		-30		
-35 dBVrms, Ch 2		-30		
-35 dBVrms, Ch 3		-30		
-35 dBVrms, Ch 4		-30		

Noise

Measurement	Lower Limit	Upper Limit (dBV/√Hz)	Measured Value (dBV/√Hz)	Pass/Fail
Four Ch, 6.4 kHz Span, Ch 1		-130		
Four Ch, 6.4 kHz Span, Ch 2		-130		
Four Ch, 6.4 kHz Span, Ch 3		-130		
Four Ch, 6.4 kHz Span, Ch 4		-130		
Four Ch, 25.6 kHz Span, Ch 1		-140		
Four Ch, 25.6 kHz Span, Ch 2		-140		
Four Ch, 25.6 kHz Span, Ch 3		-140		
Four Ch, 25.6 kHz Span, Ch 4		-140		
Two Ch, 51.2 kHz Span, Ch 1		-140		
Two Ch, 51.2 kHz Span, Ch 2		-140		

Serial Number: _____ **Report Number:** _____
Test Date: ___/___/___

Spurious Signals

Measurement	Lower Limit	Upper Limit (dBfs)	Measured Value (dBfs)	Pass/Fail
Four Ch, 0 Hz Start, Ch 1		-80		
Four Ch, 0 Hz Start, Ch 2		-80		
Four Ch, 0 Hz Start, Ch 3		-80		
Four Ch, 0 Hz Start, Ch 4		-80		
Four Ch, 200 Hz Start, Ch 1		-80		
Four Ch, 200 Hz Start, Ch 2		-80		
Four Ch, 200 Hz Start, Ch 3		-80		
Four Ch, 200 Hz Start, Ch 4		-80		
Four Ch, 400 Hz Start, Ch 1		-80		
Four Ch, 400 Hz Start, Ch 2		-80		
Four Ch, 400 Hz Start, Ch 3		-80		
Four Ch, 400 Hz Start, Ch 4		-80		
Four Ch, 600 Hz Start, Ch 1		-80		
Four Ch, 600 Hz Start, Ch 2		-80		
Four Ch, 600 Hz Start, Ch 3		-80		
Four Ch, 600 Hz Start, Ch 4		-80		
Four Ch, 800 Hz Start, Ch 1		-80		
Four Ch, 800 Hz Start, Ch 2		-80		
Four Ch, 800 Hz Start, Ch 3		-80		
Four Ch, 800 Hz Start, Ch 4		-80		
Four Ch, 1000 Hz Start, Ch 1		-80		
Four Ch, 1000 Hz Start, Ch 2		-80		
Four Ch, 1000 Hz Start, Ch 3		-80		
Four Ch, 1000 Hz Start, Ch 4		-80		
Four Ch, 1200 Hz Start, Ch 1		-80		
Four Ch, 1200 Hz Start, Ch 2		-80		
Four Ch, 1200 Hz Start, Ch 3		-80		

Verifying Specifications
 Operation Verification Test Record - Four Channel

Agilent 35670A

Serial Number: _____ *Report Number:* _____
Test Date: ___/___/___

Measurement	Lower Limit	Upper Limit (dBfs)	Measured Value (dBfs)	Pass/Fail
Four Ch, 1200 Hz Start, Ch 4		-80		
Four Ch, 1400 Hz Start, Ch 1		-80		
Four Ch, 1400 Hz Start, Ch 2		-80		
Four Ch, 1400 Hz Start, Ch 3		-80		
Four Ch, 1400 Hz Start, Ch 4		-80		
Four Ch, 1600 Hz Start, Ch 1		-80		
Four Ch, 1600 Hz Start, Ch 2		-80		
Four Ch, 1600 Hz Start, Ch 3		-80		
Four Ch, 1600 Hz Start, Ch 4		-80		
Four Ch, 3200 Hz Start, Ch 1		-80		
Four Ch, 3200 Hz Start, Ch 2		-80		
Four Ch, 3200 Hz Start, Ch 3		-80		
Four Ch, 3200 Hz Start, Ch 4		-80		
Four Ch, 4800 Hz Start, Ch 1		-80		
Four Ch, 4800 Hz Start, Ch 2		-80		
Four Ch, 4800 Hz Start, Ch 3		-80		
Four Ch, 4800 Hz Start, Ch 4		-80		
Four Ch, 6400 Hz Start, Ch 1		-80		
Four Ch, 6400 Hz Start, Ch 2		-80		
Four Ch, 6400 Hz Start, Ch 3		-80		
Four Ch, 6400 Hz Start, Ch 4		-80		
Four Ch, 8000 Hz Start, Ch 1		-80		
Four Ch, 8000 Hz Start, Ch 2		-80		
Four Ch, 8000 Hz Start, Ch 3		-80		
Four Ch, 8000 Hz Start, Ch 4		-80		
Four Ch, 9600 Hz Start, Ch 1		-80		
Four Ch, 9600 Hz Start, Ch 2		-80		

Serial Number: _____ **Report Number:** _____
Test Date: ___/___/___

Four Ch, 9600 Hz Start, Ch 3	-80
Four Ch, 9600 Hz Start, Ch 4	-80
Four Ch, 11200 Hz Start, Ch 1	-80
Four Ch, 11200 Hz Start, Ch 2	-80
Four Ch, 11200 Hz Start, Ch 3	-80
Four Ch, 11200 Hz Start, Ch 4	-80
Four Ch, 12800 Hz Start, Ch 1	-80
Four Ch, 12800 Hz Start, Ch 2	-80
Four Ch, 12800 Hz Start, Ch 3	-80
Four Ch, 12800 Hz Start, Ch 4	-80
Four Ch, 14400 Hz Start, Ch 1	-80
Four Ch, 14400 Hz Start, Ch 2	-80
Four Ch, 14400 Hz Start, Ch 3	-80
Four Ch, 14400 Hz Start, Ch 4	-80
Four Ch, 16000 Hz Start, Ch 1	-80
Four Ch, 16000 Hz Start, Ch 2	-80
Four Ch, 16000 Hz Start, Ch 3	-80
Four Ch, 16000 Hz Start, Ch 4	-80
Four Ch, 17600 Hz Start, Ch 1	-80
Four Ch, 17600 Hz Start, Ch 2	-80
Four Ch, 17600 Hz Start, Ch 3	-80
Four Ch, 17600 Hz Start, Ch 4	-80
Four Ch, 19200 Hz Start, Ch 1	-80
Four Ch, 19200 Hz Start, Ch 2	-80
Four Ch, 19200 Hz Start, Ch 3	-80
Four Ch, 19200 Hz Start, Ch 4	-80
Four Ch, 20800 Hz Start, Ch 1	-80
Four Ch, 20800 Hz Start, Ch 2	-80

Serial Number: _____ *Report Number:* _____
Test Date: ___/___/___

Spurious Signals (continued)

Measurement	Lower Limit	Upper Limit (dBfs)	Measured Value (dBfs)	Pass/Fail
Four Ch, 20800 Hz Start, Ch 3		-80		
Four Ch, 20800 Hz Start, Ch 4		-80		
Four Ch, 22400 Hz Start, Ch 1		-80		
Four Ch, 22400 Hz Start, Ch 2		-80		
Four Ch, 22400 Hz Start, Ch 3		-80		
Four Ch, 22400 Hz Start, Ch 4		-80		
Four Ch, 24000 Hz Start, Ch 1		-80		
Four Ch, 24000 Hz Start, Ch 2		-80		
Four Ch, 24000 Hz Start, Ch 3		-80		
Four Ch, 24000 Hz Start, Ch 4		-80		
Two Ch, 25600 Hz Start, Ch 1		-80		
Two Ch, 25600 Hz Start, Ch 2		-80		
Two Ch, 27200 Hz Start, Ch 1		-80		
Two Ch, 27200 Hz Start, Ch 2		-80		
Two Ch, 28800 Hz Start, Ch 1		-80		
Two Ch, 28800 Hz Start, Ch 2		-80		
Two Ch, 30400 Hz Start, Ch 1		-80		
Two Ch, 30400 Hz Start, Ch 2		-80		
Two Ch, 32000 Hz Start, Ch 1		-80		
Two Ch, 32000 Hz Start, Ch 2		-80		
Two Ch, 33600 Hz Start, Ch 1		-80		
Two Ch, 33600 Hz Start, Ch 2		-80		
Two Ch, 35200 Hz Start, Ch 1		-80		
Two Ch, 35200 Hz Start, Ch 2		-80		
Two Ch, 36800 Hz Start, Ch 1		-80		
Two Ch, 36800 Hz Start, Ch 2		-80		
Two Ch, 38400 Hz Start, Ch 1		-80		

Serial Number: _____ **Report Number:** _____
Test Date: ___/___/___

Spurious Signals (continued)

Measurement	Lower Limit	Upper Limit (dBfs)	Measured Value (dBfs)	Pass/Fail
Two Ch, 38400 Hz Start, Ch 2		-80		
Two Ch, 40000 Hz Start, Ch 1		-80		
Two Ch, 40000 Hz Start, Ch 2		-80		
Two Ch, 41600 Hz Start, Ch 1		-80		
Two Ch, 41600 Hz Start, Ch 2		-80		
Two Ch, 43200 Hz Start, Ch 1		-80		
Two Ch, 43200 Hz Start, Ch 2		-80		
Two Ch, 44800 Hz Start, Ch 1		-80		
Two Ch, 44800 Hz Start, Ch 2		-80		
Two Ch, 46400 Hz Start, Ch 1		-80		
Two Ch, 46400 Hz Start, Ch 2		-80		
Two Ch, 48000 Hz Start, Ch 1		-80		
Two Ch, 48000 Hz Start, Ch 2		-80		
Two Ch, 49600 Hz Start, Ch 1		-80		
Two Ch, 49600 Hz Start, Ch 2		-80		

Amplitude Accuracy

Measurement	Lower Limit (dBVrms)	Upper Limit (dBVrms)	Measured Value (dBVrms)	Pass/Fail
-51 dBVrms, Ch 1	-51.15	-50.85		
-51 dBVrms, Ch 2	-51.15	-50.85		
-51 dBVrms, Ch 3	-51.15	-50.85		
-51 dBVrms, Ch 4	-51.15	-50.85		
-43 dBVrms, Ch 1	-43.15	-42.85		
-43 dBVrms, Ch 2	-43.15	-42.85		
-43 dBVrms, Ch 3	-43.15	-42.85		
-43 dBVrms, Ch 4	-43.15	-42.85		
-35 dBVrms, Ch 1	-35.15	-34.85		

Serial Number: _____ Report Number: _____
 Test Date: __/__/__

Amplitude Accuracy (continued)

Measurement	Lower Limit	Upper Limit (dBfs)	Measured Value (dBfs)	Pass/Fail
-35 dBVrms, Ch 2	-35.15	-34.85		
-35 dBVrms, Ch 3	-35.15	-34.85		
-35 dBVrms, Ch 4	-35.15	-34.85		
-27 dBVrms, Ch 1	-27.15	-26.85		
-27 dBVrms, Ch 2	-27.15	-26.85		
-27 dBVrms, Ch 3	-27.15	-26.85		
-27 dBVrms, Ch 4	-27.15	-26.85		
-11 dBVrms, Ch 1	-11.15	-10.85		
-11 dBVrms, Ch 2	-11.15	-10.85		
-11 dBVrms, Ch 3	-11.15	-10.85		
-11 dBVrms, Ch 4	-11.15	-10.85		
1 dBVrms, Ch 1	0.85	1.15		
1 dBVrms, Ch 2	0.85	1.15		
1 dBVrms, Ch 3	0.85	1.15		
1 dBVrms, Ch 4	0.85	1.15		
9 dBVrms, Ch 1	8.85	9.15		
9 dBVrms, Ch 2	8.85	9.15		
9 dBVrms, Ch 3	8.85	9.15		
9 dBVrms, Ch 4	8.85	9.15		
19 dBVrms, Ch 1	18.85	19.15		
19 dBVrms, Ch 2	18.85	19.15		
19 dBVrms, Ch 3	18.85	19.15		
19 dBVrms, Ch 4	18.85	19.15		
27 dBVrms, Ch 1	26.85	27.15		
27 dBVrms, Ch 2	26.85	27.15		
27 dBVrms, Ch 3	26.85	27.15		
27 dBVrms, Ch 4	26.85	27.15		

Serial Number: _____ **Report Number:** _____
Test Date: ___/___/___

Flatness

Measurement	Lower Limit (dB)	Upper Limit (dB)	Measured Value (dB)	Pass/Fail
27 dBVrms, 51.2 kHz, One Ch, Ch 1	-0.2	0.2		
9 dBVrms, 51.2 kHz, One Ch, Ch 1	-0.2	0.2		
-11 dBVrms, 51.2 kHz, One Ch, Ch 1	-0.2	0.2		
27 dBVrms, 51.2 kHz, Two Ch, Ch 1	-0.2	0.2		
27 dBVrms, 51.2 kHz, Two Ch, Ch 2	-0.2	0.2		
9 dBVrms, 51.2 kHz, Two Ch, Ch 1	-0.2	0.2		
9 dBVrms, 51.2 kHz, Two Ch, Ch 2	-0.2	0.2		
-11 dBVrms, 51.2 kHz, Two Ch, Ch 1	-0.2	0.2		
-11 dBVrms, 51.2 kHz, Two Ch, Ch 2	-0.2	0.2		
27 dBVrms, 25.6 kHz, Four Ch, Ch 1	-0.2	0.2		
27 dBVrms, 25.6 kHz, Four Ch, Ch 2	-0.2	0.2		
27 dBVrms, 25.6 kHz, Four Ch, Ch 3	-0.2	0.2		
27 dBVrms, 25.6 kHz, Four Ch, Ch 4	-0.2	0.2		
9 dBVrms, 25.6 kHz, Four Ch, Ch 1	-0.2	0.2		
9 dBVrms, 25.6 kHz, Four Ch, Ch 2	-0.2	0.2		
9 dBVrms, 25.6 kHz, Four Ch, Ch 3	-0.2	0.2		
9 dBVrms, 25.6 kHz, Four Ch, Ch 4	-0.2	0.2		
-11 dBVrms, 25.6 kHz, Four Ch, Ch 1	-0.2	0.2		
-11 dBVrms, 25.6 kHz, Four Ch, Ch 2	-0.2	0.2		
-11 dBVrms, 25.6 kHz, Four Ch, Ch 3	-0.2	0.2		
-11 dBVrms, 25.6 kHz, Four Ch, Ch 4	-0.2	0.2		

Serial Number: _____ Report Number: _____
 Test Date: __/__/__

Amplitude Linearity

Measurement	Lower Limit (dB)	Upper Limit (dB)	Measured Value (dB)	Pass/Fail
13 dBVrms, Ch 1	-0.0615	0.061		
13 dBVrms, Ch 2	-0.0615	0.061		
13 dBVrms, Ch 3	-0.0615	0.061		
13 dBVrms, Ch 4	-0.0615	0.061		
-1 dBVrms, Ch 1	-0.105	0.104		
-1 dBVrms, Ch 2	-0.105	0.104		
-1 dBVrms, Ch 3	-0.105	0.104		
-1 dBVrms, Ch 4	-0.105	0.104		
-15 dBVrms, Ch 1	-0.33	0.318		
-15 dBVrms, Ch 2	-0.33	0.318		
-15 dBVrms, Ch 3	-0.33	0.318		
-15 dBVrms, Ch 4	-0.33	0.318		
-29 dBVrms, Ch 1	-1.551	1.316		
-29 dBVrms, Ch 2	-1.551	1.316		
-29 dBVrms, Ch 3	-1.551	1.316		
-29 dBVrms, Ch 4	-1.551	1.316		
-43 dBVrms, Ch 1	-13.823	5.088		
-43 dBVrms, Ch 2	-13.823	5.088		
-43 dBVrms, Ch 3	-13.823	5.088		
-43 dBVrms, Ch 4	-13.823	5.088		
-53 dBVrms, Ch 1	-30.116	10.896		
-53 dBVrms, Ch 2	-30.116	10.896		
-53 dBVrms, Ch 3	-30.116	10.896		
-53 dBVrms, Ch 4	-30.116	10.896		

Serial Number: _____ **Report Number:** _____
Test Date: ___/___/___

A-Weight Filter

Measurement	Lower Limit (dB)	Upper Limit (dB)	Measured Value (dB)	Pass/Fail
Ch 1, 10 Hz	-5	2		
Ch 2, 10 Hz	-5	2		
Ch 3, 10 Hz	-5	2		
Ch 4, 10 Hz	-5	2		
Ch 1, 31.62 Hz	-1	1		
Ch 2, 31.62 Hz	-1	1		
Ch 3, 31.62 Hz	-1	1		
Ch 4, 31.62 Hz	-1	1		
Ch 1, 100 Hz	-0.7	0.7		
Ch 2, 100 Hz	-0.7	0.7		
Ch 3, 100 Hz	-0.7	0.7		
Ch 4, 100 Hz	-0.7	0.7		
Ch 1, 1000 Hz	-0.7	0.7		
Ch 2, 1000 Hz	-0.7	0.7		
Ch 3, 1000 Hz	-0.7	0.7		
Ch 4, 1000 Hz	-0.7	0.7		
Ch 1, 10000 Hz	-3	2		
Ch 2, 10000 Hz	-3	2		
Ch 3, 10000 Hz	-3	2		
Ch 4, 10000 Hz	-3	2		
Ch 1, 25120 Hz	-4.5	2.4		
Ch 2, 25120 Hz	-4.5	2.4		
Ch 3, 25120 Hz	-4.5	2.4		
Ch 4, 25120 Hz	-4.5	2.4		

Serial Number: _____ Report Number: _____
 Test Date: ___/___/___

Channel Match

Measureme nt	Lower Limit	Upper Limit	Measured Value	Pass/Fail
Two Ch, 2/1, 7 dBV FS Mag	-0.04	0.04		
Two Ch, 2/1, 7 dBV FS Phs	-0.5	0.5		
Two Ch, 2/1, -13 dBV FS Mag	-0.04	0.04		
Two Ch, 2/1, -13 dBV FS Phs	-0.5	0.5		
Two Ch, 2/1, -33 dBV FS Mag	-0.04	0.04		
Two Ch, 2/1, -33 dBV FS Phs	-0.5	0.5		
Two Ch, 2/1, 7 dBV -20 dBfs Mag	-0.08	0.08		
Two Ch, 2/1, 7 dBV -20 dBfs Phs	-0.5	0.5		
Four Ch, 2/1, 7 dBV FS Mag	-0.04	0.04		
Four Ch, 2/1, 7 dBV FS Phs	-0.5	0.5		
Four Ch, 2/1, -13 dBV FS Mag	-0.04	0.04		
Four Ch, 2/1, -13 dBV FS Phs	-0.5	0.5		
Four Ch, 2/1, -33 dBV FS Mag	-0.04	0.04		
Four Ch, 2/1, -33 dBV FS Phs	-0.5	0.5		
Four Ch, 2/1, 7 dBV -20 dBfs Mag	-0.08	0.08		
Four Ch, 2/1, 7 dBV -20 dBfs Phs	-0.5	0.5		
Four Ch, 3/1, 7 dBV FS Mag	-0.04	0.04		
Four Ch, 3/1, 7 dBV FS Phs	-0.5	0.5		
Four Ch, 3/1, -13 dBV FS Mag	-0.04	0.04		
Four Ch, 3/1, -13 dBV FS Phs	-0.5	0.5		
Four Ch, 3/1, -33 dBV FS Mag	-0.04	0.04		
Four Ch, 3/1, -33 dBV FS Phs	-0.5	0.5		
Four Ch, 3/1, 7 dBV -20 dBfs Mag	-0.08	0.08		
Four Ch, 3/1, 7 dBV -20 dBfs Phs	-0.5	0.5		
Four Ch, 4/1, 7 dBV FS Mag	-0.04	0.04		
Four Ch, 4/1, 7 dBV FS Phs	-0.5	0.5		
Four Ch, 4/1, -13 dBV FS Mag	-0.04	0.04		

Serial Number: _____ **Report Number:** _____
Test Date: ___/___/___

Measurement	Lower Limit	Upper Limit	Measured Value	Pass/Fail
Four Ch, 4/1, -13 dBV FS Phs	-0.5	0.5		
Four Ch, 4/1, -33 dBV FS Mag	-0.04	0.04		
Four Ch, 4/1, -33 dBV FS Phs	-0.5	0.5		
Four Ch, 4/1, 7 dBV -20 dBfs Mag	-0.08	0.08		
Four Ch, 4/1, 7 dBV -20 dBfs Phs	-0.5	0.5		
Four Ch, 4/3, 7 dBV FS Mag	-0.04	0.04		
Four Ch, 4/3, 7 dBV FS Phs	-0.5	0.5		
Four Ch, 4/3, -13 dBV FS Mag	-0.04	0.04		
Four Ch, 4/3, -13 dBV FS Phs	-0.5	0.5		
Four Ch, 4/3, -33 dBV FS Mag	-0.04	0.04		
Four Ch, 4/3, -33 dBV FS Phs	-0.5	0.5		
Four Ch, 4/3, 7 dBV -20 dBfs Mag	-0.08	0.08		
Four Ch, 4/3, 7 dBV -20 dBfs Phs	-0.5	0.5		

Frequency Accuracy

Measurement	Lower Limit (kHz)	Upper Limit (kHz)	Measured Value (kHz)	Pass/Fail
50 kHz	49.9985	50.0015		

Single Ch Phase Accuracy

Measurement	Lower Limit (deg)	Upper Limit (deg)	Measured Value (deg)	Pass/Fail
Positive slope, Ch 1	-4	4		
Positive slope, Ch 2	-4	4		
Positive slope, Ch 3	-4	4		
Positive slope, Ch 4	-4	4		
Negative slope, Ch 1	-4	4		
Negative slope, Ch 2	-4	4		
Negative slope, Ch 3	-4	4		
Negative slope, Ch 4	-4	4		

Serial Number: _____ Report Number: _____
 Test Date: __/__/__

ICP Supply

Measurement	Lower Limit	Upper Limit	Measured Value	Pass/Fail
Ch 1 Open Circuit Voltage	26 Vdc	32 Vdc	Vdc	
Ch 2 Open Circuit Voltage	26 Vdc	32 Vdc	Vdc	
Ch 31 Open Circuit Voltage	26 Vdc	32 Vdc	Vdc	
Ch 4 Open Circuit Voltage	26 Vdc	32 Vdc	Vdc	
Ch 1 Current	2.75 mA	5.75 mA	mA	
Ch 2 Current	2.75 mA	5.75 mA	mA	
Ch 3 Current	2.75 mA	5.75 mA	mA	
Ch 4 Current	2.75 mA	5.75 mA	mA	

Source Amplitude Accuracy

Measurement	Lower Limit (%)	Upper Limit (%)	Measured Value (%)	Pass/Fail
1 kHz, 0.1 Vpk	-4	4		
1 kHz, 3.0 Vpk	-4	4		
1 kHz, 5.0 Vpk	-4	4		

Source Flatness

Measurement	Lower Limit (dB)	Upper Limit (dB)	Measured Value (dB)	Pass/Fail
12.8 kHz	-1	1		
25.6 kHz	-1	1		
51.2 kHz	-1	1		

Source Distortion

Measurement	Lower Limit (dBc)	Upper Limit (dBc)	Measured Value (dBc)	Pass/Fail
12.8 kHz		-60		
51.2 kHz		-40		

Index

A

- A-weight filter test **3-20**
- ac power
 - cables **2-4**
 - consumption **2-2**
 - select switch **2-5**
- amplitude
 - accuracy test **3-17**
 - linearity test **3-19**
 - source accuracy test **3-43**
- anti-alias filter test 3-23**
- automobile
 - dc power **2-8**
 - dc power cable **2-3**
 - power transients **2-20**

B

- battery **2-8**

C

- centronics port **2-11**
- channel match test **3-21**
- cleaning screen **2-17**
- connecting
 - dc power **2-8**
 - external keyboard **2-14**
 - external monitor **2-13**
 - microphone adapter **2-16**
- cooling **2-7**
- cross talk test **3-30**

D

- dc offset test **3-14**
- dc power
 - cables **2-3**
 - connecting **2-8**
 - consumption **2-2**
 - intermittent operation **2-20**
 - select switch **2-8**
- disk drive cover **2-7**

E

- equipment required **1-17**
- external
 - keyboard **2-14**
 - monitor **2-13**
 - trigger test **3-35**

F

- flatness test **3-18**
- frequency accuracy test **3-22**
- fuse **2-10**

G

- grounding requirements **2-3**
- GPIB connector **2-12**

H

- harmonic distortion test **3-25**

I

- ICP supply test **3-39**
- incoming inspection 2-5**
- input
 - coupling test **3-24**
 - resistance test **3-37**

installation 2-7

interface

 GPIB 2-12

 parallel 2-11

 serial 2-11

intermodulation distortion test 3-28

K

keyboard 2-14

M

measurement uncertainty 3-4, 3-54

microphone adapter, connecting 2-16

monitor, connecting external 2-13

N

noise test 3-15

O

operating environment 2-7

operation verification

 confidence level 3-4

 test list 3-4

P

parallel port 2-11

performance test

 confidence level 3-4

 cycle 3-3

 test list 3-4

 versus specification 3-6

performance test software

 loading program 3-7

 manual mode 3-12

 program controlled equipment 3-4

 semiautomated mode 3-8

 softkey descriptions 3-49

 without a printer 3-10, 3-12

plotter interface 2-11

power

 ac cables 2-4

 consumption 2-2

 dc cables 2-3

 select switch 2-5

printer interface 2-11

R

recommended test equipment 1-17

S

safety

See front matter

screen cleaning 2-17

self test 3-13

serial port 2-11

shipping 2-18

single channel phase accuracy test 3-34

source

 amplitude accuracy test 3-43

 dc offset test 3-46

 distortion test 3-48

 flatness test 3-47

 output resistance test 3-44

specifications 1-2

spurious signals test 3-16

storage 2-17

T

test equipment 1-17

transporting 2-18

Guide to Agilent 35670A Documentation

If you are thinking about...	And you want to...	Then read...
Unpacking and installing the Agilent 35670A	Install the Agilent 35670A Dynamic Signal Analyzer Do operation verification or performance verification tests	<i>Agilent 35670A Installation and Verification Guide</i> <i>Agilent 35670A Installation and Verification Guide</i>
Getting started	Make your first measurements with your new analyzer Review measurement basics Learn what each key does	<i>Agilent 35670A Quick Start Guide</i> <i>Agilent 35670A Operator's Guide</i> Use the analyzer's [Help] key
Making measurements	Learn how to make typical measurements with the Agilent 35670A Understand each of the analyzer's instrument modes	<i>Agilent 35670A Operator's Guide</i> <i>Agilent 35670A Operator's Guide</i>
Creating automated measurements (Instrument Basic is Option 1C2)	Learn the Instrument Basic interface Record keystrokes for a particular measurement Program with Instrument Basic	<i>Using Instrument Basic with the Agilent 35670A</i> <i>Agilent 35670A Quick Start Guide</i> <i>Instrument Basic User's Handbook</i>
Remote operation	Learn about the GPIB Learn how to program with GPIB Find specific GPIB commands	<i>GPIB Programmer's Guide</i> <i>GPIB Programming with the Agilent 35670A</i> <i>Agilent 35670A GPIB Commands: Quick Reference</i>
Using analyzer data with a PC application	-Display or plot analyzer data on or from a Personal Computer -Transfer analyzer data to a PC software application format - Transfer data from a PC software application format to the analyzer (for example, to load data into a data register)	<i>Standard Data Format Utilities: User's Guide</i>
Servicing the analyzer	Adjust, troubleshoot, or repair the analyzer	<i>Agilent 35670A Service Guide</i>

Need Assistance?

If you need assistance, contact your nearest Agilent Technologies Sales and Service Office listed in the Agilent Catalog. You can also find a list of local service representatives on the Web at:

<http://www.agilent.com/find/assist> or contact your nearest regional office listed below.

If you are contacting Agilent Technologies about a problem with your Agilent 35670 Dynamic Signal Analyzer, please provide the following information:

- Model number: Agilent 35670A
- Serial number:
- Options:
- Date the problem was first encountered:
- Circumstances in which the problem was encountered:
- Can you reproduce the problem?
- What effect does this problem have on you?

You may find the serial number and options from the front panel of your analyzer by executing the following:

Press [**System Utility**], [more], [serial number].

Press [**System Utility**], [options setup].

If you do not have access to the Internet, one of these centers can direct you to your nearest representative:

United States	Test and Measurement Call Center (800) 452-4844 (Toll free in US)
Canada	(905) 206-4725
Europe	(31 20) 547 9900
Japan	Measurement Assistance Center (81) 426 56 7832 (81) 426 56 7840 (FAX)
Latin America	(305) 267 4245 (305) 267 4288 (FAX)
Australia/New Zealand	1 800 629 485 (Australia) 0800 738 378 (New Zealand)
Asia-Pacific	(852) 2599 7777 (FAX) (852) 2506 9285
