

---

# Installation Guide

Publication number 16700-97023  
November 2002

For Safety information and Regulatory information, see the pages behind the index.

© Copyright Agilent Technologies 2000-2002  
All Rights Reserved

---

## Agilent Technologies 16700B-Series Logic Analysis Systems

---

# Installation at a Glance

## 16700B Overview

### 16700B Mainframe



If ordered:  
Monitor  
Monitor Cable  
Monitor Power Cable

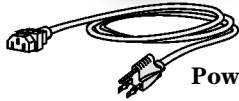

Power Cable

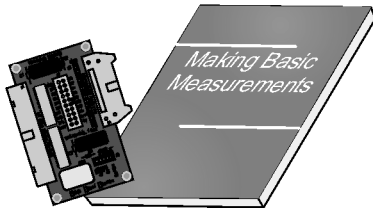

Training Board & Kit



Keyboard  
& Mouse



---

### Additional Connections

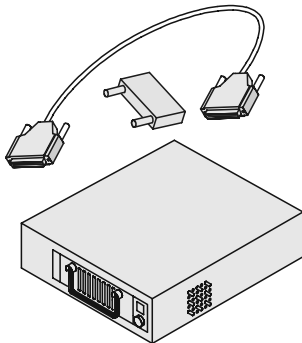

External Disk Drive & Cable  
(Data Drive - Option 008)  
(Boot Drive - Option 009)

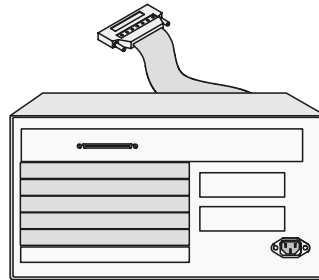

16701A/B  
Expander  
Frame

Printer &  
Cable

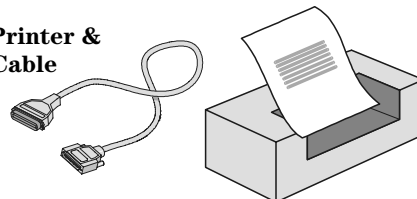

## 16702B Overview

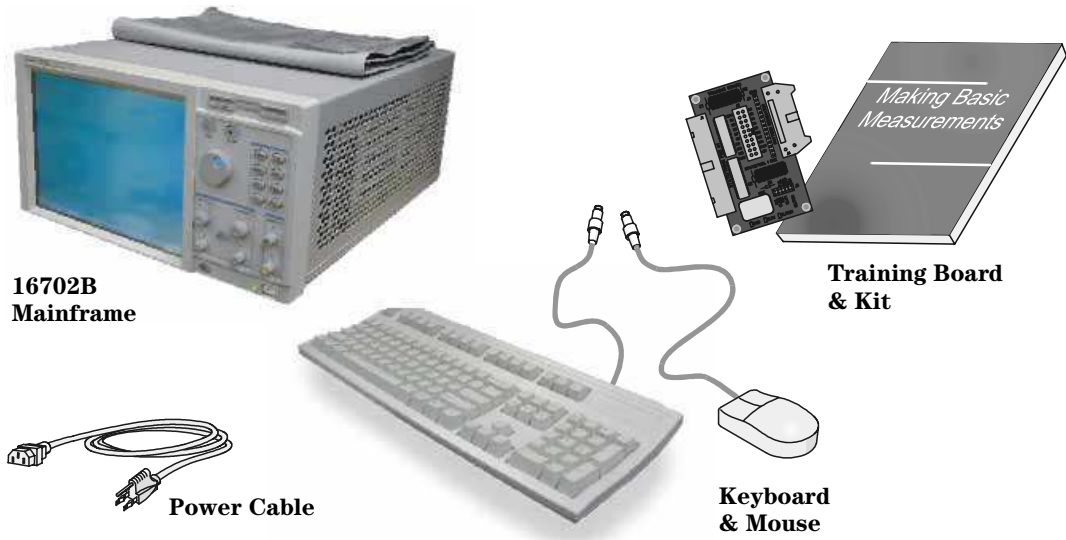

---

## Additional Connections

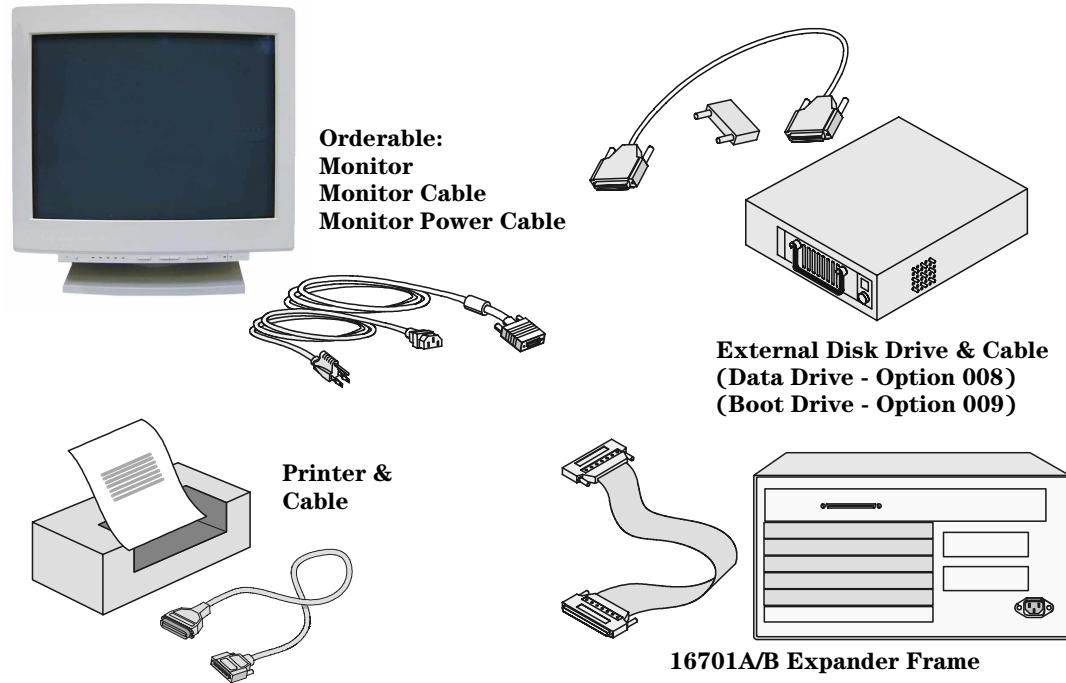



## Installation at a Glance

### **1 General Information 9**

- To locate information on using the logic analyzer 10
- To locate specifications and characteristics 11
- To create a backup file of your system settings and license passwords 13
- To reload system settings and license passwords 15

### **2 Connecting and Configuring Hardware 17**

- To connect the mouse, keyboard, and monitor 18
- To configure a monitor for the 16700B 19
- To configure an optional monitor for the 16702B 21
- To change monitors (16700B or 16702B) 22
- To connect to LAN 22
- To connect a printer 24
- To connect an external data drive (option 008) 26
- To disconnect an external data drive (option 008) 30
- To connect a removable boot drive (option 009) 31
- To disconnect a removable boot drive (option 009) 34
- To install software 34
- To connect a 16701B expander frame 37
- To connect multiple frames 38
- To install, remove, or replace measurement modules 42

### **3 Installing Logic Analyzer Measurement Modules 45**

---

## Contents

Software Requirements	46
16517/18A Logic Analyzer (2-card module)	47
16517/18A Logic Analyzer (3-card module)	48
16517/18A Logic Analyzer (4-card module)	49
16517/18A Logic Analyzer (5-card module)	50
16557D Logic Analyzer (1-card module)	50
16557D Logic Analyzer (2-card module)	51
16557D Logic Analyzer (3-card module)	52
16557D Logic Analyzer (3-card module)	53
16557D Logic Analyzer (5-card module)	54
16710/11/12A Logic Analyzer (1-card module)	55
16710/11/12A Logic Analyzer (2-card module)	56
16715/16/17A, 16718/19A, 16740/41/42A, 16750/51/52A/B Logic Analyzer (1-card module)	57
16715/16/17A, 16718/19A, 16740/41/42A, 16750/51/52A/B Logic Analyzer (2-card module)	58
16715/16/17A, 16718/19A, 16740/41/42A, 16750/51/52A/B Logic Analyzer (3-card module)	59
16715/16/17A, 16718/19A, 16740/41/42A, 16750/51/52A/B Logic Analyzer (4-card module)	60
16715/16/17A, 16718/19A, 16740/41/42A, 16750/51/52A/B Logic Analyzer (5-card module)	61
16753/54/55/56A Logic Analyzer (1-card module)	62
16753/54/55/56A Logic Analyzer (2-card module)	63
16753/54/55/56A Logic Analyzer (3-card module)	64
16753/54/55/56A Logic Analyzer (4-card module)	65
16753/54/55/56A Logic Analyzer (5-card module)	66
16760A Logic Analyzer (1-card module)	67
16760A Logic Analyzer (2-card module)	67
16760A Logic Analyzer (3-card module)	68
16760A Logic Analyzer (4-card module)	69
16760A Logic Analyzer (5-card module)	70

## 4 Installing Oscilloscope

**Measurement Modules 71**

16533/34A Oscilloscope Module (single or multi-card modules) 72

**5 Installing Pattern Generator**

**Measurement Modules 87**

Software Requirements 88

16522A Pattern Generator (1-card module) 88

16522A Pattern Generator (2-card module) 89

16522A Pattern Generator (3-card module) 89

16522A Pattern Generator (4-card module) 90

16522A Pattern Generator (5-card module) 91

16720A Pattern Generator (1-card module) 92

16720A Pattern Generator (2-card module) 92

16720A Pattern Generator (3-card module) 93

16720A Pattern Generator (4-card module) 94

16720A Pattern Generator (5-card module) 95

**6 Connecting Accessories 97**

**For More Information**

General-purpose probing 99

Isolation adapter (Part number 01650-63203) 101

Direct connection 102

38-pin Low-voltage Probe (E5339A with tip isolation network) 103

38-pin Single-ended Probe (E5346A for analyzers with 40-pin pod connectors) 104

38-pin Adapter Cable (E5351A no tip network) 105

100-pin Single-ended Probe (E5378A for analyzers with 90-pin pod connectors) 106

---

## Contents

100-pin Differential Probe (E5379A for analyzers with 90-pin pod connectors)	107
38-pin Single-ended Probe (E5380A for analyzers with 90-pin pod connectors)	108
Half-channel Adapter (E5386A)	109
Single-ended Flying Lead Probe Set (E5382A)	110
Soft Touch Probes (E5387A and E5390A for analyzers with 90-pin pod connectors)	111

## **7 Troubleshooting** 113

To run self-tests	114
To execute disaster recovery procedures	115



---

**General Information**

---

## To locate information on using the logic analyzer

Go to on-line help for information on using your logic analyzer. A pdf file of the on-line help is on the CD that came with your system if you want to print it out.

- 1 Select Help in the upper right corner of the screen and then select On Main System.

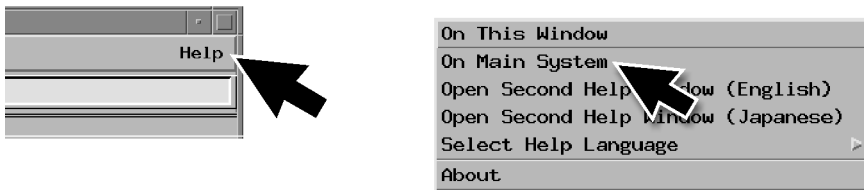

- 2 Select the task you need information about. .

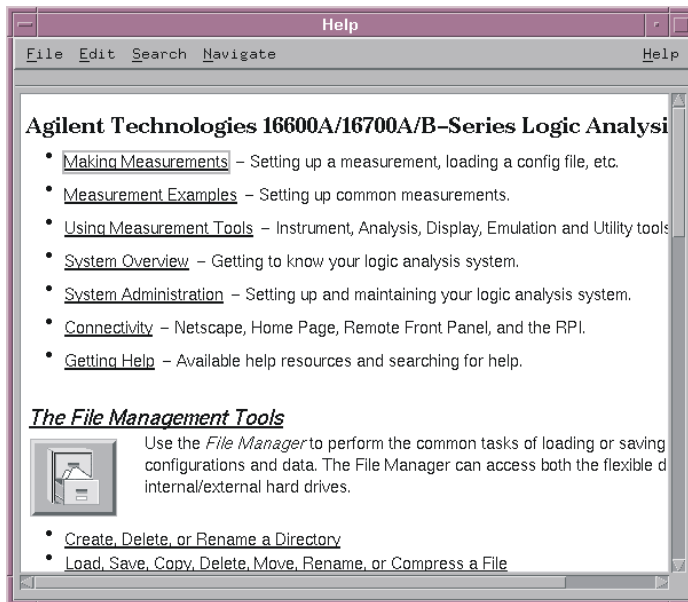

## To locate specifications and characteristics

The specifications and characteristics for your instrument and measurement module are in the on-line Help.

- 1 Select Help in the upper right corner of the screen and then select On Main System.

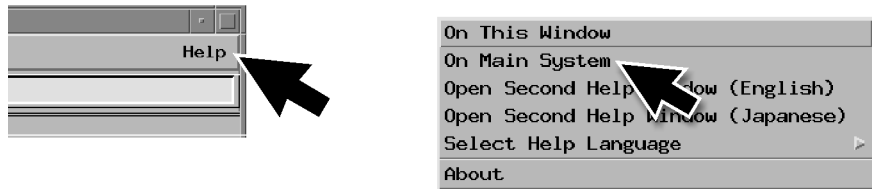

- 2 Select Using Measurement Tools and then select your instrument or measurement module from the list.



## Chapter 1: General Information

### To locate specifications and characteristics

- 3 Under Interface Reference, select Specifications and Characteristics.

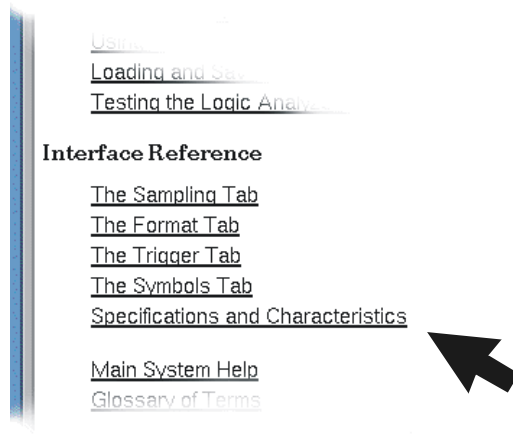

**To create a backup file of your system settings and license passwords****To create a backup file of your system settings and license passwords**

By saving your system settings to a flexible disk or a mounted directory, you create a backup file that can be used to quickly setup systems or to restore current system settings in case of problems.

- 1 Insert a flexible disk or set up a mounted directory.
- 2 Select the Tools icon from the menu bar.

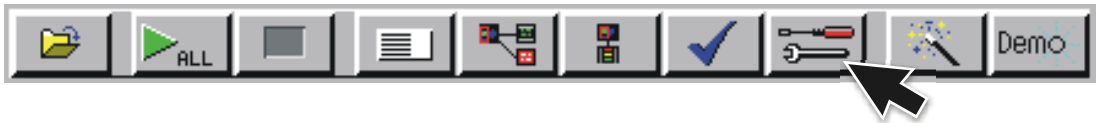

- 3 Select the Admin tab and select Save, then select Licenses and Save to File.

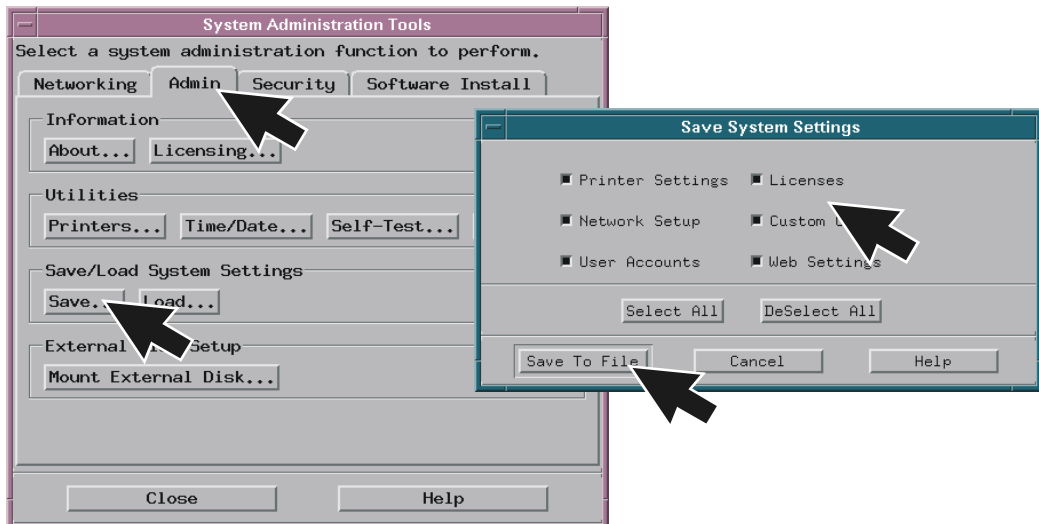

**To create a backup file of your system settings and license passwords**

- 4 Select Flexible Disk or a Mounted Directory and then select OK.

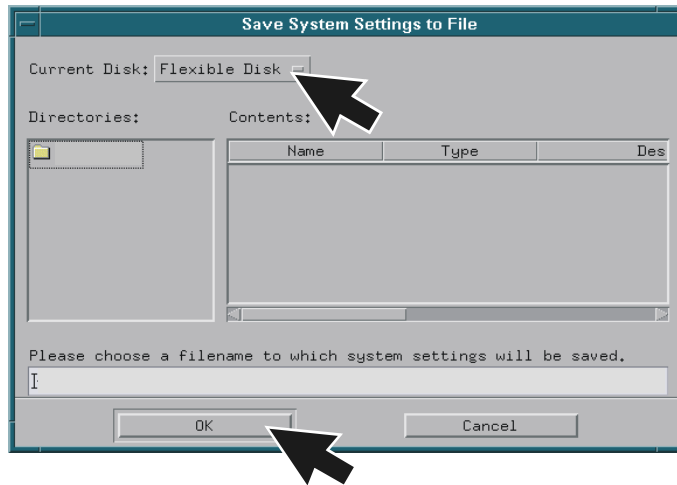

---

## To reload system settings and license passwords

- 1 Insert the flexible disk or set up a mounted directory.
- 2 Select the Tools icon from the menu bar.

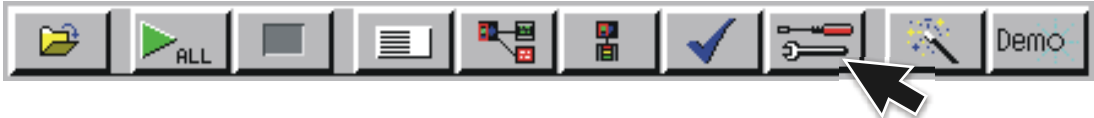

- 3 Go to the Admin tab and select Load.

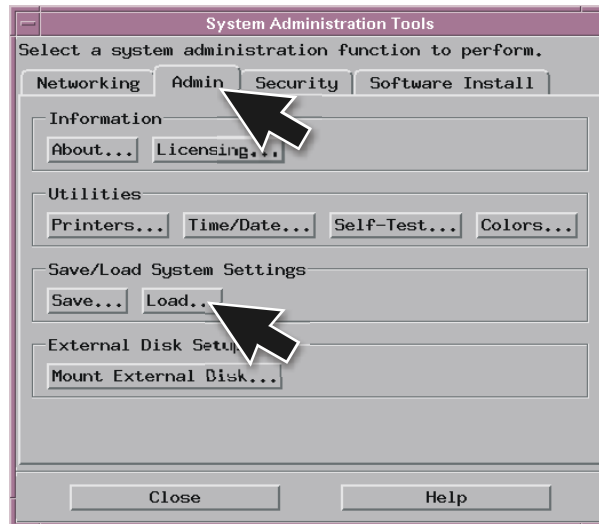

## Chapter 1: General Information

### To reload system settings and license passwords

- 4 Select Flexible Disk or Mounted Directory and select OK.

If an item is not valid, or was not initially saved to the file, the selection will be grayed out in the interface. Also, if no file extension is added, a '.set' extension is automatically added for you.

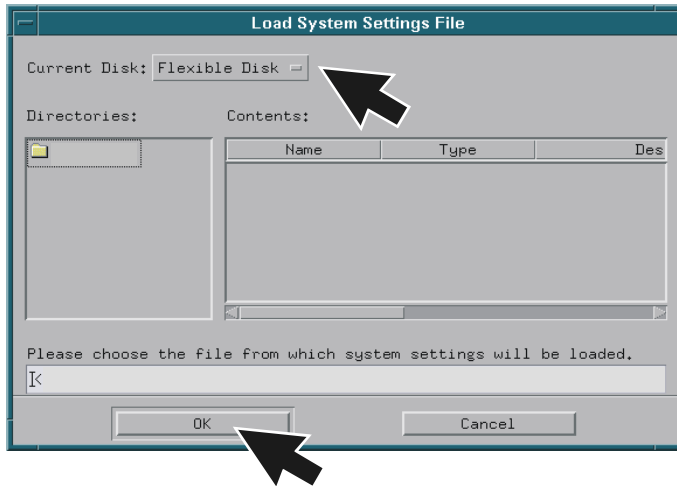



---

**Connecting and Configuring Hardware**

---

## To connect the mouse, keyboard, and monitor

The 16700B must have the system mouse and keyboard connected for the system to boot up properly. Once enabled on the LAN, the system can be operated remotely without a keyboard or mouse. Use of a monitor is optional for the 16700B and 16702B.

- 1 Connect the mouse and keyboard to the back of the 16700B or 16702B.

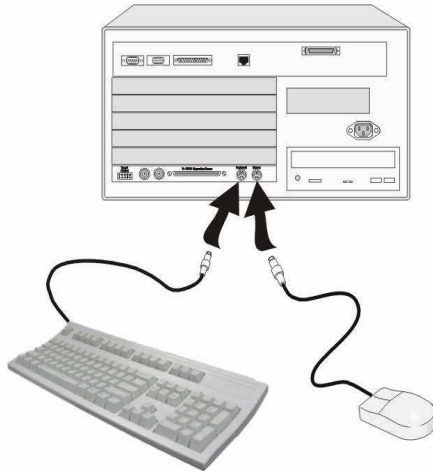

- 2 Connect the optional monitor to the back of the 16700B or 16702B.

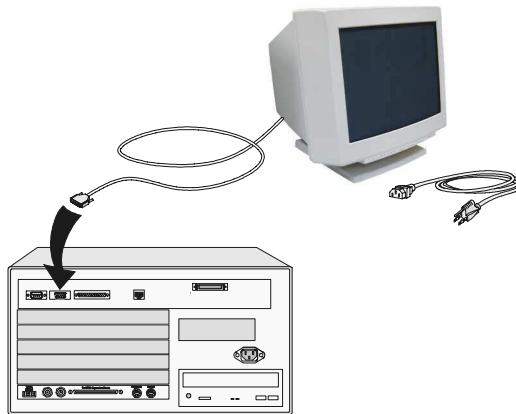

- 3 Connect the monitor power cable. International versions of the power cables can be found in the accessories box.

- 4 Allow a minimum of 5 cm spacing between instruments for proper cooling.

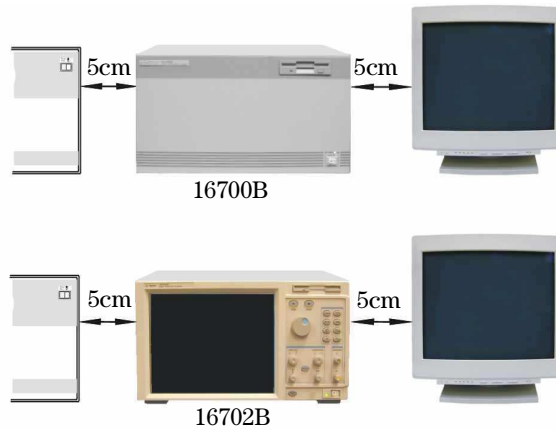

---

## To configure a monitor for the 16700B

If you ordered the optional monitor with your logic analyzer, the monitor resolution setting is pre-configured for 1280 x 1024 at the factory. Use this procedure if you wish to configure an external monitor other than the optional monitor orderable with the 16700B.

- 1 Connect your monitor to the logic analysis system as shown on page 18.
- 2 Turn on power to the monitor and then to the logic analysis system.

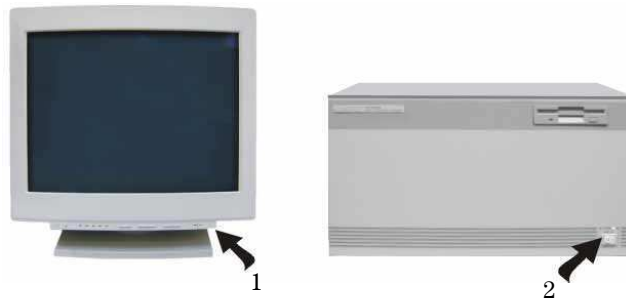

**To configure a monitor for the 16700B**

- 3 Immediately press the TAB key. Press once per second for approximately 30 seconds. The monitor display will change on the screen every few seconds as the system cycles through the monitor resolution choices.

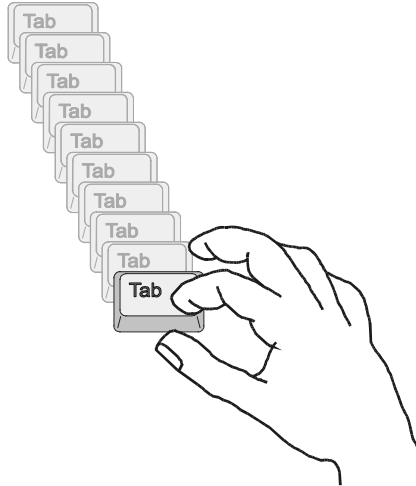

- 4 Press ENTER when you see a clear image to select your monitor choice and type 'Y' to confirm.

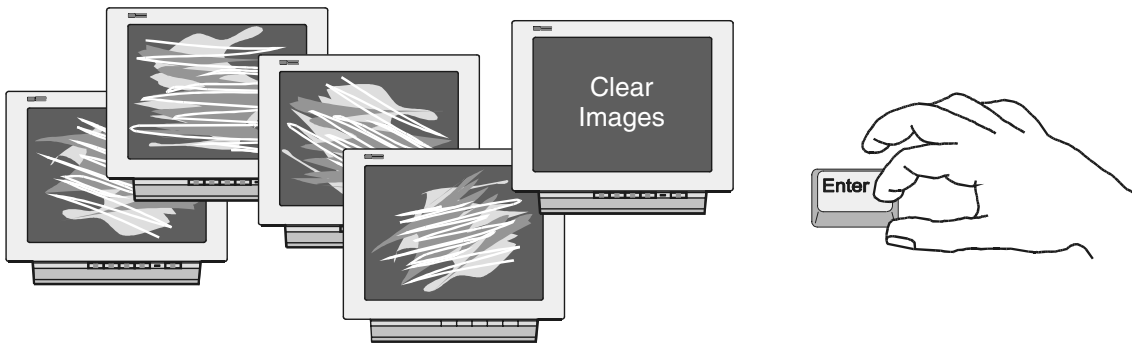

## To configure an optional monitor for the 16702B

The internal LCD display is pre-configured for 800 x 600 at the factory. Use this procedure if you wish to configure an external monitor or change the monitor setting to a different resolution.

- 1** Connect your monitor to the logic analysis system as shown on page 18.
- 2** Turn on power to the monitor and then to the logic analysis system.

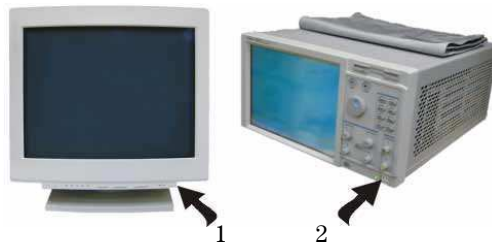

- 3** Immediately press the TAB key. Press once per second for approximately 30 seconds. The display will change on the screen every few seconds as the system cycles through the monitor resolution choices.

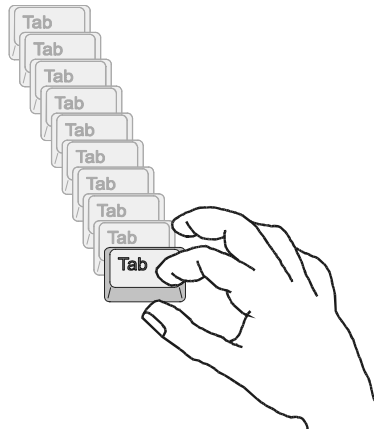

**To change monitors (16700B or 16702B)**

- 4 Press ENTER when you see a clear image to select your monitor choice and type 'Y' to confirm.

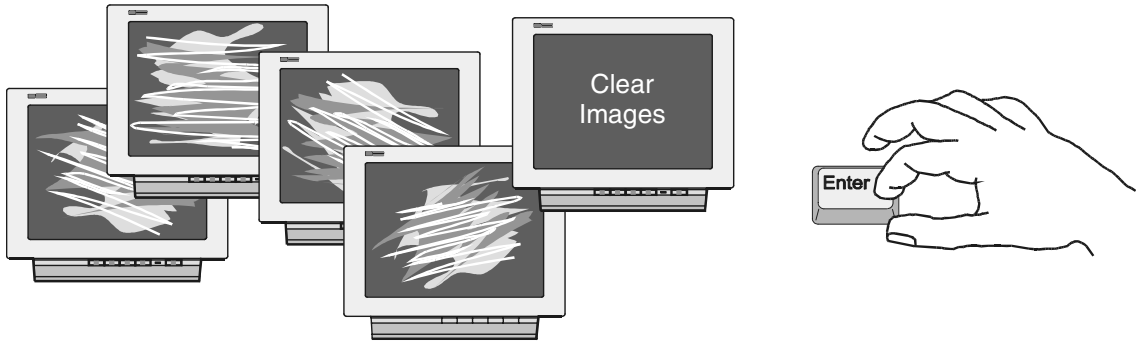

---

**To change monitors (16700B or 16702B)**

Any time you change monitors you will need to re-configure the new monitor. Follow the instructions beginning with step one on page 19 if you have a 16700B or page 21 if you have a 16702B.

---

**To connect to LAN**

- 1 Connect the LAN cable to the back of the 16700B or 16702B.

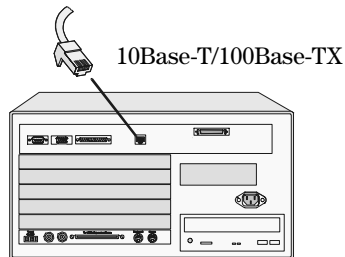

2 Go to the Help menu and select On Main System.

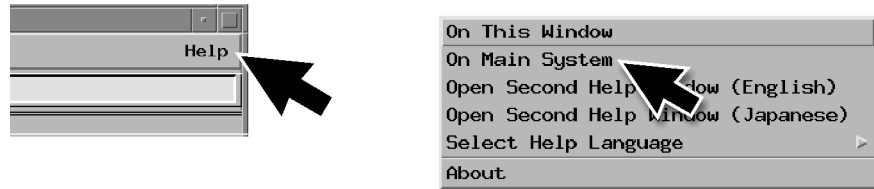

3 In the Help window select System Administration and then select Configuring the Network. Follow the instructions on configuring the network.

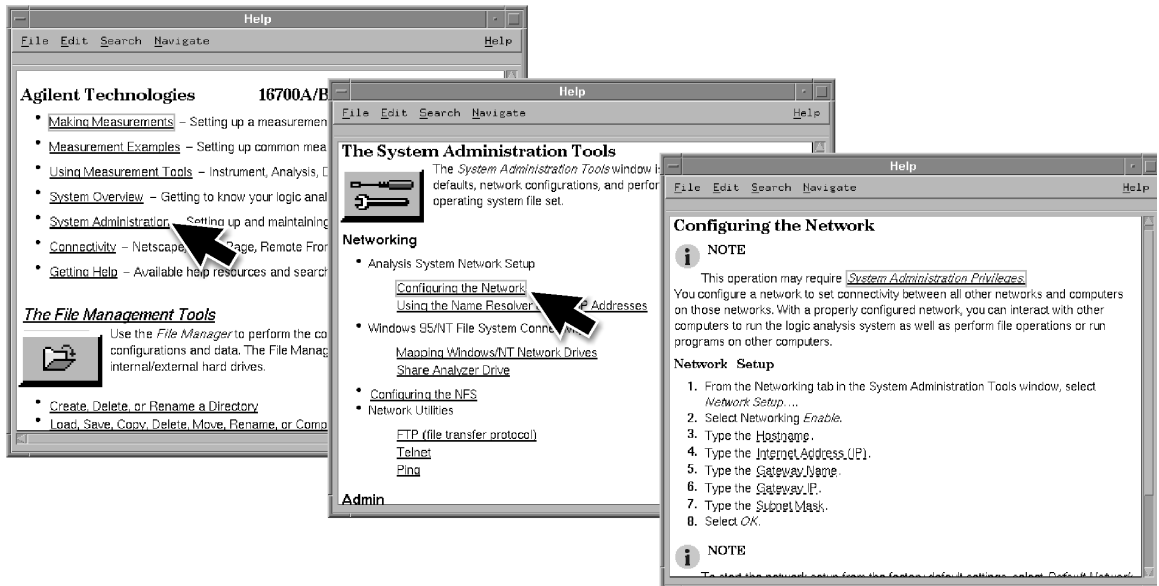

**To connect a printer**

---

**To connect a printer**

- 1 Connect the printer cable to the back of your 16700B or 16702B.

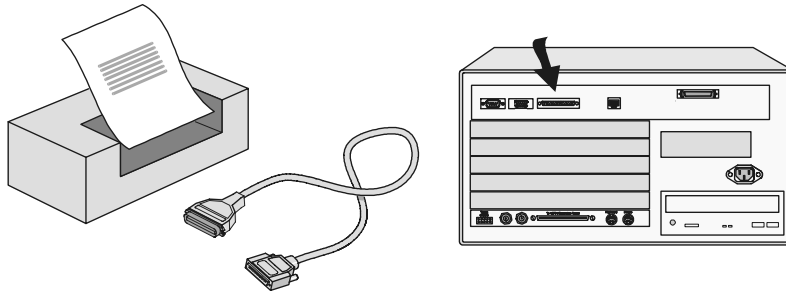

- 2 Select the Tools icon from the menu bar.

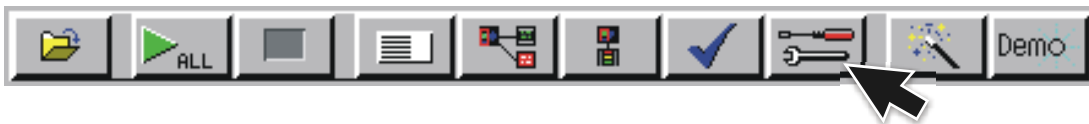

- 3 Go to the Admin. tab and select Printers.

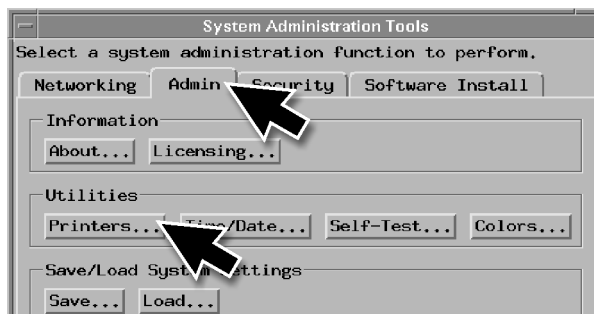



- 4 If you are connecting a local printer, select Local, select your printer type, select OK, and then Close.

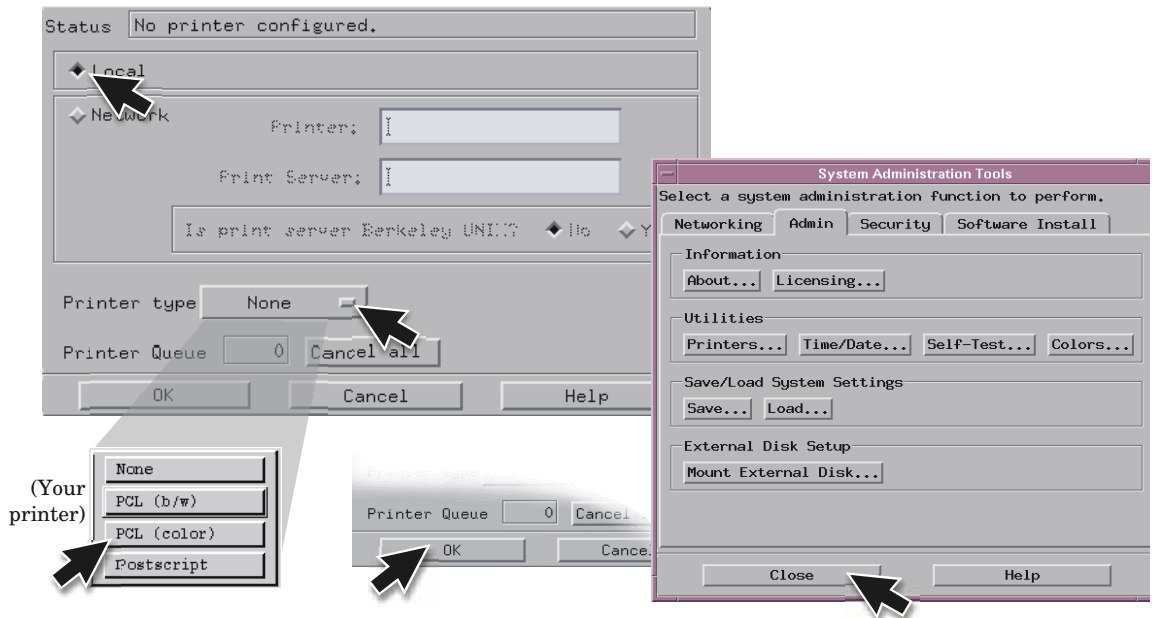

- 5 If you are connecting a network printer, select Network, enter the printer name, server address, select type, select OK, and then Close.

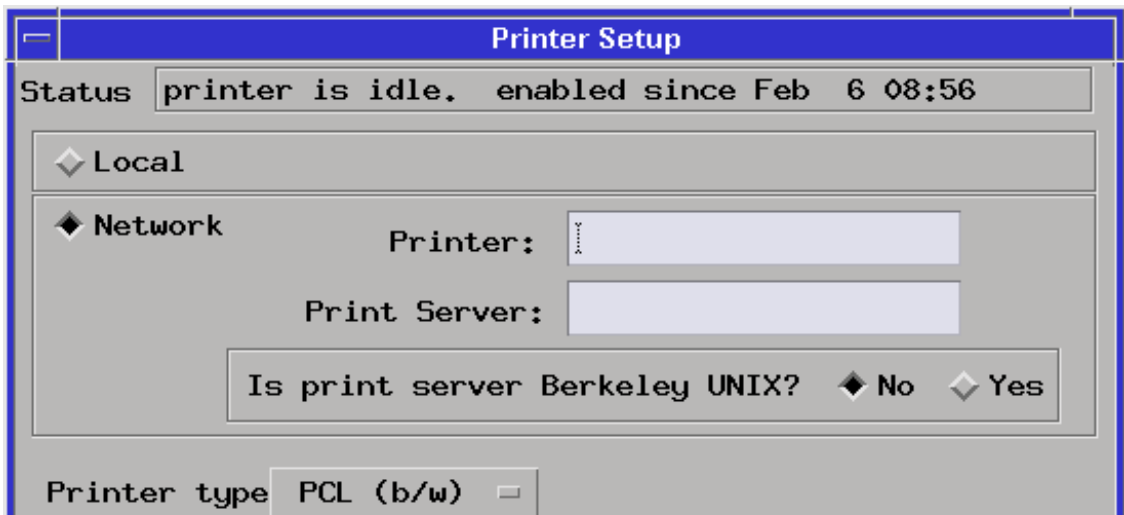

---

## To connect an external data drive (option 008)

- 1 Power up the data drive.
- 2 Set the address.
  - a Unlock the data drive carrier. Wait until the drive stops spinning and a “u” is displayed as shown.

---

**CAUTION:**

Damage could result to the data drive if it is removed from the carrier while the number is flashing.

---

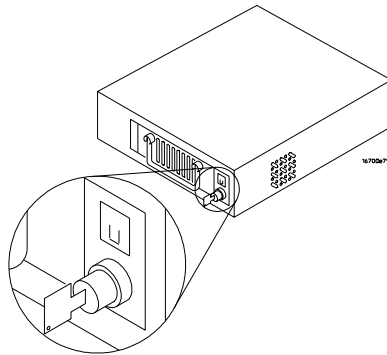

- b Remove the data drive from the carrier.

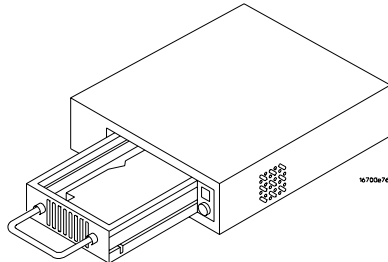

- c Set the external data drive address to 3 or 4 using the alignment tool supplied with the drive. The rotating switch is located inside the carrier.

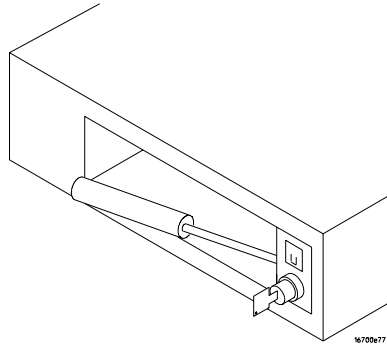

- d Insert the disk drive into the carrier and lock it into place.

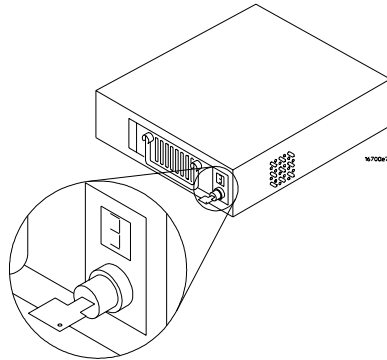

- 3 Power down the data drive.

Chapter 2: Connecting and Configuring Hardware  
To connect an external data drive (option 008)

4 Connect the data drive to the SCSI-II port.

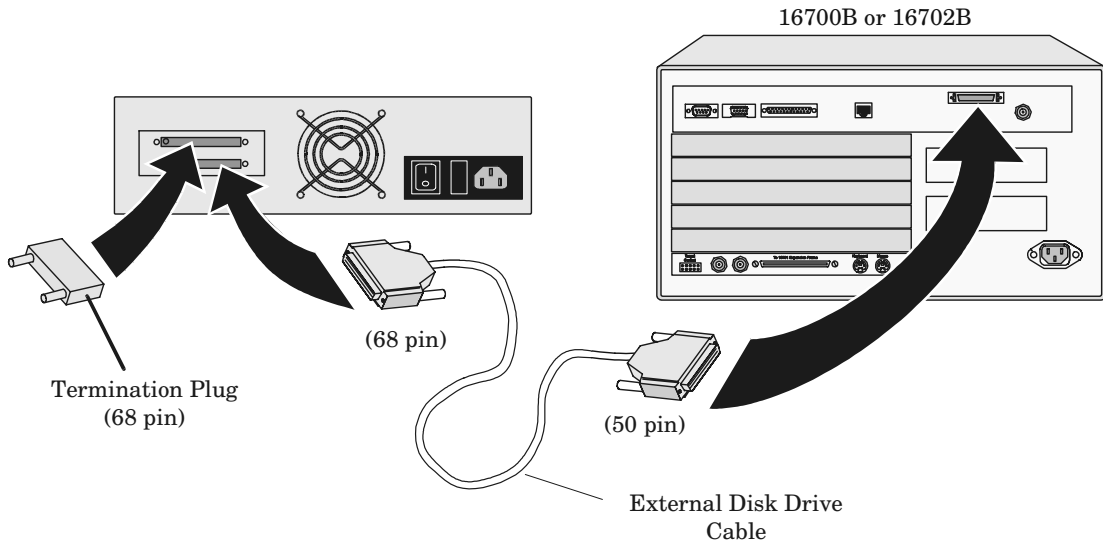

5 Power up the data drive, then the monitor, and then the system (16700B or 16702B).

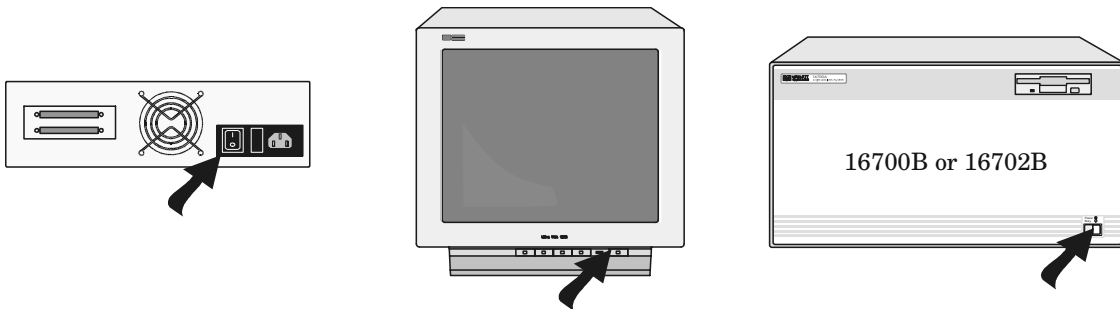

6 Mount the disk.

a Select the Tools icon from the menu bar

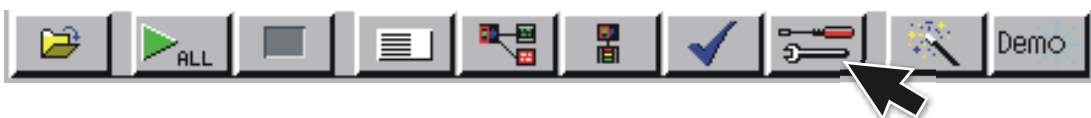

- b Go to the Admin. tab and select Mount External Disk.

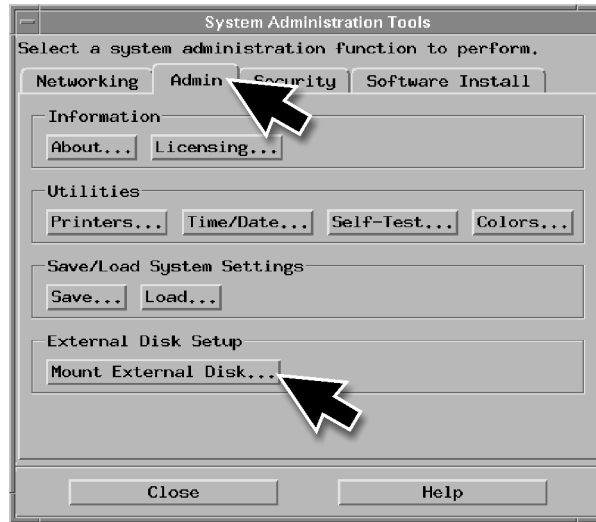

- c Select SCSI Address to the same number set in step 2, then Mount, and Close.

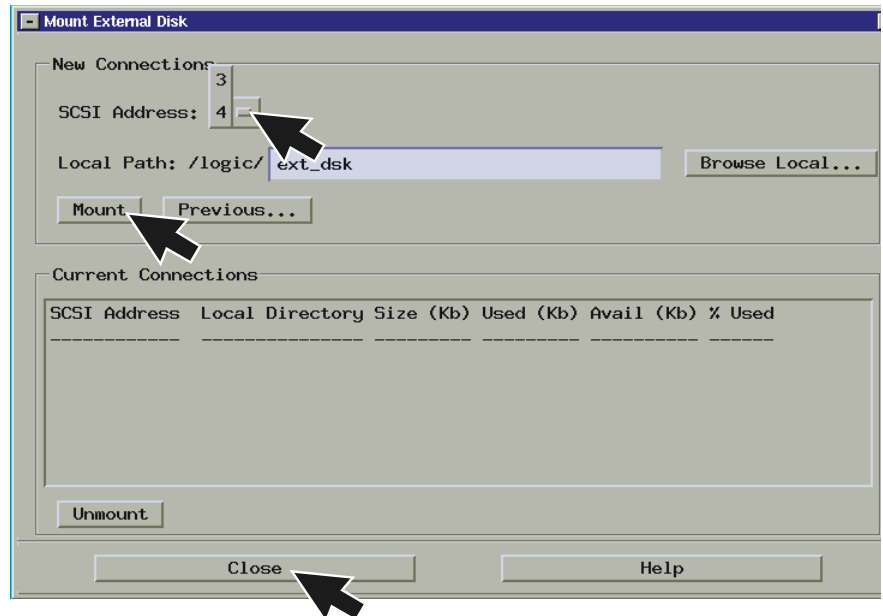

## To disconnect an external data drive (option 008)

It is important that you unmount the disk before turning the system off.

- 1 Select the Tools icon from the menu bar.

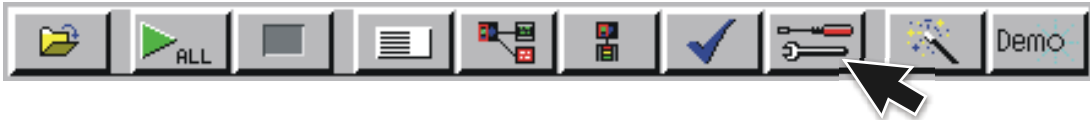

- 2 Select the Admin. tab, select Mount External Disk, select Unmount, and then Close.

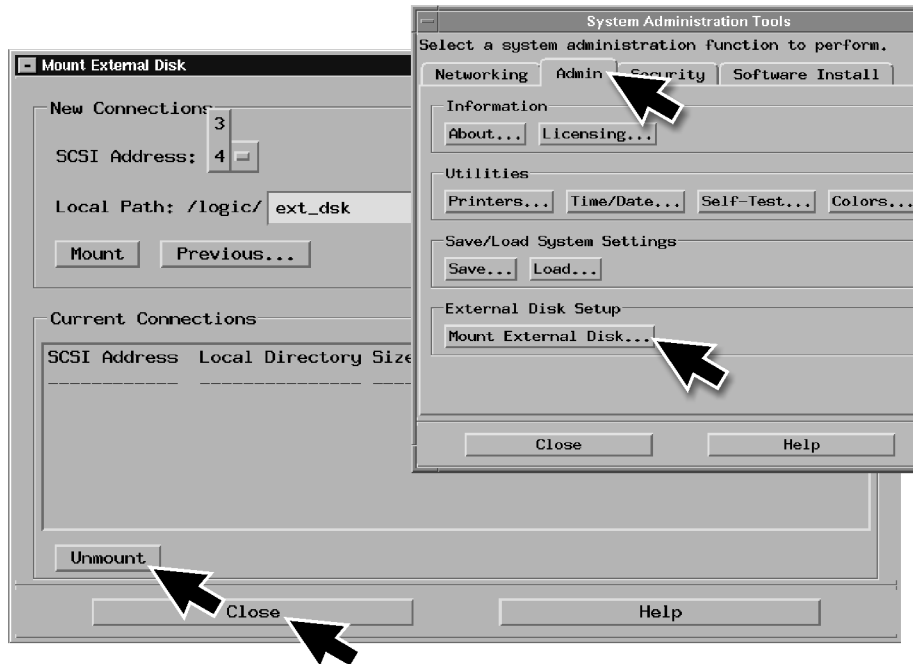

- 3 Turn the power off on the system, then the monitor, and then the data drive.

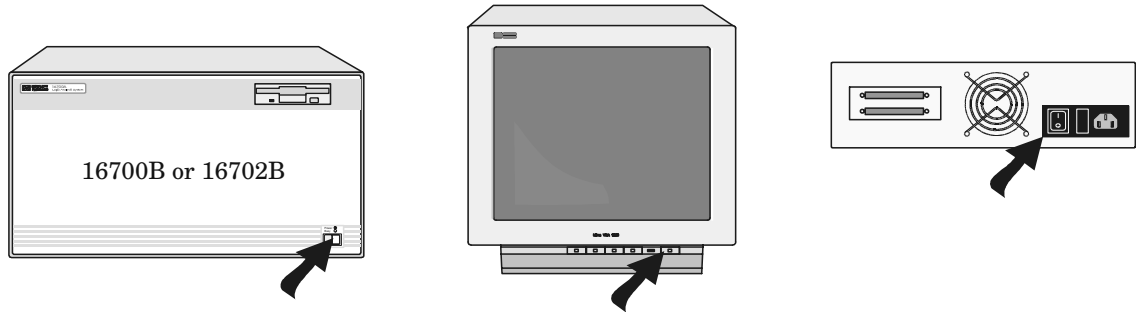

---

## To connect a removable boot drive (option 009)

- 1 Power up the boot drive.
- 2 Set the address.
  - a Unlock the boot drive carrier. Wait until the drive stops spinning and a “u” is displayed as shown.

---

**CAUTION:**

---

Damage could result to the data drive if it is removed from the carrier while the number is flashing.

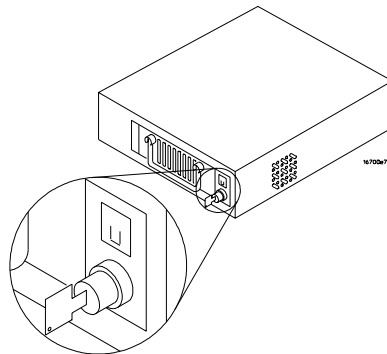

Chapter 2: Connecting and Configuring Hardware  
**To connect a removable boot drive (option 009)**

- b** Remove the boot drive from the carrier.

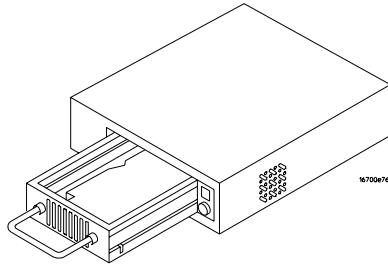

- c** Set the external boot drive address to 6 using the alignment tool supplied with the drive. The rotating switch is located inside the carrier.

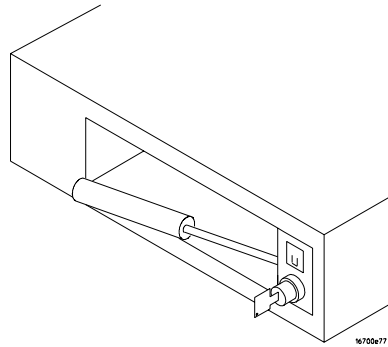

- d** Insert the disk into the carrier drive and lock it into place.

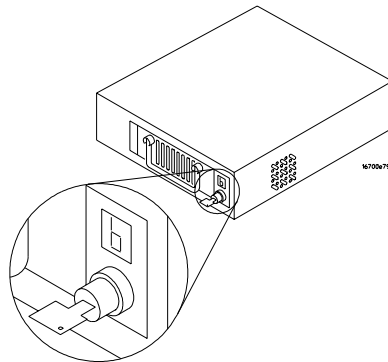



- 3 Power down the boot drive.
- 4 Connect the boot drive to the SCSI-II port.

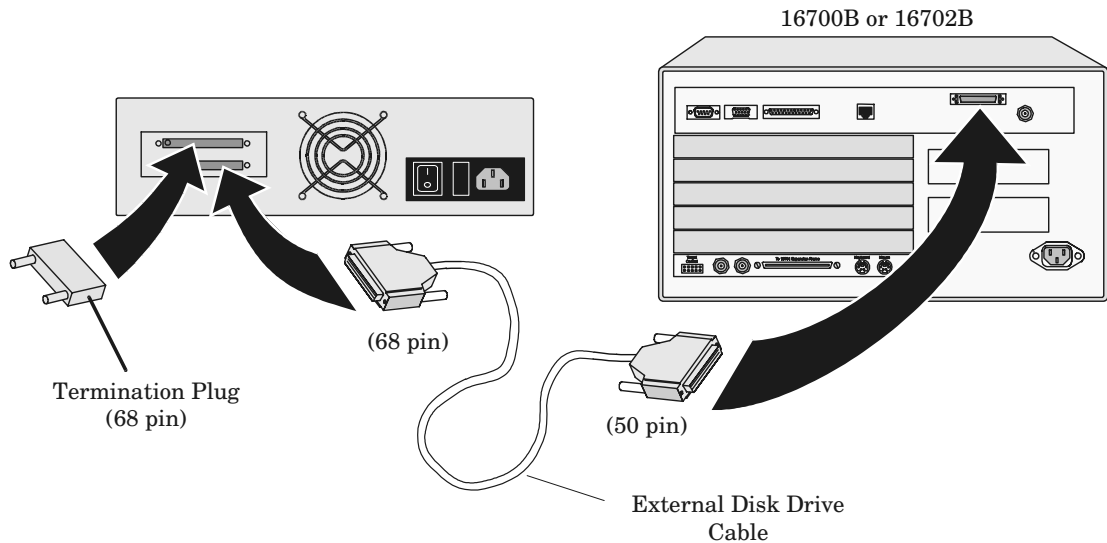

- 5 Power up the boot drive, then the monitor, and then the system.



---

## To disconnect a removable boot drive (option 009)

Turn the power off on the system, then the monitor, and then the boot drive.

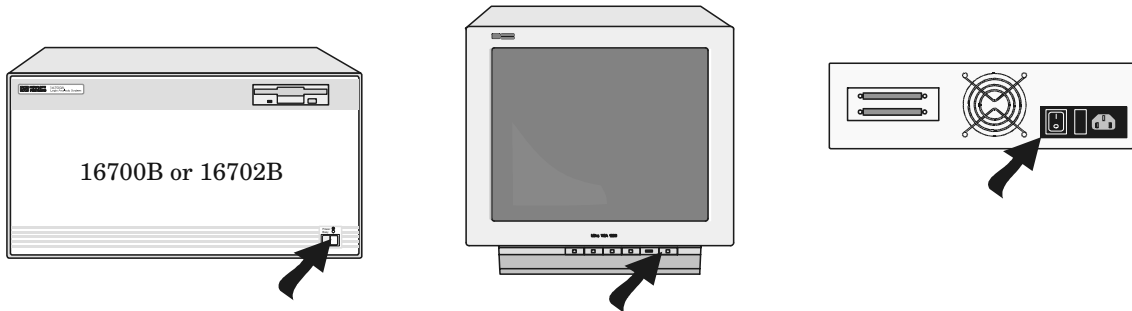

---

## To install software

When a system is shipped, the factory installs the current operating system and ordered processor support packages and tools. The latest software update is available at [www.software.cos.agilent.com/16700](http://www.software.cos.agilent.com/16700).

- 1 Select the Tools icon from the menu bar.

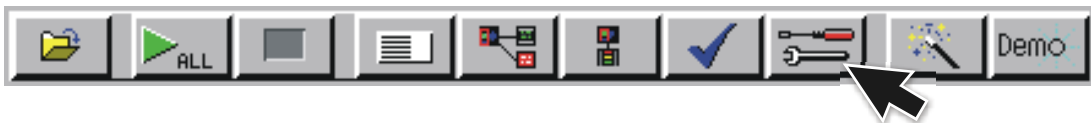

2 Select the Software Install tab and then select Install.

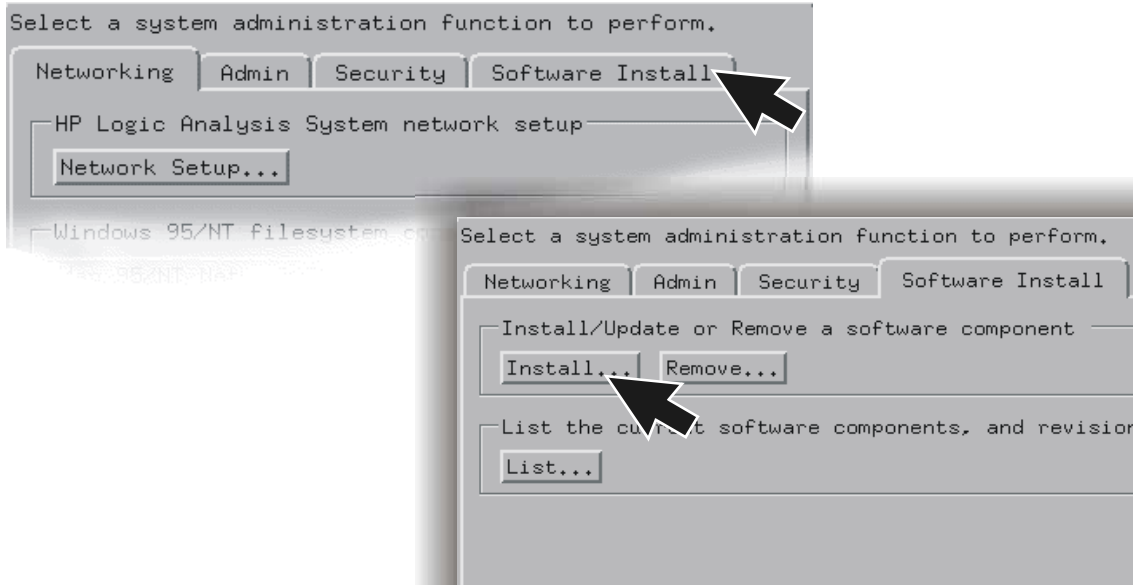

3 Select the media type and select Apply. The resulting window will display software that can be loaded.

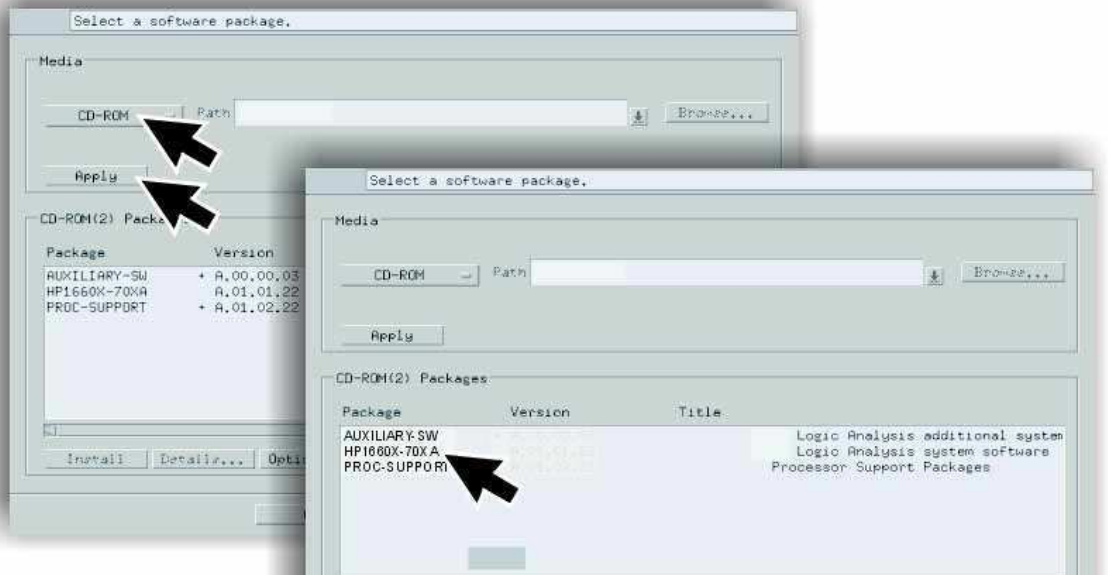

## Chapter 2: Connecting and Configuring Hardware To install software

- 4 To load System Software, highlight it and select Install.

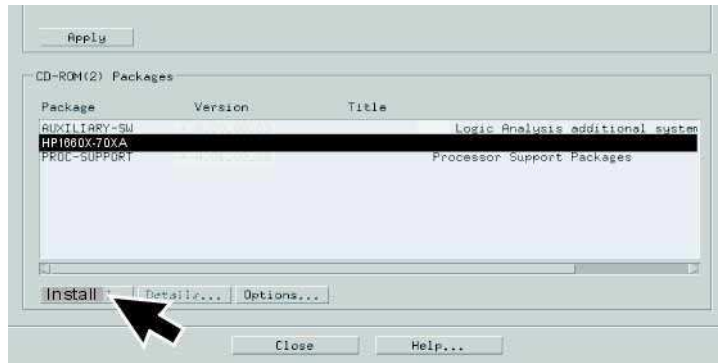

- 5 To load Additional Tools or Processor Support Software:
- Double click to display the available packages.
  - Select one or more desired packages. A second click on a highlighted item will deselect it.
  - Select Install and the system will automatically reboot if it is required by the newly installed package.

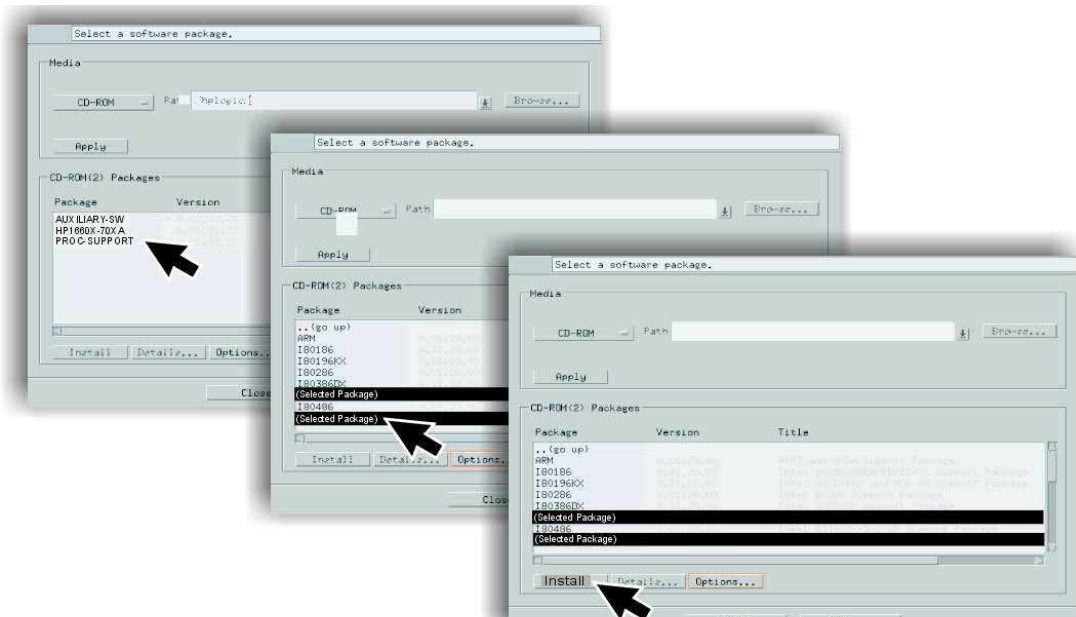

## To connect a 16701B expander frame

- 1 Install your measurement modules in the 16701B expander frame. Module installation instructions are on page 42. For information on specific measurement modules go to:

Module Type	Page
Logic Analyzer	45
Oscilloscope	71
Pattern Generator	87

- 2 Connect either a 30 cm (12 inch) or 90 cm (36 inch) interconnect cable to the expander and system frames.
- 3 Tighten the connector screws with the screwdriver provided.
- 4 Connect the power cable to the 16701B.
- 5 Power up the 16700B or 16702B system.

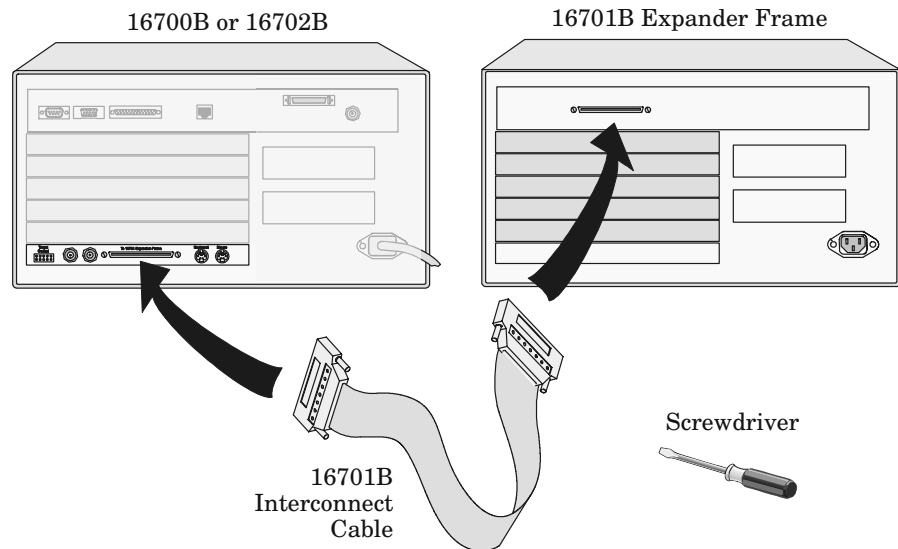

---

## To connect multiple frames

As many as eight 16700B's and/or 16702B's with expander frames may be connected together. To connect multiple frames you need to order 16700B option #012 and/or 16702B option #012.

---

**NOTE:**

The multiframe module requires software Rev. A.02.00.00 or higher. Agilent 16700B and 16702B logic analysis systems ordered with the multiframe option installed will have the current operating system software installed.

- 1** If the multiframe module is already installed, skip to step 11.
- 2** End your logic analysis session.
  - a** Exit all logic analysis sessions. In the session manager, select Shutdown.
  - b** At the query, select Powerdown.
  - c** When the “OK to turn off power or reset system” message appears, turn the instrument off.
  - d** Remove power from the instrument.
- 3** Disconnect the power cable and all data and peripheral cables from the rear panel.
- 4** Move the instrument to a static-safe work area.
- 5** Lay the instrument on its side so the handle side is up.
- 6** Using a Torx T10 screwdriver, remove two feet and one screw at the center rear of the cover that secures the bottom cover to the frame.

**7** Slide the bottom cover toward the rear of the instrument and away..

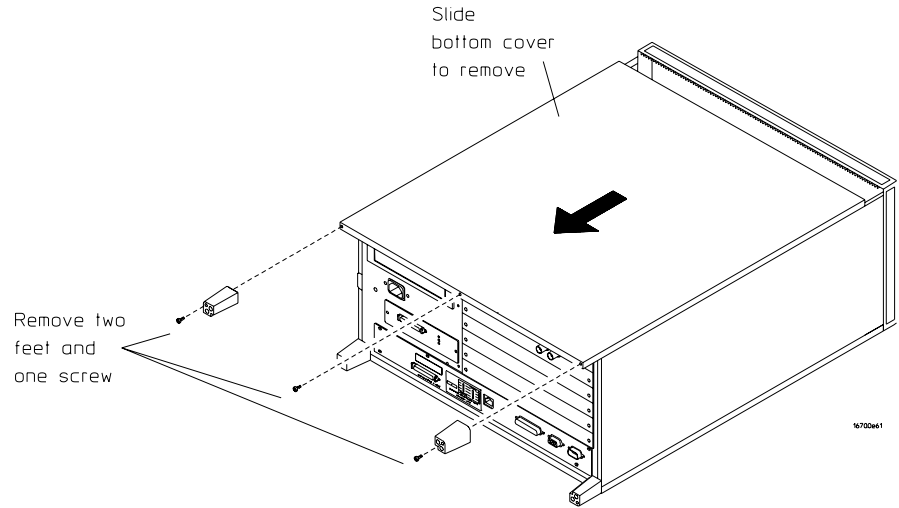

**8** Remove the cover plate.

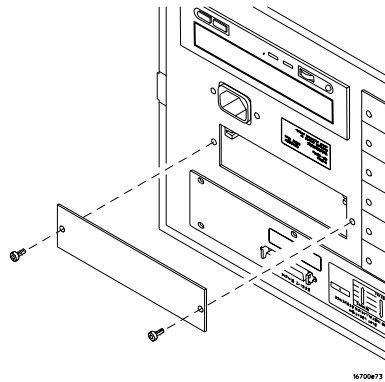

Chapter 2: Connecting and Configuring Hardware  
**To connect multiple frames**

- 9 Insert the Multiframe Module with the cable attached.

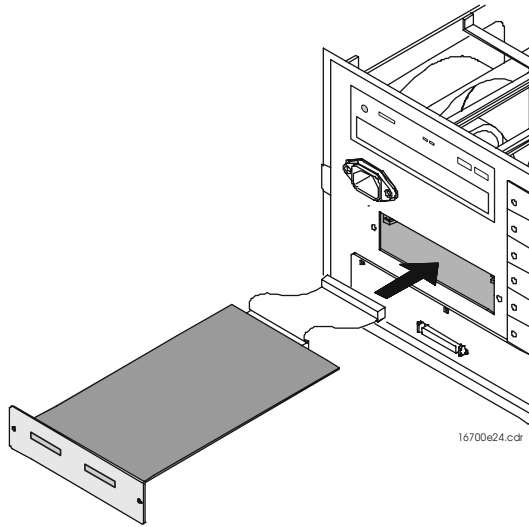



- 10 Connect the Multiframe Module cable to the connector on the bottom side of the Interface Board, insert the screws and reassemble the frame.

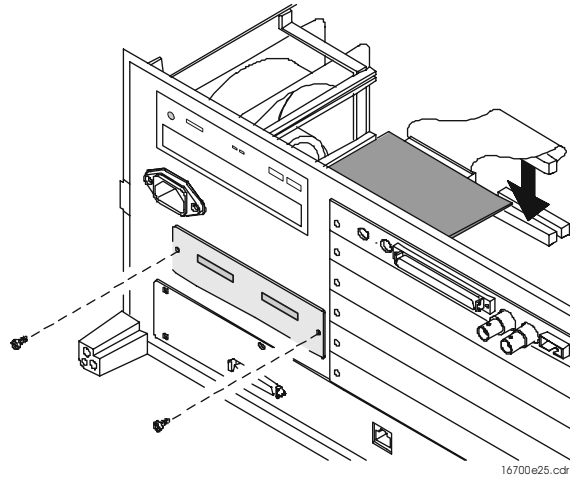

- 11 Connect mainframe and expander frames together. The frame at the beginning of the series must have its INPUT port open and the last frame in the series must have its OUTPUT port open.

Input port open on first frame



Output port open on last frame



---

## To install, remove, or replace measurement modules

---

**CAUTION:** Electrostatic discharge can damage electronic components. Use grounded wrist straps and mats when performing any service to measurement modules.

---

**NOTE:** Measurement modules with different model numbers may not be connected together in multi-card (Master/Expander) modules unless stated otherwise.

---

For information on specific measurement modules go to:

Module Type	Page
Logic Analyzer	45
Oscilloscope	71
Pattern Generator	87

- 1 Power down the system and disconnect the power cable before installing, removing or replacing measurement modules.

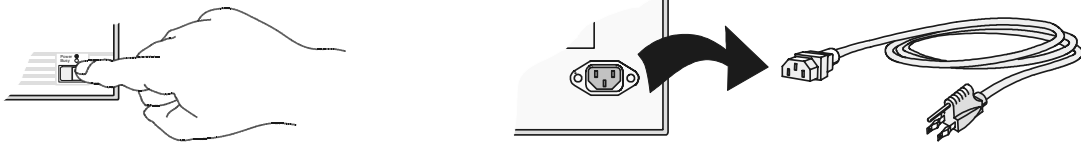

- 2 Remove filler panels and carefully slide the module into the frame.
- 3 Gently apply pressure to the center of the module while tightening the thumb screws.

- 4 If you are inserting more than one module, the tightening order is bottom module to top module. A single-module configuration can be installed in any available slot.

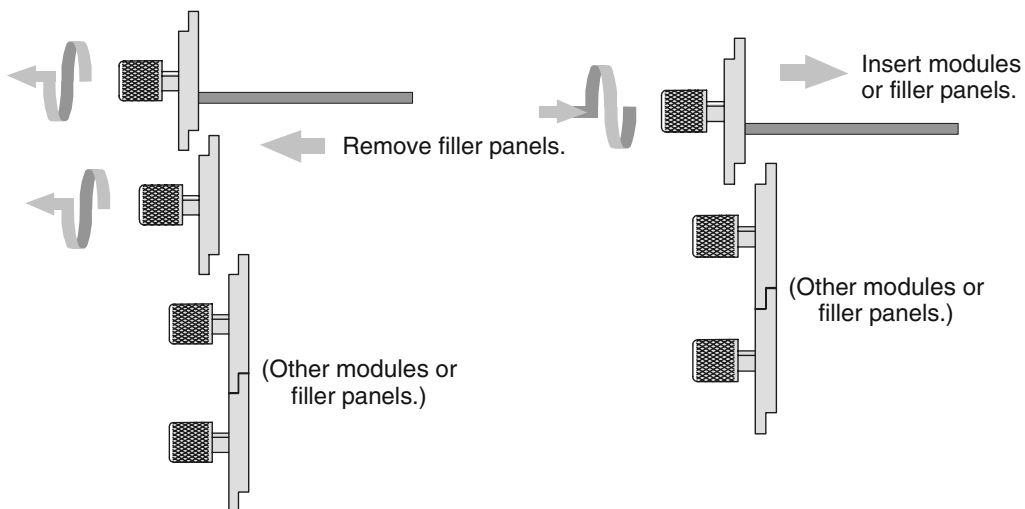

- 5 Some modules require calibration if they are moved to a different slot. For calibration information, refer to the on-line help for the individual modules.

---

**WARNING:**

---

For correct air circulation, filler panels must be installed in all unused card slots. Correct air circulation keeps the instrument from overheating. Keep any extra filler panels for future use.

Chapter 2: Connecting and Configuring Hardware  
**To install, remove, or replace measurement modules**

---

## Installing Logic Analyzer Measurement Modules

## Software Requirements

The following table gives you the software version required in your 16700A/B or 16702A/B mainframe for use with logic analyzer measurement modules. For software installation instructions go to page page 34.

<b>Model Number</b>	<b>Software Version</b>
16517/18A	All versions
16557D	All versions
16710/11/12A	A.01.20.00 or higher
16715/16/17A	A.01.40.00 or higher
16718/19A	A.01.50.00 or higher
16740/41/42A	A.02.50.00 or higher
16750/51/52A	A.02.00.00 or higher
16750/51/52B	A.02.50.00 or higher
16753/54/55/56A	A.02.70.00 or higher
16760A	A.02.20.00 or higher

---

## 16517/18A Logic Analyzer (2-card module)

The 16517A is the master card and the 16518A is the expander card. Connect the cards together in one of the two ways shown below.

---

**NOTE:**

Turn off the mainframe power before removing, replacing, or installing modules following the procedures on page 42.

---

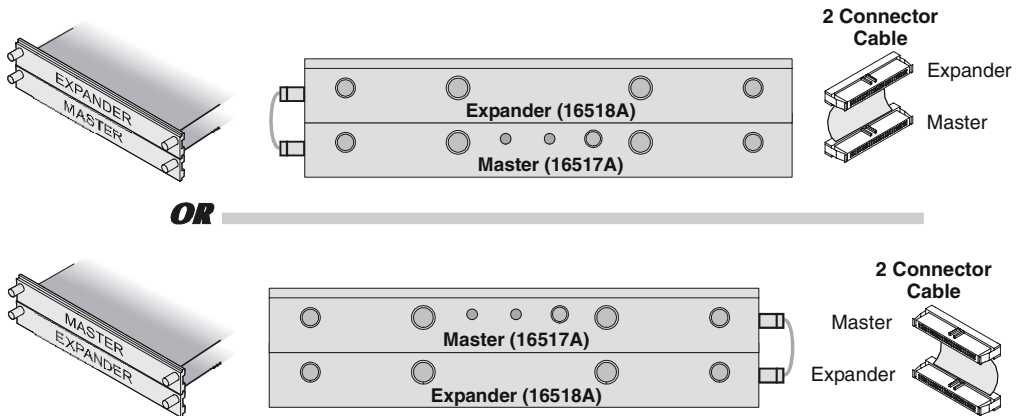

## 16517/18A Logic Analyzer (3-card module)

The 16517A is the master card and the 16518A cards are expander cards. Connect the cards together in one of the three ways shown below.

**NOTE:**

Turn off the mainframe power before removing, replacing, or installing modules following the procedures on page 42.

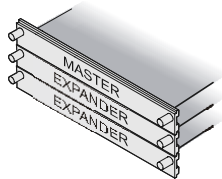

**OR**

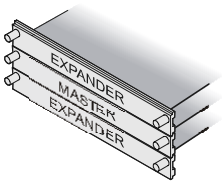
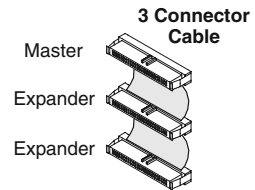
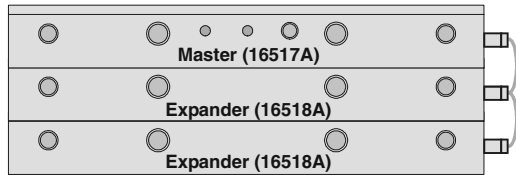

**OR**

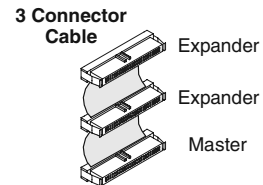
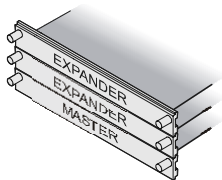
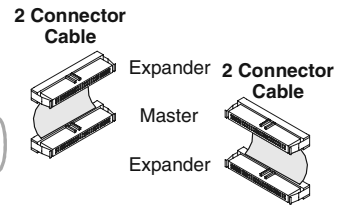
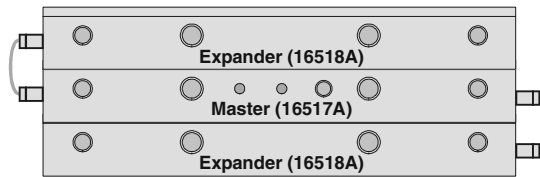



## 16517/18A Logic Analyzer (4-card module)

The 16517A is the master card and the 16518A cards are expander cards. Connect the cards together in one of the two ways shown below.

**NOTE:**

Turn off the mainframe power before removing, replacing, or installing modules following the procedures on page 42.

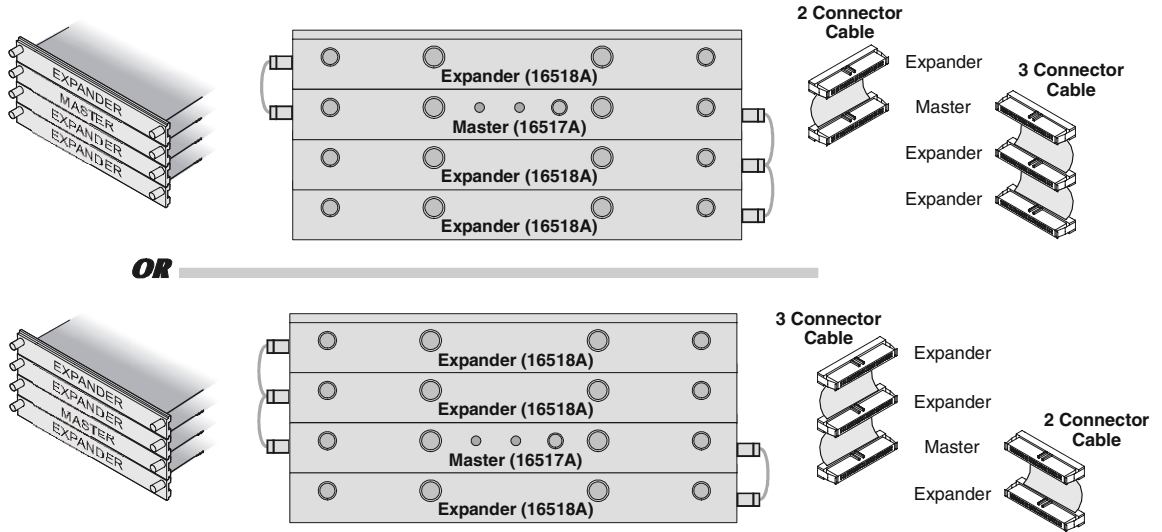

---

## 16517/18A Logic Analyzer (5-card module)

The 16517A is the master card and the 16518A cards are expander cards. Connect the cards together as shown below.

---

**NOTE:**

Turn off the mainframe power before removing, replacing, or installing modules following the procedures on page 42.

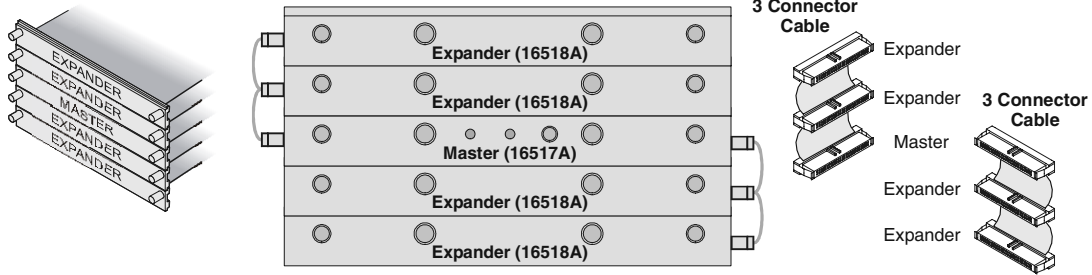

---

## 16557D Logic Analyzer (1-card module)

When ordered as a single card, the 16557D is shipped with a 2 x 10 cable factory configured as a single-card module.

---

**NOTE:**

Turn off the mainframe power before removing, replacing, or installing modules following the procedures on page 42.

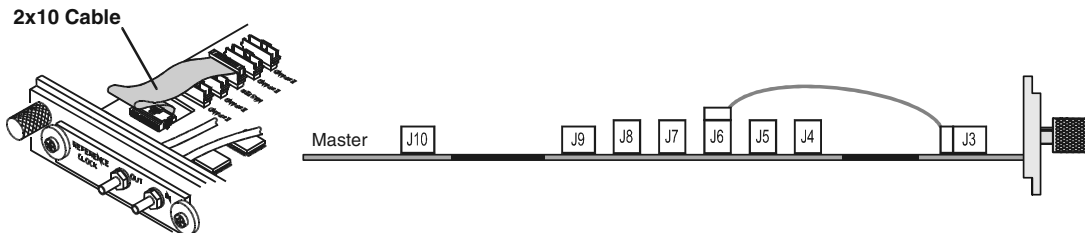

---

## 16557D Logic Analyzer (2-card module)

Use two 2 x 25 cables and two 2 x 10 cables to connect the cards as shown.

---

**NOTE:**

Turn off the mainframe power before removing, replacing, or installing modules following the procedures on page 42.

---

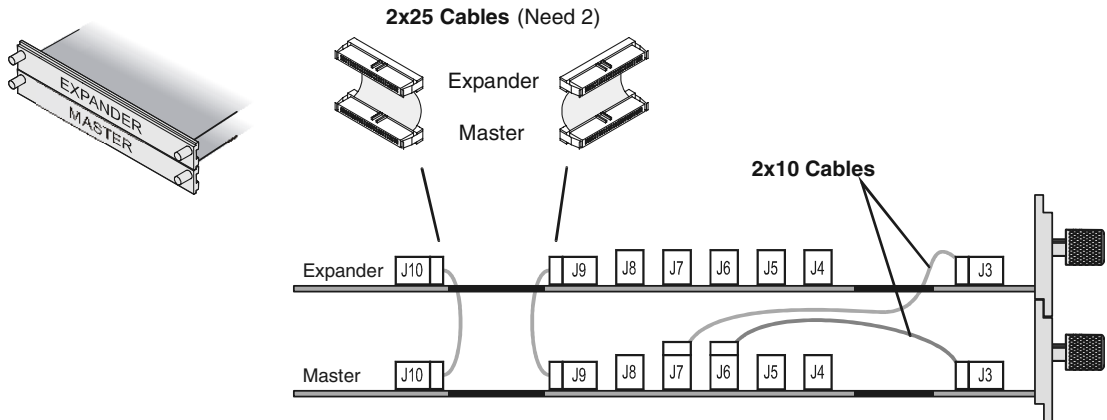

---

## 16557D Logic Analyzer (3-card module)

Use two 2 x 25 cables and three 2 x 10 cables to connect the cards as shown.

---

**NOTE:**

Turn off the mainframe power before removing, replacing, or installing modules following the procedures on page 42.

---

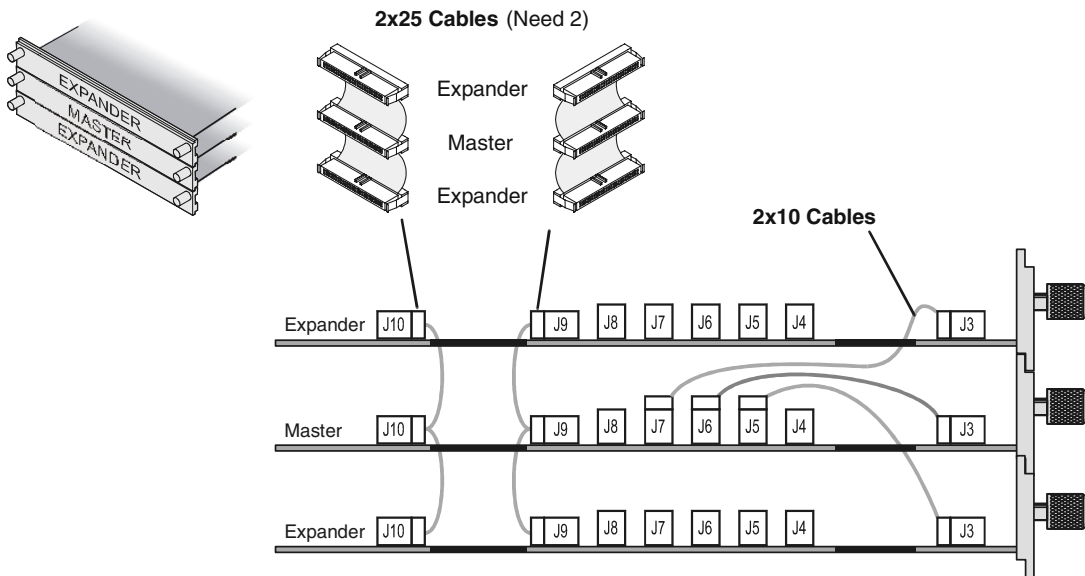

## 16557D Logic Analyzer (3-card module)

Use two 2 x 25 cables and four 2 x 10 cables to connect the cards as shown.

**NOTE:**

Turn off the mainframe power before removing, replacing, or installing modules following the procedures on page 42.

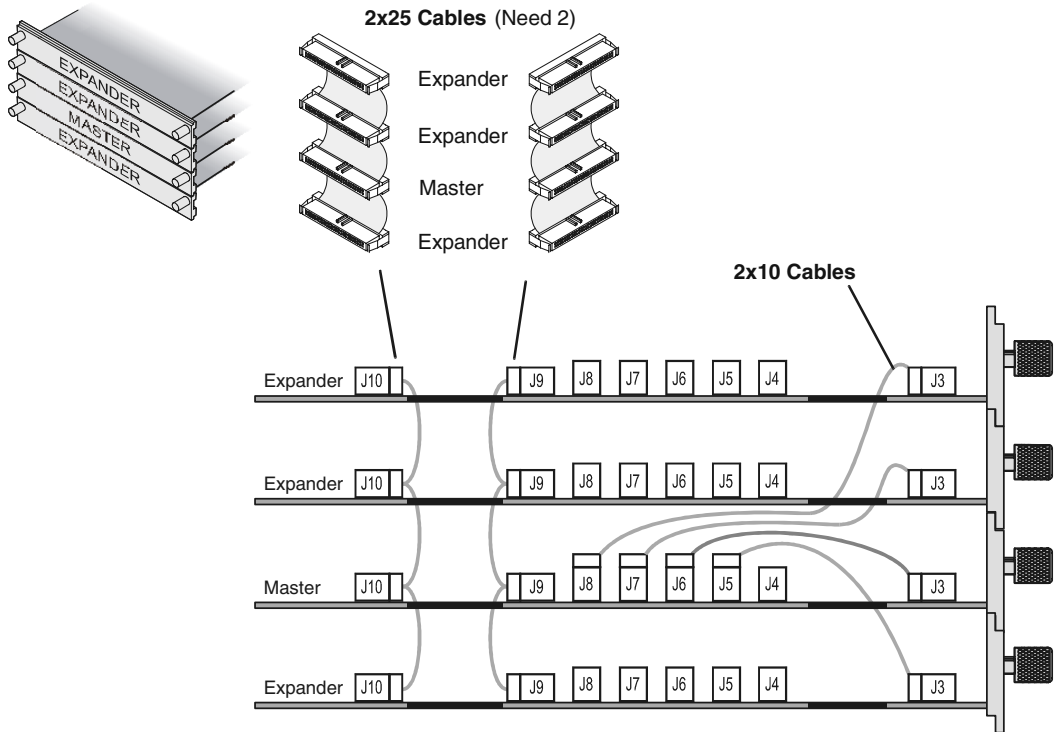

## 16557D Logic Analyzer (5-card module)

Use two 2 x 25 cables and five 2 x 10 cables to connect the cards as shown.

**NOTE:**

Turn off the mainframe power before removing, replacing, or installing modules following the procedures on page 42.

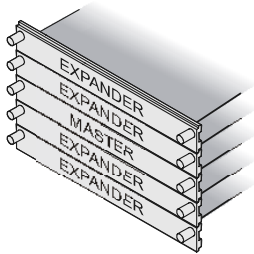

**2x25 Cables (Need 2)**

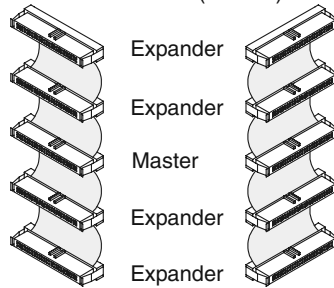

**2x10 Cables**

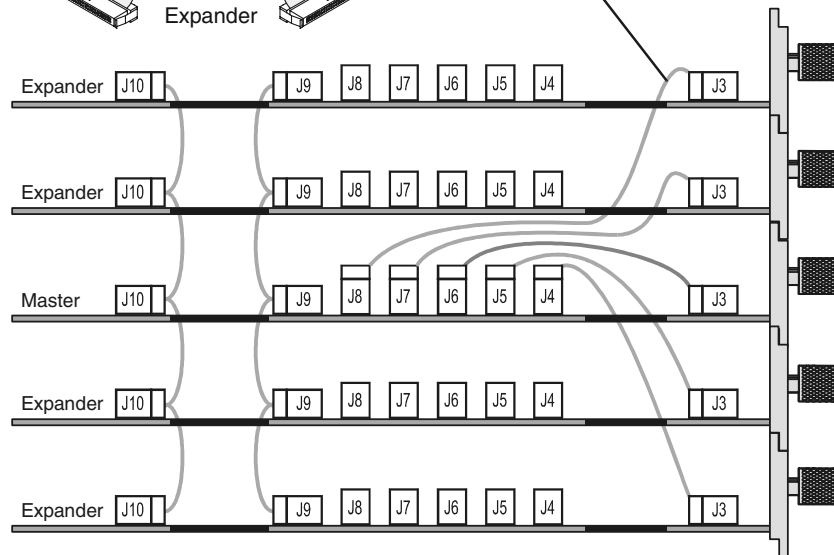

---

## 16710/11/12A Logic Analyzer (1-card module)

A single 16710/11/12A logic analyzer module will have the 2 x 40 cable connected in the single-card configuration.

---

**NOTE:**

Turn off the mainframe power before removing, replacing, or installing modules following the procedures on page 42.

---

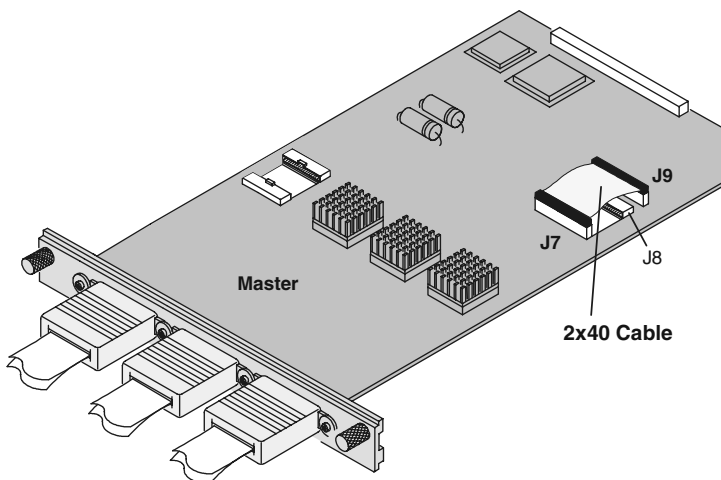

---

**NOTE:**

Measurement modules with different model numbers may not be connected together in multi-card (Master/Expander) modules.

---

## 16710/11/12A Logic Analyzer (2-card module)

Connect two modules as shown using two 2 x 25 cables and two 2 x 40 cables.

**NOTE:**

Turn off the mainframe power before removing, replacing, or installing modules following the procedures on page 42.

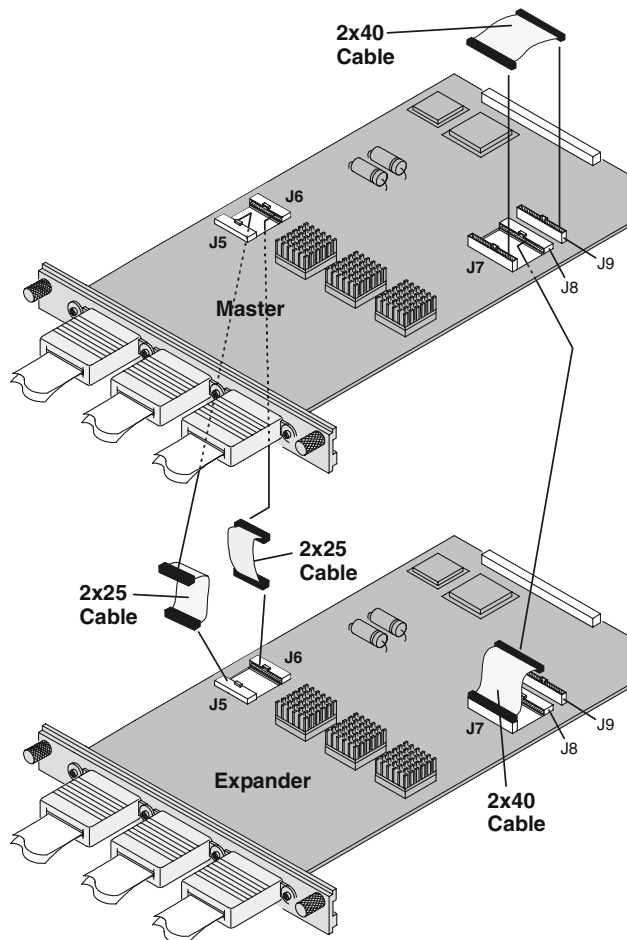

**NOTE:**

Measurement modules with different model numbers may not be connected together in multi-card (Master/Expander) modules.



---

## 16715/16/17A, 16718/19A, 16740/41/42A, 16750/51/52A/B Logic Analyzer (1-card module)

Each card shipped stand-alone has the 2 x 10 cable connected in the single-card module configuration. A single-card module can be installed in any available slot.

---

**NOTE:**

Turn off the mainframe power before removing, replacing, or installing modules following the procedures on page 42.

---

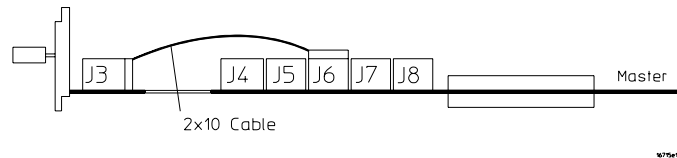

---

**NOTE:**

Measurement modules with different model numbers may not be connected together in multi-card (Master/Expander) modules.

---

**16715/16/17A, 16718/19A, 16740/41/42A, 16750/51/52A/B Logic Analyzer (2-card module)**

---

**16715/16/17A, 16718/19A, 16740/41/42A, 16750/51/52A/B Logic Analyzer (2-card module)**

Use two 2 x 10 cables and two 2 x 40 cables (in the accessory pouch) to connect the modules.

---

**NOTE:**

Turn off the mainframe power before removing, replacing, or installing modules following the procedures on page 42.

---

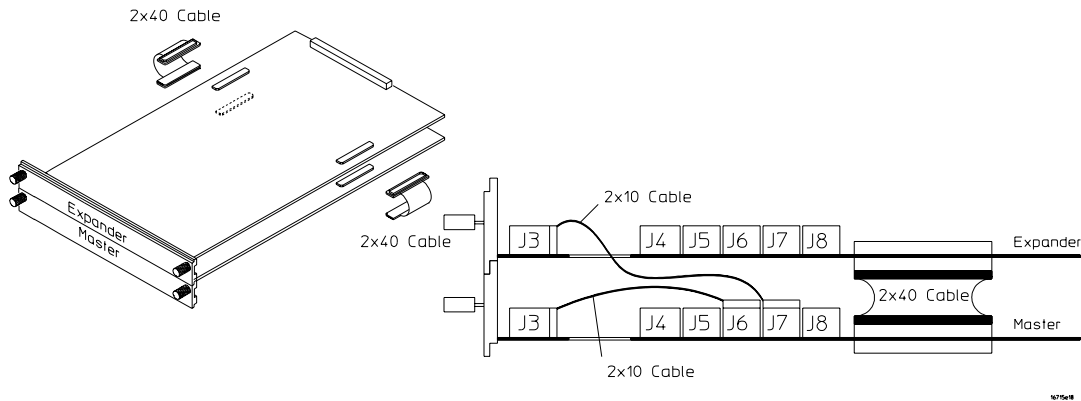

---

**NOTE:**

Measurement modules with different model numbers may not be connected together in multi-card modules. However, the 16750A works with the 16750B; the 16751A works with the 16751B; the 16752A works with the 16752B.

---

## 16715/16/17A, 16718/19A, 16740/41/42A, 16750/51/52A/B Logic Analyzer (3-card module)

Use three 2 x 10 cables and four 2 x 40 cables (in the accessory pouch) to connect the modules.

**NOTE:**

Turn off the mainframe power before removing, replacing, or installing modules following the procedures on page 42.

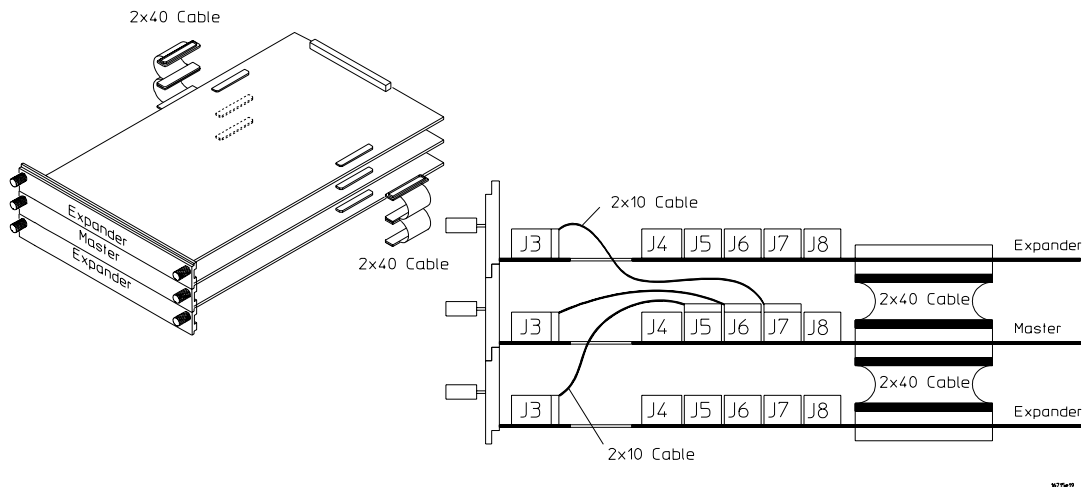

**NOTE:**

Measurement modules with different model numbers may not be connected together in multi-card modules. However, the 16750A works with the 16750B; the 16751A works with the 16751B; the 16752A works with the 16752B.

**16715/16/17A, 16718/19A, 16740/41/42A, 16750/51/52A/B Logic Analyzer (4-card module)**

**16715/16/17A, 16718/19A, 16740/41/42A, 16750/51/52A/B Logic Analyzer (4-card module)**

Use four 2 x 10 cables and six 2 x 40 cables (in the accessory pouch) to connect the modules.

**NOTE:**

Turn off the mainframe power before removing, replacing, or installing modules following the procedures on page 42

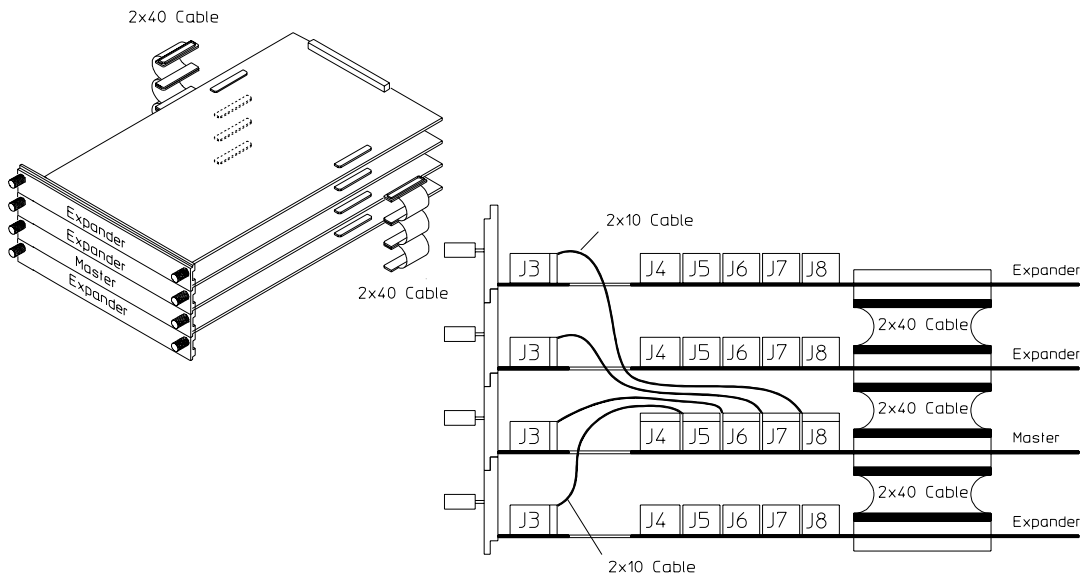

**NOTE:**

Measurement modules with different model numbers may not be connected together in multi-card modules. However, the 16750A works with the 16750B; the 16751A works with the 16751B; the 16752A works with the 16752B.

## 16715/16/17A, 16718/19A, 16740/41/42A, 16750/51/52A/B Logic Analyzer (5-card module)

Use five 2 x 10 cables and eight 2 x 40 cables (in the accessory pouch) to connect the modules

**NOTE:**

Turn off the mainframe power before removing, replacing, or installing modules following the procedures on page 42.

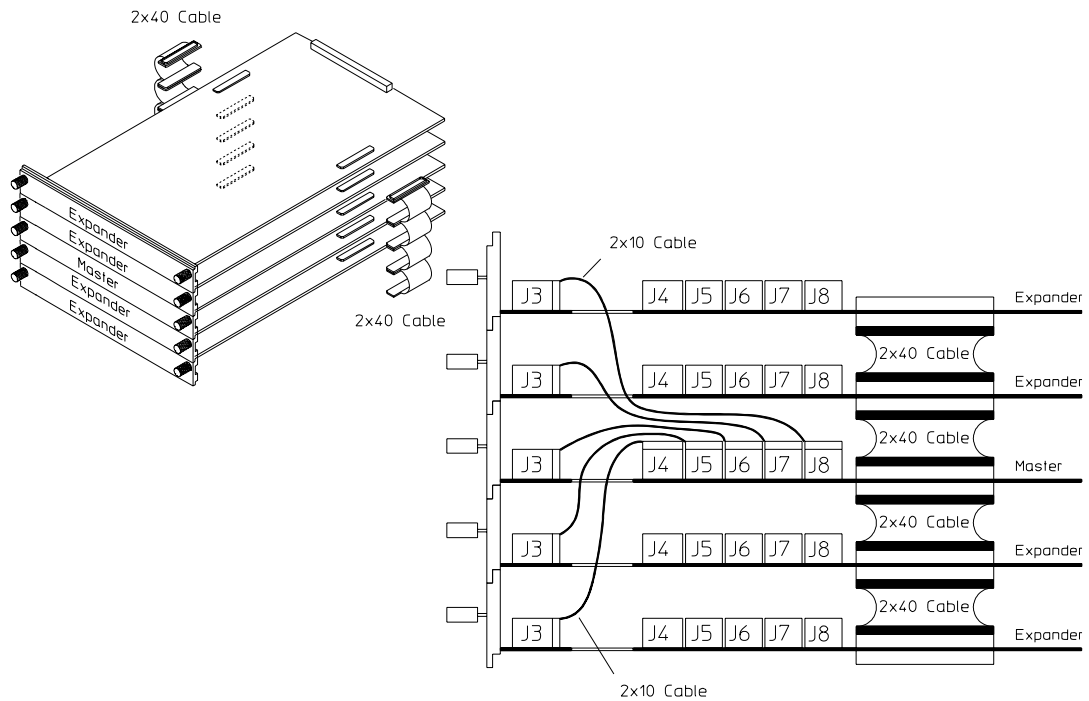

**NOTE:**

Measurement modules with different model numbers may not be connected together in multi-card modules. However, the 16750A works with the 16750B; the 16751A works with the 16751B; the 16752A works with the 16752B.

## 16753/54/55/56A Logic Analyzer (1-card module)

Each card shipped stand-alone has the 2 x 15 cable connected in the single-card module configuration. The 2 x 50 cables in the accessory pouch are not used. A single-card module can be installed in any available slot.

---

**NOTE:**

---

Turn off the mainframe power before removing, replacing, or installing modules following the procedures on page 42.

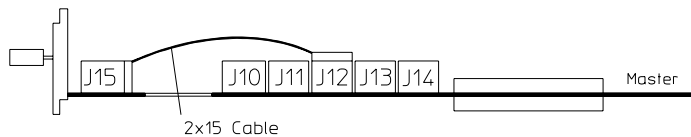

10754002

---

## 16753/54/55/56A Logic Analyzer (2-card module)

Use two 2 x 15 cables and two 2 x 50 cables (in the accessory pouch) to connect the modules.

---

**NOTE:**

Turn off the mainframe power before removing, replacing, or installing modules following the procedures on page 42.

---

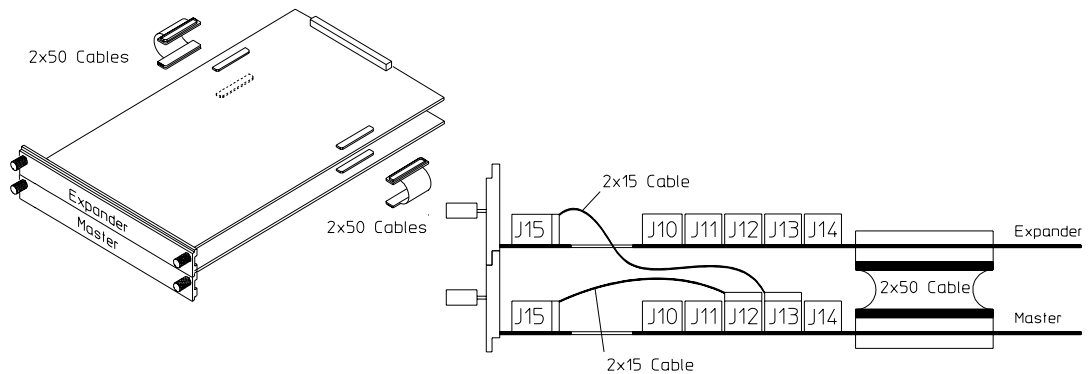

---

**NOTE:**

Measurement modules with different model numbers can be mixed in multi-card modules.

---

## 16753/54/55/56A Logic Analyzer (3-card module)

Use three 2 x 15 cables and four 2 x 50 cables (in the accessory pouch) to connect the modules.

**NOTE:**

Turn off the mainframe power before removing, replacing, or installing modules following the procedures on page 42.

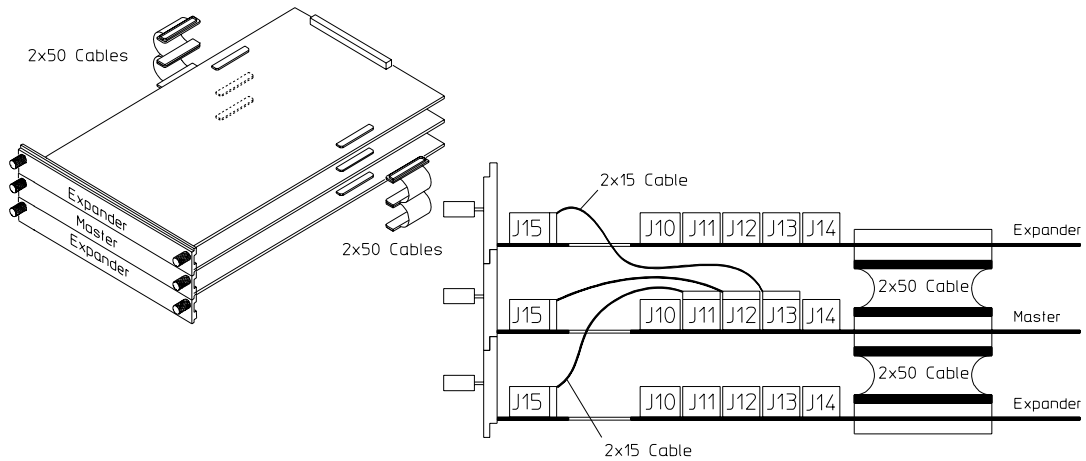

**NOTE:**

Measurement modules with different model numbers can be mixed in multi-card modules.



## 16753/54/55/56A Logic Analyzer (4-card module)

Use four 2 x 15 cables and six 2 x 50 cables (in the accessory pouch) to connect the modules.

**NOTE:**

Turn off the mainframe power before removing, replacing, or installing modules following the procedures on page 42

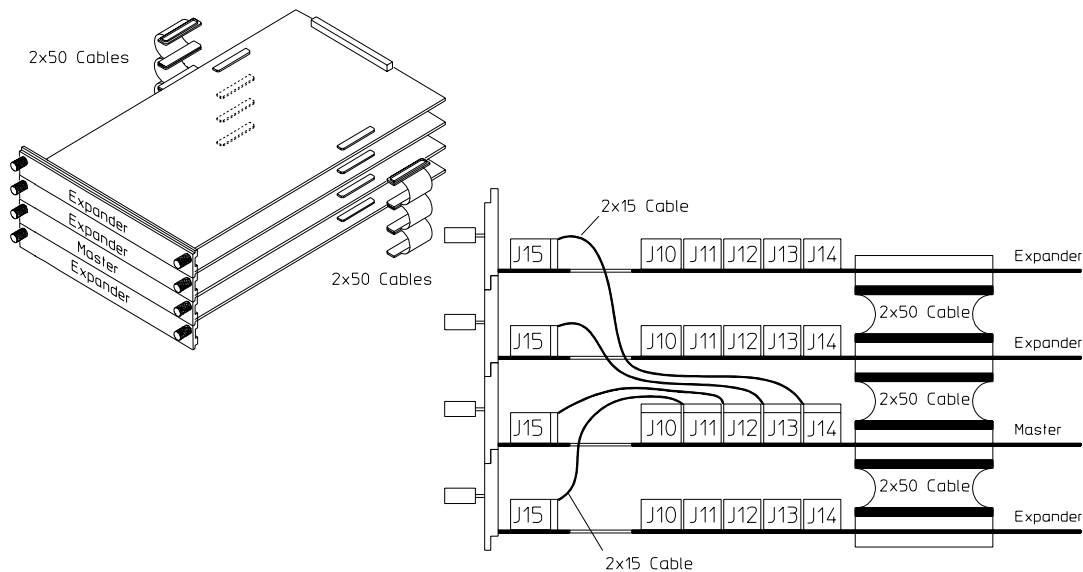

**NOTE:**

Measurement modules with different model numbers can be mixed in multi-card modules.

## 16753/54/55/56A Logic Analyzer (5-card module)

Use five 2 x 15 cables and eight 2 x 50 cables (in the accessory pouch) to connect the modules.

**NOTE:**

Turn off the mainframe power before removing, replacing, or installing modules following the procedures on page 42.

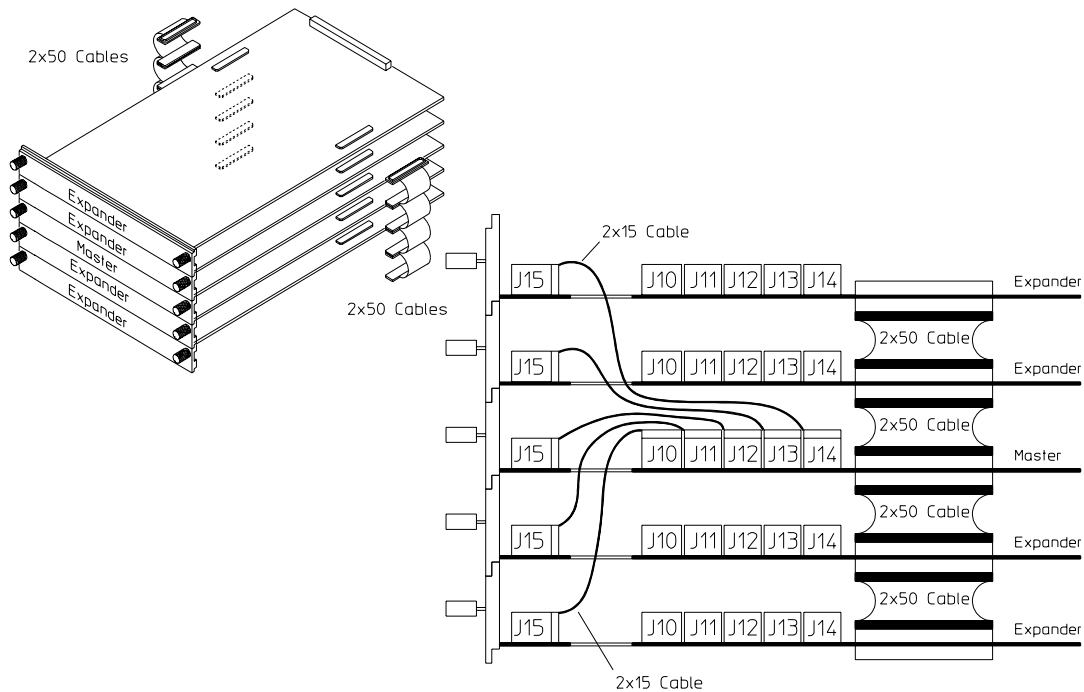

**NOTE:**

Measurement modules with different model numbers can be mixed in multi-card modules.

---

## 16760A Logic Analyzer (1-card module)

A single 16760A logic analyzer module will have the 2 x 10 cable connected in the single-card configuration.

---

**NOTE:**

Turn off the mainframe power before removing, replacing, or installing modules following the procedures on page 42.

---

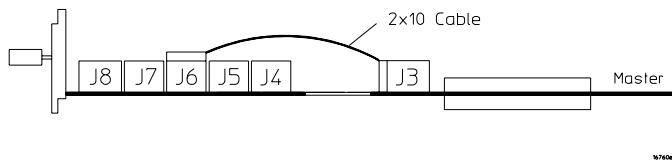

---

## 16760A Logic Analyzer (2-card module)

Use two 2 x 10 cables and two 2 x 40 cables (in the accessory pouch) to connect the modules.

---

**NOTE:**

Turn off the mainframe power before removing, replacing, or installing modules following the procedures on page 42.

---

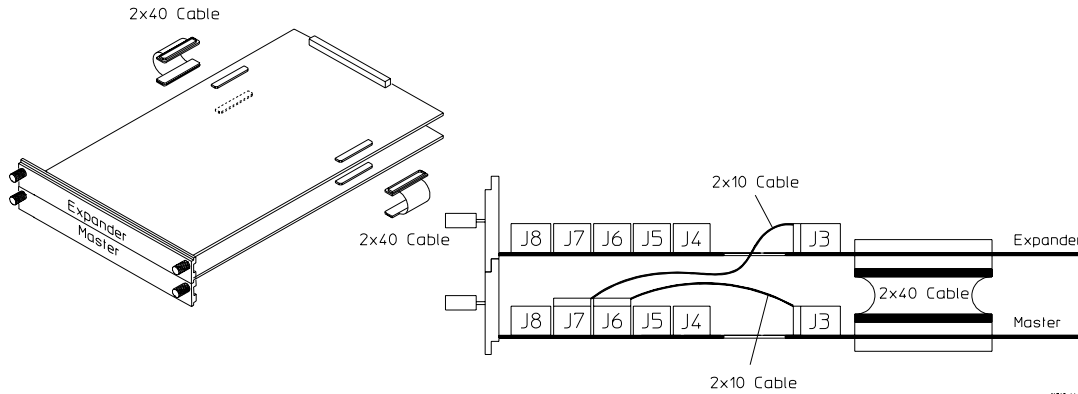

## 16760A Logic Analyzer (3-card module)

Use three 2 x 10 cables and four 2 x 40 cables (in the accessory pouch) to connect the modules.

**NOTE:**

Turn off the mainframe power before removing, replacing, or installing modules following the procedures on page 42.

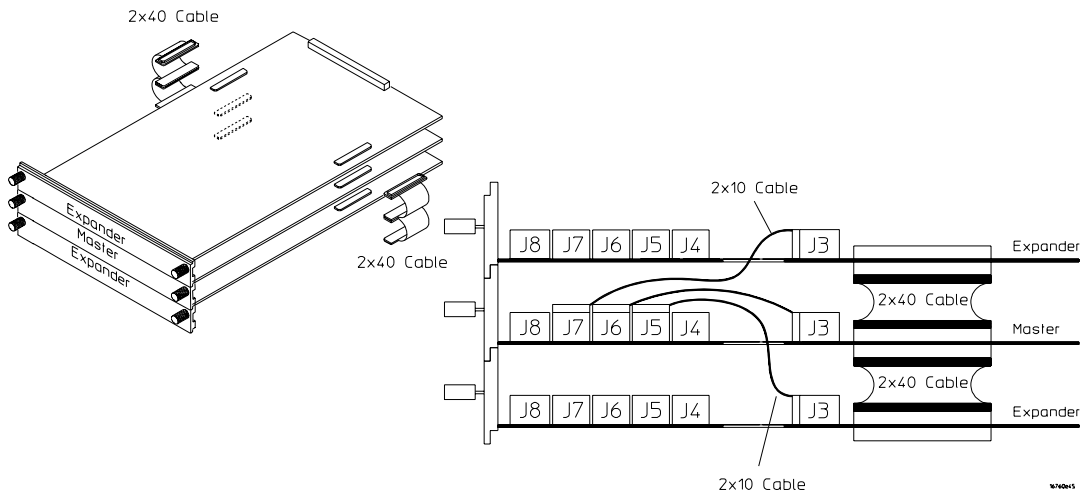

## 16760A Logic Analyzer (4-card module)

Use four 2 x 10 cables and six 2 x 40 cables (in the accessory pouch) to connect the modules.

**NOTE:**

Turn off the mainframe power before removing, replacing, or installing modules following the procedures on page 42.

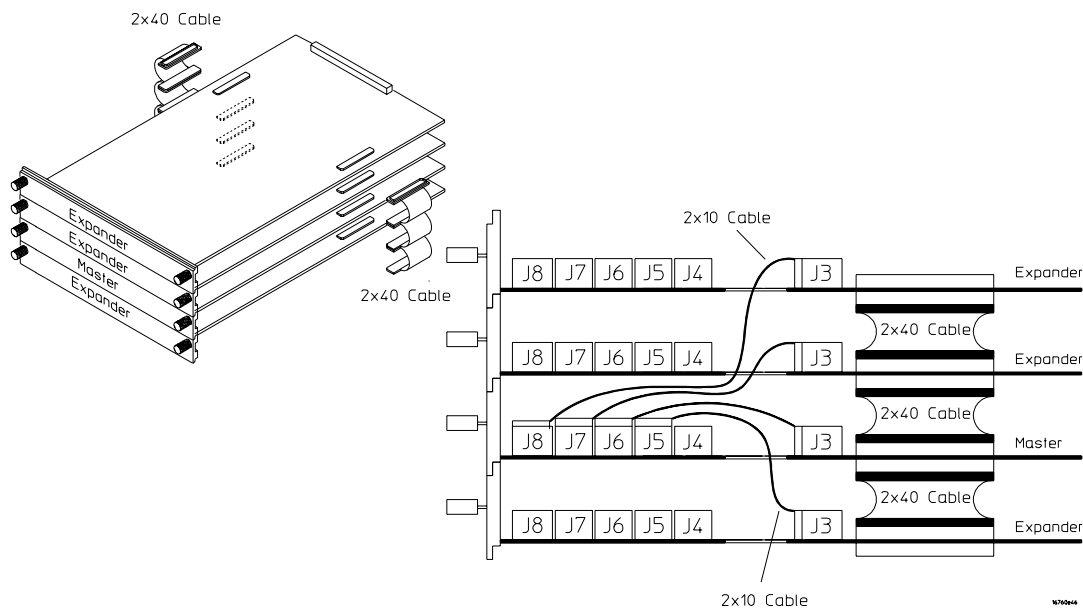

## 16760A Logic Analyzer (5-card module)

Use five 2 x 10 cables and eight 2 x 40 cables (in the accessory pouch) to connect the modules.

**NOTE:**

Turn off the mainframe power before removing, replacing, or installing modules following the procedures on page 42.

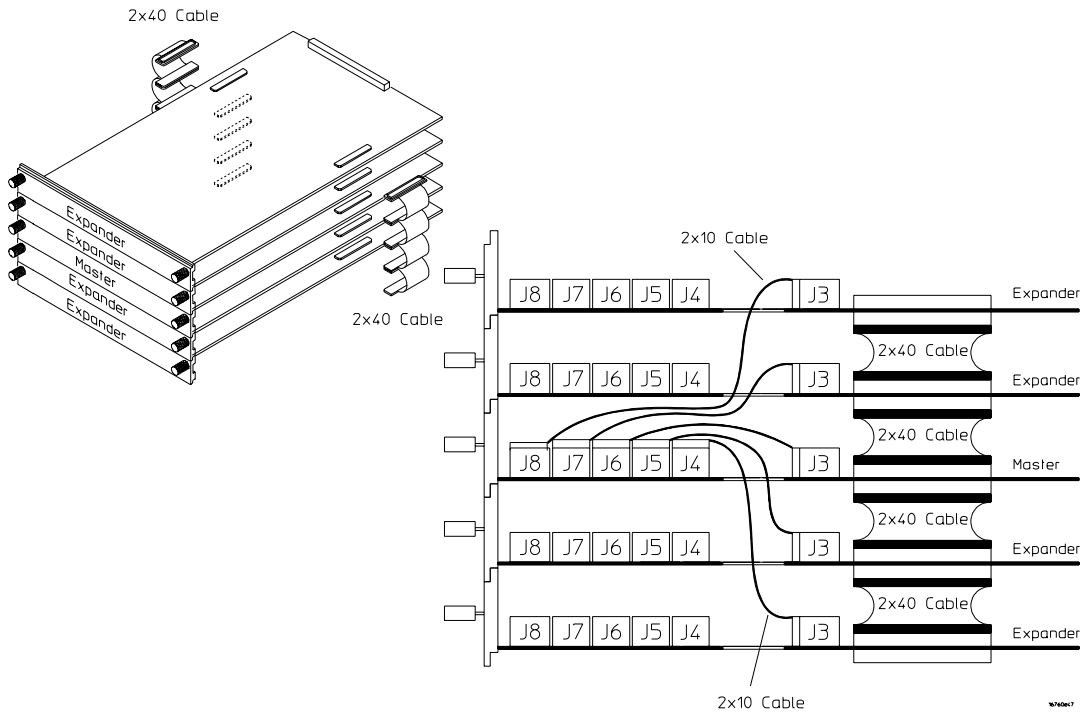

---

Installing Oscilloscope  
Measurement Modules

## 16533/34A Oscilloscope Module (single or multi-card modules)

The Agilent Technologies 16533A/34A oscilloscope module functions as either a master card or expander card. It is compatible with all versions of software in your 16700A/B or 16702A/B mainframe. The circuitry in the module requires an operational accuracy calibration to optimize measurement accuracy.

A multicard module should contain either all 16533A or 16534A cards.

---

**NOTE:**

Each of the individual cards of a multicard 16533A or a multicard 16534A module must first be calibrated as a single card. After reconfiguring into a multicard module, the channel skew calibration needs to be done.

---

### Step 1 Prepare a single 16533/34A card for calibration

---

**CAUTION:**

The effects of ELECTROSTATIC DISCHARGE can damage components. Use grounded wrist straps and mats when you are performing any kind of service on this module.

---

- 1 Power down your 16700A/B or 16702A/B mainframe.

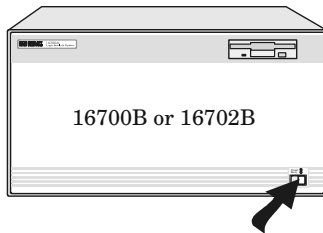

- 2 Remove all modules and filler panels from the mainframe and set the PROTECTED/UNPROTECTED switch to UNPROTECTED.



Chapter 4: Installing Oscilloscope Measurement Modules  
**16533/34A Oscilloscope Module (single or multi-card modules)**

**NOTE:**

If you calibrate a module without unprotecting the memory, the new calibration settings will not be saved when the system is shut down. The system will default to the previous settings. The new calibration settings would be effective for the current active session only.

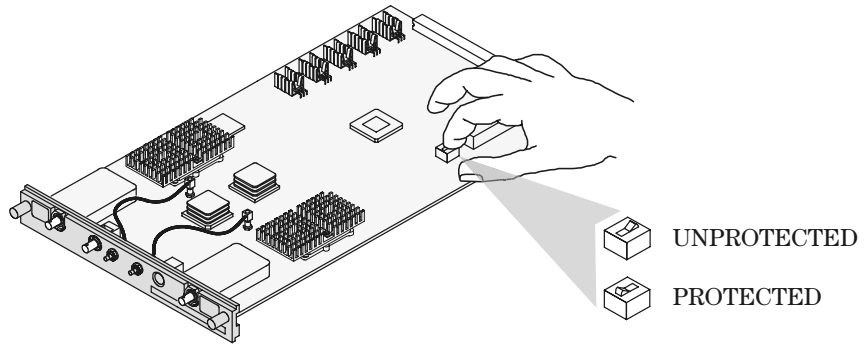

- 3 Reinstall the 16533/34A modules and filler panels into the mainframe.

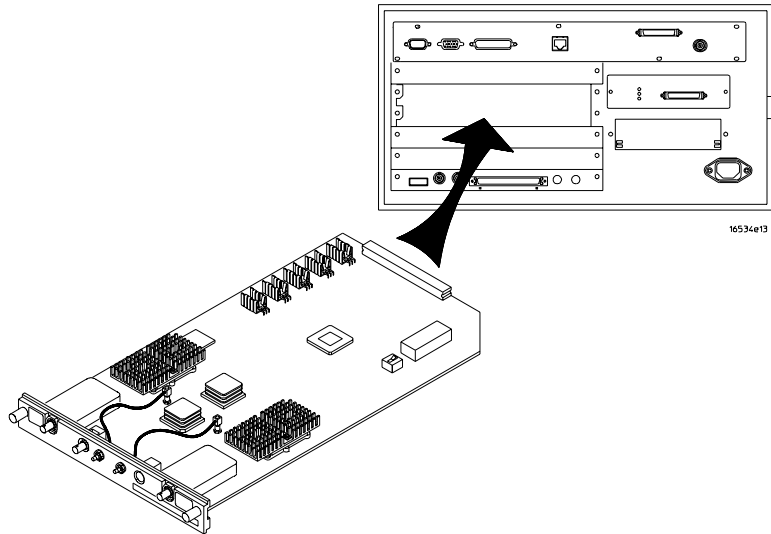

Chapter 4: Installing Oscilloscope Measurement Modules  
**16533/34A Oscilloscope Module (single or multi-card modules)**

- 4 Power up the monitor (if applicable) and then the system.

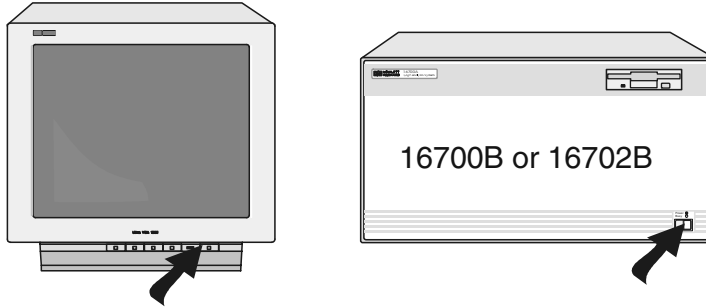

- 5 For more accurate calibration, allow the system 30 minutes to warm up.



## **Step 2** **Perform operational accuracy calibration**

- 1** Connect the BNC Tee and the (equal length) 50-ohm BNC cables to the module.

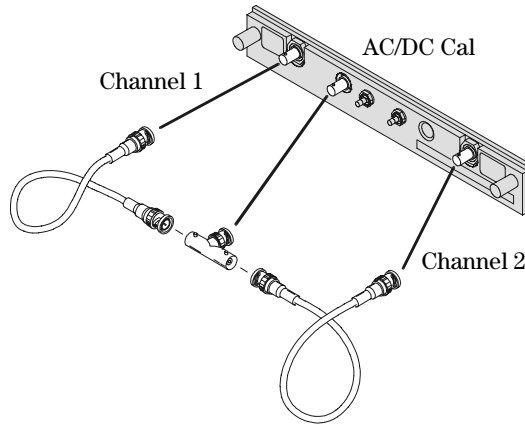

- 2** In the Logic Analysis System window, select the module icon for the 16533A/34A to be calibrated, then select Calibration.

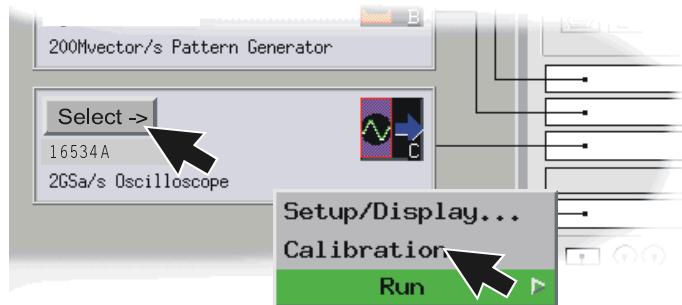

Chapter 4: Installing Oscilloscope Measurement Modules  
**16533/34A Oscilloscope Module (single or multi-card modules)**

- 3 In the Calibration window, select Default Factors. At the confirmation, select OK to load the default factors.

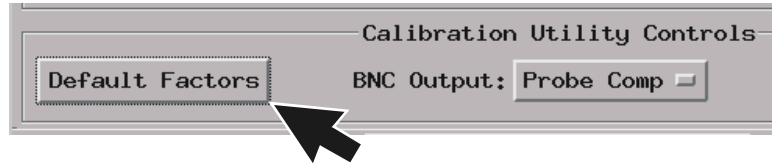

- 4 Select the Run icon and the instrument will remind you to connect the cables to the appropriate locations on the rear panel of the module. Select OK and wait until the operational accuracy calibration is complete.

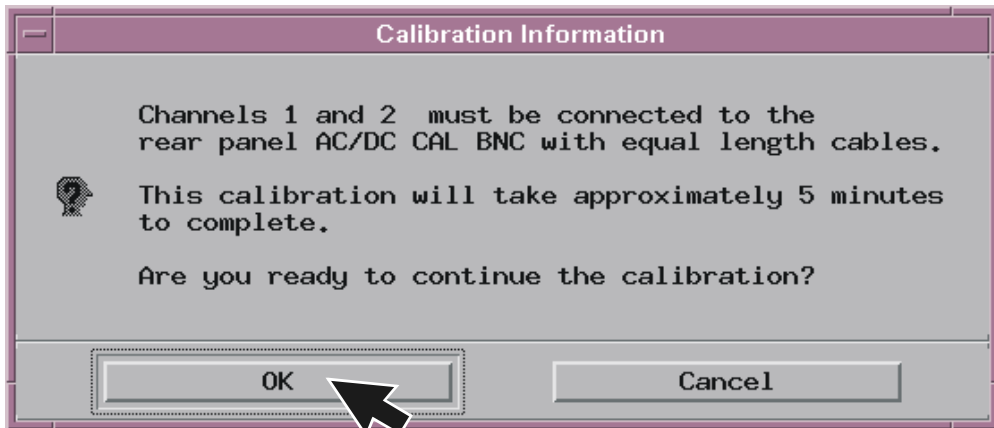
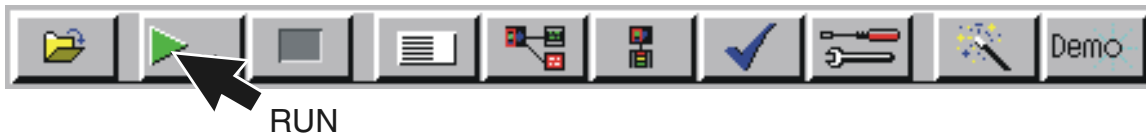

Chapter 4: Installing Oscilloscope Measurement Modules  
**16533/34A Oscilloscope Module (single or multi-card modules)**

As operational accuracy calibration runs, messages appear in the message box on screen.

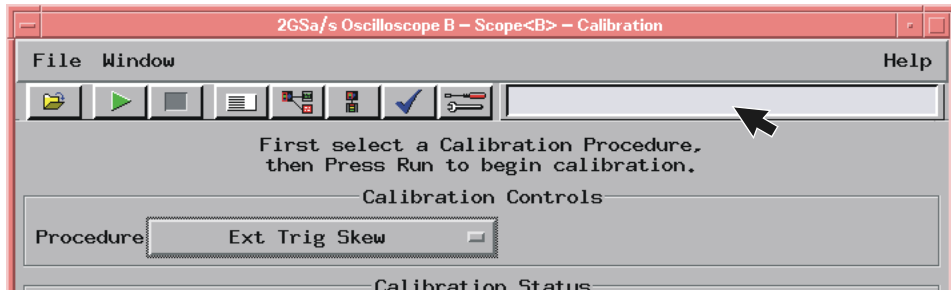

The Calibration Status window indicates pass or fail as each operational accuracy calibration routine is completed. The resulting calibration factors are automatically stored to non-volatile RAM at the conclusion of each calibration routine.

Calibration Status			
PROCEDURE	CHAN 1	CHAN 2	EXT TRIG
ADC	Pass	Pass	
Gain	Pass	Pass	
Offset	Pass	Pass	
Hysteresis	Pass	Pass	
Trigger Level	Pass	Pass	
Trigger Delay	Pass	Pass	
Logic Trigger	Pass	Pass	
Channel Skew			
Ext Trig Skew			Default

### Step 3 Calibrate a single card for external trigger skew

- 1 Connect a 9-inch 50-ohm BNC cable to one side of the BNC tee adapter. On the other side of the BNC tee adapter connect a 9-inch 50-ohm BNC and a BNC(f)/SMB(m) adapter.

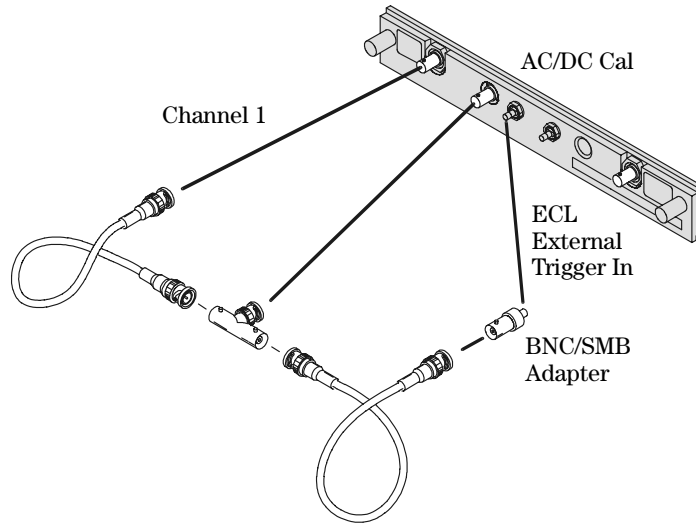

- 2 Select the Procedure field and then select Ext Trig Skew.

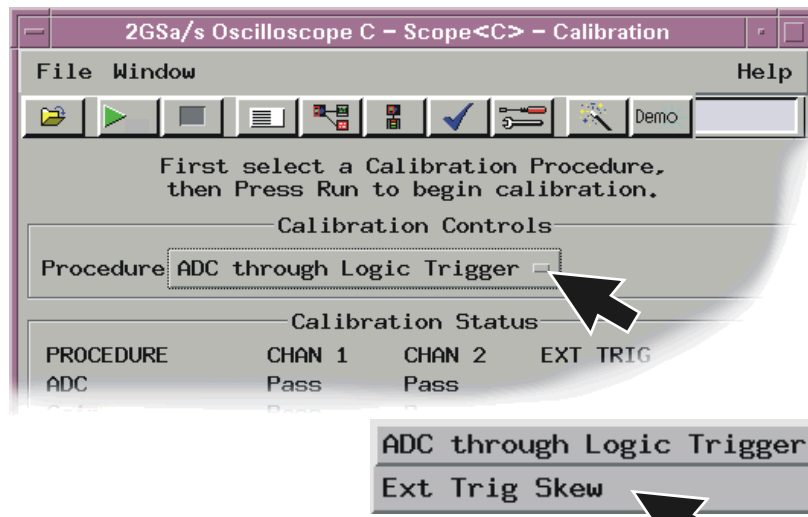

- 3 Select the Run icon and the instrument will remind you to connect the cables. Select OK and wait for the trigger skew calibration to complete.

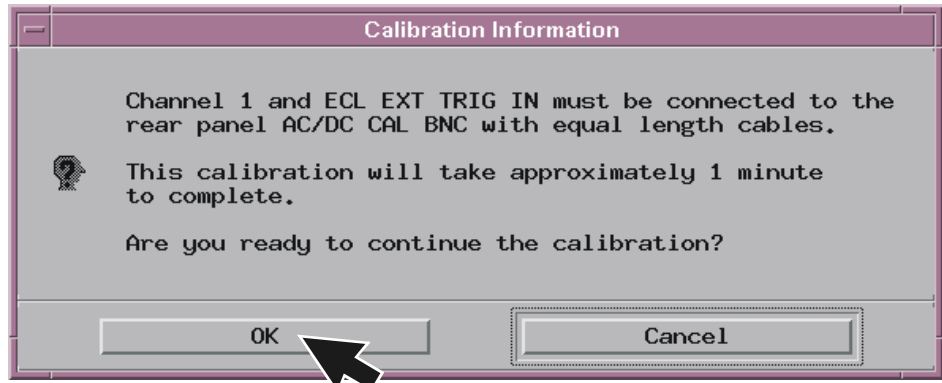
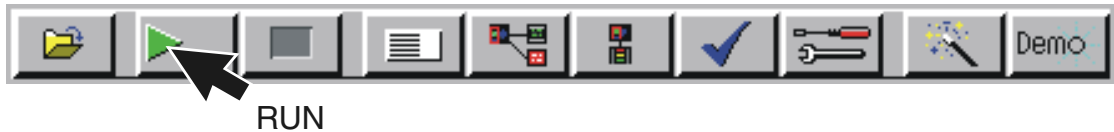

As trigger skew calibration runs, messages appear in the message box on screen. When the Ext Trig Skew calibration is complete, the resulting calibration factors are stored in non-volatile RAM.

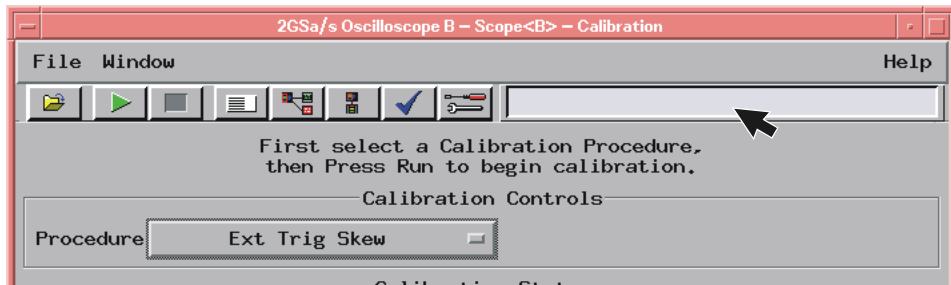

- 4 If a multi-card module is being calibrated, repeat the procedures beginning with Step 1 on page 72 for each card until all cards have been calibrated.
- 5 If all cards have been calibrated, remove the BNC cables from the instrument.
- 6 Select Close in the Calibration window.

Chapter 4: Installing Oscilloscope Measurement Modules  
**16533/34A Oscilloscope Module (single or multi-card modules)**

- 7 In the Logic Analysis System window select File, then select Exit and OK to close the session.

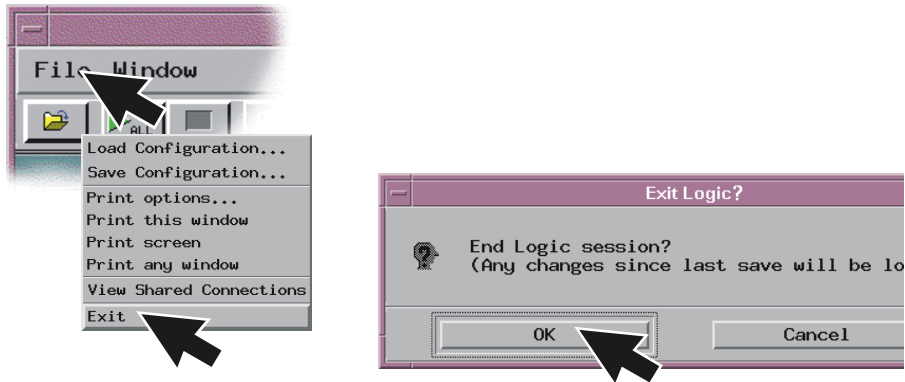

- 8 In the Session Manager window select Shutdown.

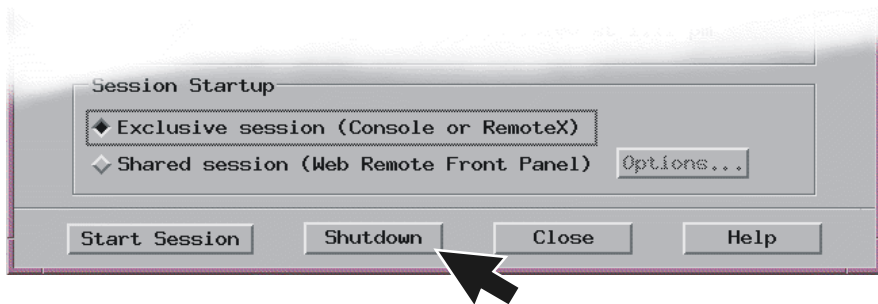

- 9 When the “OK to powerdown” message appears, turn off the power switch.



- 10** If you are only calibrating one card set the PROTECTED/UNPROTECTED switch back to PROTECTED.

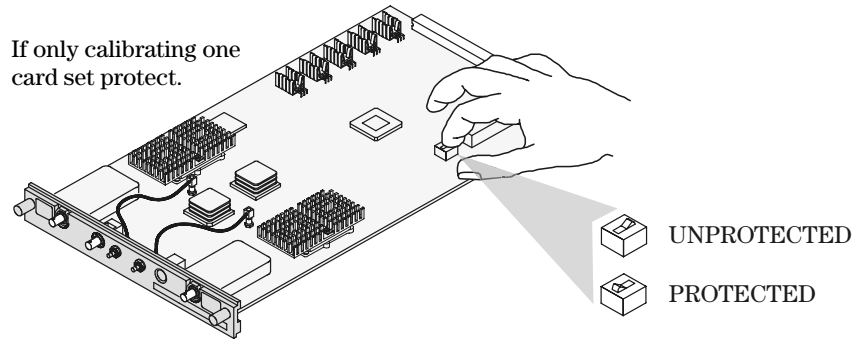

- 11** For multi-card modules, leave the switch set to UNPROTECTED and continue to Step 4 to perform reconfiguration.

**Step 4**  
**Reconfigure multi-card modules**

A multicard module should contain either all 16533A or 16534A cards.

- 1** After calibrating each card individually (following the procedures beginning on page 72) and before applying power to the mainframe, connect the module cables.
- a** Beginning with the top-most card, connect the ECL EXT TRIG OUT to the ECL EXT TRIG IN of the card immediately below. Use the master/expander trigger cable included with the accessory kit of each card.

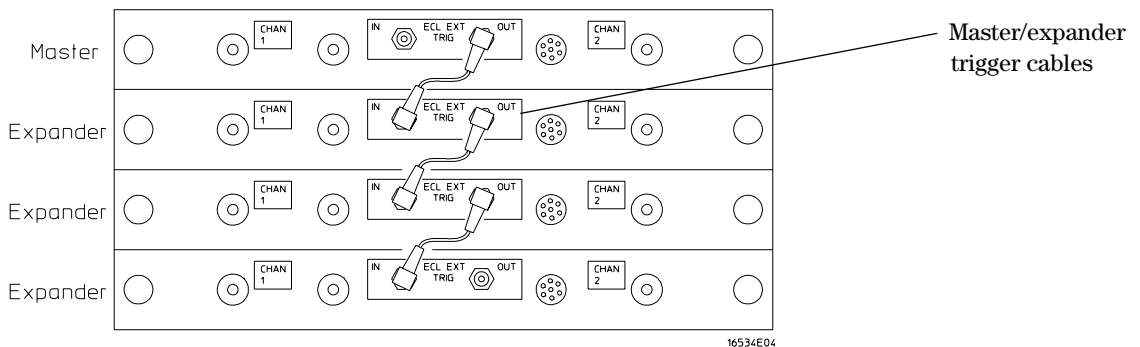

16534E04

Chapter 4: Installing Oscilloscope Measurement Modules  
**16533/34A Oscilloscope Module (single or multi-card modules)**

- b** Repeat for all cards in the module. Up to 4 cards may be configured on a single time base and trigger in a 16700A, 16700B, 16702A, or 16702B mainframe
- 2** Reapply power to the 16700-series mainframe.
- 3** In the Logic Analysis System window select the icon for the master card of the multi-card module then select Calibration.

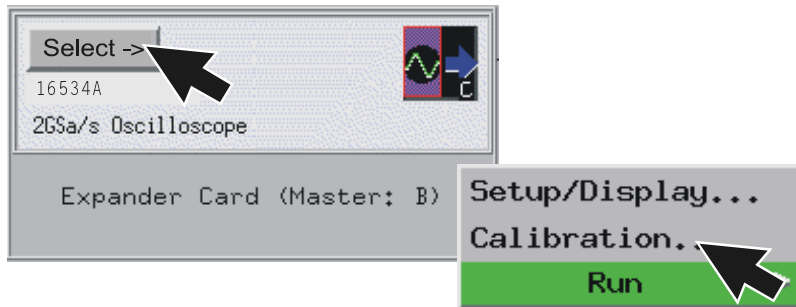

- 4** Perform channel skew calibration on the multi-card module.
  - a** Connect two 9-inch 50-ohm BNC cables and a BNC tee adapter between channel 1, AC/DC cal, of the first card and channel 1 of the second card.

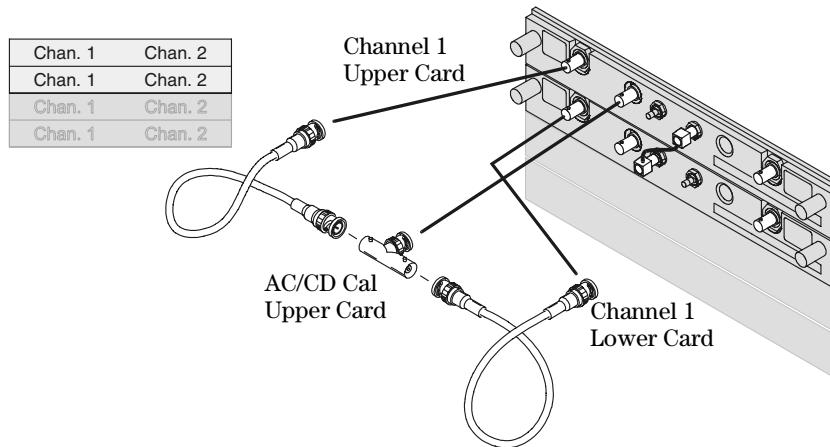

- b Select the Procedure field and then select Ext Trig Skew.

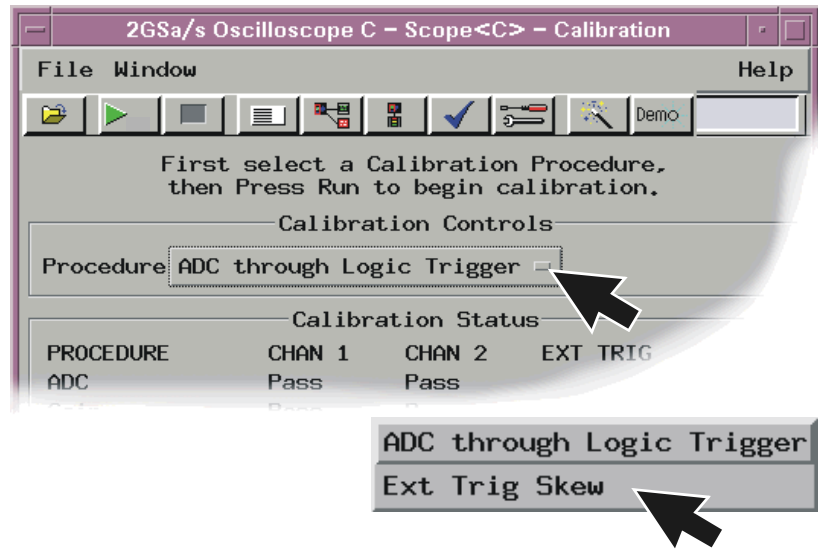

- c Select Run and the instrument will remind you to connect the cables. Select OK and the Calibration window opens.

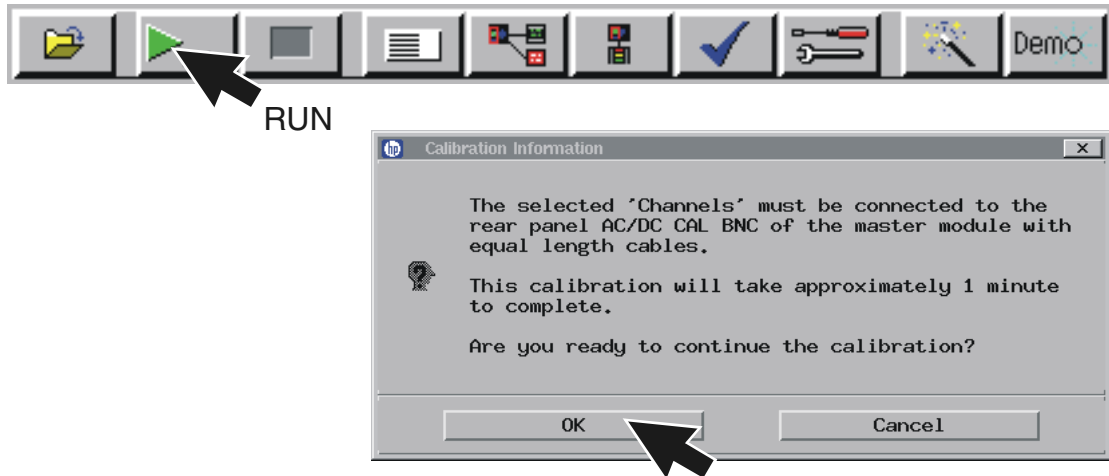

Chapter 4: Installing Oscilloscope Measurement Modules  
**16533/34A Oscilloscope Module (single or multi-card modules)**

- d Select the Channels field, select two channels to deskew, select Run, and follow the instructions on the display.

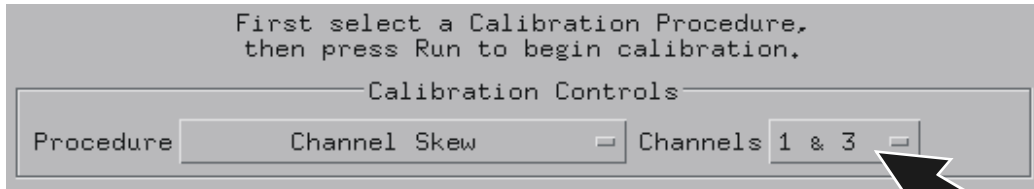

RUN

- e Repeat the channel skew procedure until all channel combinations have been deskewed.

Calibration Status					
PROCEDURE	CHAN 1	CHAN 2	CHAN 3	CHAN 4	EXT TRIG
ADC	Pass	Pass	Pass	Pass	
Gain	Pass	Pass	Pass	Pass	
Offset	Pass	Pass	Pass	Pass	
Hysteresis	Pass	Pass	Pass	Pass	
Trigger Level	Pass	Pass	Pass	Pass	
Trigger Delay	Pass	Pass	Pass	Pass	
Logic Trigger	Pass	Pass	Pass	Pass	
Channel Skew			Default	Default	
Ext Trig Skew					Default

- 5 Remove the BNC cables from the instrument.
- 6 Select Close in the Calibration window.

- 7 In the Logic Analysis System window select File, then select Exit and OK to close the session.

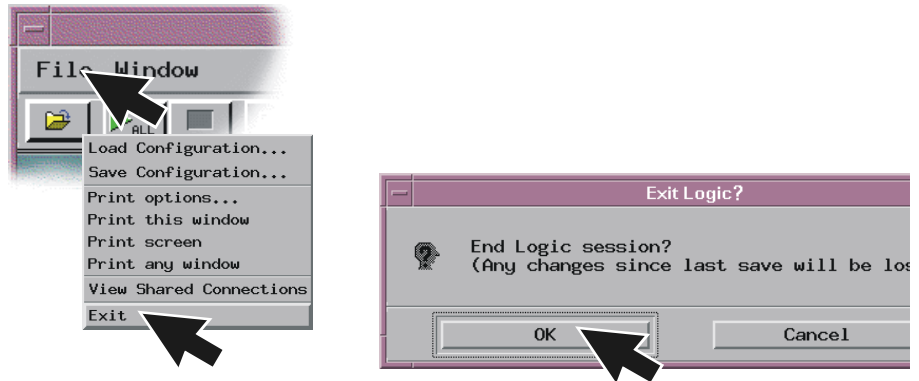

- 8 In the Session Manager window select Shutdown.

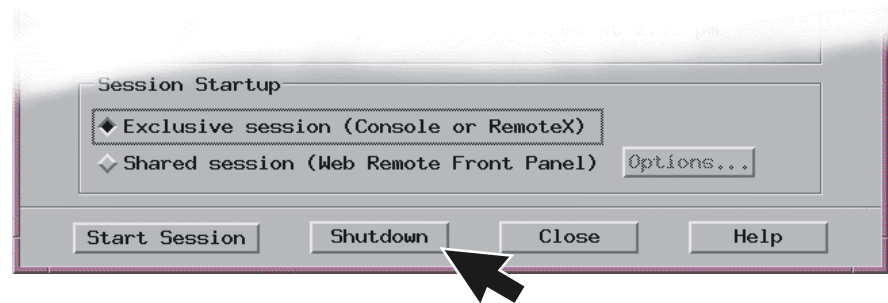

- 9 When the "OK to powerdown" message appears, turn off the power switch.
- 10 Set the PROTECTED/UNPROTECTED switch back to PROTECTED.

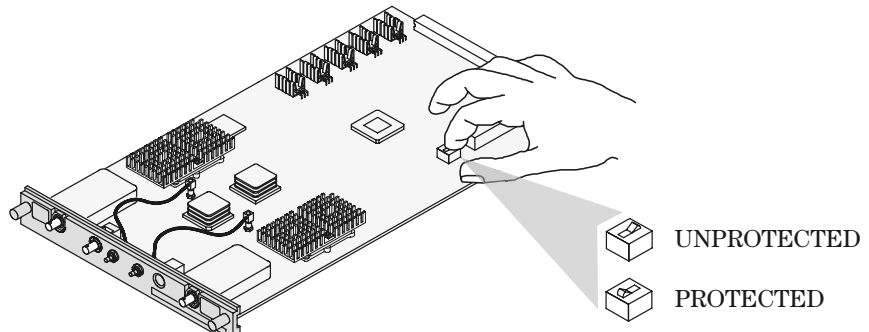



---

## Installing Pattern Generator Measurement Modules

---

## Software Requirements

The following table gives you the software version required in your 16700A/B or 16702A/B mainframe for use with pattern generator measurement modules. For software installation instructions go to page page 34.

Model Number	Software Version
16522A	All versions
16720A	A.02.00.00 or higher

---

## 16522A Pattern Generator (1-card module)

Each 16522A shipped stand-alone has the 2 x 10 cable connected in the single-card module configuration. A single-card module can be installed in any available slot.

---

**NOTE:**

Turn off the mainframe power before removing, replacing, or installing modules following the procedures on page 42.

---

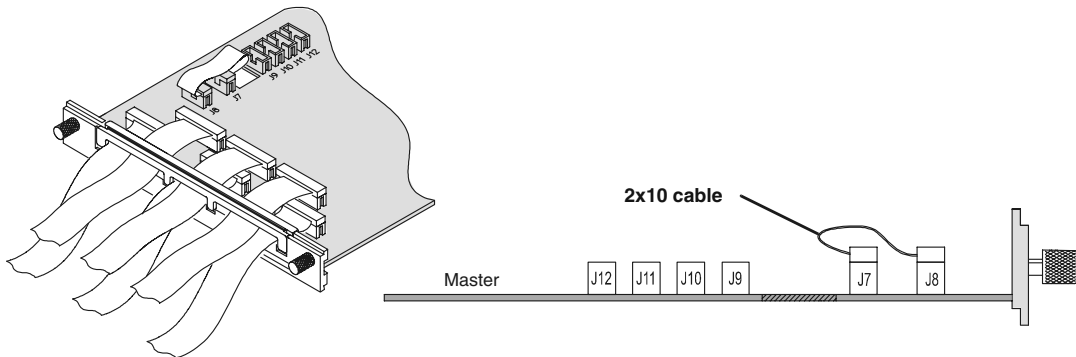



---

## 16522A Pattern Generator (2-card module)

Use two 2 x 10 cables to connect the modules as shown.

---

**NOTE:**

Turn off the mainframe power before removing, replacing, or installing modules following the procedures on page 42.

---

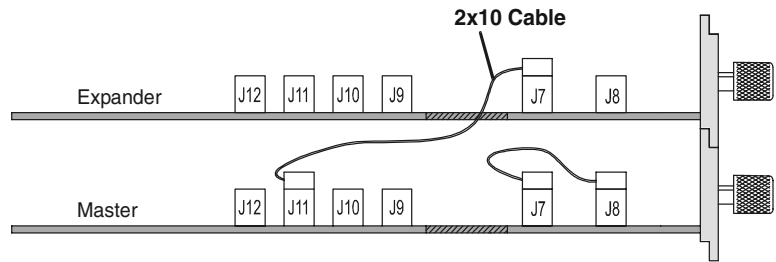
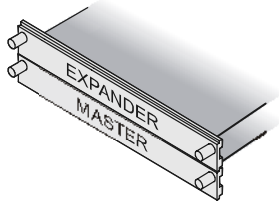

---

## 16522A Pattern Generator (3-card module)

Use three 2 x 10 cables to connect the modules.

---

**NOTE:**

Turn off the mainframe power before removing, replacing, or installing modules following the procedures on page 42.

---

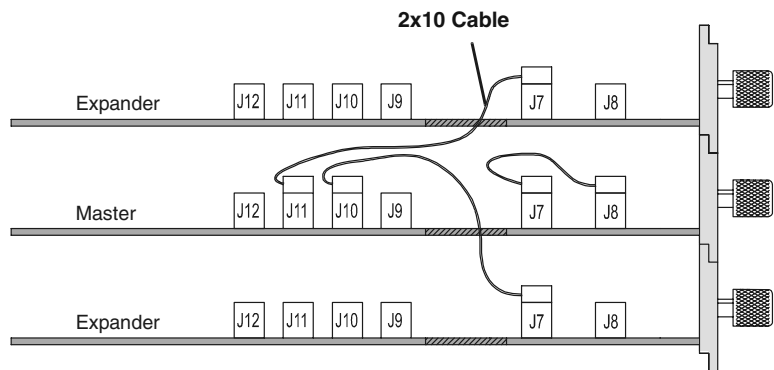
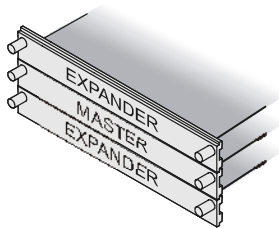

---

## 16522A Pattern Generator (4-card module)

---

**NOTE:**

Turn off the mainframe power before removing, replacing, or installing modules following the procedures on page 42.

---

- 1 Carefully slide the 4 cards half way into the mainframe slots.
- 2 Use four 2 x 10 cables to connect the modules. Cable the bottom Expander Card to the Master Card first. Then cable the upper two Expander Cards to the Master Card.

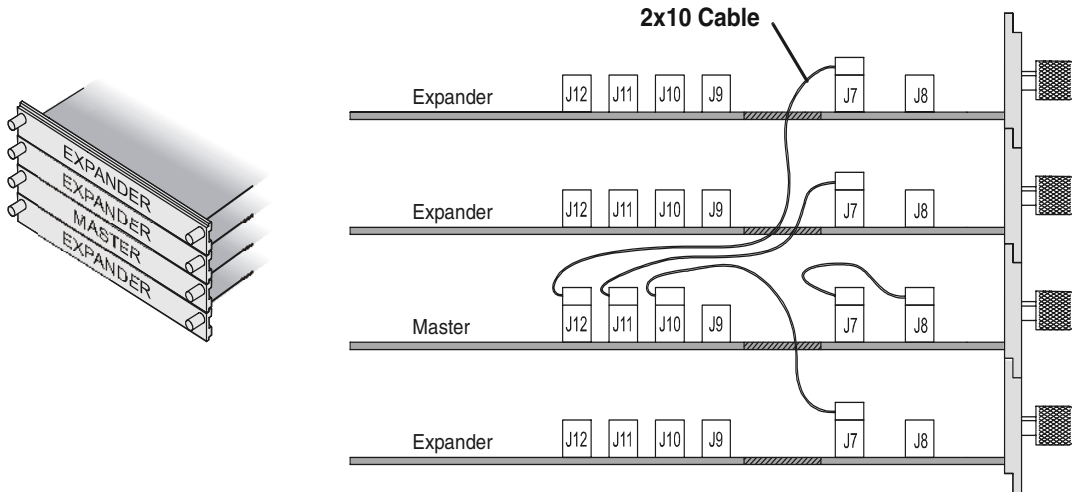

- 3 Gently slide the cabled assembly fully into the frame and tighten the thumb screws.

---

## 16522A Pattern Generator (5-card module)

---

**NOTE:**

Turn off the mainframe power before removing, replacing, or installing modules following the procedures on page 42.

- 1 Carefully slide the 4 cards half way into the mainframe slots.
- 2 Use five 2 x 10 cables to connect the modules. Cable the bottom Expander Card to the Master Card first. Then cable the upper two Expander Cards to the Master Card.

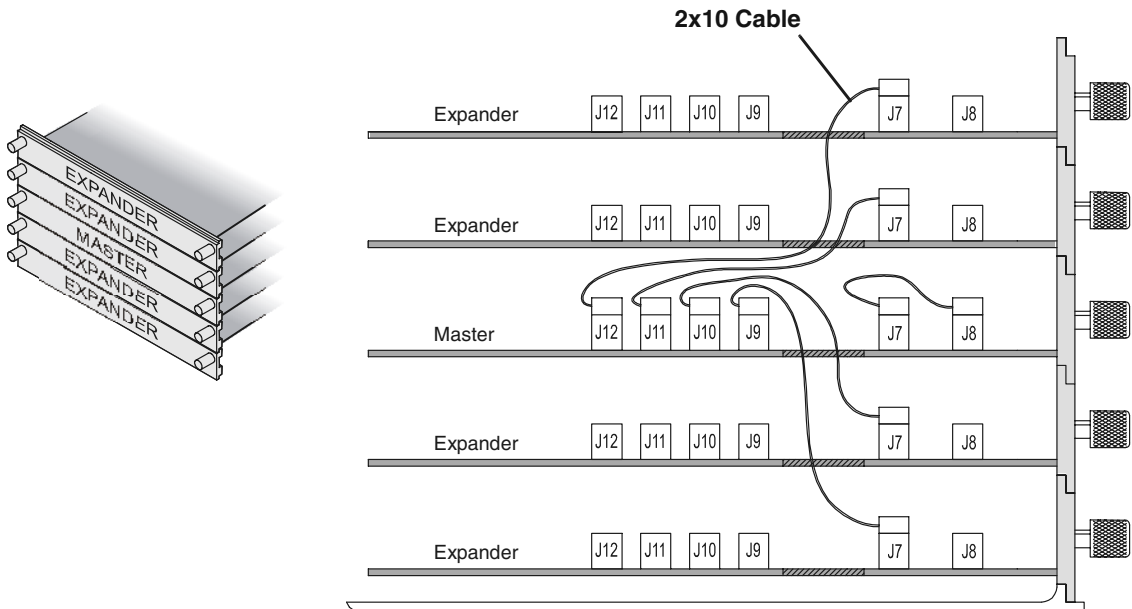

- 3 Gently slide the cabled assembly fully into the frame and tighten the thumb screws.

---

## 16720A Pattern Generator (1-card module)

Each card shipped stand-alone has the 2 x 10 cable connected in the single-card module configuration. A single-card module can be installed in any available slot.

---

**NOTE:**

Turn off the mainframe power before removing, replacing, or installing modules following the procedures on page 42.

---

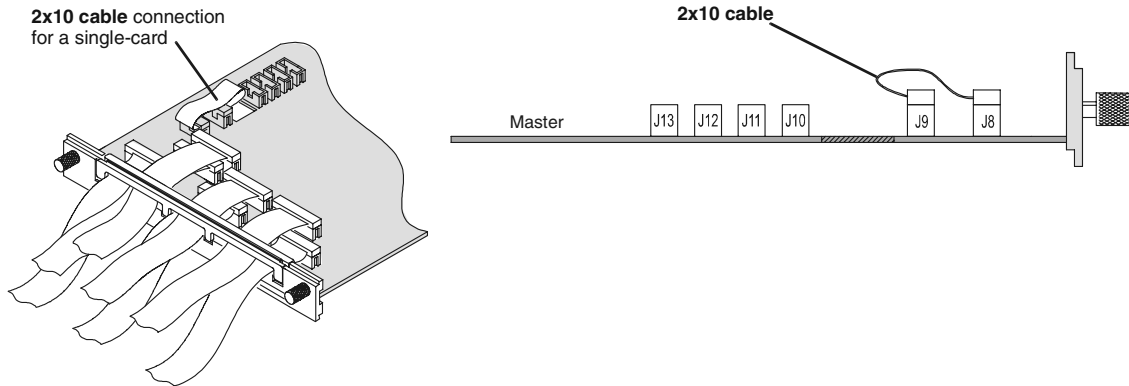

---

## 16720A Pattern Generator (2-card module)

Use two 2 x 10 cables to connect the modules.

---

**NOTE:**

Turn off the mainframe power before removing, replacing, or installing modules following the procedures on page 42.

---

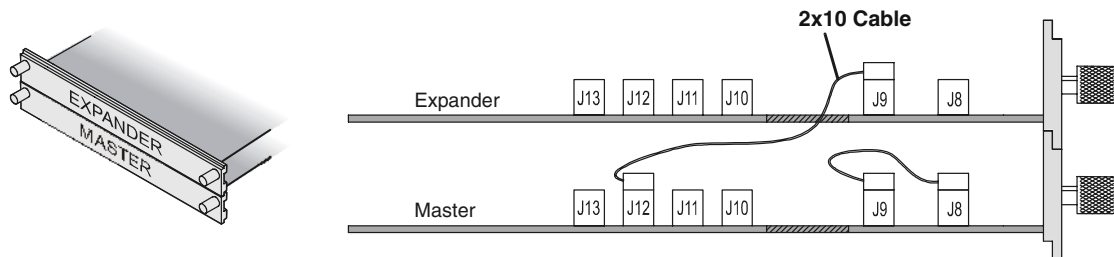

---

## 16720A Pattern Generator (3-card module)

Use three 2 x 10 cables to connect the modules.

---

**NOTE:**

Turn off the mainframe power before removing, replacing, or installing modules following the procedures on page 42.

---

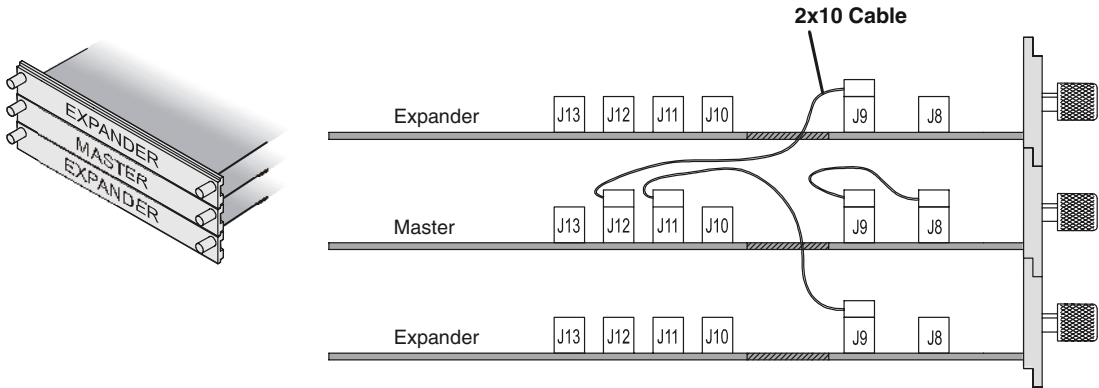

---

## 16720A Pattern Generator (4-card module)

---

**NOTE:**

Turn off the mainframe power before removing, replacing, or installing modules following the procedures on page 42.

---

- 1 Carefully slide the 4 cards half way into the mainframe slots.
- 2 Use four 2 x 10 cables to connect the modules. Cable the bottom Expander Card to the Master Card first. Then cable the upper two Expander Cards to the Master Card.

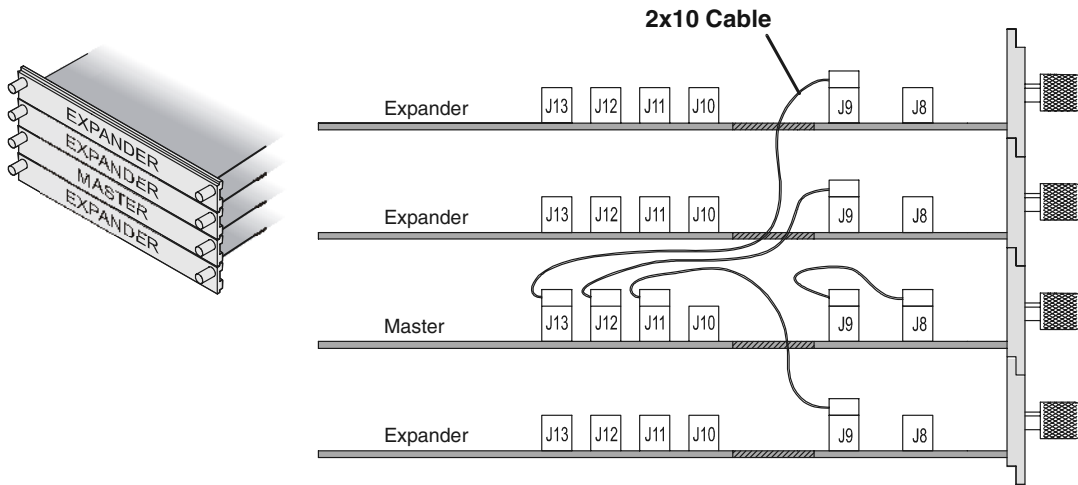

- 3 Gently slide the cabled assembly fully into the frame and tighten the thumb screws.

---

## 16720A Pattern Generator (5-card module)

---

**NOTE:**

Turn off the mainframe power before removing, replacing, or installing modules following the procedures on page 42.

- 1 Carefully slide the 4 cards half way into the mainframe slots.
- 2 Use six 2 x 10 cables to connect the modules. Cable the bottom two Expander Cards to the Master Card first. Then cable the upper two Expanders to the Master Card.

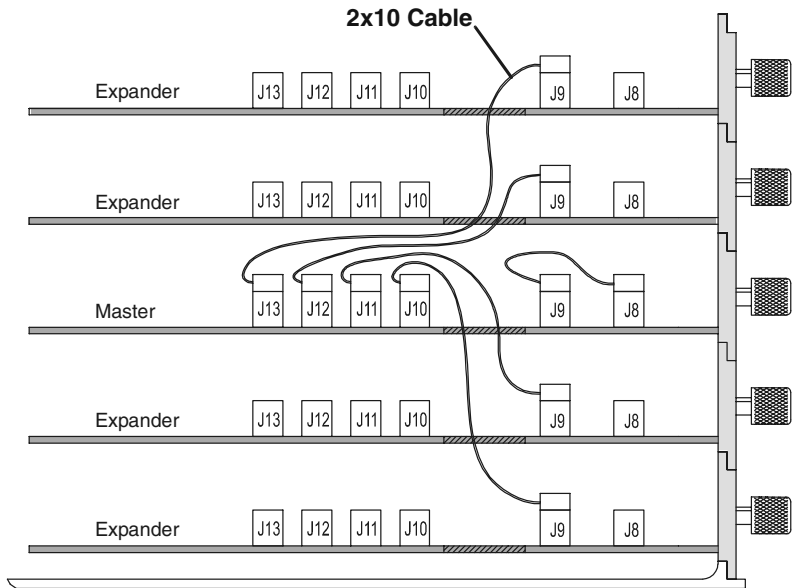
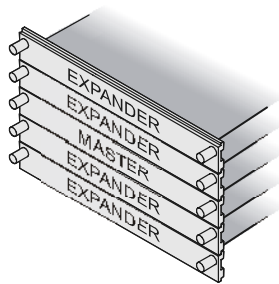

- 3 Gently slide the cabled assembly fully into the frame and tighten the thumb screws.





---

**Connecting Accessories**

## For More Information

The following sections give you an overview of Agilent Technologies probes and time correlation fixture.

More information on probing options can be found in a document titled *Probing Solutions for Logic Analysis Systems* which you can download from [www.agilent.com](http://www.agilent.com). In the search box type 'Probing Solutions for Logic Analysis Systems' and select go. Scroll down to Datasheets, Demonstrations, & Catalogs to find the document.

Detailed information on specific probes or the time correlation fixture can be found in the documentation that comes with the product. Product documentation can also be downloaded from <http://www.tm.agilent.com/classes/ProdSearch>. Type in the model number or product name and select go. Scroll down to Manuals, Guides & Service Notes to find these documents.

## General-purpose probing

**NOTE:**

For all Agilent logic analyzers except 16517A, 16518A, 16760A, and 16753/54/55/56A.

General-purpose probing requires connecting probe leads to individual signal lines. It is generally the most cumbersome method but it is also the most flexible. There are no active circuits at the outer end of the cable due to the passive design of the probe.

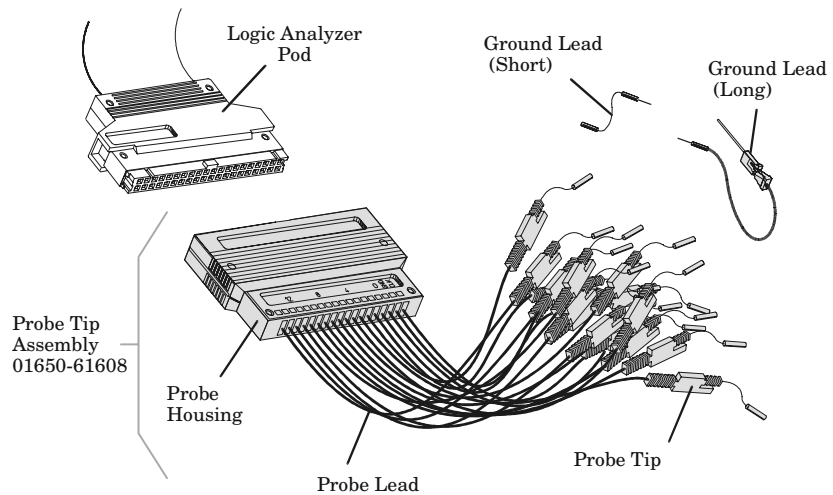

The advantages of general-purpose probing are:

- High-input impedance as shown in the equivalent load model below.
- Signal ground at the probe tip for high-speed signals.
- Inexpensive, removable probe tip assemblies.

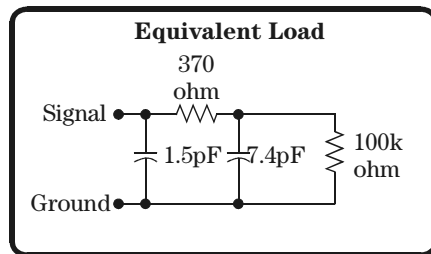

Includes logic analyzer

### General-purpose probing

**Connecting probe leads to the target.** The signal and ground leads can be connected directly to the target system. This requires installing 0.63 mm (0.025 inch) square pins, or round pins with a diameter between 0.66 and 0.84 mm (0.026 and 0.033 inch) directly on the board. You can also use an IC test clip with pins with those dimensions.

You can also connect the leads using through-hole grabbers that have small enough hooks to fit around adjacent IC pins, or by using surface-mount grabbers designed for fine surface-mount component leads.

**Grounding.** Proper grounding will improve the signal quality and is essential for high speed measurements. Each pod has a pod ground lead, which must be used. If you use this ground only, signal quality for high speed signals will be poor.

For better results, ground not only the pod, but every third or fourth lead.

For best results, and when probing signals with rise and fall times of 1 ns or less, ground each probe lead with no more than a 2-inch ground lead as well as grounding the pod with the pod ground lead.

**Replacing damaged leads.** You can replace damaged leads. Disconnect individual probe leads by pushing on the latch at the lead base with a ball-point pen.

**Connecting grabbers to the leads.** Connect grabbers to the leads by slipping the end of the lead over the recessed pin located in the side of the grabber.

**Isolation adapter (Part number 01650-63203)**

**NOTE:**

For all Agilent logic analyzers except 16517A, 16518A, 16760A, and 16753/54/55/56A.

The logic analyzer cable must have the proper RC network at its input in order to acquire data correctly. The optional Isolation Adapter incorporates the RC network into a convenient package. It also reduces the number of pins required for the header on the target board from 40 pins to 20.

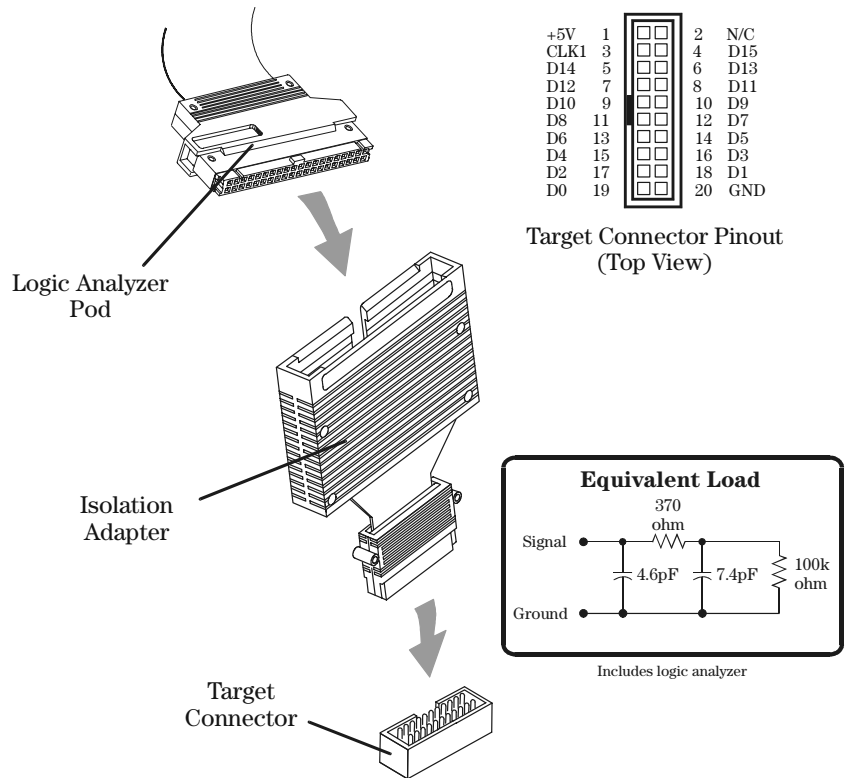

**Direct connection**

**Direct connection**

**NOTE:**

For all Agilent logic analyzers except 16517A, 16518A, 16760A, and 16753/54/55/56A.

You can connect the logic analyzer cable directly to a 40-pin connector, but you must install the proper isolation network directly onto the target system board.

**CAUTION:**



If drawing current from the 5V supply, do not exceed 0.33 amps per cable. The cable ground lines are chassis (earth) grounds and not "floating" grounds. All the lines are woven into a flat ribbon that is 137.16 cm (4.5 feet) long.

**NOTE:**

Agilent Technologies recommends two types of RC networks. They are described in detail in *Probing Solutions for Agilent Logic Analysis Systems*. Go to <http://www.tm.agilent.com/classes/ProdSearch> to download this application note. Type in the title, select go, and the document will be listed under the section Application Notes & Technical Papers.

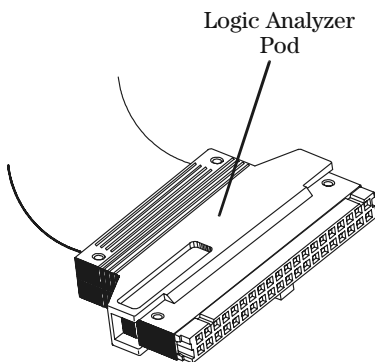

+5V	1	○ ○	2	Power GND
CLK1	3	○ ○	4	Signal GND
N/C	5	○ ○	6	Signal GND
D15	7	○ ○	8	Signal GND
D14	9	○ ○	10	Signal GND
D13	11	○ ○	12	Signal GND
D12	13	○ ○	14	Signal GND
D11	15	○ ○	16	Signal GND
D10	17	○ ○	18	Signal GND
D9	19	○ ○	20	Signal GND
D8	21	○ ○	22	Signal GND
D7	23	○ ○	24	Signal GND
D6	25	○ ○	26	Signal GND
D5	27	○ ○	28	Signal GND
D4	29	○ ○	30	Signal GND
D3	31	○ ○	32	Signal GND
D2	33	○ ○	34	Signal GND
D1	35	○ ○	36	Signal GND
D0	37	○ ○	38	Signal GND
+5V	39	○ ○	40	Power GND

Target Connector Pinout  
(Top View)

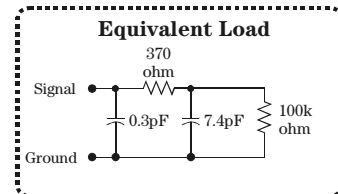
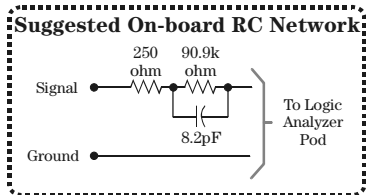

Includes on-board isolation network and logic analyzer

## 38-pin Low-voltage Probe (E5339A with tip isolation network)

**NOTE:**

For all Agilent logic analyzers except 16517A, 16518A, 16760A, and 16753/54/55/56A.

The 38-pin low-voltage probe provides a convenient way to connect two Agilent Technologies logic analyzer probe cables to a small area of a target system. The Agilent E5339A probe has isolation networks in the cable end that connects to the high-density AMP MICTOR (Matched Impedance ConnectoR) connector. It is designed to be compatible with low-amplitude digital signals, down to 250 mV p-p.

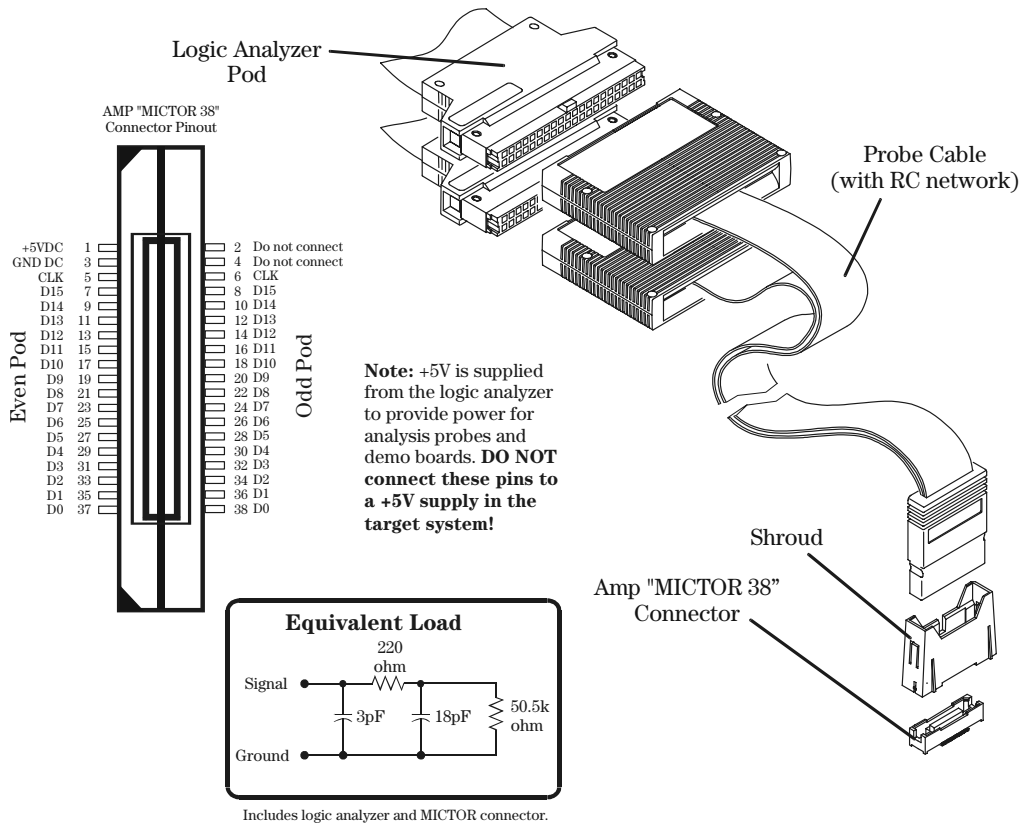

### 38-pin Single-ended Probe (E5346A for analyzers with 40-pin pod connectors)

**NOTE:**

For all Agilent logic analyzers except 16517A, 16518A, 16760A, and 16753/54/55/56A.

The 38-pin probe provides a convenient way to connect two Agilent Technologies logic analyzer probe cables to a small area of a target system. The Agilent Technologies E5346A probe has isolation networks in the cable end that connects to the 38-pin AMP MICTOR (*Matched Impedance ConnecTOR*) connector.

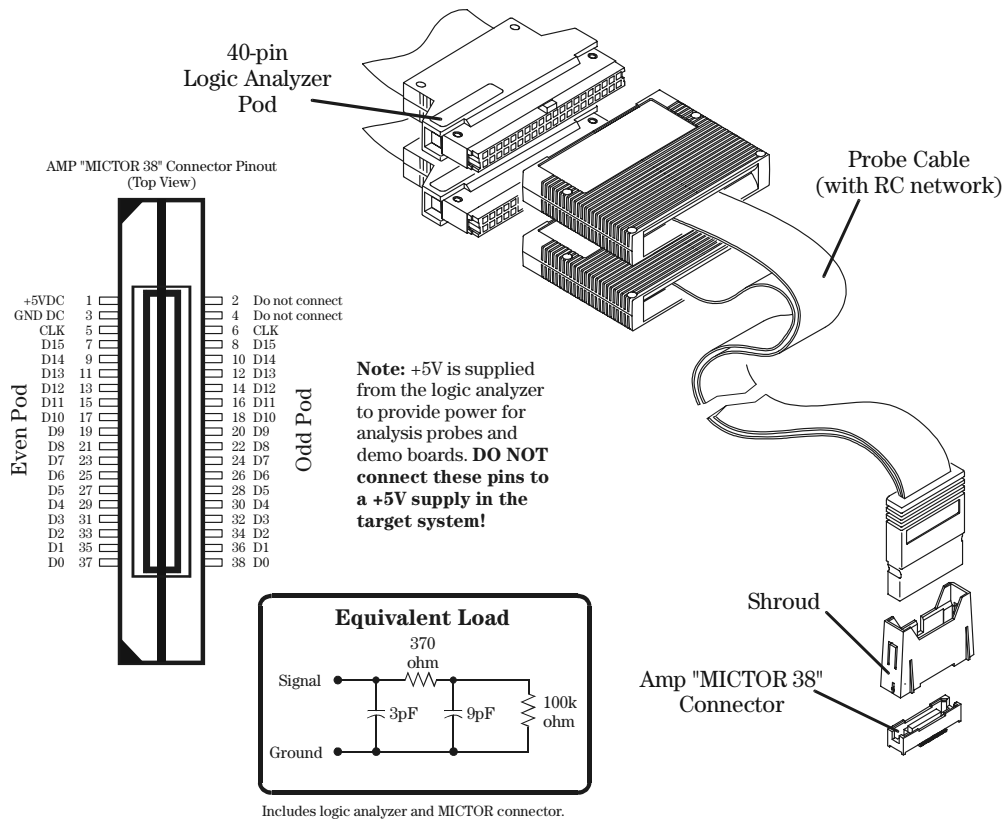



## 38-pin Adapter Cable (E5351A no tip network)

**NOTE:**

For all Agilent logic analyzers except 16517A, 16518A, 16760A, and 16753/54/55/56A.

The 38-pin adapter cable provides a convenient way to connect two Agilent Technologies logic analyzer probe cables to a small area of a target system. The Agilent Technologies E5351A adapter cable does not have isolation networks, so isolation networks must be provided on the target system.

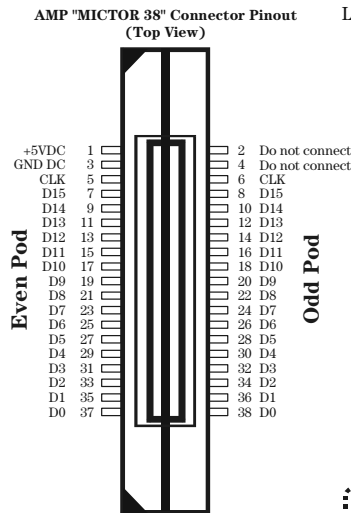

**Note:** +5V is supplied from the logic analyzer to provide power for analysis probes and demo boards. **DO NOT connect these pins to a +5V supply in the target system!**

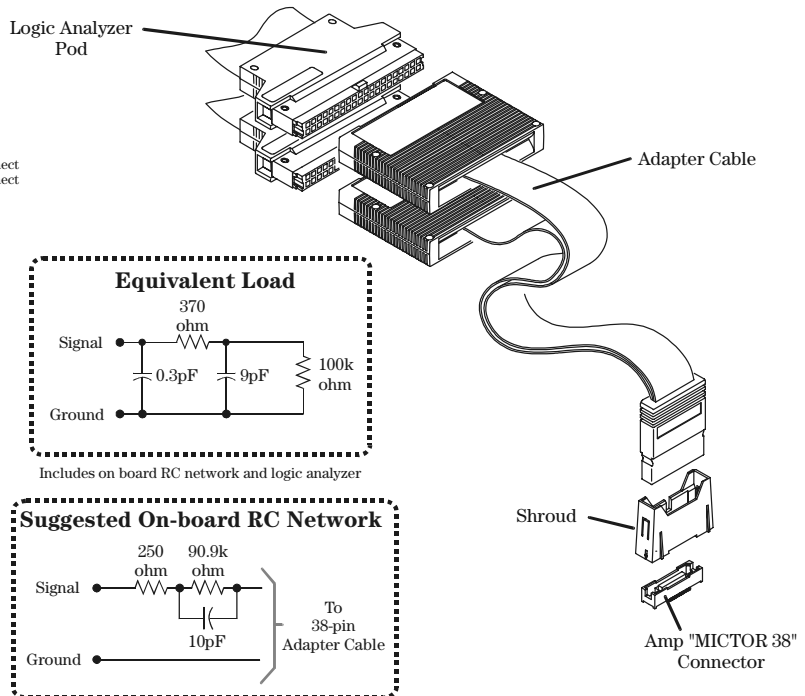

**NOTE:**

Agilent Technologies recommends two types of RC networks. They are described in detail in *Probing Solutions for Agilent Logic Analysis Systems*. Go to <http://www.tm.agilent.com/classes/ProdSearch> to download this application note. Type in the title, select go, and the document will be listed under the section Application Notes & Technical Papers.

**100-pin Single-ended Probe (E5378A for analyzers with 90-pin pod connectors)**

**100-pin Single-ended Probe (E5378A for analyzers with 90-pin pod connectors)**

**NOTE:**

For use with Agilent logic analyzer modules 16760A, 16753A, 16754A, 16755A, and 16756A.

The Agilent E5378A is a 34-channel, single-ended, 100-pin probe capable of capturing data up to the rated maximum state (synchronous) analysis clock rates of all the supported analyzers, with signal amplitudes as small as 250 mV peak-to-peak. One E5378A probe is required for a 16760A module and two are required to support all the inputs on a 16753/54/55/56A module. A 100-pin connector must be installed on you target system board.

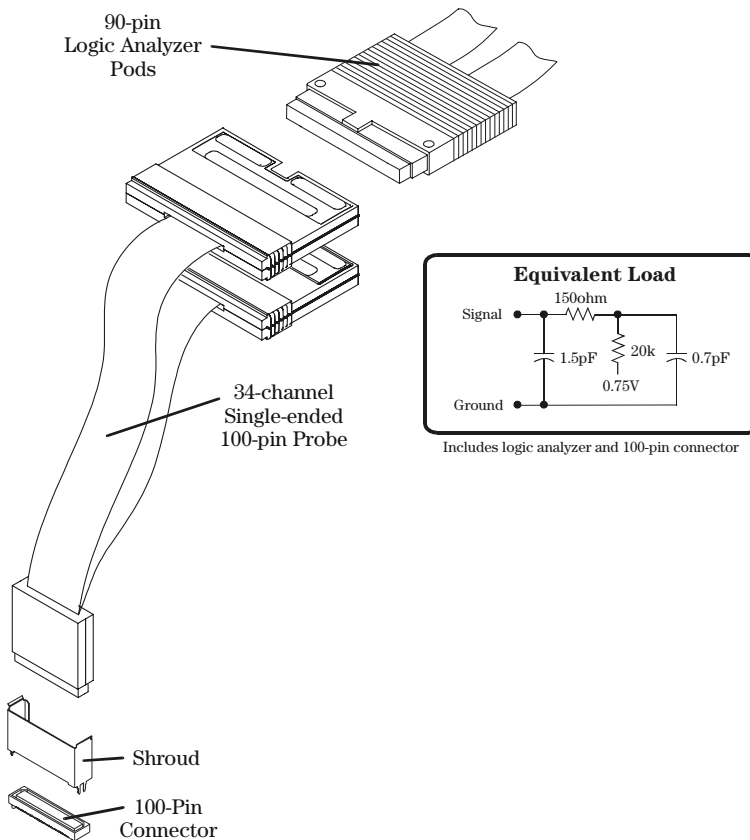

**100-pin Differential Probe (E5379A for analyzers with 90-pin pod connectors)****100-pin Differential Probe (E5379A for analyzers with 90-pin pod connectors)****NOTE:**

For use with Agilent logic analyzer modules 16760A, 16753A, 16754A, 16755A, and 16756A.

The Agilent E5379A is a 17-channel, 100-pin differential probe capable of capturing data up to the rated maximum state (synchronous) analysis clock rates of all the supported analyzers, with differential signal amplitudes as small as 200 mV peak-to-peak (100 mV peak-to-peak on both positive and negative inputs). Two E5379A probes are required to support all the inputs on one 16760A. Four are required for one 16753/54/55/56A module. A 100-pin connector must be installed on your target system board.

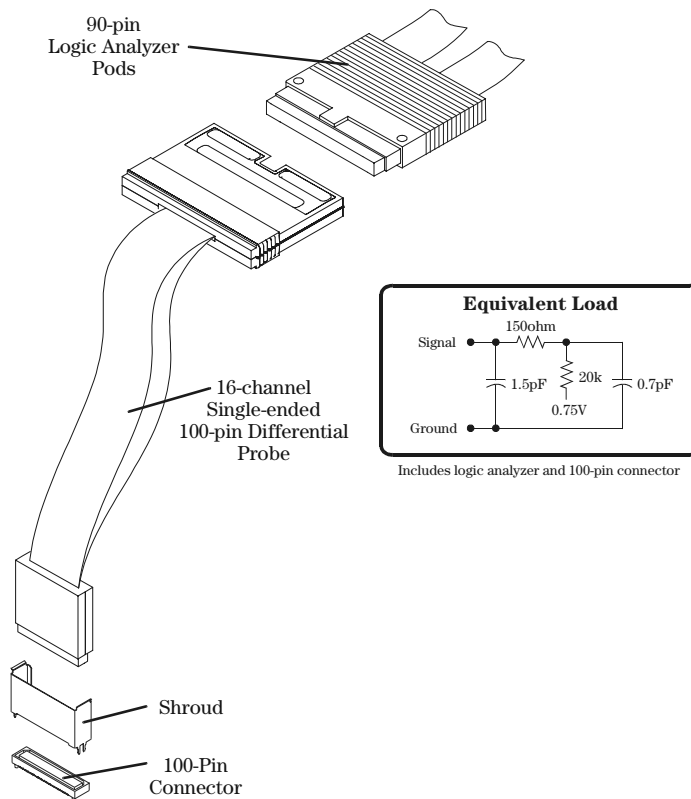

**38-pin Single-ended Probe (E5380A for analyzers with 90-pin pod connectors)**

**38-pin Single-ended Probe (E5380A for analyzers with 90-pin pod connectors)**

**NOTE:**

For use with Agilent logic analyzer modules 16760A, 16753A, 16754A, 16755A, and 16756A.

The E5380A is a 34-channel, single ended, 38-pin probe designed to be compatible with the AMP MICTOR 38-pin connector. It is pin-compatible with target systems that were designed for the Agilent E5346A 38-pin probe, thus enabling you to use Agilent's latest logic analyzers with target systems that were designed for older Agilent logic analyzers. The E5380A is capable of capturing state (synchronous) data at clock speeds up to 600 MHz, at data rates up to 600Mb/s, with with signal amplitudes as small as 300 mV peak-to-peak.

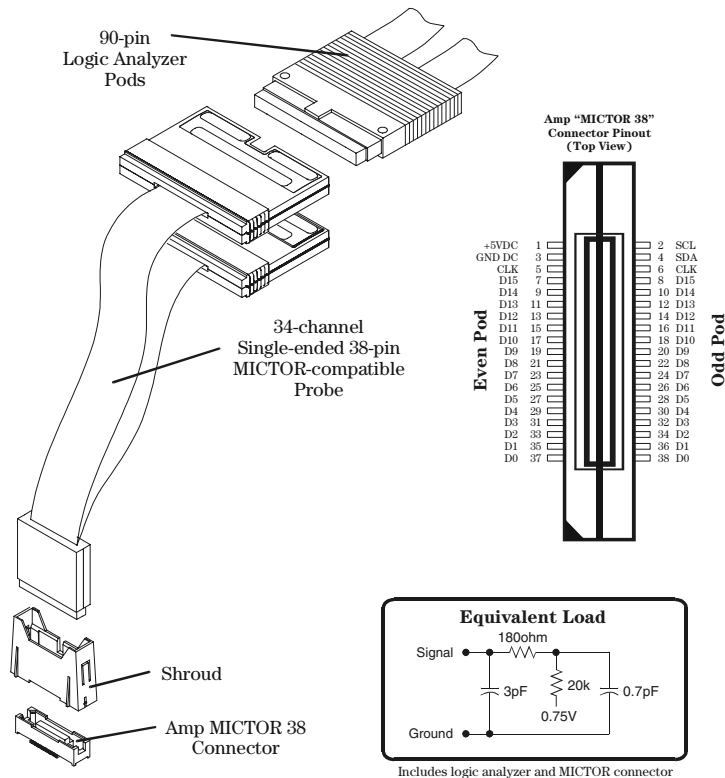

---

## Half-channel Adapter (E5386A)

---

**NOTE:**

For use with Agilent 16760A logic analyzers.

The E5386A Half-channel Adapter is intended to be used in half-channel state mode and works with:

- E5378A 100-pin Single-ended Probe
- E5379A 100-pin Differential Probe
- E5387A Differential Soft Touch Probe
- E5390A Single-ended Soft Touch Probe

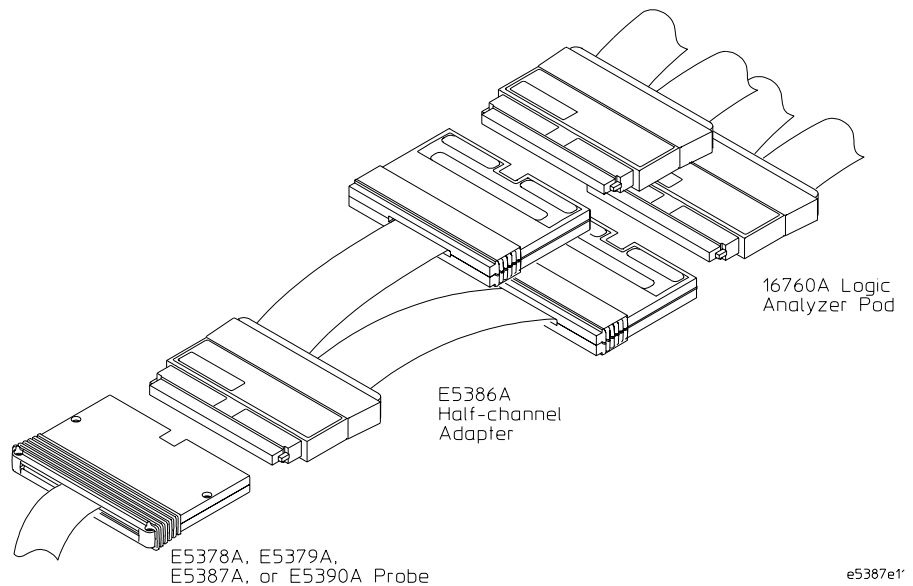

The E5386A Half-channel Adapter has its own ID code. When using the adapter, the logic analyzer recognizes its code rather than that of the probe which is attached to the target. Therefore, the user interface format menu doesn't automatically set thresholds to the right values. You need to go into the threshold menu and select (differential, custom, or standard settings).

---

## Single-ended Flying Lead Probe Set (E5382A)

---

**NOTE:**

For use with Agilent logic analyzer modules 16760A, 16753A, 16754A, 16755A, and 16756A.

---

The E5382A is a 17-channel single-ended flying lead probe set that enables you to acquire signals from randomly located points in your target system. Two E5382As are required to support all 34 channels in one 16760A. Four are required to support all 68 channels on one 16753/54/55/56A module. A variety of accessories are supplied with the E5382A to allow you to access signals on various types of components on your PC board.

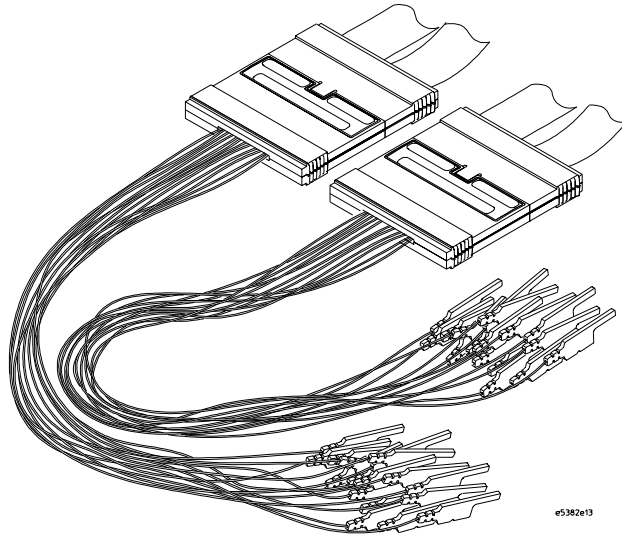

**Soft Touch Probes (E5387A and E5390A for analyzers with 90-pin pod connectors)****Soft Touch Probes (E5387A and E5390A for analyzers with 90-pin pod connectors)****NOTE:**

For use with Agilent logic analyzer modules 16760A, 16753A, 16754A, 16755A, and 16756A.

The new Agilent soft touch probes are ultra-low-load connector-less probes that attach to the PC board using a retention module which ensures pad-to-pad alignment and holds the probe in place. The E5387A is a 17-channel differential soft-touch probe and the E5390A is a 34-channel single-ended soft-touch probe. These probes will work with any future analyzers that use a 90-pin connector on the cable where the probe attaches to the logic analyzer.

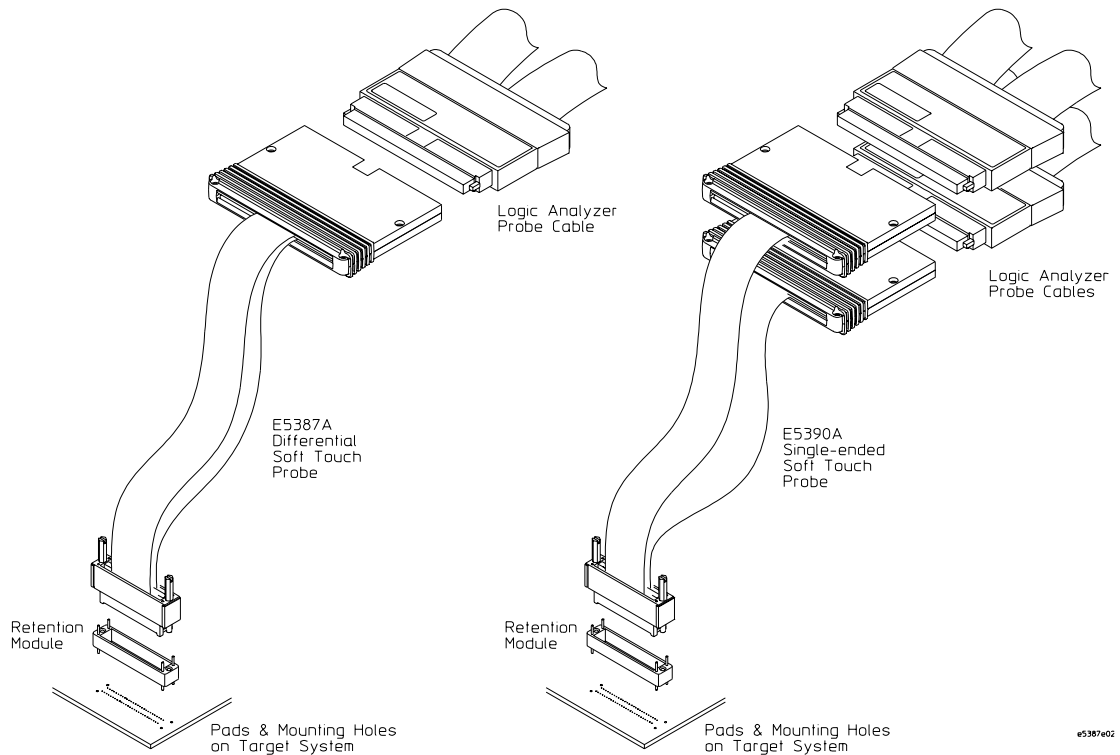

e5387a02

---

## Time Correlation Fixture (E5850A)

The Agilent E5850A time correlation fixture allows you to make time-correlated measurements between a 16700 logic analyzer and an Agilent 548XX series Infiniium oscilloscope. The instruments communicate with one another through a LAN connection and through the time correlation fixture. The instruments connect to your target system (device under test) through separate probes, just as when they are used independently. Waveforms acquired by the oscilloscope can be displayed on the logic analyzer.







## Troubleshooting

To run self-tests

To run self-tests

- 1 Select the Tools icon from the menu bar.

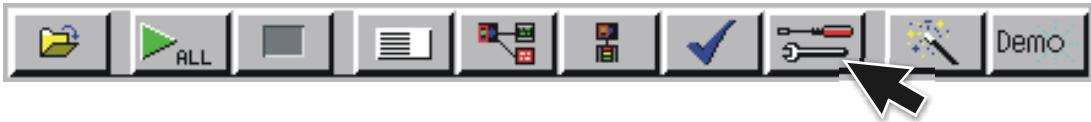

- 2 Select the Admin tab, select Self-Test, and read the text box before selecting Yes.

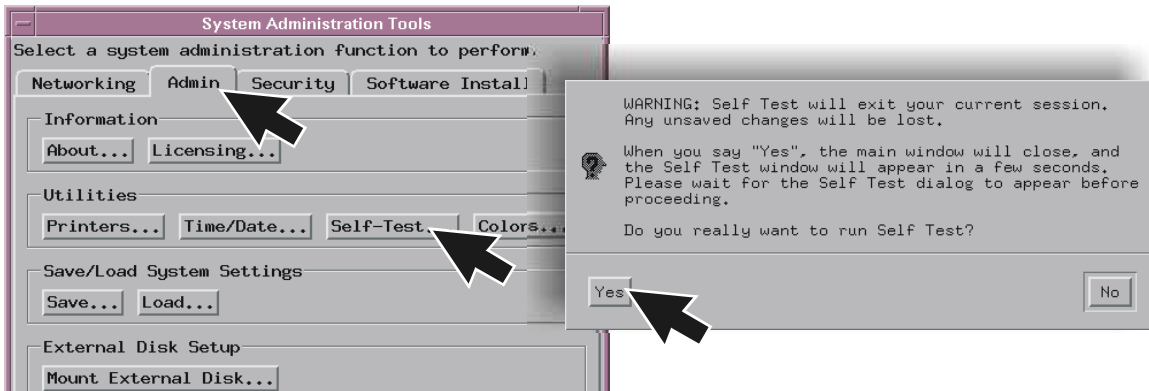

- 3 In the Self Test window select the System tab, select the Master or Expander Frame tab, and then select the module you want to test.

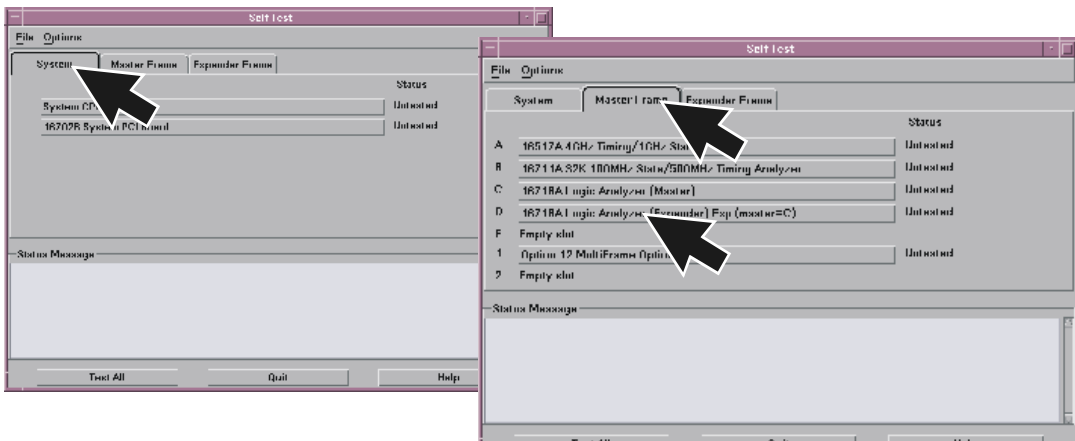

---

## To execute disaster recovery procedures

---

**CAUTION:**

Read this section carefully before you attempt to reinstall the operating system from the CD-ROM using this procedure. *Everything on the hard drive will be overwritten, including user configuration, data files, and license passwords. To save your system's license information, as well as other system settings, refer to page 13. To reload, refer to page 15.*

A batch process is used to autoload the software and then reboot the instrument. The batch process waits for only a short time-out period for user interaction to abort the process. Otherwise, the hard drive will be initialized, the operating system will be uploaded, and the instrument will reboot.

The reinstallation process takes approximately one hour depending on the speed of the attached CD-ROM.

- 1 If you have a 16702B, you will need to connect a keyboard to your system in order to execute these procedures.
- 2 If required, follow the steps on page 13 to create a backup file of your system settings and license passwords.
- 3 Insert the CD-ROM containing the instrument operating software into the CD-ROM drive. Allow a couple of moments for the media to settle after inserting the media.
- 4 If the LAN cable is connected, disconnect it from the instrument.
- 5 If needed, turn on the system and initiate the monitor selection mode. Follow the instructions beginning with step one on page 19 if you have a 16700B or page 21 if you have a 16702B. Otherwise, proceed to the next step.
- 6 Turn on the instrument and repeatedly press the [ESC] key on the keyboard to terminate the boot process. When the boot process is terminated, a prompt will be displayed.

Main Menu: Enter command >

**a** Press: <Enter>

**b** Type: SEA <Enter>

The instrument will search for all viable boot devices on the bus, including the

## Chapter 7: Troubleshooting

### To execute disaster recovery procedures

CD-ROM drive. The display will then show the boot devices:

Path Number	Device Path	Device Type
P0	SESCSI.6.0	IBM DNES-309170W
P1	SESCSI.1.0	PLEXTOR CD-ROM PX-40TS

**7** At the prompt:

```
Main Menu: Enter command >
```

```
Type: BO P1 <Enter>
```

**8** At the prompt:

```
Interact with IPL (Y, N, Q) ?>
```

```
Type: N <Enter>
```

**9** After about 30 seconds you will see the message:

```
WARNING: The configuration information calls for a non-  
interactive installation.  
Press <Return> within 10 seconds to cancel batch mode  
installation:
```

**10** To abort the reinstallation process at this point:

Press the [Return] key on the keyboard within 10 seconds. (If you do nothing within the 10 second time-out, the reinstallation process will begin. The instrument will completely reload the operating system software onto the hard disk drive.)

**11** Processor Support Packages, Auxiliary Software, and user files must be installed manually once the operating system has been reinstalled.

**12** Follow the steps on page 15 to reload system settings and license passwords.

## Numerics

16517/18A logic analyzer module, 47, 48, 49, 50  
16522A pattern generator module, 88, 89, 90, 91  
16533/34A oscilloscope module, 72 (calibration), 72 (multicard), 81 (operational accuracy), 75  
16557D logic analyzer module, 50, 51, 52, 53, 54  
16701B expander frame, 37  
16710/11/12A logic analyzer module, 55, 56  
16715/16/17A logic analyzer module, 57, 58, 59, 60, 61  
16718/19A logic analyzer module, 57, 58, 59, 60, 61  
16720A pattern generator module, 92, 93, 94, 95  
16740/41/42A logic analyzer module, 57, 58, 59, 60, 61  
16750/51/52A logic analyzer module, 57, 58, 59, 60, 61  
16753/54/55A logic analyzer module, 62, 63, 64, 65, 66  
16760A logic analyzer module, 67, 68, 69, 70  
34-channel single-ended probe, 106  
38-pin adapter cable, E5351A, 105  
38-pin probe, E5346A, 104

## B

backup system settings, 13  
boot drive, removable, 31  
  disconnecting, 34

## C

calibration, 16533/34A, 75  
characteristics, 11  
cleaning the instrument, 149

configuring  
  monitor for 16700B, 19  
  monitor for 16702B, 21  
connecting  
  16701B expander frame, 37  
  external data drive, 26  
  keyboard, 18  
  LAN, 22  
  logic analyzer probe directly to target, 102  
  monitor, 18  
  mouse, 18  
  multiple frames, 38  
  option 008, 26  
  option 009, 31  
  printer, 24  
  removable boot drive, 31

## D

data drive, 26  
differential probe, 107, 111  
direct connection probing, 102  
disaster recovery, 115  
disconnecting  
  external data drive, 30  
  option 008, 30  
  option 009, 34  
  removable boot drive, 34

## E

E5339A 38-pin low-voltage probe, 103  
E5351A 38-pin adapter cable, 105  
E5379A 100-pin differential probe, 107  
E5382A single-ended flying lead probe set, 110  
E5386A half-channel adapter, 109  
E5850A time correlation fixture, 112  
expander frame, 37  
external data drive

connecting, 26  
disconnecting, 30

## F

flying lead  
  general-purpose, 99  
  single-ended, 110  
frames  
  expander, 37  
  multiple, 38

## G

general-purpose probing, 99

## H

half-channel adapter, 109

## I

installation  
  disaster recovery, 115  
  measurement modules, 42  
  software, 34  
instrument, cleaning the, 149  
isolation adapter probing, 101

## K

keyboard, 18

## L

LAN, 22  
license passwords, 13, 15  
logic analyzer modules  
  16517/18A (2-card), 47  
  16517/18A (3-card), 48  
  16517/18A (4-card), 49  
  16517/18A (5-card), 50  
  16557D (1-card), 50  
  16557D (2-card), 51  
  16557D (3-card), 52  
  16557D (4-card), 53

16557D (5-card), 54  
16710/11/12A (1-card), 55  
16710/11/12A (2-card), 56  
16715/16/17A (1-card), 57  
16715/16/17A (2-card), 58  
16715/16/17A (3-card), 59  
16715/16/17A (4-card), 60  
16715/16/17A (5-card), 61  
16718/19A (1-card), 57  
16718/19A (2-card), 58  
16718/19A (3-card), 59  
16718/19A (4-card), 60  
16718/19A (5-card), 61  
16740/41/42A (1-card), 57  
16740/41/42A (2-card), 58  
16740/41/42A (3-card), 59  
16740/41/42A (4-card), 60, 61  
16750/51/52A (1-card), 57  
16750/51/52A (2-card), 58  
16750/51/52A (3-card), 59  
16750/51/52A (4-card), 60, 61  
16753/54/55A (1-card), 62  
16753/54/55A (2-card), 63  
16753/54/55A (3-card), 64  
16753/54/55A (4-card), 65, 66  
16760A (1-card), 67  
16760A (2-card), 67  
16760A (3-card), 68  
16760A (4-card), 69  
16760A (5-card), 70  
low-voltage probe, 38-pin, 103

## M

measurement modules  
installing, removing, or replacing, 42  
logic analyzer  
16517/18A, 47, 48, 49, 50  
16557D, 50, 51, 52, 53, 54  
16710/11/12A, 55, 56  
16715/16/17A, 57, 58, 59, 60, 61

167150/51/52A, 57, 58, 59  
16718/19A, 57, 58, 59, 60, 61  
16740/41/42A, 57, 58, 59, 60, 61  
16750/51/52A, 60, 61  
16753/54/55A, 62, 63, 64, 65, 66  
16760A, 67, 68, 69, 70  
oscilloscope  
16533/34A, 72, 81  
16533/34A (calibration), 72  
16533/34A (operational accuracy), 75  
pattern generator  
16522A, 88, 89, 90, 91  
16720A, 92, 93, 94, 95  
MICTOR, 38-pin, 103, 104  
monitor  
changing/configuring, 22  
configuring for 16700B, 19  
configuring for 16702B, 21  
connecting, 18  
mouse, 18  
multi-card modules, 42, 55, 56, 57, 58, 59, 60, 61, 63, 64, 65, 66  
multiple frames, 38

## O

operational accuracy calibration, 16533/34A, 75  
option 008, 26  
option 009, 31  
disconnecting, 34  
oscilloscope module  
16533/34A, 72  
calibration, 72  
multicard module, 81  
operational accuracy, 75

## P

passwords, 13, 15  
pattern generator modules  
16522A (1-card), 88  
16522A (2-card), 89  
16522A (3-card), 89  
16522A (4-card), 90  
16522A (5-card), 91  
16720A (1-card), 92  
16720A (2-card), 92  
16720A (3-card), 93  
16720A (4-card), 94  
16720A (5-card), 95  
printer, connecting, 24  
probe leads, 99  
probing  
100-pin differential probe, 107  
100-pin single-ended probe (16760A), 106  
38-pin adapter cable, 105  
38-pin low-voltage, 103  
38-pin probe, 104  
38-pin single-ended probe, 108  
direct connection, 102  
E5339A, 103  
E5346A 38-pin, 104  
E5351A, 105  
E5378A single-ended probe, 106  
E5379A, 107  
E5382A single-ended flying lead, 110  
E5386A half-channel adapter, 109  
E5387A differential soft touch, 111  
E5390A single-ended soft touch, 111  
general-purpose, 99  
half-channel adapter, 109  
isolation adapter, 101  
single-ended flying lead, 110  
single-ended probe, 38-pin, 108  
soft touch, 111

## **R**

- recovering, 115
- reinstallation, 115
- removable boot drive
  - connecting, 31
  - disconnecting, 34
- removing
  - measurement modules, 42
- replacing
  - measurement modules, 42
- restoring, 115
- run self-tests, 114

## **S**

- self-tests, 114
- single-ended probe, 106, 111
- soft touch probes, 111
- software
  - installation, 34
  - reinstalling, 115
- software requirements
  - logic analyzer modules, 46
  - pattern generator modules, 88
- specifications, 11
- system settings
  - backup, 13
  - reloading, 15

## **T**

- tests, self, 114
- time correlation, 112
- troubleshooting, 114

## **W**

- waveforms, 112







Agilent Technologies

# DECLARATION OF CONFORMITY

According to ISO/IEC Guide 22 and CEN/CENELEC EN 45014

**Manufacturer's Name:** Agilent Technologies, Inc.  
**Manufacturer's Address:** 1900 Garden of the Gods Road  
Colorado Springs, Colorado  
80907 U.S.A.

**Declares, that the product**

**Product Name:** Digitizing Oscilloscope Module  
**Model Number:** 16517A and 16518A  
**Product Options:** This declaration covers all options of the above product(s).

**Conforms with the following product standards:**

<b>EMC</b>	<b>Standard</b>	<b>Limit</b>
	CISPR 11:1990 / EN 55011:1991	Group 1, Class A
	IEC 555-2:1982 + A1:1985 / EN 60555-2:1987	
	IEC 555-3:1982 + A1:1990 / EN 60555-3:1987 + A1:1991	
	IEC 801-2:1991 / EN 50082-1:1992	4 kV CD, 8 kV AD
	IEC 801-3:1984 / EN 50082-1:1992	3 V/m, {1kHz 80% AM, 27-1000 MHz}
	IEC 801-4:1988 / EN 50082-1:1992	0.5 kV Sig. Lines, 1 kV Power Lines

**Safety** IEC 1010-1:1990+A1 / EN 61010-1:1993  
UL 3111  
CSA-C22.2 No. 1010.1:1993

**Additional Information:**

The product herewith complies with the requirements of the Low Voltage Directive 73/23/EEC and the EMC Directive 89/336/EEC (including 93/68/EEC) and carries the CE-marking accordingly (European Union).

The product was tested in a typical configuration with Agilent Technologies test systems.

Date: 10/03/96

  
John Strathman / Quality Manager

For further information, please contact your local Agilent Technologies sales office, agent or distributor.

---

## Product Regulations

---

<b>EMC</b>	This Product meets the requirements of the European Communities (EC) EMC Directive 89/336/EEC.	
<b>Emissions</b>	EN55011/CISPR 11 (ISM, Group 1, Class A equipment)	
<b>Immunity</b>	EN50082-1	Performance Code <sup>1</sup>
	IEC 555-2	1
	IEC 555-3	1
	IEC 801-2 (ESD) 8kV AD	2
	IEC 801-3 (Rad.) 3V/m1	1
	IEC 801-4 (EFT) 1kV	1
	Performance Codes:	
	1 Pass - Normal operation, no effect.	
	2 Pass - Temporary degradation, self recoverable.	
	3 Pass - Temporary degradation, operator intervention required.	
	4 Fail - Not recoverable, component damage.	
<b>Safety</b>	IEC 348:1978 / HD 401 S1:1981 UL 1244 CSA-C22.2 No. 231 (Series M-89)	

**Sound Pressure Level** N/A

### Regulatory Information for Canada

#### **ICES/NMB-001**

This ISM device complies with Canadian ICES-001.  
Cet appareil ISM est conforme à la norme NMB-001 du Canada.

### Regulatory Information for Australia/New Zealand

This ISM device complies with Australian/New Zealand AS/NZS 2064.1



**Definitions:** Installation category (overvoltage category) I: Signal level, special equipment or parts of equipment, telecommunication, electronic etc., with smaller transient overvoltages than installation (overvoltage category) II.

Installation category (overvoltage category) II: Local level, appliances, portable equipment etc., with smaller transient overvoltages than installation category III.

**Environmental Conditions** Indoor use only.  
Altitude up to 3000 m. (10,000 ft.)

**Temperature** Instrument - 0 degrees C to 50 degrees C (32 degrees F to 122 degrees F)  
Disk Media - 10 degrees C to 40 degrees C (50 degrees F to 104 degrees F)  
Probes/cables - 0 degrees C to 65 degrees C (32 degrees F to 149 degrees F)

**Humidity** Relative humidity 8 to 80% at 40 degrees C (104 degrees F)

**Power** (From host frame.)



Agilent Technologies

# DECLARATION OF CONFORMITY

According to ISO/IEC Guide 22 and CEN/CENELEC EN 45014

**Manufacturer's Name:** Agilent Technologies, Inc.  
**Manufacturer's Address:** 1900 Garden of the Gods Road  
Colorado Springs, Colorado  
80907 U.S.A.

## Declares, that the product

**Product Name:** Pattern Generator Module  
**Model Number:** 16522A  
**Product Options:** This declaration covers all options of the above product(s).

## Conforms with the following product standards:

EMC	Standard	Limit
	CISPR 11:1990 / EN 55011:1991	Group 1, Class A
	IEC 555-2:1982 + A1:1985 / EN 60555-2:1987	
	IEC 555-3:1982 + A1:1990 / EN 60555-3:1987 + A1:1991	
	IEC 801-2:1991 / EN 50082-1:1992	4 kV CD, 8 kV AD
	IEC 801-3:1984 / EN 50082-1:1992	3 V/m, {1kHz 80% AM, 27-1000 MHz}
	IEC 801-4:1988 / EN 50082-1:1992	0.5 kV Sig. Lines, 1 kV Power Lines

**Safety** IEC 1010-1:1990+A1 / EN 61010-1:1993  
UL 3111  
CSA-C22.2 No. 1010.1:1993

## Additional Information:

The product herewith complies with the requirements of the Low Voltage Directive 73/23/EEC and the EMC Directive 89/336/EEC (including 93/68/EEC) and carries the CE-marking accordingly (European Union).

The product was tested in a typical configuration with Agilent Technologies test systems.

Date: 4/03/95

  
John Strathman / Quality Manager

For further information, please contact your local Agilent Technologies sales office, agent or distributor.

---

## Product Regulations

---

<b>EMC</b>	This Product meets the requirements of the European Communities (EC) EMC Directive 89/336/EEC.	
<b>Emissions</b>	EN55011/CISPR 11 (ISM, Group 1, Class A equipment)	
<b>Immunity</b>	EN50082-1	Code <sup>1</sup>
	IEC 555-2	1
	IEC 555-3	1
	IEC 801-2 (ESD) 8kV AD	1
	IEC 801-3 (Rad.) 3V/m	1
	IEC 801-4 (EFT) 1kV	1
	Performance Codes <sup>1</sup> :	
	1 Pass - Normal operation, no effect.	
	2 Pass - Temporary degradation, self recoverable.	
	3 Pass - Temporary degradation, operator intervention required.	
	4 Fail - Not recoverable, component damage.	
<b>Safety</b>	IEC 1010-1:1990+A1 / EN 61010-1: 1993 UL 3111 CSA-C22.2 No. 1010.1:1993	

**Sound Pressure Level** N/A

### **Regulatory Information for Canada**

#### **ICES/NMB-001**

This ISM device complies with Canadian ICES-001.  
Cet appareil ISM est conforme à la norme NMB-001 du Canada.

### **Regulatory Information for Australia/New Zealand**

This ISM device complies with Australian/New Zealand AS/NZS 2064.1



**Definitions:** Installation category (overvoltage category) I: Signal level, special equipment or parts of equipment, telecommunication, electronic etc., with smaller transient overvoltages than installation (overvoltage category) II.

Installation category (overvoltage category) II: Local level, appliances, portable equipment etc., with smaller transient overvoltages than installation category III.

**Environmental Conditions** Indoor use only.  
Altitude up to 3000 m. (10,000 ft.)

**Temperature** Instrument - 0 degrees C to 50 degrees C (32 degrees F to 122 degrees F)  
Disk Media - 10 degrees C to 40 degrees C (50 degrees F to 104 degrees F)  
Probes/cables - 0 degrees C to 65 degrees C (32 degrees F to 149 degrees F)

**Humidity** Relative humidity 8 to 80% at 40 degrees C (104 degrees F)

**Power** (From host frame.)



Agilent Technologies

# DECLARATION OF CONFORMITY

According to ISO/IEC Guide 22 and CEN/CENELEC EN 45014

**Manufacturer's Name:** Agilent Technologies, Inc.  
**Manufacturer's Address:** 1900 Garden of the Gods Road  
Colorado Springs, Colorado  
80907 U.S.A.

**Declares, that the product**

**Product Name:** Digitizing Oscilloscope Module  
**Model Number:** 16533A and 16534A  
**Product Options:** This declaration covers all options of the above product(s).

**Conforms with the following product standards:**

<b>EMC</b>	<b>Standard</b>	<b>Limit</b>
	CISPR 11:1990 / EN 55011:1991	Group 1, Class A
	IEC 555-2:1982 + A1:1985 / EN 60555-2:1987	
	IEC 555-3:1982 + A1:1990 / EN 60555-3:1987 + A1:1991	
	IEC 801-2:1991 / EN 50082-1:1992	4 kV CD, 8 kV AD
	IEC 801-3:1984 / EN 50082-1:1992	3 V/m, {1kHz 80% AM, 27-1000 MHz}
	IEC 801-4:1988 / EN 50082-1:1992	0.5 kV Sig. Lines, 1 kV Power Lines

**Safety** IEC 1010-1:1990+A1 / EN 61010-1:1993  
UL 3111  
CSA-C22.2 No. 1010.1:1993

**Additional Information:**

The product herewith complies with the requirements of the Low Voltage Directive 73/23/EEC and the EMC Directive 89/336/EEC (including 93/68/ECC) and carries the CE-marking accordingly (European Union).

The product was tested in a typical configuration with Agilent Technologies test systems.

Date: 4/03/95

  
John Strathman / Quality Manager

For further information, please contact your local Agilent Technologies sales office, agent or distributor.

---

## Product Regulations

---

<b>EMC</b>	This Product meets the requirements of the European Communities (EC) EMC Directive 89/336/EEC.	
<b>Emissions</b>	EN55011/CISPR 11 (ISM, Group 1, Class A equipment)	
<b>Immunity</b>	EN50082-1	Code <sup>1</sup>
	IEC 555-2	1
	IEC 555-3	1
	IEC 801-2 (ESD) 8kV AD	1
	IEC 801-3 (Rad.) 3V/m	1
	IEC 801-4 (EFT) 1kV	1
	Performance Codes <sup>1</sup> :	
	1 Pass - Normal operation, no effect.	
	2 Pass - Temporary degradation, self recoverable.	
	3 Pass - Temporary degradation, operator intervention required.	
	4 Fail - Not recoverable, component damage.	
<b>Safety</b>	IEC 1010-1:1990+A1 / EN 61010-1: 1993 UL 3111 CSA-C22.2 No. 1010.1:1993	

**Sound Pressure Level** N/A

### **Regulatory Information for Canada**

#### **ICES/NMB-001**

This ISM device complies with Canadian ICES-001.  
Cet appareil ISM est conforme à la norme NMB-001 du Canada.

### **Regulatory Information for Australia/New Zealand**

This ISM device complies with Australian/New Zealand AS/NZS 2064.1



**Definitions:** Installation category (overvoltage category) I: Signal level, special equipment or parts of equipment, telecommunication, electronic etc., with smaller transient overvoltages than installation (overvoltage category) II.

Installation category (overvoltage category) II: Local level, appliances, portable equipment etc., with smaller transient overvoltages than installation category III.

**Environmental Conditions** Indoor use only.  
Altitude up to 3000 m. (10,000 ft.)

**Temperature** Instrument - 0 degrees C to 50 degrees C (32 degrees F to 122 degrees F)  
Disk Media - 10 degrees C to 40 degrees C (50 degrees F to 104 degrees F)  
Probes/cables - 0 degrees C to 65 degrees C (32 degrees F to 149 degrees F)

**Humidity** Relative humidity 8 to 80% at 40 degrees C (104 degrees F)

**Power** (From host frame.)



Agilent Technologies

# DECLARATION OF CONFORMITY

According to ISO/IEC Guide 22 and CEN/CENELEC EN 45014

**Manufacturer's Name:** Agilent Technologies, Inc.  
**Manufacturer's Address:** 1900 Garden of the Gods Road  
Colorado Springs, Colorado  
80907 U.S.A.

**Declares, that the product**

**Product Name:** Logic Analyzer Module  
**Model Number:** 16557D  
**Product Options:** This declaration covers all options of the above product(s).

**Conforms with the following product standards:**

<b>EMC</b>	<b>Standard</b>	<b>Limit</b>
	CISPR 11:1990 / EN 55011:1991	Group 1, Class A
	IEC 555-2:1982 + A1:1985 / EN 60555-2:1987	
	IEC 555-3:1982 + A1:1990 / EN 60555-3:1987 + A1:1991	
	IEC 801-2:1991 / EN 50082-1:1992	4 kV CD, 8 kV AD
	IEC 801-3:1984 / EN 50082-1:1992	3 V/m, {1kHz 80% AM, 27-1000 MHz}
	IEC 801-4:1988 / EN 50082-1:1992	0.5 kV Sig. Lines, 1 kV Power Lines

**Safety** IEC 1010-1:1990+A1 / EN 61010-1:1993  
UL 3111  
CSA-C22.2 No. 1010.1:1993

**Additional Information:**

The product herewith complies with the requirements of the Low Voltage Directive 73/23/EEC and the EMC Directive 89/336/EEC (including 93/68/EEC) and carries the CE-marking accordingly (European Union).

The product was tested in a typical configuration with Agilent Technologies test systems.

Date: 7/02/97

  
John Strathman / Quality Manager

For further information, please contact your local Agilent Technologies sales office, agent or distributor.

---

## Product Regulations

---

<b>EMC</b>	This Product meets the requirements of the European Communities (EC) EMC Directive 89/336/EEC.	
<b>Emissions</b>	EN55011/CISPR 11 (ISM, Group 1, Class A equipment) IEC 555-2 and IEC 555-3	
<b>Immunity</b>	EN50082-1	Code <sup>1</sup> 1
	IEC 801-2 (ESD) 8kV AD	1
	IEC 801-3 (Rad.) 3V/m	1
	IEC 801-4 (EFT) 1kV	
	Performance Codes <sup>1</sup> :	
	1 Pass - Normal operation, no effect.	
	2 Pass - Temporary degradation, self recoverable.	
	3 Pass - Temporary degradation, operator intervention required.	
	4 Fail - Not recoverable, component damage.	
<b>Safety</b>	IEC 1010-1:1990+A1 / EN 61010-1: 1993 UL 3111 CSA-C22.2 No. 1010.1:1993	

**Sound Pressure Level** N/A

### Regulatory Information for Canada

#### **ICES/NMB-001**

This ISM device complies with Canadian ICES-001.  
Cet appareil ISM est conforme à la norme NMB-001 du Canada.

### Regulatory Information for Australia/New Zealand

This ISM device complies with Australian/New Zealand AS/NZS 2064.1



**Definitions:** Installation category (overvoltage category) I: Signal level, special equipment or parts of equipment, telecommunication, electronic etc., with smaller transient overvoltages than installation (overvoltage category) II.

Installation category (overvoltage category) II: Local level, appliances, portable equipment etc., with smaller transient overvoltages than installation category III.

**Environmental Conditions** Indoor use only.  
Altitude up to 3000 m. (10,000 ft.)

**Temperature** Instrument - 0 degrees C to 50 degrees C (32 degrees F to 122 degrees F)  
Disk Media - 10 degrees C to 40 degrees C (50 degrees F to 104 degrees F)  
Probes/cables - 0 degrees C to 65 degrees C (32 degrees F to 149 degrees F)

**Humidity** Relative humidity 8 to 80% at 40 degrees C (104 degrees F)

**Power** (From host frame.)





Agilent Technologies

# DECLARATION OF CONFORMITY

According to ISO/IEC Guide 22 and CEN/CENELEC EN 45014

**Manufacturer's Name:** Agilent Technologies, Inc.  
**Manufacturer's Address:** 1900 Garden of the Gods Road  
Colorado Springs, Colorado  
80907 U.S.A.

**Declares, that the product**

**Product Name:** Logic Analysis System Mainframe  
**Model Number:** 16700B, 16701B and 16702B  
**Product Options:** This declaration covers all options of the above product(s).

**Conforms with the following product standards:**

EMC	Standard	Limit
	IEC 61326-1:1997+A1:1998 / EN 61326-1:1997+A1:1998	
	CCISPR 11:1990/EN 55011:1991	Group 1 Class A <sup>[1, 2]</sup>
	IEC 61000-4-2:1995+A1:1998 / EN 61000-4-2:1995	4kV CD, 8kV AD
	IEC 61000-4-3:1995/EN 61000-4-3:1995	3V/m, 80-1000 MHz
	IEC 61000-4-4:1995/EN 61000-4-4:1995	0.5kV signal lines, 1kV power lines
	IEC 61000-4-5:1995 / EN 61000-4-5:1995	0.5 kV line-line, 1 kV line-ground
	IEC 61000-4-6:1996/EN 61000-4-6:1996	3V, 0.15-80 MHz
	IEC 61000-4-11:1994 / EN 61000-4-11:1994	1 cycle, 100%
	Canada: ICES-001:1998	
	Australia/New Zealand: AS/NZS 2064.1	

**Safety** IEC 61010-1:1990+A1:1992+A2:1995 / EN 61010-1:1993+A2:1995  
Canada: CSA C22.2 No. 1010.1:1992

**Additional Information:**

The product herewith complies with the requirements of the Low Voltage Directive 73/23/EEC and the EMC Directive 89/336/EEC (including 93/68/EEC) and carries the CE-marking accordingly (European Union).

[1] The product was tested in a typical configuration with Agilent Technologies test systems.  
[2] The product meets CISPR requirements using "type test" specified in IEC 61326-1 edition 1.1, section 3.1..

Date: 02/11/2002

Name

Ken Wyatt / Product Regulations Manager

For further information, please contact your local Agilent Technologies sales office, agent or distributor.

---

## Product Regulations

---

<b>EMC</b>	IEC 61326-1:1997+A1:1998 / EN 61326-1:1997+A1:1998	Performance Criteria <sup>1</sup>
	CISPR 11:1990 / EN 55011:1991	
	IEC 61000-4-2:1995+A1:1998 / EN 61000-4-2:1995	
	IEC 61000-4-3:1995 / EN 61000-4-3:1995	A
	IEC 61000-4-4:1995 / EN 61000-4-4:1995	A
	IEC 61000-4-5:1995 / EN 61000-4-5:1995	A
	IEC 61000-4-6:1996 / EN 61000-4-6:1996	A
	IEC 61000-4-11:1994 / EN 61000-4-11:1994	
	Canada: ICES-001:1998	
	Australia/New Zealand: AS/NZS 2064.1	
<b>Safety</b>	IEC 61010-1:1990+A1:1992+A2:1995 / EN 61010-1:1993+A2:1995	
	Canada: CSA C22.2 No. 1010.1:1992	

### Additional Information

The product herewith complies with the requirements of the Low Voltage Directive 73/23/EEC and the EMC Directive 89/336/EEC (including 93/68/EEC) and carries the CE Marking accordingly (European Union).

<sup>1</sup> Performance Criteria:

- A Pass - Normal operation, no effect.
- B Pass - Temporary degradation, self recoverable.
- C Pass - Temporary degradation, operator intervention required.
- D Fail - Not recoverable, component damage.

**Sound Pressure Level** Less than 60 dBA

### Regulatory Information for Canada

#### **ICES/NMB-001**

This ISM device complies with Canadian ICES-001.  
Cet appareil ISM est conforme à la norme NMB-001 du Canada.

### Regulatory Information for Australia/New Zealand

This ISM device complies with Australian/New Zealand AS/NZS 2064.1



**Definitions:** Installation category (overvoltage category) I: Signal level, special equipment or parts of equipment, telecommunication, electronic etc., with smaller transient overvoltages than installation (overvoltage category) II.  
Installation category (overvoltage category) II: Local level, appliances, portable equipment etc., with smaller transient overvoltages than installation category III.

**Environmental Conditions** Indoor use only.  
Altitude up to 3000 m. (10,000 ft.)

**Temperature** Instrument - 0 degrees C to 50 degrees C (32 degrees F to 122 degrees F)  
Disk Media - 10 degrees C to 40 degrees C (50 degrees F to 104 degrees F)  
Probes/cables - 0 degrees C to 65 degrees C (32 degrees F to 149 degrees F)

**Humidity** Relative humidity 8 to 80% at 40 degrees C (104 degrees F)

**Power** (From host frame.)



Agilent Technologies

# DECLARATION OF CONFORMITY

According to ISO/IEC Guide 22 and CEN/CENELEC EN 45014

**Manufacturer's Name:** Agilent Technologies, Inc.  
**Manufacturer's Address:** 1900 Garden of the Gods Road  
Colorado Springs, Colorado  
80907 U.S.A.

**Declares, that the product**

**Product Name:** Logic Analyzer Module  
**Model Number:** 16710A, 16711A and 16712A  
**Product Options:** This declaration covers all options of the above product(s).

**Conforms with the following product standards:**

<b>EMC</b>	<b>Standard</b>	<b>Limit</b>
	CISPR 11:1990 / EN 55011:1991	Group 1, Class A
	IEC 555-2:1982 + A1:1985 / EN 60555-2:1987	
	IEC 555-3:1982 + A1:1990 / EN 60555-3:1987 + A1:1991	
	IEC 801-2:1991 / EN 50082-1:1992	4 kV CD, 8 kV AD
	IEC 801-3:1984 / EN 50082-1:1992	3 V/m, {1kHz 80% AM, 27-1000 MHz}
	IEC 801-4:1988 / EN 50082-1:1992	0.5 kV Sig. Lines, 1 kV Power Line
<b>Safety</b>	IEC 1010-1:1990+A1 / EN 61010-1:1993	
	UL 3111	
	CSA-C22.2 No. 1010.1:1993	

**Additional Information:**

The product herewith complies with the requirements of the Low Voltage Directive 73/23/EEC and the EMC Directive 89/336/EEC (including 93/68/EEC) and carries the CE-marking accordingly (European Union).

The product was tested in a typical configuration with Agilent Technologies test systems.

Date: 09/01/98

\_\_\_\_\_  
Name

Ken Wyatt / Product Regulations Manager

For further information, please contact your local Agilent Technologies sales office, agent or distributor.

## Product Regulations

---

<b>EMC</b>	This Product meets the requirements of the European Communities (EC) EMC Directive 89/336/EEC.	
<b>Emissions</b>	EN55011/CISPR 11 (ISM, Group 1, Class A equipment), IEC 555-2 and IEC 555-3	
<b>Immunity</b>	EN50082-1	Code <sup>1</sup>
	IEC 801-2 (ESD) 8kV AD	2
	IEC 801-3 (Rad.) 3V/m	1
	IEC 801-4 (EFT) 1kV	1
	Performance Codes <sup>1</sup> :	
	1 Pass - Normal operation, no effect.	
	2 Pass - Temporary degradation, self recoverable.	
	3 Pass - Temporary degradation, operator intervention required.	
	4 Fail - Not recoverable, component damage.	
<b>Safety</b>	IEC 1010-1: 1990+A1 / EN 61010-1: 1993 UL 3111 CSA-C22.2 No.1010.1:1993	
<b>Sound Pressure Level</b>	N/A	

### Regulatory Information for Canada

#### **ICES/NMB-001**

This ISM device complies with Canadian ICES-001.  
Cet appareil ISM est conforme à la norme NMB-001 du Canada.

### Regulatory Information for Australia/New Zealand

This ISM device complies with Australian/New Zealand AS/NZS 2064.1



Definitions:	Installation category (overvoltage category) I: Signal level, special equipment or parts of equipment, telecommunication, electronic etc., with smaller transient overvoltages than installation (overvoltage category) II.  Installation category (overvoltage category) II: Local level, appliances, portable equipment etc., with smaller transient overvoltages than installation category III.
Environmental Conditions	Indoor use only. Altitude up to 3000 m. (10,000 ft.)
Temperature	Instrument - 0 degrees C to 50 degrees C (32 degrees F to 122 degrees F) Disk Media - 10 degrees C to 40 degrees C (50 degrees F to 104 degrees F) Probes/cables - 0 degrees C to 65 degrees C (32 degrees F to 149 degrees F)
Humidity	Relative humidity 8 to 80% at 40 degrees C (104 degrees F)
Power	(From host frame.)



Agilent Technologies

# DECLARATION OF CONFORMITY

According to ISO/IEC Guide 22 and CEN/CENELEC EN 45014

**Manufacturer's Name:** Agilent Technologies, Inc.  
**Manufacturer's Address:** 1900 Garden of the Gods Road  
Colorado Springs, Colorado  
80907 U.S.A.

**Declares, that the product**

**Product Name:** Logic Analyzer Module  
**Model Number:** 16715A, 16716A and 16717A  
**Product Options:** This declaration covers all options of the above product(s).

**Conforms with the following product standards:**

<b>EMC</b>	<b>Standard</b>	<b>Limit</b>
	CISPR 11:1990 / EN 55011:1991	Group 1, Class A
	IEC 555-2:1982 + A1:1985 / EN 60555-2:1987	
	IEC 555-3:1982 + A1:1990 / EN 60555-3:1987 + A1:1991	
	IEC 801-2:1991 / EN 50082-1:1992	4 kV CD, 8 kV AD
	IEC 801-3:1984 / EN 50082-1:1992	3 V/m, {1kHz 80% AM, 27-1000 MHz}
	IEC 801-4:1988 / EN 50082-1:1992	0.5 kV Sig. Lines, 1 kV Power Line
<b>Safety</b>	IEC 1010-1:1990+A1 / EN 61010-1:1993	
	UL 3111	
	CSA-C22.2 No. 1010.1:1993	

**Additional Information:**

The product herewith complies with the requirements of the Low Voltage Directive 73/23/EEC and the EMC Directive 89/336/EEC (including 93/68/EEC) and carries the CE-marking accordingly (European Union).

The product was tested in a typical configuration with Agilent Technologies test systems.

Date: 03/19/99

\_\_\_\_\_  
Name

Ken Wyatt / Product Regulations Manager

For further information, please contact your local Agilent Technologies sales office, agent or distributor.

## Product Regulations

---

<b>EMC</b>	This Product meets the requirements of the European Communities (EC) EMC Directive 89/336/EEC.	
<b>Emissions</b>	EN55011/CISPR 11 (ISM, Group 1, Class A equipment), IEC 555-2 and IEC 555-3	
<b>Immunity</b>	EN50082-1	Code <sup>1</sup>
	IEC 801-2 (ESD) 8kV AD	2
	IEC 801-3 (Rad.) 3V/m	1
	IEC 801-4 (EFT) 1kV	1
	Performance Codes <sup>1</sup> :	
	1 Pass - Normal operation, no effect.	
	2 Pass - Temporary degradation, self recoverable.	
	3 Pass - Temporary degradation, operator intervention required.	
	4 Fail - Not recoverable, component damage.	
<b>Safety</b>	IEC 1010-1: 1990+A1 / EN 61010-1: 1993 UL 3111 CSA-C22.2 No.1010.1:1993	
<b>Sound Pressure Level</b>	N/A	

### Regulatory Information for Canada

#### **ICES/NMB-001**

This ISM device complies with Canadian ICES-001.  
Cet appareil ISM est conforme à la norme NMB-001 du Canada.

### Regulatory Information for Australia/New Zealand

This ISM device complies with Australian/New Zealand AS/NZS 2064.1



Definitions:	Installation category (overvoltage category) I: Signal level, special equipment or parts of equipment, telecommunication, electronic etc., with smaller transient overvoltages than installation (overvoltage category) II.  Installation category (overvoltage category) II: Local level, appliances, portable equipment etc., with smaller transient overvoltages than installation category III.
Environmental Conditions	Indoor use only. Altitude up to 3000 m. (10,000 ft.)
Temperature	Instrument - 0 degrees C to 50 degrees C (32 degrees F to 122 degrees F) Disk Media - 10 degrees C to 40 degrees C (50 degrees F to 104 degrees F) Probes/cables - 0 degrees C to 65 degrees C (32 degrees F to 149 degrees F)
Humidity	Relative humidity 8 to 80% at 40 degrees C (104 degrees F)
Power	(From host frame.)



Agilent Technologies

# DECLARATION OF CONFORMITY

According to ISO/IEC Guide 22 and CEN/CENELEC EN 45014

**Manufacturer's Name:** Agilent Technologies, Inc.  
**Manufacturer's Address:** 1900 Garden of the Gods Road  
Colorado Springs, Colorado  
80907 U.S.A.

**Declares, that the product**

**Product Name:** Logic Analysis Module  
**Model Number:** 16718A and 16719A  
**Product Options:** This declaration covers all options of the above product(s).

**Conforms with the following product standards:**

<b>EMC</b>	<b>Standard</b>	<b>Limit</b>
	CISPR 11:1990 / EN 55011:1991	Group 1, Class A
	IEC 555-2:1982 + A1:1985 / EN 60555-2:1987	
	IEC 555-3:1982 + A1:1990 / EN 60555-3:1987 + A1:1991	
	IEC 801-2:1991 / EN 50082-1:1992	4 kV CD, 8 kV AD
	IEC 801-3:1984 / EN 50082-1:1992	3 V/m, {1kHz 80% AM, 27-1000 MHz}
	IEC 801-4:1988 / EN 50082-1:1992	0.5 kV Sig. Lines, 1 kV Power Line
<b>Safety</b>	IEC 1010-1:1990+A1 / EN 61010-1:1993	
	UL 3111	
	CSA-C22.2 No. 1010.1:1993	

**Additional Information:**

The product herewith complies with the requirements of the Low Voltage Directive 73/23/EEC and the EMC Directive 89/336/EEC (including 93/68/EEC) and carries the CE-marking accordingly (European Union).

The product was tested in a typical configuration with Agilent Technologies test systems.

Date: 06/16/99

\_\_\_\_\_  
Name

Ken Wyatt / Product Regulations Manager

For further information, please contact your local Agilent Technologies sales office, agent or distributor.

## Product Regulations

---

<b>EMC</b>	This Product meets the requirements of the European Communities (EC) EMC Directive 89/336/EEC.	
<b>Emissions</b>	EN55011/CISPR 11 (ISM, Group 1, Class A equipment), IEC 555-2 and IEC 555-3	
<b>Immunity</b>	EN50082-1	Code <sup>1</sup>
	IEC 801-2 (ESD) 8kV AD	2
	IEC 801-3 (Rad.) 3V/m	1
	IEC 801-4 (EFT) 1kV	1
	Performance Codes <sup>1</sup> :	
	1 Pass - Normal operation, no effect.	
	2 Pass - Temporary degradation, self recoverable.	
	3 Pass - Temporary degradation, operator intervention required.	
	4 Fail - Not recoverable, component damage.	
<b>Safety</b>	IEC 1010-1: 1990+A1 / EN 61010-1: 1993 UL 3111 CSA-C22.2 No.1010.1:1993	
<b>Sound Pressure Level</b>	N/A	

### Regulatory Information for Canada

#### **ICES/NMB-001**

This ISM device complies with Canadian ICES-001.  
Cet appareil ISM est conforme à la norme NMB-001 du Canada.

### Regulatory Information for Australia/New Zealand

This ISM device complies with Australian/New Zealand AS/NZS 2064.1



Definitions:	Installation category (overvoltage category) I: Signal level, special equipment or parts of equipment, telecommunication, electronic etc., with smaller transient overvoltages than installation (overvoltage category) II.  Installation category (overvoltage category) II: Local level, appliances, portable equipment etc., with smaller transient overvoltages than installation category III.
Environmental Conditions	Indoor use only. Altitude up to 3000 m. (10,000 ft.)
Temperature	Instrument - 0 degrees C to 50 degrees C (32 degrees F to 122 degrees F) Disk Media - 10 degrees C to 40 degrees C (50 degrees F to 104 degrees F) Probes/cables - 0 degrees C to 65 degrees C (32 degrees F to 149 degrees F)
Humidity	Relative humidity 8 to 80% at 40 degrees C (104 degrees F)
Power	(From host frame.)





Agilent Technologies

# DECLARATION OF CONFORMITY

According to ISO/IEC Guide 22 and CEN/CENELEC EN 45014

**Manufacturer's Name:** Agilent Technologies, Inc.  
**Manufacturer's Address:** 1900 Garden of the Gods Road  
Colorado Springs, Colorado  
80907 U.S.A.

## Declares, that the product

**Product Name:** Pattern Generator Module  
**Model Number:** 16720A  
**Product Options:** This declaration covers all options of the above product(s).

## Conforms with the following product standards:

EMC	Standard	Limit
	IEC 61326-1:1997+A1:1998 / EN 61326-1:1997+A1:1998	
	CISPR 11:1990 / EN 55011:1991	Group 1 Class A <sup>[1]</sup>
	IEC 61000-4-2:1995+A1:1998 / EN 61000-4-2:1995	(ESD 4kV CD, 8kV AD)
	IEC 61000-4-3:1995 / EN 61000-4-3:1995	(3V/m 80% AM)
	IEC 61000-4-4:1995 / EN 61000-4-4:1995	(0.5kV line-line, 1kV line-earth)
	IEC 61000-4-5:1995 / EN 61000-4-5:1995	(0.5kV line-line, 1kV line-ground)
	IEC 61000-4-6:1996 / EN 61000-4-6:1996	(3V 80% AM, power line)
	IEC 61000-4-11:1994/EN 61000-4-11:1994	(1 cycle, 100%)
	Australia/New Zealand: AS/NZS 2064.1	

**Safety** IEC 61010-1:1990+A1:1992+A2:1995 / EN 61010-1:1994+A2:1995  
Canada: CSA C22.2 No. 1010.1:1992  
USA: UL 3111-1:1994

## Additional Information:

The product herewith complies with the requirements of the Low Voltage Directive 73/23/EEC and the EMC Directive 89/336/EEC (including 93/68/EEC) and carries the CE-marking accordingly (European Union).

<sup>[1]</sup> The product was tested in a typical configuration with Agilent Technologies test systems.

Date: 02/10/2000

  
\_\_\_\_\_  
Name  
Ken Wyatt / Product Regulations Manager

For further information, please contact your local Agilent Technologies sales office, agent or distributor.

---

## Product Regulations

---

<b>EMC</b>	IEC 61326-1:1997+A1:1998 / EN 61326-1:1997+A1:1998 CISPR 11:1990 / EN 55011:1991 IEC 61000-4-2:1995+A1:1998/EN 61000-4-2:1995 IEC 61000-4-3:1995 / EN 61000-4-3:1995 IEC 61000-4-4:1995 / EN 61000-4-4:1995 IEC 61000-4-5:1995 / EN 61000-4-5:1995 IEC 61000-4-6:1996 / EN 61000-4-6:1996 IEC 61000-4-11:1994 / EN 61000-4-11:1994 Canada: ICES-001:1998	Performance Criteria <sup>[2]</sup>  A A A A A A A
<b>Safety</b>	IEC 61010-1:1990+A1:1992+A2:1995 / EN 61010-1:1994+A2:1995 Canada: CSA C22.2 No. 1010.1:1992	

### Additional Information

The product herewith complies with the requirements of the Low Voltage Directive 73/23/EEC and the EMC Directive 89/336/EEC (including 93/68/EEC) and carries the CE Marking accordingly (European Union).

<sup>[2]</sup> Performance Criteria:

- A Pass - Normal operation, no effect.
- B Pass - Temporary degradation, self recoverable.
- C Pass - Temporary degradation, operator intervention required.
- D Fail - Not recoverable, component damage.

**Sound Pressure Level** N/A

### Regulatory Information for Canada

#### **ICES/NMB-001:1998**

This ISM device complies with Canadian ICES-001.  
Cet appareil ISM est conforme à la norme NMB-001 du Canada.

### Regulatory Information for Australia/New Zealand

This ISM device complies with Australian/New Zealand AS/NZS 2064.1



**Definitions:** Installation category (overvoltage category) I: Signal level, special equipment or parts of equipment, telecommunication, electronic etc., with smaller transient overvoltages than installation (overvoltage category) II.

Installation category (overvoltage category) II: Local level, appliances, portable equipment etc., with smaller transient overvoltages than installation category III.

**Environmental Conditions** Indoor use only.  
Altitude up to 3000 m. (10,000 ft.)

**Temperature** Instrument - 0 degrees C to 50 degrees C (32 degrees F to 122 degrees F)  
Disk Media - 10 degrees C to 40 degrees C (50 degrees F to 104 degrees F)  
Probes/cables - 0 degrees C to 65 degrees C (32 degrees F to 149 degrees F)

**Humidity** Relative humidity 8 to 80% at 40 degrees C (104 degrees F)

**Power** (From host frame.)



Agilent Technologies

# DECLARATION OF CONFORMITY

According to ISO/IEC Guide 22 and CEN/CENELEC EN 45014

**Manufacturer's Name:** Agilent Technologies, Inc.  
**Manufacturer's Address:** 1900 Garden of the Gods Road  
Colorado Springs, Colorado  
80907 U.S.A.

### Declares, that the product

**Product Name:** Logic Analyzer Module  
**Model Number:** 16740A, 16741A and 16742A  
**Product Options:** This declaration covers all options of the above product(s).

### Conforms with the following product standards:

EMC	Standard	Limit
	IEC 61326-1:1997+A1:1998 / EN 61326-1:1997+A1:1998	
	CCISPR 11:1990/EN 55011:1991	Group 1 Class A <sup>[1]</sup>
	IEC 61000-4-2:1995+A1:1998 / EN 61000-4-2:1995	4kV CD, 8kV AD
	IEC 61000-4-3:1995/EN 61000-4-3:1995	3V/m, 80-1000 MHz
	IEC 61000-4-4:1995/EN 61000-4-4:1995	0.5kV signal lines, 1kV power lines
	IEC 61000-4-5:1995 / EN 61000-4-5:1995	0.5 kV line-line, 1 kV line-ground
	IEC 61000-4-6:1996/EN 61000-4-6:1996	3V, 0.15-80 MHz
	IEC 61000-4-11:1994 / EN 61000-4-11:1994	1 cycle, 100%
	Canada: ICES-001:1998	
	Australia/New Zealand: AS/NZS 2064.1	

**Safety** IEC 61010-1:1990+A1:1992+A2:1995 / EN 61010-1:1993+A2:1995  
Canada: CSA C22.2 No. 1010.1:1992

### Additional Information:

The product herewith complies with the requirements of the Low Voltage Directive 73/23/EEC and the EMC Directive 89/336/EEC (including 93/68/EEC) and carries the CE-marking accordingly (European Union).

<sup>[1]</sup> The product was tested in a typical configuration with Agilent Technologies test systems.

Date: 08/29/2001

\_\_\_\_\_  
Name

Ken Wyatt / Product Regulations Manager

For further information, please contact your local Agilent Technologies sales office, agent or distributor.

---

## Product Regulations

---

<b>EMC</b>	IEC 61326-1:1997+A1:1998 / EN 61326-1:1997+A1:1998	Performance Criteria <sup>[2]</sup>
	CISPR 11:1990 / EN 55011:1991	
	IEC 61000-4-2:1995+A1:1998 / EN 61000-4-2:1995	A
	IEC 61000-4-3:1995 / EN 61000-4-3:1995	A
	IEC 61000-4-4:1995 / EN 61000-4-4:1995	A
	IEC 61000-4-5:1995 / EN 61000-4-5:1995	A
	IEC 61000-4-6:1996 / EN 61000-4-6:1996	A
	IEC 61000-4-11:1994 / EN 61000-4-11:1994	A
Canada: ICES-001:1998		
Australia/New Zealand: AS/NZS 2064.1		
<b>Safety</b>	IEC 61010-1:1990+A1:1992+A2:1995 / EN 61010-1:1994+A2:1995	
	Canada: CSA C22.2 No. 1010.1:1992	

### Additional Information

The product herewith complies with the requirements of the Low Voltage Directive 73/23/EEC and the EMC Directive 89/336/EEC (including 93/68/EEC) and carries the CE Marking accordingly (European Union).

<sup>[2]</sup> Performance Criteria:

- A Pass - Normal operation, no effect.
- B Pass - Temporary degradation, self recoverable.
- C Pass - Temporary degradation, operator intervention required.
- D Fail - Not recoverable, component damage.

**Sound Pressure Level** N/A

### Regulatory Information for Canada

#### ICES/NMB-001

This ISM device complies with Canadian ICES-001.  
Cet appareil ISM est conforme à la norme NMB-001 du Canada.

### Regulatory Information for Australia/New Zealand

This ISM device complies with Australian/New Zealand AS/NZS 2064.1



**Definitions:** Installation category (overvoltage category) I: Signal level, special equipment or parts of equipment, telecommunication, electronic etc., with smaller transient overvoltages than installation (overvoltage category) II.

Installation category (overvoltage category) II: Local level, appliances, portable equipment etc., with smaller transient overvoltages than installation category III.

**Environmental Conditions** Indoor use only.  
Altitude up to 3000 m. (10,000 ft.)

**Temperature** Instrument - 0 degrees C to 50 degrees C (32 degrees F to 122 degrees F)  
Disk Media - 10 degrees C to 40 degrees C (50 degrees F to 104 degrees F)  
Probes/cables - 0 degrees C to 65 degrees C (32 degrees F to 149 degrees F)

**Humidity** Relative humidity 8 to 80% at 40 degrees C (104 degrees F)

**Power** (From host frame.)



Agilent Technologies

# DECLARATION OF CONFORMITY

According to ISO/IEC Guide 22 and CEN/CENELEC EN 45014

**Manufacturer's Name:** Agilent Technologies, Inc.  
**Manufacturer's Address:** 1900 Garden of the Gods Road  
Colorado Springs, Colorado  
80907 U.S.A.

**Declares, that the product**

**Product Name:** Logic Analyzer Module  
**Model Number:** 16750A, 16751A and 16752A  
**Product Options:** This declaration covers all options of the above product(s).

**Conforms with the following product standards:**

EMC	Standard	Limit
	IEC 61326-1:1997+A1:1998 / EN 61326-1:1997+A1:1998	
	CCISPR 11:1990/EN 55011:1991	Group 1 Class A <sup>[1]</sup>
	IEC 61000-4-2:1995+A1:1998 / EN 61000-4-2:1995	ESD 4kV CD, 8kV AD
	IEC 61000-4-3:1995/EN 61000-4-3:1995	3V/m, 80% AM
	IEC 61000-4-4:1995/EN 61000-4-4:1995	0.5kV line-line, 1kV line-earth
	IEC 61000-4-5:1995 / EN 61000-4-5:1995	0.5 kV line-line, 1 kV line-ground
	IEC 61000-4-6:1996/EN 61000-4-6:1996	3V, 80% AM, power line
	IEC 61000-4-11:1994 / EN 61000-4-11:1994	1 cycle, 100%
	Canada: ICES-001:1998	
	Australia/New Zealand: AS/NZS 2064.1	

**Safety** IEC 61010-1:1990+A1:1992+A2:1995 / EN 61010-1:1994+A2:1995  
Canada: CSA C22.2 No. 1010.1:1992  
USA: UL 3111-1:1994

**Additional Information:**

The product herewith complies with the requirements of the Low Voltage Directive 73/23/EEC and the EMC Directive 89/336/EEC (including 93/68/EEC) and carries the CE-marking accordingly (European Union).

[1] The product was tested in a typical configuration with Agilent Technologies test systems.

Date: 02/08/2000

Name

Ken Wyatt / Product Regulations Manager

For further information, please contact your local Agilent Technologies sales office, agent or distributor.

---

## Product Regulations

---

<b>EMC</b>	IEC 61326-1:1997+A1:1998 / EN 61326-1:1997+A1:1998 CISPR 11:1990 / EN 55011:1991 IEC 61000-4-2:1995+A1:1998 / EN 61000-4-2:1995 IEC 61000-4-3:1995 / EN 61000-4-3:1995 IEC 61000-4-4:1995 / EN 61000-4-4:1995 IEC 61000-4-5:1995 / EN 61000-4-5:1995 IEC 61000-4-6:1996 / EN 61000-4-6:1996 IEC 61000-4-11:1994 / EN 61000-4-11:1994 Canada: ICES-001:1998 Australia/New Zealand: AS/NZS 2064.1	Performance Criteria <sup>[2]</sup>  A A A A A A
<b>Safety</b>	IEC 61010-1:1990+A1:1992+A2:1995 / EN 61010-1:1994+A2:1995 Canada: CSA C22.2 No. 1010.1:1992	

### Additional Information

The product herewith complies with the requirements of the Low Voltage Directive 73/23/EEC and the EMC Directive 89/336/EEC (including 93/68/EEC) and carries the CE Marking accordingly (European Union).

<sup>[2]</sup> Performance Criteria:

- A Pass - Normal operation, no effect.
- B Pass - Temporary degradation, self recoverable.
- C Pass - Temporary degradation, operator intervention required.
- D Fail - Not recoverable, component damage.

**Sound Pressure Level** N/A

### Regulatory Information for Canada

#### **ICES/NMB-001**

This ISM device complies with Canadian ICES-001.  
Cet appareil ISM est conforme à la norme NMB-001 du Canada.

### Regulatory Information for Australia/New Zealand

This ISM device complies with Australian/New Zealand AS/NZS 2064.1



**Definitions:** Installation category (overvoltage category) I: Signal level, special equipment or parts of equipment, telecommunication, electronic etc., with smaller transient overvoltages than installation (overvoltage category) II.

Installation category (overvoltage category) II: Local level, appliances, portable equipment etc., with smaller transient overvoltages than installation category III.

**Environmental Conditions** Indoor use only.  
Altitude up to 3000 m. (10,000 ft.)

**Temperature** Instrument - 0 degrees C to 50 degrees C (32 degrees F to 122 degrees F)  
Disk Media - 10 degrees C to 40 degrees C (50 degrees F to 104 degrees F)  
Probes/cables - 0 degrees C to 65 degrees C (32 degrees F to 149 degrees F)

**Humidity** Relative humidity 8 to 80% at 40 degrees C (104 degrees F)

**Power** (From host frame.)



Agilent Technologies

# DECLARATION OF CONFORMITY

According to ISO/IEC Guide 22 and CEN/CENELEC EN 45014

**Manufacturer's Name:** Agilent Technologies, Inc.  
**Manufacturer's Address:** 1900 Garden of the Gods Road  
Colorado Springs, Colorado  
80907 U.S.A.

**Declares, that the product**

**Product Name:** Logic Analyzer Module  
**Model Number:** 16750B, 16751B and 16752B  
**Product Options:** This declaration covers all options of the above product(s).

**Conforms with the following product standards:**

EMC	Standard	Limit
	IEC 61326-1:1997+A1:1998 / EN 61326-1:1997+A1:1998	
	CCISPR 11:1990/EN 55011:1991	Group 1 Class A <sup>[1]</sup>
	IEC 61000-4-2:1995+A1:1998 / EN 61000-4-2:1995	ESD 4kV CD, 8kV AD
	IEC 61000-4-3:1995/EN 61000-4-3:1995	3V/m, 80% AM
	IEC 61000-4-4:1995/EN 61000-4-4:1995	0.5kV line-line, 1kV line-earth
	IEC 61000-4-5:1995 / EN 61000-4-5:1995	0.5 kV line-line, 1 kV line-ground
	IEC 61000-4-6:1996/EN 61000-4-6:1996	3V, 80% AM, power line
	IEC 61000-4-11:1994 / EN 61000-4-11:1994	1 cycle, 100%
	Canada: ICES-001:1998	
	Australia/New Zealand: AS/NZS 2064.1	

**Safety** IEC 61010-1:1990+A1:1992+A2:1995 / EN 61010-1:1994+A2:1995  
Canada: CSA C22.2 No. 1010.1:1992  
USA: UL 3111-1:1994

**Additional Information:**

The product herewith complies with the requirements of the Low Voltage Directive 73/23/EEC and the EMC Directive 89/336/EEC (including 93/68/EEC) and carries the CE-marking accordingly (European Union).

[1] The product was tested in a typical configuration with Agilent Technologies test systems.

Date: 05/13/2002

Name

Ken Wyatt / Product Regulations Manager

For further information, please contact your local Agilent Technologies sales office, agent or distributor.

---

## Product Regulations

---

<b>EMC</b>	IEC 61326-1:1997+A1:1998 / EN 61326-1:1997+A1:1998	Performance Criteria <sup>[2]</sup>
	CISPR 11:1990 / EN 55011:1991	
	IEC 61000-4-2:1995+A1:1998 / EN 61000-4-2:1995	A
	IEC 61000-4-3:1995 / EN 61000-4-3:1995	A
	IEC 61000-4-4:1995 / EN 61000-4-4:1995	A
	IEC 61000-4-5:1995 / EN 61000-4-5:1995	A
	IEC 61000-4-6:1996 / EN 61000-4-6:1996	A
	IEC 61000-4-11:1994 / EN 61000-4-11:1994	A
Canada: ICES-001:1998		
Australia/New Zealand: AS/NZS 2064.1		
<b>Safety</b>	IEC 61010-1:1990+A1:1992+A2:1995 / EN 61010-1:1994+A2:1995	
	Canada: CSA C22.2 No. 1010.1:1992	

### Additional Information

The product herewith complies with the requirements of the Low Voltage Directive 73/23/EEC and the EMC Directive 89/336/EEC (including 93/68/EEC) and carries the CE Marking accordingly (European Union).

<sup>[2]</sup> Performance Criteria:

- A Pass - Normal operation, no effect.
- B Pass - Temporary degradation, self recoverable.
- C Pass - Temporary degradation, operator intervention required.
- D Fail - Not recoverable, component damage.

**Sound Pressure Level** N/A

### Regulatory Information for Canada

#### ICES/NMB-001

This ISM device complies with Canadian ICES-001.  
Cet appareil ISM est conforme à la norme NMB-001 du Canada.

### Regulatory Information for Australia/New Zealand

This ISM device complies with Australian/New Zealand AS/NZS 2064.1



**Definitions:** Installation category (overvoltage category) I: Signal level, special equipment or parts of equipment, telecommunication, electronic etc., with smaller transient overvoltages than installation (overvoltage category) II.

Installation category (overvoltage category) II: Local level, appliances, portable equipment etc., with smaller transient overvoltages than installation category III.

**Environmental Conditions** Indoor use only.  
Altitude up to 3000 m. (10,000 ft.)

**Temperature** Instrument - 0 degrees C to 50 degrees C (32 degrees F to 122 degrees F)  
Disk Media - 10 degrees C to 40 degrees C (50 degrees F to 104 degrees F)  
Probes/cables - 0 degrees C to 65 degrees C (32 degrees F to 149 degrees F)

**Humidity** Relative humidity 8 to 80% at 40 degrees C (104 degrees F)

**Power** (From host frame.)





Agilent Technologies

# DECLARATION OF CONFORMITY

According to ISO/IEC Guide 22 and CEN/CENELEC EN 45014

**Manufacturer's Name:** Agilent Technologies, Inc.  
**Manufacturer's Address:** 1900 Garden of the Gods Road  
Colorado Springs, Colorado  
80907 U.S.A.

**Declares, that the product**

**Product Name:** Logic Analyzer Module  
**Model Number:** 16753A, 16754A, 16755A and 16756A  
**Product Options:** This declaration covers all options of the above product(s).

**Conforms with the following product standards:**

EMC	Standard	Limit
	IEC 61326-2:2002/ EN 61326-1:1997	
	CCISPR 11:1997+A1:1999/EN 55011:1991	Group 1 Class A <sup>[1]</sup>
	IEC 61000-4-2:1995+A1:1998+A2:2000 / EN 61000-4-2:1995	4kV CD, 8kV AD
	IEC 61000-4-3:1995+A1:1998+A2:2000/EN 61000-4-3:1995	3V/m, 80-1000 MHz
	IEC 61000-4-4:1995+A1:2000+A2:2001/EN 61000-4-4:1995	0.5kV signal lines, 1kV power lines
	IEC 61000-4-5:1995 / EN 61000-4-5:1995	0.5 kV line-line, 1 kV line-ground
	IEC 61000-4-6:1996+A1:2000/EN 61000-4-6:1996	3V, 0.15-80 MHz
	IEC 61000-4-11:1994 / EN 61000-4-11:1994	1 cycle, 100%
	Canada: ICES/NMB-001:1998	
	Australia/New Zealand: AS/NZS 2064.1	
<b>Safety</b>	IEC 61010-1:1990+A1:1992+A2:1995 / EN 61010-1:1994+A2:1995	
	Canada: CSA C22.2 No. 1010.1:1992	

**Additional Information:**

The product herewith complies with the requirements of the Low Voltage Directive 73/23/EEC and the EMC Directive 89/336/EEC (including 93/68/EEC) and carries the CE-marking accordingly (European Union).

[1] The product was tested in a typical configuration with Agilent Technologies test systems.

Date: 2002-10-16

\_\_\_\_\_  
Name

Ken Wyatt / Product Regulations Manager

For further information, please contact your local Agilent Technologies sales office, agent or distributor.

---

## Product Regulations

---

<b>EMC</b>	IEC 61326-2:2002 / EN 61326-1:1997	Performance Criteria <sup>[2]</sup>
	CISPR 11:1997+A1:1999 / EN 55011:1991 - Group 1 Class A	
	IEC 61000-4-2:1995+A1:1998+A2:2000/EN 61000-4-2:1995 (ESD 4kV CD, 8kV AD)	A
	IEC 61000-4-3:1995+A1:1998+A2:2000/EN 61000-4-3:1995 (3V/m, 80-1000 MHz)	A
	IEC 61000-4-4:1995+A1:1998+A2:2001/EN 61000-4-4:1995 (EFT 0.5kV line-line, 1kV line-earth)	A
	IEC 61000-4-5:1995 / EN 61000-4-5:1995 (Surge 0.5 kV line-line, 1 kV line-earth)	A
	IEC 61000-4-6:1996 / EN 61000-4-6:1996 (3V 80% AM power line)	A
	IEC 61000-4-11:1994 / EN 61000-4-11:1994 (Dips 1 cycle, 100%)	A
	Canada: ICES-001:1998	
	Australia/New Zealand: AS/NZS 2064.1	
<b>Safety</b>	IEC 61010-1:1990+A1:1992+A2:1995 / EN 61010-1:1994+A2:1995	
	Canada: CSA C22.2 No. 1010.1:1992	
	USA: UL 3111-1:1994 (optional)	

### Additional Information

The product herewith complies with the requirements of the Low Voltage Directive 73/23/EEC and the EMC Directive 89/336/EEC (including 93/68/EEC) and carries the CE Marking accordingly (European Union).

<sup>[2]</sup> Performance Criteria:

- A Pass - Normal operation, no effect.
- B Pass - Temporary degradation, self recoverable.
- C Pass - Temporary degradation, operator intervention required.
- D Fail - Not recoverable, component damage.

**Sound Pressure Level**      Less than 60 dBA

### Regulatory Information for Canada

#### **ICES/NMB-001:1998**

This ISM device complies with Canadian ICES-001.  
Cet appareil ISM est conforme à la norme NMB-001 du Canada.

### Regulatory Information for Australia/New Zealand

This ISM device complies with Australian/New Zealand AS/NZS 2064.1



Definitions:	Installation category (overvoltage category) I: Signal level, special equipment or parts of equipment, telecommunication, electronic etc., with smaller transient overvoltages than installation (overvoltage category) II.  Installation category (overvoltage category) II: Local level, appliances, portable equipment etc., with smaller transient overvoltages than installation category III.
Environmental Conditions	Indoor use only. Altitude up to 3000 m. (10,000 ft.)
Temperature	Instrument - 0 degrees C to 50 degrees C (32 degrees F to 122 degrees F) Disk Media - 10 degrees C to 40 degrees C (50 degrees F to 104 degrees F) Probes/cables - 0 degrees C to 65 degrees C (32 degrees F to 149 degrees F)
Humidity	Relative humidity 8 to 80% at 40 degrees C (104 degrees F)
Power	(From host frame.)



Agilent Technologies

# DECLARATION OF CONFORMITY

According to ISO/IEC Guide 22 and CEN/CENELEC EN 45014

**Manufacturer's Name:** Agilent Technologies, Inc.  
**Manufacturer's Address:** 1900 Garden of the Gods Road  
Colorado Springs, Colorado  
80907 U.S.A.

**Declares, that the product**

**Product Name:** Logic Analysis System Module  
**Model Number:** 16760A  
**Product Options:** This declaration covers all options of the above product(s).

**Conforms with the following product standards:**

EMC	Standard	Limit
	IEC 61326-1:1997+A1:1998 / EN 61326-1:1997+A1:1998	
	CCISPR 11:1990/EN 55011:1991	Group 1 Class A <sup>[1]</sup>
	IEC 61000-4-2:1995+A1:1998 / EN 61000-4-2:1995	4kV CD, 8kV AD
	IEC 61000-4-3:1995/EN 61000-4-3:1995	3V/m, 80-1000 MHz
	IEC 61000-4-4:1995/EN 61000-4-4:1995	0.5kV signal lines, 1kV power lines
	IEC 61000-4-5:1995 / EN 61000-4-5:1995	0.5 kV line-line, 1 kV line-ground
	IEC 61000-4-6:1996/EN 61000-4-6:1996	3V, 0.15-80 MHz
	IEC 61000-4-11:1994 / EN 61000-4-11:1994	1 cycle, 100%
	Canada: ICES-001:1998	
	Australia/New Zealand: AS/NZS 2064.1	

**Safety** IEC 61010-1:1990+A1:1992+A2:1995 / EN 61010-1:1993+A2:1995  
Canada: CSA C22.2 No. 1010.1:1992  
USA: UL 3111-1:1994

**Additional Information:**

The product herewith complies with the requirements of the Low Voltage Directive 73/23/EEC and the EMC Directive 89/336/EEC (including 93/68/EEC) and carries the CE-marking accordingly (European Union).

[1] The product was tested in a typical configuration with Agilent Technologies test systems.

Date: 10/12/2000

\_\_\_\_\_  
Name

Ken Wyatt / Product Regulations Manager

For further information, please contact your local Agilent Technologies sales office, agent or distributor.

---

## Product Regulations

---

<b>EMC</b>	IEC 61326-1:1997+A1:1998 / EN 61326-1:1997+A1:1998 CISPR 11:1990 / EN 55011:1991 IEC 61000-4-2:1995+A1:1998 / EN 61000-4-2:1995 IEC 61000-4-3:1995 / EN 61000-4-3:1995 IEC 61000-4-4:1995 / EN 61000-4-4:1995 IEC 61000-4-5:1995 / EN 61000-4-5:1995 IEC 61000-4-6:1996 / EN 61000-4-6:1996 IEC 61000-4-11:1994 / EN 61000-4-11:1994 Canada: ICES-001:1998 Australia/New Zealand: AS/NZS 2064.1	Performance Criteria <sup>[2]</sup>  B A A A B A
<b>Safety</b>	IEC 61010-1:1990+A1:1992+A2:1995 / EN 61010-1:1994+A2:1995 Canada: CSA C22.2 No. 1010.1:1992	

### Additional Information

The product herewith complies with the requirements of the Low Voltage Directive 73/23/EEC and the EMC Directive 89/336/EEC (including 93/68/EEC) and carries the CE Marking accordingly (European Union).

<sup>[2]</sup> Performance Criteria:

- A Pass - Normal operation, no effect.
- B Pass - Temporary degradation, self recoverable.
- C Pass - Temporary degradation, operator intervention required.
- D Fail - Not recoverable, component damage.

**Sound Pressure Level** N/A

### Regulatory Information for Canada

#### **ICES/NMB-001**

This ISM device complies with Canadian ICES-001.  
Cet appareil ISM est conforme à la norme NMB-001 du Canada.

### Regulatory Information for Australia/New Zealand

This ISM device complies with Australian/New Zealand AS/NZS 2064.1



**Definitions:** Installation category (overvoltage category) I: Signal level, special equipment or parts of equipment, telecommunication, electronic etc., with smaller transient overvoltages than installation (overvoltage category) II.

Installation category (overvoltage category) II: Local level, appliances, portable equipment etc., with smaller transient overvoltages than installation category III.

**Environmental Conditions** Indoor use only.  
Altitude up to 3000 m. (10,000 ft.)

**Temperature** Instrument - 0 degrees C to 50 degrees C (32 degrees F to 122 degrees F)  
Disk Media - 10 degrees C to 40 degrees C (50 degrees F to 104 degrees F)  
Probes/cables - 0 degrees C to 65 degrees C (32 degrees F to 149 degrees F)

**Humidity** Relative humidity 8 to 80% at 40 degrees C (104 degrees F)

**Power** (From host frame.)

# Safety Notices

This apparatus has been designed and tested in accordance with IEC Publication 1010, Safety Requirements for Measuring Apparatus, and has been supplied in a safe condition. This is a Safety Class I instrument (provided with terminal for protective earthing). Before applying power, verify that the correct safety precautions are taken (see the following warnings). In addition, note the external markings on the instrument that are described under "Safety Symbols."

## Warnings

- Before turning on the instrument, you must connect the protective earth terminal of the instrument to the protective conductor of the (mains) power cord. The mains plug shall only be inserted in a socket outlet provided with a protective earth contact. You must not negate the protective action by using an extension cord (power cable) without a protective conductor (grounding). Grounding one conductor of a two-conductor outlet is not sufficient protection.
- Only fuses with the required rated current, voltage, and specified type (normal blow, time delay, etc.) should be used. Do not use repaired fuses or short-circuited fuseholders. To do so could cause a shock or fire hazard.
- If you energize this instrument by an auto transformer (for voltage reduction or mains isolation), the common terminal must be connected to the earth terminal of the power source.
- Whenever it is likely that the

ground protection is impaired, you must make the instrument inoperative and secure it against any unintended operation.

- Service instructions are for trained service personnel. To avoid dangerous electric shock, do not perform any service unless qualified to do so. Do not attempt internal service or adjustment unless another person, capable of rendering first aid and resuscitation, is present.
- Do not install substitute parts or perform any unauthorized modification to the instrument.
- Capacitors inside the instrument may retain a charge even if the instrument is disconnected from its source of supply.
- Do not operate the instrument in the presence of flammable gasses or fumes. Operation of any electrical instrument in such an environment constitutes a definite safety hazard.
- Do not use the instrument in a manner not specified by the manufacturer.

## To clean the instrument

If the instrument requires cleaning: (1) Remove power from the instrument. (2) Clean the external surfaces of the instrument with a soft cloth dampened with a mixture of mild detergent and water. (3) Make sure that the instrument is completely dry before reconnecting it to a power source.

## Safety Symbols



Instruction manual symbol: the product is marked with this symbol when it is necessary for you to refer to the instruction manual in order to protect against damage to the product..



Hazardous voltage symbol.



Earth terminal symbol: Used to indicate a circuit common connected to grounded chassis.

Agilent Technologies Inc.  
P.O. Box 2197  
1900 Garden of the Gods Road  
Colorado Springs, CO 80901-2197, U.S.A.

# Notices

© Agilent Technologies, Inc. 2002

No part of this manual may be reproduced in any form or by any means (including electronic storage and retrieval or translation into a foreign language) without prior agreement and written consent from Agilent Technologies, Inc. as governed by United States and international copyright laws.

## Manual Part Number

16700-97023, November 2002

## Print History

16700-97014, April 2000

16700-97018, February 2001

16700-97019, November 2001

16700-97022, October 2002

16700-97023, November 2002

Agilent Technologies, Inc.  
1900 Garden of the Gods Road  
Colorado Springs, CO 80907 USA

## Restricted Rights Legend

If software is for use in the performance of a U.S. Government prime contract or subcontract, Software is delivered and licensed as "Commercial computer software" as defined in DFAR 252.227-7014 (June 1995), or as a "commercial item" as defined in FAR 2.101(a) or as "Restricted computer software" as defined in FAR 52.227-19 (June 1987) or any equivalent agency regulation or contract clause. Use, duplication or disclosure of Software is subject to Agilent Technologies' standard commercial license terms, and non-DOD Departments and Agencies of the U.S. Government will receive no greater than Restricted Rights as defined in FAR 52.227-19(c)(1-2) (June 1987). U.S. Government users will receive no greater than Limited Rights as defined in FAR 52.227-14 (June 1987) or

DFAR 252.227-7015 (b)(2) (November 1995), as applicable in any technical data.

## Document Warranty

**The material contained in this document is provided "as is," and is subject to being changed, without notice, in future editions. Further, to the maximum extent permitted by applicable law, Agilent disclaims all warranties, either express or implied, with regard to this manual and any information contained herein, including but not limited to the implied warranties of merchantability and fitness for a particular purpose. Agilent shall not be liable for errors or for incidental or consequential damages in connection with the furnishing, use, or performance of this document or of any information contained herein. Should Agilent and the user have a separate written agreement with warranty terms covering the material in this document that conflict with these terms, the warranty terms in the separate agreement shall control.**

## Technology Licenses

The hardware and/or software described in this document are furnished under a license and may be used or copied only in accordance with the terms of such license.

## WARNING

**A WARNING notice denotes a hazard. It calls attention to an operating procedure, practice, or the like that, if not correctly performed or adhered to, could result in personal injury or death. Do not proceed beyond a WARNING notice until the indicated conditions are fully understood and met.**

## CAUTION

A CAUTION notice denotes a hazard. It calls attention to an operating procedure, practice, or the like that, if not correctly performed or adhered to, could result in damage to the product or loss of important data. Do not proceed beyond a CAUTION notice until the indicated conditions are fully understood and met.

## Trademark Acknowledgements

Windows and MS Windows are U.S. registered trademarks of Microsoft Corporation.

Windows NT is a U.S. registered trademark of Microsoft Corporation.