



Communications Test Set 3500 / 3500A Operation Manual

Issue-4

EXPORT CONTROL WARNING: This document contains controlled technology or technical data under the jurisdiction of the Export Administration Regulations (EAR), 15 CFR 730-774. It cannot be transferred to any foreign third party without the specific prior approval of the U.S. Department of Commerce, Bureau of Industry and Security (BIS). Violations of these regulations are punishable by fine, imprisonment, or both.

OPERATION MANUAL

COMMUNICATIONS TEST SET

3500 / 3500A

PUBLISHED BY
Aeroflex

COPYRIGHT © Aeroflex 2010

All rights reserved. No part of this publication may be reproduced, stored in a retrieval system, or transmitted in any form or by any means, electronic, mechanical, photocopying, recording or otherwise without the prior permission of the publisher.

Reissued	Jan 2010
Issue-2	Apr 2010
Issue-3	May 2010
Issue-4	Mar 2011

10200 West York / Wichita, Kansas 67215 U.S.A. / (316) 522-4981 / FAX (316) 524-2623

Subject to Export Control, see Cover Page for details.

Electromagnetic Compatibility:

For continued EMC compliance, all external cables must be shielded and three meters or less in length.

Nomenclature Statement:

In this manual, 3500 / 3500A, Test Set or Unit refers to the 3500 / 3500A Communications Test Set.

Subject to Export Control, see Cover Page for details.

THIS PAGE INTENTIONALLY LEFT BLANK.

Subject to Export Control, see Cover Page for details.

SAFETY FIRST: TO ALL OPERATIONS PERSONNEL

REFER ALL SERVICING OF UNIT TO QUALIFIED TECHNICAL PERSONNEL. THIS UNIT CONTAINS NO OPERATOR SERVICEABLE PARTS.

WARNING: USING THIS EQUIPMENT IN A MANNER NOT SPECIFIED BY THE ACCOMPANYING DOCUMENTATION MAY IMPAIR THE SAFETY PROTECTION PROVIDED BY THE EQUIPMENT.

CASE, COVER OR PANEL REMOVAL

Opening the Case Assembly exposes the operator to electrical hazards that can result in electrical shock or equipment damage. Do not operate this Test Set with the Case Assembly open.

SAFETY IDENTIFICATION IN TECHNICAL MANUAL

This manual uses the following terms to draw attention to possible safety hazards, that may exist when operating or servicing this equipment.

CAUTION: THIS TERM IDENTIFIES CONDITIONS OR ACTIVITIES THAT, IF IGNORED, CAN RESULT IN EQUIPMENT OR PROPERTY DAMAGE (E.G., FIRE).

WARNING: THIS TERM IDENTIFIES CONDITIONS OR ACTIVITIES THAT, IF IGNORED, CAN RESULT IN PERSONAL INJURY OR DEATH.

SAFETY SYMBOLS IN MANUALS AND ON UNITS



CAUTION: Refer to accompanying documents. (This symbol refers to specific CAUTIONS represented on the unit and clarified in the text.)



AC OR DC TERMINAL: Terminal that may supply or be supplied with AC or DC voltage.



DC TERMINAL: Terminal that may supply or be supplied with DC voltage.



AC TERMINAL: Terminal that may supply or be supplied with AC or alternating voltage.

EQUIPMENT GROUNDING PRECAUTION

Improper grounding of equipment can result in electrical shock.

USE OF PROBES

Check the specifications for the maximum voltage, current and power ratings of any connector on the Test Set before connecting it with a probe from a terminal device. Be sure the terminal device performs within these specifications before using it for measurement, to prevent electrical shock or damage to the equipment.

POWER CORDS

Power cords must not be frayed, broken nor expose bare wiring when operating this equipment.

USE RECOMMENDED FUSES ONLY

Use only fuses specifically recommended for the equipment at the specified current and voltage ratings.

INTERNAL BATTERY

This unit contains a Lithium Ion Battery, serviceable only by a qualified technician.

CAUTION: SIGNAL GENERATORS CAN BE A SOURCE OF ELECTROMAGNETIC INTERFERENCE (EMI) TO COMMUNICATION RECEIVERS. SOME TRANSMITTED SIGNALS CAN CAUSE DISRUPTION AND INTERFERENCE TO COMMUNICATION SERVICES OUT TO A DISTANCE OF SEVERAL MILES. USERS OF THIS EQUIPMENT SHOULD SCRUTINIZE ANY OPERATION THAT RESULTS IN RADIATION OF A SIGNAL (DIRECTLY OR INDIRECTLY) AND SHOULD TAKE NECESSARY PRECAUTIONS TO AVOID POTENTIAL COMMUNICATION INTERFERENCE PROBLEMS.

Subject to Export Control, see Cover Page for details.

THIS PAGE INTENTIONALLY LEFT BLANK.

Subject to Export Control, see Cover Page for details.

DECLARATION OF CONFORMITY

The Declaration of Conformity Certificate included with the Unit should remain with the Unit.

Aeroflex recommends the operator reproduce a copy of the Declaration of Conformity Certificate to be stored with the Operation Manual for future reference.

Subject to Export Control, see Cover Page for details.

THIS PAGE INTENTIONALLY LEFT BLANK.

Subject to Export Control, see Cover Page for details.

PREFACE

SCOPE

This Manual contains Instructions for operating the 3500 / 3500A. It is strongly recommended that the Operator be thoroughly familiar with this manual before attempting to operate the equipment.

ORGANIZATION

The Manual is composed of the following Chapters:

CHAPTER 1 - INTRODUCTION

Provides an Introduction and a Brief Overview of Functions and Features. Principles of Operation are also included.

CHAPTER 2 - OPERATING INSTRUCTIONS

Identifies and functionally describes all Controls, Indicators and Connectors.

Identifies and explains all Operation Screens and Menus.

Provides a Turn-On Procedure and Initial Adjustments.

Provides Applications.

CHAPTER 3 - OPERATOR MAINTENANCE

Identifies and explains Routine Service, Troubleshooting, Maintenance and Storage Procedures.

CHAPTER 4 - OPTIONS

Identifies and explains the Options available for the 3500 / 3500A.

TABLE OF CONTENTS

PARAGRAPH		PAGE
CHAPTER 1 - INTRODUCTION		
1-1	General Information	1-1
1-1A	Scope	1-1
1-1B	Nomenclature Cross-Reference List	1-1
1-2	Equipment Capabilities and Features	1-2
1-2A	Capabilities	1-2
1-2B	Features	1-3
1-3	Equipment Data	1-4
1-4	Principles of Operation	1-15
CHAPTER 2 - OPERATING INSTRUCTIONS		
2-1	Operator's Controls, Indicators and Connectors	2-1
2-2	Operation Screens and Menu Configurations	2-5
2-2-1	Screen Icons	2-6
2-2-2	System Menu	2-8
2-2-2A	Duplex Test Screen	2-9
2-2-2B	Receiver Test Screen	2-18
2-2-2C	Transmitter Test Screen	2-26
2-2-2D	ANT-Cable Test Screen	2-31
2-2-2E	Audio Function Generator Test Screen	2-40
2-2-3	Meters Menu	2-44
2-2-3A	SINAD Meter Screen	2-45
2-2-3B	Distortion Meter Screen	2-47
2-2-3C	AF Counter Screen	2-49
2-2-3D	Audio Level Meter Screen	2-51
2-2-4	Self Test Menu	2-53
2-2-4A	Self Test Screen	2-54
2-2-4B	Diagnostic Screen	2-55
2-2-4C	Calibration Screen	2-58
2-2-5	Utilities Menu	2-59
2-2-5A	Annunciator Setup Screen	2-60
2-2-5B	Remote Setup Screen	2-61
2-2-5C	Version Screen	2-66
2-2-5D	Date / Time Screen	2-67
2-2-5E	HW Config Setup Screen	2-68
2-2-5F	Options Screen	2-70
2-2-5G	USB Manager Screen	2-71
2-2-5H	Unit Copy Screen	2-72
2-2-6	Other Meters / Functions	2-73
2-2-6A	DCS Decode Meter	2-74
2-2-6B	DTMF Decode Meter	2-75
2-2-6C	Function Generator	2-76
2-2-6D	Modulation Meter Screen	2-77
2-2-6E	RF Error Meter Screen	2-79
2-2-6F	RF Power Meter Screen	2-81
2-2-6G	RSSI Meter Screen	2-83
2-2-7	Other Functions	2-85
2-2-7A	Recall Configuration Screen	2-85
2-2-7B	Save Configuration Screen	2-86
2-3	Preventive Maintenance Checks and Services	2-87
2-3-1	General	2-87
2-3-2	Preventive Maintenance Procedures	2-87
2-3-2A	Tools, Materials and Equipment Required	2-87
2-3-2B	Routine Checks	2-87
2-3-2C	Schedule of Checks	2-87

CHAPTER 2 - OPERATING INSTRUCTIONS (cont)

2-4	Operation Under Usual Conditions	2-88
2-4-1	Turn-On Procedure	2-88
2-4-2	Screen Warnings and Cautions	2-90
2-5	Operating Procedures	2-91
2-5-1	Introduction	2-91
2-5-2	Typical Vehicle Installation Test	2-92
2-5-3	Advanced Vehicle Installation Testing	2-96
2-5-4	Measuring SWR	2-97
2-5-5	Measuring DTF (Distance to Fault)	2-102
2-5-6	Measuring Reverse Power	2-108
2-5-7	Loading Software using USB Memory Device	2-112

CHAPTER 3 - MAINTENANCE

3-1	Service Upon Receipt	3-1
3-1-1	Service Upon Receipt of Material	3-1
3-1-1A	Unpacking	3-1
3-1-1B	Checking Unpacked Equipment	3-1
3-1-2	Preliminary Servicing and Adjustment of Equipment	3-2
3-2	Troubleshooting	3-3
3-3	Maintenance Procedures	3-7
3-3-1	Battery Recharging	3-7
3-3-2	Battery Replacement	3-8
3-3-3	Fuse Replacement	3-11
3-3-4	Handle Replacement	3-14
3-3-5	Bumper Replacement	3-16
3-4	Preparation for Storage or Shipment	3-17
3-4A	Packaging	3-17
3-4B	Environment	3-17

CHAPTER 4 - OPTIONS

4-1	General	4-1
4-2	Installing Options	4-2
4-3	Spectrum Analyzer Option (35000010)	4-3
4-3-1	Spectrum Analyzer Screen	4-4
4-3-2	Spectrum Analyzer Screen Features and Functions	4-5
4-4	Oscilloscope Option (35000001)	4-15
4-4-1	Oscilloscope Screen	4-15
4-4-2	Oscilloscope Screen Features and Functions	4-16
4-5	Tracking Generator Option (35000070)	4-23
4-5-1	Tracking Generator Screen	4-23
4-5-2	Tracking Generator Screen Features and Functions	4-24
4-6	P25 Option (35000100)	4-31
4-6-1	P25 Mini-Meter	4-31
4-6-2	P25 Mini-Meter Features and Functions	4-32
4-6-3	Digital Receive (P25) Screen Features and Functions	4-33
4-7	DMR Option (35000200)	4-35
4-7-1	DMR Mini-Meter	4-35
4-7-2	DMR Mini-Meter Features and Functions	4-36
4-7-3	Digital Receive (DMR) Screen Features and Functions	4-37
4-8	NXDN Option (35000400)	4-41
4-8-1	NXDN Mini-Meter	4-41
4-8-2	NXDN Mini-Meter Features and Functions	4-42
4-8-3	Digital Receive (NXDN) Screen Features and Functions	4-43

CHAPTER 4 - OPTIONS (cont)

4-9	dPMR Option (35000300)	4-45
4-9-1	dPMR Mini-Meter	4-45
4-9-2	dPMR Mini-Meter Features and Functions	4-46
4-9-3	Digital Receive (dPMR) Screen Features and Functions	4-47
4-10	ARIBT98 Option (35000500)	4-49
4-10-1	ARIBT98 Mini-Meter	4-49
4-10-2	ARIBT98 Mini-Meter Features and Functions	4-50
4-10-3	Digital Receive (ARIBT98) Screen Features and Functions	4-51
4-11	Scripting Option (35000060)	4-53
4-11-1	Scripts Screen	4-53
4-11-2	Scripts Screen Features and Functions	4-54
4-11-3	Transfer Scripts to the 3500 / 3500A	4-55
4-11-4	Copy Scripts with Unit Copy Screen	4-57
4-11-5	General Scripting Commands	4-58
4-11-6	Scripting Flowcharts	4-59

APPENDICES

A	Connector Pin-Out Tables	A-1
A-1	I/O Connectors	A-1
A-2	AUDIO Connector Pin-Out Table	A-3
A-3	REMOTE Connector Pin-Out Table	A-5
B	Abbreviations	B-1
C	Remote Operation	C-1

INDEX

LIST OF ILLUSTRATIONS / TABLES

LIST OF ILLUSTRATIONS

<u>TITLE</u>	<u>PAGE</u>
Controls, Connectors and Indicators	2-1
Comm Breakout Box Connectors	2-4
Menu / Screen Hierarchy	2-5

LIST OF TABLES

<u>TITLE</u>	<u>PAGE</u>
3500 I/O Connectors	A-1
3500A I/O Connectors	A-2
3500 AUDIO Connector Pin-Out Table	A-3
3500A AUDIO Connector Pin-Out Table	A-4
3500 REMOTE Connector Pin-Out Table	A-5
3500A REMOTE Connector Pin-Out Table	A-6

THIS PAGE INTENTIONALLY LEFT BLANK.

SERVICE UPON RECEIPT OF MATERIAL

Unpacking

Special-design packing material inside this shipping carton provides maximum protection for the 3500 / 3500A. Avoid damaging the carton and packing material during equipment unpacking. Use the following steps for unpacking the 3500 / 3500A.

- Cut and remove the sealing tape on the carton top and open the carton.
- Grasp the 3500 / 3500A transit case firmly, while restraining the shipping carton, and lift the equipment and packing material vertically and place the 3500 / 3500A transit case and end cap packing on a suitable flat, clean and dry surface.
- Remove the protective plastic bag from the 3500 / 3500A transit case. Place protective plastic bag and end cap packing material inside shipping carton. Store the shipping carton for future use should the 3500 / 3500A need to be returned.

Checking Unpacked Equipment

- Inspect the equipment for damage incurred during shipment. If the equipment has been damaged, report the damage to Aeroflex.
- Check the equipment against the packing slip to see if the shipment is complete. Report all discrepancies to Aeroflex.

Checking Unpacked Equipment (cont)

STANDARD ITEMS

DESCRIPTION	PART NUMBER	QTY	MODEL
3500 Communications Test Set		1	3500 ONLY
3500A Communications Test Set		1	3500A ONLY
Adapter (BNC-F to TNC-M)	23758 (2200-0410-700)	5	3500 / 3500A
Antenna (BNC) (50 MHz)	9149 (1201-7617-001)	1	3500A ONLY
Antenna (BNC) (150 MHz)	9145 (1201-7616-801)	1	3500A ONLY
Antenna (BNC) (450 MHz)	9147 (1201-7616-901)	1	3500A ONLY
Antenna (BNC) (800 MHz)	9143 (1201-7616-001)	1	3500A ONLY
Cable (BNC) (M-M) (48 in)	62368 (6041-4284-400)	2	3500 / 3500A
Cable (TNC) (M-M) (48 in)	62398 (6041-5680-800)	1	3500 / 3500A
Case, Accessory	5763 (1000-6200-800)	1	3500 ONLY
Case, Accessory	5762 (1000-6200-700)	1	3500A ONLY
Case, Soft-Sided Carrying	10191 (1412-0006-006)	1	3500 ONLY
Case, Soft-Sided Carrying	10192 (1412-0006-007)	1	3500A ONLY
Comm Breakout Box	64598 (7005-6242-900)	1	3500 / 3500A
External DC Power Supply	67374 (7110-6200-200)	1	3500 / 3500A
Fuse, Spare (5 A, 32 Vdc, Type F)	56080 (5106-0000-057)	2	3500 / 3500A
Handset	64592 (7005-6240-200)	1	3500 ONLY
Handset Cable	62403 (6041-6280-000)	1	3500 ONLY
Handset	64606 (7005-6244-700)	1	3500A ONLY
Manual, Getting Started (Paper)	6107 (1002-6200-8P0)	1	3500 / 3500A
Manual, Operation/ICW (CD)	6105 (1002-6200-2C0)	1	3500 / 3500A
Power Cable (AC)	62302 (6041-0001-000)	1	3500 ONLY
Power Cable (AC) (3-wire leads)	27516 (23424/159)	1	3500A ONLY
Power Cable (AC) (Continental Europe)	27480 (23422/007)	1	3500A ONLY
Power Cable (AC) (North America)	27478 (23422/005)	1	3500A ONLY
Power Cable (AC) (UK)	27477 (23422/002)	1	3500A ONLY
Power Cable (DC Cigarette Lighter)	62404 (6041-6281-400)	1	3500 / 3500A
Short-Open-Load VSWR Calibrator (TNC)	38245 (2901-0000-054)	1	3500 / 3500A
USB Flash Drive (1 GB)	67327 (7110-1100-600)	1	3500A ONLY

Checking Unpacked Equipment (cont)

STANDARD ITEMS



Adapter (BNC-F to TNC-M)

(23758) (2200-0410-700)



Antenna (BNC) (50 MHz)

(9149) (1201-7617-001)



Antenna (BNC) (150 MHz)

(9145) (1201-7616-801)



Antenna (BNC) (450 MHz)

(9147) (1201-7616-901)



Antenna (BNC) (800 MHz)

(9143) (1201-7616-001)



BNC Cable (M-M) (48 in)

(62368) (6041-4284-400)



TNC Cable (M-M) (48 in)

(62398) (6041-5680-800)



Accessory Case (3500)

(5763) (1000-6200-800)

Checking Unpacked Equipment (cont)

STANDARD ITEMS



Accessory Case (3500A)
(5762) (1000-6200-700)



Soft-Sided Carrying Case
(10191) (1412-0006-006)



Soft-Sided Carrying Case
(10192) (1412-0006-007)



Comm Breakout Box
(64598) (7005-6242-900)



External DC Power Supply
(67374) (7110-6200-200)



Spare Fuse (5 A, 32 Vdc, Type F)
(56080) (5106-0000-057)



Handset (3500)
(64592) (7005-6240-200)



Handset Cable (3500)
(62403) (6041-6280-000)

Checking Unpacked Equipment (cont)

STANDARD ITEMS



Handset (3500A)

(64606) (7005-6244-700)

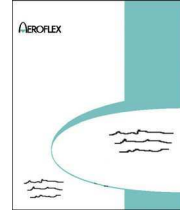

Getting Started Manual

(6107) (1002-6200-8P0)



Operation / ICW Manual

(61105) (1002-6200-2C0)



AC Power Cable

(62302) (6041-0001-000)



Power Cable (AC) (3 wire leads)

(27516) (23424/159)



Power Cable (AC) (Continental Europe)

(27480) (23422/007)



Power Cable (AC) (North America)

(27478) (23422/005)



Power Cable (AC) (UK)

(27477) (23422/002)

Checking Unpacked Equipment (cont)

STANDARD ITEMS



Power Cable (DC Cigarette Lighter)

(62404) (6041-6281-400)



VSWR Calibrator (TNC)

(38245) (2901-0000-054)



USB Flash Drive (1 GB)

(67327) (7110-1100-600)

Checking Unpacked Equipment (cont)

OPTIONAL ITEMS

(These optional items may be included if ordered)

DESCRIPTION	PART NUMBER	QTY	MODEL
Antenna (BNC) (50 MHz)	9149 (1201-7617-001)	1	3500 ONLY
Antenna (BNC) (150 MHz)	9145 (1201-7616-801)	1	3500 ONLY
Antenna (BNC) (450 MHz)	9147 (1201-7616-901)	1	3500 ONLY
Antenna (BNC) (800 MHz)	9143 (1201-7616-001)	1	3500 ONLY
Attenuator (20 dB / 50 W)	82559		3500 / 3500A
Attenuator (20 dB / 50 W)	38240 (2901-0000-049)	1	
Adapter (N-F to BNC-F)	23770 (2200-0412-800)	1	
Adapter (N-M to TNC-M)	23766 (2200-0412-400)	1	
Attenuator (20 dB / 150 W)	82560		3500 / 3500A
Attenuator (20 dB / 150 W)	38242 (2901-0000-051)	1	
Adapter (N-F to BNC-F)	23770 (2200-0412-800)	1	
Adapter (N-M to BNC-F)	20327 (2113-0000-004)	1	
Battery, Spare	67076 (7020-0012-500)	1	3500 / 3500A
Case, Transit	10242 (1412-6200-500)	1	3500 / 3500A
Desk Top Stand	63656 (6500-5681-000)	1	3500 / 3500A
Directional Coupler (20 to 200 MHz)	63964		3500 / 3500A
Directional Coupler (20 to 200 MHz)	47290 (4100-0900-000)	1	
Attenuator (10 dB)	38255 (2901-0401-010)	1	
Adapter (N-M to BNC-F)	20327 (2113-0000-004)	2	
Cable (BNC) (M-M) (16 in)	62405 (6041-6282-000)	2	
Flip Cover	63966 (7001-6242-100)	1	3500 / 3500A
Maintenance Manual (CD)	6108 (1002-6201-4C0)	1	3500 / 3500A
Tripod	67474 (7112-8102-500)	1	3500 / 3500A
Tripod and Stand with Dolly	82553	1	3500 / 3500A
Tripod	67474 (7112-8102-500)		
Tripod Stand	63659 (6500-5881-100)		
Dolly	6361 (1005-1000-000)		

Checking Unpacked Equipment (cont)

OPTIONAL ITEMS



Antenna (BNC) (50 MHz)
(9149) (1201-7617-001)



Antenna (BNC) (150 MHz)
(9145) (1201-7616-801)



Antenna (BNC) (450 MHz)
(9147) (1201-7616-901)



Antenna (BNC) (800 MHz)
(9143) (1201-7616-001)



20 dB / 50 W Attenuator
(38240) (2901-0000-049)



20 dB / 150 W Attenuator
(38242) (2901-0000-051)



Adapter (N-M to TNC-M)
(23766) (2200-0412-400)



Adapter (N-M to BNC-F)
(20327) (2113-0000-004)



Adapter (N-F to BNC-F)
(23770) (2200-0412-800)



Spare Battery
(67076) (7020-0012-500)

Checking Unpacked Equipment (cont)

OPTIONAL ITEMS



Transit Case

(10242) (1412-6200-500)



Directional Coupler

(47290) (4100-0900-000)



10 dB Attenuator

(38255) (2901-0401-010)



BNC Cable (M-M) (16 in)

(62405) (6041-6282-000)



Desk Top Stand

(63656) (6500-6242-100)



Flip Cover

(63966) (7001-6242-100)



Maintenance Manual

(6108) (1002-6201-4C0)



Tripod

(67474) (7112-8102-500)

Checking Unpacked Equipment (cont)

OPTIONAL ITEMS



Tripod / Stand / Dolly

**(67474) (7112-8102-500) / (63659) (6500-5881-100) /
(6361) (1005-1000-000)**

CHAPTER 1 - INTRODUCTION

1-1. GENERAL INFORMATION

A. Scope

Type of Manual: Operation Manual
Equipment Name and Model Number: 3500 / 3500A Communications Test Set
Purpose of Equipment: The 3500 / 3500A Communications Test Set is used for testing radios and related equipment.

B. Nomenclature Cross-Reference List

<u>COMMON NAME</u>	<u>OFFICIAL NOMENCLATURE</u>
3500 / 3500A	3500 / 3500A Communications Test Set
Test Set or Unit	3500 / 3500A Communications Test Set

1-2. EQUIPMENT CAPABILITIES AND FEATURES

The 3500 / 3500A is a Handheld Communications Test Set for Radio installation testing. The 3500 / 3500A is capable of measuring high power, up to 200 W, as well as fault finding for antennas, power amplifiers and interconnects. The 3500 / 3500A meets the needs of a variety of vehicular radios, as well as commercial radio applications.

The 3500 / 3500A is designed for ease of use, portability, reliability and long service life. The 3500 / 3500A may also be used for bench testing in the General Communications environment.

Power is derived from an internal battery. For DC input, the DC IN Connector is provided for battery charging, bench operation or servicing.

The 3500 / 3500A and supplied accessories are stored in a Soft Carrying Case or a Transit Case.

A. Capabilities

Capabilities

- RF Receiver Testing - Up to 1 GHz bandwidth; AM, FM, frequency and level measurements.
- RF Generator Testing - Up to 1 GHz bandwidth; AM, FM, 1 kHz / 150 Hz and external modulation sources.
- RF Power Meter - 20 W intermittent duty cycle; 200 W with an external attenuator.
- VSWR measurements.
- Simple operation with few key strokes and textual displays.
- Large LCD Display with user adjustable Backlight and Contrast.
- Self Test and Diagnostics for internal validation and testing.
- Internal Battery allows 6 hours intermittent use, 5 hours continuous use before recharge.
- Automatic power shutdown after approximately 5 to 20 minutes (selectable) of non-use when AC power is not connected.
- Compact and lightweight enough to allow for one person operation.

B. Features

Features

- System Menu
 - Duplex Test Screen
 - Receiver Test Screen
 - Transmitter Test Screen
 - ANT-Cable Test Screen
 - Audio Function Generator Test Screen
- Meters Menu
 - SINAD Meter Screen
 - Distortion Meter Screen
 - AF Counter Screen
 - Audio Level Meter Screen
- Self Test Menu
 - Self Test Screen
 - Diagnostic Screen
 - Calibration Screen
- Utilities Menu
 - Annunciator Screen
 - Remote Screen
 - Version Screen
 - Date/Time Screen
 - HW Config Screen
 - Options Screen
 - USB Manager Screen
 - Unit Copy Screen

Optional Features

- Spectrum Analyzer Screen
- Oscilloscope Screen
- Tracking Generator
- P25 Test
- DMR
- NXDN
- dPMR
- ARIBT98
- Scripting

1-3. EQUIPMENT DATA (cont)

RF GENERATOR MODULATION - FM

Modulation Frequency (Rate) - AM and FM:

Range:0 Hz to 20 kHz

Resolution: 0.1 Hz

Accuracy: Timebase ± 2 Hz

Modulation Waveforms - AM and FM Sine, DCS, DTMF

FM Deviation Range: Off, 0 Hz to 100 kHz (AFGEN1 and AFGEN2 selectable)

Total Harmonic Distortion: 3% (1000 Hz Rate, >2 kHz Deviation, 300 Hz to 3 kHz BPF)

FM Deviation Resolution: 10 Hz

FM Deviation Accuracy: $\pm 10\%$ (2 to 50 kHz deviation, 150 Hz to 5 kHz rate)

MIC IN (3500):

Microphone Input: 1 to 30 mVrms

FM Input Frequency Range: 400 Hz to 1.2 kHz

FM Input Slope: Positive voltage yields positive deviation

MIC IN (3500A):

Microphone Input: 2 to 15 mVrms (8 mVrms nominal) (Range 1)
35 to 350 mVrms (100 mVrms nominal) (Range 2)
2 to 32 mVrms (20 mVrms nominal) (Range 3)

FM Input Frequency Range: 300 Hz to 3 kHz

FM Deviation: Off, 0 Hz to 80 kHz

FM Modulation Accuracy: $\pm 20\%$ (300 Hz to 1.2 kHz)
 $\pm 30\%$ (>1.2 kHz)

FM Input Slope: Positive voltage yields positive deviation

Ext AUDIN Input:

Switchable Loads: 150 Ω , 600 Ω , High Z (3500)
150 Ω , 600 Ω , 1 K Ω , High Z (3500A)

Input Levels: 0.05 to 3 Vrms

FM Input Frequency Range: 300 Hz to 5 kHz

FM Input Level Sensitivity: 1 kHz / 35 mVrms nominal (High Z Load)

FM Input Slope: Positive voltage yields positive deviation

1-3. EQUIPMENT DATA (cont)

RF GENERATOR MODULATION - AM

Modulation Frequency (Rate) - AM and FM:

Range:0 Hz to 20 kHz

Resolution: 0.1 Hz

Accuracy: Timebase ± 2 Hz

AM Modulation:

Range: OFF, 0% to 100% (AFGEN1 and AFGEN2 selectable)

Resolution: 0.1%

Accuracy: 10% of setting, 150 Hz to 5 kHz rate, 10% to 90% Modulation

Total Harmonic Distortion: 3% (20% to 90% mod, 1000 Hz rate, 300 Hz to 3 kHz BPF)

Ext AUDIN Input:

Switchable Loads: 150 Ω , 600 Ω , High Z (3500)
150 Ω , 600 Ω , 1 K Ω , High Z (3500A)

Input Levels: 0.05 to 3 Vrms

AM Input Frequency Range: 300 Hz to 5 kHz

AM Input Level Sensitivity: 1% / 35 mVrms nominal (High Z Load)

MIC IN (3500):

AM Input Frequency Range: 400 Hz to 1.2 kHz

MIC IN (3500A):

Microphone Input: 2 to 15 mVrms (8 mVrms nominal) (Range 1)
35 to 350 mVrms (100 mVrms nominal) (Range 2)
2 to 32 mVrms (20 mVrms nominal) (Range 3)

AM Input Frequency Range: 300 Hz to 3 kHz

AM Modulation: Off, 0 Hz to 80 kHz

AM Modulation Accuracy: $\pm 20\%$ (300 Hz to 1.2 kHz)
 $\pm 30\%$ (>1.2 kHz)

1-3. EQUIPMENT DATA (cont)

AUDIO GENERATORS (AFGEN1 AND AFGEN2)

NOTE

If two sources are selected, they are summed together. AFGEN1 and AFGEN2 may be routed to the external AUD Out connection on the handset. Specifications are for each FGEN individually.

Frequency Range:30 Hz to 5 kHz
0 to 20 kHz (operational)
Frequency Resolution: 0.1 Hz
Frequency Accuracy: Timebase ± 2 Hz
Output Level:
Load Impedance: 600 Ω
Audio Level Out: 0 to 1.57 Vrms
Resolution: 0.01 Vrms
Accuracy: $\pm 10\%$
Distortion: $<3\%$ (1 kHz rate, sine 300 Hz to 3 kHz)

HANDSET (PROVIDED) OR H-250 HANDSET WITH ADAPTER

Frequency: 300 Hz to 1.2 kHz
Input Level: 0.03 to 8 Vrms

PTT OPERATION

NOTE

PTT ON / OFF changes between TRANSMITTER TEST and RECEIVER TEST.

PTT ON: Low, GND
PTT OFF: High, Open with Pullup

1-3. EQUIPMENT DATA (cont)

RF RECEIVER

FREQUENCY RANGE: 2 to 1000 MHz

ACCURACY:..... Timebase

RESOLUTION:..... 1 Hz

INPUT AMPLITUDE

Minimum Input Level (Audio Sensitivity):

ANT Connector: -80 dBm typical, 10 dB SINAD / 22.4 μ V (-110 dBm with Preamp)

T/R Connector: -40 dBm typical, 10 dB SINAD, 2236 μ V

Useable Input Level Range (Receiver Measurements):

ANT Connector: -60 to -10 dBm (RF Error, Distortion, Modulation, AF Counter)
-80 to -10 dBm with Preamp ON
-90 to -10 dBm (RSSI)
-110 to -10 dBm with Preamp ON

Minimum Input Level (Receiver Measurements)

T/R Connector: -20 dBm (RF Error, Distortion, Modulation, AF Counter)
-50 dBm (RSSI)

Maximum Input Level:

ANT Connector: +20 dBm for 10 seconds, Alarm sounds

T/R Connector: +37 dBm (AM)
+43 dBm (FM)

NOTE

Overtemp Alarm trips if the power is left on too long and the temperature of the Power Termination gets too hot.

FM Demod Output (AUD OUT):

IF BW: 5, 6.25, 8.33, 10, 12.5, 25, 30, 100 and 300 kHz IF BW

Audio Filters BW: C-Wt BP, CCITT BP, NONE, 15 kHz LP, 300 Hz LP,
300 Hz HP, 5 kHz LP, 300 Hz to 5 kHz BP, 300 Hz to 3 kHz BP,
300 Hz to 20 kHz BP and 3 kHz LP

Level Sensitivity:.....(3 Vrms/kHz Dev) / IF BW (kHz) \pm 15%

AM Demod Output (AUD OUT):

IF BW: 5, 6.25, 8.33, 10, 12.5, 25 and 30 kHz

Audio Filters BW: C-Wt BP, CCITT BP, NONE, 15 kHz LP, 300 Hz LP,
300 Hz HP, 5 kHz LP, 300 Hz to 5 kHz BP, 300 Hz to 3 kHz BP,
300 Hz to 20 kHz BP and 3 kHz LP

Level Sensitivity:..... 7 mVrms / %AM \pm 15%

Speaker Output: 75 dBa minimum at 0.5 m, 600 to 1800 Hz, maximum volume

Volume Control: Level Range, Scale 0 to 100

LO Emissions:..... >-50 dBc

Quieted Channels: 10 frequencies allowed between 2 and 999.999 MHz, quieted by \leq 30 dB

1-3. EQUIPMENT DATA (cont)

DUPLEX

NOTE

Duplex Test is Receiver and Transmitter Tests simultaneously. Performance parameters are the same as the independent Receiver and Transmitter Test Screens.

RF TRANSMITTER TEST METERS

RF ERROR METER

Meter Operating Range: ± 200 kHz
Resolution: 1 Hz
Accuracy: Timebase ± 2 Hz

RSSI METER (RF Power within Receiver IF BW)

Display Range / Units: -120 to +43 dBm (10 pW to 20 W)
-120 to +53 dBm (10 pW to 200 W) (Ext Atten set to 20 dB)

Useable Meter Reading - RF Level Range:

ANT Connector: -90 to -10 dBm
-110 to -10 dBm (Preamp ON)

T/R Connector: -50 to +43 dBm

Resolution: 0.01 dBm

Accuracy: ± 3 dB

RF POWER METER (Broadband RF Power into T/R Connector)

Display Range / Units: 0 to +43 dBm (0 to 20 W)
0 to +53 dBm (0 to 200 W) (Ext Atten set to 20 dB)

Minimum Input Level (w/ dBm): 0.10 W / +20 dBm

Maximum Input Level: +43 dBm / 20 W for 10 minutes at +25°C
or until Thermal Alarm sounds (whichever occurs first)

Alarms: +44 dBm for 5 seconds ON, 5 minutes OFF
or until Thermal Alarm sounds (whichever occurs first)

Meter Modes: Average Power

Display Units: W or dBm (selectable)

Resolution: 0.01 (W), 0.1 (dBm)

Accuracy

No External Attenuator: ± 1 dB for internal attenuator

With External Attenuator: ± 1 dB \pm external attenuator accuracy

NOTE

When External Attenuator is selected, 20 dB is added to the measurements of 50 or 200 W.

1-3. EQUIPMENT DATA (cont)

RF POWER METER (Broadband RF Power into T/R Connector) (cont)

External 20 dB Attenuator Accuracy

50 W Attenuator: ±0.75 dB

150 W Attenuator: ±0.50 dB

External 20 dB Attenuator Power Rating:

50 W Attenuator - 20 dB: 50 W average at 25°C

150 W Attenuator - 20 dB: 150 W average for temperatures up to 25°C,
linearly de-rated to 125 W at 55°C, horizontal
200 W peak for 30 seconds ON/ 5 minutes OFF at 25°C

FM DEVIATION METER

Meter Deviation Range: 500 Hz to ±100 kHz

Meter Modes: Peak+, Peak-, (Peak-Peak)/2

Resolution: 1 Hz

Accuracy: ±10% (500 Hz to 100 kHz Deviation)
±5% (1 to 10 kHz Deviation)
150 Hz and 1 kHz Rate

AM MODULATION METER

Meter Range: 5% to 100%

Meter Modes: Peak+, Peak-, (Peak-Peak)/2

Resolution: 1%

Accuracy: ±5% of reading, 1 kHz rate, 30% to 90% modulation, 3 kHz LPF

SWR MEASUREMENT

FREQUENCY

Range: 2 to 1000 MHz

Calibration and Sweep Bandwidth: 2 to 1000 MHz, 0.1 MHz Resolution

SWR READING

Display Range: 1.00 to 7.00

Resolution: 0.01

Accuracy: ±10% of SWR readings (calibrated) <300 MHz
±20% of SWR readings (calibrated) >300 MHz

DTF READING

Test Range: 3 to 328 ft (1 to 100 m)

Display Range: 40 to 400 ft
(Range is function of Frequency Span and Cable Velocity Factor and Cable Loss)

Accuracy: ±3 ft

1-3. EQUIPMENT DATA (cont)

AUDIO METERS

AUDIO INPUT (EXT AUD IN) (BNC Input on Handset)

EXT AUD IN Input :

Frequency Range: 300 Hz to 10 kHz (1 kHz for SINAD and Distortion Meters)

Input Level (3500): 50 to 1.5 mVrms

Input Level (3500A): 0.2 to 5 Vp-p

SINAD METER

Measurement Sources: EXT AUD IN, DEMOD

Audio Frequency Notch: 1 kHz

Reading Range: 0 to 40 dB

Resolution: 0.1 dB

Accuracy: ± 1.5 dB, reading >8 dB, <40 dB, ± 1 Count

DISTORTION METER

Measurement Sources: EXT AUD IN, DEMOD

Audio Frequency Notch: 1 kHz

Reading Range: 0% to 100%

Resolution: 0.1%

Accuracy: $\pm 10\%$, reading $>1\%$, $<20\%$, ± 1 Count

AF COUNTER

Input Dynamic Range:

FM: 15 Hz to 20 kHz (IF BW set appropriately for received modulation BW)

AM: 100 Hz to 10 kHz (IF BW set appropriately for received modulation BW)

Baseband Audio In: 10 mVp-p to 5 Vp-p

Audio Input Range: 15 Hz to 20 kHz

Ext Audio Input: 10 mVrms to 1.5 Vrms

Resolution: 0.1 Hz

Accuracy: ± 1 Hz

AUDIO FREQUENCY LEVEL METER

Measurement Sources: EXT AUD IN, DVM

Frequency Range: 200 Hz to <5 kHz

Input Level:

EXT AUD IN (3500): 10 mVrms to 1.5 Vrms

EXT AUD IN (3500A): 10 mVrms to 3 Vrms (x1), 1 Vrms to 30 Vrms ($\div 10$)

DVM (3500): 1 Vrms to 30 Vrms ($\div 20$)

DVM (3500A): 10 mVrms to 3 Vrms (x1), 1 Vrms to 30 Vrms ($\div 20$)

Display Unit Resolution: 0.001 V, 0.001 mV, 0.001 dB μ V, 0.001 dBm, 0.001 W

Accuracy: $\pm 5\%$ (EXT AUD IN)

1-3. EQUIPMENT DATA (cont)

OSCILLOSCOPE (OPTIONAL)

Single Input Channels:DVM, Audio In, Internal Demod
Input Impedance:
DVM Input: 1 M Ω
Audio I/O Input: 150 Ω , 600 Ω , High Z (3500)
150 Ω , 600 Ω , 1 K Ω , Divide-by-10, High Z (3500A)
Coupling:
DVM Input: AC, DC and GND
Audio I/O Input: AC
FM Internal Demod: DC
AC Internal Demod: AC
Range:
DVM and Audio I/O Output: 10 mV/Div to 10 V/Div in a 1,2,5 sequence
FM Internal Demodulation: 0.1 kHz/Div to 50 kHz/Div in a 1,2,5 sequence
AM Internal Demodulation: 5%, 10%, 20%, 50%/Div
Vertical Accuracy: 10% of Full Scale (DC to 5 kHz)
Bandwidth: 5 kHz
Horizontal Sweep:
Range: 0.5 ms/Div to 0.1 sec/Div
Accuracy: 3% of Full Scale
Trigger Source: Auto or Normal (Internal)
Trigger Adjustment: Variable on Vertical Scale
Markers: Two Markers
Displays Vertical Measurement (Voltage, kHz, % Modulation)
Displays Delta in Time between Markers

SPECTRUM ANALYZER (OPTIONAL)

Frequency:
Range: 2 MHz to 1 GHz
Span: 10 kHz to 5 MHz in a 1,2,5 sequence
Windows: Hanning, Flat Top, Rectangle
Vertical Scale: 2, 5, 10, 15, 20 dB/Div
Marker Range: 1 kHz to 5 MHz in a 1,2,5 sequence
Marker Offset: ± 1 kHz to 0.5 Span in a 1,2,5 sequence
Power Bandwidth Accuracy: ± 3 dB Typical (30 dB Signal to Noise)
Noise Floor: ± 3 dB Typical (30 dB Signal to Noise)

1-3. EQUIPMENT DATA (cont)

TIMEBASE

STANDARD OSCILLATOR

Temperature Stability:..... ± 0.25 ppm at 25°C
 ± 0.5 ppm over temperature range
Aging: 1 ppm / year
Warmup Time: 3 minutes

ENVIRONMENTAL / PHYSICAL

OVERALL DIMENSIONS: 231 mm (9.1 in) (W), 285 mm (11.2 in) (L), 70 mm (2.8 in) (D)

WEIGHT: 8.5 lbs.; 12 lbs with accessories and soft carrying case

TEMPERATURE

Storage: -51°C to +71°C

NOTE

Battery must not be subjected to temperatures below -20°C, nor above +60°C.

Operation: -20°C to +50°C

NOTE

Battery is to be charged at 0°C to +45°C.

HUMIDITY

Storage: MIL-PRF-28800F, Class 2

Operation: MIL-PRF-28800F, Class 2

ALTITUDE

Operation: MIL-PRF-28800F, Class 2

SHOCK

Operation: MIL-PRF-28800F, Class 2

BENCH HANDLING

Operation: MIL-PRF-28800F, Class 2

VIBRATION

Operation: MIL-PRF-28800F, Class 2

COMPLIANCE

USE: Pollution Degree 2

EMC: MIL-PRF-28800F, Class 2

AC INPUT POWER

AC Input Voltage Range: 100 to 240 VAC, 1.5 A maximum, 47 Hz to 63 Hz

AC Input Voltage Fluctuation: <10% of the nominal input voltage

Transient Overvoltage: According to Installation Category II

1-3. EQUIPMENT DATA (cont)

AC-DC CONVERTER

Usage Environment:..... Indoor use, Pollution Degree 2
Operating Temperature: 0°C to +40°C
Storage Temperature: -20°C to +85°C
EMI:..... EN55022 Class B, EN61000-3-2 Class D
Safety: UL 1950, CSA 22.2 No. 234 and No.950, IEC 950/EN 60950

DC INPUT CONNECTOR (DC IN)

DC Input Voltage Range:..... 11 to 32 Vdc
DC Power Input:
Maximum:..... 55 W
Nominal:..... 25 W
DC Fuse Requirement: 5 A, 32 Vdc, Type F

BATTERY

Battery Type:Lithium Ion (Li Ion) Battery pack

NOTE

Battery must not be subjected to temperatures below -20°C, nor above +60°C.

Operation Time: 5 hours continuous use
Charge Time: 4 hours

NOTE

Battery is to be charged at 0°C to +45°C. Dead Battery (<10% capacity) is to be charged for 20 minutes before operation on AC Power.

STATIC THERMAL CHARACTERISTICS

Ambient, Power ON, RF Power OFF:..... <15°C rise after 30 minutes
Ambient, Power ON, RF Power ON: <25°C rise after 30 minutes

1-4. PRINCIPLES OF OPERATION

The 3500 contains the following assemblies:

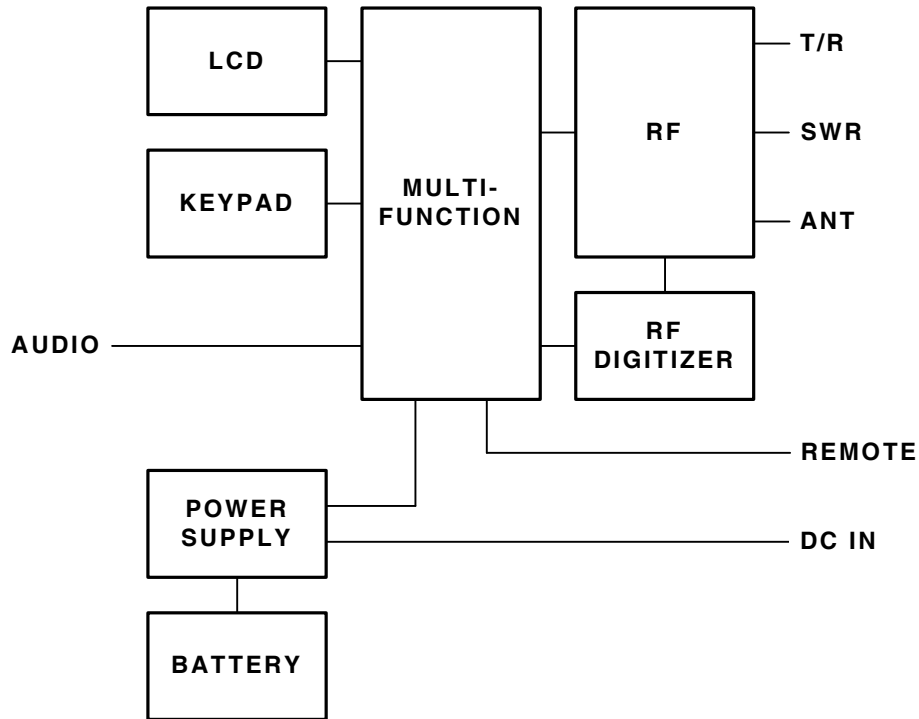

The **Power Supply PCB Assy** is responsible for supplying power to the internal modules for operation and for charging the internal batteries.

The **RF Digitizer PCB Assy** converts the baseband signal to a modulated 10.5 MHz Tx IF which is upconverted in the RF Assy to provide an RF Generator output. The Receive signals are down-converted to 13 MHz and demodulated to baseband signals.

The **Multi-Function PCB Assy** includes the processors, FPGA and memory to send data from the RF Digitizer PCB Assy through the Power PC to the ColdFire for display on the LCD Display. Keyboard inputs are processed to provide instructions to the RF Assy.

The **RF Assy** consists of the RF Controller PCB Assy and the RF Converter PCB Assy. The RF Converter PCB Assy converts the 10.5 MHz TX IF to the 2 MHz to 1 GHz RF and from the 2 MHz to 1 GHz receiver input to the 13 MHz RX IF. The RF Converter PCB Assy also contains the VSWR coupler and associated circuitry and the Power Termination. The RF Controller PCB Assy provides the TCXO, LOs and digital circuitry necessary for software control and for tuning and level control.

1-4. PRINCIPLES OF OPERATION (cont)

The 3500A contains the following assemblies:

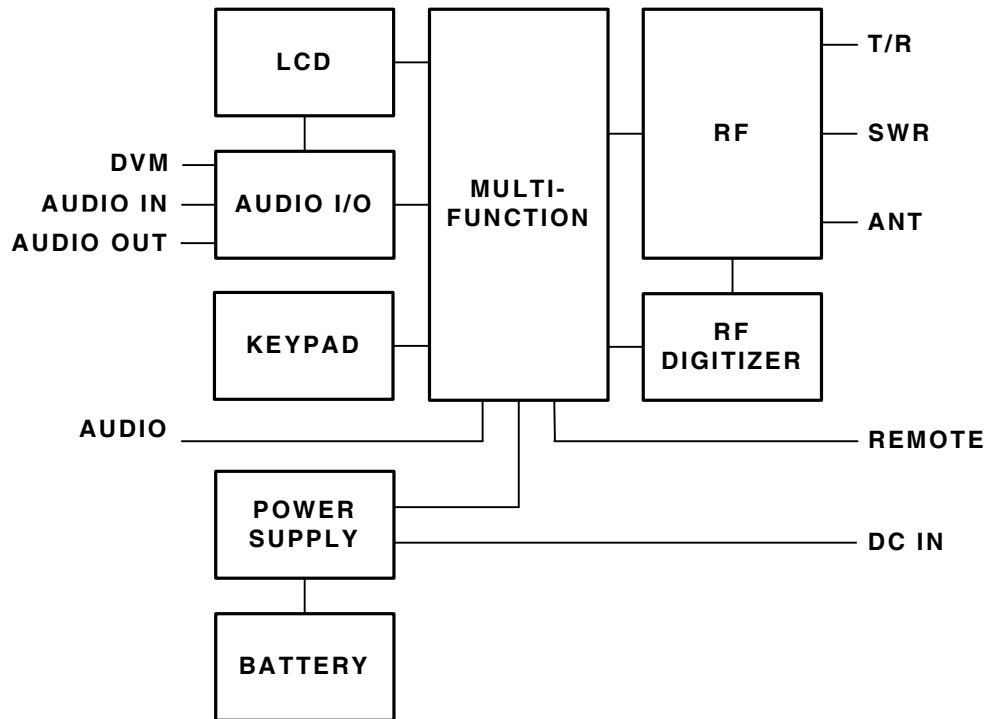

The **Power Supply PCB Assy** is responsible for supplying power to the internal modules for operation and for charging the internal batteries.

The **RF Digitizer PCB Assy** converts the baseband signal to a modulated 10.5 MHz Tx IF which is upconverted in the RF Assy to provide an RF Generator output. The Receive signals are down-converted to 13 MHz and demodulated to baseband signals.

The **Multi-Function PCB Assy** includes the processors, FPGA and memory to send data from the RF Digitizer PCB Assy through the Power PC to the ColdFire for display on the LCD Display. Keyboard inputs are processed to provide instructions to the RF Assy.

The **RF Assy** consists of the RF Controller PCB Assy and the RF Converter PCB Assy. The RF Converter PCB Assy converts the 10.5 MHz TX IF to the 2 MHz to 1 GHz RF and from the 2 MHz to 1 GHz receiver input to the 13 MHz RX IF. The RF Converter PCB Assy also contains the VSWR coupler and associated circuitry and the Power Termination. The RF Controller PCB Assy provides the TCXO, LOs and digital circuitry necessary for software control and for tuning and level control.

The **Audio I/O PCB Assy** provides the DVM/Scope, Audio In and Audio Out signals to the 3500A Front Panel.

CHAPTER 2 - OPERATING INSTRUCTIONS

2-1. OPERATOR'S CONTROLS, INDICATORS AND CONNECTORS

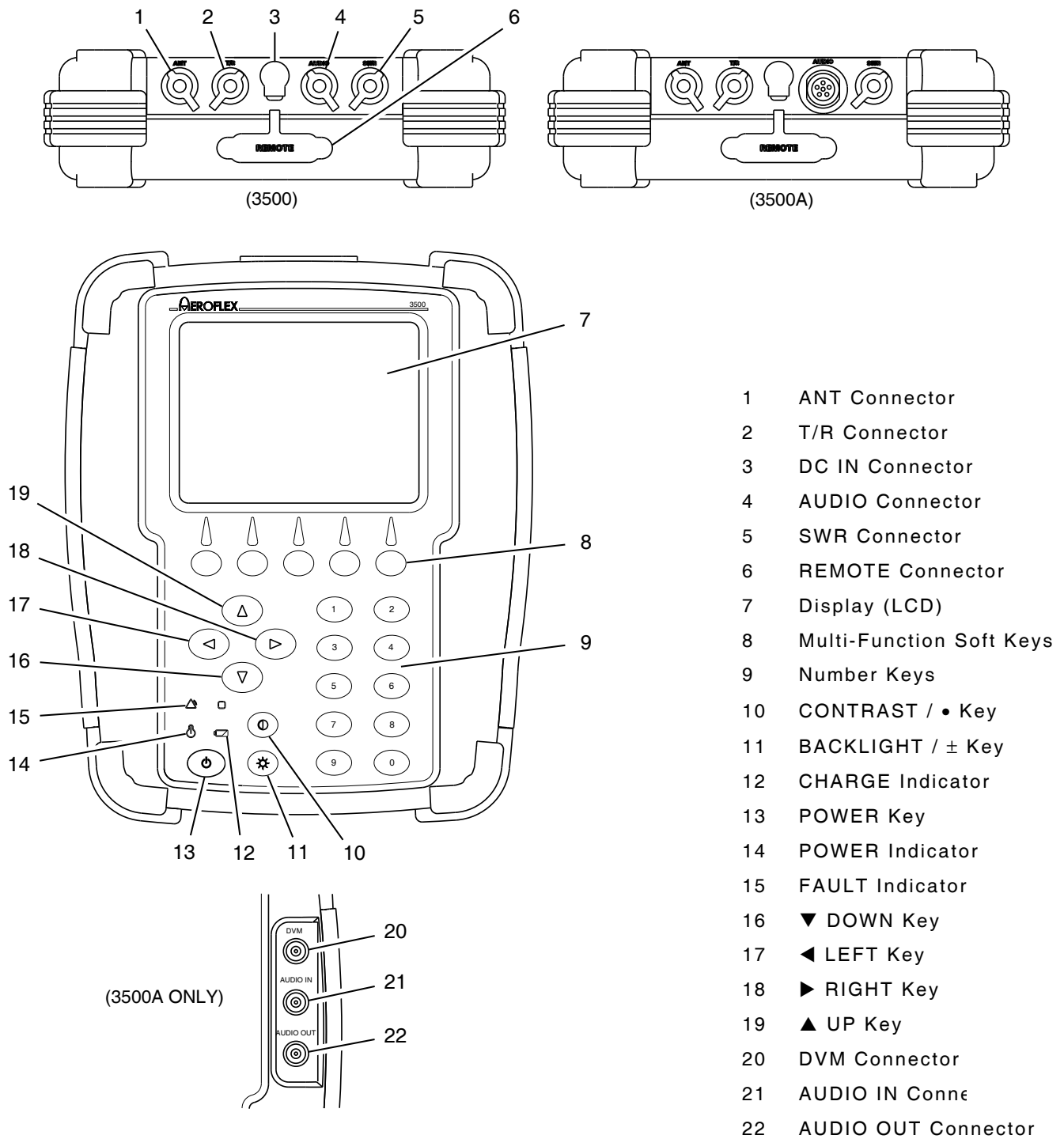

Figure 2-1. Controls, Connectors and Indicators

2-1. OPERATOR'S CONTROLS, INDICATORS AND CONNECTORS (cont)

ITEM	DESCRIPTION
◀ LEFT Key	Used to move the on-screen cursor from one frame to another. Also used to move the on-screen cursor to the next digit to the left in an edit field. NOTE: The on-screen cursor moves in a fixed order. This is to ensure that all frames and fields are accessed in a predictable fashion.
▶ RIGHT Key	Used to move the on-screen cursor from one frame to another. Also used to move the on-screen cursor to the next digit to the right in an edit field. NOTE: The on-screen cursor moves in a fixed order. This is to ensure that all frames and fields are accessed in a predictable fashion.
▲ UP Key	Used to move the on-screen cursor from one field to another within a frame. Also used to increment an edit field. NOTE: The on-screen cursor moves in a fixed order. This is to ensure that all frames and fields are accessed in a predictable fashion.
▼ DOWN Key	Used to move the on-screen cursor from one field to another within a frame. Also used to decrement an edit field. NOTE: The on-screen cursor moves in a fixed order. This is to ensure that all frames and fields are accessed in a predictable fashion.
AUDIO Connector	Used for connection to the Microphone.
AUDIO IN Connector (3500A only)	Used to receive external modulation input, and as input for the SINAD and Distortion Meters and AF Counter.
AUDIO OUT Connector (3500A only)	Used as output for Demod and Function Generators and for Audio In signal output.
ANT Connector	Used for over-the-air tests.
BACKLIGHT / ± Key	Used for selecting the Backlight Adjust Mode. The ▲ UP or ▼ DOWN Keys may be used to adjust the Backlight level to one of 25 different settings. Used to change between positive (+) and negative (-) values during data entry.
CHARGE Indicator	Illuminates when external DC power is applied: GREEN Battery at Full Charge YELLOW Battery is Charging RED Battery Charge Failure
CONTRAST / • Key	Used for selecting the Contrast Adjust Mode. The ▲ UP or ▼ DOWN Keys may be used to adjust the Contrast level to one of 25 different settings. Used to add a decimal point (•) to values during data entry.

2-1. OPERATOR'S CONTROLS, INDICATORS AND CONNECTORS (cont)

ITEM	DESCRIPTION
DC IN Connector	Used for operation of the 3500 / 3500A or battery charging.
Display (LCD)	Used for viewing menus and screens. Soft Key boxes appear at the bottom of the menus/screens.
DVM Connector (3500A only)	Provides DC coupled input for the Audio Level Meter and the Oscilloscope (Option) functions.
FAULT Indicator	Illuminates when a fault exists in the 3500 / 3500A: YELLOW Caution Condition exists RED Warning Condition exists
Multi-Function Soft Keys	Five Soft Keys are provided. The legends are displayed in boxes at the bottom of the Display.
Number Keys	Used for data entry or to select a numbered item. Alternate key functions are utilized when selecting file names in the Save Screen.
POWER Indicator	Illuminates when the 3500 / 3500A is powered up.
POWER Key	Used for powering the 3500 / 3500A ON and OFF.
REMOTE Connector (External I/O)	Used for communicating with external equipment.
SWR Connector	Used for measuring the VSWR of Antenna systems. Also used as a transmit signal output.
T/R Connector	Used for high power direct connection to radio equipment.

2-1. OPERATOR'S CONTROLS, INDICATORS AND CONNECTORS (cont)



Figure 2-2. Comm Breakout Box Connectors

CONNECTOR	FUNCTION
USB HOST Connector	Used to connect to external unit.
RS-232 Connector	Used to connect to RS-232 external unit.
ETHERNET Connector	Used to connect to an external unit.
REMOTE Connector	Used for communicate with the 3500 / 3500A.

2-2. OPERATION SCREENS AND MENU CONFIGURATIONS

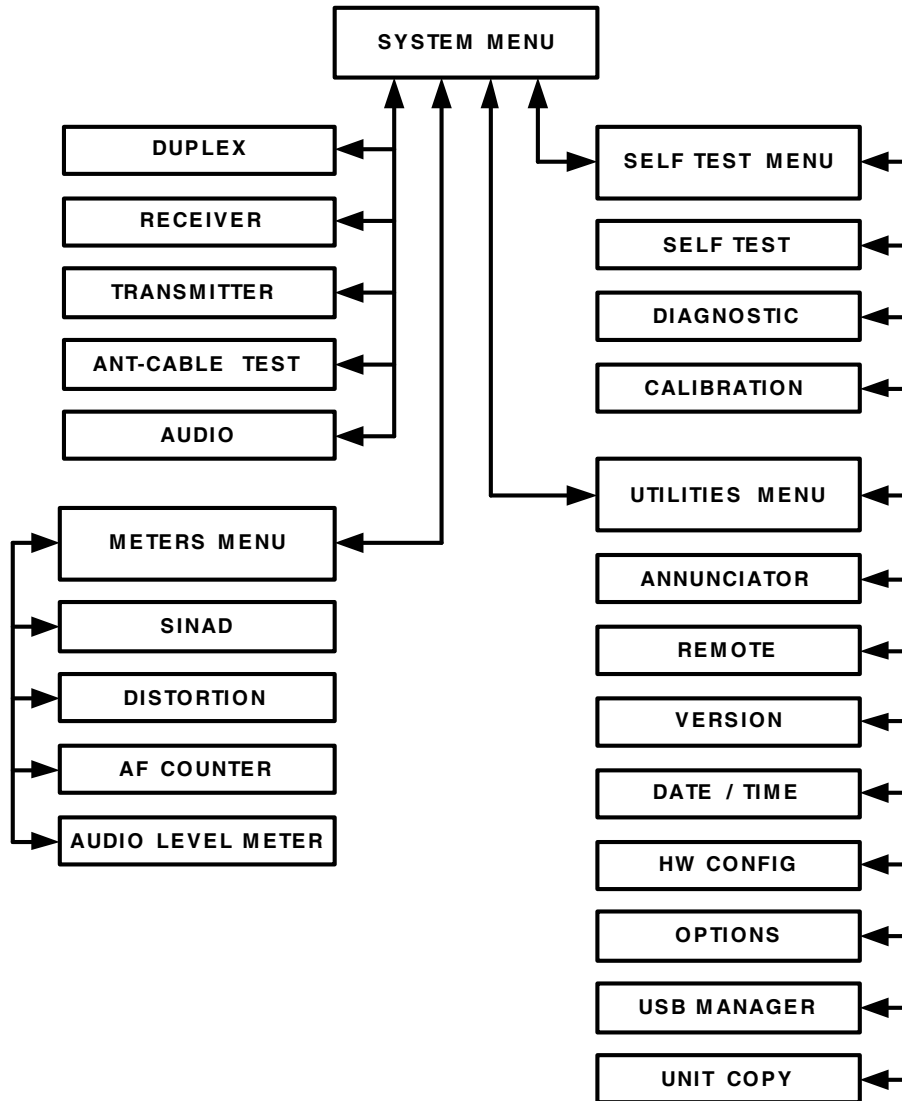
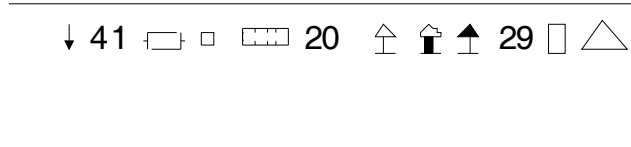





Figure 2-3. Menu / Screen Hierarchy





2-2-1. SCREEN ICONS

The screen icons are displayed at the top left of the test screens.



SCREEN FEATURE	FUNCTION
	<p>PPC CPU Usage</p> <p>Displays the level of PPC usage.</p> <p>When the PPC usage is 20% to 39%, the icon is displayed as vertical bar.</p> <p>When the PPC usage is 40% to 59%, the icon is displayed as two vertical bars.</p> <p>When the PPC usage is 60% to 79%, the icon is displayed as three vertical bars.</p> <p>When the PPC usage is 80% to 100%, the icon is displayed as four vertical bars. The icon blinks when the PPC usage is >90%.</p>
<p>NUMBER</p>	<p>Internal Temperature</p> <p>Displays the current FPGA temperature in °C. (Example: 41)</p> <p>When the internal temperature is <-20°C or >85°C, a warning message is displayed.</p>
	<p>Flash Save Status</p> <p>Displays the status of a save operation.</p> <p>When the icon is fully drawn, all settings are currently saved to Flash. After editing, the lower right half of the icon disappears until the settings are saved to Flash.</p>
	<p>Phase Loop Lock (PLL)</p> <p>Displays the status of the Generator and Receiver Synthesizer Lock.</p> <p>Under normal conditions, the icon is displayed as a square.</p> <p>If the Generator becomes unlocked, a warning message is displayed and a triangle shape is displayed (blinking) above the square icon.</p> <p>If the Receiver becomes unlocked, a warning message is displayed and a triangle shape is displayed (blinking) below the square icon.</p>
	<p>Battery Level Indicator</p> <p>Displays the percentage of the battery life remaining.</p> <p>When the battery level is <20 (on a 0 to 100 scale) the battery level icon blinks.</p>

2-2-1. SCREEN ICONS (cont)

SCREEN FEATURE	FUNCTION
NUMBER	<p>Battery Temperature</p> <p>Displays the Battery temperature in °C. (Example: 20)</p> <p>If the battery temperature is >53°C a warning message is displayed and the battery level icon blinks.</p>
	<p>ANT Connector Overload</p> <p>Indicates if the ANT Connector is in overload mode.</p> <p>If the ANT Connector is in overload mode, a warning message is displayed and the lower half of the icon blinks.</p>
	<p>T/R Connector Overload</p> <p>Indicates if the T/R Connector is in overload mode.</p> <p>If the T/R Connector is in overload mode, a warning message is displayed and the lower half of the icon blinks.</p>
	<p>SWR Connector Overload</p> <p>Indicates if the SWR Connector is in overload mode.</p> <p>If the SWR Connector is in overload mode, a warning message is displayed and the lower half of the icon blinks.</p>
NUMBER	<p>RF Temperature</p> <p>Displays the T/R Connector temperature in °C. (Example: 29)</p> <p>The RF temperature increases when more RF power is dissipated.</p>
	<p>AGC Compression</p> <p>Displays the level of Receiver compression.</p> <p>With no AGC compression the icon is displayed as a box.</p> <p>When AGC is in compression, a message is displayed and the icon is displayed as an hourglass.</p>
	<p>DVM Overload</p> <p>Displays the DVM Overload status.</p> <p>When conditions are normal the icon is displayed as a triangle.</p> <p>When an overload occurs, a message is displayed, the icon is displayed as a lightning bolt inside a triangle and the icon blinks.</p>

2-2-2. SYSTEM MENU

When the unit is powered ON, the System Menu is displayed, or when the Meters Menu, Self Test Menu or Utilities Menu is displayed, press the F3 “System” Key to access the System Menu:

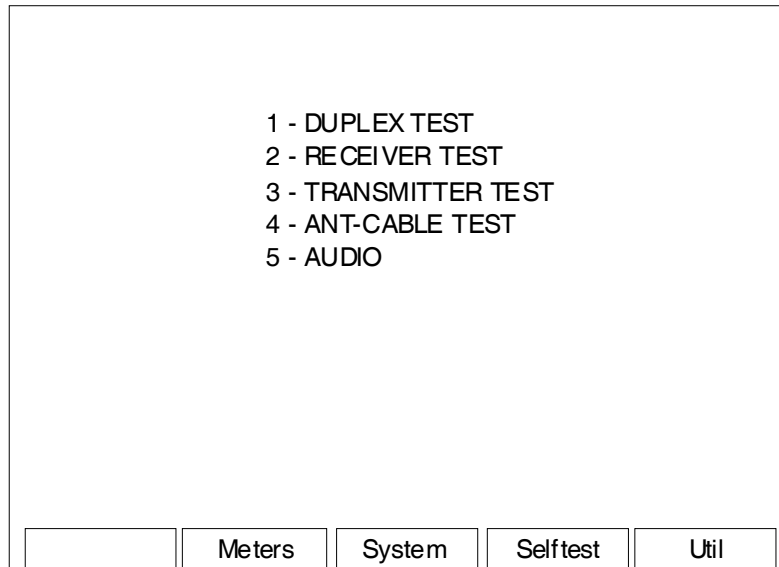

SCREEN FEATURE	FUNCTION
1 - DUPLEX TEST	Displays the Duplex Test Screen (para 2-2-2A).
2 - RECEIVER TEST	Displays the Receiver Test Screen (para 2-2-2B).
3 - TRANSMITTER TEST	Displays the Transmitter Test Screen (para 2-2-2C).
4 - ANT-CABLE TEST	Displays the ANT-Cable Test Screen (para 2-2-2D).
5 - AUDIO	Displays the Audio Test Screen (para 2-2-2E).
F2 “Meters”	Displays the Meters Menu (para 2-2-3).
F3 “System”	Displays the System Menu (para 2-2-2).
F4 “Selftest”	Displays the Self Test Menu (para 2-2-4).
F5 “Util”	Displays the Utilities Menu (para 2-2-5).

A. Duplex Test Screen

When the System Menu is displayed, press the 1 Key to access the Duplex Test Screen:

DUPLEX TEST		41		20		29	
Generator	Off	Receiver	More				
MHz	40.000000	MHz:	40.000000				
Port:	T/R	Port:	T/R				
Level:	-70 dBm	Mod:	FM 10k				
Ext Attn dB:	0	AFBW:	0.3k HP				
Modulator	Freq	FM	Analog				
Gen 1:	On 1000.0 Hz	6.25	kHz				
Gen 2:	On 150.0 Hz	3.25	kHz				
MIC:	On	6.25	kHz				
Ext Aud:	Off	Load:	High Z				
Volume:	100						
Squelch:	-50 dBm						
Speaker:	Audio In						
AudOut:	Audio In						
Save	Recall						
Edit	Return	Hold	Setup	PTT on			

Receiver	More
Ext Attn dB:	0.0
Preamp:	Auto

(CTCSS)

Modulator	Freq/Code	FM	DCS
Gen 1:	Off 150.0 Hz	3.50	kHz
Dcs:	NonInv 023	6.25	kHz
MIC:	Off	0.00	kHz
Ext Aud:	Off	Load:	High Z

(DCS)

Modulator	Freq	FM	DTMF
Gen 1:	Off 150.0 Hz	3.50	kHz
DTMF:	Burst Trig Lo:	6.25	kHz
Seq:	0123456789	Hi:	6.25 kHz
Mark	200 ms	Space:	200 ms

(DTMF)

SCREEN FEATURE	FUNCTION
Status (Generator)	Displays the status (On / Off) of the Generator.
MHz (Generator)	Used to select the signal generator frequency. Range: 2.000000 to 1000.000000 MHz in 0.000001 MHz increments
Port (Generator)	Used to select the signal generator output connector. Select: Ant, T/R or SWR

A. Duplex Test Screen (cont)

SCREEN FEATURE	FUNCTION
Level (Generator)	Used to select the signal generator output level. The Generator Output Level Units can be toggled between dBm and μ V. Select: Ant -90 to -30 dBm in 1 dB increments T/R -120 to -50 dBm in 1 dB increments SWR -65 to -5 dBm in 1 dB increments Select: Ant 7.07 to 7071.03 μ V in 1 dB increments T/R 0.22 to 707.11 μ V in 1 dB increments SWR 125.74 to 125743.3 μ V in 1 dB increments
Ext Attn dB (Generator)	Used to select the external attenuation on the output connector. Select: 0 to 30 dB in 1 dB increments
MHz (Receiver)	Used to select the signal receiver frequency. Range: 2.000000 to 1000.000000 MHz in 0.000001 MHz increments
Port (Receiver)	Used to select the signal receiver input connector. Select: Ant or T/R
Mod (Receiver)	Used to select the signal receiver modulation type. Select: AM Modulation Meter changes to AM%. FM Modulation Meter changes to FM DEV.
IFBW (field to right of Mod Field)	Used to select the IF bandwidth. Select: (for AM): 5k, 6.25k, 8.33k, 10k, 12.5k, 25k or 30k (for FM): 5k, 6.25k, 8.33k, 10k, 12.5k, 25k, 30k, 100k or 300k
AFBW (Receiver)	Used to select the bandwidth filter. Select: 0.3k LP, 3k LP, 5k LP, 15k LP, CCITT BP, C-Wt BP, 0.3-3k BP, 0.3-5k BP, 0.3-20k BP, 0.3k HP or None.
More	Toggles the Receiver Frame to display the Cable Offset and Preamp Fields.
Cable Offset (Receiver)	Used to select the cable loss. Cable loss is used by the RSSI and Power Meters to display the power level at the UUT. Select: 0 to 30.0 dB in 0.01 dB steps
Ext Attn dB (Receiver)	Used to select the external attenuation on the input connector. Select: 0.0 to 30.0 dB in 0.1 dB increments
Preamp (Receiver)	Used to select preamp operation. Select: Auto, On or Off
Modulation Type	Used to select the modulation type. Select: AM, FM or Off

A. Duplex Test Screen (cont)

SCREEN FEATURE	FUNCTION
Modulator	<p>Used to change functionality of the modulation source fields.</p> <p>Press F1 "ENTER" Key to toggle between Analog (CTCSS), DCS and DTMF modulation source fields.</p> <p>NOTE: The total combined modulation from all sources in each Modulatorframe cannot exceed 100% for AM or 100 kHz for FM.</p> <p>If the modulation level of a selection source is set to a value that would cause the total modulation to exceed the modulation limit, the value of the unselected sources are lowered automatically.</p>
Analog (CTCSS) Modulation Source Fields	
Gen 1	<p>Used to select internal modulation.</p> <p>Select: On or Off</p> <p>AM: Freq 0 to 20000 Hz in 1 Hz increments %Mod 0% to 100% in 0.1% increments</p> <p>FM: Freq 0 to 20000 Hz in 1 Hz increments Dev kHz 0 to 100 kHz in 0.01 kHz increments</p>
Gen 2	<p>Used to select internal modulation.</p> <p>This setting can be toggled between Gen 2, DCS (Digitally Coded Squelch) and DCS INV (Inverse DCS).</p> <p>Select: On or Off</p> <p>Select: AM: Freq 0 to 20000 Hz in 1 Hz increments %Mod 0% to 100% in 0.1% increments</p> <p>FM: Freq 0 to 20000 Hz in 1 Hz increments Dev kHz 0 to 100 kHz in 0.01 kHz increments</p>
MIC	<p>Used to select the external Microphone and the level of modulation for the microphone input.</p> <p>Select: On The external Microphone modulates the test set signal generator.</p> <p>Off Deactivates the external Microphone input.</p> <p>AM 0% to 100% in 0.1% increments</p> <p>FM 0 to 100 kHz in 0.01 kHz increments</p>
Load	<p>Used to select the Audio input signal load (Ω).</p> <p>Select: 150, 600, 1K (3500A), Div10 (3500A) or High Z</p>

A. Duplex Test Screen (cont)

SCREEN FEATURE	FUNCTION
Ext Aud	Used to select external modulation. Select: On Permits an external tone generator to modulate the test set signal generator. Off Deactivates the external Audio input.
DCS Modulation Source Fields	
Gen 1	Used to select internal modulation. Select: On or Off AM: Freq 0 to 20000 Hz in 1 Hz increments %Mod 0% to 100% in 0.1% increments FM: Freq 0 to 20000 Hz in 1 Hz increments Dev kHz 0 to 100 kHz in 0.01 kHz increments
Dcs	Used to select the DCS state. Select: AM: Inv (Interted), NonInv (Non-Inverted) or Off DCS Code 023, 025, 026, 031, 032, 043, 047, 051, 054, 065, 071, 072, 073, 074, 114, 115, 116, 125, 131, 132, 134, 143, 152, 155, 156, 162, 165, 172, 174, 205, 223, 226, 243, 244, 245, 251, 261, 263, 265, 271, 306, 311, 315, 331, 343, 346, 351, 364, 365, 371, 411, 412, 413, 423, 431, 432, 445, 464, 465, 466, 503, 506, 516, 532, 546, 565, 606, 612, 624, 627, 631, 632, 654, 662, 664, 703, 712, 723, 731, 732, 734, 743 or 754 %Mod 0% to 100% in 0.1% increments Select: FM: Inv (Interted), NonInv (Non-Inverted) or Off DCS Code 023, 025, 026, 031, 032, 043, 047, 051, 054, 065, 071, 072, 073, 074, 114, 115, 116, 125, 131, 132, 134, 143, 152, 155, 156, 162, 165, 172, 174, 205, 223, 226, 243, 244, 245, 251, 261, 263, 265, 271, 306, 311, 315, 331, 343, 346, 351, 364, 365, 371, 411, 412, 413, 423, 431, 432, 445, 464, 465, 466, 503, 506, 516, 532, 546, 565, 606, 612, 624, 627, 631, 632, 654, 662, 664, 703, 712, 723, 731, 732, 734, 743 or 754 Dev kHz 0 to 100 kHz in 0.01 kHz increments

A. Duplex Test Screen (cont)

SCREEN FEATURE	FUNCTION
MIC	Used to select the external Microphone and the level of modulation for the microphone input. Select: On The external Microphone modulates the test set signal generator. Off Deactivates the external Microphone input. AM 0% to 100% in 0.1% increments FM 0 to 100 kHz in 0.01 kHz increments
Ext Aud	Used to select external modulation. Select: On Permits an external tone generator to modulate the test set signal generator. Off Deactivates the external Audio input.
Load	Used to select the Audio input signal load (Ω). Select: 150, 600, 1K (3500A), Div10 (3500A) or High Z
DTMF Modulation Source Fields	
Gen 1	Used to select internal modulation. Select: On or Off AM: Freq 0 to 20000 Hz in 1 Hz increments %Mod 0% to 100% in 0.1% increments FM: Freq 0 to 20000 Hz in 1 Hz increments Dev kHz 0 to 100 kHz in 0.01 kHz increments
Dtmf	Used to select the DTMF state. Select: AM: State Burst, Cont (Continuous) or Off %Mod 0% to 100% in 0.1% increments (Lo) 0% to 100% in 0.1% increments (Hi) Seq Up to 12 characters (0 to 9, A, B, C, D) FM: State Burst, Cont (Continuous) or Off Freq 0 to 20000 Hz in 1 Hz increments Dev kHz 0 to 100 kHz in 0.01 kHz increments 0 to 100 kHz in 0.01 kHz increments Seq Up to 12 characters (0 to 9, A, B, C, D)
Mark	Used to select the DTMF timing. Select: 100 to 1000 ms in 1 ms increments
Space	Used to select the DTMF timing. Select: 100 to 1000 ms in 1 ms increments

A. Duplex Test Screen (cont)

SCREEN FEATURE	FUNCTION								
Volume	Used to select the Handset volume level. Select: 0 to 100								
Squelch	Used to select the Squelch level for Duplex and Transmitter tests. Select: -150 to 50 dBm in 1 dB increments Squelch operates in conjunction with the Receiver RSSI Meter. When the RSSI Meter is under this threshold, then the speaker audio is silenced. The RSSI Meter does not need to be displayed on the screen for squelch to be operational.								
Speaker	Used to select the Speaker Output. Select: Audio In, Demod or Fgen								
Aud Out	Used to select the Audio Output Connector. Select: Audio In, Demod or Fgen								
Save	Displays the Save Configuration Screen (para 2-2-7B) to store the current state of the test screen in the internal memory.								
Recall	Displays the Recall Configuration Screen (para 2-2-7A) to recall a stored state of the test screen from internal memory.								
Meters (not shown)	Several Meters can be selected to appear on the Duplex Test Screen. Meters are selected in the Duplex Test Setup Screen.								
F1 "Edit" / "Done" / "Zoom" / "Enter"	<table border="0"> <tr> <td>Edit</td> <td>Highlights the selected field to be changed or changes the field value if the field only contains two selections.</td> </tr> <tr> <td>Done</td> <td>Ends the Field Edit and saves the new setting / value.</td> </tr> <tr> <td>Zoom</td> <td>Displays the screen of the field selected.</td> </tr> <tr> <td>Enter</td> <td>Moves cursor into meter / function on test screen.</td> </tr> </table>	Edit	Highlights the selected field to be changed or changes the field value if the field only contains two selections.	Done	Ends the Field Edit and saves the new setting / value.	Zoom	Displays the screen of the field selected.	Enter	Moves cursor into meter / function on test screen.
Edit	Highlights the selected field to be changed or changes the field value if the field only contains two selections.								
Done	Ends the Field Edit and saves the new setting / value.								
Zoom	Displays the screen of the field selected.								
Enter	Moves cursor into meter / function on test screen.								
F2 "Return" / "Save"	<table border="0"> <tr> <td>Return</td> <td>Displays the System Menu (para 2-2-2)</td> </tr> <tr> <td>Save</td> <td>Performs a data dump of frames displayed on the screen. Meters save configurations and readings. Control frames save settings. The data dump is stored in a time-stamped ASCII report and can be retrieved at a later time.</td> </tr> </table>	Return	Displays the System Menu (para 2-2-2)	Save	Performs a data dump of frames displayed on the screen. Meters save configurations and readings. Control frames save settings. The data dump is stored in a time-stamped ASCII report and can be retrieved at a later time.				
Return	Displays the System Menu (para 2-2-2)								
Save	Performs a data dump of frames displayed on the screen. Meters save configurations and readings. Control frames save settings. The data dump is stored in a time-stamped ASCII report and can be retrieved at a later time.								
F3 "Hold" / "Resume" / "Find"	<table border="0"> <tr> <td>Hold</td> <td>Freezes the screen.</td> </tr> <tr> <td>Resume</td> <td>Restores the screen to active mode.</td> </tr> <tr> <td>Find</td> <td>Used to scan and find RF signals.</td> </tr> </table>	Hold	Freezes the screen.	Resume	Restores the screen to active mode.	Find	Used to scan and find RF signals.		
Hold	Freezes the screen.								
Resume	Restores the screen to active mode.								
Find	Used to scan and find RF signals.								
F4 "Setup"	Displays the Duplex Test Setup Screen.								

A. Duplex Test Screen (cont)

SCREEN FEATURE	FUNCTION
F5 "Ptt on" / "Ptt off" / "Esc"	<p>Ptt on Activates MIC. Turns RF Generator ON and turns Demod Audio OFF.</p> <p>Ptt off Deactivates MIC. Turns RF Generator OFF and turns Demod Audio ON.</p> <p>Esc Ends the Field Edit, but does <u>NOT</u> save any changes to the setting or value.</p>

A. Duplex Test Screen (cont)

When the Duplex Test Screen is displayed, press the F4 "Setup" Key to access the Duplex Test Setup Screen:

DUPLEX TEST SETUP		↓ 41	□	□	□	20	↑	↑	↑	29	□	△																		
Modulation Meter	<input type="text" value="0"/>	DCS Decode	<input type="text" value="0"/>																											
RSSI Meter	<input type="text" value="0"/>	Audio Level	<input type="text" value="0"/>																											
RF Error Meter	<input type="text" value="0"/>																													
RF Power Meter	<input type="text" value="0"/>																													
SINAD Meter	<input type="text" value="0"/>																													
Distortion Meter	<input type="text" value="0"/>																													
AF Counter	<input type="text" value="0"/>																													
DTMF Decode	<input type="text" value="0"/>																													
<table border="1"> <tr> <td>1</td><td><input checked="" type="checkbox"/></td> <td>2</td><td><input checked="" type="checkbox"/></td> <td>3</td><td><input type="checkbox"/></td> </tr> <tr> <td>4</td><td><input checked="" type="checkbox"/></td> <td>5</td><td><input checked="" type="checkbox"/></td> <td>6</td><td><input type="checkbox"/></td> </tr> <tr> <td>7</td><td><input checked="" type="checkbox"/></td> <td>8</td><td><input type="checkbox"/></td> <td>9</td><td><input type="checkbox"/></td> </tr> </table>		1	<input checked="" type="checkbox"/>	2	<input checked="" type="checkbox"/>	3	<input type="checkbox"/>	4	<input checked="" type="checkbox"/>	5	<input checked="" type="checkbox"/>	6	<input type="checkbox"/>	7	<input checked="" type="checkbox"/>	8	<input type="checkbox"/>	9	<input type="checkbox"/>											
1	<input checked="" type="checkbox"/>	2	<input checked="" type="checkbox"/>	3	<input type="checkbox"/>																									
4	<input checked="" type="checkbox"/>	5	<input checked="" type="checkbox"/>	6	<input type="checkbox"/>																									
7	<input checked="" type="checkbox"/>	8	<input type="checkbox"/>	9	<input type="checkbox"/>																									
Edit		Return																												

Mod-FM Dev
16.670 kHz

RSSI
0.0 dBm

RF Error
0.0 kHz

RF Power
0.0 Watts

SINAD Audio In
0.0 dB

Distortion Audio In
0.0%

AF Cntr Audio In
0.0 Hz

DTMF Decode
01234

0123456789

DCS Decode
State Run
Inv 155

Audio Level Audio In
0.000 V

A. Duplex Test Screen (cont)

SCREEN FEATURE	FUNCTION
Modulation Meter	Used to select the position of the Modulation Meter on the Duplex Test Screen (refer to Meter Chart). Select: 0 (Meter not shown), 3, 6, 8 or 9
RSSI Meter	Used to select the position of the RSSI Meter on the Duplex Test Screen (refer to Meter Chart). Select: 0 (Meter not shown), 3, 6, 8 or 9
RF Error Meter	Used to select the position of the RF Error Meter on the Duplex Test Screen (refer to Meter Chart). Select: 0 (Meter not shown), 3, 6, 8 or 9
RF Power Meter	Used to select the position of the RF Power Meter on the Duplex Test Screen (refer to Meter Chart). Select: 0 (Meter not shown), 3, 6, 8 or 9
SINAD Meter	Used to select the position of the SINAD Meter on the Duplex Test Screen (refer to Meter Chart). Select: 0 (Meter not shown), 3, 6, 8 or 9
Distortion Meter	Used to select the position of the Distortion Meter on the Duplex Test Screen (refer to Meter Chart). Select: 0 (Meter not shown), 3, 6, 8 or 9
AF Counter	Used to select the position of the AF Counter on the Duplex Test Screen (refer to Meter Chart). Select: 0 (Meter not shown), 2, 3, 6, 8 or 9
DTMF Decode	Used to select the position of the DTMF Decode Meter on the Duplex Test Screen (refer to Meter Chart). Select: 0 (Meter not shown), 2, 3, 6, 8 or 9
DCS Decode	Used to select the position of the DCS Decode Meter on the Duplex Test Screen (refer to Meter Chart). Select: 0 (Meter not shown), 2, 3, 6, 8 or 9
Audio Level	Used to select the position of the Audio Level Meter on the Duplex Test Screen (refer to Meter Chart). Select: 0 (Meter not shown), 2, 3, 6, 8 or 9
Meter Chart	Displays the areas of the Duplex Test Screen and a number representing each area (i.e., 3 is top right on the Duplex Test Screen, etc.).
F1 "Edit" / "Done" / "Zoom"	<p>Edit Highlights the selected field to be changed.</p> <p>Done Ends the Field Edit and saves the new setting / value.</p> <p>Zoom Displays the screen of the field selected.</p>
F2 "Return"	Displays the Duplex Test Screen.
F5 "Esc"	Ends the Field Edit, but does <u>NOT</u> save any changes to the setting or value.

B. Receiver Test Screen

When the System Menu is displayed, press the 2 Key to access the Receiver Test Screen:

RECEIVER TEST		41		20		29	
Generator	Off						
MH z	40.000000						
Port:	T/R						
Level:	-70 dBm						
Ext Attn dB:	0						
Modulator	Freq	FM	Analog				
Gen 1:	On	1000.0 Hz	6.25 kHz				
Gen 2:	On	150.0 Hz	3.25 kHz				
MIC:	On		6.25 kHz				
Ext Aud:	Off	Load:	High Z				
Volume:	100						
Squelch:	-50 dBm						
Speaker:	Audio In						
AudOut:	Audio In						
Save	Recall						
Edit		Return		Hold		Setup	

(CTCSS)

Modulator	Freq/Code	FM	DCS
Gen 1:	Off 150.0 Hz	3.50 kHz	
Dcs:	NonInv 023	6.25 kHz	
MIC:	Off	0.00 kHz	
Ext Aud:	Off	Load:	High Z

(DCS)

Modulator	Freq	FM	DTMF
Gen 1:	Off 150.0 Hz	3.50 kHz	
DTMF:	Burst Trig	Lo: 6.25 kHz	
Seq:	0123456789	Hi: 6.25 kHz	
Mark	200 ms	Space:	200 ms

(DTMF)

SCREEN FEATURE	FUNCTION
Status (Generator)	Displays the status (On / Off) of the Generator.
MHz	Used to select the signal generator frequency. Range: 2.000000 to 1000.000000 MHz in 0.000001 MHz increments
Port	Used to select the signal generator output connector. Select: Ant, T/R or SWR

B. Receiver Test Screen (cont)

SCREEN FEATURE	FUNCTION
Level	<p>Used to select the signal generator output level.</p> <p>The Generator Output Level Units can be toggled between dBm and μV.</p> <p>Select: Ant -90 to -30 dBm in 1 dB increments T/R -120 to -50 dBm in 1 dB increments SWR -65 to -5 dBm in 1 dB increments</p> <p>Select: Ant 7.07 to 7071.03 μV in 1 dB increments T/R 0.22 to 707.11 μV in 1 dB increments SWR 125.74 to 125743.3 μV in 1 dB increments</p>
Ext Attn dB	<p>Used to select the external attenuation on the output connector.</p> <p>Select: 0 to 30 dB in 1 dB increments</p>
Modulation Type	<p>Used to select the modulation type.</p> <p>Select: AM, FM or Off</p>
Modulator	<p>Used to change functionality of the modulation source fields.</p> <p>Press F1 "ENTER" Key to toggle between Analog (CTCSS), DCS and DTMF modulation source fields.</p> <p>NOTE: The total combined modulation from all sources in each Modulatorframe cannot exceed 100% for AM or 100 kHz for FM.</p> <p>If the modulation level of a selection source is set to a value that would cause the total modulation to exceed the modulation limit, the value of the unselected sources are lowered automatically.</p>
Analog (CTCSS) Modulation Source Fields	
Gen 1	<p>Used to select internal modulation.</p> <p>Select: On or Off</p> <p>AM: Freq 0 to 20000 Hz in 1 Hz increments %Mod 0% to 100% in 0.1% increments</p> <p>FM: Freq 0 to 20000 Hz in 1 Hz increments Dev kHz 0 to 100 kHz in 0.01 kHz increments</p>

B. Receiver Test Screen (cont)

SCREEN FEATURE	FUNCTION
Gen 2	<p>Used to select internal modulation.</p> <p>This setting can be toggled between Gen 2, DCS (Digitally Coded Squelch) and DCS INV (Inverse DCS).</p> <p>Select: On or Off</p> <p>Select: AM: Freq 0 to 20000 Hz in 1 Hz increments %Mod 0% to 100% in 0.1% increments</p> <p>FM: Freq 0 to 20000 Hz in 1 Hz increments Dev kHz 0 to 100 kHz in 0.01 kHz increments</p>
MIC	<p>Used to select the external Microphone and the level of modulation for the microphone input.</p> <p>Select: On The external Microphone modulates the test set signal generator.</p> <p>Off Deactivates the external Microphone input.</p> <p>AM 0% to 100% in 0.1% increments</p> <p>FM 0 to 100 kHz in 0.01 kHz increments</p>
Ext Aud	<p>Used to select external modulation.</p> <p>Select: On Permits an external tone generator to modulate the test set signal generator.</p> <p>Off Deactivates the external Audio input.</p>
Load	<p>Used to select the Audio input signal load (Ω).</p> <p>Select: 150, 600, 1K (3500A), Div10 (3500A) or High Z</p>
DCS Modulation Source Fields	
Gen 1	<p>Used to select internal modulation.</p> <p>Select: On or Off</p> <p>AM: Freq 0 to 20000 Hz in 1 Hz increments %Mod 0% to 100% in 0.1% increments</p> <p>FM: Freq 0 to 20000 Hz in 1 Hz increments Dev kHz 0 to 100 kHz in 0.01 kHz increments</p>

B. Receiver Test Screen (cont)

SCREEN FEATURE	FUNCTION
Dcs	<p>Used to select the DCS state.</p> <p>Select: AM: Inv (Interted), NonInv (Non-Inverted) or Off DCS Code 023, 025, 026, 031, 032, 043, 047, 051, 054, 065, 071, 072, 073, 074, 114, 115, 116, 125, 131, 132, 134, 143, 152, 155, 156, 162, 165, 172, 174, 205, 223, 226, 243, 244, 245, 251, 261, 263, 265, 271, 306, 311, 315, 331, 343, 346, 351, 364, 365, 371, 411, 412, 413, 423, 431, 432, 445, 464, 465, 466, 503, 506, 516, 532, 546, 565, 606, 612, 624, 627, 631, 632, 654, 662, 664, 703, 712, 723, 731, 732, 734, 743 or 754</p> <p> %Mod 0% to 100% in 0.1% increments</p> <p>Select: FM: Inv (Interted), NonInv (Non-Inverted) or Off DCS Code 023, 025, 026, 031, 032, 043, 047, 051, 054, 065, 071, 072, 073, 074, 114, 115, 116, 125, 131, 132, 134, 143, 152, 155, 156, 162, 165, 172, 174, 205, 223, 226, 243, 244, 245, 251, 261, 263, 265, 271, 306, 311, 315, 331, 343, 346, 351, 364, 365, 371, 411, 412, 413, 423, 431, 432, 445, 464, 465, 466, 503, 506, 516, 532, 546, 565, 606, 612, 624, 627, 631, 632, 654, 662, 664, 703, 712, 723, 731, 732, 734, 743 or 754</p> <p> Dev kHz 0 to 100 kHz in 0.01 kHz increments</p>
MIC	<p>Used to select the external Microphone and the level of modulation for the microphone input.</p> <p>Select: On The external Microphone modulates the test set signal generator.</p> <p> Off Deactivates the external Microphone input.</p> <p> AM 0% to 100% in 0.1% increments</p> <p> FM 0 to 100 kHz in 0.01 kHz increments</p>
Ext Aud	<p>Used to select external modulation.</p> <p>Select: On Permits an external tone generator to modulate the test set signal generator.</p> <p> Off Deactivates the external Audio input.</p>
Load	<p>Used to select the Audio input signal load (Ω).</p> <p>Select: 150, 600, 1K (3500A), Div10 (3500A) or High Z</p>

B. Receiver Test Screen (cont)

DTMF Modulation Source Fields	
Gen 1	<p>Used to select internal modulation.</p> <p>Select: On or Off</p> <p>AM: Freq 0 to 20000 Hz in 1 Hz increments %Mod 0% to 100% in 0.1% increments</p> <p>FM: Freq 0 to 20000 Hz in 1 Hz increments Dev kHz 0 to 100 kHz in 0.01 kHz increments</p>
Dtmf	<p>Used to select the DTMF state.</p> <p>Select: AM: State Burst, Cont (Continuous) or Off %Mod 0% to 100% in 0.1% increments (Lo) 0% to 100% in 0.1% increments (Hi) Seq Up to 12 characters (0 to 9, A, B, C, D)</p> <p>FM: State Burst, Cont (Continuous) or Off Dev kHz 0 to 100 kHz in 0.01 kHz increments 0 to 100 kHz in 0.01 kHz increments Seq Up to 12 characters (0 to 9, A, B, C, D)</p>
Mark	<p>Used to select the DTMF timing.</p> <p>Select: 100 to 1000 ms in 1 ms increments</p>
Space	<p>Used to select the DTMF timing.</p> <p>Select: 100 to 1000 ms in 1 ms increments</p>
Volume	<p>Used to select the Handset volume level.</p> <p>Select: 0 to 100</p>
Squelch	<p>Used to select the Squelch level for Duplex and Transmitter tests.</p> <p>Select: -150 to 50 dBm in 1 dB increments</p> <p>Squelch operates in conjunction with the Receiver RSSI Meter. When the RSSI Meter is under this threshold, then the speaker audio is silenced. The RSSI Meter does not need to be displayed on the screen for squelch to be operational.</p>
Speaker	<p>Used to select the Speaker Output.</p> <p>Select: Audio In or Mod</p>
Aud Out	<p>Used to select the Audio Output Connector.</p> <p>Select: Audio In or Mod</p>
Save	<p>Displays the Save Configuration Screen (para 2-2-7B) to store the current state of the test screen in the internal memory.</p>
Recall	<p>Displays the Recall Configuration Screen (para 2-2-7A) to recall a stored state of the test screen from internal memory.</p>

B. Receiver Test Screen (cont)

SCREEN FEATURE	FUNCTION
Meters (not shown)	Several Meters can be selected to appear on the Receiver Test Screen. Meters are selected in the Receiver Test Setup Screen.
F1 "Edit" / "Done" / "Zoom" / "Enter"	<p>Edit Highlights the selected field to be changed or changes the field value if the field only contains two selections.</p> <p>Done Ends the Field Edit and saves the new setting / value.</p> <p>Zoom Displays the screen of the field selected.</p> <p>Enter Moves cursor into meter / function on test screen.</p>
F2 "Return" / "Save"	<p>Return Displays the System Menu (para 2-2-2)</p> <p>Save Performs a data dump of frames displayed on the screen. Meters save configurations and readings. Control frames save settings. The data dump is stored in a time-stamped ASCII report and can be retrieved at a later time.</p>
F3 "Hold" / "Resume"	<p>Hold Freezes the screen.</p> <p>Resume Restores the screen to active mode.</p>
F4 "Setup"	Displays the Receiver Test Setup Screen.
F5 "Esc"	Ends the Field Edit, but does NOT save any changes to the setting or value.

B. Receiver Test Screen (cont)

RECEIVER TEST SETUP ↓ 41 □ □ □ □ 20 ↑ ↑ ↑ 29 □ △

SINAD Meter

Distortion Meter 0

AF Counter 0

Audio Level 0

1 <input checked="" type="checkbox"/>	2 <input type="checkbox"/>	3 <input type="checkbox"/>
4 <input checked="" type="checkbox"/>	5 <input checked="" type="checkbox"/>	6 <input type="checkbox"/>
7 <input checked="" type="checkbox"/>	8 <input type="checkbox"/>	9 <input type="checkbox"/>

SINAD Audio In
0.0 dB

Distortion Audio In
0.0%

AF Cntr Audio In
0.0 Hz

Audio Level Audio In
0.000 V

SCREEN FEATURE	FUNCTION
SINAD Meter	Used to select the position of the SINAD Meter on the Receiver Test Screen (refer to Meter Chart). Select: 0 (Meter not shown), 2, 3, 6, 8 or 9
Distortion Meter	Used to select the position of the Distortion Meter on the Receiver Test Screen (refer to Meter Chart). Select: 0 (Meter not shown), 2, 3, 6, 8 or 9
AF Counter	Used to select the position of the AF Counter on the Receiver Test Screen (refer to Meter Chart). Select: 0 (Meter not shown), 2, 3, 6, 8 or 9
Audio Level	Used to select the position of the Audio Level Meter on the Receiver Test Screen (refer to Meter Chart). Select: 0 (Meter not shown), 2, 3, 6, 8 or 9

B. Receiver Test Screen (cont)

SCREEN FEATURE	FUNCTION
Meter Chart	Displays the areas of the Receiver Test Screen and a number representing each area (i.e., 3 is top right on the Receiver Test Screen, etc.).
F1 "Edit" / "Done"	Edit Highlights the selected field to be changed. Done Ends the Field Edit and saves the new setting / value.
F2 "Return"	Displays the Receiver Test Screen.
F5 "Esc"	Ends the Field Edit, but does <u>NOT</u> save any changes to the setting or value.

C. Transmitter Test Screen

When the System Menu is displayed, press the 3 Key to access the Transmitter Test Screen:

TRANSMITTER TEST	
Receiver	More
MHz	40.000000
Port:	T/R
Mod:	FM 10k
AFBW:	None
Volume: 100	
Squelch: -50 dBm	
Speaker: Audio In	
AudOut: Audio In	
Save	Recall
Edit	Return
Hold	Setup

TRANSMITTER TEST	
Receiver	More
Ext Attn dB:	0.0
Preamp:	Auto

SCREEN FEATURE	FUNCTION
MHz	Used to select the signal receiver frequency. Range: 2.000000 to 1000.000000 MHz in 0.000001 MHz increments
Port	Used to select the signal receiver input connector. Select: Ant or T/R
Mod	Used to select the signal receiver modulation type. Select: AM Modulation Meter changes to AM%. FM Modulation Meter changes to FM DEV.
IFBW (field to right of Mod Field)	Used to select the IF bandwidth. Select: (for AM): 5k, 6.25k, 8.33k, 10k, 12.5k, 25k or 30k (for FM): 5k, 6.25k, 8.33k, 10k, 12.5k, 25k, 30k, 100k or 300k
AFBW	Used to select the bandwidth filter. Select: 0.3k LP, 3k LP, 5k LP, 15k LP, CCITT BP, C-Wt BP, 0.3-3k BP, 0.3-5k BP, 0.3-20k BP, 0.3k HP or None.
More	Toggles the Receiver Frame to display the Ext Attn dB and Preamp Fields.
Ext Attn dB	Used to select the external attenuation on the input connector. Select: 0.0 to 30.0 dB in 0.1 dB increments

C. Transmitter Test Screen (cont)

SCREEN FEATURE	FUNCTION								
Preamp (Receiver)	Used to select preamp operation. Select: Auto, On or Off								
Volume	Used to select the Handset volume level. Select: 0 to 100								
Squelch	Used to select the Squelch level for Duplex and Transmitter tests. Select: -150 to 50 dBm in 1 dB increments Squelch operates in conjunction with the Receiver RSSI Meter. When the RSSI Meter is under this threshold, then the speaker audio is silenced. The RSSI Meter does not need to be displayed on the screen for squelch to be operational.								
Speaker	Used to select the Speaker Output. Select: Audio In, Demod or Fgen								
Aud Out	Used to select the Audio Output Connector. Select: Audio In, Demod or Fgen								
Save	Displays the Save Configuration Screen (para 2-2-7B) to store the current state of the test screen in the internal memory.								
Recall	Displays the Recall Configuration Screen (para 2-2-7A) to recall a stored state of the test screen from internal memory.								
Meters (not shown)	Several Meters can be selected to appear on the Transmitter Test Screen. Meters are selected in the Transmitter Test Setup Screen.								
F1 "Edit" / "Done" / "Zoom" / "Enter"	<table border="0"> <tr> <td>Edit</td> <td>Highlights the selected field to be changed or changes the field value if the field only contains two selections.</td> </tr> <tr> <td>Done</td> <td>Ends the Field Edit and saves the new setting / value.</td> </tr> <tr> <td>Zoom</td> <td>Displays the screen of the field selected.</td> </tr> <tr> <td>Enter</td> <td>Displays additional fields on test screen.</td> </tr> </table>	Edit	Highlights the selected field to be changed or changes the field value if the field only contains two selections.	Done	Ends the Field Edit and saves the new setting / value.	Zoom	Displays the screen of the field selected.	Enter	Displays additional fields on test screen.
Edit	Highlights the selected field to be changed or changes the field value if the field only contains two selections.								
Done	Ends the Field Edit and saves the new setting / value.								
Zoom	Displays the screen of the field selected.								
Enter	Displays additional fields on test screen.								
F2 "Return" / "Save"	<table border="0"> <tr> <td>Return</td> <td>Displays the System Menu (para 2-2-2)</td> </tr> <tr> <td>Save</td> <td>Performs a data dump of frames displayed on the screen. Meters save configurations and readings. Control frames save settings. The data dump is stored in a time-stamped ASCII report and can be retrieved at a later time.</td> </tr> </table>	Return	Displays the System Menu (para 2-2-2)	Save	Performs a data dump of frames displayed on the screen. Meters save configurations and readings. Control frames save settings. The data dump is stored in a time-stamped ASCII report and can be retrieved at a later time.				
Return	Displays the System Menu (para 2-2-2)								
Save	Performs a data dump of frames displayed on the screen. Meters save configurations and readings. Control frames save settings. The data dump is stored in a time-stamped ASCII report and can be retrieved at a later time.								
F3 "Hold" / "Resume" / "Find"	<table border="0"> <tr> <td>Hold</td> <td>Freezes the screen.</td> </tr> <tr> <td>Resume</td> <td>Restores the screen to active mode.</td> </tr> <tr> <td>Find</td> <td>Used to scan and find RF signals.</td> </tr> </table>	Hold	Freezes the screen.	Resume	Restores the screen to active mode.	Find	Used to scan and find RF signals.		
Hold	Freezes the screen.								
Resume	Restores the screen to active mode.								
Find	Used to scan and find RF signals.								
F4 "Setup"	Displays the Transmitter Test Setup Screen.								
F5 "Esc"	Ends the Field Edit, but does <u>NOT</u> save any changes to the setting or value.								

C. Transmitter Test Screen (cont)

When the Transmitter Test Screen is displayed, press the F4 "Setup" Key to access the Transmitter Test Setup Screen:

TX TEST SETUP ↓ 41 □ □ □ □ 20 ↑ □ □ □ 29 □ △

Fgen	0	DTMF Decode	0
Modulation Meter	0	DCS Decode	0
RSSI Meter	0	Audio Level	0
RF Error Meter	0		
Distortion Meter	0		
SINAD Meter	0		
RF Power Meter	0		
AF Counter	0		

1

2

3

4

5

6

7

8

9

Edit

Return

Function Generator

	Freq	Level
#1: Off	0.0 Hz	0.20 Vrms
#2: Off	0.0 Hz	0.20 Vrms

Mod-FM Dev
16.670 kHz

RSSI
0.0 dBm

RF Error
0.0 kHz

Distortion Audio In
0.0%

SINAD Audio In
0.0 dB

RF Power
0.0 Watts

AF Cntr Audio In
0.0 Hz

DTMF Decode
01234

0123456789

DCS Decode
State Run
Inv 155

Audio Level Audio In
0.000 V

C. Transmitter Test Screen (cont)

SCREEN FEATURE	FUNCTION
Fgen (Function Generator)	<p>Used to select the position of the Function Generator on the Transmitter Test Screen (refer to Meter Chart).</p> <p>Since the Function Generator occupies the screen space of two functions on the Transmitter Test Screen, the space directly adjacent to the screen space selected must be empty in order for the Function Generator to be displayed. (e.g. To select screen space 2; screen space 3 must be empty)</p> <p>Select: 0 (Meter not shown), 2, 4, 5 or 8</p> <p>Status Select: On or Off</p> <p>Freq Select: 0 to 20000 Hz in 0.1 Hz increments</p> <p>Level Select: 0.00 to 1.57 Vrms in 0.01 V increments</p> <p>The Function Generator utilizes the AUDIO Connector for signal output.</p>
Modulation Meter	<p>Used to select the position of the Modulation Meter on the Transmitter Test Screen (refer to Meter Chart).</p> <p>Select: 0 (Meter not shown), 2, 3, 4, 5, 6, 8 or 9</p>
RSSI Meter	<p>Used to select the position of the RSSI Meter on the Transmitter Test Screen (refer to Meter Chart).</p> <p>Select: 0 (Meter not shown), 2, 3, 4, 5, 6, 8 or 9</p>
RF Error Meter	<p>Used to select the position of the RF Error Meter on the Transmitter Test Screen (refer to Meter Chart).</p> <p>Select: 0 (Meter not shown), 2, 3, 4, 5, 6, 8 or 9</p>
Distortion Meter	<p>Used to select the position of the Distortion Meter on the Transmitter Test Screen (refer to Meter Chart).</p> <p>Select: 0 (Meter not shown), 2, 3, 4, 5, 6, 8 or 9</p>
SINAD Meter	<p>Used to select the position of the SINAD Meter on the Transmitter Test Screen (refer to Meter Chart).</p> <p>Select: 0 (Meter not shown), 2, 3, 4, 5, 6, 8 or 9</p>
RF Power Meter	<p>Used to select the position of the RF Power Meter on the Transmitter Test Screen (refer to Meter Chart).</p> <p>Select: 0 (Meter not shown), 2, 3, 4, 5, 6, 8 or 9</p>
AF Counter	<p>Used to select the position of the AF Counter on the Transmitter Test Screen (refer to Meter Chart).</p> <p>Select: 0 (Meter not shown), 2, 3, 4, 5, 6, 8 or 9</p>
DTMF Decode	<p>Used to select the position of the DTMF Decode Meter on the Transmitter Test Screen (refer to Meter Chart).</p> <p>Select: 0 (Meter not shown), 2, 3, 4, 5, 6, 8 or 9</p>
DCS Decode	<p>Used to select the position of the DCS Decode Meter on the Transmitter Test Screen (refer to Meter Chart).</p> <p>Select: 0 (Meter not shown), 2, 3, 4, 5, 6, 8 or 9</p>

C. Transmitter Test Screen (cont)

SCREEN FEATURE	FUNCTION
Audio Level	Used to select the position of the Audio Level Meter on the Transmitter Test Screen (refer to Meter Chart). Select: 0 (Meter not shown), 2, 3, 4, 5, 6, 8 or 9
Meter Chart	Displays the areas of the Transmitter Test Screen and a number representing each area (i.e., 3 is top right on the Transmitter Test Screen, etc.).
F1 "Edit" / "Done"	Edit Highlights the selected field to be changed. Done Ends the Field Edit and saves the new setting / value.
F2 "Return"	Displays the Transmitter Test Screen.
F5 "Esc"	Ends the Field Edit, but does <u>NOT</u> save any changes to the setting or value.

D. ANT-Cable Test Screen

When the System Menu is displayed, press the 4 Key to access the ANT-Cable Test Screen:

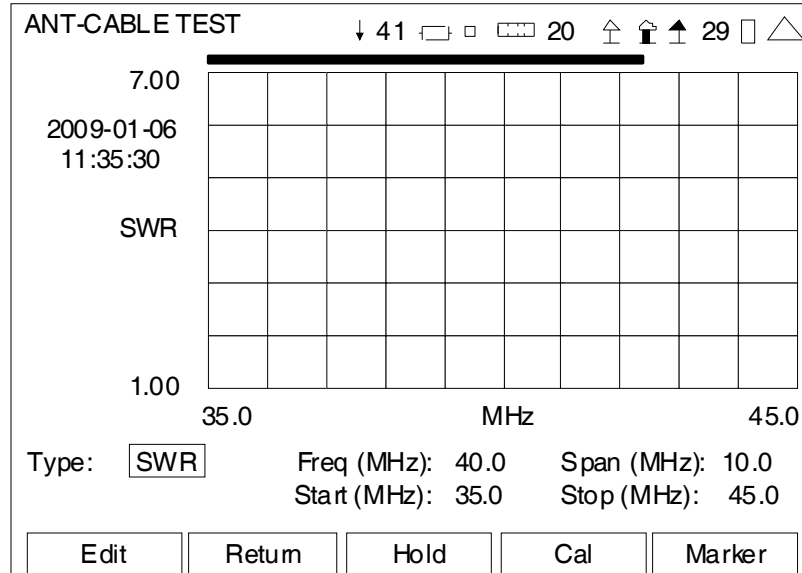

(RF Mode)

SCREEN FEATURE	FUNCTION
VSWR Progress Bar	A graphical representation of the percentage completed for the current measurement.
Type	Used to select the mode of testing. Select: SWR, DTF, RL, LOSS or Raw
Freq	Used to select/display the Center Frequency. Range: 2.0 to 1000.0 MHz in 0.1 MHz increments Displays the Center Frequency entered by the operator or the calculated Center Frequency if the Start and Stop Frequencies are entered.
Span	Used to select/display the Frequency Span. Range: (SWR) 10 to 998 MHz in 0.1 MHz increments (DTF) 100 to 998 MHz in 0.1 MHz increments (RL) 10 to 998 MHz in 0.1 MHz increments (LOSS) 10 to 998 MHz in 0.1 MHz increments Displays the Frequency Span entered by the operator or the calculated Frequency Span if the Start and Stop Frequencies are entered.

D. ANT-Cable Test Screen (cont)

SCREEN FEATURE	FUNCTION
Start	Used to select/display the Start Frequency. Range: 2.0 to 1000 MHz in 0.1 MHz increments Displays the Start Frequency entered by the operator or the calculated Start Frequency if the Center Frequency and Frequency Span are entered.
Stop	Used to select/display the Stop Frequency. Range: 2.0 to 1000 MHz in 0.1 MHz increments Displays the Stop Frequency entered by the operator or the calculated Stop Frequency if the Center Frequency and Frequency Span are entered.
F1 "Edit" / "Done" / "Next"	<p>Edit Highlights the selected field to be changed or changes the field value if the field only contains two selections.</p> <p>Done Ends the Field Edit and saves the new setting / value.</p> <p>Next Displays the next pop-up screen.</p>
F2 "Return" / "Save"	<p>Return Displays the System Menu (para 2-2-2)</p> <p>Save Performs a data dump of frames displayed on the screen, including configurations, readings and settings. The data dump is stored in a time-stamped ASCII report and can be retrieved at a later time.</p>
F3 "Hold" / "Resume" / "Abort"	<p>Hold Freezes the screen.</p> <p>Resume Restores the screen to active mode.</p> <p>Abort Stops the action to calibrate the SWR Connector.</p>
F4 "Cal"	Instruction pop-ups are displayed to calibrate the SWR Connector.
F5 "Marker" / "Scale" / "RF" / "Esc"	<p>Marker Used to change the displayed fields and functionality on the ANT-Cable Test Screen to Marker Mode.</p> <p>Scale Used to change the displayed fields and functionality on the ANT-Cable Test Screen to Scale Mode.</p> <p>RF Used to change the displayed fields and functionality on the ANT-Cable Test Screen to RF Mode.</p> <p>Esc Ends the Field Edit, but does <u>NOT</u> save any changes to the setting or value.</p>

D. ANT-Cable Test Screen (cont)

SCREEN FEATURE	FUNCTION
VSWR Progress Bar	A graphical representation of the percentage completed for the current measurement.
Marker	Used to select and enable one of three markers on the Graphical Display. Select: 1 to 3
Marker Status	Used to set the Marker selected to ON or OFF.
Delta	Used to enable the Delta Marker Function. Select: 1 to 3
DTF	Displays the distance to fault.
Delta (Top)	Displays the Delta in SWR/Return Loss between the Active Marker selected in the Marker Field and the Marker selected in the Delta Field.
Move/Min/Max	Used to move the Active Marker on the Graphical Display. Select: Max, Min or Move
Left Right	Used to move the Active Marker selected in the Marker Field to the left or to the right on the Graphical Display.
Pos	Displays the Horizontal Axis of the Active Marker.
VSWR / dB	Displays the reading of the Active Marker. VSWR Displays the SWR reading. dB Displays the DTF, RL or LOSS reading.
Delta (Bottom)	Displays the Delta in Frequency or Distance between the Active Marker selected in the Marker Field and the Marker selected in the Delta Field.
F1 "Edit" / "Done" / "Next"	Edit Highlights the selected field to be changed or changes the field value if the field only contains two selections. Done Ends the Field Edit and saves the new setting / value. Next Displays the next pop-up screen.
F2 "Return" / "Save"	Return Displays the System Menu (para 2-2-2) Save Performs a data dump of frames displayed on the screen, including configurations, readings and settings. The data dump is stored in a time-stamped ASCII report and can be retrieved at a later time.
F3 "Hold" / "Resume" / "Abort"	Hold Freezes the screen. Resume Restores the screen to active mode. Abort Stops the action to calibrate the SWR Connector.
F4 "Cal"	Instruction pop-ups are displayed to calibrate the SWR Connector.

D. ANT-Cable Test Screen (cont)

SCREEN FEATURE	FUNCTION	
F5 "Marker" / "Scale" "Cable" / "RF" / "Esc"	Marker	Used to change the displayed fields and functionality on the ANT-Cable Test Screen to Marker Mode.
	Scale	Used to change the displayed fields and functionality on the ANT-Cable Test Screen to Scale Mode.
	Cable	Used to change the displayed fields and functionality on the ANT-Cable Test Screen to Cable Mode.
	RF	Used to change the displayed fields and functionality on the ANT-Cable Test Screen to RF Mode.
	Esc	Ends the Field Edit, but does <u>NOT</u> save any changes to the setting or value.

D. ANT-Cable Test Screen (cont)

SCREEN FEATURE	FUNCTION
F1 "Edit" / "Done" / "Next"	<p>Edit Highlights the selected field to be changed or changes the field value if the field only contains two selections.</p> <p>Done Ends the Field Edit and saves the new setting / value.</p> <p>Next Displays the next pop-up screen.</p>
F2 "Return" / "Save"	<p>Return Displays the System Menu (para 2-2-2)</p> <p>Save Performs a data dump of frames displayed on the screen, including configurations, readings and settings. The data dump is stored in a time-stamped ASCII report and can be retrieved at a later time.</p>
F3 "Hold" / "Resume" / "Abort"	<p>Hold Freezes the screen.</p> <p>Resume Restores the screen to active mode.</p> <p>Abort Stops the action to calibrate the SWR Connector.</p>
F4 "Cal"	Instruction pop-ups are displayed to calibrate the SWR Connector.
F5 "Marker" / "Scale" / "RF" / "Esc"	<p>Marker Used to change the displayed fields and functionality on the ANT-Cable Test Screen to Marker Mode.</p> <p>Scale Used to change the displayed fields and functionality on the ANT-Cable Test Screen to Scale Mode.</p> <p>RF Used to change the displayed fields and functionality on the ANT-Cable Test Screen to RF Mode.</p> <p>Esc Ends the Field Edit, but does <u>NOT</u> save any changes to the setting or value.</p>

D. ANT-Cable Test Screen (cont)

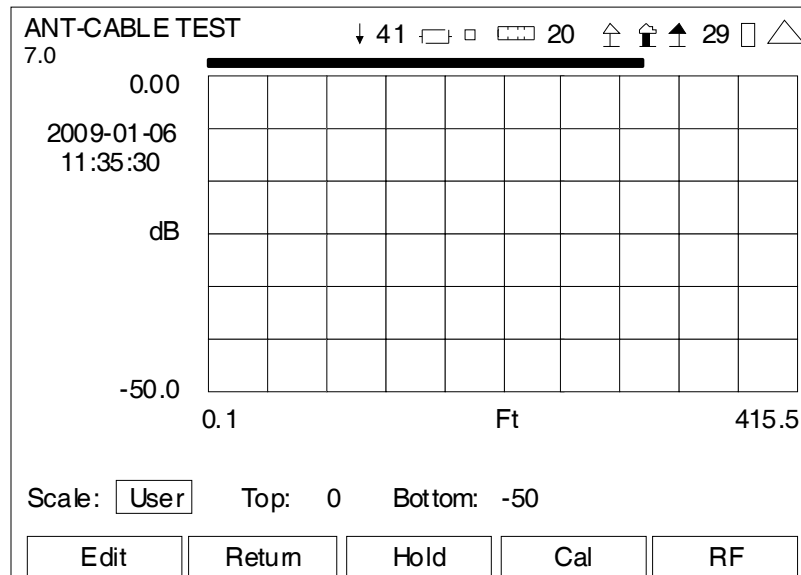

(Scale Mode)

SCREEN FEATURE	FUNCTION
VSWR Progress Bar	A graphical representation of the percentage completed for the current measurement.
Scale	Used to scale the Vertical Axis of the Graphical Display. Select: Fixed or User
Top	Used to set the upper limit of the Vertical Axis. Select: -100 to 100
Bottom	Used to set the lower limit of the Vertical Axis. Select: -100 to 100
F1 "Edit" / "Done" / "Next"	<p>Edit Highlights the selected field to be changed or changes the field value if the field only contains two selections.</p> <p>Done Ends the Field Edit and saves the new setting / value.</p> <p>Next Displays the next pop-up screen.</p>
F2 "Return" / "Save"	<p>Return Displays the System Menu (para 2-2-2)</p> <p>Save Performs a data dump of frames displayed on the screen, including configurations, readings and settings. The data dump is stored in a time-stamped ASCII report and can be retrieved at a later time.</p>
F3 "Hold" / "Resume" / "Abort"	<p>Hold Freezes the screen.</p> <p>Resume Restores the screen to active mode.</p> <p>Abort Stops the action to calibrate the SWR Connector.</p>
F4 "Cal"	Instruction pop-ups are displayed to calibrate the SWR Connector.

D. ANT-Cable Test Screen (cont)

SCREEN FEATURE	FUNCTION	
F5 "Marker" / "Scale" "RF" / "Esc"	Marker	Used to change the displayed fields and functionality on the ANT-Cable Test Screen to Marker Mode.
	Scale	Used to change the displayed fields and functionality on the ANT-Cable Test Screen to Scale Mode.
	RF	Used to change the displayed fields and functionality on the ANT-Cable Test Screen to RF Mode.
	Esc	Ends the Field Edit, but does <u>NOT</u> save any changes to the setting or value.

E. Audio Function Generator Test Screen

When the System Menu is displayed, press the 5 Key to access the Audio Function Generator Test Screen.

The Audio Function Generator Test Screen utilizes the AUDIO Connector for signal output.

Function Generator		Level
# 1: <input type="checkbox"/> On	Freq 1000.0 Hz	1.00 Vrms
# 2: <input type="checkbox"/> On	Freq 2400.0 Hz	1.00 Vrms

Volume:	100
Squelch:	-50 dBm
Speaker:	Audio In
AudOut:	Audio In
Save	Recall

Edit	Return	Hold	Setup	
------	--------	------	-------	--

SCREEN FEATURE	FUNCTION
#1 (Function Generator)	Used to select Function Generator #1. Select: On or Off Freq 0 to 20000 Hz in 0.1 Hz increments Level 0.00 to 1.57 Vrms in 0.01 V increments
#2 (Function Generator)	Used to select Function Generator #2. Select: On or Off Freq 0 to 20000 Hz in 0.1 Hz increments Level 0.00 to 1.57 Vrms in 0.01 V increments

NOTE: The combined output level from both Function Generators cannot exceed 1.57 Vrms.

If the level of a selected Function Generator is set so the combined output level would exceed 1.57 Vrms, then the output level of the unselected Function Generator is lowered automatically.

Volume	Used to select the Handset volume level. Select: 0 to 100
--------	--

E. Audio Function Generator Test Screen (cont)

SCREEN FEATURE	FUNCTION								
Squelch	Used to select the Squelch level for Duplex and Transmitter tests. Select: -150 to 50 dBm in 1 dB increments Squelch operates in conjunction with the Receiver RSSI Meter. When the RSSI Meter is under this threshold, then the speaker audio is silenced. The RSSI Meter does not need to be displayed on the screen for squelch to be operational.								
Speaker	Used to select the Speaker Output. Select: Audio In, Demod or Fgen								
Aud Out	Used to select the Audio Output Connector. Select: Audio In, Demod or Fgen								
Save	Displays the Save Configuration Screen (para 2-2-7B) to store the current state of the test screen in the internal memory.								
Recall	Displays the Recall Configuration Screen (para 2-2-7A) to recall a stored state of the test screen from internal memory.								
Meters (not shown)	Several Meters can be selected to appear on the Audio Function Generator Screen. Meters are selected in the Audio Function Generator Setup Screen.								
F1 "Edit" / "Done" / "Zoom" / "Enter"	<table border="0"> <tr> <td>Edit</td> <td>Highlights the selected field to be changed or changes the field value if the field only contains two selections.</td> </tr> <tr> <td>Done</td> <td>Ends the Field Edit and saves the new setting / value.</td> </tr> <tr> <td>Zoom</td> <td>Displays the screen of the field selected.</td> </tr> <tr> <td>Enter</td> <td>Moves cursor into meter / function on test screen.</td> </tr> </table>	Edit	Highlights the selected field to be changed or changes the field value if the field only contains two selections.	Done	Ends the Field Edit and saves the new setting / value.	Zoom	Displays the screen of the field selected.	Enter	Moves cursor into meter / function on test screen.
Edit	Highlights the selected field to be changed or changes the field value if the field only contains two selections.								
Done	Ends the Field Edit and saves the new setting / value.								
Zoom	Displays the screen of the field selected.								
Enter	Moves cursor into meter / function on test screen.								
F2 "Return" / "Save"	<table border="0"> <tr> <td>Return</td> <td>Displays the System Menu (para 2-2-2)</td> </tr> <tr> <td>Save</td> <td>Performs a data dump of frames displayed on the screen. Meters save configurations and readings. Control frames save settings. The data dump is stored in a time-stamped ASCII report and can be retrieved at a later time.</td> </tr> </table>	Return	Displays the System Menu (para 2-2-2)	Save	Performs a data dump of frames displayed on the screen. Meters save configurations and readings. Control frames save settings. The data dump is stored in a time-stamped ASCII report and can be retrieved at a later time.				
Return	Displays the System Menu (para 2-2-2)								
Save	Performs a data dump of frames displayed on the screen. Meters save configurations and readings. Control frames save settings. The data dump is stored in a time-stamped ASCII report and can be retrieved at a later time.								
F3 "Hold" / "Resume"	<table border="0"> <tr> <td>Hold</td> <td>Freezes the screen.</td> </tr> <tr> <td>Resume</td> <td>Restores the screen to active mode.</td> </tr> </table>	Hold	Freezes the screen.	Resume	Restores the screen to active mode.				
Hold	Freezes the screen.								
Resume	Restores the screen to active mode.								
F4 "Setup"	Displays the Audio Function Generator Setup Screen.								
F5 "Esc"	Ends the Field Edit, but does <u>NOT</u> save any changes to the setting or value.								

E. Audio Function Generator Test Screen (cont)

When the Audio Function Generator Test Screen is displayed, press the F4 "Setup" Key to access the Audio Function Generator Test Setup Screen:

AF GEN SETUP ↓ 41 □ □ □ □ 20 ↑ ↑ ↑ 29 □ △

SINAD Meter

Distortion Meter 0

AF Counter 0

Audio Level 0

1	<input checked="" type="checkbox"/>	2	<input checked="" type="checkbox"/>	3	<input type="checkbox"/>
4	<input type="checkbox"/>	5	<input type="checkbox"/>	6	<input type="checkbox"/>
7	<input checked="" type="checkbox"/>	8	<input type="checkbox"/>	9	<input type="checkbox"/>

Edit	Return			
------	--------	--	--	--

SINAD Audio In
0.0 dB

Distortion Audio In
0.0%

AF Cntr Audio In
0.0 Hz

Audio Level Audio In
0.000 V

SCREEN FEATURE	FUNCTION
SINAD Meter	Used to select the position of the SINAD Meter on the Audio Function Generator Test Screen (refer to Meter Chart). Select: 0 (Meter not shown), 3, 4, 5, 6, 8 or 9
Distortion Meter	Used to select the position of the Distortion Meter on the Audio Function Generator Test Screen (refer to Meter Chart). Select: 0 (Meter not shown), 3, 4, 5, 6, 8 or 9
AF Counter	Used to select the position of the AF Counter on the Audio Function Generator Test Screen (refer to Meter Chart). Select: 0 (Meter not shown), 3, 4, 5, 6, 8 or 9

E. Audio Function Generator Test Screen (cont)

SCREEN FEATURE	FUNCTION
Audio Level	Used to select the position of the Audio Level Meter on the Audio Function Generator Test Screen (refer to Meter Chart). Select: 0 (Meter not shown), 3, 4, 5, 6, 8 or 9
Meter Chart	Displays the areas of the Audio Function Generator Test Screen and a number representing each area (i.e., 3 is top right on the Audio Function Generator Test Screen, etc.).
F1 "Edit" / "Done"	Edit Highlights the selected field to be changed. Done Ends the Field Edit and saves the new setting / value.
F2 "Return"	Displays the Audio Function Generator Test Screen.
F5 "Esc"	Ends the Field Edit, but does <u>NOT</u> save any changes to the setting or value.

2-2-3. METERS MENU

When the System Menu, Self Test Menu or Utilities Menu is displayed, press the F2 “Meters” Key to access the Meters Menu:

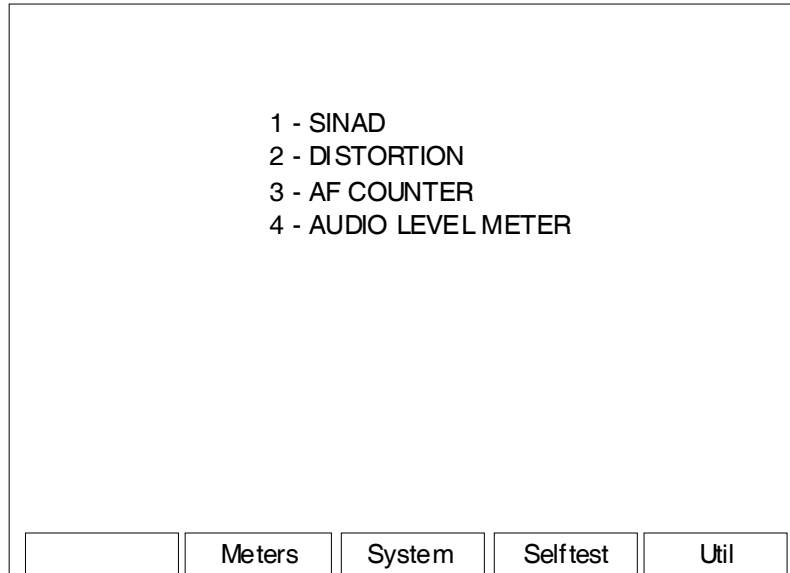

SCREEN FEATURE	FUNCTION
1 - SINAD	Displays the SINAD Meter Screen (para 2-2-3A).
2 - DISTORTION	Displays the Distortion Meter Screen (para 2-2-3B).
3 - AF COUNTER	Displays the AF Counter Screen (para 2-2-3C).
4 - AUDIO LEVEL METER	Displays the Audio Level Meter Screen (para 2-2-3D).
F2 “Meters”	Displays the Meters Menu (para 2-2-3).
F3 “System”	Displays the System Menu (para 2-2-2).
F4 “Selftest”	Displays the Self Test Menu (para 2-2-4).
F5 “Util”	Displays the Utilities Menu (para 2-2-5).

A. SINAD Meter Screen

When the Meters Menu is displayed, press the 1 Key to access the SINAD Meter Screen:

The SINAD Meter Screen utilizes the AUDIO Connector and AUDIO IN Connector for signal input.

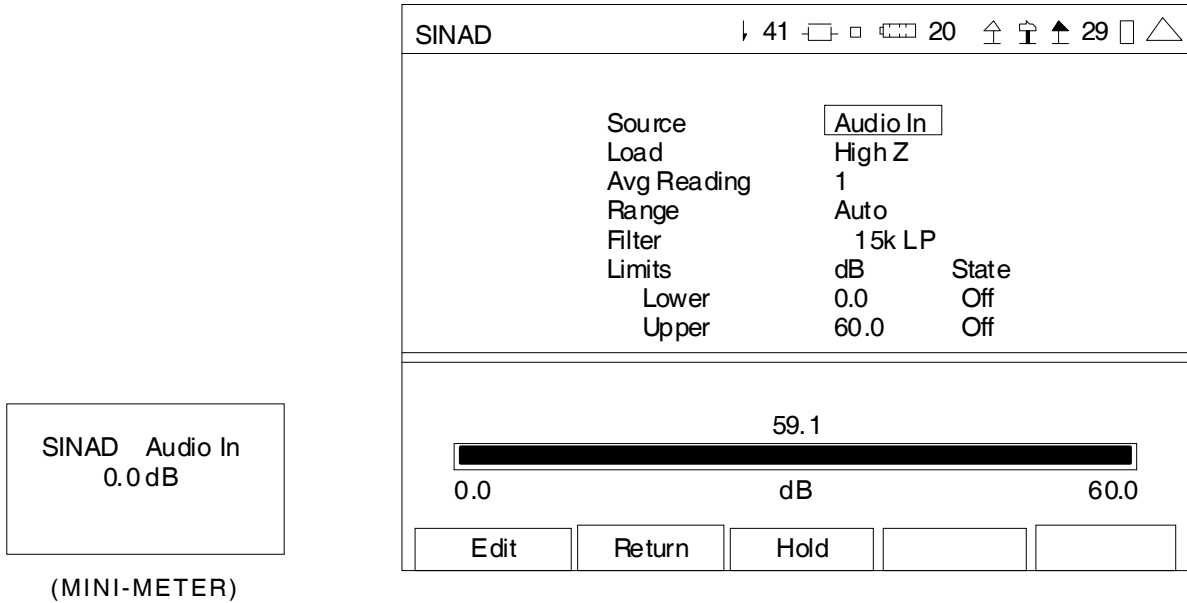

SCREEN FEATURE	FUNCTION
Source	Used to select the SINAD Meter input source on the SINAD Meter Screen and/or the SINAD Mini-Meter. Select: Audio In or Demod (Duplex Test Screen) Audio In (Receiver Test Screen) Audio In or Demod (Transmitter Test Screen) Audio In (Audio Function Generator Screen) When the SINAD Meter Screen is selected from the Meters Menu, 'Audio In' is the only setting available.
Load	Used to select the Audio input signal load (Ω). Select: 150, 600, 1K (3500A), Div10 (3500A) or High Z
Avg Reading	Used to select the SINAD Meter Averaging. Select: 1 to 99 This is the number of readings to average for the displayed value.
Range	Used to select the meter range. Select: Auto, 0-20dB, 0-40dB or 0-60dB
Filter	Used to select the audio filter. Select: None, 15k LP or 0.3-3k BP

A. SINAD Meter Screen (cont)

SCREEN FEATURE	FUNCTION
Limits - Lower	Used to enable the SINAD Meter Low Limit. Select: 0.0 to 60.0 dBm in 0.1 dB increments Sets the marker on the SINAD Meter Bar to the Lower Limit selected.
Limits - Upper	Used to enable the SINAD Meter Upper Limit. Select: 0.0 to 60.0 dBm in 0.1 dB increments Sets the marker on the SINAD Meter Bar to the Upper Limit selected.
State - Lower Limit	Used to display the Lower Limit Marker on the SINAD Meter Bar. Select: On or Off
State - Upper Limit	Used to display the Upper Limit Marker on the SINAD Meter Bar. Select: On or Off
SINAD Meter Bar	A graphical representation of the received SINAD Meter readings.
F1 "Edit" / "Done"	Edit Highlights the selected field to be changed or changes the field value if the field only contains two selections. Done Ends the Field Edit and saves the new setting / value.
F2 "Return" / "Save"	Return Displays the System Menu (para 2-2-2) Save Performs a data dump of frames displayed on the screen, including configurations, readings and settings. The data dump is stored in a time-stamped ASCII report and can be retrieved at a later time.
F3 "Hold" / "Resume"	Hold Freezes the screen. Resume Restores the screen to active mode.
F5 "Return" / "Esc"	Return Closes the SINAD Meter Screen and returns to the Test Screen. Esc Ends the Field Edit, but does <u>NOT</u> save any changes to the setting or value.

B. Distortion Meter Screen

When the Meters Menu is displayed, press the 2 Key to access the Distortion Meter Screen:

The Distortion Meter Screen utilizes the AUDIO Connector and AUDIO IN Connector (3500A only) for signal input.

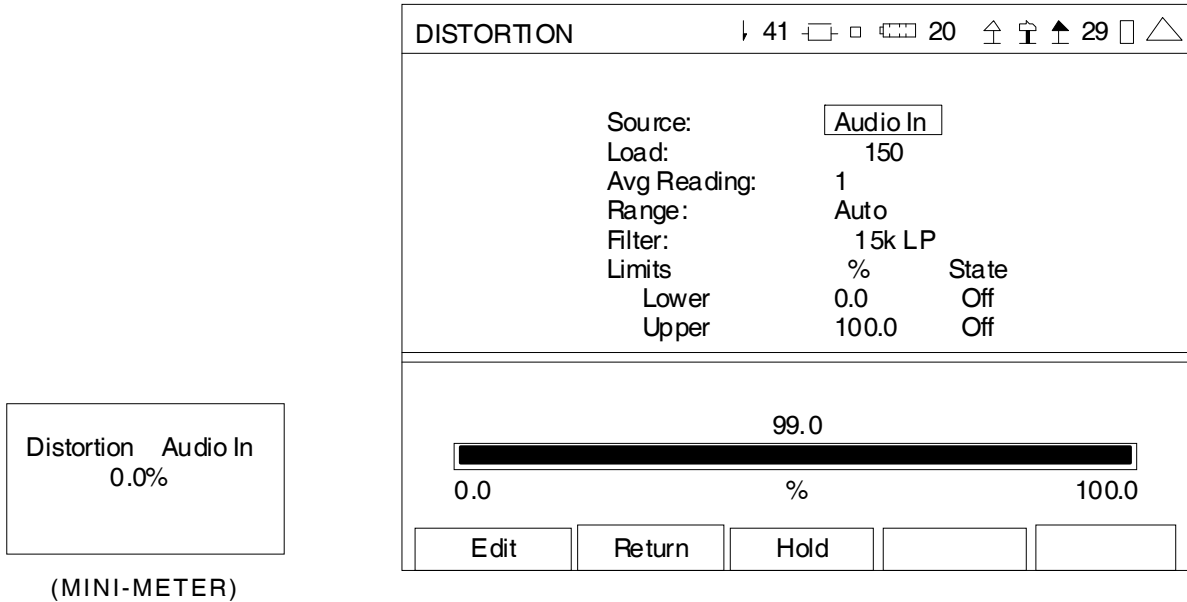

SCREEN FEATURE	FUNCTION
Source	Used to select the Distortion Meter input source on the Distortion Meter Screen and/or the Distortion Mini-Meter. Select: Audio In or Demod (Duplex Test Screen) Audio In (Receiver Test Screen) Audio In or Demod (Transmitter Test Screen) Audio In (Audio Function Generator Screen) When the Distortion Meter Screen is selected from the Meters Menu, 'Audio In' is the only setting available.
Load	Used to select the Audio input signal load (Ω). Select: 150, 600, 1K (3500A), Div10 (3500A) or High Z
Avg Reading	Used to select the Distortion Meter Averaging. Select: 1 to 99 This is the number of readings to average for the displayed value.
Range	Used to select the meter range. Select: Auto, 0-10%, 0-20%, 0-50% or 0-100%
Filter	Used to select the audio filter. Select: None, 15k LP or 0.3-3k BP

B. Distortion Meter Screen (cont)

SCREEN FEATURE	FUNCTION
Limits - Lower	Used to enable the Distortion Meter Low Limit. Select: 0.0% to 100.0% in 0.1% increments Sets the marker on the Distortion Bar to the Lower Limit selected.
Limits - Upper	Used to enable the Distortion Meter Upper Limit. Select: 0.0% to 100.0% in 0.1% increments Sets the marker on the Distortion Meter Bar to the Upper Limit selected.
State - Lower Limit	Used to display the Lower Limit Marker on the Distortion Meter Bar. Select: On or Off
State - Upper Limit	Used to display the Upper Limit Marker on the Distortion Meter Bar. Select: On or Off
Distortion Meter Bar	A graphical representation of the received Distortion Meter readings.
F1 "Edit" / "Done"	Edit Highlights the selected field to be changed or changes the field value if the field only contains two selections. Done Ends the Field Edit and saves the new setting / value.
F2 "Return" / "Save"	Return Displays the System Menu (para 2-2-2) Save Performs a data dump of frames displayed on the screen, including configurations, readings and settings. The data dump is stored in a time-stamped ASCII report and can be retrieved at a later time.
F3 "Hold" / "Resume"	Hold Freezes the screen. Resume Restores the screen to active mode.
F5 "Return" / "Esc"	Return Closes the Distortion Meter Screen and returns to the Test Screen. Esc Ends the Field Edit, but does <u>NOT</u> save any changes to the setting or value.

C. AF Counter Screen

When the Meters Menu is displayed, press the 3 Key to access the AF Counter Screen:

The AF Counter Screen utilizes the AUDIO Connector and AUDIO IN Connector (3500A only) for signal input.

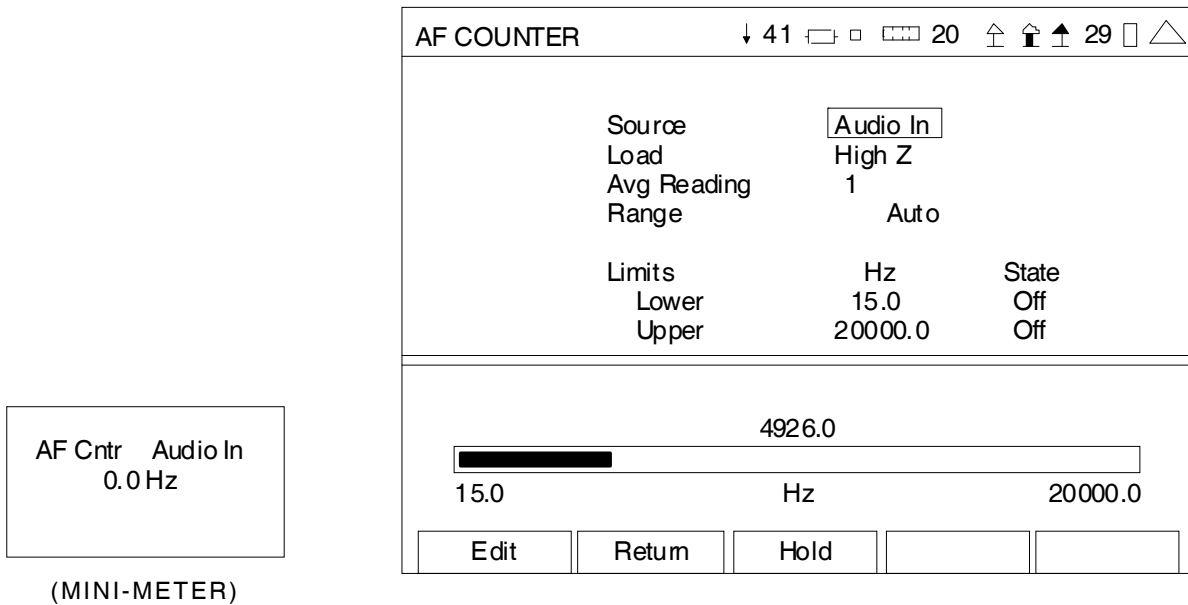

SCREEN FEATURE	FUNCTION
Source	Used to select the AF Counter input source on the AF Counter Screen and/or the AF Counter Mini-Meter. Select: Audio In, Demod, or Mod (Duplex Test Screen) Audio In or Mod (Receiver Test Screen) Audio In, Demod or Fgen (Transmitter Test Screen) Audio In or Fgen (Audio Function Generator Test Screen) When the AF Counter Screen is selected from the Meters Menu, 'Audio In' is the only setting available.
Load	Used to select the Audio input signal load (Ω). Select: 150, 600, 1K (3500A), Div10 (3500A) or High Z
Avg Reading	Used to select the AF Counter Averaging. Select: 1 to 99 This is the number of readings to average for the displayed value.
Range	Used to select the meter range. Select: Auto, 15-100Hz, 15-1000Hz, 15-10000Hz or 15-20000Hz
Limits - Lower	Used to select the AF Counter Lower Limit. Select: 15.0 to 20000.0 Hz in 0.1 Hz increments Sets the marker on the AF Counter Bar to the Lower Limit selected.

C. AF Counter Screen (cont)

SCREEN FEATURE	FUNCTION
Limits - Upper	Used to select the AF Counter Upper Limit. Select: 15.0 to 20000.0 Hz in 0.1 Hz increments Sets the marker on the AF Counter Bar to the Upper Limit selected.
State - Lower Limit	Used to display the Lower Limit Marker on the AF Counter Bar. Select: On or Off
State - Upper Limit	Used to display the Upper Limit Marker on the AF Counter Bar. Select: On or Off
AF Counter Bar	A graphical representation of the received AF Counter readings.
F1 "Edit" / "Done"	Edit Highlights the selected field to be changed or changes the field value if the field only contains two selections. Done Ends the Field Edit and saves the new setting / value.
F2 "Return" / "Save"	Return Displays the System Menu (para 2-2-2) Save Performs a data dump of frames displayed on the screen, including configurations, readings and settings. The data dump is stored in a time-stamped ASCII report and can be retrieved at a later time.
F3 "Hold" / "Resume"	Hold Freezes the screen. Resume Restores the screen to active mode.
F5 "Return" / "Esc"	Return Closes the AF Counter Screen and returns to the Test Screen. Esc Ends the Field Edit, but does <u>NOT</u> save any changes to the setting or value.

D. Audio Level Meter Screen

When the Meters Menu is displayed, press the 4 Key to access the Audio Level Meter Screen.

The Audio Level Meter Screen utilizes the AUDIO Connector, AUDIO IN Connector (3500A only) and DVM Connector (3500A only) for signal input.

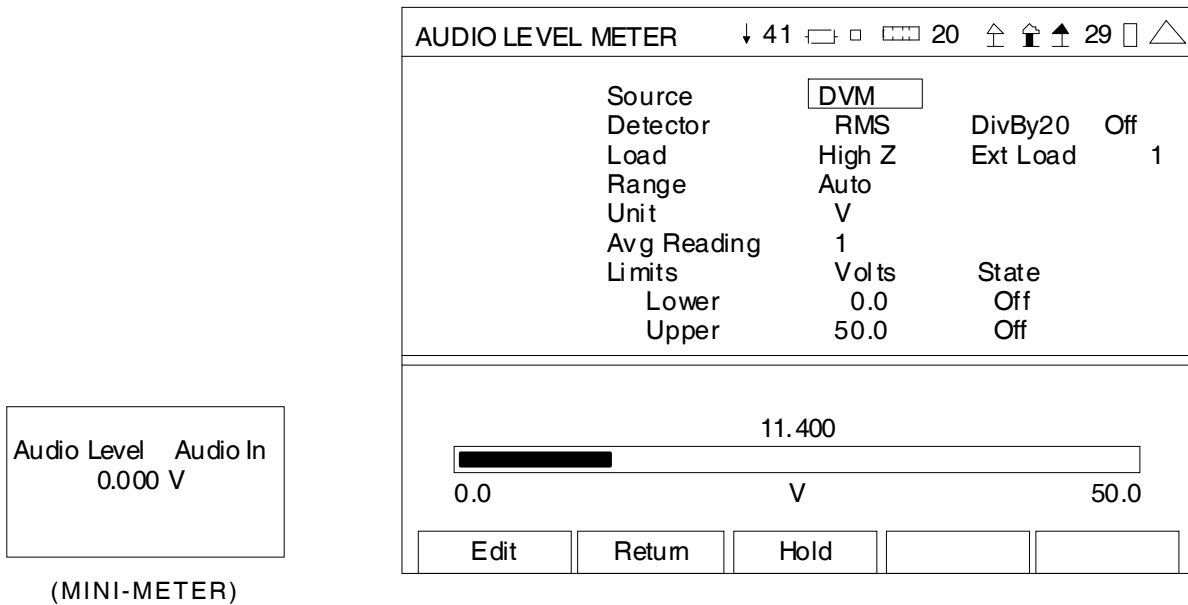

SCREEN FEATURE	FUNCTION
Source	Used to select the Audio Level Meter input source on the Audio Level Meter Screen and/or the Audio Level Meter Mini-Meter. Select: Audio In or DVM
Detector	Used to select the measurement type. Select: Peak+, Peak-, PK2PK or RMS
DivBy20	Used to select the divide-by-20 function on the output level (DVM only) Select: On or Off
Load	Used to select the Audio input signal load (Ω). Select: Audio In 150, 600, 1K (3500A), Div10 (3500A) or High Z DVM High Z
Ext Load	Used to select the impedance of an external load. The selected impedance value is used to calculate power when the Unit Field is set to dBm or Watts. Select: 1 to 90000 Ω in 1 Ω increments
Range	Used to select the meter range. Select: Auto, 0-0.1V, 0-0.2V, 0-0.5V, 0-1V or 0-3.5V

D. Audio Level Meter Screen (cont)

SCREEN FEATURE	FUNCTION
Unit	Used to select the Audio Level Meter units of measure. Select: dBm, dBuV, mV, V or Watts
Avg Reading	Used to select the Audio Level Meter Averaging. Select: 1 to 99 This is the number of readings to average for the displayed value.
Limits - Lower	Used to select the Audio Level Meter Lower Limit. Select: 0.0 to 100.0 V in 0.1 V increments Sets the marker on the Audio Level Meter Bar to the Lower Limit selected.
Limits - Upper	Used to select the Audio Level Meter Upper Limit. Select: 0.0 to 100.0 V in 0.1 V increments Sets the marker on the Audio Level Meter Bar to the Upper Limit selected.
State - Lower Limit	Used to display the Lower Limit Marker on the Audio Level Meter Bar. Select: On or Off
State - Upper Limit	Used to display the Upper Limit Marker on the Audio Level Meter Bar. Select: On or Off
AF Counter Bar	A graphical representation of the received Audio Level Meter readings.
F1 "Edit" / "Done"	Edit Highlights the selected field to be changed or changes the field value if the field only contains two selections. Done Ends the Field Edit and saves the new setting / value.
F2 "Return" / "Save"	Return Displays the System Menu (para 2-2-2) Save Performs a data dump of frames displayed on the screen, including configurations, readings and settings. The data dump is stored in a time-stamped ASCII report and can be retrieved at a later time.
F3 "Hold" / "Resume"	Hold Freezes the screen. Resume Restores the screen to active mode.
F5 "Return" / "Esc"	Return Closes the Audio Level Meter Screen and returns to the Test Screen. Esc Ends the Field Edit, but does <u>NOT</u> save any changes to the setting or value.

2-2-4. SELF TEST MENU

When the System Menu, Self Test Menu or Utilities Menu is displayed, press the F4 “Selftest” Key to access the Self Test Menu:

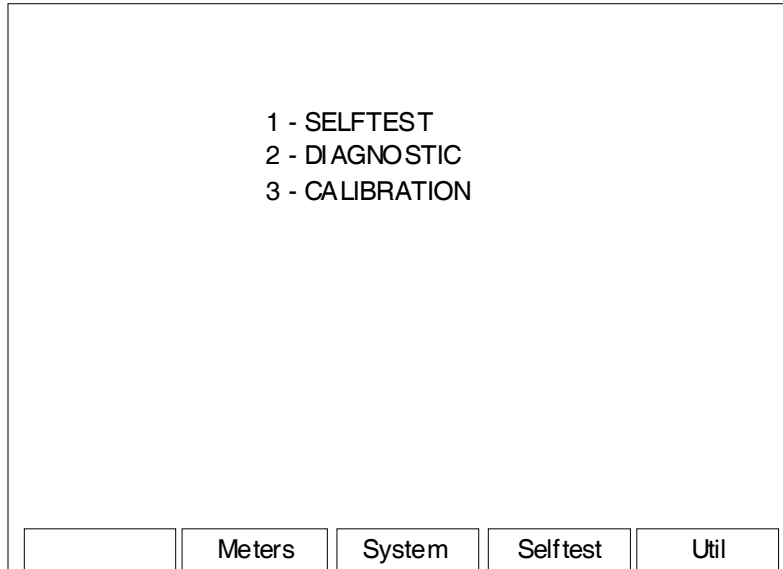

SCREEN FEATURE	FUNCTION
1 - SELFTEST	Displays the Self Test Screen (para 2-2-4A).
2 - DIAGNOSTIC	Displays the Diagnostic Screen (para 2-2-4B).
3 - CALIBRATION	Displays the Calibration Screen (para 2-2-4C).
F2 “Meters”	Displays the Meters Menu (para 2-2-3).
F3 “System”	Displays the System Menu (para 2-2-2).
F4 “Selftest”	Displays the Self Test Menu (para 2-2-4).
F5 “Util”	Displays the Utilities Menu (para 2-2-5).

A. Self Test Screen

When the Self Test Menu is displayed, press the 1 Key to access the Self Test Screen:

SELF TEST		↓ 41		□		20		↑ 29		△	
Test Mode:	Normal Run										
TDM	Pass	0	Fail	0							
Modulation	Pass	0	Fail	0							
<div style="display: flex; justify-content: space-between; margin-top: 20px;"> Edit Return Start </div>											

SCREEN FEATURE	FUNCTION
Test Mode	Used to select the run mode of the Self Test. Select: Normal Run (runs Self Test one time) Loop All (runs Self Test continuously)
TDM	Displays the pass/fail status of the TDM (Time-Division Multiplexing) Self Test. Each time the test is performed, the fields next to Pass or Fail are incremented. The fields are cleared if the Self Test is re-initialized.
Modulation	Displays the pass/fail status of the Modulation Self Test. Each time the test is performed, the fields next to Pass or Fail are incremented. The fields are cleared if the Self Test is restarted.
F1 "Edit" / "Done"	Edit Highlights the selected field to be changed or changes the field value if the field only contains two selections. Done Ends the Field Edit and saves the new setting / value.
F2 "Return"	Displays the Self Test Menu (para 2-2-4).
F5 "Start" / "Stop" / "Esc"	Start Initiates the Self Test. Stop Terminates the Self Test. Esc Ends the Field Edit, but does <u>NOT</u> save any changes to the setting or value.

B. Diagnostic Screen

When the Self Test Menu is displayed, press the 2 Key to access the Diagnostic Screen:

STAND ALONE TEST ↓ 41 □ □ □ 20 ↑ ↑ ↑ 29 □ △

Mode: Normal Run

RF CPLD	Invalid	Distortion	Invalid
TDM	Invalid	Gen Lock	Invalid
FPGA	Invalid	Rec Lock	Invalid
Temperature	Invalid	Button Battery	Invalid
AM Mod	Invalid	AF Counter	Invalid
FM Mod	Invalid	Time Domain	Invalid
RF Power	Invalid	Freq Domain	Invalid
RF Error	Invalid	SWR	Invalid
RSSI	Invalid	DTMF	Invalid
SPI	Invalid	DCS	Invalid
SINAD	Invalid		

RF CPLD Pass: 0 Fail: 0

Edit	Return			Start
------	--------	--	--	-------

SCREEN FEATURE	FUNCTION
Mode	Used to select the run mode of the Diagnostic Tests. Select: Normal Run, Loop Selected, Run Selected or Loop All
RF CPLD	Used to test Complex Programmable Logic Device. The test status field (right of the test) displays INVALID until the test is run, then displays RUNNING, STOPPED, PASSED or FAILED.
TDM	Used to test the Time-Division Multiplexing. The test status field (right of the test) displays INVALID until the test is run, then displays RUNNING, STOPPED, PASSED or FAILED.
FPGA	Used to test the Field Programmable Gate Array. The test status field (right of the test) displays INVALID until the test is run, then displays RUNNING, STOPPED, PASSED or FAILED.
Temperature	Used to test the Temperature. Sensing Devices. The test status field (right of the test) displays INVALID until the test is run, then displays RUNNING, STOPPED, PASSED or FAILED.
AM Mod	Used to test AM Modulation. The test status field (right of the test) displays INVALID until the test is run, then displays RUNNING, STOPPED, PASSED or FAILED.
FM Mod	Used to test FM Modulation. The test status field (right of the test) displays INVALID until the test is run, then displays RUNNING, STOPPED, PASSED or FAILED.

B. Diagnostic Screen (cont)

SCREEN FEATURE	FUNCTION
RF Power	Used to test RF Power. The test status field (right of the test) displays INVALID until the test is run, then displays RUNNING, STOPPED, PASSED or FAILED.
RF Error	Used to test RF Error. The test status field (right of the test) displays INVALID until the test is run, then displays RUNNING, STOPPED, PASSED or FAILED.
RSSI	Used to test the Received Signal Strength Indication. The test status field (right of the test) displays INVALID until the test is run, then displays RUNNING, STOPPED, PASSED or FAILED.
SPI	Used to test Serial Peripheral Interface. The test status field (right of the test) displays INVALID until the test is run, then displays RUNNING, STOPPED, PASSED or FAILED.
SINAD	Used to test the SINAD Meter. The test status field (right of the test) displays INVALID until the test is run, then displays RUNNING, STOPPED, PASSED or FAILED.
Distortion	Used to test the Distortion Meter. The test status field (right of the test) displays INVALID until the test is run, then displays RUNNING, STOPPED, PASSED or FAILED.
Gen Lock	Used to test the Generator (1st LO / 2nd LO). The test status field (right of the test) displays INVALID until the test is run, then displays RUNNING, STOPPED, PASSED or FAILED.
Rec Lock	Used to test the Receiver (1st LO / 2nd LO). The test status field (right of the test) displays INVALID until the test is run, then displays RUNNING, STOPPED, PASSED or FAILED.
Button Battery	Used to test the battery used to maintain non-volatile memory. The test status field (right of the test) displays INVALID until the test is run, then displays RUNNING, STOPPED, PASSED or FAILED.
AF Counter	Used to test the AF Counter. The test status field (right of the test) displays INVALID until the test is run, then displays RUNNING, STOPPED, PASSED or FAILED.
Time Domain	Used to test the Time Domain. The test status field (right of the test) displays INVALID until the test is run, then displays RUNNING, STOPPED, PASSED or FAILED.
Freq Domain	Used to test the Frequency Domain. The test status field (right of the test) displays INVALID until the test is run, then displays RUNNING, STOPPED, PASSED or FAILED.
SWR	Used to test the SWR. The test status field (right of the test) displays INVALID until the test is run, then displays RUNNING, STOPPED, PASSED or FAILED.

B. Diagnostic Screen (cont)

SCREEN FEATURE	FUNCTION
DTMF	Used to test the DTMF. The test status field (right of the test) displays INVALID until the test is run, then displays RUNNING, STOPPED, PASSED or FAILED.
DCS	Used to test the DCS. The test status field (right of the test) displays INVALID until the test is run, then displays RUNNING, STOPPED, PASSED or FAILED.
Pass / Fail Counters	Displays Pass / Fail record of the Diagnostic Test selected. The Pass / Fail Counters are incremented each time the test is performed. The Pass / Fail Counters are cleared if the Diagnostics Screen is re-initialized.
F1 "Edit" / "Done"	<p>Edit Highlights the selected field to be changed or changes the field value if the field only contains two selections.</p> <p>Done Ends the Field Edit and saves the new setting / value.</p>
F2 "Return"	Displays the Self Test Menu (para 2-2-4).
F5 "Start" / "Stop" / "Esc"	<p>Start Initiates the Diagnostic Testing.</p> <p>Stop Terminates the Diagnostic Testing.</p> <p>Esc Ends the Field Edit, but does <u>NOT</u> save any changes to the setting or value.</p>

C. Calibration Screen

When the Self Test Menu is displayed, press the 3 Key to access the Calibration Screen:

CALIBRATION		↓ 41	□	□	20	↑	↑	29	□	△
CAL PASSWORD:		<input type="text" value="0"/>								
Edit		Return								

SCREEN FEATURE	FUNCTION
CAL PASSWORD	Used to enter the Calibration Password.
F1 "Edit" / "Done"	Edit Highlights the selected field to be changed. Done Ends the Field Edit and saves the new setting / value.
F2 "Return"	Displays the Self Test Menu (para 2-2-4).
F5 "Esc"	Ends the Field Edit, but does <u>NOT</u> save any changes to the setting or value.

Refer to the 3500 / 3500A Maintenance Manual for more information on calibrating the 3500 / 3500A.

2-2-5. UTILITIES SCREEN

When the System Menu, Meters Menu or Self Test Menu is displayed, press the F5 “Util” Key to access the Utilities Menu:

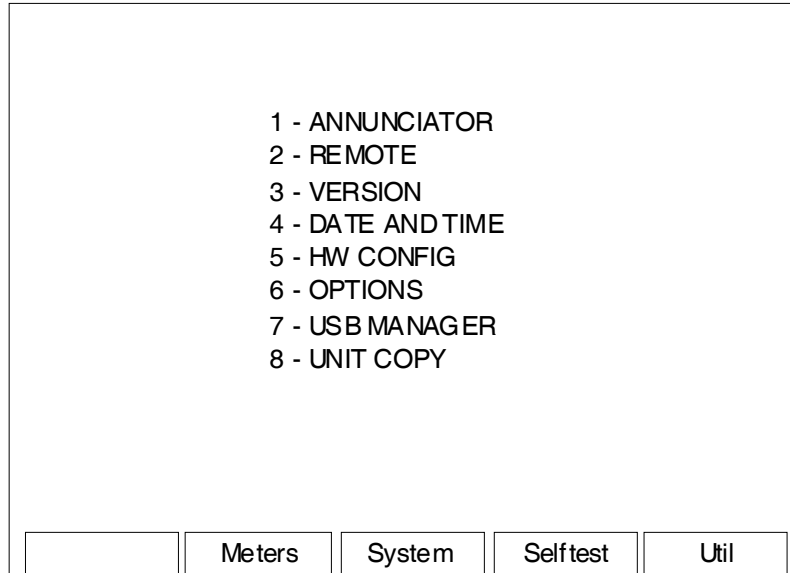

SCREEN FEATURE	FUNCTION
1 - ANNUNCIATOR	Displays the Annunciator Screen (para 2-2-5A).
2 - REMOTE	Displays the Remote Screen (para 2-2-5B).
3 - VERSION	Displays the Version Screen (para 2-2-5C).
4 - DATE / TIME	Displays the Date / Time Screen (para 2-2-5D).
5 - HW CONFIG	Displays the HW Config Screen (para 2-2-5E).
6 - OPTIONS	Displays the Options Screen (para 2-2-5F).
7 - USB MANAGER	Displays the USB Manager Screen (para 2-2-5G).
8 - UNIT COPY	Displays the Unit Copy Screen (para 2-2-5H).
F2 “Meters”	Displays the Meters Menu (para 2-2-3).
F3 “System”	Displays the System Menu (para 2-2-2).
F4 “Selftest”	Displays the Self Test Menu (para 2-2-4).
F5 “Util”	Displays the Utilities Menu (para 2-2-5).

A. Annunciator Screen

When the Utilities Menu is displayed, press the 1 Key to access the Annunciator Screen:

ANNUNCIATOR		↓ 41	□	20	↑ 29	△					
Alarm:	<input type="button" value="On"/>										
Key Press:	Off										
PTT:	Off										
<table border="1" style="width: 100%; text-align: center;"> <tr> <td>Edit</td> <td>Return</td> <td></td> <td></td> <td></td> </tr> </table>							Edit	Return			
Edit	Return										

SCREEN FEATURE	FUNCTION				
Alarm	Used to enable the audible alarm. Select: On or Off				
Key Press	Used to enable the audible tone on each key press. Select: On or Off				
PTT	Used to enable the audible tone when the PTT is pressed on the microphone. Select: On or Off				
F1 "Edit" / "Done"	<table border="0"> <tr> <td>Edit</td> <td>Highlights the selected field to be changed or changes the field value if the field only contains two selections.</td> </tr> <tr> <td>Done</td> <td>Ends the Field Edit and saves the new setting / value.</td> </tr> </table>	Edit	Highlights the selected field to be changed or changes the field value if the field only contains two selections.	Done	Ends the Field Edit and saves the new setting / value.
Edit	Highlights the selected field to be changed or changes the field value if the field only contains two selections.				
Done	Ends the Field Edit and saves the new setting / value.				
F2 "Return"	Displays the Utilities Menu (para 2-2-5).				
F5 "Esc"	Ends the Field Edit, but does <u>NOT</u> save any changes to the setting or value.				

B. Remote Screen

When the Utilities Menu is displayed, press the 2 Key to access the Remote Screen:

REMOTE		↓ 41	□	20	↑ 29	△
Config Port:	ETHERNET					
IP:	10 10 10 193					
Subnet Mask:	255 0 0 0					
Gateway:	0 0 0 0					
Ethernet Port:	9991					
Ethernet Type:	STANDARD					
Port Currently Active:	ETHERNET					
Edit		Return				Config

NOTE: For screen settings to be effective, the F5 “Config” Key should be pressed whenever the screen is changed.

SCREEN FEATURE	FUNCTION
Config Port	Used to select the remote connection. Select: ETHERNET, USB or RS-232
IP	Used to select the IP address. Select: 0 0 0 0 to 255 255 255 255
Subnet Mask	Used to select the Subnet Mask address. Select: 0 0 0 0 to 255 255 255 255
Gateway	Used to select the Gateway address. Select: 0 0 0 0 to 255 255 255 255
Ethernet Port	Used to select the Telnet port. Select: 1000 to 9999
Ethernet Type	Used to select the Ethernet type. Select: STANDARD or DEV (Scripting Option)
Port Currently Active	Used to select the active remote connection. Select: ETHERNET, USB or RS-232

B. Remote Screen (cont)

SCREEN FEATURE	FUNCTION
F1 "Edit" / "Done"	Edit Highlights the selected field to be changed or changes the field value if the field only contains two selections. Done Ends the Field Edit and saves the new setting / value.
F2 "Return"	Displays the Utilities Menu (para 2-2-5).
F5 "Config" / "Esc"	Config Applies the screen parameters for the remote connection settings. Esc Ends the Field Edit, but does <u>NOT</u> save any changes to the setting or value.

B. Remote Screen (cont)

REMOTE ↓ 41 □ □ □ □ 20 ↑ ↑ ↑ 29 □ △

Config Port:

Port Currently Active: USB

NOTE: For screen settings to be effective, the F5 “Config” Key should be pressed whenever the screen is changed.

SCREEN FEATURE	FUNCTION
Config Port	Used to select the remote connection. Select: ETHERNET, USB or RS-232
Port Currently Active	Used to select the active remote connection. Select: ETHERNET, USB or RS-232
F1 “Edit” / “Done”	<p>Edit Highlights the selected field to be changed or changes the field value if the field only contains two selections.</p> <p>Done Ends the Field Edit and saves the new setting / value.</p>
F2 “Return”	Displays the Utilities Menu (para 2-2-5).
F5 “Config” / “Esc”	<p>Config Applies the screen parameters for the remote connection settings.</p> <p>Esc Ends the Field Edit, but does <u>NOT</u> save any changes to the setting or value.</p>

B. Remote Screen (cont)

REMOTE
↓ 41 □ □ □ 20 ↑ ↑ 29 □ △

Config Port:

RS-232 Baud:

RS-232 Parity:

RS-232 #Data:

RS-232 #Stop:

RS-232 Flow:

RS-232 Echo:

Port Currently Active:

RS-232

19200

None

8

1

XON/OFF

On

RS-232

Edit
Return

Config

NOTE: For screen settings to be effective, the F5 “Config” Key should be pressed whenever the screen is changed.

SCREEN FEATURE	FUNCTION
Config Port	Used to select the remote connection. Select: ETHERNET, USB or RS-232
RS-232 Baud	Used to select the Baud Rate. Select: 300, 1200, 2400, 4800, 9600, 19200, 38400, 57600, 115200 or 230400
RS-232 Parity	Used to select the Parity. Select: Even, Odd, Space or None
RS-232 #Data	Used to select the Data Bits. Select: 5, 6, 7 or 8
RS-232 #Stop	Used to select the Stop Bits. Select: 1 or 2
RS-232 Flow	Used to select the Flow. Select: XON/XOFF or Off
RS-232 Echo	Used to select the Echo. Select: On or Off
Port Currently Active	Used to select the active remote connection. Select: ETHERNET, USB or RS-232

B. Remote Screen (cont)

SCREEN FEATURE	FUNCTION
F1 "Edit" / "Done"	Edit Highlights the selected field to be changed or changes the field value if the field only contains two selections. Done Ends the Field Edit and saves the new setting / value.
F2 "Return"	Displays the Utilities Menu (para 2-2-5).
F5 "Config" / "Esc"	Config Applies the screen parameters for the remote connection settings. Esc Ends the Field Edit, but does <u>NOT</u> save any changes to the setting or value.

C. Version Screen

When the Utilities Menu is displayed, press the 3 Key to access the Version Screen:

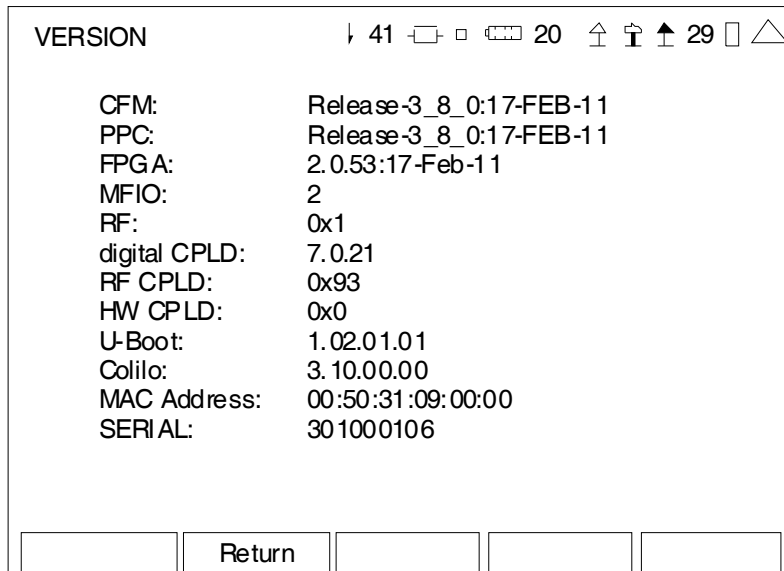

This screen is a representation of the screen that appears.

SCREEN FEATURE	FUNCTION
CFM	Displays the Coldfire processor Version Number/Date.
PPC	Displays the PowerPC processor Version Number/Date.
FPGA	Displays the Field Programmable Gate Array Version Number/Date.
MFIO	Displays the MFIO (Multi-Function I/O Hardware) Version Number.
RF	Displays the RF Version Number.
digital CPLD	Displays the Digital CPLD Version Number.
RF CPLD	Displays the RF CPLD Version Number.
HW CPLD	Displays the HW CPLD Version Number.
U-Boot	Displays the U-Boot Loader Version Number.
Colilo	Displays the Colilo Loader Version Number.
MAC Address	Displays the MAC Address.
SERIAL	Displays the Unit Serial Number.
F2 "Return"	Displays the Utilities Menu (para 2-2-5).

D. Date / Time Screen

When the Utilities Menu is displayed, press the 4 Key to access the Date / Time Screen:

DATE/TIME		↓ 41	□	□	□	20	↑	↑	↑	29	□	△		
Current Date:	Friday, 07:44:16, 17-Jul-2009													
New Date (DMV):	17	JUL	2009											
New Time (HMS):	6	44	2											
Cal Due Date:	25-JUN-2010													
Active Time:	11 Days, 8 Hr, 46 Min, 20 Sec													
Edit			Return											

This screen is a representation of the screen that appears.

SCREEN FEATURE	FUNCTION
Current Date	Displays the current Day of Week, Time (HH:MM:SS) and Date (DD-MMM-YYYY).
New Date	Used to select the Date. Select: Days 01 to 31 (depending upon month selected) Month JAN to DEC Year 2004 to 2099 All Date Fields are scrolling fields.
New Time	Used to select the Time. Select: Hours 00 to 23 Minutes 00 to 59 Seconds 00 to 59 All Time Fields are scrolling fields.
Cal Due Date	Displays the Calibration Expiration Date (DD-MMM-YYYY).
Active Time	Displays the cumulative time the test set has been powered ON (Days, Hours, Minutes, Seconds).
F1 "Edit" / "Done"	Edit Highlights the selected field to be changed. Done Ends the Field Edit and saves the new setting / value.
F2 "Return"	Displays the Utilities Menu (para 2-2-5).
F5 "Esc"	Ends the Field Edit, but does <u>NOT</u> save any changes to the setting or value.

E. HW Config Screen

When the Utilities Menu is displayed, press the 5 Key to access the HW Config (Hardware Configuration) Screen:

HW-CONFIG		↓ 41	□	□	□	20	↑	↑	↑	29	□	△
Save-Recall:	Restore to Default	Scripting:	Auto Exec: Off									
Time-Out Timer:	State: On	Minutes: 20	Minutes Remaining: 20									
Frequency Find:	Threshold (dBm): -30.0	Start Freq (MHz): 2.0	Ch Spacing (kHz): 12.50 Stop Freq (MHz): 1000.0									
Edit	Return											

SCREEN FEATURE	FUNCTION
Save/Recall - Restore to Default	Used to reset all system and screen settings to factory default.
Scripting - Auto Exec	Used to enable the Script Autostart Control.
Time-Out Timer - State	Used to select the Time-Out Timer. Select: On or Off
Time-Out Timer - Minutes	Used to select the number of minutes for the Time-Out Timer. Select: 5 to 300
Time-Out Timer - Minutes Remaining	Displays the remaining minutes before the Time-Out Timer is initiated.
Frequency Find - Threshold	Used to select the minimum signal level. Select: -110.0 to 40.0 dBm
Frequency Find - Ch Spacing	Used to select the channel spacing. Select: 1.00 to 5000.00 kHz
Frequency Find - Start Freq	Used to select the start frequency. Select: 2 to 1000 MHz
Frequency Find - Stop Freq	Used to select the stop frequency. Select: 2 to 1000 MHz

E. HW Config Screen (cont)

SCREEN FEATURE	FUNCTION
F1 "Edit" / "Done"	Edit Highlights the selected field to be changed or changes the field value if the field only contains two selections. Done Ends the Field Edit and saves the new setting / value.
F2 "Return"	Displays the Utilities Menu (para 2-2-5).
F5 "Esc"	Ends the Field Edit, but does <u>NOT</u> save any changes to the setting or value.

F. Options Screen

When the Utilities Menu is displayed, press the 6 Key to access the Options Screen:

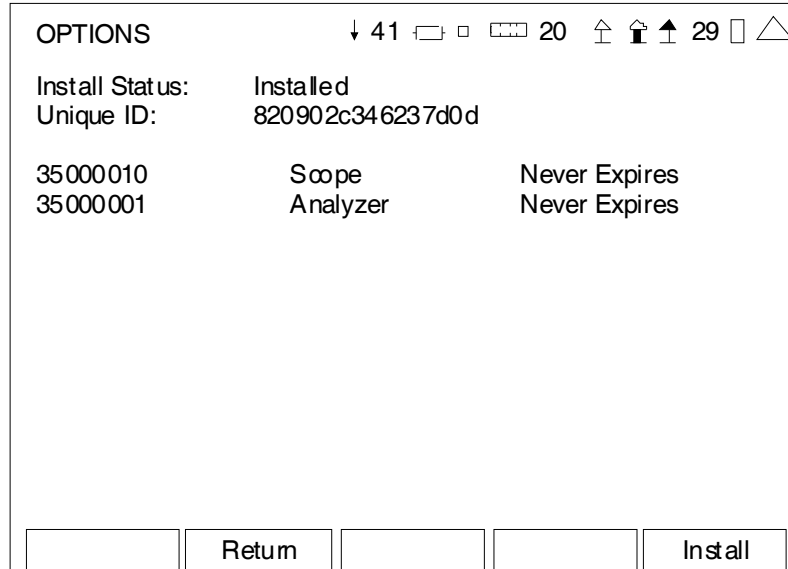

This screen is a representation of the screen that appears.

SCREEN FEATURE	FUNCTION
Install Status	Displays the status when installing Options.
Unique ID	Displays the ID Number of the test set.
Options	Displays the Option Number, Name and Expiration Date of the installed Options.
F2 "Return"	Displays the Utilities Menu (para 2-2-5).
F3 "Pag Up"	Displays the previous page of Options if more than 10 Options are installed.
F4 "Pag Dn"	Displays the next page of Options if more than 10 Options are installed.
F5 "Install"	Used to install Options from USB Memory Device.

Refer to Chapter 4 for more information on installed Options.

G. USB Manager Screen

When the Utilities Menu is displayed, press the 7 Key to access the USB Manager Screen:

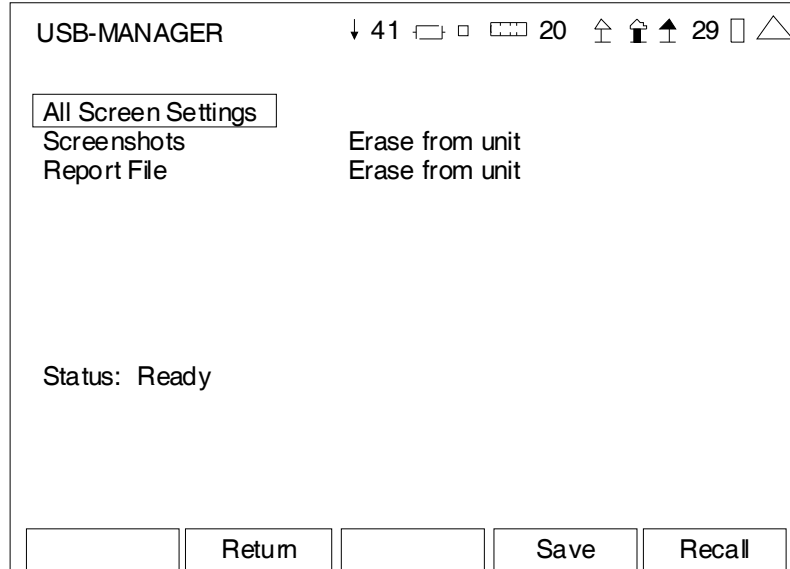

SCREEN FEATURE	FUNCTION
All Screen Settings	Used to return all screen settings to default settings.
Screenshots	Used to save or recall screen captures.
Report File	Used to save or recall reports.
Erase from unit	Used to erase all Screenshots or Report Files.
Status	Displays the status (Stop, In process or Complete) of the USB transfer activity.
F1 "Enter"	Used to confirm the action for the field selected.
F2 "Return"	Displays the Utilities Menu (para 2-2-5).
F4 "Save" / "Yes"	Save Used to store data or test screens on USB Memory Device. Yes Used to confirm save or recall of screen settings
F5 "Recall" / "No"	Recall Used to retrieve saved data or test screens from USB Memory Device. No Used to cancel the save or recall action.

H. Unit Copy Screen

When the Utilities Menu is displayed, press the 8 Key to access the Unit Copy Screen:

UNIT COPY		↓ 41	□	□	□	20	↑	↑	↑	29	□	△
Unit IP addr:	10.10.10.193											
Target IP addr:	10	10	10	193								
Status:	Ready											
<hr/> All Screen Settings Clear and Copy All Screen Settings Copy												
Edit			Return									

SCREEN FEATURE	FUNCTION
Unit IP Addr	Displays the IP Address of the source unit.
Target IP Addr	Used to select the IP Address of the copy unit.
Status	Displays the staus (Ready or Busy) of the copy process.
All Screens Settings Clear and Copy	Used to copy all the Save/Recall files to the cloned unit after all the Save/Recall files have been deleted from the cloned unit.
All Screen Settings Copy	Used to copy all the Save/Recall files to the cloned unit.
F1 "Edit" / "Done" / "Enter"	Edit Highlights the selected field to be changed or changes the field value if the field only contains two selections. Done Ends the Field Edit and saves the new setting / value. Enter Used to confirm the action for the field selected.
F2 "Return"	Displays the Utilities Menu (para 2-2-5).
F5 "Esc"	Ends the Field Edit, but does <u>NOT</u> save any changes to the setting or value.

2-2-6. OTHER METERS / FUNCTIONS

When the Duplex Test Screen, Receiver Test Screen, Transmitter Test Screen or Audio Function Generator Test Screen is displayed, there are several Meters / Functions that are available to be placed on the Test Screen. Refer to the descriptions of the Test Screens for a list of Meters / Functions available for use with each Test Screen.

NOTE: Refer to para 2-2-3 for a description of the SINAD Meter, Distortion Meter, AF Counter and Audio Level Meter Screens.

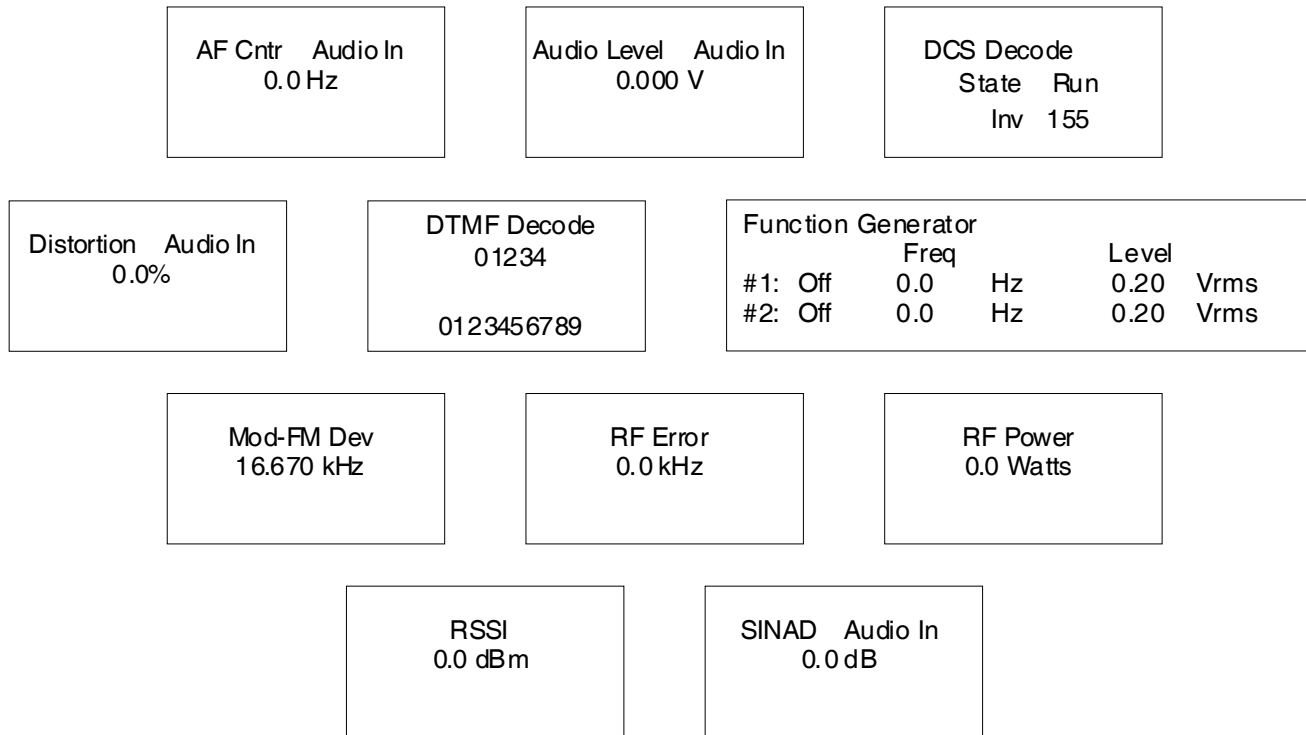

When the mini-meter is accessed on the Test Screen (F1 “Zoom” Key), the Meter is displayed in full view for adjustment of the meter levels and parameters.

There is no Zoom function for the DCS Decode Meter, DTMF Decode Meter and Function Generator.

A. DCS Decode Meter

DCS Decode
State Run
Inv 155

SCREEN FEATURE	FUNCTION
State	Used to enable meter operation. Select: Run or Stop
Format	Used to select the signal format. Select: Inv (Inverted) or NonInv (Non-Inverted)
Meter Readout	Used to display the signal level. Displays “- - -” when no signal is present.

B. DTMF Decode Meter

DTMF Decode
01234

0123456789

SCREEN FEATURE	FUNCTION
1st Line	Displays the current message being decoded.
2nd Line	Displays the last full message decoded.

C. Function Generator

Function Generator				
		Freq		Level
#1:	Off	0.0	Hz	0.20 Vrms
#2:	Off	0.0	Hz	0.20 Vrms

SCREEN FEATURE	FUNCTION
#1 (Function Generator)	Used to select Function Generator #1. Select: On or Off Freq 0 to 20000 Hz in 0.1 Hz increments Level 0.00 to 1.57 Vrms in 0.01 V increments
#2 (Function Generator)	Used to select Function Generator #2. Select: On or Off Freq 0 to 20000 Hz in 0.1 Hz increments Level 0.00 to 1.57 Vrms in 0.01 V increments

NOTE: The combined output level from both Function Generators cannot exceed 1.57 Vrms.

If the level of a selected Function Generator is set so the combined output level would exceed 1.57 Vrms, then the output level of the unselected Function Generator is lowered automatically.

D. Modulation Meter Screen

Mod-FM Dev
16.670 kHz

(MINI-METER)

↓ 41 □ □ □ □ □ 20 ↑ ↑ ↑ 29 □ △

Measure Type	<input type="text" value="PK-PK/2"/>		
Peak Hold	Off		
Avg Reading	1		
Range	Auto		
Limits			
Lower	0.0	State	Off
Upper	10.0	State	Off

16.670

0.0
20.0

kHz

Edit		Hold		Return
------	--	------	--	--------

SCREEN FEATURE	FUNCTION
Measure Type	Used to select the Modulation Meter units of measure. Select: PK-PK/2, PEAK PLUS or PEAK MINUS
Peak Hold	Used to select the Modulation Meter peak hold. Select: On or Off
Avg Reading	Used to select the Modulation Meter Averaging. Select: 1 to 99 This is the number of readings to average for the displayed value.
Range	Used to select the meter range. Select: Auto, 0-1kHz, 0-2kHz, 0-5kHz, 0-10kHz, 0-20kHz, 0-50kHz or 0-100kHz
Limits - Lower	Used to enable the Modulation Meter Lower Limit. Select: 0.0 to 100.0 kHz in 0.1 kHz increments Sets the marker on the Modulation Meter Bar to the Lower Limit selected.
Limits - Upper	Used to enable the Modulation Meter Upper Limit. Select: 0.0 to 100.0 kHz in 0.1 kHz increments Sets the marker on the Modulation Meter Bar to the Upper Limit selected.
State - Lower Limit	Used to display the Lower Limit Marker on the Modulation Meter Bar. Select: On or Off

D. Modulation Meter Screen (cont)

SCREEN FEATURE	FUNCTION
State - Upper Limit	Used to display the Upper Limit Marker on the Modulation Meter Bar. Select: On or Off
Modulation Meter Bar	A graphical representation of the received Modulation Meter readings.
F1 "Edit" / "Done"	Edit Highlights the selected field to be changed or changes the field value if the field only contains two selections. Done Ends the Field Edit and saves the new setting / value.
F2 "Save"	Performs a data dump of frames displayed on the screen, including configurations, readings and settings. The data dump is stored in a time-stamped ASCII report and can be retrieved at a later time.
F3 "Hold" / "Resume"	Hold Freezes the screen. Resume Restores the screen to active mode.
F5 "Return" / "Esc"	Return Closes the Modulation Meter Screen and returns to the Test Screen. Esc Ends the Field Edit, but does <u>NOT</u> save any changes to the setting or value.

E. RF Error Meter Screen

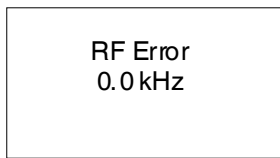

(MINI-METER)

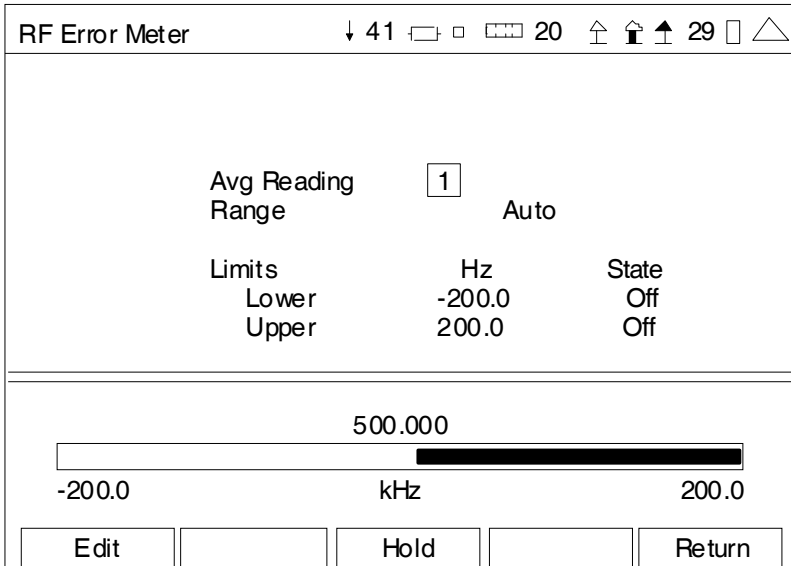

SCREEN FEATURE	FUNCTION
Avg Reading	Used to select the RR Error Meter Averaging. Select: 1 to 99 This is the number of readings to average for the displayed value.
Range	Used to select the meter range. Select: Auto, -1-1kHz, -2-2kHz, -5-5kHz, -10-10kHz, -20-20kHz, -50-50kHz, -100-100kHz or -200-200kHz
Limits - Lower	Used to enable the RR Error Meter Lower Limit. Select: -200.0 to 200.0 Hz in 0.1 Hz increments Sets the marker on the RF Error Meter Bar to the Lower Limit selected.
Limits - Upper	Used to enable the RF Error Meter Upper Limit. Select: -200.0 to 200.0 Hz in 0.1 Hz increments Sets the marker on the RF Error Meter Bar to the Upper Limit selected.
State - Lower Limit	Used to display the Lower Limit Marker on the RF Error Meter Bar. Select: On or Off
State - Upper Limit	Used to display the Upper Limit Marker on the RF Error Meter Bar. Select: On or Off
RF Error Meter Bar	A graphical representation of the received RF Error Meter readings.

E. RF Error Meter Screen (cont)

SCREEN FEATURE	FUNCTION
F1 "Edit" / "Done"	Edit Highlights the selected field to be changed or changes the field value if the field only contains two selections. Done Ends the Field Edit and saves the new setting / value.
F2 "Save"	Performs a data dump of frames displayed on the screen, including configurations, readings and settings. The data dump is stored in a time-stamped ASCII report and can be retrieved at a later time.
F3 "Hold" / "Resume"	Hold Freezes the screen. Resume Restores the screen to active mode.
F5 "Return" / "Esc"	Return Closes the RF Error Meter Screen and returns to the Test Screen. Esc Ends the Field Edit, but does <u>NOT</u> save any changes to the setting or value.

F. RF Power Meter Screen

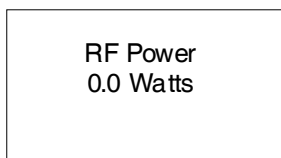

(MINI-METER)

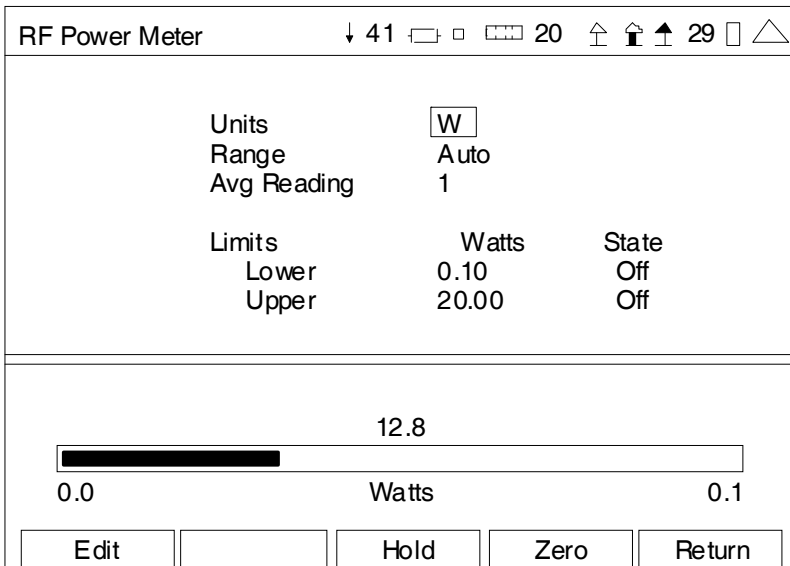

SCREEN FEATURE	FUNCTION
Units	Used to select the RF Power Meter units of measure. Select: dBm or W
Range	Used to select the meter range. Select: Auto, -0-0.1W, 0-0.2W, 0-0.5W, 0-1W, 0-2W, 0-5W, 0-10W, 0-20W, 0-50W, 0-100W or 0-200W
Avg Reading	Used to select the RF Power Meter Averaging. Select: 1 to 99 This is the number of readings to average for the displayed value.
Limits - Lower	Used to enable the RF Power Meter Lower Limit. Select: 0 to 43 dBm in 0.01 dB increments 0 to 53 dBm in 0.01 dB increments (with Cable Offset) 0 to 20 W in 0.01 W increments 0 to 200 W in 0.01 W increments (with Cable Offset) Sets the marker on the RF Power Meter Bar to the Lower Limit selected.
Limits - Upper	Used to enable the RF Power Meter Upper Limit. Select: 0 to 43 dBm in 0.01 dB increments 0 to 53 dBm in 0.01 dB increments (with Cable Offset) 0 to 20 W in 0.01 W increments 0 to 200 W in 0.01 W increments (with Cable Offset) Sets the marker on the RF Power Meter Bar to the Upper Limit selected.

F. RF Power Meter Screen (cont)

SCREEN FEATURE	FUNCTION
State - Lower Limit	Used to display the Lower Limit Marker on the RF Power Meter Bar. Select: On or Off
State - Upper Limit	Used to display the Upper Limit Marker on the RF Power Meter Bar. Select: On or Off
RF Power Meter Bar	A graphical representation of the received RF Power Meter readings.
F1 "Edit" / "Done" / "Next"	<p>Edit Highlights the selected field to be changed or changes the field value if the field only contains two selections.</p> <p>Done Ends the Field Edit and saves the new setting / value.</p> <p>Next Continues with next step of Zero function.</p>
F2 "Save"	Performs a data dump of frames displayed on the screen, including configurations, readings and settings. The data dump is stored in a time-stamped ASCII report and can be retrieved at a later time.
F3 "Hold" / "Resume" / "Abort"	<p>Hold Freezes the screen.</p> <p>Resume Restores the screen to active mode.</p> <p>Abort Ends the Zero function.</p>
F4 "Zero"	Instruction pop-ups are displayed to zero the RF Power Meter.
F5 "Return" / "Esc"	<p>Return Closes the RF Power Meter Screen and returns to the Test Screen.</p> <p>Esc Ends the Field Edit, but does <u>NOT</u> save any changes to the setting or value.</p>

G. RSSI Meter Screen

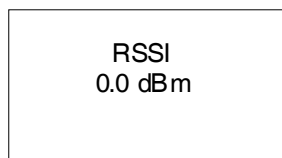

(MINI-METER)

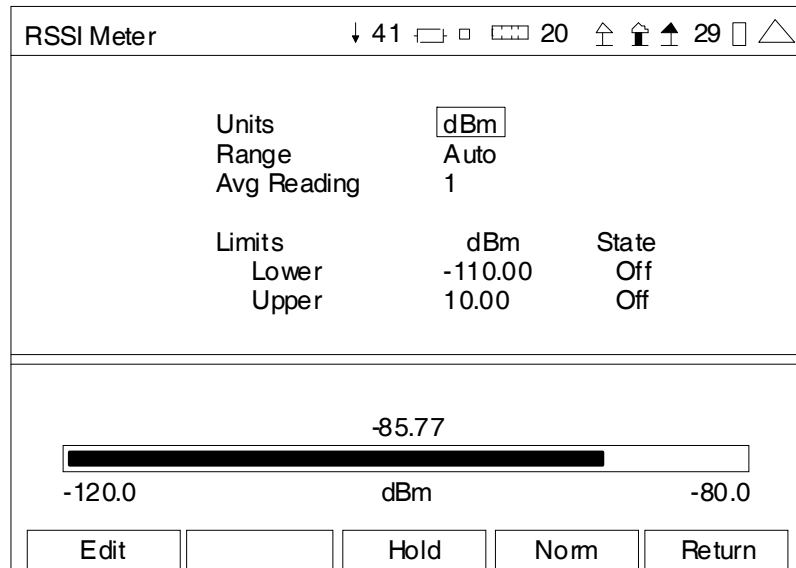

SCREEN FEATURE	FUNCTION
Units	Used to select the RSSI Meter units of measure. Select: dBm or W
Range	Used to select the meter range. Select: Auto, -120-(-80)dBm, -100-(-60)dBm, -80-(-40)dBm, -60-(-20)dBm, -40-0dBm, -20-20dBm, 0-40dBm or 20-60dBm
Avg Reading	Used to select the RSSI Meter Averaging. Select: 1 to 99 This is the number of readings to average for the displayed value.
Limits - Lower	Used to enable the RSSI Meter Lower Limit. Select: -110 to 43 dBm in 0.01 dB increments -110 to 53 dBm in 0.01 dB increments (with Cable Offset) 0 to 100 W in 0.01 W increments 0 to 100 mW in 0.01 mW increments (with Cable Offset) Sets the marker on the RSSI Meter Bar to the Lower Limit selected.
Limits - Upper	Used to enable the RSSI Meter Upper Limit. Select: -110 to 43 dBm in 0.01 dB increments -110 to 53 dBm in 0.01 dB increments (with Cable Offset) 0 to 100 W in 0.01 W increments 0 to 100 mW in 0.01 mW increments (with Cable Offset) Sets the marker on the RSSI Meter Bar to the Upper Limit selected.

G. RSSI Meter Screen (cont)

SCREEN FEATURE	FUNCTION
State - Lower Limit	Used to display the Lower Limit Marker on the RSSI Meter Bar. Select: On or Off
State - Upper Limit	Used to display the Upper Limit Marker on the RSSI Meter Bar. Select: On or Off
RSSI Meter Bar	A graphical representation of the received RSSI Meter readings.
F1 "Edit" / "Done" / "Next"	<p>Edit Highlights the selected field to be changed or changes the field value if the field only contains two selections.</p> <p>Done Ends the Field Edit and saves the new setting / value.</p> <p>Next Continues with next step of Zero function.</p>
F2 "Save"	Performs a data dump of frames displayed on the screen, including configurations, readings and settings. The data dump is stored in a time-stamped ASCII report and can be retrieved at a later time.
F3 "Hold" / "Resume"	<p>Hold Freezes the screen.</p> <p>Resume Restores the screen to active mode.</p>
F4 "Norm" / "Abort"	<p>Norm Instruction pop-ups are displayed to normalize the RSSI Meter.</p> <p>Abort Ends the Normalize function.</p>
F5 "Return" / "Esc"	<p>Return Closes the RSSI Meter Screen and returns to the Test Screen.</p> <p>Esc Ends the Field Edit, but does <u>NOT</u> save any changes to the setting or value.</p>

2-2-7. OTHER FUNCTIONS

A. Recall Configuration Screen

When the Duplex Test Screen, Receiver Test Screen, Transmitter Test Screen, or Audio Function Generator Screen is displayed, access the Recall Field and press the F1 “Zoom” Key to display the Recall Configuration Screen.

The Recall Configuration Screen gives the user access to recall a test screen from internal memory.

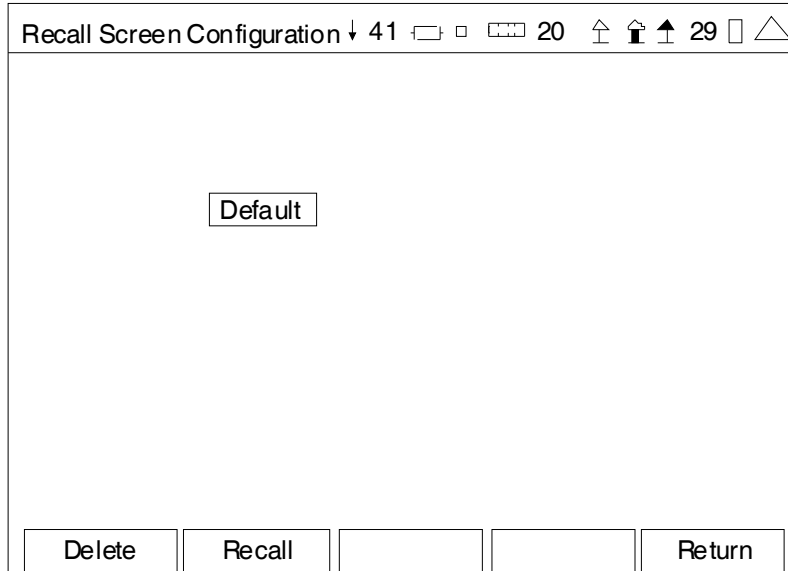

SCREEN FEATURE	FUNCTION
Recall Selection	Displays the test screens stored in internal memory.
Default	Restores the test screen to a known condition.
F1 “Delete”	Erases the selected stored test screen from internal memory.
F2 “Recall”	Retrieves selected test screen from internal memory.
F5 “Return”	Closes the Recall Configuration Screen and returns to the Test Screen.

B. Save Configuration Screen

When the Duplex Test Screen, Receiver Test Screen, Transmitter Test Screen, or Audio Function Generator Screen is displayed, access the Save Field and press the F1 “Zoom” Key to display the Save Configuration Screen.

The Save Configuration Screen gives the user access to store a test screen into internal memory.

SCREEN FEATURE	FUNCTION				
Edit File Name	Used to enter a new file name (5 characters maximum). Use Number Keys and UP / DOWN Keys to enter characters.				
Hints	Shows the numeric and corresponding alphabetical characters for use when entering a new file name.				
F1 “Edit” / “Done”	<table border="0"> <tr> <td>Edit</td> <td>Highlights the selected field to be changed or changes the field value if the field only contains two selections.</td> </tr> <tr> <td>Done</td> <td>Ends the Field Edit.</td> </tr> </table>	Edit	Highlights the selected field to be changed or changes the field value if the field only contains two selections.	Done	Ends the Field Edit.
Edit	Highlights the selected field to be changed or changes the field value if the field only contains two selections.				
Done	Ends the Field Edit.				
F2 “Store”	Saves the selected test screen into internal memory.				
F5 “Return” / Esc”	<table border="0"> <tr> <td>Return</td> <td>Closes the Save Configuration Screen and returns to the Test Screen.</td> </tr> <tr> <td>Esc</td> <td>Ends the Field Edit.</td> </tr> </table>	Return	Closes the Save Configuration Screen and returns to the Test Screen.	Esc	Ends the Field Edit.
Return	Closes the Save Configuration Screen and returns to the Test Screen.				
Esc	Ends the Field Edit.				

2-3. PREVENTIVE MAINTENANCE CHECKS AND SERVICES

2-3-1. GENERAL

When doing any Preventive Maintenance or routine checks, keep in mind the WARNINGS and CAUTIONS about electrical shock and bodily harm.

2-3-2. PREVENTIVE MAINTENANCE PROCEDURES

A. Tools, Materials and Equipment Required

No tools or equipment are required for operator preventive maintenance. Cleaning materials required are a lint free cloth and mild liquid detergent.

B. Routine Checks

Preventive Maintenance is limited to routine checks such as shown below:

- Cleaning
- Dusting
- Wiping
- Checking for frayed cables
- Storing items not in use
- Covering unused receptacles
- Checking for loose nuts, bolts or screws

C. Schedule of Checks

Perform routine checks whenever required.

2-4. OPERATION UNDER USUAL CONDITIONS

2-4-1. TURN-ON PROCEDURE

Follow these instructions to initialize the 3500 / 3500A:

1. Press the POWER Key to initialize the 3500 / 3500A.
2. Verify the POWER Indicator illuminates GREEN.

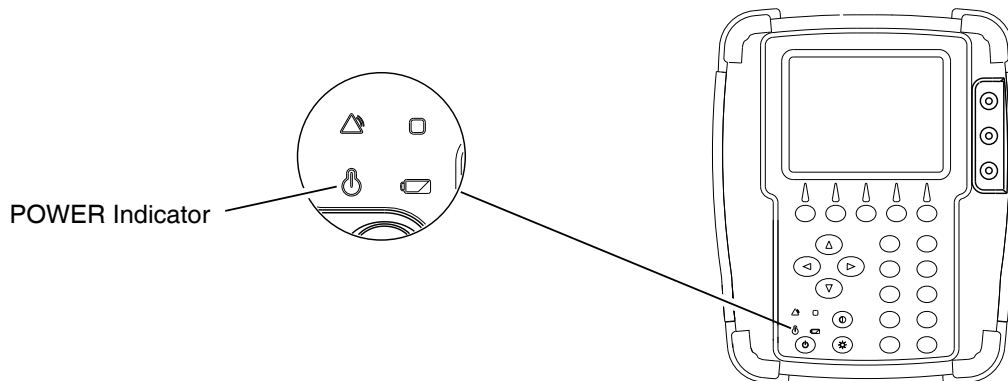

3. The Opening Screen is displayed. When the Test Set is initialized, the Startup Screen is displayed and then the 3500 / 3500A displays the System Menu.

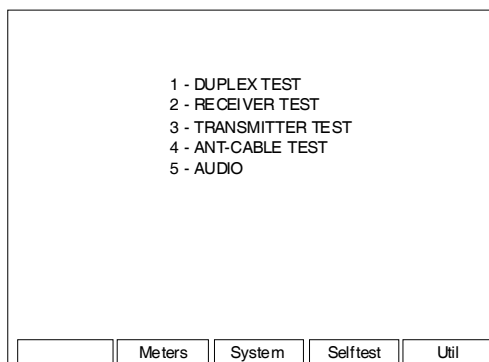
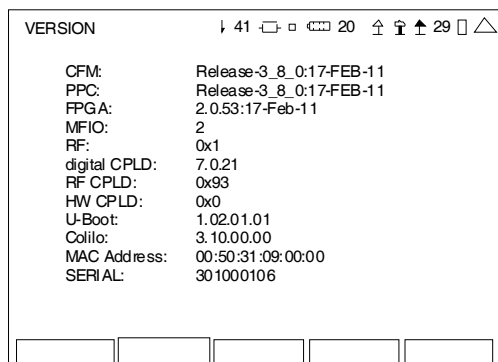

*This screen is a representation
of the screen that appears.*

2-4-1. TURN-ON PROCEDURE (cont)

4. The operator can now choose the desired menu / screen:

TEST SCREENS

Press the associated key to display the desired screen.

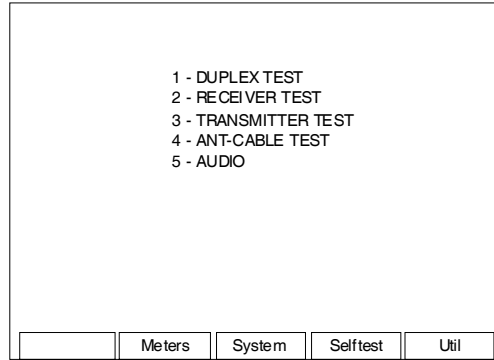

METERS MENU

Press the F2 "Meters" Key on the System Menu to display the Meters Menu.

Press the associated key to display the desired screen.

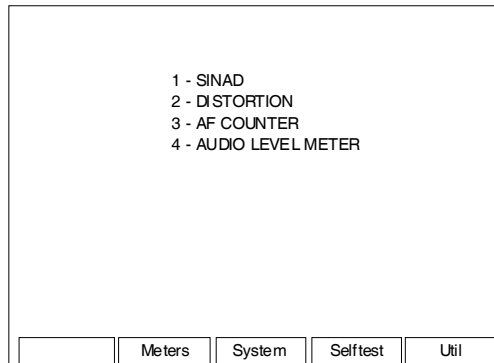

SELF TEST MENU

Press the F4 "Selftest" Key on the System Menu to display the Self Test Menu.

Press the associated key to display the desired screen.

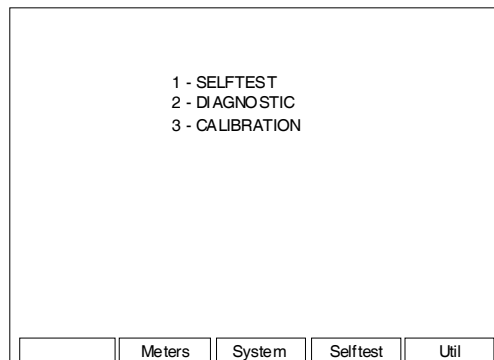

UTILITIES MENU

Press the F5 "Util" Key on the System Menu to display the Utilities Menu.

Press the associated key to display the desired screen.

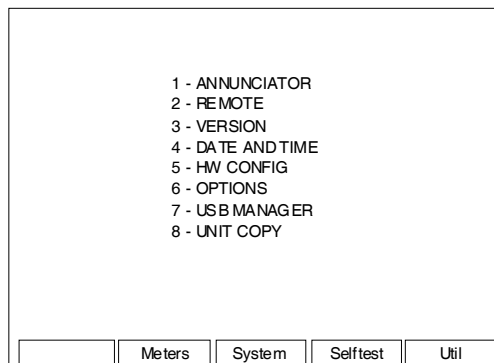

2-4-2. SCREEN WARNINGS AND CAUTIONS

The 3500 / 3500A provides the user with alarm prompts to warn the user of an impending condition that might damage the 3500 / 3500A.

The alarm prompts are displayed at the bottom of the test screen. All screen activity and updates are placed on hold until the condition is cleared.

RECEIVER TEST				↓ 41	□	□	□	20	↑	↑	↑ 29	□	△
Generator Off MH z <input type="text" value="151.625000"/> Port: SWR Level: -50 dBm Ext Attn dB: 0				SINAD Audio In 0.0 dB									
Modulator Freq FM Analog Gen 1: Off 1000.0 Hz 6.25 kHz Gen 2: On 150.0 Hz 3.25 kHz MIC: On 6.25 kHz Ext Aud: Off Load: High Z				Distortion Audio In 0.0%									
Volume: 100 Squelch: -50 dBm Speaker: Audio In AudOut: Audio In Save Recall				AF Cntr Audio In 0.0 Hz									
SWR OVERLOAD! Remove power from SWR port!												<input type="button" value="Enter"/>	

This screen is a representation of the screen that appears.

2-5. OPERATING PROCEDURES

Operating Procedures for the 3500 / 3500A are provided.

Refer to para 2-1 for further description of the controls, indicators and connectors.

Refer to para 2-2 for further description of the operation screens and menus.

2-5-1. INTRODUCTION

The 3500 / 3500A is intended to be used to determine that all external connections are in place on the vehicle radio installation and that the antenna is connected and matched to the transmitter.

When the 3500 / 3500A is used in conjunction with the BIT built into the UUT, the user is able to establish, with a 95% probability rate, that the installation is operational. If the UUT is not operational, the user can determine where the fault lies to such a level as to recommend corrective action (i.e., replace the antenna, return the radio for repair etc.).

2-5-2. TYPICAL VEHICLE INSTALLATION TEST

1. Connect the appropriate supplied Antenna to the 3500 / 3500A ANT Connector.

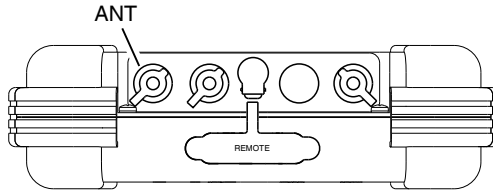

062-007

2. Connect the Headset to the 3500 / 3500A AUDIO Connector.

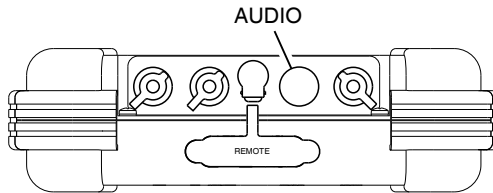

062-008

3. The Duplex Test Screen should be displayed.

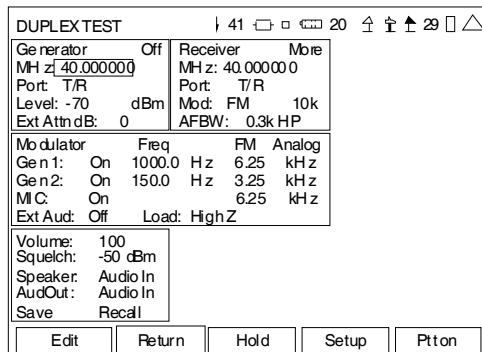

4. With the cursor on the Generator Port Field, press the F1 "Edit" Key and use the ▲ UP Key or ▼ DOWN Key to select the ANT Connector. Press the F1 "Done" Key to save the setting.

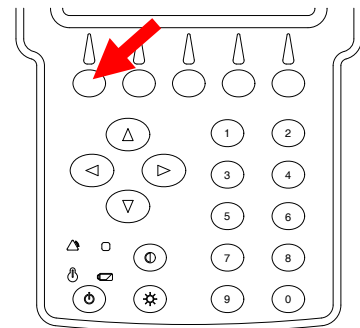
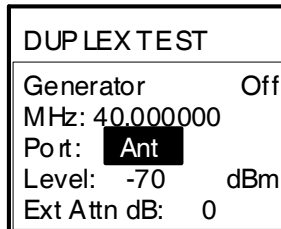
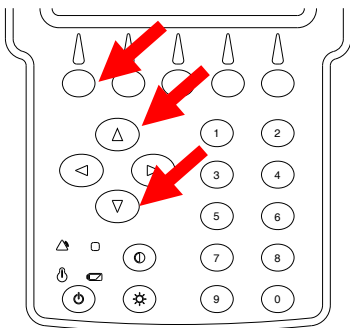

2-5-2. TYPICAL VEHICLE INSTALLATION TEST (cont)

- With the cursor on the Generator MHz Field, press the F1 "Edit" Key and use the ◀ LEFT, ▶ RIGHT and Number Keys to select the desired frequency. Press the F1 "Done" Key to save the setting.

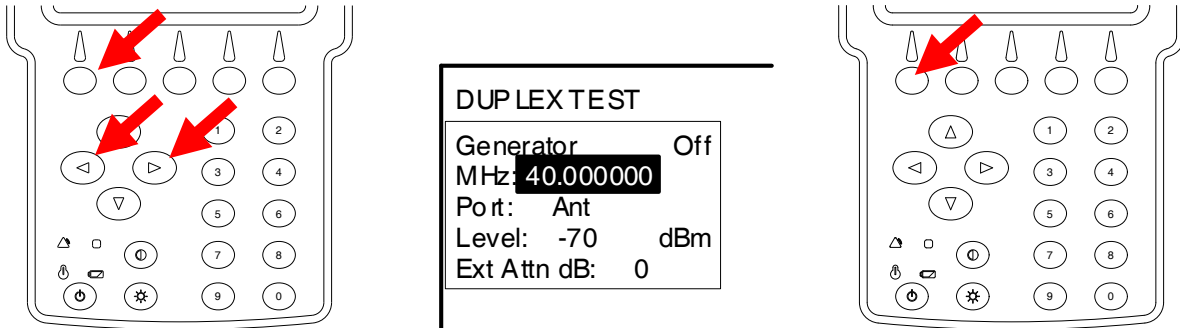

- With the cursor on the Generator Level Field, press the F1 "Edit" Key and use the ◀ LEFT, ▶ RIGHT and Number Keys to select the desired RF level. Press the F1 "Done" Key to save the setting.

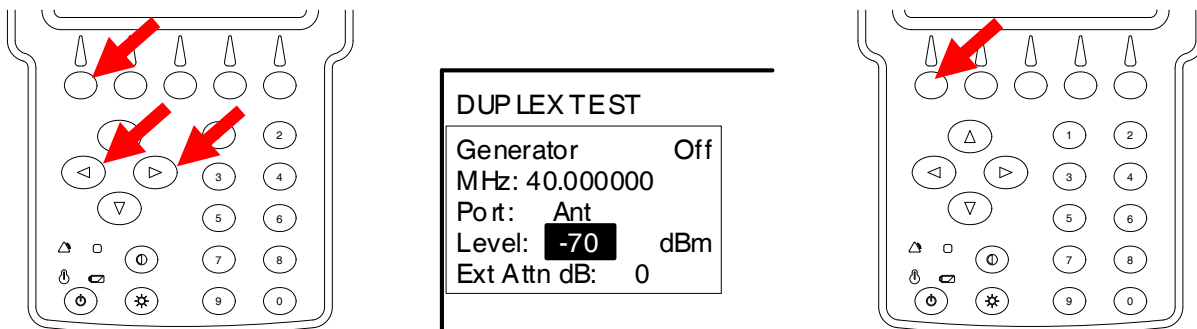

- Press the F4 "Setup" Key to display the Duplex Setup Screen.

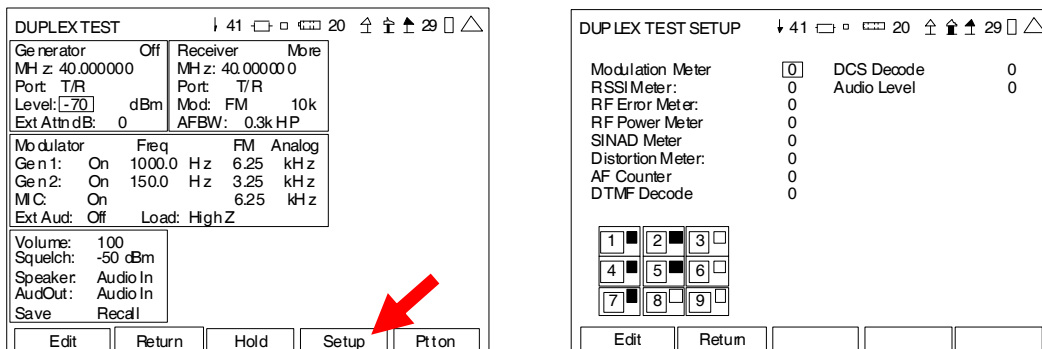

2-5-2. TYPICAL VEHICLE INSTALLATION TEST (cont)

- With the cursor on the Modulation Meter Field, press the F1 "Edit" Key and the 3 Key to display the Modulation Meter in the top right portion of the Duplex Test Screen. Press the F1 "Done" Key to save the setting.

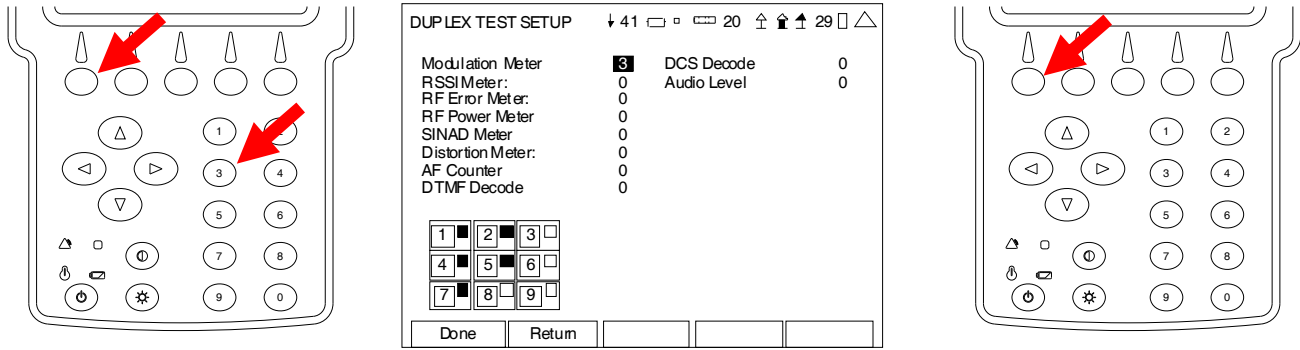

- With the cursor on the RSSI Meter Field, press the F1 "Edit" Key and the 6 Key to display the RSSI Meter in the middle right portion of the Duplex Test Screen. Press the F1 "Done" Key to save the setting.

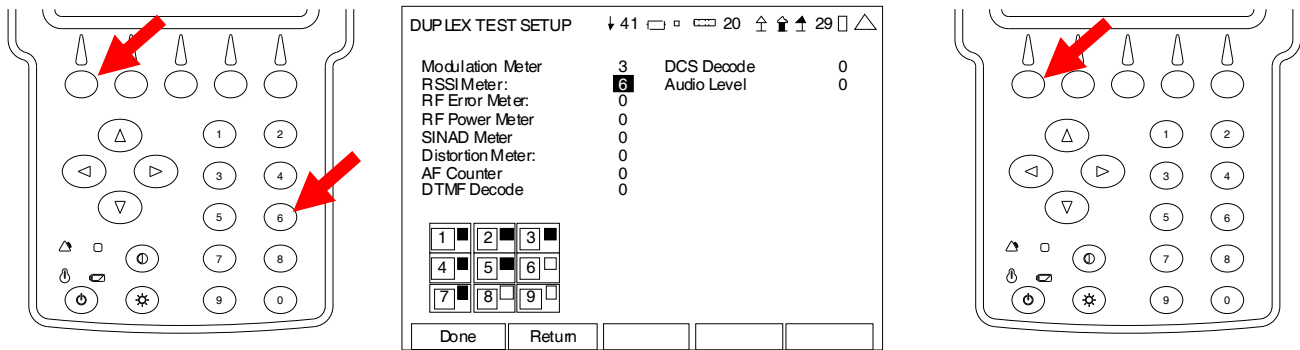

- With the cursor on the RF Error Meter Field, press the F1 "Edit" Key and the 9 Key to display the RF Error Meter in the bottom right portion of the Duplex Test Screen. Press the F1 "Done" Key to save the setting.

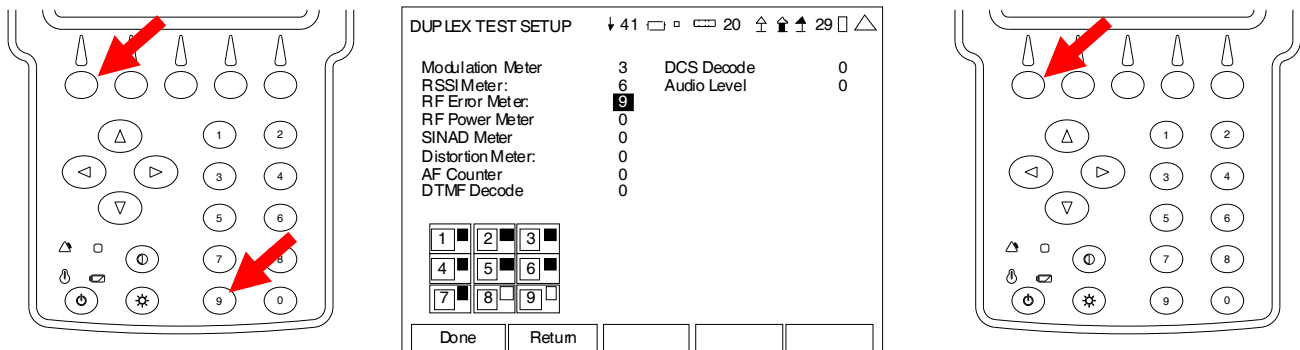

2-5-2. TYPICAL VEHICLE INSTALLATION TEST (cont)

- Press the F2 "Return" Key to display the Duplex Test Screen.

DUPLEX TEST SETUP			
Modulation Meter	3	DCS Decode	0
RSSI Meter:	6	Audio Level	0
RF Error Meter:	9		
RF Power Meter	0		
SINAD Meter	0		
Distortion Meter:	0		
AF Counter	0		
DTMF Decode	0		

1	2	3
4	5	6
7	8	9

Done	Return			
------	--------	--	--	--

DUPLEX TEST			
Generator	Off	Receiver	More
MHz: 40.000000		MHz: 40.000000	
Port: T/R		Port: T/R	MOD-FMDev
Level: [-70] dBm		Mod: FM	16.435 kHz
Ext Attn dB: 0		AFBW: None	

Modulator	Freq	FM	Analog	
Gen 1: On	1000.0 Hz	6.25 kHz		RSSI
Gen 2: On	1500.0 Hz	3.25 kHz		0.0 dBm
MIC: On		6.25 kHz		
Ext Aud: Off	Load: High Z			

Volume:	100		
Squelch:	-50 dBm		RF Error
Speaker:	Audio In		0.0 kHz
AudOut:	Audio In		
Save	Recall		

Edit	Return	Hold	Setup	Ptton
------	--------	------	-------	-------

- Stand within 5 ft of the vehicle antenna.
- With a second operator in the vehicle, talk back and forth on several frequencies to determine that the radio is transmitting and receiving messages over the entire system.

Monitor field strength indicator for proper signal level.

Repeat this test at different locations around the antenna.

- If malfunction(s) occur in the testing process, check the Antenna under test first using SWR.
- If Antenna test is positive, troubleshoot malfunction(s) in Radio.

2-5-3. ADVANCED VEHICLE INSTALLATION TESTING

1. Connect the 3500 / 3500A T/R Connector to the Radio Antenna Port. If the Radio rated output power is >20 W, insert attenuator between the T/R Connector and the Radio Antenna port. Key the Radio and measure the Radio's forward output power, frequency and modulation.
2. Unkey the Radio, select Receiver Test and set up the RF level so a 1 kHz tone can be heard in the Radio (add 150 Hz squelch tone if required). Select frequency and modulation.
3. Measure sensitivity by reducing the RF level of the 3500 / 3500A until the audio signal can no longer be heard in the Radio. If a RF Power Amplifier is installed between the Radio and antenna, take a measurement between the RF Power Amplifier and the antenna (install the optional attenuator), then measure between the Radio and the RF Power Amplifier to determine if the Radio or the RF Power Amplifier is faulty.
4. Connect the antenna to the 3500 / 3500A SWR Connector and measure VSWR. For installations with multiple bulkhead connections, repeat this test at each bulkhead to determine if a bad connection exists between the antenna and the Radio. The 3500 / 3500A SWR Connector needs to be calibrated the first time.
5. Perform BIT (SELF TEST) on the Radio to detect radio faults not related to the RF output.

2-5-4. MEASURING SWR

1. With the System Menu displayed, press the 4 Key to display the ANT-Cable Test Screen.

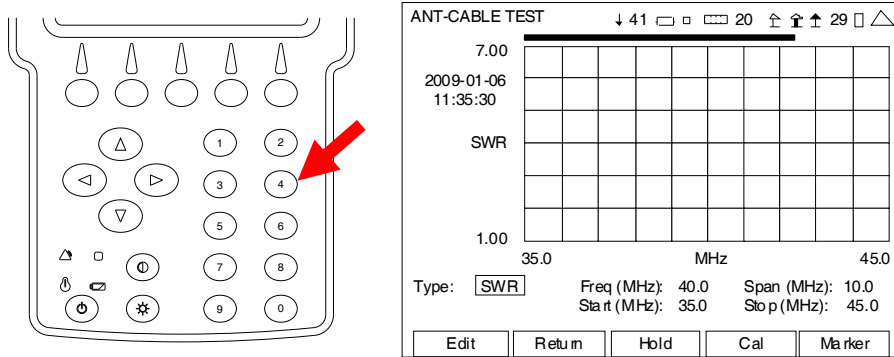

2. With the cursor on the Type Field, press the F1 "Edit" Key and use the ▲ UP Key or ▼ DOWN Key to select SWR. Press the F1 "Done" Key to save the setting.

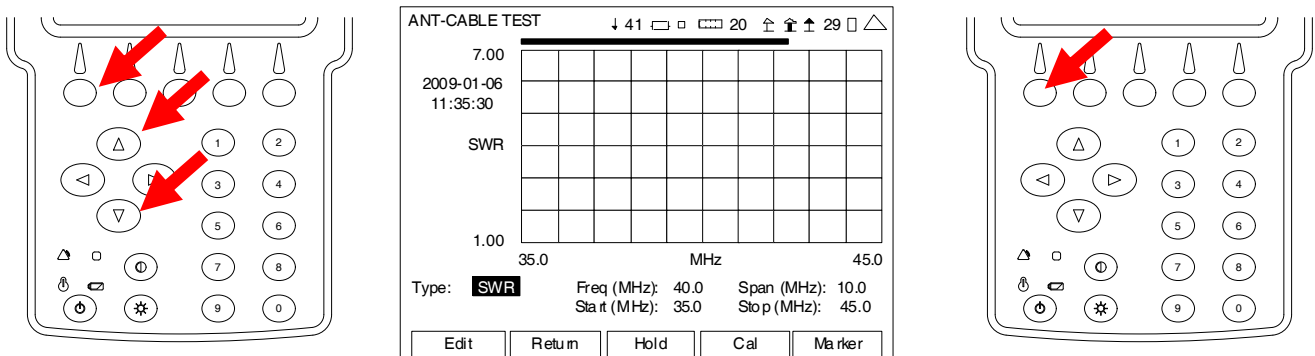

3. With the cursor on the Freq Field, press the F1 "Edit" Key and use the Number Keys to select the desired center frequency. Press the F1 "Done" Key to save the setting.

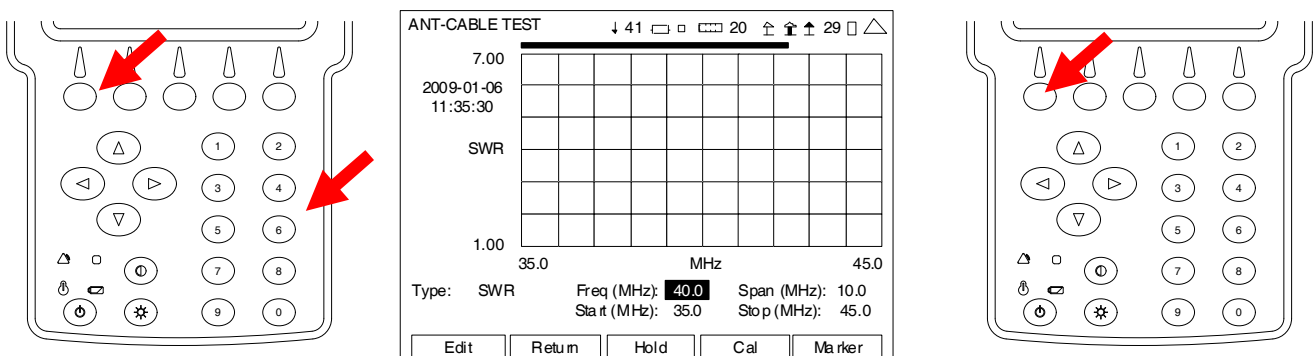

2-5-4. MEASURING SWR (cont)

- With the cursor on the Span Field, press the F1 "Edit" Key and use the Number Keys to select the desired frequency span. Press the F1 "Done" Key to save the setting.

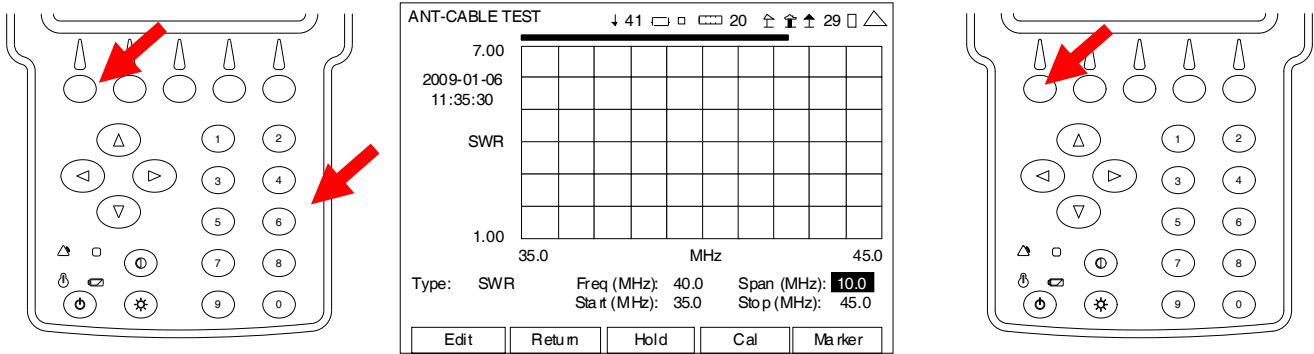

- Press the F4 "Cal" Key to start the SWR Calibration. Follow the instructions on the screen to complete the SWR Calibration. When SWR Calibration is completed ("Calibration Complete" displayed on screen), press the F5 "Done" Key to return to the ANT-Cable Test Screen.

NOTE: Calibration must be performed at the point the operator is connecting to the system under test:

- If the supplied test cable is being used to connect to the system under test, calibration is to be performed at the end of the test cable. Test cable should not exceed four feet in length.
- If the system under test cable is being connected directly to the 3500 / 3500A, then calibration is to be performed at the SWR Connector.

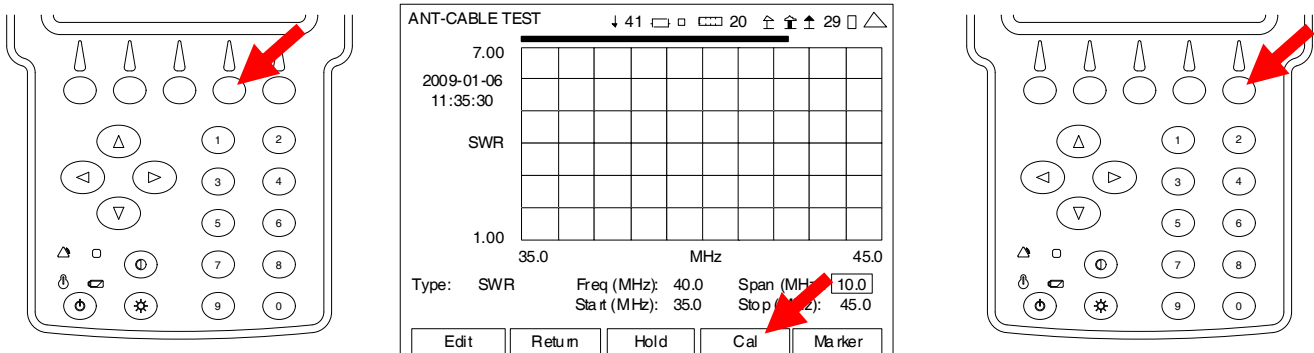

NOTE: Once the SWR Connection is calibrated, the SWR Connector remains in the calibration state until the user changes the point of connection to the UUT. The ANT-Cable Test Screen displays the Date and Time of the last Calibration above the Graphical Display.

2-5-4. MEASURING SWR (cont)

6. Connect the System Under Test to the SWR Connector at the point of calibration.
7. The Graphical Display is updated approximately every 20 seconds. Allow at least two updates of the Graphical Display to insure data is valid.

NOTE: The 3500 / 3500A checks the electrical length of the load under test. If the frequency span selected is too wide, the 3500 / 3500A automatically adjusts the frequency span to insure an accurate measurement, and displays 'Span Clipped' above the graphical display to alert the user the frequency span was changed.

8. Press the F5 "Marker" Key to display the ANT-Cable Test Screen in Marker Mode.

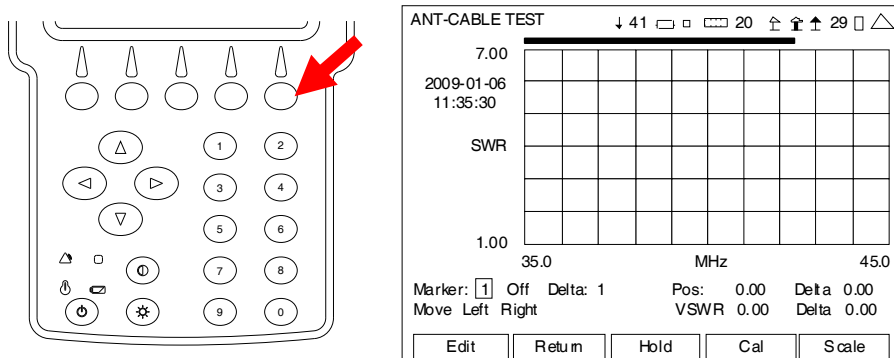

9. With the data displayed on the Graphical Display, the Markers are used to determine the SWR at any point across the span. With the cursor on the Marker Number Field, use the ▲ UP Key or ▼ DOWN Key to select a Marker (1, 2 or 3). Press the F1 "Done" Key to save the setting.

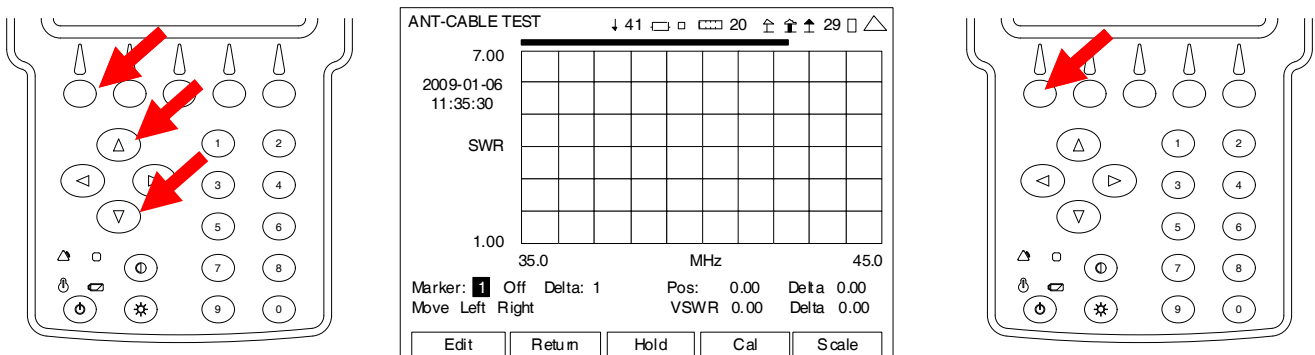

2-5-4. MEASURING SWR (cont)

10. Move the cursor to the right and use the ▲ UP Key or ▼ DOWN Key to select On.

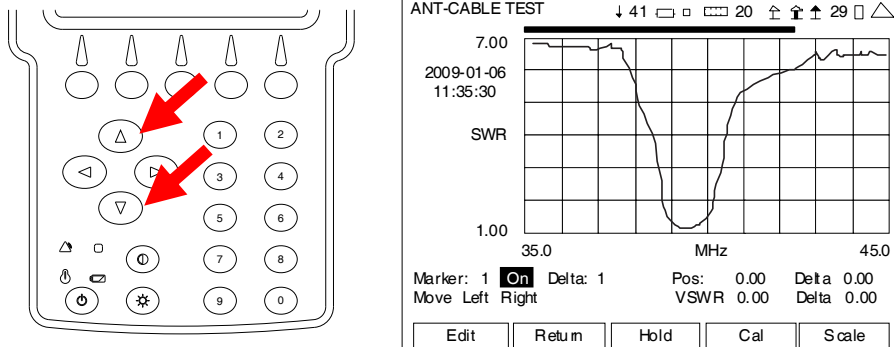

11. With the cursor on the Move/Min/Max Field, press the F1 "Edit" Key and use the ▲ UP Key or ▼ DOWN Key to select Move. Press the F1 "Done" Key to save the setting.

NOTE: Selecting "Move" positions the Marker to the next Data Point on the Graphical Display.

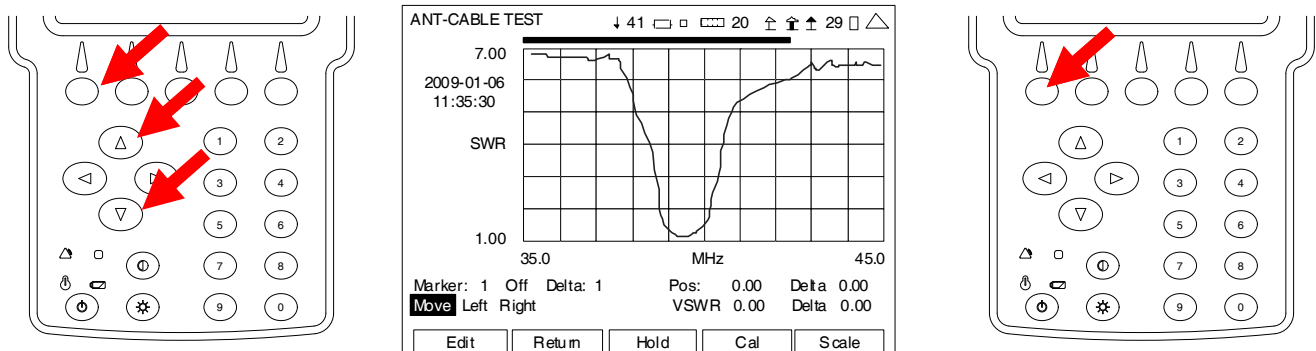

2-5-4. MEASURING SWR (cont)

12. With the cursor on the Right Field, press the F1 "Enter" Key to move the Marker to the right on the Graphical Display.

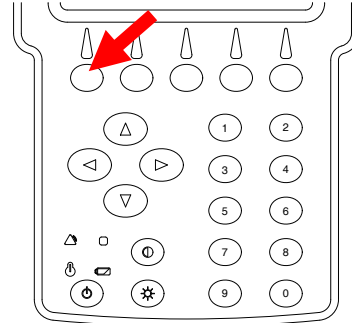
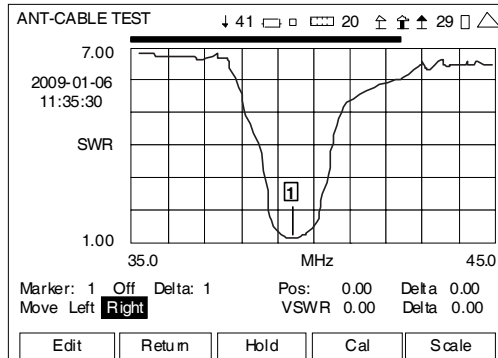

NOTE: When first enabled, a Marker is at the far left of the Graphical Display. Up to three Markers may be placed on the Graphical Display at a time. The Marker shown in the Marker Number Field is active. The active Marker can be moved using the Move/Min/Max and Left Right Fields with the readings, corresponding to the Marker position, displayed in fields under the Graphical Display.

2-5-5. MEASURING DTF (Distance to Fault)

1. With the System Menu displayed, press the 4 Key to display the ANT-Cable Test Screen.

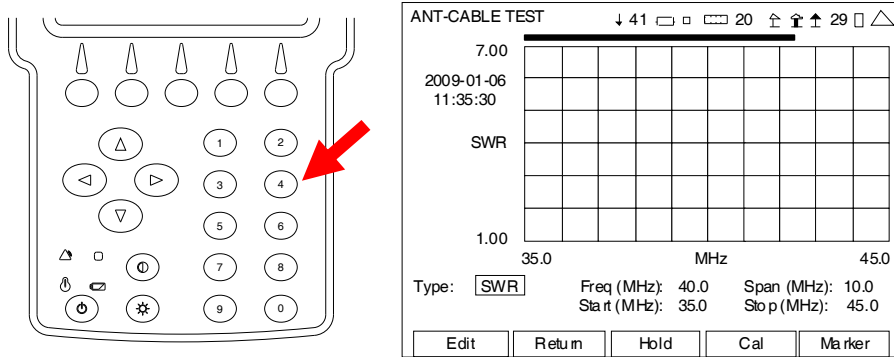

2. Press the F4 “Cal” Key to start the SWR Calibration. Follow the instructions on the screen to complete the SWR Calibration. When SWR Calibration is completed (“Calibration Complete” displayed on screen), press the F5 “Done” Key to return to the ANT-Cable Test Screen.

NOTE: Calibration must be performed at the point the operator is connecting to the system under test:

- If the supplied test cable is being used to connect to the system under test, calibration is to be performed at the end of the test cable. Test cable should not to exceed four feet in length.
- If the system under test cable is being connected directly to the 3500 / 3500A, then calibration is to be performed at the SWR Connector.

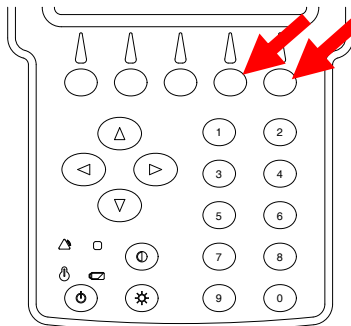

NOTE: Once the SWR Connection is calibrated, the SWR Connector remains in the calibration state until the user changes the point of connection to the UUT. The ANT-Cable Test Screen displays the Date and Time of the last Calibration above the Graphical Display.

2-5-5. MEASURING DTF (Distance to Fault) (cont)

- With the cursor on the Type Field, press the F1 "Edit" Key and use the ▲ UP Key or ▼ DOWN Key to select DTF. Press the F1 "Done" Key to save the setting.

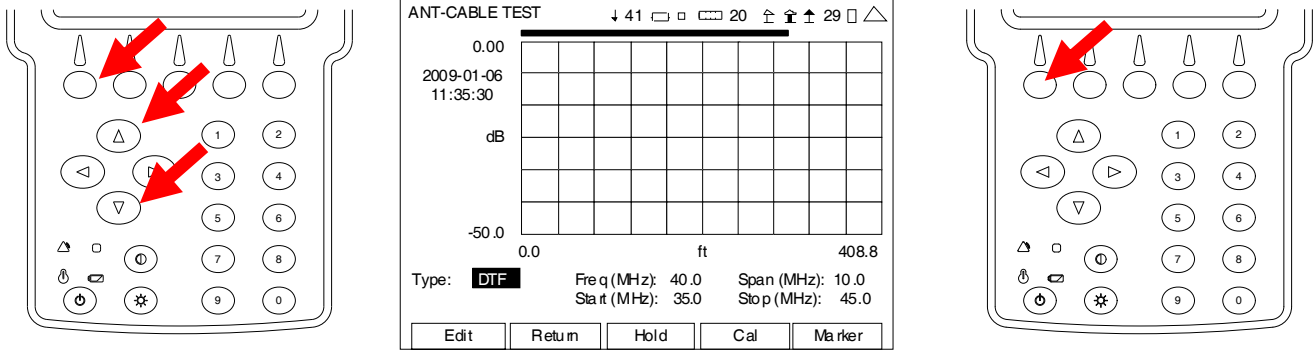

- With the cursor on the Freq Field, press the F1 "Edit" Key and use the Number Keys to select the center frequency of the UUT. Press the F1 "Done" Key to save the setting.

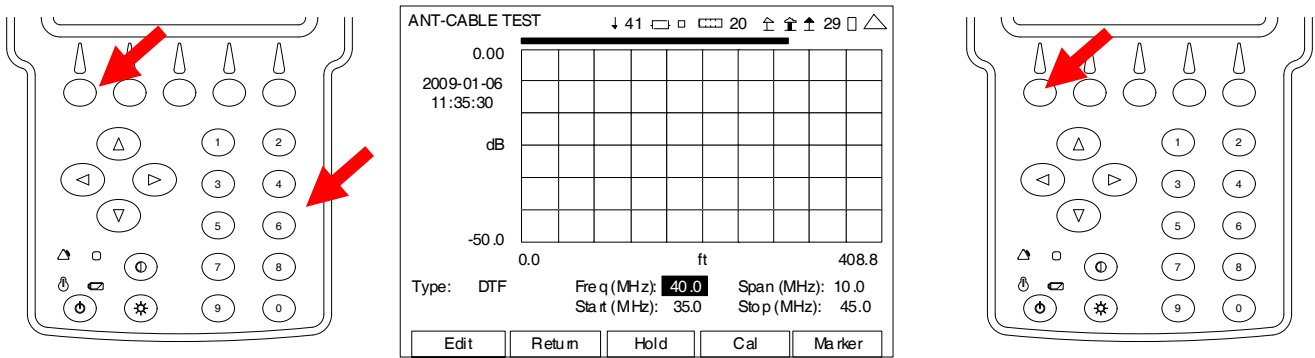

- Press the F5 "Marker" Key to display the ANT-Cable Test Screen in Marker Mode. Press the F5 "Cable" Key to display the ANT-Cable Test Screen in Cable Mode.

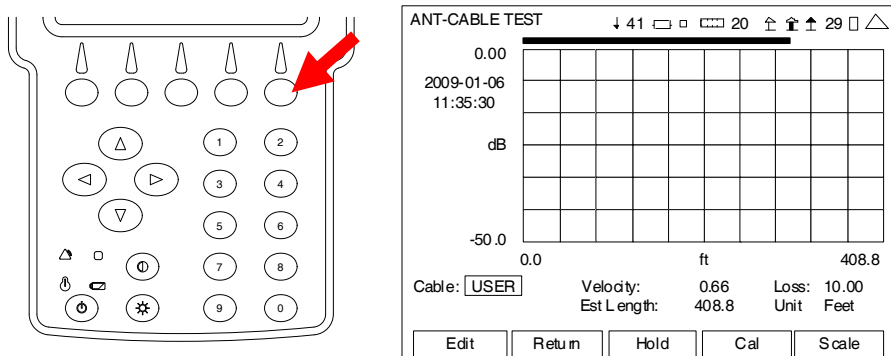

2-5-5. MEASURING DTF (Distance to Fault) (cont)

- With the cursor on the Cable Field, press the F1 "Edit" Key and use the ▲ UP Key or ▼ DOWN Key to select Cable Type used in the System Under Test. If Cable Type is not listed, select USER. Press the F1 "Done" Key to save the setting.

The diagram illustrates the first step of the process. On the left, a keypad with red arrows pointing to the Up, Down, and Done keys. In the center, the 'ANT-CABLE TEST' screen shows the 'Cable' field highlighted with 'RG-8x'. The screen also displays a dB scale from 0.00 to -50.0, a velocity of 0.66, and an estimated length of 408.8 feet. On the right, the keypad has a red arrow pointing to the Done key.

- Move the cursor to the Velocity Field. Press the F1 "Edit" Key and use the number keys to enter the Velocity Factor of the Cable. Press the F1 "Done" Key to save the setting.

The diagram illustrates the second step. On the left, a keypad with red arrows pointing to the Up, Down, and Done keys. In the center, the 'ANT-CABLE TEST' screen shows the 'Velocity' field highlighted with '0.66'. The 'Cable' field now shows 'RG-8x' and the 'Est Length' is 408.8 feet. On the right, the keypad has a red arrow pointing to the Done key.

- Then move the cursor to the Loss Field. Press the F1 "Edit" Key and use the number keys to enter the Cable Loss per 100 ft. Press the F1 "Done" Key to save the setting.

The diagram illustrates the third step. On the left, a keypad with red arrows pointing to the Up, Down, and Done keys. In the center, the 'ANT-CABLE TEST' screen shows the 'Loss' field highlighted with '10.00'. The 'Cable' field is 'RG-8x', 'Velocity' is '0.66', and 'Est Length' is '408.8'. On the right, the keypad has a red arrow pointing to the Done key.

2-5-5. MEASURING DTF (Distance to Fault) (cont)

- With the cursor on the Est Length Field, press the F1 “Edit” Key and use the Number Keys to select the Estimated Cable Length. (The Estimated Cable Length is the total Cable Length of the System Under Test plus 15%.) Press the F1 “Done” Key to save the setting.

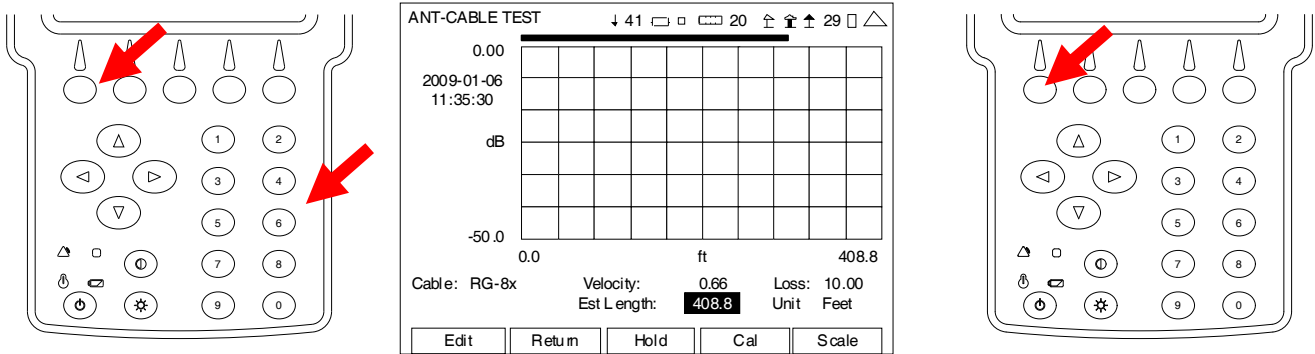

- With the cursor on the Unit Field, press the F1 “Edit” Key to select Feet or Meters.

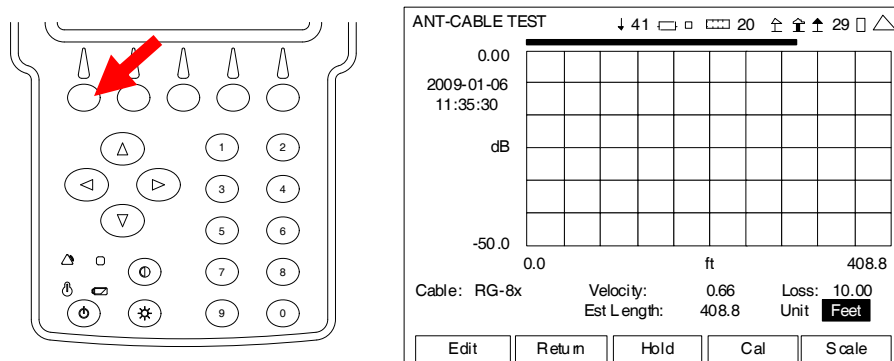

- Connect the System Under Test to the SWR Connector at the point of calibration.
- The Graphical Display is updated approximately every 20 seconds. Allow at least two updates of the Graphical Display to insure data is valid.

2-5-5. MEASURING DTF (Distance to Fault) (cont)

- Press the F5 "Scale" Key to display the ANT-Cable Test Screen in Scale Mode. Press the F5 "RF" Key to display the ANT-Cable Test Screen in RF Mode. Press the F5 "Marker" Key to display the ANT-Cable Test Screen in Marker Mode.

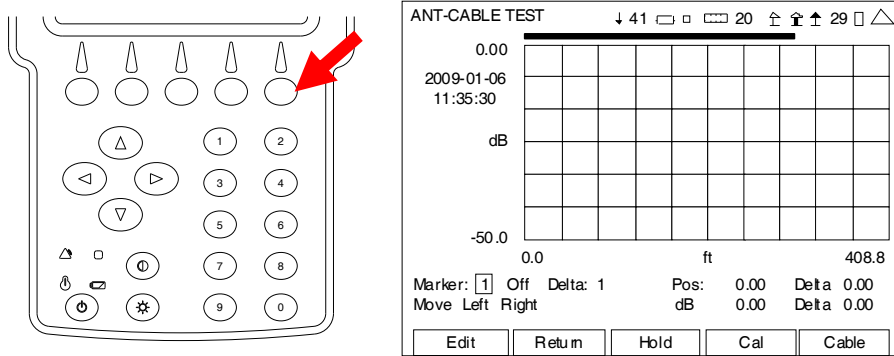

- With the data displayed on the Graphical Display, the Markers are used to determine the DTF at any point across the Graphical Display. With the cursor on the Marker Number Field, use the ▲ UP Key or ▼ DOWN Key to select a Marker. Press the F1 "Done" Key to save the setting.

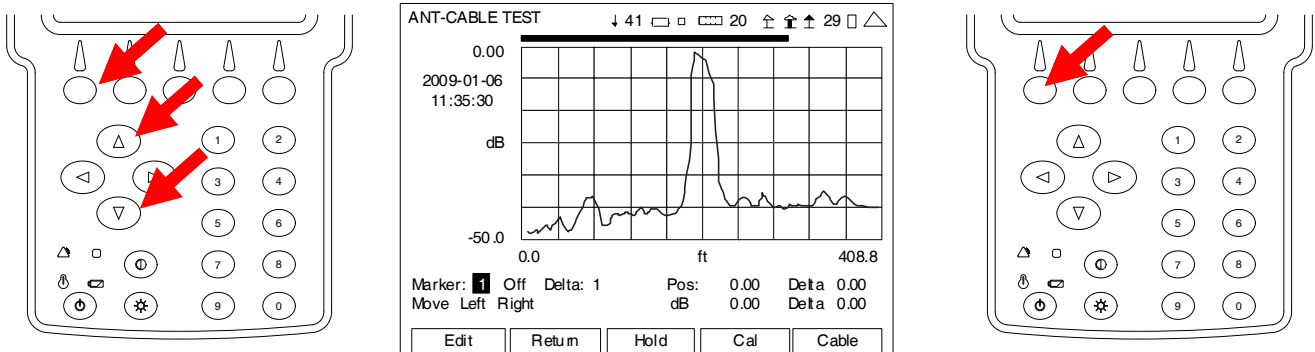

- Move the cursor to the right, press the F1 "Edit" Key and use the ▲ UP Key or ▼ DOWN Key to select On. Press the F1 "Done" Key to save the setting.

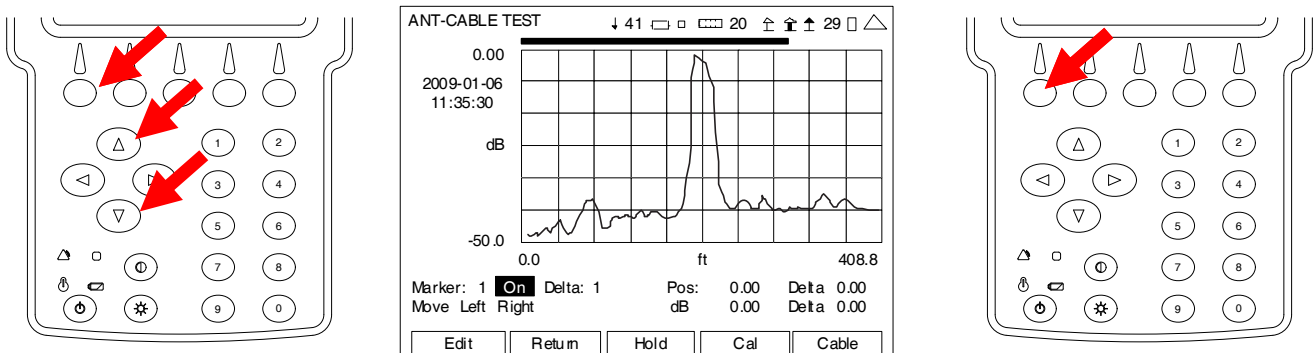

2-5-5. MEASURING DTF (Distance to Fault) (cont)

16. With the cursor on the Peak/Move Field, press the F1 “Edit” Key and use the ▲ UP Key or ▼ DOWN Key to select Peak or Move. Press the F1 “Done” Key to save the setting.

NOTE: Selecting “Peak” moves the Marker to the Next Peak on the Graphical Display. Selecting “Move” moves the Marker to the next Data Point on the Graphical Display.

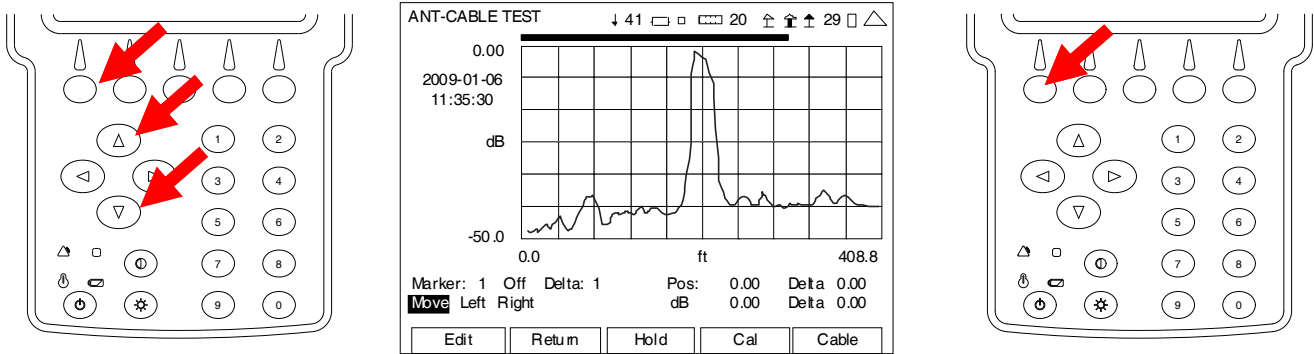

17. With the cursor on the Right Field, press the F1 “Enter” Key to move the Marker to the right on the Graphical Display.

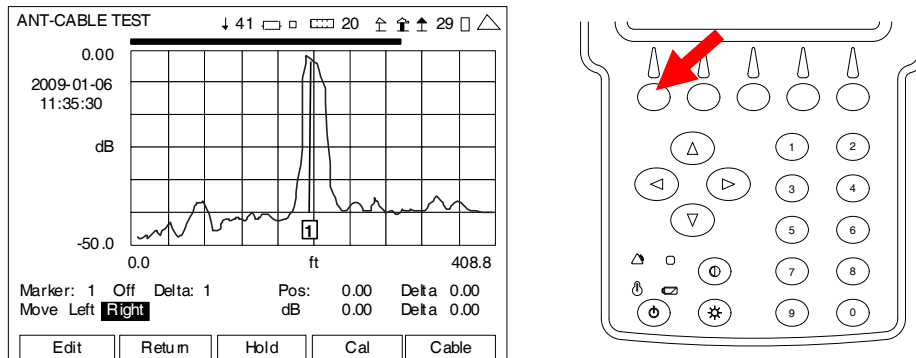

NOTE: When first enabled, a Marker is at the far left of the Graphical Display. Up to three Markers may be placed on the Graphical Display at a time. The Marker shown in the Marker Number Field is active. The active Marker can be moved using the Peak/Move and Left Right Fields with the readings, corresponding to the Marker position, displayed in fields under the Graphical Display.

2-5-6. MEASURING REVERSE POWER

1. Connect the Directional Coupler in line between the Transmitter and Antenna and to the 3500 / 3500A.

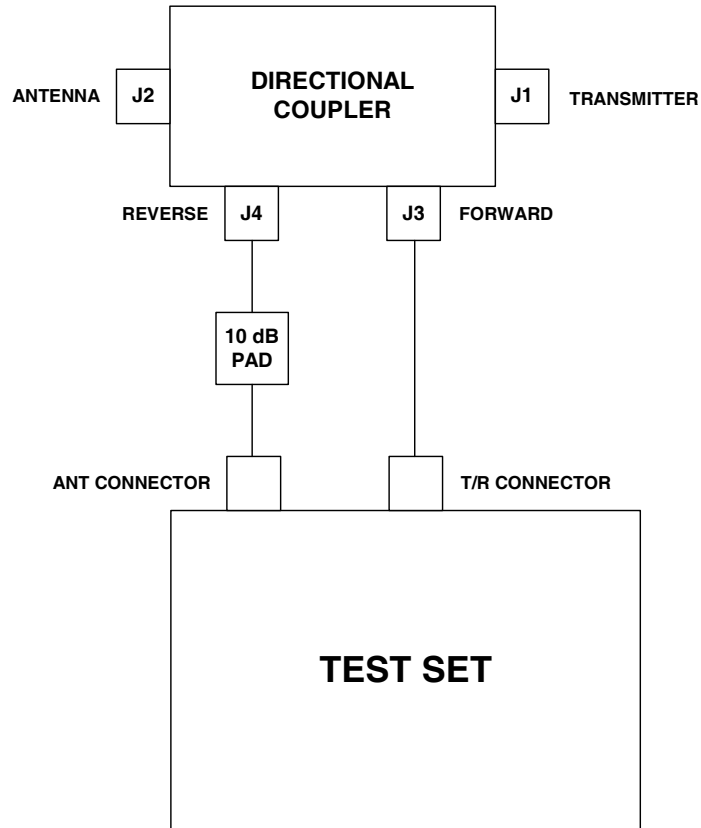

2. The Transmitter Test Screen should be displayed.

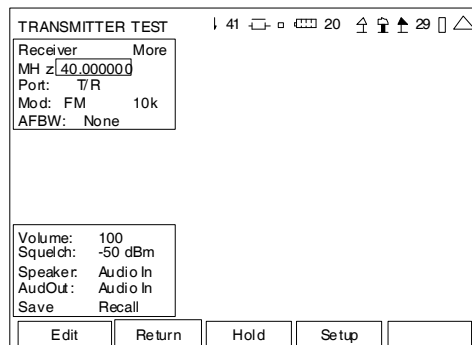

2-5-6. MEASURING REVERSE POWER (cont)

- With the cursor on the Port (RF In) Field, press the F1 "Edit" Key and use the ▲ UP Key or ▼ DOWN Key to select the T/R Connector. Press the F1 "Done" Key to save the setting.

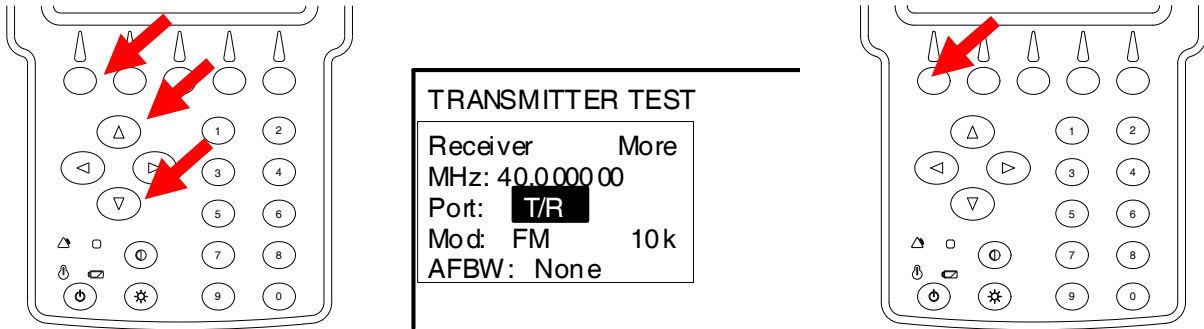

- Press the F4 "Setup" Key to display the Transmitter Test Setup Screen.

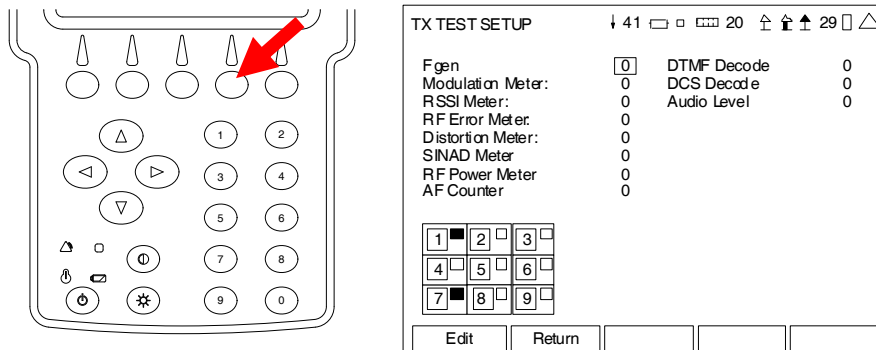

- With the cursor on the RSSI Meter Field, press the F1 "Edit" Key and the Number Key for an open Meter position (refer to Meter Chart) to display the RSSI Meter in that position on the Transmitter Test Screen. Press the F1 "Done" Key to save the setting.

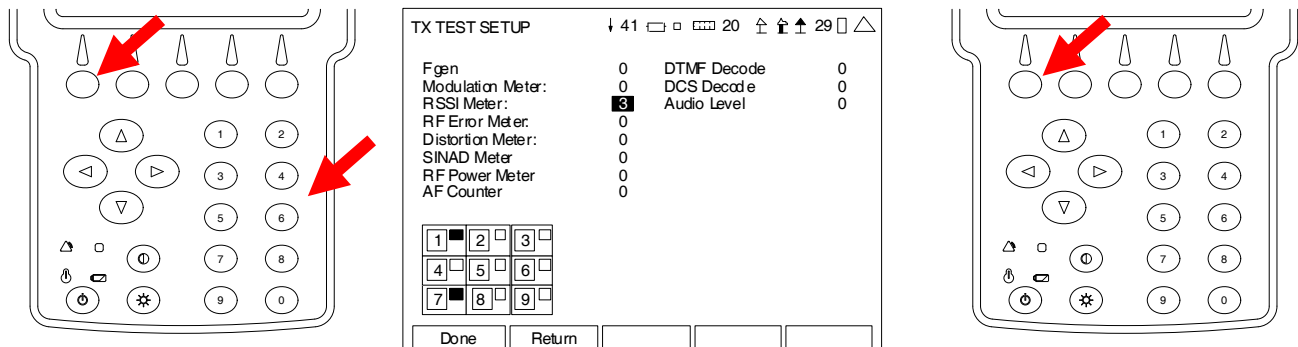

2-5-6. MEASURING REVERSE POWER (cont)

- Press the F2 "Return" Key to display the Transmitter Test Screen.

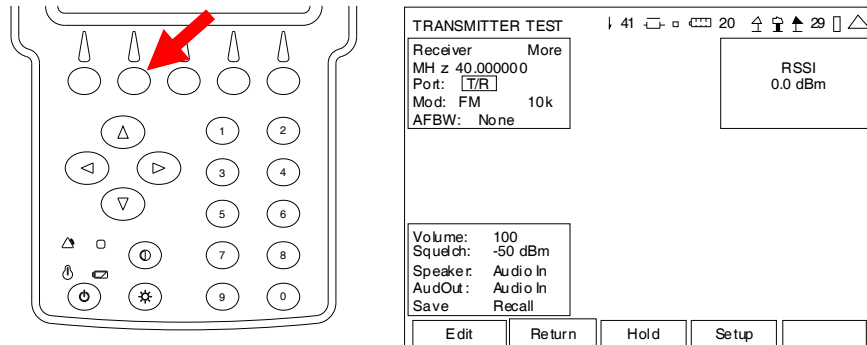

- With the cursor on the RF MHz Field, press the F1 "Edit" Key and use the ◀ LEFT, ▶ RIGHT and Number Keys to match the Transmit frequency of the UUT. Press the F1 "Done" Key to save the setting.

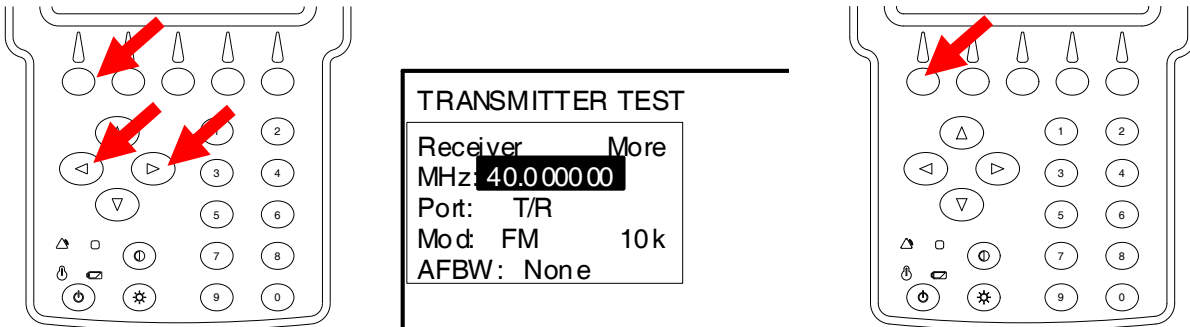

- Key the Transmitter and record the RSSI Meter reading.
- With the cursor on the Port (RF In) Field, press the F1 "Edit" Key and use the ▲ UP Key or ▼ DOWN Key to select the ANT Connector. Press the F1 "Done" Key to save the setting.

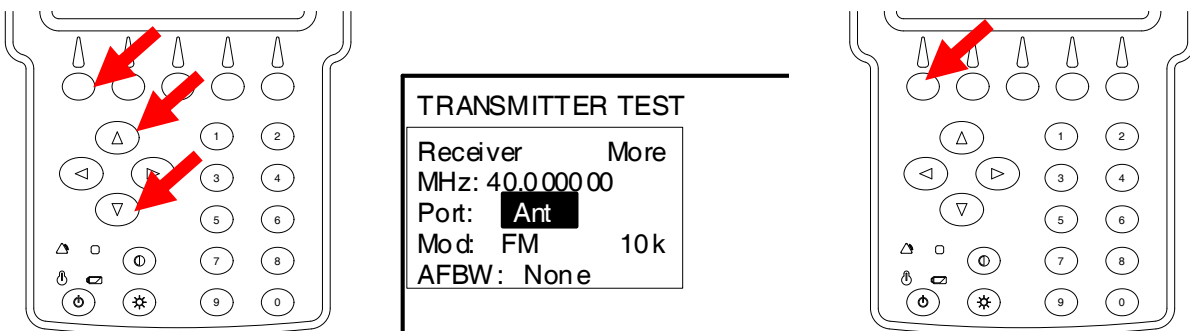

2-5-6. MEASURING REVERSE POWER (cont)

10. Key the Transmitter and record the RSSI Meter reading.
11. Calculate Forward and Reverse Power:

$$\text{FWD PWR (dBm)} = \text{T/R RSSI (dBm)} + \text{FWD Coupling}$$

$$\text{REV PWR (dBm)} = \text{ANT RSSI (dBm)} + \text{REV Coupling} + \text{Coupler Insertion Loss}$$

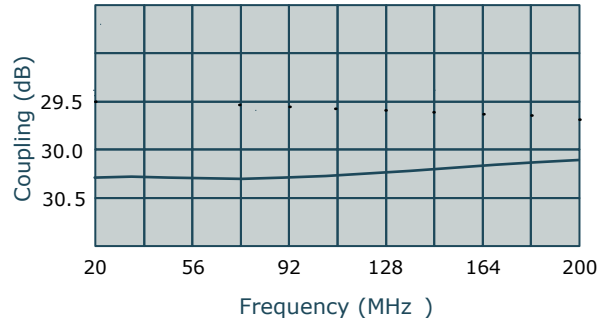

12. Calculate Power in Watts and Return Loss:

$$\text{Power (Watts)} = 10^{(\text{PWR (dBm)}/10)} * 0.001$$

$$\text{Return Loss} = \text{REV PWR (dBm)} - \text{FWD PWR (dBm)} + 10 \text{ dB}$$

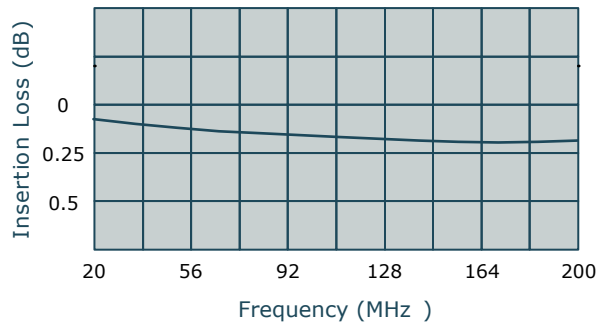

2-5-7. LOADING SOFTWARE USING USB MEMORY DEVICE

NOTE: When loading Software into the 3500 / 3500A, the Calibration Values are not affected; however any saved Setup Files are deleted.

1. Connect the External DC Power Supply to the Test Set (DC IN Connector).
2. Connect the AC Power Cable from the External DC Power Supply to an appropriate AC power source.
3. Ensure the Test Set is ON.
4. Connect the Comm Breakout Box to the Test Set REMOTE Connector.
5. Connect the Ethernet Crossover Cable from the Comm Breakout Box (ETHERNET Connector) to the PC (Ethernet Port).
6. Place the Software Loader CD-ROM into the PC and reboot the PC.

NOTE: Often the BIOS on the PC needs to be reconfigured to boot from the CD-ROM.

7. Follow the instructions displayed on the PC. Allow several minutes for the PC to reboot from the CD-ROM.
8. When the software load is completed, verify the Software Version displayed on the Version Screen matches the Software Version loaded.

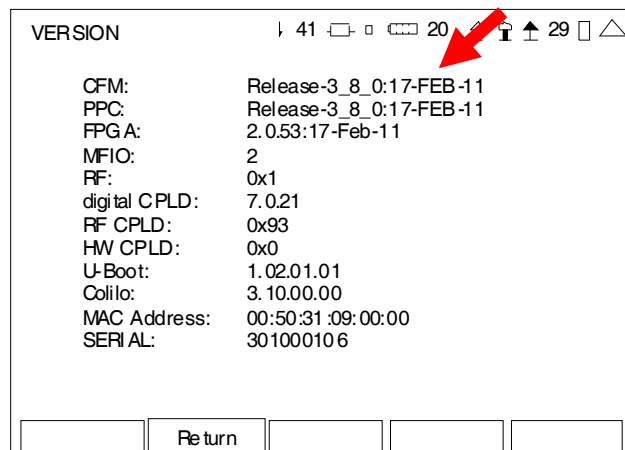

This screen is a representation of the screen that appears.

CHAPTER 3 - OPERATOR MAINTENANCE

3-1. SERVICE UPON RECEIPT

3-1-1. SERVICE UPON RECEIPT OF MATERIAL

A. Unpacking

Special-design packing material inside this shipping carton provides maximum protection for the 3500 / 3500A. Avoid damaging the carton and packing material during equipment unpacking. Use the following steps for unpacking the 3500 / 3500A.

- Cut and remove the sealing tape on the carton top and open the carton.
- Grasp the 3500 / 3500A transit case firmly, while restraining the shipping carton, and lift the 3500 / 3500A transit case and packing material vertically.
- Place the 3500 / 3500A transit case and end cap packing on a suitable flat, clean and dry surface.
- Remove the 3500 / 3500A transit case from the protective plastic bag.
- Place protective plastic bag and end cap packing material inside shipping carton.
- Store the shipping carton for future use should the 3500 / 3500A need to be returned.

B. Checking Unpacked Equipment

Use the following steps for checking the equipment.

- Inspect the equipment for damage incurred during shipment. If the equipment has been damaged, report the damage.
- Check the equipment against the packing slip to see if the shipment is complete. Report all discrepancies.

3-1-2. PRELIMINARY SERVICING AND ADJUSTMENT OF EQUIPMENT

1. Remove the 3500 / 3500A from the Soft Carrying Case or Transit Case.



2. Perform the Turn-On Procedure (para 2-4-1).

BATTERY PRECAUTIONS

The 3500 / 3500A is powered by an internal Lithium Ion battery pack. The 3500 / 3500A is supplied with an external DC Power Supply that enables the operator to recharge the battery when connected to AC power. The 3500 / 3500A can operate continuously on AC power via the DC Power Supply, for servicing and/or bench tests.

The internal battery is equipped to power the 3500 / 3500A for five hours of continuous use, after which time, the 3500 / 3500A battery needs recharging. When the POWER Indicator is GREEN, the battery is at >25% capacity. When the POWER Indicator is YELLOW, the battery is at <25% capacity.

If the battery level, shown in the BAT Field on most Test Screens, drops to 10 (10%), the 3500 / 3500A powers down automatically.

The battery charger operates whenever DC power (11 to 32 Vdc) is applied to the 3500 / 3500A with the supplied DC Power Supply or a suitable DC power source. When charging, the battery reaches an 100% charge in approximately four hours. The internal battery charger allows the battery to charge between a temperature range of 5° to 45°C. The 3500 / 3500A can operate, connected to an external DC source, outside the battery charging temperature range (5° to 45°C). Allow 20 minutes for the battery to charge when turning the 3500 / 3500A ON from a dead battery condition.

The battery should be charged every three months (minimum) or disconnected for long term inactive storage periods of more than six months. The Battery must be removed when conditions surrounding the 3500 / 3500A are <-20°C and >60°C)

3-2. TROUBLESHOOTING

Troubleshooting is divided into a Symptom Index and a Troubleshooting Table.

The Troubleshooting Table lists the common malfunctions which may occur during operation of the 3500 / 3500A. Perform the tests/inspections and corrective actions in the order listed.

NOTE

- This manual cannot list all the malfunctions that may occur, nor all the tests or inspections and corrective actions.
- If a malfunction is not listed or is not corrected by the listed corrective actions, route the 3500 / 3500A to an authorized Maintenance Facility for repair.

SYMPTOM	DESCRIPTION	PAGE
1	External DC Power Supply failure	3-4
2	POWER Indicator does not illuminate	3-4
3	CHARGE Indicator does not illuminate	3-5
4	FAULT Indicator is Red	3-5
5	FAULT Indicator is Yellow	3-5
6	Blows Fuse	3-6
7	Battery does not charge	3-6
8	Display is blank or abnormality exists in Display	3-6
9	Display Contrast or Backlight cannot be adjusted	3-6
10	Keys inoperable	3-6
11	Self Test failure	3-6
12	Connector failure	3-6

TROUBLESHOOTING TABLE

NOTE

The Troubleshooting Table lists common malfunctions found during normal operation of the 3500 / 3500A. The tests or inspections and corrective actions should be performed in the order listed. Failure to do so may result in troubleshooting recommendations that replace working items.

MALFUNCTION	TEST OR INSPECTION	CORRECTIVE ACTION
1 External DC Power Supply failure		
	Step 1. Connect the External DC Power Supply to a verifiable AC Power Source and verify the LED is lit.	◆ If incorrect, replace the External DC Power Supply.
	Step 2. Using a DMM on the External DC Power Supply output, verify +18 Vdc (± 1 Vdc).	◆ If incorrect, replace the External DC Power Supply.
2 POWER Indicator does not illuminate		
	Step 1. Connect the External DC Power Supply to a verifiable AC Power Source and verify the LED is lit.	◆ If incorrect, replace the External DC Power Supply.
	Step 2. Using a DMM on the External DC Power Supply output, verify +18 Vdc (± 1 Vdc).	◆ If incorrect, replace the External DC Power Supply.
	Step 3. Verify the Battery is installed.	◆ If incorrect, install the Battery (para 3-3-2).
	Step 4. Verify the Fuse is not blown.	◆ If incorrect, replace the Fuse (para 3-3-3).
	Step 5. Remove any external power sources from the 3500 / 3500A. Using a DMM, verify 11.1 Vdc Nominal at the Battery Connector (Red wire).	◆ If incorrect, replace the Battery (para 3-3-2).
	Step 6. Connect the External DC Power Supply to the 3500 / 3500A. Using a DMM, verify 12.6 Vdc at the Battery Connector (Red wire).	◆ If incorrect, refer to Troubleshooting (para 2-2) in the 3500 / 3500A Maintenance Manual.

TROUBLESHOOTING TABLE (cont)

<i>MALFUNCTION</i>	<i>TEST OR INSPECTION</i>	<i>CORRECTIVE ACTION</i>
---------------------------	----------------------------------	---------------------------------

3	CHARGE Indicator does not illuminate	<p>Step 1. Connect the External DC Power Supply to a verifiable AC Power Source and verify the LED is lit.</p> <ul style="list-style-type: none">◆ If incorrect, replace the External DC Power Supply. <p>Step 2. Using a DMM on the External DC Power Supply output, verify +18 Vdc (± 1 Vdc).</p> <ul style="list-style-type: none">◆ If incorrect, replace the External DC Power Supply. <p>Step 3. Verify the Battery is installed.</p> <ul style="list-style-type: none">◆ If incorrect, install the Battery (para 3-3-2). <p>Step 4. Verify the Fuse is not blown.</p> <ul style="list-style-type: none">◆ If incorrect, replace the Fuse (para 3-3-3). <p>Step 5. Remove any external power sources from the 3500 / 3500A. Using a DMM, verify 11.1 Vdc Nominal at the Battery Connector (Red wire).</p> <ul style="list-style-type: none">◆ If incorrect, replace the Battery (para 3-3-2). <p>Step 6. Connect the External DC Power Supply to the 3500 / 3500A. Using a DMM, verify 12.6 Vdc at the Battery Connector (Red wire).</p> <ul style="list-style-type: none">◆ If incorrect, refer to Troubleshooting (para 2-2) in the 3500 / 3500A Maintenance Manual.
4	FAULT Indicator is Red	<p>Step 1. Clear Warning condition in the 3500 / 3500A.</p> <p>Step 2. Press the POWER Key twice to cycle power.</p> <ul style="list-style-type: none">◆ If FAULT Indicator is still Red, refer to Troubleshooting (para 2-2) in the 3500 / 3500A Maintenance Manual.
5	FAULT Indicator is Yellow	<p>Step 1. Clear Caution condition in the 3500 / 3500A.</p> <p>Step 2. Press the POWER Key twice to cycle power.</p> <ul style="list-style-type: none">◆ If FAULT Indicator is still Yellow, refer to Troubleshooting (para 2-2) in the 3500 / 3500A Maintenance Manual.

TROUBLESHOOTING TABLE (cont)

MALFUNCTION	TEST OR INSPECTION	CORRECTIVE ACTION
6 Blows Fuse	<p>Step 1. Connect the External DC Power Supply to a verifiable AC Power Source and verify the LED is lit.</p> <p>◆ If incorrect, replace the External DC Power Supply.</p> <p>Step 2. Using a DMM on the External DC Power Supply output, verify +18 Vdc (± 1 Vdc).</p> <p>◆ If incorrect, replace the External DC Power Supply.</p> <p>Step 3. Replace the Fuse (para 3-3-3).</p> <p>◆ If the Fuse continues to blow, refer to Troubleshooting (para 2-2) in the 3500 / 3500A Maintenance Manual.</p>	
7 Battery does not charge	<p>Step 1. Connect the External DC Power Supply to the 3500 / 3500A and verify the CHARGE Indicator is Green or Yellow.</p> <p>◆ If incorrect, replace the Battery (para 3-3-2).</p> <p>Step 2. Allow four hours for Battery to fully charge and verify the CHARGE Indicator is Green.</p> <p>◆ If incorrect, replace the Battery (para 3-3-2).</p>	
8 Display is blank or abnormality exists in Display	<p>Step 1. Press the POWER Key.</p> <p>Step 2. Check and/or adjust Contrast and Backlight levels.</p> <p>Refer to Troubleshooting (para 2-2) in the 3500 / 3500A Maintenance Manual.</p>	
9 Display Contrast or Backlight cannot be adjusted	<p>Refer to Troubleshooting (para 2-2) in the 3500 / 3500A Maintenance Manual.</p>	
10 Keys inoperable	<p>Refer to Troubleshooting (para 2-2) in the 3500 / 3500A Maintenance Manual.</p>	
11 Self Test failure	<p>Refer to Troubleshooting (para 2-2) in the 3500 / 3500A Maintenance Manual.</p>	
12 Connector failure	<p>Inspect connector for damage and/or wear.</p> <p>Refer to Troubleshooting (para 2-2) in the 3500 / 3500A Maintenance Manual.</p>	

3-3. MAINTENANCE PROCEDURES

3-3-1. BATTERY RECHARGING

The Battery is equipped to power the 3500 / 3500A for five hours of continuous use, after which time, the Battery needs recharging. The battery charger operates whenever DC power (11 to 32 Vdc) is applied to the 3500 / 3500A with the supplied External DC Power Supply or a suitable DC power source. When charging, the Battery reaches an 100% charge in approximately four hours. The internal battery charger allows the Battery to charge between a temperature range of 5°C to 40°C. Allow 20 minutes for battery to charge when turning 3500 / 3500A ON from a dead battery condition.

The Battery should be charged every three months (minimum) or disconnected for long term inactive storage periods of more than six months. The Battery must be removed when conditions surrounding the 3500 / 3500A are <-20°C or >60°C).

DESCRIPTION

This procedure is used to recharge the Battery in 3500 / 3500A with an External DC Power Supply.

WARNING

Do not recharge the Lithium Ion Battery Pack outside the 3500 / 3500A.

1. Connect the External DC Power Supply to the DC IN Connector on the 3500 / 3500A.
 2. Connect the AC Power Cable to the External DC Power Supply and an appropriate AC power source.
 3. Verify the CHARGE Indicator is YELLOW.
- If the CHARGE Indicator is RED, refer to Troubleshooting (para 3-2).
4. Allow four hours for Battery charge or until the CHARGE Indicator is GREEN.

If the CHARGE Indicator is YELLOW and/or the Battery fails to accept a charge and the 3500 / 3500A does not operate on Battery power, refer to Troubleshooting (para 3-2).

NOTE: The 3500 / 3500A may turn OFF whenever the External DC Power Supply (connected to AC power) is plugged into 3500 / 3500A. This is a design behavior to prevent damage to the lithium batteries. Performing the Steps above in order shown helps to avoid the inadvertent turning OFF of 3500 / 3500A when External DC Power Supply is connected.

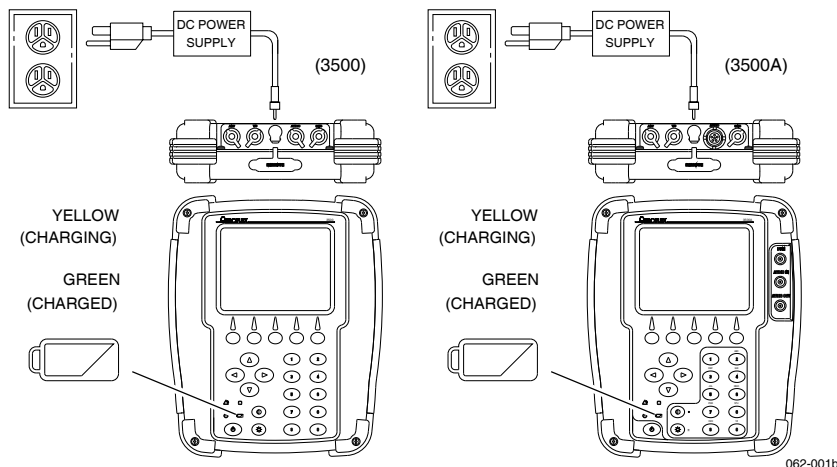

3-3-2. BATTERY REPLACEMENT

DESCRIPTION

This procedure is used to replace the Battery in the 3500 / 3500A.

CAUTION

REPLACE ONLY WITH THE BATTERY SPECIFIED. DO NOT ATTEMPT TO INSTALL A NON-RECHARGEABLE BATTERY.

WARNING

- **DISPOSE OF THE LITHIUM ION BATTERY PACK ACCORDING TO LOCAL STANDARD SAFETY PROCEDURES. DO NOT CRUSH, INCINERATE OR DISPOSE OF THE LITHIUM ION BATTERY PACK IN NORMAL WASTE.**
- **DO NOT SHORT CIRCUIT OR FORCE DISCHARGE OF THE LITHIUM ION BATTERY PACK AS THIS MIGHT CAUSE THE LITHIUM ION BATTERY PACK TO VENT, OVERHEAT OR EXPLODE.**

REMOVE

1. Fully loosen the captive screws (on each side of the bumper) in the two lower bumpers and remove the bumpers from the 3500 / 3500A.

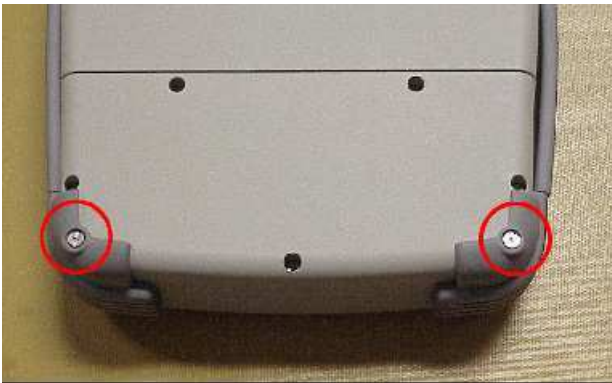

2. Fully loosen five captive screws holding the Battery Cover to the 3500 / 3500A and remove the Battery Cover from the 3500 / 3500A.

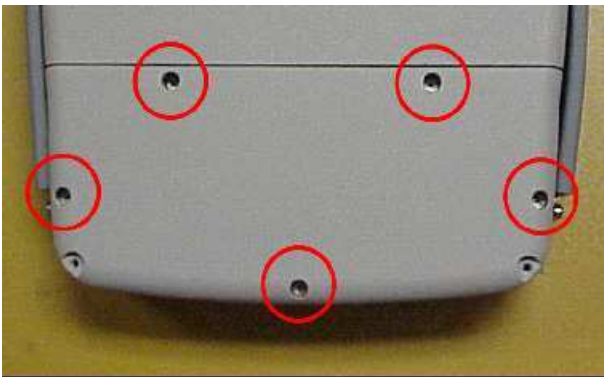

3-3-2. BATTERY REPLACEMENT (cont)

REMOVE (cont)

3. Disconnect the Battery Wire Harness and remove the Battery from the 3500 / 3500A.



INSTALL

1. Install the Battery in the 3500 / 3500A and connect the Battery Wire Harness.



2. Install the Battery Cover on the 3500 / 3500A and tighten five captive screws (8 in/lbs.).

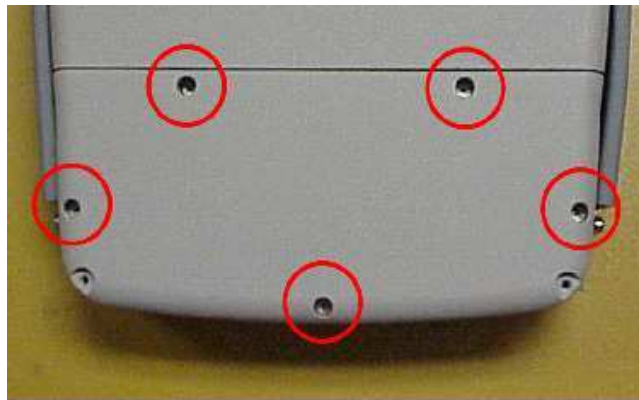

3-3-2. BATTERY REPLACEMENT (cont)

INSTALL (cont)

3. Install the two lower bumpers on the 3500 / 3500A and tighten the captive screws (on each side of the bumpers) (8 in/lbs.).

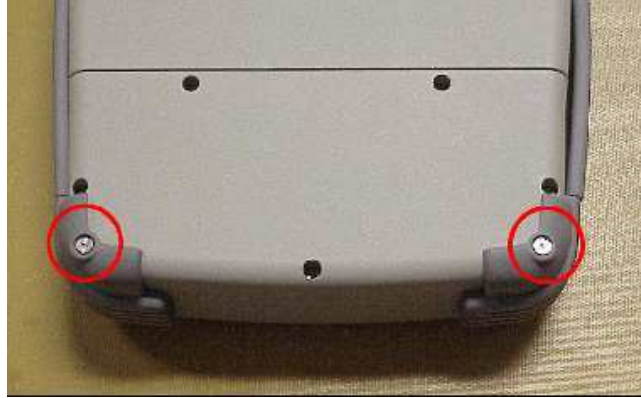

3-3-3. FUSE REPLACEMENT

DESCRIPTION

This procedure is used to replace the internal fuse in the 3500 / 3500A.

CAUTION

FOR CONTINUOUS PROTECTION AGAINST FIRE, REPLACE ONLY WITH FUSES OF THE SPECIFIED VOLTAGE AND CURRENT RATINGS. (5 A, 32 Vdc, Type F - Mini Blade Fuse)

REMOVE

1. Fully loosen the captive screws (on each side of the bumper) in the two lower bumpers and remove the bumpers from the 3500 / 3500A.

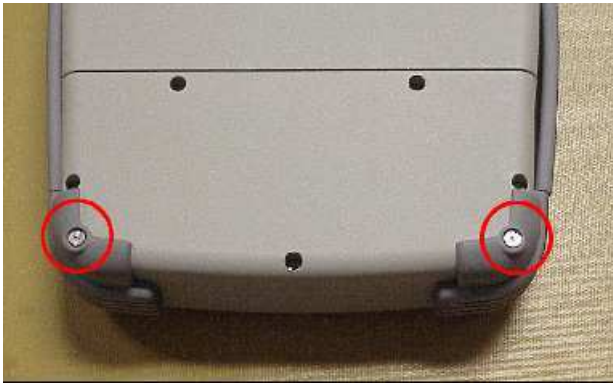

2. Fully loosen five captive screws holding the Battery Cover to the 3500 / 3500A and remove the Battery Cover from the 3500 / 3500A.

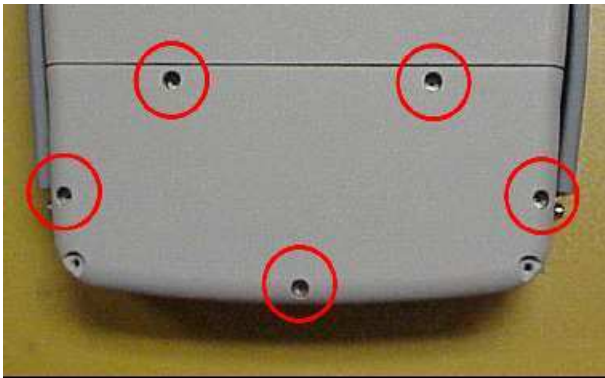

3-3-3. FUSE REPLACEMENT (cont)

REMOVE (cont)

3. Locate and remove the Fuse.

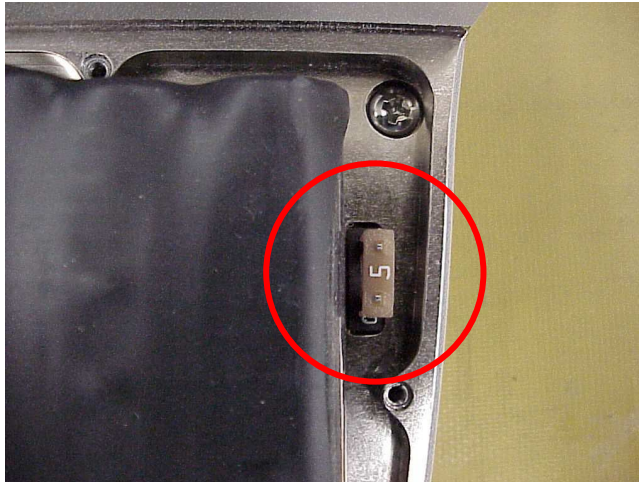

INSTALL

1. Install the Fuse.

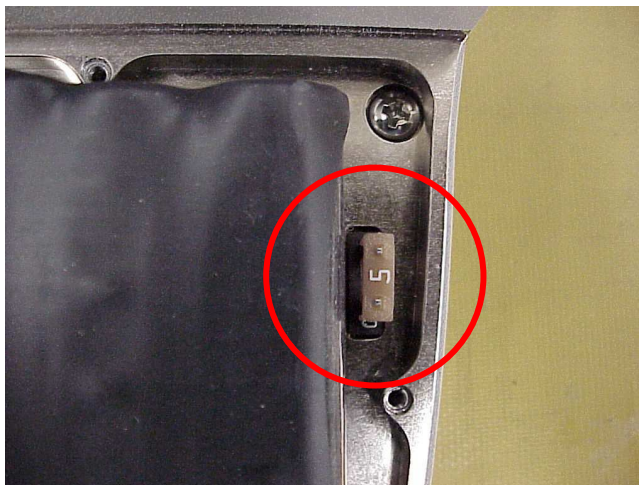

3-3-3. FUSE REPLACEMENT (cont)

INSTALL (cont)

2. Install the Battery Cover on the 3500 / 3500A and tighten five captive screws (8 in/lbs.).

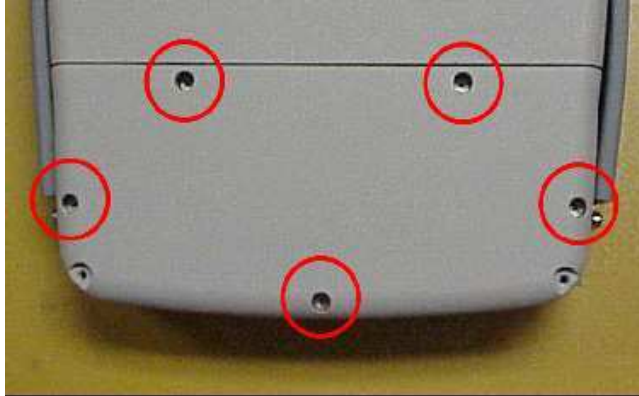

3. Install the two lower bumpers on the 3500 / 3500A and tighten the captive screws (on each side of the bumpers) (8 in/lbs.).

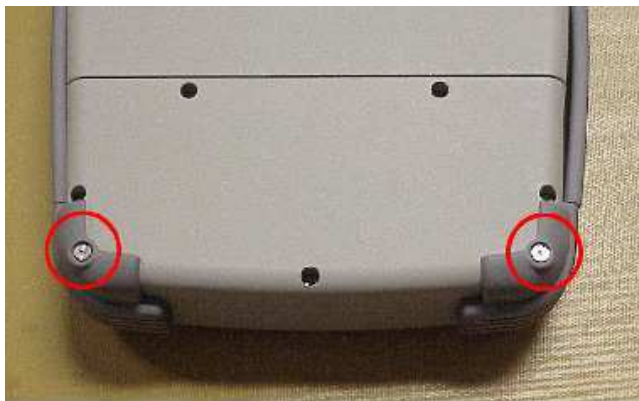

3-3-4. HANDLE REPLACEMENT

DESCRIPTION

This procedure is used to replace the handle(s) on the 3500 / 3500A.

REMOVE

1. Fully loosen the captive screws (on each side of the bumper) in the two bumpers (on the right or left side of the 3500 / 3500A) and remove the bumpers from the 3500 / 3500A.



2. Remove the four shoulder bolts securing the Handle to the 3500 / 3500A and remove the Handle.

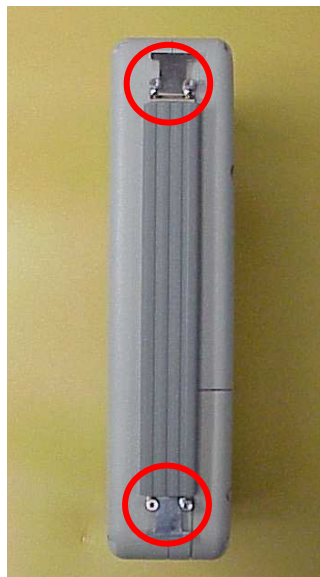

3-3-4. HANDLE REPLACEMENT (cont)

INSTALL

1. Install the Handle and the four shoulder bolts (8 in/lbs.).

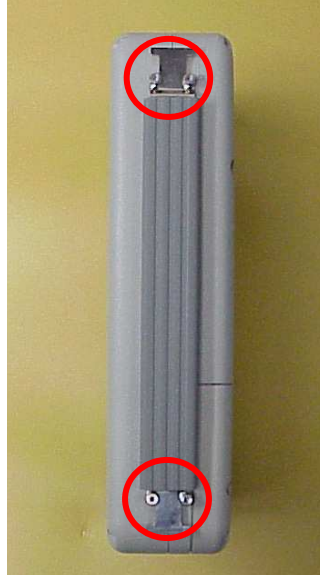

2. Install the two bumpers (on the right or left side of the 3500 / 3500A) and tighten the captive screws (on each side of the bumper) (8 in/lbs.).



3-3-5. BUMPER REPLACEMENT

DESCRIPTION

This procedure is used to replace the bumper(s) on the 3500 / 3500A.

REMOVE

Fully loosen the captive screws on each side of the bumper and remove the bumper from the 3500 / 3500A.

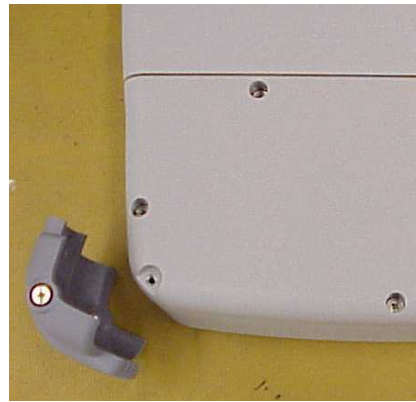

INSTALL

Install the bumper on the 3500 / 3500A and tighten the captive screws (on each side of the bumpers) (8 in/lbs.).



3-4. PREPARATION FOR STORAGE OR SHIPMENT

A. Packaging

Package the 3500 / 3500A in the original shipping container. When using packing materials other than the original, use the following guidelines:

- Wrap the 3500 / 3500A transit case in plastic packing material.
- Use a double-wall cardboard shipping container.
- Protect all sides with shock-absorbing material to prevent the 3500 / 3500A transit case from moving within the container.
- Seal the shipping container with approved sealing tape.
- Mark "FRAGILE" on the top, bottom and all sides of the shipping container.

B. Environment

The 3500 / 3500A should be stored in a clean, dry environment. In high humidity environments, protect the 3500 / 3500A from temperature variations that could cause internal condensation. The following environmental conditions apply to both shipping and storage:

Temperature: -30°C to +71°C*
Relative Humidity: 0% to 95%
Altitude: 0 to 4600 m
Vibration: <2 g
Shock: <30 g

* The Battery must not be subjected to temperatures <-20°C or >+60°C.

THIS PAGE INTENTIONALLY LEFT BLANK.

CHAPTER 4 - OPTIONS

4-1. GENERAL

There are nine Options that are currently available to be installed in the 3500 / 3500A:

- Spectrum Analyzer (35000010)
- Oscilloscope (35000001)
- Tracking Generator (35000070)
- P25 (35000100)
- DMR (35000200)
- NXDN (35000400)
- dPMR (35000300)
- ARIBT98 (35000500)
- Scripting (35000060)

The Options that are installed in the 3500 / 3500A are displayed on the Options Screen.

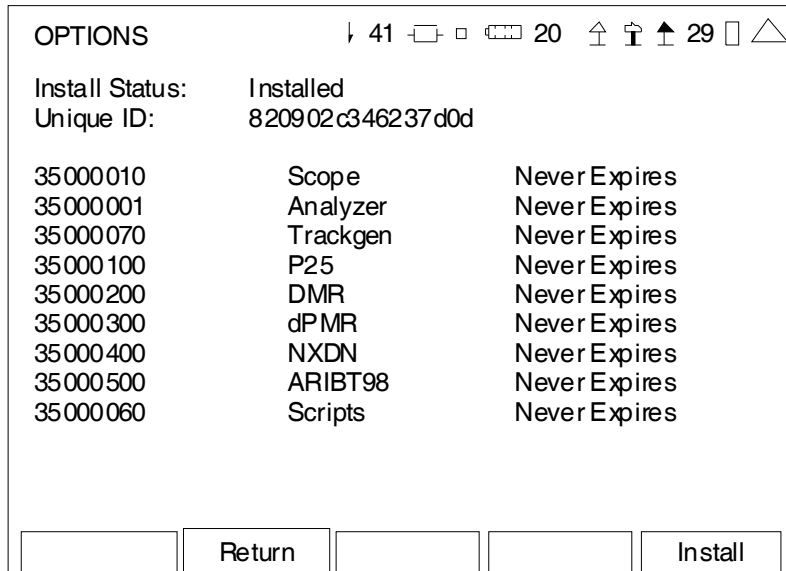

This screen is a representation of the screen that appears.

Refer to para 2-2-5F for a description of the Options Screen features and functions.

4-2. INSTALLING OPTIONS

1. Attach the Comm Breakout Box to the REMOTE Connector.
2. Insert the USB Memory Device in the USB Connector on the Comm Breakout Box. The 3500 / 3500A recognizes the USB Memory Device and the USB LED flashes momentarily.
3. Press the F5 “Install” Key.
4. The USB Memory Device LED starts to flash when the Option files are loading. The “Install Status” Indicator provides messages indicating when the Option load is completed. Allow approximately one minute for the Options files to load.
5. When the Option files are installed, remove the USB Memory Device.
6. Press the POWER Key to turn the 3500 / 3500A OFF. Press the POWER Key again to turn the 3500 / 3500A ON.
7. When the System Menu is displayed, press the F5 “Util” Key to display the Utilities Menu. Press the 6 Key to display the Options Screen.
8. Verify the Options are displayed on the Options Screen. To the right of the displayed Option is the Option expiration date.

(Sample Screen)

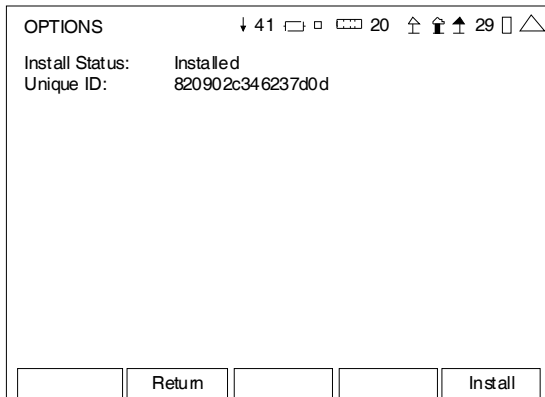

(Before Option Install)

(Sample Screen)

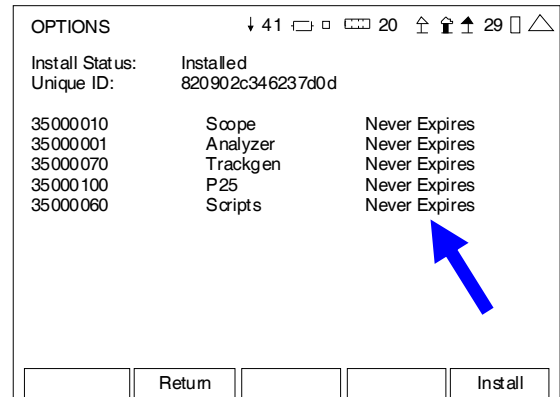

(After Option Install)

INSTALL TROUBLESHOOTING

Incorrect Unit ID Number and Serial Number

Option files are created for a specific Unique ID (Unit ID) Number and Serial Number in each 3500 / 3500A. If the Option installation is attempted for a different unit other than the unit the Option Files were created for, then the Option files are not installed, the Option Install fails and the “Install Status” indicates “Not For Me.”

4-3. SPECTRUM ANALYZER OPTION (35000010)

The Spectrum Analyzer Option (35000010) adds a Spectrum Analyzer to the testing compatibilities of the 3500 / 3500A.

The Spectrum Analyzer provides users with the ability to view and measure RF.

The 3500 / 3500A Spectrum Analyzer is a FFT Spectrum Analyzer. The FFT Spectrum Analyzer operates differently than a swept IF Spectrum Analyzer.

In swept IF Spectrum Analyzers the RBW is defined by analog filters. On many communications test sets, 300 z is as small as possible, with the more narrow the filter the longer the incoming signal takes to stabilize in the filter. The number of possible positions that the filter can be moved to are called "bins."

The FFT Spectrum Analyzer takes the RBW and uses this same concept to the extreme, with 1024 bins on every sweep. The large number of FFT bins increases the measurement sensitivity.

4-3-1. SPECTRUM ANALYZER SCREEN

When the System Menu displayed, press the appropriate Number Key to display the Spectrum Analyzer Screen.

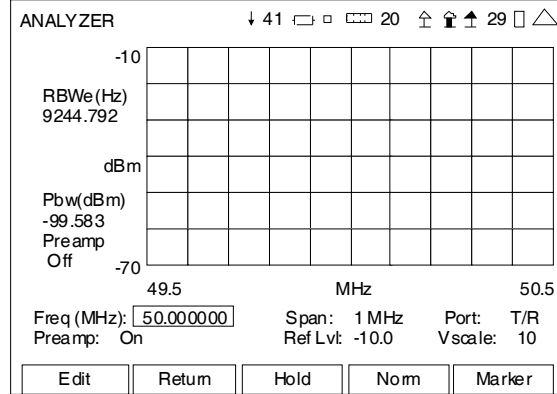
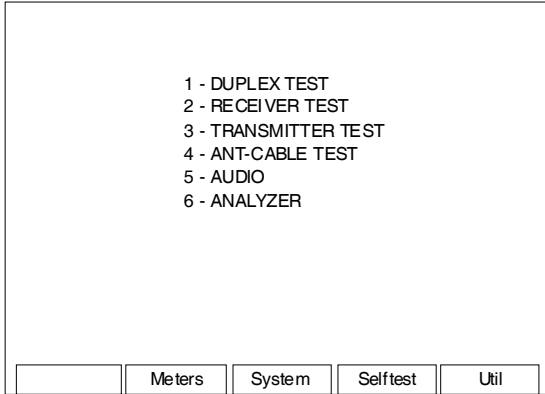

The Spectrum Analyzer Screen can also be added to the Duplex and Transmitter Test Screens for easy access.

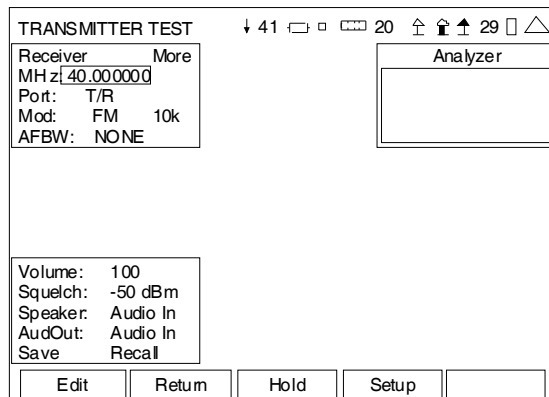
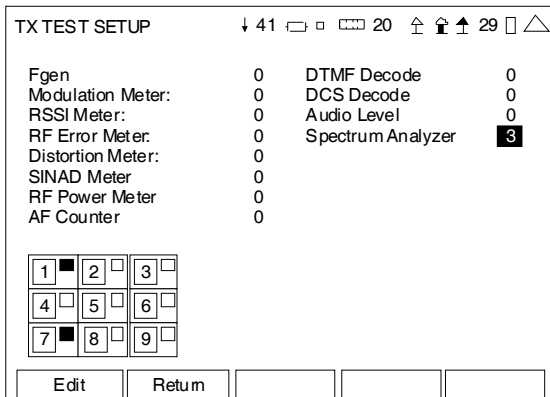

To access the Spectrum Analyzer Screen on the Duplex or Transmitter Test Screens:

- Press the ◀ LEFT Key or ▶ RIGHT Key to move the on-screen cursor to the Spectrum Analyzer frame.
- Press the F1 “Zoom” Key to display the Spectrum Analyzer Screen.

4-3-2. SPECTRUM ANALYZER SCREEN FEATURES AND FUNCTIONS

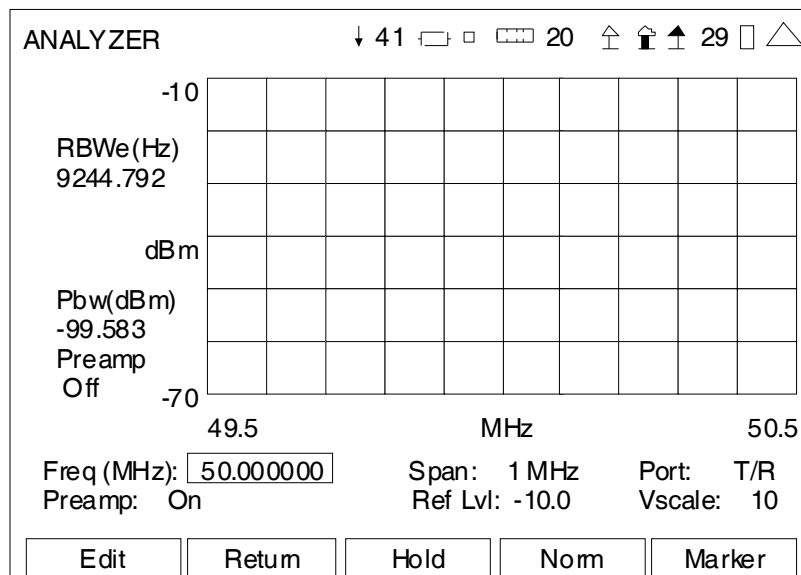

(Control Mode)

SCREEN FEATURE	FUNCTION
RBWe(Hz)	Displays the equivalent resolution bandwidth.
Pbw(dBm)	Displays the total power inside the power bandwidth markers.
Freq (MHz)	Used to select the Spectrum Analyzer center frequency. Range: 2.000000 to 1000.000000 MHz in 0.000001 MHz increments
Preamp	Used to select the Preamp for an additional gain of 20 dB. Select: On or Off
Span	Used to select the Frequency Span adjustment to control the bandwidth of the displayed frequency. Select: 10 kHz, 20 kHz, 50 kHz, 100 kHz, 200 kHz, 500 kHz, 1 MHz, 2 MHz or 5 MHz
Ref Lvl	Used to select the Reference Level on the Spectrum Analyzer. Select: -90.0 to 10.0 dBm in 0.1 dB increments
Port	Used to select the signal input connector. Select: ANT or T/R
Vscale	Used to adjust the vertical scale of the major divisions on the Spectrum Analyzer Screen. Select: 2, 5, 10, 15 or 20 (dB)

4-3-2. SPECTRUM ANALYZER SCREEN FEATURES AND FUNCTIONS (cont)

SCREEN FEATURE	FUNCTION
F1 "Edit" / "Done" / "Next"	Edit Highlights the selected field to be changed or changes the field value if the field only contains two selections.
	Done Ends the Field Edit and saves the new setting / value.
	Next Displays the next pop-up screen.
F2 "Return" / "Save"	Return Displays the System Menu (para 2-2-2)
	Save Saves the test screen.
F3 "Hold" / "Resume" / "Find"	Hold Freezes the screen.
	Resume Restores the screen to active mode.
	Find Used to perform the Frequency Find function.
F4 "Norm" / "Abort"	Norm Instruction pop-ups are displayed to normalize the Spectrum Analyzer.
	Abort Aborts the normalize sequence.
F5 "Control" / "Marker" / "PBw" / "Esc"	Control Used to change the displayed fields and functionality on the Spectrum Analyzer Screen to Control Mode.
	Marker Used to change the displayed fields and functionality on the Spectrum Analyzer Screen to Marker Mode.
	PBw Used to change the displayed fields and functionality on the Spectrum Analyzer Screen to Power Bandwidth Mode.
	Esc Ends the Field Edit, but does <u>NOT</u> save any changes to the setting or value.

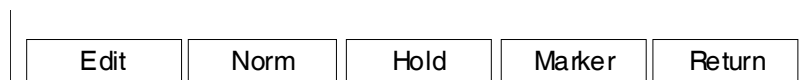

(when accessed from the Mini-Meter)

SCREEN FEATURE	FUNCTION
F1 "Edit" / "Done" / "Next"	Edit Highlights the selected field to be changed or changes the field value if the field only contains two selections.
	Done Ends the Field Edit and saves the new setting / value.
	Next Displays the next pop-up screen.
F2 "Norm" / "Save"	Norm Instruction pop-ups are displayed to normalize the Spectrum Analyzer.
	Save Performs a data dump of frames displayed on the screen, including configurations, readings and settings. The data dump is stored in a time-stamped ASCII report and can be retrieved at a later time.

4-3-2. SPECTRUM ANALYZER SCREEN FEATURES AND FUNCTIONS (cont)

SCREEN FEATURE	FUNCTION
F3 "Hold" / "Resume" / "Find"	<p>Hold Freezes the screen.</p> <p>Resume Restores the screen to active mode.</p> <p>Find Used to perform the Frequency Find function.</p>
F4 "Control" / "Marker" / "PBw"	<p>Control Used to change the displayed fields and functionality on the Spectrum Analyzer Screen to Control Mode.</p> <p>Marker Used to change the displayed fields and functionality on the Spectrum Analyzer Screen to Marker Mode.</p> <p>PBw Used to change the displayed fields and functionality on the Spectrum Analyzer Screen to Power Bandwidth Mode.</p>
F5 "Return" / "Esc"	<p>Return Closes the Spectrum Analyzer Screen and returns to the Test Screen.</p> <p>Esc Ends the Field Edit, but does <u>NOT</u> save any changes to the setting or value.</p>

4-3-2. SPECTRUM ANALYZER SCREEN FEATURES AND FUNCTIONS (cont)

SCREEN FEATURE	FUNCTION
F1 "Edit" / "Done" / "Next"	Edit Highlights the selected field to be changed or changes the field value if the field only contains two selections.
	Done Ends the Field Edit and saves the new setting / value.
	Next Displays the next pop-up screen.
F2 "Return" / "Save"	Return Displays the System Menu (para 2-2-2)
	Save Saves the test screen.
F3 "Hold" / "Resume"	Hold Freezes the screen.
	Resume Restores the screen to active mode.
F4 "Norm" / "Abort"	Norm Instruction pop-ups are displayed to normalize the Spectrum Analyzer.
	Abort Aborts the normalize sequence.
F5 "Control" / "Marker" / "PBw" / "Esc"	Control Used to change the displayed fields and functionality on the Spectrum Analyzer Screen to Control Mode.
	Marker Used to change the displayed fields and functionality on the Spectrum Analyzer Screen to Marker Mode.
	PBw Used to change the displayed fields and functionality on the Spectrum Analyzer Screen to Power Bandwidth Mode.
	Esc Ends the Field Edit, but does <u>NOT</u> save any changes to the setting or value.

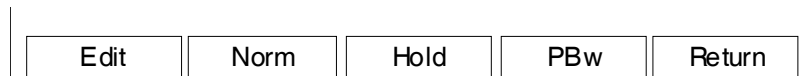

(when accessed from the Mini-Meter)

SCREEN FEATURE	FUNCTION
F1 "Edit" / "Done" / "Next"	Edit Highlights the selected field to be changed or changes the field value if the field only contains two selections.
	Done Ends the Field Edit and saves the new setting / value.
	Next Displays the next pop-up screen.
F2 "Norm" / "Save"	Norm Instruction pop-ups are displayed to normalize the Spectrum Analyzer.
	Save Performs a data dump of frames displayed on the screen, including configurations, readings and settings. The data dump is stored in a time-stamped ASCII report and can be retrieved at a later time.
F3 "Hold" / "Resume"	Hold Freezes the screen.
	Resume Restores the screen to active mode.

4-3-2. SPECTRUM ANALYZER SCREEN FEATURES AND FUNCTIONS (cont)

SCREEN FEATURE	FUNCTION	
F4 "Control" / "Marker" / "PBw"	Control	Used to change the displayed fields and functionality on the Spectrum Analyzer Screen to Control Mode.
	Marker	Used to change the displayed fields and functionality on the Spectrum Analyzer Screen to Marker Mode.
	PBw	Used to change the displayed fields and functionality on the Spectrum Analyzer Screen to Power Bandwidth Mode.
F5 "Return" / "Esc"	Return	Closes the Spectrum Analyzer Screen and returns to the Test Screen.
	Esc	Ends the Field Edit, but does <u>NOT</u> save any changes to the setting or value.

4-3-2. SPECTRUM ANALYZER SCREEN FEATURES AND FUNCTIONS (cont)

SCREEN FEATURE	FUNCTION
F3 "Hold" / "Resume"	Hold Freezes the screen.
	Resume Restores the screen to active mode.
F4 "Norm" / "Abort"	Norm Instruction pop-ups are displayed to normalize the Spectrum Analyzer.
	Abort Aborts the normalize sequence.
F5 "Control" / "Marker" / "PBw" / "Esc"	Control Used to change the displayed fields and functionality on the Spectrum Analyzer Screen to Control Mode.
	Marker Used to change the displayed fields and functionality on the Spectrum Analyzer Screen to Marker Mode.
	PBw Used to change the displayed fields and functionality on the Spectrum Analyzer Screen to Power Bandwidth Mode.
	Esc Ends the Field Edit, but does <u>NOT</u> save any changes to the setting or value.

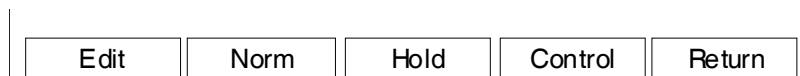

(when accessed from the Mini-Meter)

SCREEN FEATURE	FUNCTION
F1 "Edit" / "Done" / "Next"	Edit Highlights the selected field to be changed or changes the field value if the field only contains two selections.
	Done Ends the Field Edit and saves the new setting / value.
	Next Displays the next pop-up screen.
F2 "Norm" / "Save"	Norm Instruction pop-ups are displayed to normalize the Spectrum Analyzer.
	Save Performs a data dump of frames displayed on the screen, including configurations, readings and settings. The data dump is stored in a time-stamped ASCII report and can be retrieved at a later time.
F3 "Hold" / "Resume"	Hold Freezes the screen.
	Resume Restores the screen to active mode.
F4 "Control" / "Marker" / "PBw"	Control Used to change the displayed fields and functionality on the Spectrum Analyzer Screen to Control Mode.
	Marker Used to change the displayed fields and functionality on the Spectrum Analyzer Screen to Marker Mode.
	PBw Used to change the displayed fields and functionality on the Spectrum Analyzer Screen to Power Bandwidth Mode.

4-3-2. SPECTRUM ANALYZER SCREEN FEATURES AND FUNCTIONS (cont)

SCREEN FEATURE	FUNCTION				
F5 "Return" / "Esc"	<table><tr><td data-bbox="532 344 669 373">Return</td><td data-bbox="669 344 1469 401">Closes the Spectrum Analyzer Screen and returns to the Test Screen.</td></tr><tr><td data-bbox="532 415 587 445">Esc</td><td data-bbox="669 415 1469 472">Ends the Field Edit, but does <u>NOT</u> save any changes to the setting or value.</td></tr></table>	Return	Closes the Spectrum Analyzer Screen and returns to the Test Screen.	Esc	Ends the Field Edit, but does <u>NOT</u> save any changes to the setting or value.
Return	Closes the Spectrum Analyzer Screen and returns to the Test Screen.				
Esc	Ends the Field Edit, but does <u>NOT</u> save any changes to the setting or value.				

THIS PAGE INTENTIONALLY LEFT BLANK.

4-4. OSCILLOSCOPE OPTION (3500001)

The Oscilloscope Option (3500001) adds an Oscilloscope to the testing compatibilities of the 3500 / 3500A.

The Oscilloscope provides users with the ability to perform time dependent measurement analysis.

4-4-1. OSCILLOSCOPE SCREEN

When the System Menu is displayed, press the appropriate Number Key to display the Oscilloscope Screen.

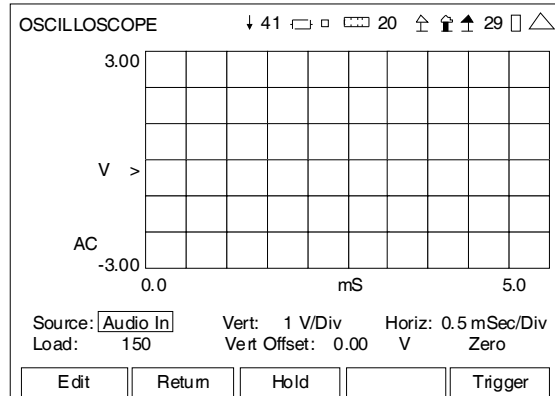
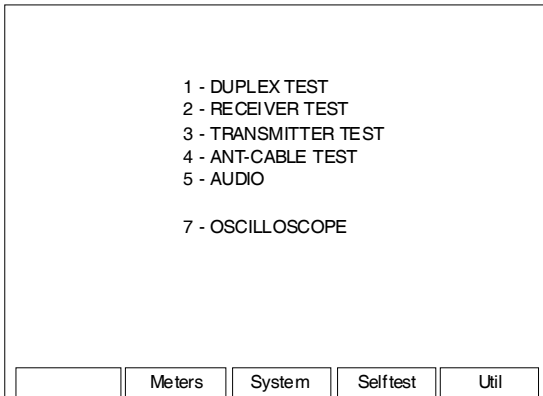

The Oscilloscope Screen can also be added to the Duplex, Receiver, Transmitter and Audio Function Generator Test Screens for easy access.

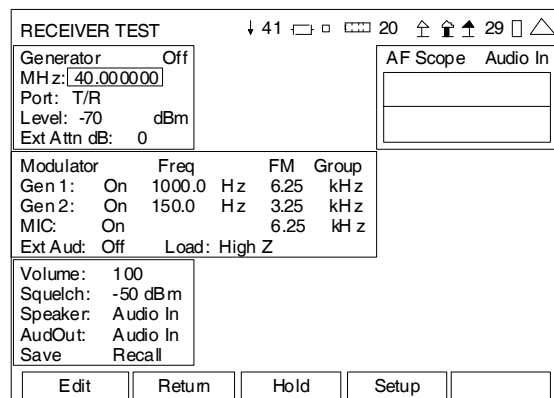
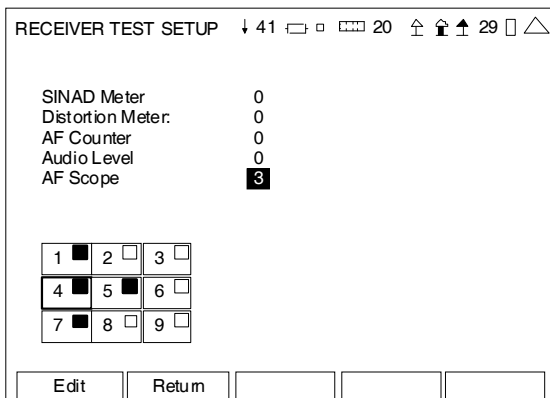

To access the Oscilloscope on the Duplex, Receiver, Transmitter and Audio Function Generator Test Screens:

- Press the ◀ LEFT Key or ▶ RIGHT Key to move the on-screen cursor to the Oscilloscope frame.
- Press the F1 “Zoom” Key to display the Oscilloscope Screen or use the ▼ DOWN Key to access the Oscilloscope Mini-Meter Source Field.

4-4-2. OSCILLOSCOPE SCREEN FEATURES AND FUNCTIONS

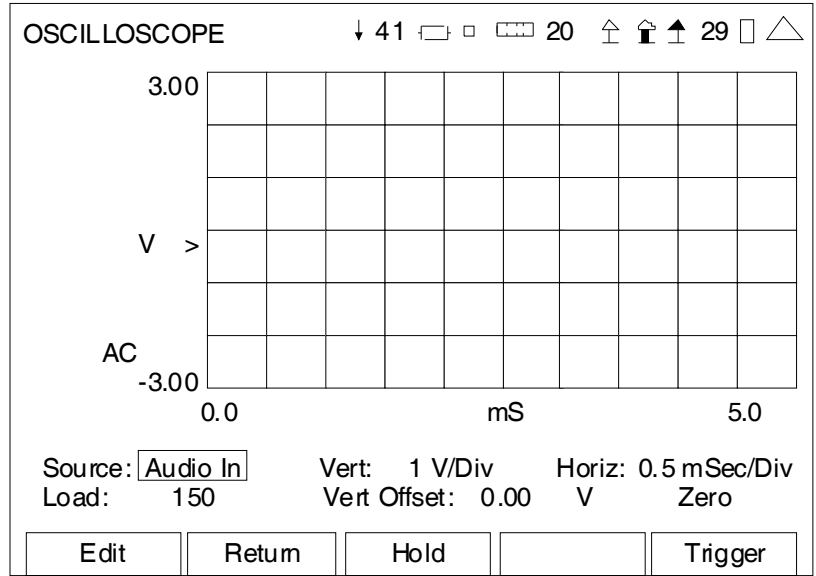

(Control Mode)

SCREEN FEATURE	FUNCTION
Source	Used to select the signal source. Select: Audio In, DVM or Demod (Duplex Test Screen) Audio In or DVM (Receiver Test Screen) Audio In, DVM or Demod (Transmitter Test Screen) Audio In or DVM (Audio Function Generator Screen) When the Source Field is set to DVM, the Coupling Field can be set to AC or DC.
Vert	Used to select the Vertical Scale of the Oscilloscope. Select: 10 mV/Div, 20 mV/Div, 50 mV/Div, 0.1 V/Div, 0.2 V/Div, 0.5 V/Div, 1 V/Div, 2 V/Div, 5 V/Div or 10 V/Div 5%/Div, 10%/Div, 20%/Div or 50%/Div (Demod AM) 0.1 kHz/Div to 50 kHz/Div in 1,2,5 sequence (Demod FM)
Horiz	Used to select the Horizontal Scale of the Oscilloscope. Select: 0.5 mSec/Div, 1 mSec/Div, 2 mSec/Div, 4 mSec/Div, 6 mSec/Div, 10 mSec/Div, 20 mSec/Div, 50 mSec/Div or 0.1 Sec/Div
Load	Used to select the Audio input signal load (Ω). Select: 150, 600, 1K (3500A only), Div10 (3500A only) or High Z Field is displayed only when Source Field is set to Audio In.

4-4-2. OSCILLOSCOPE SCREEN FEATURES AND FUNCTIONS (cont)

SCREEN FEATURE	FUNCTION
Vert Offset	Used to select the Vertical Offset of the Oscilloscope. Select: -100.00 to +100.00 V in 0.01 V increments -100% to +100% in 0.01% increments (Demod AM) -100.00 to +100.00 kHz in 0.01 kHz increments (Demod FM)
Zero	Used to remove the DC offset from the DVM signal source. Field is displayed only when Source Field is set to DVM.
F1 "Edit" / "Done"	Edit Highlights the selected field to be changed or changes the field value if the field only contains two selections. Done Ends the Field Edit and saves the new setting / value.
F2 "Return" / "Save"	Return Displays the System Menu (para 2-2-2) Save Performs a data dump of frames displayed on the screen, including configurations, readings and settings. The data dump is stored in a time-stamped ASCII report and can be retrieved at a later time.
F3 "Hold" / "Resume"	Hold Freezes the screen. Resume Restores the screen to active mode.
F5 "Control" / "Marker" / "Trigger" / "Esc"	Control Used to change the displayed fields and functionality on the Oscilloscope Screen to Control Mode. Marker Used to change the displayed fields and functionality on the Oscilloscope Screen to Marker Mode. Trigger Used to change the displayed fields and functionality on the Oscilloscope Screen to Trigger Mode. Esc Ends the Field Edit, but does <u>NOT</u> save any changes to the setting or value.

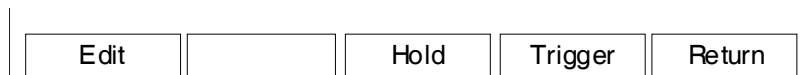

(when accessed from the Mini-Meter)

SCREEN FEATURE	FUNCTION
F1 "Edit" / "Done"	Edit Highlights the selected field to be changed or changes the field value if the field only contains two selections. Done Ends the Field Edit and saves the new setting / value.
F2 "Save"	Performs a data dump of frames displayed on the screen, including configurations, readings and settings. The data dump is stored in a time-stamped ASCII report and can be retrieved at a later time.
F3 "Hold" / "Resume"	Hold Freezes the screen. Resume Restores the screen to active mode.

4-4-2. OSCILLOSCOPE SCREEN FEATURES AND FUNCTIONS (cont)

SCREEN FEATURE	FUNCTION	
F4 "Control" / "Marker" / "Trigger"	Control	Used to change the displayed fields and functionality on the Oscilloscope Screen to Control Mode.
	Marker	Used to change the displayed fields and functionality on the Oscilloscope Screen to Marker Mode.
	Trigger	Used to change the displayed fields and functionality on the Oscilloscope Screen to Trigger Mode.
F5 "Return" / "Esc"	Return	Closes the Oscilloscope Screen and returns to the Test Screen.
	Esc	Ends the Field Edit, but does <u>NOT</u> save any changes to the setting or value.

4-4-2. OSCILLOSCOPE SCREEN FEATURES AND FUNCTIONS (cont)

SCREEN FEATURE	FUNCTION
F3 "Hold" / "Resume"	Hold Freezes the screen.
	Resume Restores the screen to active mode.
F5 "Control" / "Marker" / "Trigger" / "Esc"	Control Used to change the displayed fields and functionality on the Oscilloscope Screen to Control Mode.
	Marker Used to change the displayed fields and functionality on the Oscilloscope Screen to Marker Mode.
	Trigger Used to change the displayed fields and functionality on the Oscilloscope Screen to Trigger Mode.
	Esc Ends the Field Edit, but does <u>NOT</u> save any changes to the setting or value.



(when accessed from the Mini-Meter)

SCREEN FEATURE	FUNCTION
F1 "Edit" / "Done"	Edit Highlights the selected field to be changed or changes the field value if the field only contains two selections.
	Done Ends the Field Edit and saves the new setting / value.
F2 "Save"	Performs a data dump of frames displayed on the screen, including configurations, readings and settings. The data dump is stored in a time-stamped ASCII report and can be retrieved at a later time.
F3 "Hold" / "Resume"	Hold Freezes the screen.
	Resume Restores the screen to active mode.
F4 "Control" / "Marker" / "Trigger"	Control Used to change the displayed fields and functionality on the Oscilloscope Screen to Control Mode.
	Marker Used to change the displayed fields and functionality on the Oscilloscope Screen to Marker Mode.
	Trigger Used to change the displayed fields and functionality on the Oscilloscope Screen to Trigger Mode.
F5 "Return" / "Esc"	Return Closes the Oscilloscope Screen and returns to the Test Screen.
	Esc Ends the Field Edit, but does <u>NOT</u> save any changes to the setting or value.

4-4-2. OSCILLOSCOPE SCREEN FEATURES AND FUNCTIONS (cont)

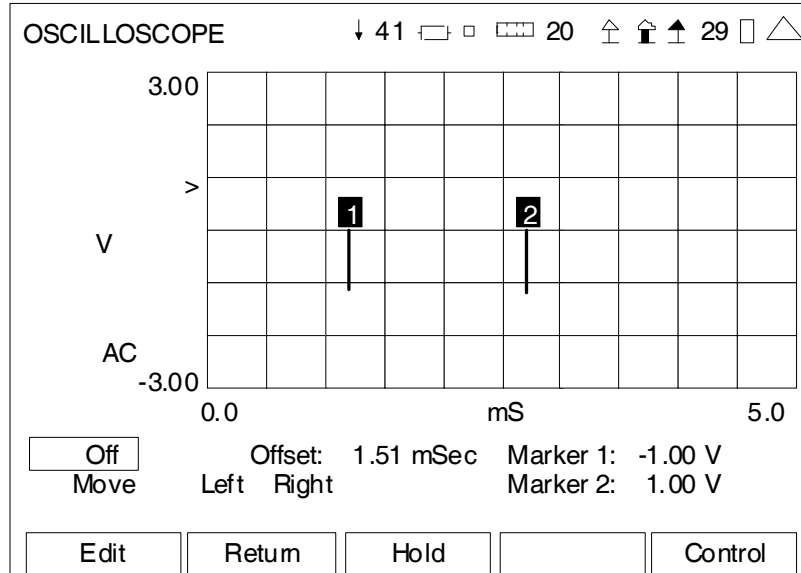

(Marker Mode)

SCREEN FEATURE	FUNCTION
Markers	Used to display the Markers. When Marker 1 or Marker 2 is displayed, then the movement controls (Move, Left and Right) are active for the Markers. Select: Off, Marker 1 or Marker 2
Offset	Displays the Marker Delta in time.
Move	Used to move the Marker in different time stop steps. Select: Move x10, Move x50 or Peak
Left	Used to move the position of the selected Marker to the left. When selected, press the F1 "Enter" Key to move the selected Marker to the left the increment selected in the Move field.
Right	Used to move the position of the selected Marker to the right. When selected, press the F1 "Enter" Key to move the selected Marker to the right the increment selected in the Move field.
Marker 1	Displays the level of Marker 1.
Marker 2	Displays the level of Marker 2.
F1 "Edit" / "Enter" / "Done"	Edit Highlights the selected field to be changed or changes the field value if the field only contains two selections. Enter Moves the Marker the increment selected in the Move field. Done Ends the Field Edit and saves the new setting / value.

4-4-2. OSCILLOSCOPE SCREEN FEATURES AND FUNCTIONS (cont)

SCREEN FEATURE	FUNCTION
F2 "Return" / "Save"	Return Displays the System Menu (para 2-2-2)
	Save Performs a data dump of frames displayed on the screen, including configurations, readings and settings. The data dump is stored in a time-stamped ASCII report and can be retrieved at a later time.
F3 "Hold" / "Resume"	Hold Freezes the screen.
	Resume Restores the screen to active mode.
F5 "Control" / "Marker" / "Trigger" / "Esc"	Control Used to change the displayed fields and functionality on the Oscilloscope Screen to Control Mode.
	Marker Used to change the displayed fields and functionality on the Oscilloscope Screen to Marker Mode.
	Trigger Used to change the displayed fields and functionality on the Oscilloscope Screen to Trigger Mode.
	Esc Ends the Field Edit, but does <u>NOT</u> save any changes to the setting or value.

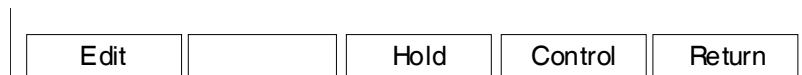

(when accessed from the Mini-Meter)

SCREEN FEATURE	FUNCTION
F1 "Edit" / "Done"	Edit Highlights the selected field to be changed or changes the field value if the field only contains two selections.
	Done Ends the Field Edit and saves the new setting / value.
F2 "Save"	Performs a data dump of frames displayed on the screen, including configurations, readings and settings. The data dump is stored in a time-stamped ASCII report and can be retrieved at a later time.
F3 "Hold" / "Resume"	Hold Freezes the screen.
	Resume Restores the screen to active mode.
F4 "Control" / "Marker" / "Trigger"	Control Used to change the displayed fields and functionality on the Oscilloscope Screen to Control Mode.
	Marker Used to change the displayed fields and functionality on the Oscilloscope Screen to Marker Mode.
	Trigger Used to change the displayed fields and functionality on the Oscilloscope Screen to Trigger Mode.
F5 "Return" / "Esc"	Return Closes the Oscilloscope Screen and returns to the Test Screen.
	Esc Ends the Field Edit, but does <u>NOT</u> save any changes to the setting or value.

4-5. TRACKING GENERATOR OPTION (35000070)

The Tracking Generator Option (35000070) adds a Tracking Generator to the testing compatibilities of the 3500 / 3500A.

The Tracking Generator provides users with the ability to generate a carrier wave that is applied to components or systems, which allows the output to be analyzed to evaluate the frequency response of the device under test.

4-5-1. TRACKING GENERATOR SCREEN

When the System Menu is displayed, press the appropriate Number Key to display the Tracking Generator Screen.

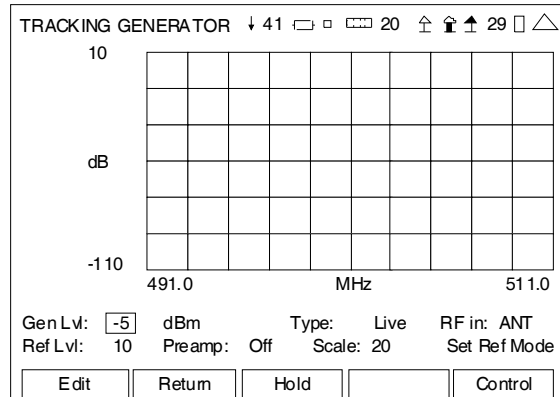
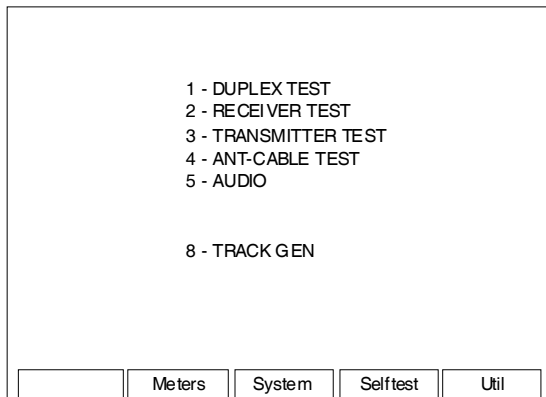

4-5-2. TRACKING GENERATOR SCREEN FEATURES AND FUNCTIONS

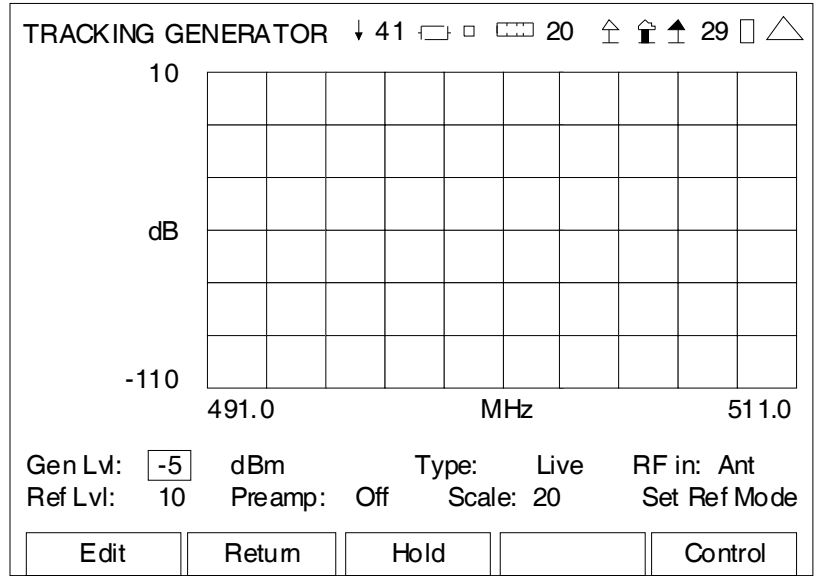

(RF Mode)

SCREEN FEATURE	FUNCTION
Gen Lvl	Used to select the Tracking Generator output level. Select: -65 to -5 dBm in 1 dB increments 125.74 to 125743.34 μ V in 1 dB increments
dBm / μ V	Used to select the units of measure for the Tracking Generator level. Select: dBm or μ V
Type	Used to select the display type. Select: Diff or Live
RF in	Used to select the Tracking Generator input connector. Select: Ant or T/R
Ref Lvl	Used to select the top of screen reference level. Select: -70 to 10 dBm in 10 dB increments
Preamp	Used to set preamp operation ON or OFF.
Scale	Used to select the dB/Div of the vertical axis. Select: 2, 5, 10, 15 or 20
Set Ref Mode	Used to set the Reference level.
F1 "Edit" / "Done"	Edit Highlights the selected field to be changed or changes the field value if the field only contains two selections. Done Ends the Field Edit and saves the new setting / value.

4-5-2. TRACKING GENERATOR SCREEN FEATURES AND FUNCTIONS (cont)

SCREEN FEATURE	FUNCTION
F2 "Return" / "Save"	<p>Return Displays the System Menu (para 2-2-2)</p> <p>Save Performs a data dump of frames displayed on the screen, including configurations, readings and settings. The data dump is stored in a time-stamped ASCII report and can be retrieved at a later time.</p>
F3 "Hold" / "Resume"	<p>Hold Freezes the screen.</p> <p>Resume Restores the screen to active mode.</p>
F5 "Control" / "Marker" / "RF" / "Esc"	<p>Control Used to change the displayed fields and functionality on the Tracking Generator Screen to Control Mode.</p> <p>Marker Used to change the displayed fields and functionality on the Tracking Generator Screen to Marker Mode.</p> <p>RF Used to change the displayed fields and functionality on the Tracking Generator Screen to RF Mode.</p> <p>Esc Ends the Field Edit, but does <u>NOT</u> save any changes to the setting or value.</p>

4-5-2. TRACKING GENERATOR SCREEN FEATURES AND FUNCTIONS (cont)

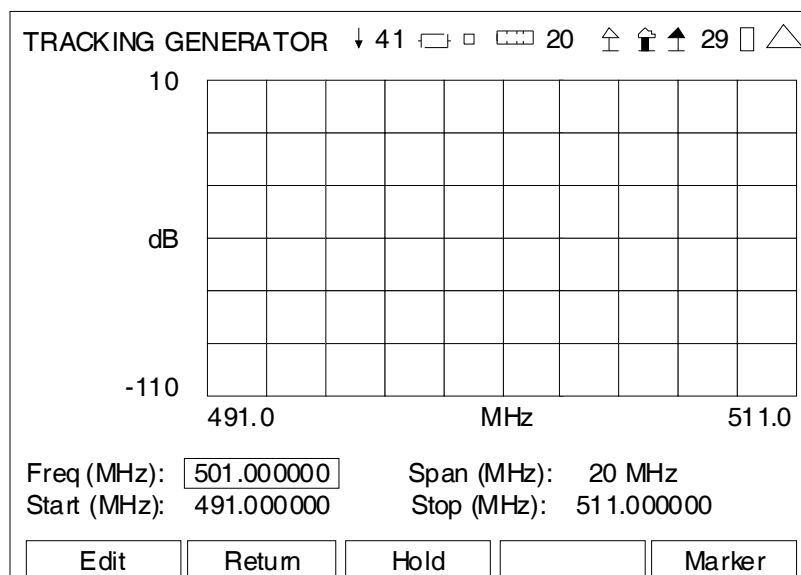

(Control Mode)

SCREEN FEATURE	FUNCTION				
Freq (MHz)	Used to select the Tracking Generator frequency. Select: 2 to 1000 MHz in 0.000001 MHz increments (floating)				
Span (MHz)	Used to select the frequency span. Select: 10 kHz, 20 kHz, 50 kHz, 100 kHz, 200 kHz, 500 kHz, 1 MHz, 2 MHz, 5 MHz, 10 MHz, 20 MHz, 50 MHz, 100 MHz, 200 MHz, 500 MHz or 998 MHz				
Start (MHz)	Used to select/display the Start Frequency. Select: 2 to 1000 MHz in 0.000001 MHz increments (floating)				
Stop (MHz)	Used to select/display the Stop Frequency. Select: 2 to 1000 MHz in 0.000001 MHz increments (floating)				
F1 "Edit" / "Done"	<table border="0"> <tr> <td>Edit</td> <td>Highlights the selected field to be changed or changes the field value if the field only contains two selections.</td> </tr> <tr> <td>Done</td> <td>Ends the Field Edit and saves the new setting / value.</td> </tr> </table>	Edit	Highlights the selected field to be changed or changes the field value if the field only contains two selections.	Done	Ends the Field Edit and saves the new setting / value.
Edit	Highlights the selected field to be changed or changes the field value if the field only contains two selections.				
Done	Ends the Field Edit and saves the new setting / value.				
F2 "Return" / "Save"	<table border="0"> <tr> <td>Return</td> <td>Displays the System Menu (para 2-2-2)</td> </tr> <tr> <td>Save</td> <td>Performs a data dump of frames displayed on the screen, including configurations, readings and settings. The data dump is stored in a time-stamped ASCII report and can be retrieved at a later time.</td> </tr> </table>	Return	Displays the System Menu (para 2-2-2)	Save	Performs a data dump of frames displayed on the screen, including configurations, readings and settings. The data dump is stored in a time-stamped ASCII report and can be retrieved at a later time.
Return	Displays the System Menu (para 2-2-2)				
Save	Performs a data dump of frames displayed on the screen, including configurations, readings and settings. The data dump is stored in a time-stamped ASCII report and can be retrieved at a later time.				
F3 "Hold" / "Resume"	<table border="0"> <tr> <td>Hold</td> <td>Freezes the screen.</td> </tr> <tr> <td>Resume</td> <td>Restores the screen to active mode.</td> </tr> </table>	Hold	Freezes the screen.	Resume	Restores the screen to active mode.
Hold	Freezes the screen.				
Resume	Restores the screen to active mode.				

4-5-2. TRACKING GENERATOR SCREEN FEATURES AND FUNCTIONS (cont)

SCREEN FEATURE	FUNCTION	
F5 "Control" / "Marker" / "RF" / "Esc"	Control	Used to change the displayed fields and functionality on the Tracking Generator Screen to Control Mode.
	Marker	Used to change the displayed fields and functionality on the Tracking Generator Screen to Marker Mode.
	RF	Used to change the displayed fields and functionality on the Tracking Generator Screen to RF Mode.
	Esc	Ends the Field Edit, but does <u>NOT</u> save any changes to the setting or value.

4-5-2. TRACKING GENERATOR SCREEN FEATURES AND FUNCTIONS (cont)

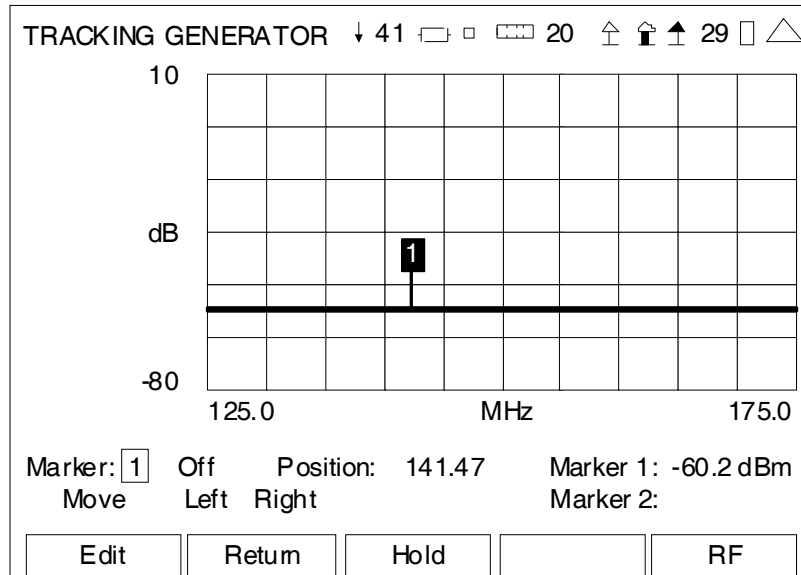

(Marker Mode)

SCREEN FEATURE	FUNCTION
Marker	Used to select and enable one of two markers on the Graphical Display. Select: 1 or 2
Marker Status	Used to set the Marker selected to On or Off.
Position	Displays the Horizontal Axis of the Active Marker. Also used to manually set the location of the Active Marker. Select: 2.00 to 1000.00 in 0.01 increments
Marker 1	Displays the vertical axis of Marker 1 in dBm.
Move/Min/Max	Used to move the Active Marker on the Graphical Display. Select: Move, Max or Min
Left Right	Used with the F1 “Enter” Key to move the Active Marker selected in the Marker Field to the left or to the right on the Graphical Display.
Marker 2	Displays the vertical axis of Marker 2 dBm.
F1 “Edit” / “Enter” / Done”	<p>Edit Highlights the selected field to be changed or changes the field value if the field only contains two selections.</p> <p>Enter Moves the Marker the increment selected in the Move field.</p> <p>Done Ends the Field Edit and saves the new setting / value.</p>

4-5-2. TRACKING GENERATOR SCREEN FEATURES AND FUNCTIONS (cont)

SCREEN FEATURE	FUNCTION
F2 "Return" / "Save"	<p>Return Displays the System Menu (para 2-2-2)</p> <p>Save Performs a data dump of frames displayed on the screen, including configurations, readings and settings. The data dump is stored in a time-stamped ASCII report and can be retrieved at a later time.</p>
F3 "Hold" / "Resume"	<p>Hold Freezes the screen.</p> <p>Resume Restores the screen to active mode.</p>
F5 "Control" / "Marker" / "RF" / "Esc"	<p>Control Used to change the displayed fields and functionality on the Tracking Generator Screen to Control Mode.</p> <p>Marker Used to change the displayed fields and functionality on the Tracking Generator Screen to Marker Mode.</p> <p>RF Used to change the displayed fields and functionality on the Tracking Generator Screen to RF Mode.</p> <p>Esc Ends the Field Edit, but does <u>NOT</u> save any changes to the setting or value.</p>

THIS PAGE INTENTIONALLY LEFT BLANK.

4-6. P25 TEST OPTION (35000100)

The P25 Test Option (35000100) adds P25 test protocols to the testing compatibilities of the 3500 / 3500A.

The P25 Test Option provides users with the ability to test P25 radio systems.

4-6-1. P25 MINI METER

The P25 Mini Meter can be added to the Duplex and Transmitter Test Screens.

DUPLIX TEST SETUP												
Modulation Meter	0	DCS Decode	0									
RSSI Meter	0	Audio Level	0									
RF Error Meter	0	Digital Receive	9									
RF Power Meter	0											
SINAD Meter	0											
Distortion Meter	0											
AF Counter	0											
DTMF Decode	0											
<table border="1"> <tr> <td>1</td><td>2</td><td>3</td> </tr> <tr> <td>4</td><td>5</td><td>6</td> </tr> <tr> <td>7</td><td>8</td><td>9</td> </tr> </table>				1	2	3	4	5	6	7	8	9
1	2	3										
4	5	6										
7	8	9										
Edit		Return										

DUPLIX TEST			
Generator	Off	Receiver	More
MHz	40.000000	MHz	40.000000
Port:	T/R	Port:	T/R
Level:	-70 dBm	Mod:	P25
Ext Attn	0		
Modulator	P25	Digital	
Pattern:	1011		
NAC:	293		
Volume:	100	P25 Demod	More
Squelch:	-50 dBm	Sig Pwr	---
Speaker:	Audio In	Freq Err	---
AudOut:	Audio In	Mod Fidly	---
Save	Recall	Deviation	---
Edit		Return	Hold
		Setup	PTT on

To access the P25 Mini Meter fields on the Duplex and Transmitter Test Screens:

- Press the ◀ LEFT Key or ▶ RIGHT Key to move the on-screen cursor to the P25 Demod frame.
- Press the ▲ UP Key or ▼ DOWN Key to move the on-screen cursor to the More field and press the F1 “Enter” Key to display additional P25 fields.
- Press the ▲ UP Key or ▼ DOWN Key to move the on-screen cursor from one field to another.

To access the Digital Receive Screen for P25 field settings:

- Press the ◀ LEFT Key or ▶ RIGHT Key to move the on-screen cursor to the P25 Demod frame.
- Press the F1 “Zoom” Key to display the Digital Receive Screen.

The P25 Test Pattern field can also be accessed in the modulation frame on the Duplex and Transmitter Test Screens:

DUPLIX TEST			
Generator	Off	Receiver	More
MHz	40.000000	MHz	40.000000
Port:	T/R	Port:	T/R
Level:	-70 dBm	Mod:	P25
Ext Attn	0		
Modulator	P25	Digital	
Pattern:	1011		
NAC:	293		
Volume:	100	P25 Demod	More
Squelch:	-50 dBm	Sig Pwr	---
Speaker:	Audio In	Freq Err	---
AudOut:	Audio In	Mod Fidly	---
Save	Recall	Deviation	---
Edit		Return	Hold
		Setup	PTT on

4-6-2. P25 MINI METER FEATURES AND FUNCTIONS

P25 Demod	More
Sig Pwr	---
Freq Err	---
Mod Fidly	---
Deviation	---

P25 Demod	More
BER	---
NAC	---
Pattern	1011
Reset Acq	

SCREEN FEATURE	FUNCTION
Sig Pwr	Displays the RF level at the input connector.
Freq Err	Displays the frequency error of the transmitted signal.
Mod Fidly	Displays the P25 waveform modulation fidelity.
Deviation	Displays the symbol deviation accuracy.
BER	Displays the incoming P25 symbol data compared to a standard pattern in determining errors in signal processing.
NAC	Displays the Network Access Code.
Pattern	Used to set the data or voice pattern. Select: 1011, 0.153 or CAL
Reset Acq	Used to reacquire the input signal.

4-6-3. DIGITAL RECEIVE (P25) SCREEN FEATURES AND FUNCTIONS

P25 Demod		Lower Limit	Upper Limit	Limit State	Avg
Freq Err:	-2.0 Hz	-800.0	800.0	Off	1
Mod Fidly:	0.5 %	0.0	100.0	Off	1
Dev:	1809 Hz	0	9999	Off	1
Sig Pwr:	-1.5 dBm	-130.0	60.0	Off	1
BER:	0.000 %	0.000	100.000	Off	1
NAC:	239				
Pattern:	1011				

Reset Acq

Edit Hold Return

SCREEN FEATURE	FUNCTION
Freq Err	Used to select the parameters of the frequency error of the transmitted signal. Lower Limit: -800.0 to 800.0 Hz in 0.1 Hz increments Upper Limit: -800.0 to 800.0 Hz in 0.1 Hz increments Limit State: On or Off Avg: 1 to 99
Mod Fidly	Used to select the parameters of the P25 waveform modulation fidelity. Lower Limit: 0.0% to 100.0% in 0.1% increments Upper Limit: 0.0% to 100.0% in 0.1% increments Limit State: On or Off Avg: 1 to 99
Dev	Used to select the parameters of the symbol deviation accuracy. Lower Limit: 0 to 9999 Hz in 1 Hz increments Upper Limit: 0 to 9999 Hz in 1 Hz increments Limit State: On or Off Avg: 1 to 99

4-6-3. DIGITAL RECEIVE (P25) SCREEN FEATURES AND FUNCTIONS (cont)

SCREEN FEATURE	FUNCTION
Sig Pwr	Used to select the parameters of the RF level at the input connector. Lower Limit: -130.0 to 60.0 dBm in 0.1 dB increments Upper Limit: -130.0 to 60.0 dBm in 0.1 dB increments Limit State: On or Off Avg: 1 to 99
BER	Used to select the parameters of the incoming P25 symbol data compared to a standard pattern in determining errors in signal processing. Lower Limit: 0.000% to 100.000% in 0.001% increments Upper Limit: 0.000% to 100.000% in 0.001% increments Limit State: On or Off Avg: 1 to 99
NAC	Displays the Network Access Code.
Pattern	Used to set the data or voice pattern. Select: 1011, 0.153 or CAL
Reset Acq	Used to reacquire the input signal.
F1 "Edit" / "Done" / "Enter" / "Save"	<p>Edit Highlights the selected field to be changed or changes the field value if the field only contains two selections.</p> <p>Done Ends the Field Edit and saves the new setting / value.</p> <p>Enter Initiates the selected field.</p> <p>Save Performs a data dump of frames displayed on the screen, including configurations, readings and settings. The data dump is stored in a time-stamped ASCII report and can be retrieved at a later time.</p>
F2 "Resume"	Resume Restores the screen to active mode.
F3 "Hold"	Hold Freezes the screen.
F5 "Return" / "Esc"	<p>Return Closes the Digital Receive Screen and returns to the Test Screen.</p> <p>Esc Ends the Field Edit, but does NOT save any changes to the setting or value.</p>

4-7. DMR OPTION (35000200)

The DMR Option (35000200) adds DMR test protocols to the testing compatibilities of the 3500 / 3500A.

The DMR Option provides users with the ability to test digital two-way radio systems.

4-7-1. DMR MINI METER

The DMR Mini Meter can be added to the Duplex and Transmitter Test Screens.

DUPLX TEST SETUP												
Modulation Meter	0	DCS Decode	0									
RSSI Meter	0	Audio Level	0									
RF Error Meter	0	Digital Receive	9									
RF Power Meter	0											
SINAD Meter	0											
Distortion Meter	0											
AF Counter	0											
DTMF Decode	0											
<table border="1"> <tr> <td>1</td><td>2</td><td>3</td> </tr> <tr> <td>4</td><td>5</td><td>6</td> </tr> <tr> <td>7</td><td>8</td><td>9</td> </tr> </table>				1	2	3	4	5	6	7	8	9
1	2	3										
4	5	6										
7	8	9										
Edit		Return										

DUPLX TEST			
Generator	Off	Receiver	More
MH z	40.000000	MH z:	40.000000
Port:	T/R	Port:	T/R
Level:	-70 dBm	Mod:	DMR
Ext Attn dB:	0		
Modulator	DMR	Digital	
Pattern:	1031		
Color:	293		
Call ID:	0		
Volume:	100	DMR Demod	More
Squelch:	-50 dBm	Freq Err	-4.4
Speaker:	Audio In	FSK Err	3.3
AudOut:	Audio In	Sym Dev	1947
Save	Recall	Mag Err	0.41
Edit		Return	Hold
		Setup	PTT on

To access the DMR Mini Meter fields on the Duplex and Transmitter Test Screens:

- Press the ◀ LEFT Key or ▶ RIGHT Key to move the on-screen cursor to the DMR Demod frame.
- Press the ▲ UP Key or ▼ DOWN Key to move the on-screen cursor to the More field and press the F1 “Enter” Key to display additional DMR fields.
- Press the ▲ UP Key or ▼ DOWN Key to move the on-screen cursor from one field to another.

To access the Digital Receive Screen for DMR field settings:

- Press the ◀ LEFT Key or ▶ RIGHT Key to move the on-screen cursor to the DMR Demod frame.
- Press the F1 “Zoom” Key to display the Digital Receive Screen.

The DMR Test Pattern, Color and Call ID fields can also be accessed in the modulation frame on the Duplex and Transmitter Test Screens:

DUPLX TEST			
Generator	Off	Receiver	More
MH z	40.000000	MH z:	40.000000
Port:	T/R	Port:	T/R
Level:	-70 dBm	Mod:	DMR
Ext Attn dB:	0		
Modulator	DMR	Digital	
Pattern:	1031		
Color:	293		
Call ID:	0		
Volume:	100	DMR Demod	More
Squelch:	-50 dBm	Freq Err	-4.4
Speaker:	Audio In	FSK Err	3.3
AudOut:	Audio In	Sym Dev	1947
Save	Recall	Mag Err	0.41
Edit		Return	Hold
		Setup	PTT on

4-7-2. DMR MINI METER FEATURES AND FUNCTIONS

DMR Demod	More
Freq Err	-4.4
FSK Err	3.3
Sym Dev	1947
Mag Err	0.41

DMR Demod	More
Pattern	1031
BER	3.241
Slot1 Pwr	-25.0
Slot2 Pwr	-6.4

DMR Demod	More
Color	0
Call ID	0
Rad. ID	16777016
Reset Acq	

SCREEN FEATURE	FUNCTION
Freq Err	Displays the frequency error of the transmitted signal.
FSK Err	Displays the FSK Error of the transmitted signal.
Sym Dev	Displays the symbol deviation accuracy.
Mag Err	Displays the magnitude error.
Pattern	Used to set the data or voice pattern. Select: 1031, BR (Base Radio), 0.153 or CAL
BER	Displays the incoming DMR symbol data compared to a standard pattern in determining errors in signal processing.
Slot1 Pwr	Displays the Slot1 power measurement.
Slot2 Pwr	Displays the Slot2 power measurement.
Color	Displays the Color Code.
Call ID	Displays the Call Identification value.
Rad. ID	Displays the Radio Identification value.
Reset Acq	Used to reacquire the input signal.

4-7-3. DIGITAL RECEIVE (DMR) SCREEN FEATURES AND FUNCTIONS

Digital Receive					
		↓ 41	□ □ □	20	↑ ↑ ↑ 29
DMR Demod	Reading	Lower Limit	Upper Limit	Limit State	Avg
Freq Error:	-60.3 Hz	-800.0	800.0	Off	1
FSK Error:	28.5 %	0.0	100.0	Off	1
Sym Dev:	2010 Hz	0	9999	Off	1
Signal Pwr:	-7.3 dBm	-130.0	60.0	Off	1
BER:	3.704 %	0.000	100.000	Off	1
Slot1 Pwr:	-19.5 dBm	-130.0	60.0	Off	1
Slot2 Pwr:	-7.4 dBm	-130.0	60.0	Off	1
Mag Error:	28.81 %	0.00	100.00	Off	1
Color Code:	0				
Call ID:	0				
Radio ID:	16777016				
Pattern:	1031				
Reset Acq					
Edit		Hold		Return	

SCREEN FEATURE	FUNCTION
Freq Error	Used to select the parameters of the frequency error of the transmitted signal. Lower Limit: -800.0 to 800.0 Hz in 0.1 Hz increments Upper Limit: -800.0 to 800.0 Hz in 0.1 Hz increments Limit State: On or Off Avg: 1 to 99
FSK Error	Used to select the parameters of the FSK error of the transmitted signal. Lower Limit: 0.0% to 100.0% in 0.1% increments Upper Limit: 0.0% to 100.0% in 0.1% increments Limit State: On or Off Avg: 1 to 99
Sym Dev	Used to select the parameters of the symbol deviation accuracy. Lower Limit: 0 to 9999 Hz in 1 Hz increments Upper Limit: 0 to 9999 Hz in 1 Hz increments Limit State: On or Off Avg: 1 to 99

4-7-3. DIGITAL RECEIVE (DMR) SCREEN FEATURES AND FUNCTIONS (cont)

SCREEN FEATURE	FUNCTION
Signal Pwr	Used to select the parameters of the RF level at the input connector. Lower Limit: -130.0 to 60.0 dBm in 0.1 dB increments Upper Limit: -130.0 to 60.0 dBm in 0.1 dB increments Limit State: On or Off Avg: 1 to 99
BER	Used to select the parameters of the incoming DMR symbol data compared to a standard pattern in determining errors in signal processing. Lower Limit: 0.000% to 100.000% in 0.001% increments Upper Limit: 0.000% to 100.000% in 0.001% increments Limit State: On or Off Avg: 1 to 99
Slot1 Pwr	Used to select the parameters of the Slot1 power measurement. Lower Limit: -130.0 to 60.0 dBm in 0.1 dB increments Upper Limit: -130.0 to 60.0 dBm in 0.1 dB increments Limit State: On or Off Avg: 1 to 99
Slot2 Pwr	Used to select the parameters of the Slot2 power measurement. Lower Limit: -130.0 to 60.0 dBm in 0.1 dB increments Upper Limit: -130.0 to 60.0 dBm in 0.1 dB increments Limit State: On or Off Avg: 1 to 99
Mag Error	Used to select the parameters of the magnitude error. Lower Limit: 0.00% to 100.00% in 0.01% increments Upper Limit: 0.000% to 100.000% in 0.01% increments Limit State: On or Off Avg: 1 to 99
Color Code	Used to select the Color Code. Select: 0 to 15
Call ID	Used to select the Call Identification value. Select: 00000000 to 16777215
Radio ID	Used to select the Radio Identification value. Select: 0 to 15

4-7-3. DIGITAL RECEIVE (DMR) SCREEN FEATURES AND FUNCTIONS (cont)

SCREEN FEATURE	FUNCTION
Pattern	Used to set the data or voice pattern. Select: 1031, BR (Base Radio), 0.153 or CAL
Reset Acq	Used to reacquire the input signal.
F1 "Edit" / "Done" / "Enter" / "Save"	<p>Edit Highlights the selected field to be changed or changes the field value if the field only contains two selections.</p> <p>Done Ends the Field Edit and saves the new setting / value.</p> <p>Enter Initiates the selected field.</p> <p>Save Performs a data dump of frames displayed on the screen, including configurations, readings and settings. The data dump is stored in a time-stamped ASCII report and can be retrieved at a later time.</p>
F2 "Resume"	Resume Restores the screen to active mode.
F3 "Hold"	Hold Freezes the screen.
F5 "Return" / "Esc"	<p>Return Closes the Digital Receive Screen and returns to the Test Screen.</p> <p>Esc Ends the Field Edit, but does NOT save any changes to the setting or value.</p>

THIS PAGE INTENTIONALLY LEFT BLANK.

4-8. NXDN OPTION (35000400)

The NXDN Option (35000400) NXDN test protocols to the testing compatibilities of the 3500 / 3500A.

The NXDN Option provides users with the ability to test digital two-way radio systems.

4-8-1. NXDN MINI METER

The NXDN Mini Meter can be added to the Duplex and Transmitter Test Screens.

DUPLX TEST SETUP												
Modulation Meter	0	DCS Decode	0									
RSSI Meter	0	Audio Level	0									
RF Error Meter	0	Digital Receive	9									
RF Power Meter	0											
SINAD Meter	0											
Distortion Meter	0											
AF Counter	0											
DTMF Decode	0											
<table border="1"> <tr> <td>1</td><td>2</td><td>3</td> </tr> <tr> <td>4</td><td>5</td><td>6</td> </tr> <tr> <td>7</td><td>8</td><td>9</td> </tr> </table>				1	2	3	4	5	6	7	8	9
1	2	3										
4	5	6										
7	8	9										
Edit		Return										

DUPLX TEST			
Generator	Off	Receiver	More
MH z	40.000000	MH z	40.000000
Port:	T/R	Port:	T/R
Level:	-70 dBm	Mod:	NXDN
Ext Attn dB:	0		
Modulator	NXDN	Digital	
Pattern:	1031		
RAN:	1		
Rate:	4800		
Volume:	100	NXDN Demod	More
Squelch:	-50 dBm	Sig Pwr	-1.8
Speaker:	Audio In	Freq Err	-4.3
AudOut:	Audio In	FSK Err	1.0
Save	Recall	Sym Dev	1056
Edit		Return	Hold
		Setup	PTT on

To access the NXDN Mini Meter fields on the Duplex and Transmitter Test Screens:

- Press the ◀ LEFT Key or ▶ RIGHT Key to move the on-screen cursor to the NXDN Demod frame.
- Press the ▲ UP Key or ▼ DOWN Key to move the on-screen cursor to the More field and press the F1 “Enter” Key to display additional NXDN fields.
- Press the ▲ UP Key or ▼ DOWN Key to move the on-screen cursor from one field to another.

To access the Digital Receive Screen for NXDN field settings:

- Press the ◀ LEFT Key or ▶ RIGHT Key to move the on-screen cursor to the NXDN Demod frame.
- Press the F1 “Zoom” Key to display the Digital Receive Screen.

The NXDN Test Pattern, RAN and Rate fields can also be accessed in the modulation frame on the Duplex and Transmitter Test Screens:

DUPLX TEST			
Generator	Off	Receiver	More
MH z	40.000000	MH z	40.000000
Port:	T/R	Port:	T/R
Level:	-70 dBm	Mod:	NXDN
Ext Attn dB:	0		
Modulator	NXDN	Digital	
Pattern:	1031		
RAN:	1		
Rate:	4800		
Volume:	100	NXDN Demod	More
Squelch:	-50 dBm	Sig Pwr	-1.8
Speaker:	Audio In	Freq Err	-4.3
AudOut:	Audio In	FSK Err	1.0
Save	Recall	Sym Dev	1056
Edit		Return	Hold
		Setup	PTT on

4-8-2. NXDN MINI METER FEATURES AND FUNCTIONS

NXDN Demod	<input type="button" value="More"/>
Sig Pwr	-1.9
Freq Err	4.3
FSK Err	1.0
Sym Dev	1056

NXDN Demod	<input type="button" value="More"/>
BER	1.736
RAN	0
Rate	4800
Pattern	1031

NXDN Demod	<input type="button" value="More"/>
Reset Acq	

SCREEN FEATURE	FUNCTION
Sig Pwr	Displays the RF level at the input connector.
Freq Err	Displays the frequency error of the transmitted signal.
FSK Err	Displays the FSK Error of the transmitted signal.
Sym Dev	Displays the symbol deviation accuracy.
BER	Displays the incoming NXDN symbol data compared to a standard pattern in determining errors in signal processing.
RAN	Displays the Radio Access Number.
Rate	Used to select the rate that data is transmitted. Select: 4800 or 9600 bps
Pattern	Used to set the data or voice pattern. Select: 1031, 0.153 or CAL
Reset Acq	Used to reacquire the input signal.

4-8-3. DIGITAL RECEIVE (NXDN) SCREEN FEATURES AND FUNCTIONS

Digital Receive		↓ 41	□	□	□	20	↑	↑	↑ 29	□	△
DMR Demod	Reading	Lower Limit	Upper Limit	Limit State	Avg						
Freq Error:	-4.5 Hz	-800.0	800.0	Off	1						
FSK Error:	1.1 %	0.0	100.0	Off	1						
Sym Dev:	1056 Hz	0	9999	Off	1						
Signal Pwr:	-1.7 dBm	-130.0	60.0	Off	1						
BER:	2.083 %	0.000	100.000	Off	1						
RAN:	0										
Rate:	4800										
Pattern:	1031										
Reset Acq											
Edit			Hold			Return					

SCREEN FEATURE	FUNCTION
Freq Error	Used to select the parameters of the frequency error of the transmitted signal. Lower Limit: -800.0 to 800.0 Hz in 0.1 Hz increments Upper Limit: -800.0 to 800.0 Hz in 0.1 Hz increments Limit State: On or Off Avg: 1 to 99
FSK Error	Used to select the parameters of the FSK error of the transmitted signal. Lower Limit: 0.0% to 100.0% in 0.1% increments Upper Limit: 0.0% to 100.0% in 0.1% increments Limit State: On or Off Avg: 1 to 99
Sym Dev	Used to select the parameters of the symbol deviation accuracy. Lower Limit: 0 to 9999 Hz in 1 Hz increments Upper Limit: 0 to 9999 Hz in 1 Hz increments Limit State: On or Off Avg: 1 to 99

4-8-3. DIGITAL RECEIVE (NXDN) SCREEN FEATURES AND FUNCTIONS (cont)

SCREEN FEATURE	FUNCTION
Signal Pwr	Used to select the parameters of the RF level at the input connector. Lower Limit: -130.0 to 60.0 dBm in 0.1 dB increments Upper Limit: -130.0 to 60.0 dBm in 0.1 dB increments Limit State: On or Off Avg: 1 to 99
BER	Used to select the parameters of the incoming NXDN symbol data compared to a standard pattern in determining errors in signal processing. Lower Limit: 0.000% to 100.000% in 0.001% increments Upper Limit: 0.000% to 100.000% in 0.001% increments Limit State: On or Off Avg: 1 to 99
RAN	Displays the Radio Access Number.
Rate	Used to select the rate that data is transmitted. Select: 4800 or 9600 bps
Pattern	Used to set the data or voice pattern. Select: 1031, 0.153 or CAL
Reset Acq	Used to reacquire the input signal.
F1 "Edit" / "Done" / "Enter" / "Save"	<p>Edit Highlights the selected field to be changed or changes the field value if the field only contains two selections.</p> <p>Done Ends the Field Edit and saves the new setting / value.</p> <p>Enter Initiates the selected field.</p> <p>Save Performs a data dump of frames displayed on the screen, including configurations, readings and settings. The data dump is stored in a time-stamped ASCII report and can be retrieved at a later time.</p>
F2 "Resume"	Resume Restores the screen to active mode.
F3 "Hold"	Hold Freezes the screen.
F5 "Return" / "Esc"	<p>Return Closes the Digital Receive Screen and returns to the Test Screen.</p> <p>Esc Ends the Field Edit, but does NOT save any changes to the setting or value.</p>

4-9. dPMR OPTION (35000300)

The dPMR Option (35000300) adds dPMR test protocols to the testing compatibilities of the 3500 / 3500A.

The dPMR Option provides users with the ability to test digital two-way radio systems.

4-9-1. dPMR MINI METER

The dPMR Mini Meter can be added to the Duplex and Transmitter Test Screens.

DUPLIX TEST SETUP												
Modulation Meter	0	DCS Decode	0									
RSSI Meter	0	Audio Level	0									
RF Error Meter	0	Digital Receive	9									
RF Power Meter	0											
SINAD Meter	0											
Distortion Meter	0											
AF Counter	0											
DTMF Decode	0											
<table border="1"> <tr> <td>1</td><td>2</td><td>3</td> </tr> <tr> <td>4</td><td>5</td><td>6</td> </tr> <tr> <td>7</td><td>8</td><td>9</td> </tr> </table>				1	2	3	4	5	6	7	8	9
1	2	3										
4	5	6										
7	8	9										
Edit		Return										

DUPLIX TEST			
Generator	Off	Receiver	More
MH z	40.000000	MH z	40.000000
Port:	T/R	Port:	T/R
Level:	-70 dBm	Mod:	dPMR
Ext Attn dB:	0		
Modulator	dPMR	Digital	
Pattern:	0.153		
Volume:	100	dPMR Demod	More
Squelch:	-50 dBm	Sig Pwr	-1.0
Speaker:	Audio In	Freq Err	-0.1
AudOut:	Audio In	FSK Err	1.1
Save	Recall	Sym Dev	1058
Edit		Return	Hold
		Setup	PTT on

To access the dPMR Mini Meter fields on the Duplex and Transmitter Test Screens:

- Press the ◀ LEFT Key or ▶ RIGHT Key to move the on-screen cursor to the dPMR Demod frame.
- Press the ▲ UP Key or ▼ DOWN Key to move the on-screen cursor to the More field and press the F1 “Enter” Key to display additional dPMR fields.
- Press the ▲ UP Key or ▼ DOWN Key to move the on-screen cursor from one field to another.

To access the Digital Receive Screen for dPMR field settings:

- Press the ◀ LEFT Key or ▶ RIGHT Key to move the on-screen cursor to the dPMR Demod frame.
- Press the F1 “Zoom” Key to display the Digital Receive Screen.

The dPMR Test Pattern field can also be accessed in the modulation frame on the Duplex and Transmitter Test Screens:

DUPLIX TEST			
Generator	Off	Receiver	More
MH z	40.000000	MH z	40.000000
Port:	T/R	Port:	T/R
Level:	-70 dBm	Mod:	dPMR
Ext Attn dB:	0		
Modulator	dPMR	Digital	
Pattern:	0.153		
Volume:	100	dPMR Demod	More
Squelch:	-50 dBm	Sig Pwr	-1.0
Speaker:	Audio In	Freq Err	-0.1
AudOut:	Audio In	FSK Err	1.1
Save	Recall	Sym Dev	1058
Edit		Return	Hold
		Setup	PTT on

4-9-2. dPMR MINI METER FEATURES AND FUNCTIONS

dPMR Demod	<input type="button" value="More"/>
Sig Pwr	-1.0
Freq Err	-0.1
FSK Err	1.1
Sym Dev	1058

dPMR Demod	<input type="button" value="More"/>
BER	0.000
Pattern	0.153
Reset Acq	

SCREEN FEATURE	FUNCTION
Sig Pwr	Displays the RF level at the input connector.
Freq Err	Displays the frequency error of the transmitted signal.
FSK Err	Displays the FSK Error of the transmitted signal.
Sym Dev	Displays the symbol deviation accuracy.
BER	Displays the incoming dPMR symbol data compared to a standard pattern in determining errors in signal processing.
Pattern	Used to set the data or voice pattern. Select: 0.153
Reset Acq	Used to reacquire the input signal.

4-9-3. DIGITAL RECEIVE (dPMR) SCREEN FEATURES AND FUNCTIONS

Digital Receive					
		↓ 41	□ □ □	20	↑ ↑ ↑ 29
DPMR Demod	Reading	Lower Limit	Upper Limit	Limit State	Avg
Freq Error:	0.4 Hz	-800.0	800.0	Off	1
FSK Error:	1.1 %	0.0	100.0	Off	1
Sym Dev:	1058 Hz	0	9999	Off	1
Signal Pwr:	-1.0 dBm	-130.0	60.0	Off	1
BER:	0.000 %	0.000	100.000	Off	1
Pattern:	<input type="text" value="0.153"/>				
Reset Acq					
<input type="button" value="Edit"/>		<input type="button" value="Hold"/>		<input type="button" value="Return"/>	

SCREEN FEATURE	FUNCTION
Freq Error	Used to select the parameters of the frequency error of the transmitted signal. Lower Limit: -800.0 to 800.0 Hz in 0.1 Hz increments Upper Limit: -800.0 to 800.0 Hz in 0.1 Hz increments Limit State: On or Off Avg: 1 to 99
FSK Error	Used to select the parameters of the FSK error of the transmitted signal. Lower Limit: 0.0% to 100.0% in 0.1% increments Upper Limit: 0.0% to 100.0% in 0.1% increments Limit State: On or Off Avg: 1 to 99
Sym Dev	Used to select the parameters of the symbol deviation accuracy. Lower Limit: 0 to 9999 Hz in 1 Hz increments Upper Limit: 0 to 9999 Hz in 1 Hz increments Limit State: On or Off Avg: 1 to 99

4-9-3. DIGITAL RECEIVE (dPMR) SCREEN FEATURES AND FUNCTIONS (cont)

SCREEN FEATURE	FUNCTION
Signal Pwr	Used to select the parameters of the RF level at the input connector. Lower Limit: -130.0 to 60.0 dBm in 0.1 dB increments Upper Limit: -130.0 to 60.0 dBm in 0.1 dB increments Limit State: On or Off Avg: 1 to 99
BER	Used to select the parameters of the incoming dPMR symbol data compared to a standard pattern in determining errors in signal processing. Lower Limit: 0.000% to 100.000% in 0.001% increments Upper Limit: 0.000% to 100.000% in 0.001% increments Limit State: On or Off Avg: 1 to 99
Pattern	Used to set the data or voice pattern. Select: 0.153
Reset Acq	Used to reacquire the input signal.
F1 "Edit" / "Done" / "Enter" / "Save"	<p>Edit Highlights the selected field to be changed or changes the field value if the field only contains two selections.</p> <p>Done Ends the Field Edit and saves the new setting / value.</p> <p>Enter Initiates the selected field.</p> <p>Save Performs a data dump of frames displayed on the screen, including configurations, readings and settings. The data dump is stored in a time-stamped ASCII report and can be retrieved at a later time.</p>
F2 "Resume"	Resume Restores the screen to active mode.
F3 "Hold"	Hold Freezes the screen.
F5 "Return" / "Esc"	<p>Return Closes the Digital Receive Screen and returns to the Test Screen.</p> <p>Esc Ends the Field Edit, but does NOT save any changes to the setting or value.</p>

4-10. ARIBT98 OPTION (35000500)

The ARIBT98 Option (35000500) adds ARIBT98 test protocols to the testing compatibilities of the 3500 / 3500A.

The ARIBT98 Option provides users with the ability to test digital two-way radio systems.

4-10-1. ARIBT98 MINI METER

The ARIBT98 Mini Meter can be added to the Duplex and Transmitter Test Screens.

DUPLX TEST SETUP												
Modulation Meter	0	DCS Decode	0									
RSSI Meter	0	Audio Level	0									
RF Error Meter	0	Digital Receive	9									
RF Power Meter	0											
SINAD Meter	0											
Distortion Meter	0											
AF Counter	0											
DTMF Decode	0											
<table border="1"> <tr> <td>1</td><td>2</td><td>3</td> </tr> <tr> <td>4</td><td>5</td><td>6</td> </tr> <tr> <td>7</td><td>8</td><td>9</td> </tr> </table>				1	2	3	4	5	6	7	8	9
1	2	3										
4	5	6										
7	8	9										
Edit		Return										

DUPLX TEST			
Generator	Off	Receiver	More
MH z	40.000000	MH z	40.000000
Port:	T/R	Port:	T/R
Level:	-70 dBm	Mod:	ARIB
Ext Attn dB:	0		
Modulator	ARIBT98	Digital	
Pattern:	1031		
Volume:	100	ARIB Demod	More
Squelch:	-50 dBm	Sig Pwr	-1.1
Speaker:	Audio In	Freq Err	-3.9
AudOut:	Audio In	FSK Err	1.2
Save	Recall	Sym Dev	948
Edit		Return	Hold
		Setup	PTT on

To access the ARIBT98 Mini Meter fields on the Duplex and Transmitter Test Screens:

- Press the ◀ LEFT Key or ▶ RIGHT Key to move the on-screen cursor to the ARIBT98 Demod frame.
- Press the ▲ UP Key or ▼ DOWN Key to move the on-screen cursor to the More field and press the F1 “Enter” Key to display additional ARIBT98 fields.
- Press the ▲ UP Key or ▼ DOWN Key to move the on-screen cursor from one field to another.

To access the Digital Receive Screen for ARIBT98 field settings:

- Press the ◀ LEFT Key or ▶ RIGHT Key to move the on-screen cursor to the ARIBT98 Demod frame.
- Press the F1 “Zoom” Key to display the Digital Receive Screen.

The ARIBT98 Test Pattern field can also be accessed in the modulation frame on the Duplex and Transmitter Test Screens:

DUPLX TEST			
Generator	Off	Receiver	More
MH z	40.000000	MH z	40.000000
Port:	T/R	Port:	T/R
Level:	-70 dBm	Mod:	ARIB
Ext Attn dB:	0		
Modulator	ARIBT98	Digital	
Pattern:	1031		
Volume:	100	ARIB Demod	More
Squelch:	-50 dBm	Sig Pwr	-1.1
Speaker:	Audio In	Freq Err	-3.9
AudOut:	Audio In	FSK Err	1.2
Save	Recall	Sym Dev	948
Edit		Return	Hold
		Setup	PTT on

4-10-2. ARIBT98 MINI METER FEATURES AND FUNCTIONS

ARIB Demod	<input type="button" value="More"/>
Sig Pwr	-1.1
Freq Err	-3.9
FSK Err	1.2
Sym Dev	948

ARIB Demod	<input type="button" value="More"/>
BER	0.000
Pattern	1031
Reset Acq	

SCREEN FEATURE	FUNCTION
Sig Pwr	Displays the RF level at the input connector.
Freq Err	Displays the frequency error of the transmitted signal.
FSK Err	Displays the FSK Error of the transmitted signal.
Sym Dev	Displays the symbol deviation accuracy.
BER	Displays the incoming ARIBT98 symbol data compared to a standard pattern in determining errors in signal processing.
Pattern	Used to set the data or voice pattern. Select: 1031, 0.153 or CAL
Reset Acq	Used to reacquire the input signal.

4-10-3. DIGITAL RECEIVE (ARIBT98) SCREEN FEATURES AND FUNCTIONS

Digital Receive					
		↓ 41	□ □ □	20	↑ ↑ ↑ 29
ARIB Demod	Reading	Lower Limit	Upper Limit	Limit State	Avg
Freq Error:	-3.9 Hz	-800.0	800.0	Off	1
FSK Error:	1.2 %	0.0	100.0	Off	1
Sym Dev:	948 Hz	0	9999	Off	1
Signal Pwr:	-1.2 dBm	-130.0	60.0	Off	1
BER:	0.000 %	0.000	100.000	Off	1
Pattern:	1031				
Reset Acq					
Edit		Hold		Return	

SCREEN FEATURE	FUNCTION
Freq Error	Used to select the parameters of the frequency error of the transmitted signal. Lower Limit: -800.0 to 800.0 Hz in 0.1 Hz increments Upper Limit: -800.0 to 800.0 Hz in 0.1 Hz increments Limit State: On or Off Avg: 1 to 99
FSK Error	Used to select the parameters of the FSK error of the transmitted signal. Lower Limit: 0.0% to 100.0% in 0.1% increments Upper Limit: 0.0% to 100.0% in 0.1% increments Limit State: On or Off Avg: 1 to 99
Sym Dev	Used to select the parameters of the symbol deviation accuracy. Lower Limit: 0 to 9999 Hz in 1 Hz increments Upper Limit: 0 to 9999 Hz in 1 Hz increments Limit State: On or Off Avg: 1 to 99

4-10-3. DIGITAL RECEIVE (ARIBT98) SCREEN FEATURES AND FUNCTIONS (cont)

SCREEN FEATURE	FUNCTION
Signal Pwr	Used to select the parameters of the RF level at the input connector. Lower Limit: -130.0 to 60.0 dBm in 0.1 dB increments Upper Limit: -130.0 to 60.0 dBm in 0.1 dB increments Limit State: On or Off Avg: 1 to 99
BER	Used to select the parameters of the incoming ARIBT98 symbol data compared to a standard pattern in determining errors in signal processing. Lower Limit: 0.000% to 100.000% in 0.001% increments Upper Limit: 0.000% to 100.000% in 0.001% increments Limit State: On or Off Avg: 1 to 99
Pattern	Used to set the data or voice pattern. Select: 1031, 0.153 or CAL
Reset Acq	Used to reacquire the input signal.
F1 "Edit" / "Done" / "Enter" / "Save"	<p>Edit Highlights the selected field to be changed or changes the field value if the field only contains two selections.</p> <p>Done Ends the Field Edit and saves the new setting / value.</p> <p>Enter Initiates the selected field.</p> <p>Save Performs a data dump of frames displayed on the screen, including configurations, readings and settings. The data dump is stored in a time-stamped ASCII report and can be retrieved at a later time.</p>
F2 "Resume"	Resume Restores the screen to active mode.
F3 "Hold"	Hold Freezes the screen.
F5 "Return" / "Esc"	<p>Return Closes the Digital Receive Screen and returns to the Test Screen.</p> <p>Esc Ends the Field Edit, but does NOT save any changes to the setting or value.</p>

4-11. SCRIPTING OPTION (35000060)

The Scripting Option (35000060) adds Scripting to the testing compatibilities of the 3500 / 3500A. Scripting provides users with the ability to create and define test scripts.

4-11-1. SCRIPTS SCREEN

Refer to Appendix C for the 3500 / 3500A RCI commands.

When the Scripting Option is installed, the F1 “Scripts” Key is displayed on the System Menu, Meters Menu, Self Test Menu and Utilities Menu. Press the F1 “Scripts” Key to display the Scripts Screen.

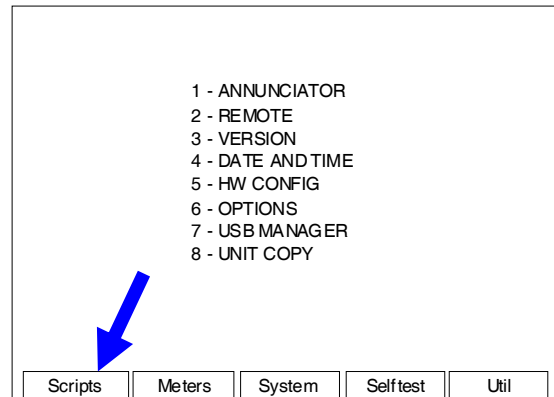
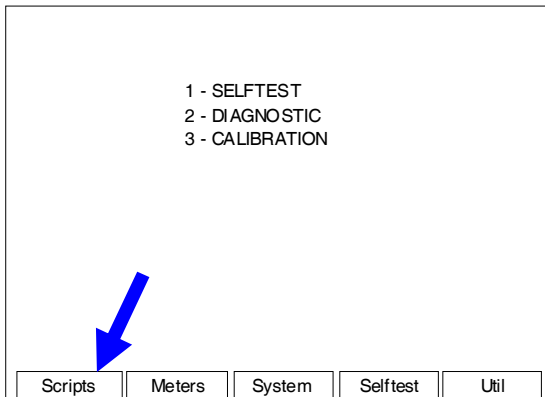
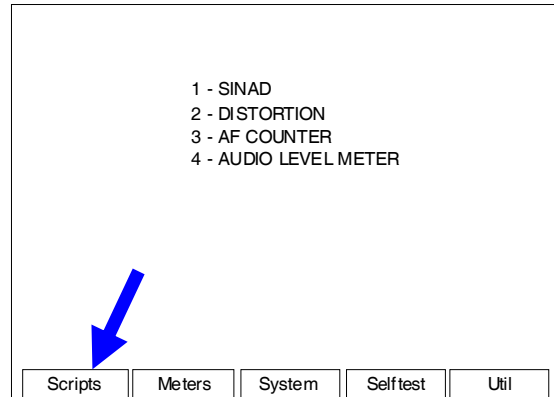
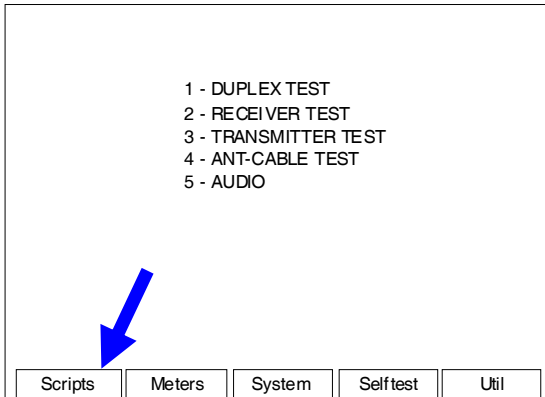

4-11-2. SCRIPTS SCREEN FEATURES AND FUNCTIONS

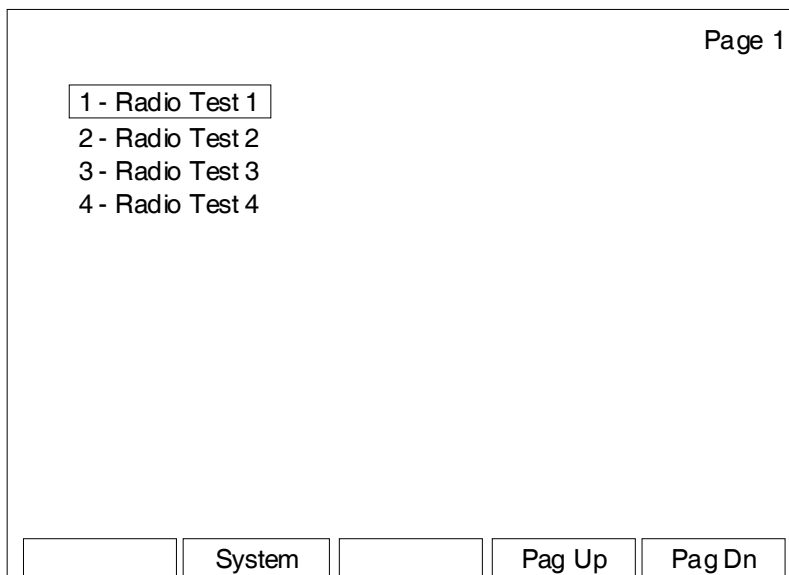

(Sample Scripts shown for display purposes only.)

SCREEN FEATURE	FUNCTION
Scripts	Displays the Scripts stored in the 3500 / 3500A. Order of Scripts and Scripts Names are defined by the user.
F2 "System"	Displays the System Menu (para 2-2-2).
F4 "Pag Up"	Displays the previous screen of Scripts if more than nine Scripts are loaded into the 3500 / 3500A.
F5 "Pag Dn"	Displays the next screen of Scripts if more than nine Scripts are loaded into the 3500 / 3500A.

4-11-3. TRANSFER SCRIPTS TO THE 3500 / 3500A

1. Attach the Comm Breakout Box to the REMOTE Connector.
2. Connect USB Cable between the PC and the 3500 / 3500A USB Connector on the Comm Breakout Box.
3. Access the TelNet server on the PC.
4. Configure the 3500 / 3500A Remote Screen to match the remote settings of the PC.

REMOTE ↓ 41 □ □ □ □ 20 ↑ ↑ ↑ 29 □ △

Config Port: **ETHERNET**

IP: 10 10 10 193

Subnet Mask: 255 0 0 0

Gateway: 0 0 0 0

Ethernet Port: 9991

Ethernet Type: STANDARD

Port Currently Active: USB

Buttons: Edit Return [] [] Config

5. Set the Port Currently Active field to USB and the Ethernet Type field to DEV to allow for interactive development with the Scripting language.

REMOTE ↓ 41 □ □ □ □ 20 ↑ ↑ ↑ 29 □ △

Config Port: **ETHERNET**

IP: 10 10 10 193

Subnet Mask: 255 0 0 0

Gateway: 0 0 0 0

Ethernet Port: 9991

Ethernet Type: **DEV**

Port Currently Active: **USB**

Buttons: Edit Return [] [] Config

Note: Blue arrows point to the 'DEV' value in the Ethernet Type field and the 'USB' value in the Port Currently Active field.

4-11-3. TRANSFER SCRIPTS TO THE 3500 / 3500A (cont)

6. On the USB-Manager Screen, Scripts can be saved and recalled to/from the USB Memory Device.

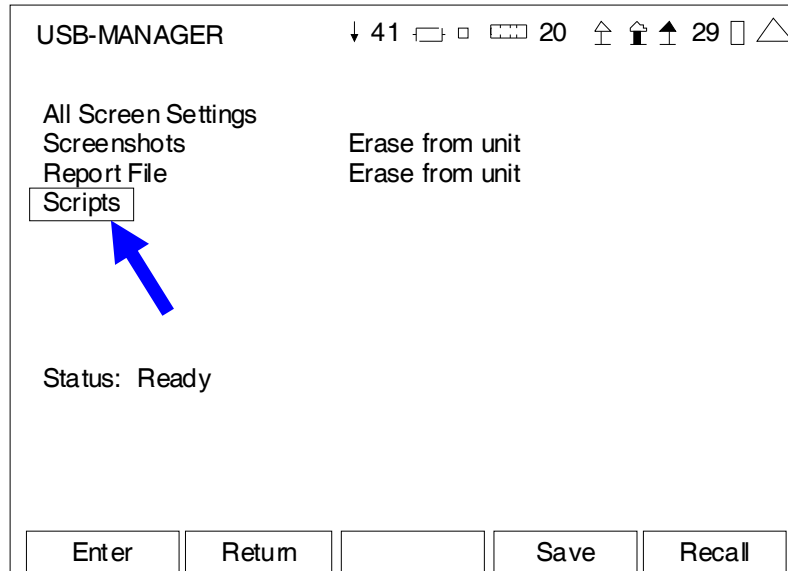

4-11-4. COPY SCRIPTS WITH UNIT COPY SCREEN

When the Unit Copy Screen is displayed, two selections are available for copying Scripts into the cloned unit:

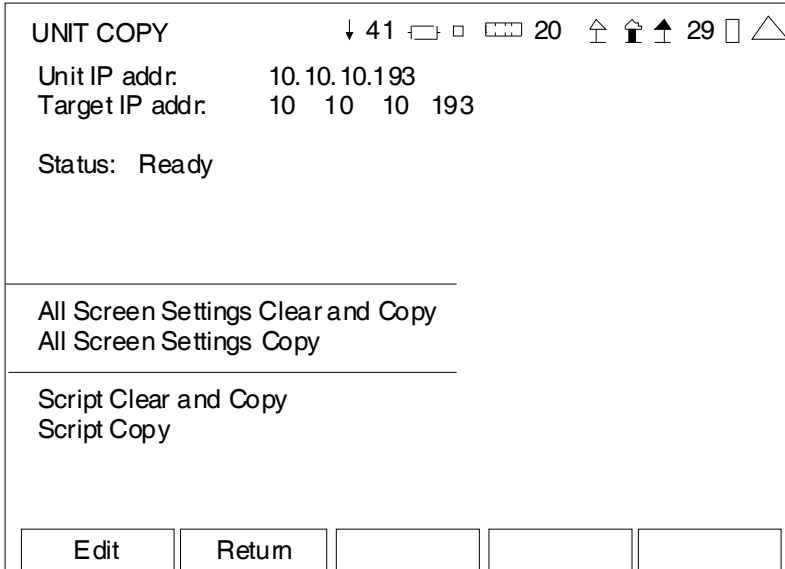

SCREEN FEATURE	FUNCTION
Script Clear and Copy	Used to copy all the Script files to the cloned unit after all the Script files have been deleted from the cloned unit.
Script Copy	Used to copy all the Script files to the cloned unit.

4-11-5. GENERAL SCRIPTING COMMANDS

In Scripting, all RCI commands start with a ":" (colon). There are a few special commands that start with a "*" (star). In addition, all Lua commands must end with a ";" (semicolon) when writing scripts.

COMMAND	DESCRIPTION
:scripting:dialog:create	Opens a dialog box. Old screen data is not saved so when the dialog box is closed, the script must ensure the dialog box is set to a valid screen. The screen may also need to be set to defaults before the screen is displayed properly.
:scripting:dialog:close	Closes a previously opened dialog box.
:scripting:softkey:label < 1 to 5 >, "string"	Prints the described quoted string in the desired soft key position.
:scripting:softkey:clear	Blanks all soft key positions.
:scripting:log:print "string"	Provides a way to print diagnostic messages to the console via PPC RS-232. The PPC RS-232 uses a fixed setting of 115200N81.
:scripting:screen:print X_VAL,Y_VAL, "string"	Prints the given string to the given x,y coordinates on the dialog box.
:scripting:screen	Returns to the Scripts Screen.
:scripting:exit	Signals the end of a running script so that other scripts may then be run. This command does not automatically return the user to the Scripts Screen.
:scripting:event:enable < 1 - 5 > "Lua command"	Sets the event for the given soft key to be the given Lua command. The command can be any available scripting or Lua command.
:scripting:event:idle	Provides a waiting mechanism so the script blocks waiting for some user keypad action. When this command completes, the dialog block, if open, closes.
:scripting:sleep <ms>	Causes the script interpreter to pause for the supplied number of milliseconds (ms). For time >1 minute, the sleep is truncated to 1 minute.
:scripting:alarm <ms>	Causes the 3500 / 3500A enunciator to sound for 0 to 1000 milliseconds (ms).
:scripting:entry:idle xpos, ypos, size	Create a box on a dialog screen for the user to input data and creates two soft keys ("ESC" and "DONE"). "ESC" returns an empty string. "DONE" returns the inputted data. Size is the number of characters to be read (1 to 16). The xpos and ypos are screen coordinates that denotes the top left corner of the entry box.
:scripting:meter:clear "RCI screen command"	Causes the script to fill the find screen path and resets the custom.ini file. Example: screen_transmitter_test

4-11-6. SCRIPTING FLOWCHARTS

AUDIO

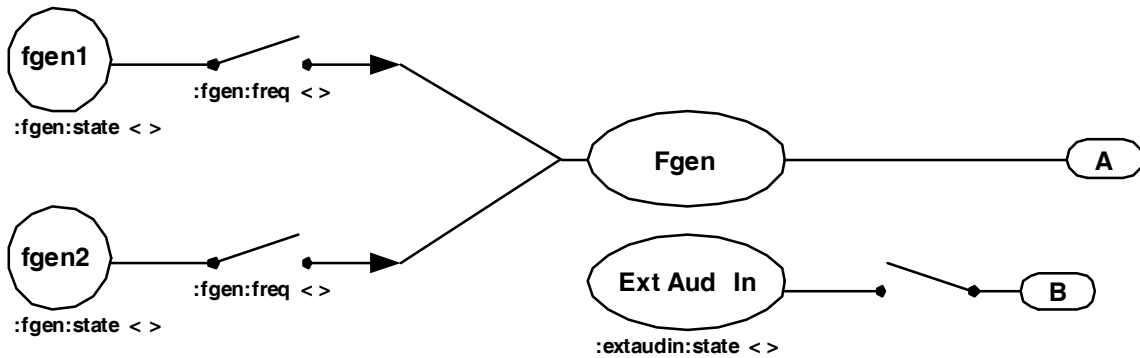
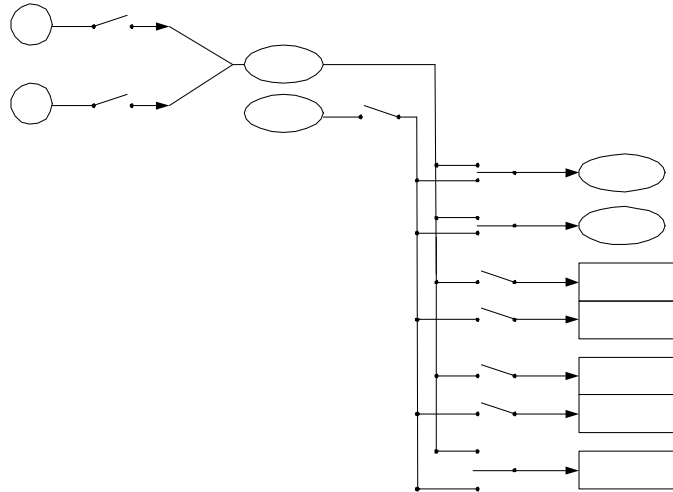

4-11-6. SCRIPTING FLOWCHARTS (cont)

AUDIO (cont)

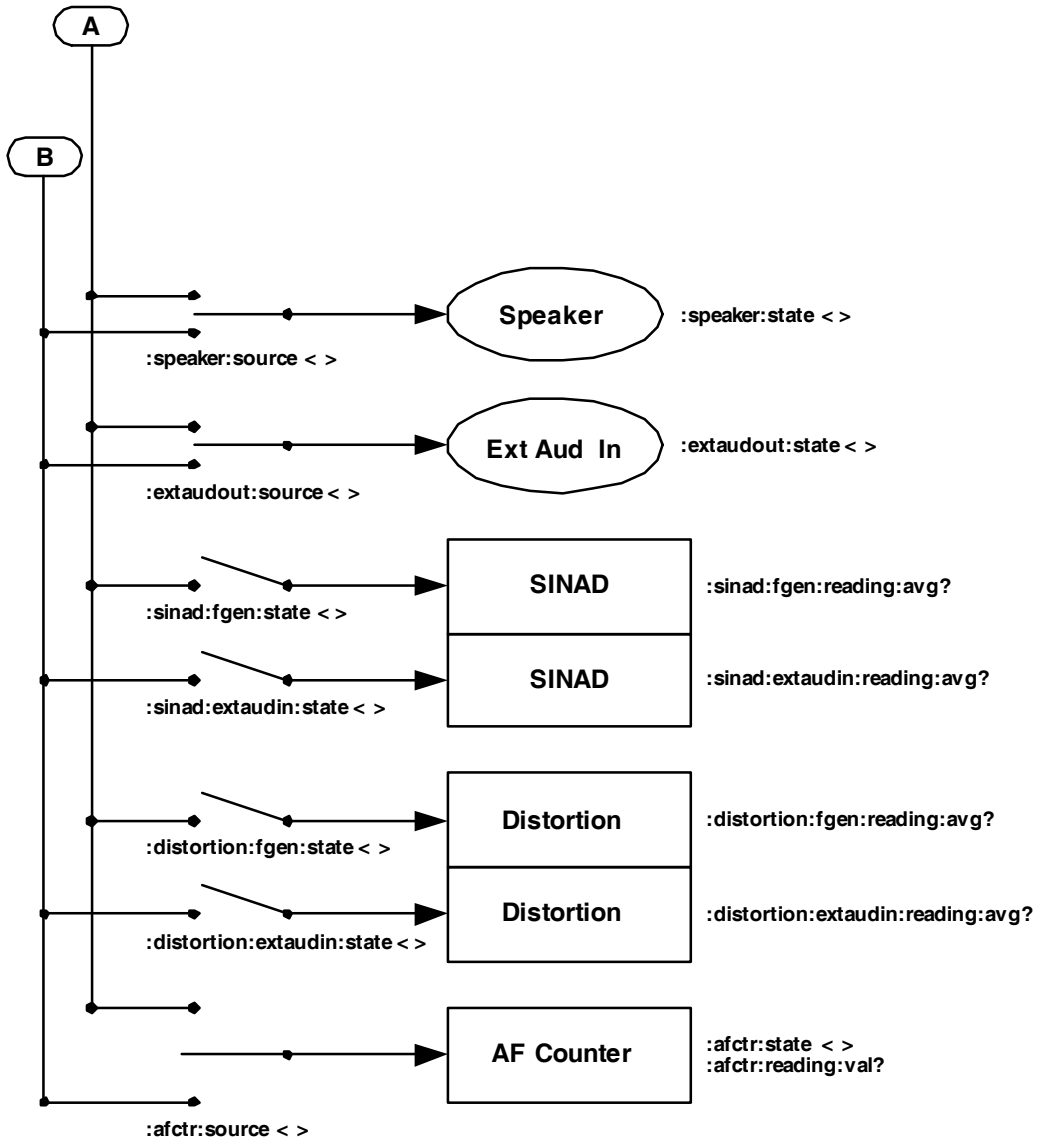

4-11-6. SCRIPTING FLOWCHARTS (cont)

RECEIVER

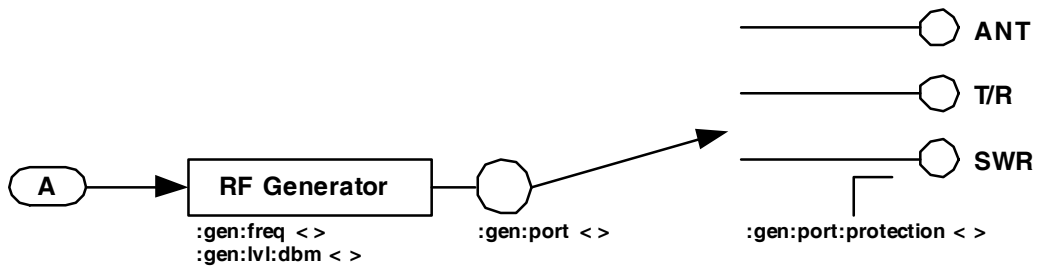
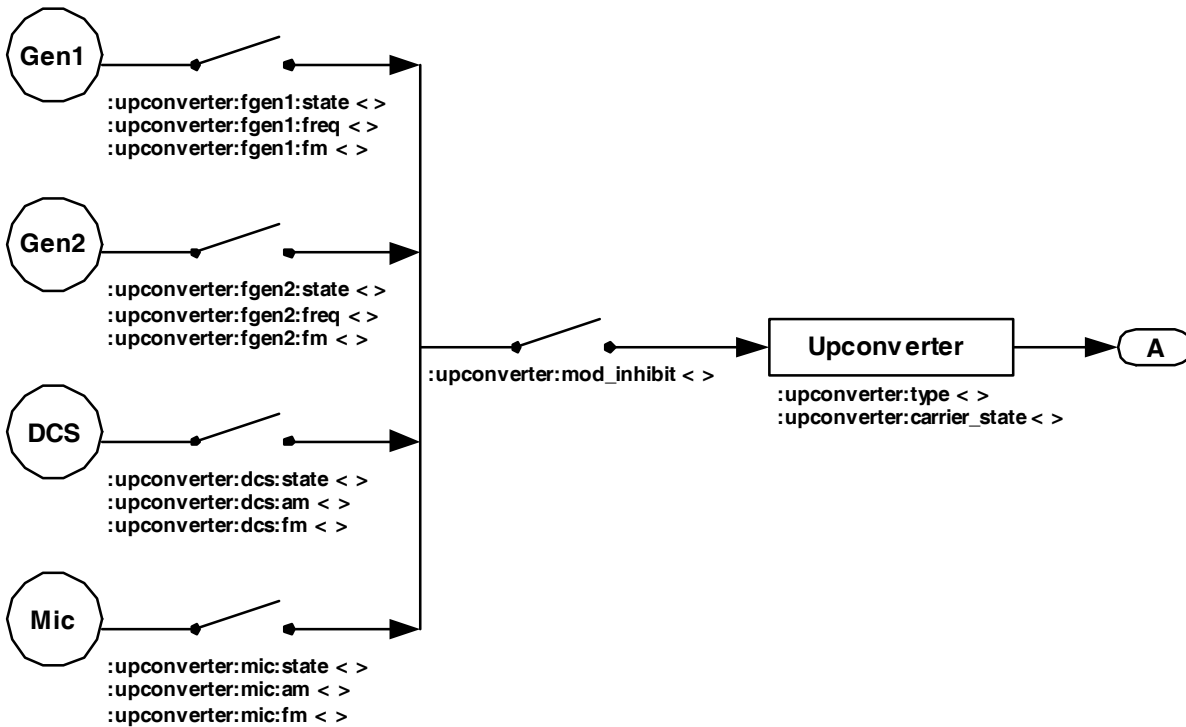
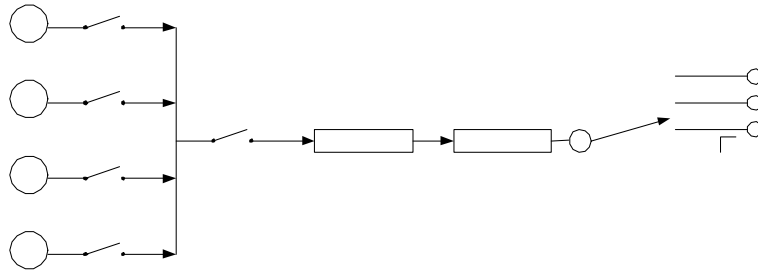

4-11-6. SCRIPTING FLOWCHARTS (cont)

TRANSMITTER

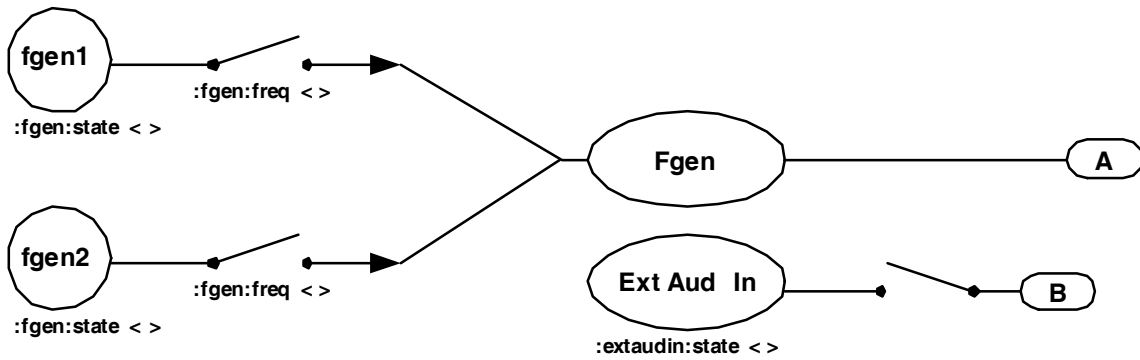
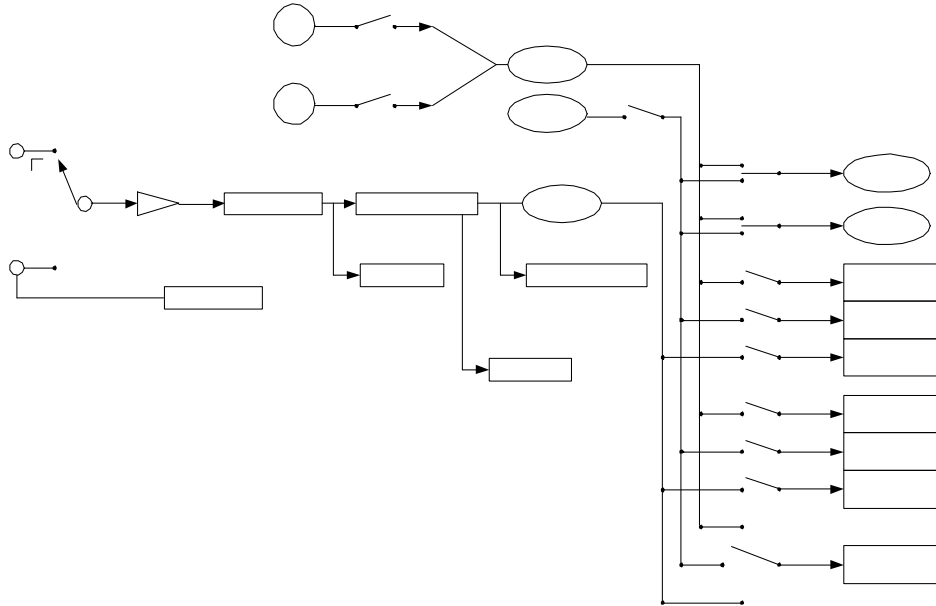

4-11-6. SCRIPTING FLOWCHARTS (cont)

TRANSMITTER (cont)

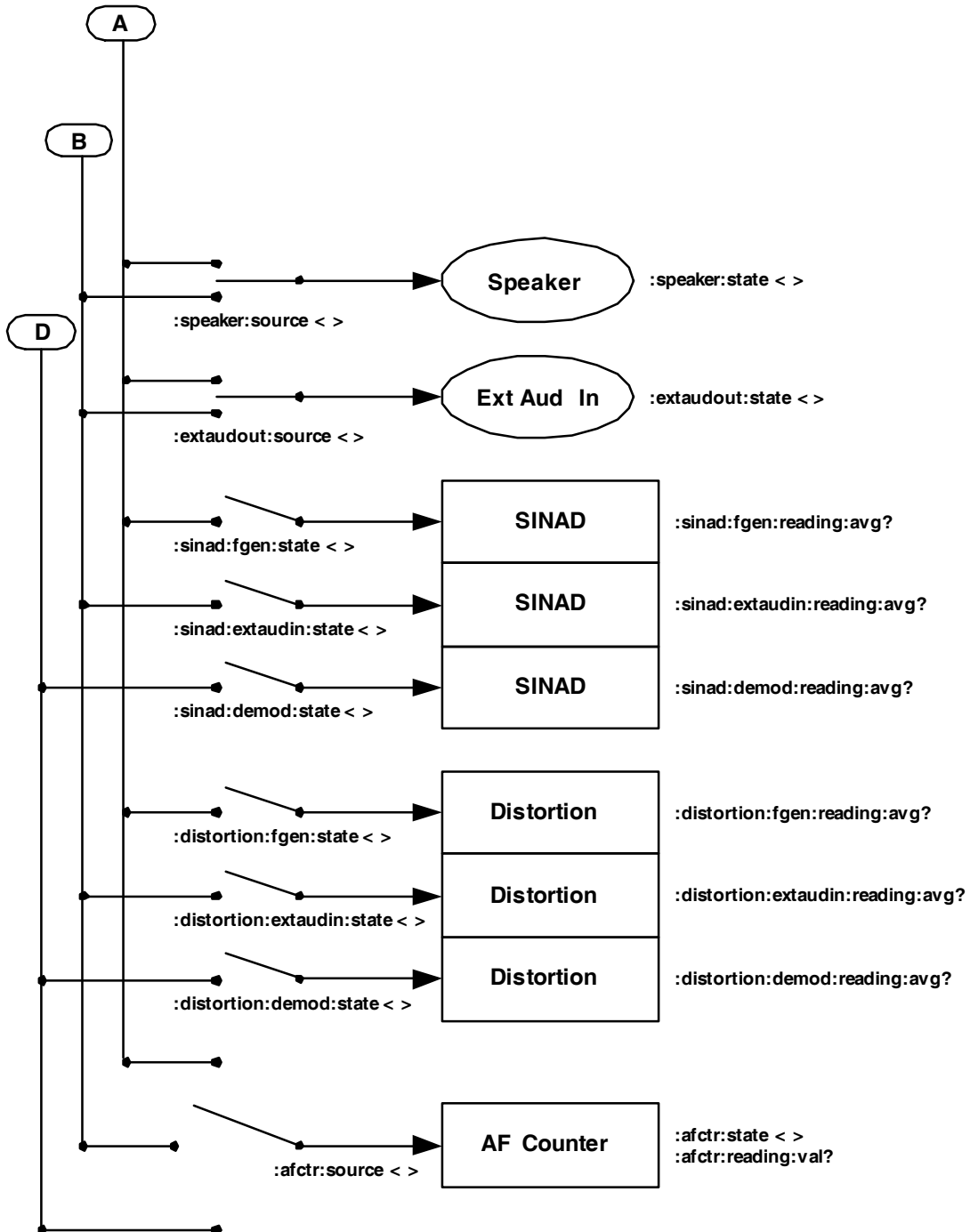

4-11-6. SCRIPTING FLOWCHARTS (cont)

TRANSMITTER (cont)

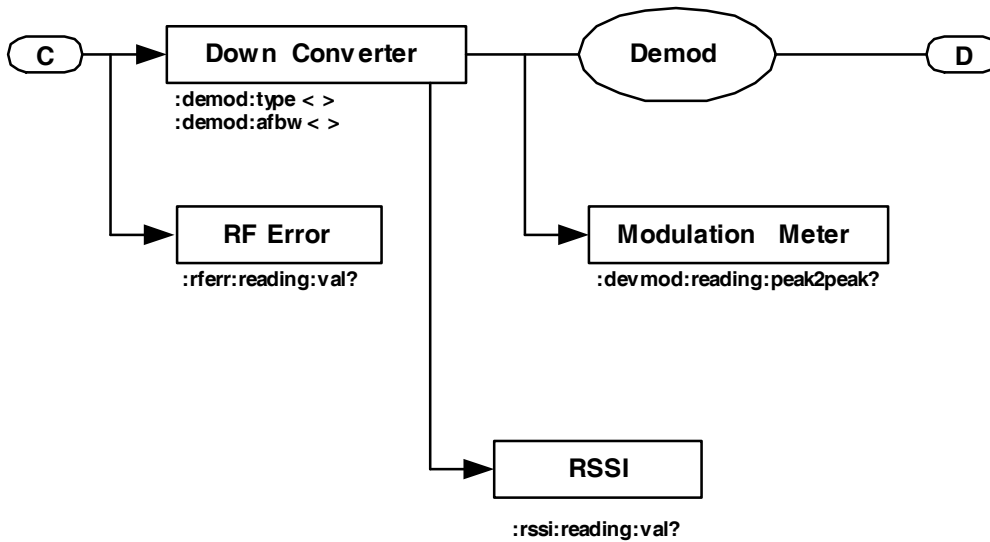
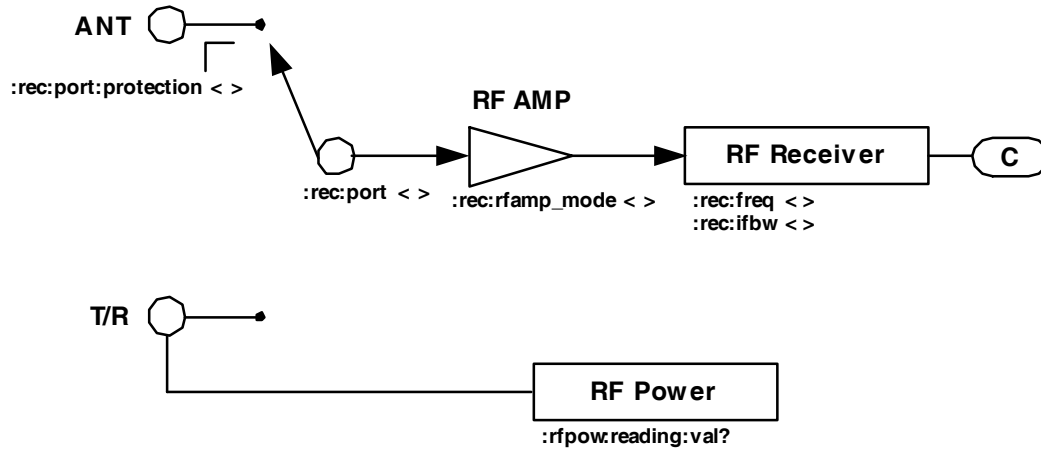

APPENDIX A - CONNECTOR PIN-OUT TABLES

A-1. I/O CONNECTORS

3500

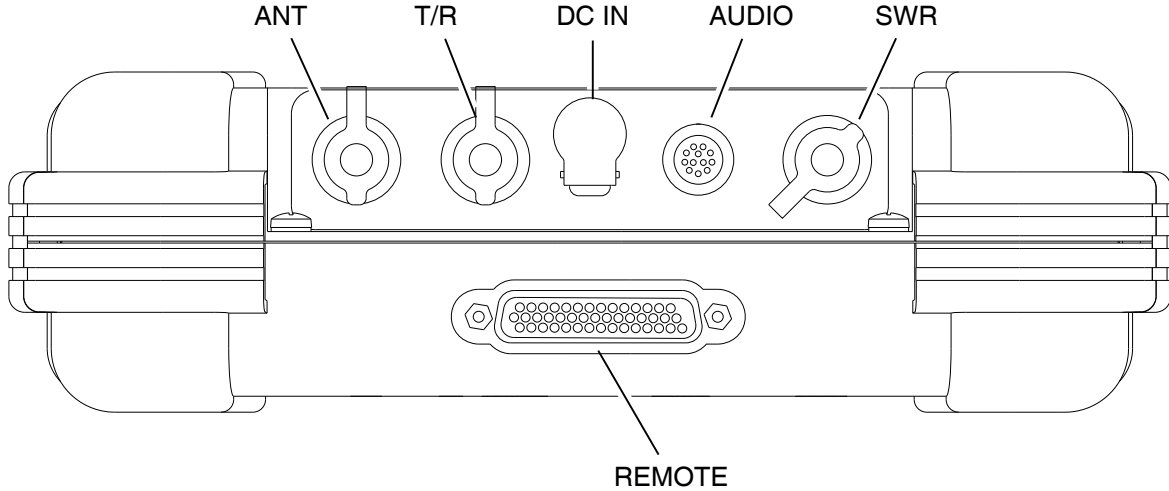

062-005

CONNECTOR	TYPE	SIGNAL TYPE	INPUT/OUTPUT
ANT	TNC Female		INPUT/OUTPUT
T/R	TNC Female		INPUT/OUTPUT
SWR	TNC Female		OUTPUT
DC IN	2.5 mm CIRCULAR (2.5 mm center, 5.5 mm outer diameter, center positive)		INPUT
AUDIO	12-Pin CIRCULAR Female	MIXED	INPUT/OUTPUT
	Refer to Appendix A, Table 3 for 3500 AUDIO Connector description		
REMOTE	44-Pin D-SUB Female	MIXED	INPUT/OUTPUT
	Refer to Appendix A, Table 5 for 3500 REMOTE Connector description		

Table A-1. 3500 I/O Connectors

A-1. I/O CONNECTORS (cont)

3500A

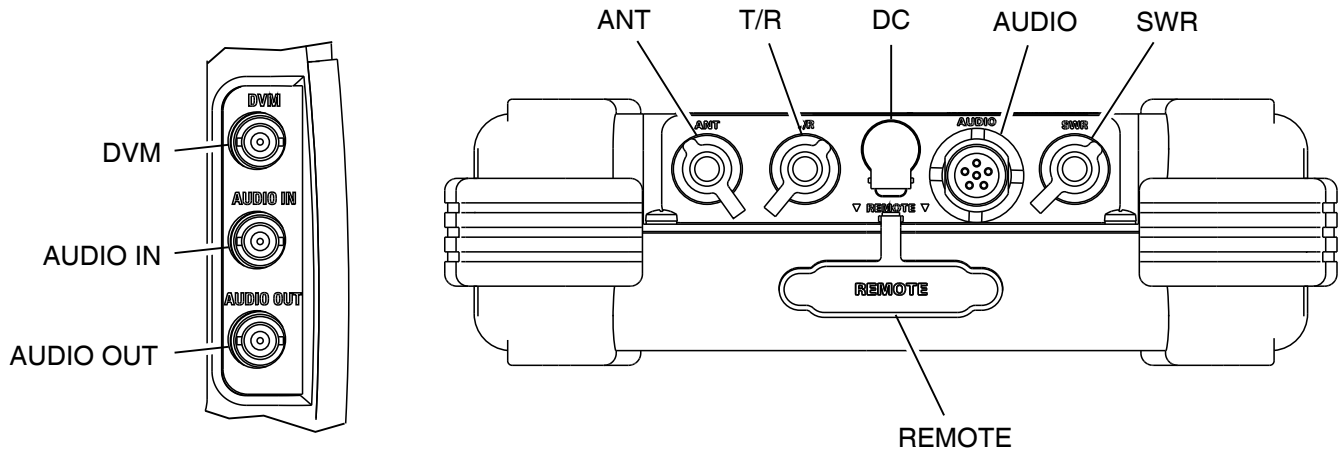

062-005

CONNECTOR	TYPE	SIGNAL TYPE	INPUT/OUTPUT
ANT	TNC Female		INPUT/OUTPUT
T/R	TNC Female		INPUT/OUTPUT
SWR	TNC Female		OUTPUT
DC IN	2.5 mm CIRCULAR (2.5 mm center, 5.5 mm outer diameter, center positive)		INPUT
AUDIO	6-Pin CIRCULAR Female	MIXED	INPUT/OUTPUT
	Refer to Appendix A, Table 4 for 3500A AUDIO Connector description		
REMOTE	44-Pin D-SUB Female	MIXED	INPUT/OUTPUT
	Refer to Appendix A, Table 6 for 3500A REMOTE Connector description		
DVM	BNC Female		INPUT
AUDIO IN	BNC Female		INPUT
AUDIO OUT	BNC Female		OUTPUT

Table A-2. 3500A I/O Connectors

A-2. AUDIO CONNECTOR PIN-OUT TABLE

3500

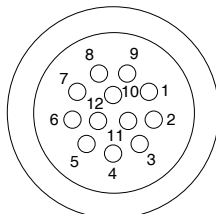

062-004

PIN NO.	SIGNAL NAME
1	PTT
2	AMP_SW
3	MIC
4	GND
5	AUDIO_IN
6	GND
7	DVM+
8	DVM-
9	AUDIO_OUT
10	GND
11	SPKR+
12	SPKR-

Table A-3. 3500 AUDIO Connector Pin-Out Table

A-2. AUDIO CONNECTOR PIN-OUT TABLE (cont)

3500A

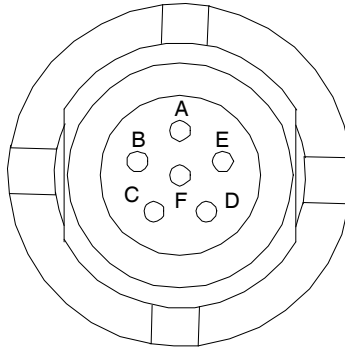

PIN NO.	SIGNAL NAME
A	GND
B	SPEAKER+
C	PTT
D	MIC
E	MICSEL1
F	MICSEL2

Table A-4. 3500A AUDIO Connector Pin-Out Table

A-3. REMOTE CONNECTOR PIN-OUT TABLE

3500

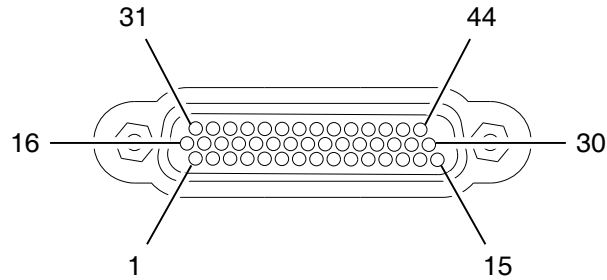

062-003

PIN NO.	SIGNAL NAME	PIN NO.	SIGNAL NAME
1	VBUS_DN1	23	GND
2	GND_DN1	24	CF_ETD+
3	VBUS_UP	25	GND
4	GND_UP	26	PPC_CTS
5	GND	27	PPC_TXD
6	CF0RTS	28	A2
7	GND	29	REM_OUT2
8	CF_ERX-	30	REM_OUT4
9	CF_ETD-	31	VBUS_DN1
10	GND	32	GND_DN1
11	PPC_RTS	33	VBUS_UP
12	PPC_RXD	34	GND_UP
13	B1	35	GND
14	A4	36	CF0RX
15	REM_OUT3	37	GND
16	H_D-	38	CF_ERX+
17	H_D+	39	GND
18	D_D-	40	A1
19	D_D+	41	REM_OUT1
20	GND	42	AUDIOOUTFLEXBUFFER
21	CF0TX	43	AUDIOINFLEXBUFFER
22	CF0CTS	44	GND

Table A-5. 3500 REMOTE Connector Pin-Out Table

A-3. REMOTE CONNECTOR PIN-OUT TABLE (cont)

3500A

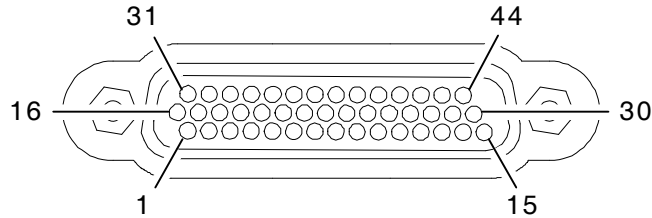

PIN NO.	SIGNALNAME	PIN NO.	SIGNALNAME
1	VBUS_DN1	23	GND
2	GND_DN1	24	CF_ETD+
3	+5 Vdc	25	GND
4	J-TAGSENSE	26	PPC_CTS
5	GND	27	PPC_TXD
6	CF0RTS	28	REM_IN2
7	GND	29	REM_OUT2
8	CF_ERX-	30	REM_OUT4
9	CF_ETD-	31	VBUS_DN1
10	GND	32	GND_DN1
11	PPC_RTS	33	+5 Vdc
12	PPC_RXD	34	J-TAGSENSE
13	REM_IN4	35	GND
14	REM_IN3	36	CF0RX
15	REM_OUT3	37	GND
16	H_D-	38	CF_ERX+
17	H_D+	39	GND
18	TNS	40	REM_IN1
19	TCK	41	REM_OUT1
20	GND	42	TDO
21	CF0TX	43	TDI
22	CF0CTS	44	GND

Table A-6. 3500A REMOTE Connector Pin-Out Table

APPENDIX B - ABBREVIATIONS

A			
A	Amperes	Gen	Generate
AC	Alternating Current	GHz	Gigahertz (10 ⁹ Hertz)
AF	Audio Frequency	H	
AFBW	Audio Frequency Bandwidth		
AM	Amplitude Modulation	H	Hour
ANT	Antenna	HI	High
Assy	Assembly	HP	High-Pass
ATTN	Attenuation	Hr	Hour
Aud	Audio	HW	Hardware
		Hz	Hertz
B			
Bat	Battery	I	
Batt	Battery	ID	Identification
BER	Bit Error Rate	i.e.,	That is ...
BNC	Bayonet Neill-Concelman	IF	Intermediate Frequency
BP	Bandpass	IN	Input or Inch
BW	Bandwidth	In/lbs.	Inch/Pounds
		I/O	Input/Output
C			
C	Celsius or Centigrade	K	
CAL	Calibrate/Calibration		
CD	Compact Disk (CD-ROM)	kHz	Kilohertz (10 ³ Hertz)
CFM	Coldfire Firmware	L	
Config	Configure/Configuration		
CPLD	Complex Processing Logic Device	LCD	Liquid Crystal Display
		LO	Low
CW	Continuous Wave	LP	Low-Pass
		Lvl	Level
D			
D	Day	M	
dB	Decibel	M, m	Month, Meters, Minutes or Male
dBc	Decibels below Carrier	MFIO	Multi-Function I/O
dBm	Decibels above one Milliwatt	MHz	Megahertz (10 ⁶ Hertz)
DC	Direct Current	MIC	Microphone
DCS	Digitally Coded Squelch	MIN, min	Minimum or Minutes
Demod	Demodulation	mm	Millimeter (10 ⁻³ Meters)
DEV	Deviation	MOD	Modulation
DIST	Distortion	N	
DTF	Distance to Fault	N/A	Not Applicable
DVM	Digital Voltmeter	NORM	Normal or Normalize
E			
e.g.	For Example ...	O	
EMC	Electromagnetic Compatibility		
EMI	Electromagnetic Interference	OUT	Output
Err	Error	Ovr	Overload
ESC	Escape	P	
Est	Estimated		
F			
F	Female	para	Paragraph
FH	Frequency Hop	PC	Printed Circuit
Fgen	Function Generator	PCB	Printed Circuit Board
FM	Frequency Modulation	PPC	PowerPC
FPGA	Field Programmable Gate Array	ppm	Parts per Million
FREQ	Frequency	PTT	Push to Talk
		Pwr	Power

R

REC Receive
RF Radio Frequency
RSSI Received Signal Strength
Indication
RX Receive

S

SWR Standing Wave Ratio

T

TDM Time-Division Multiplexing
Tem Temperature
Temp Temperature
TNC Threaded Neill-Concelman
T/R Transmit/Receive
TX Transmit

U

USB Universal Serial Bus
UUT Unit Under Test

V

V Volt
VAC Volts, Alternating Current
Vdc Volts, Direct Current
VHF Very High Frequency
Vol Volume
Vp Volta Peak
Vrms Volts Root Mean Square
VSWR Voltage Standing Wave Ratio

W

W Watt

Y

Y Year

APPENDIX C - REMOTE OPERATION

C-1. GENERAL

The 3500 / 3500A can be controlled through a serial interface.

All commands and data are printable ASCII characters.

Commands can be entered in lowercase, uppercase or a combination of uppercase and lowercase letters.

All commands must be terminated in some manner. The commands that are written to the 3500 / 3500A must be terminated with a Carriage Return/Line Feed and EOI asserted on the last byte.

C-2. REMOTE OPERATION CONNECTION

Connect the Breakout Box (REMOTE Connector) to the 3500 / 3500A REMOTE Connector.

The Breakout Box allows connection to an Ethernet or RS-232 external source.

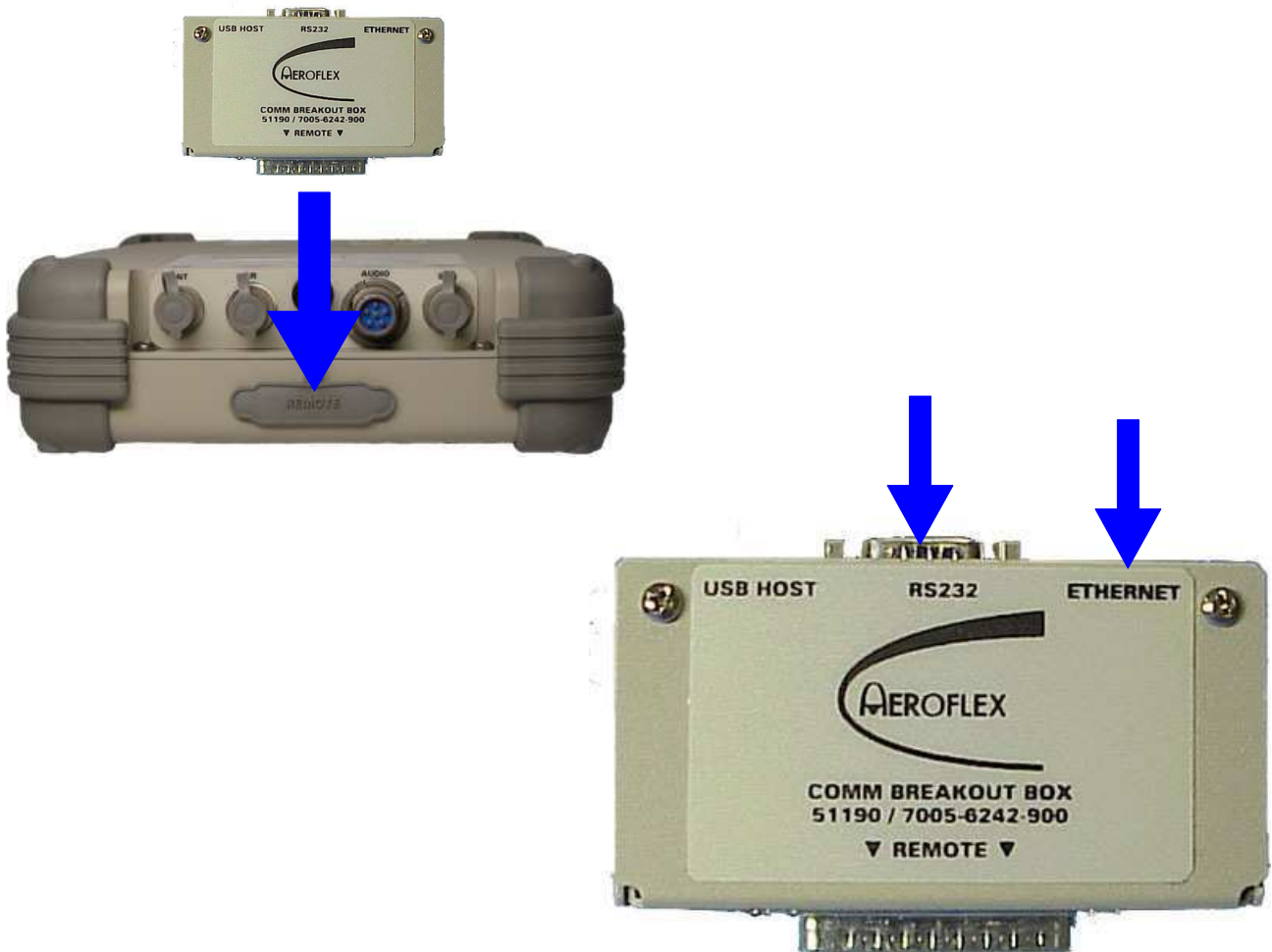

C-3. REMOTE OPERATION CONFIGURATION

The 3500 / 3500A can be configured for remote operation using an Ethernet or RS-232 connection. Both configurations require the Breakout Box is installed on the 3500 / 3500A (para C-2) and a PC is installed utilizing the proper cables.

C-3-1. CONFIGURATION FOR ETHERNET

This is an example configuration for a static address on the PC utilizing two Ethernet cables and a Fast Ethernet Switch.

1. On the PC, select the Internet Protocol (TCP/IP). Select 'Properties.'

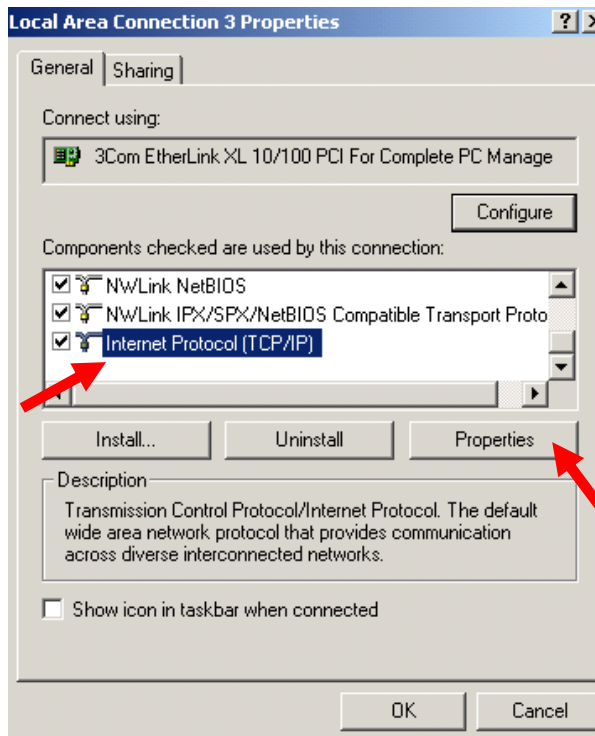

C-3-1. CONFIGURATION FOR ETHERNET (cont)

2. Select 'Use the following IP address' and set the IP Address to " 10 10 10 1 " and the Subnet Mask to " 255 255 255 0." Select "OK."

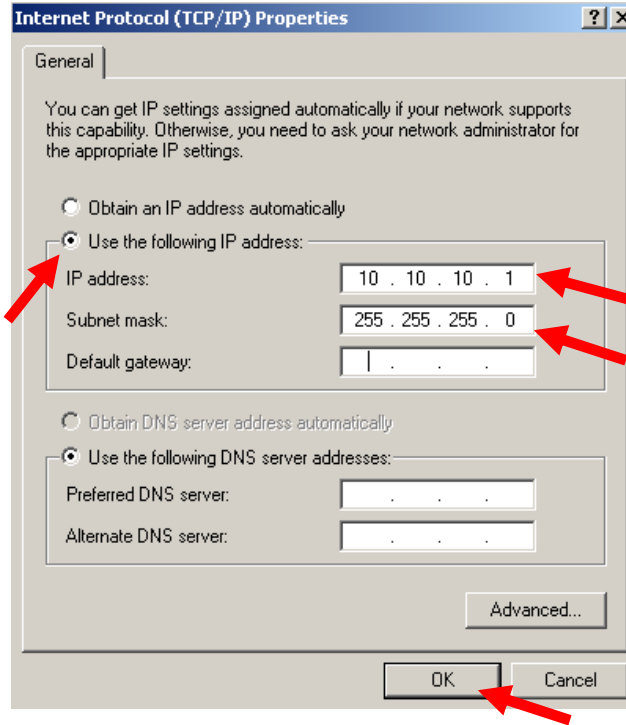

3. Connect one Ethernet Cable to the Fast Ethernet Switch (Connector 1) and to the Ethernet Connector on the Breakout Box. Connect the other Ethernet Cable to the Fast Ethernet Switch (Connector 2) and to the Ethernet Connector on the PC.

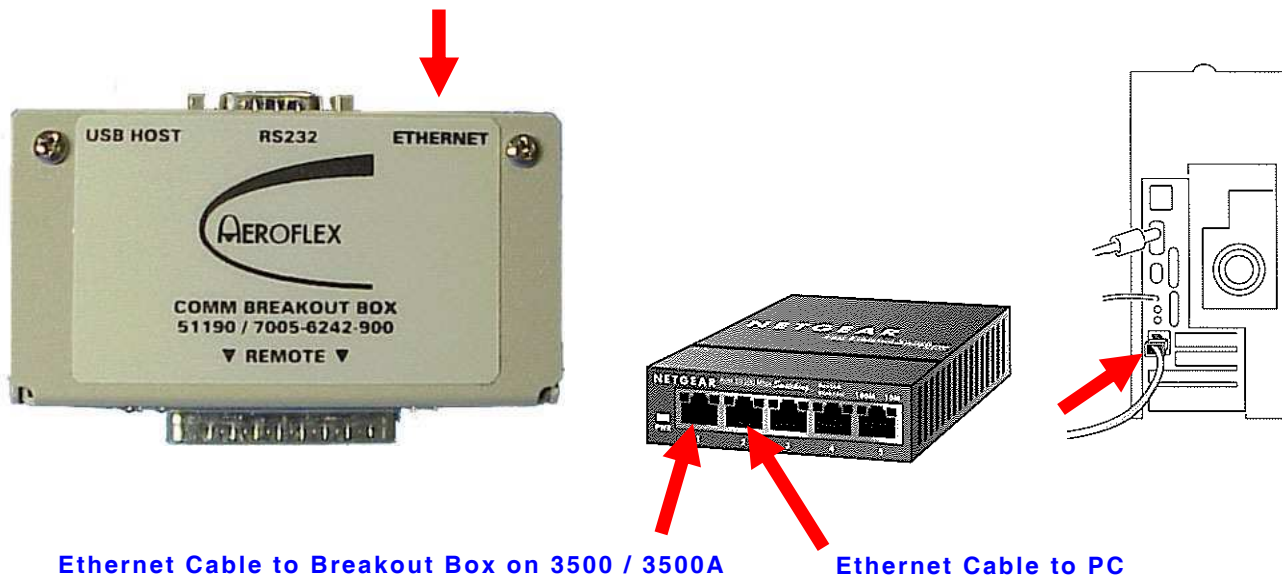

C-3-1. CONFIGURATION FOR ETHERNET (cont)

4. Access the 3500 / 3500A Remote Setup Screen and select the Ethernet selection. (Refer to para 2-2-7A for the Remote Setup Screen Field settings.)

Set the IP (Address) to “ 10 10 10 193 ” and the Subnet Mask to “ 255 255 255 0.” Ensure the ‘Port Currently Active’ field is set to “Ethernet.” Press the “Config” F5 Key to re-establish the 3500 / 3500A to the new screen settings.

REMOTE

↓ 41 □ □ □ 20 ↑ ↑ ↑ 29 □ □ △

Config Port: **ETHERNET**

IP: 10 10 10 193

Subnet Mask: 255 255 255 0

Gateway: 0 0 0 0

Ethernet Port: 9991

Ethernet Type: STANDARD

Port Currently Active: **ETHERNET**

Edit Return Config

5. Open the ‘Command Shell’ on the PC and ping the IP address of the PC (10 10 10 1) to test the connection. Ping the IP address of the 3500 / 3500A (10 10 10 193) to test the connection.
6. Open remote program (PuTTY) and set the IP Address to “ 10 10 10 193 ” Select ‘Terminal.’

PuTTY Configuration

Category:

- Session
- Logging
- Terminal**
- Keyboard
- Bell
- Features
- Window
- Appearance
- Behaviour
- Translation
- Selection
- Colours
- Connection
- Data
- Proxy
- Telnet
- Rlogin
- SSH
- Kex
- Auth
- X11
- Tunnels

Basic options for your PuTTY session

Specify your connection by host name or IP address

Host Name (or IP address): 10.200.121.111 Port: 9991

Protocol: Raw Telnet Rlogin SSH

Load, save or delete a stored session

Saved Sessions:

- HITS 111
- Default Settings
- HITS 111

Load Save Delete

Close window on exit: Always Never Only on clean exit

About Help Open Cancel

C-3-1. CONFIGURATION FOR ETHERNET (cont)

7. Set the fields as shown and select "Open."

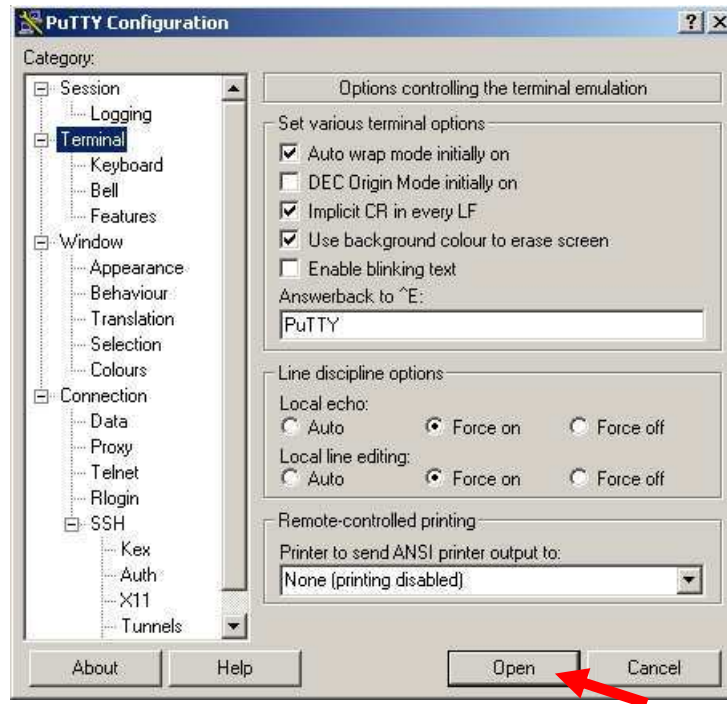

8. The Remote Window is displayed on the PC. Remote commands can now be issued to the 3500 / 3500A.

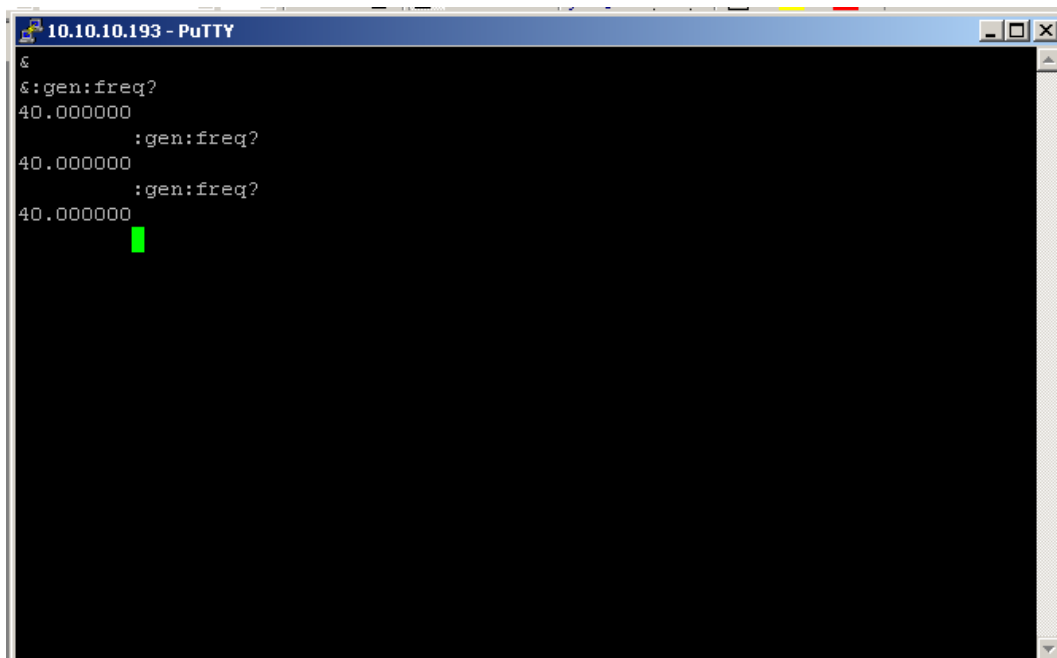

C-3-2. CONFIGURATION FOR RS-232

1. Connect RS-232 Cable to the RS-232 Connector on the Breakout Box and to the RS-232 Connector on the PC.
2. Access the 3500 / 3500A Remote Setup Screen and select the RS-232 selection. (Refer to para 2-2-7A for the Remote Setup Screen Field settings.) Select the settings shown and ensure the 'Port Currently Active' field is set to "RS-232." Press the "Config" F5 Key to re-establish the 3500 / 3500A to the new screen settings.

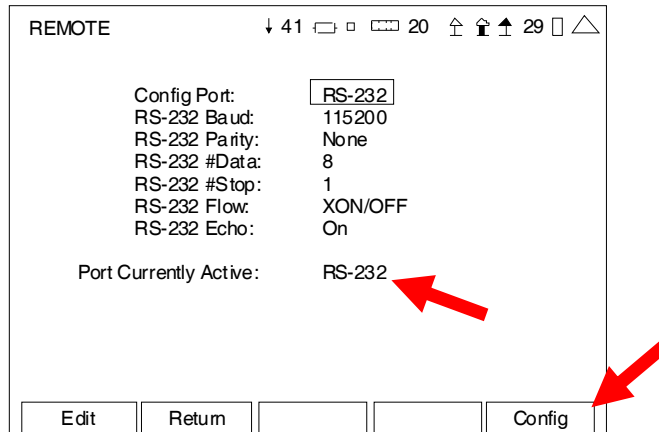

3. On the PC, open HyperTerminal and create a new connection. Select "OK."

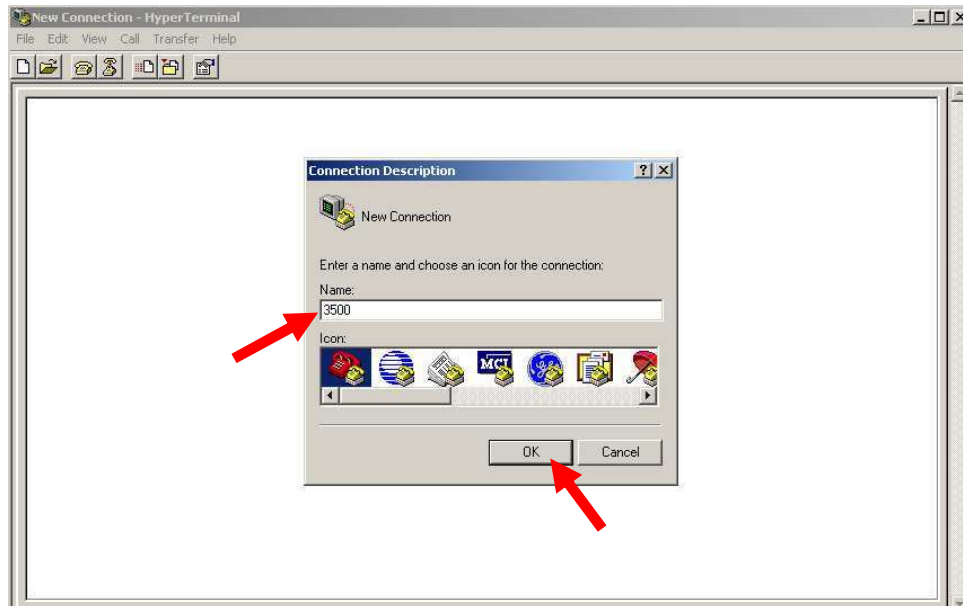

C-3-2. CONFIGURATION FOR RS-232 (cont)

4. Select "COM2." Select "OK."

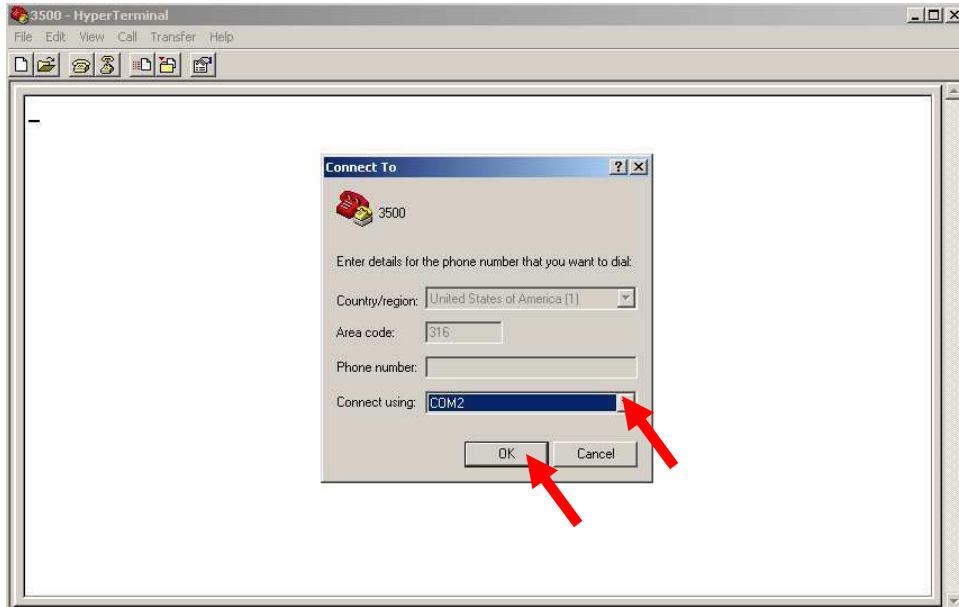

5. Set 'Bits per Second' to "115200," 'Data bits' to "8," 'Parity' to "None," 'Stop bits' to "1" and 'Flow control' to "Xon/Xoff. Select "OK."

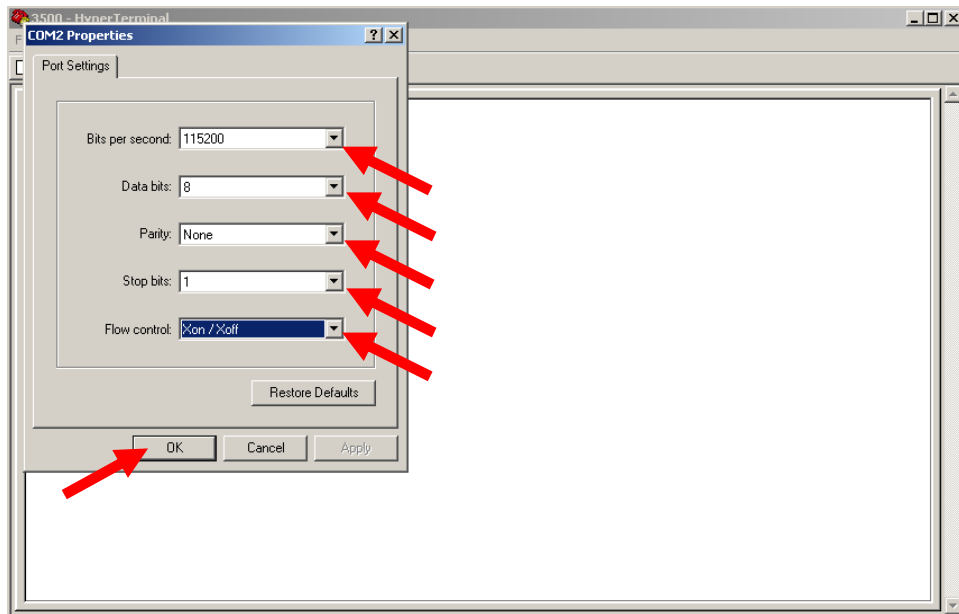

C-3-2. CONFIGURATION FOR RS-232 (cont)

6. The Remote Window is displayed on the PC. Remote commands can now be issued to the 3500 / 3500A.

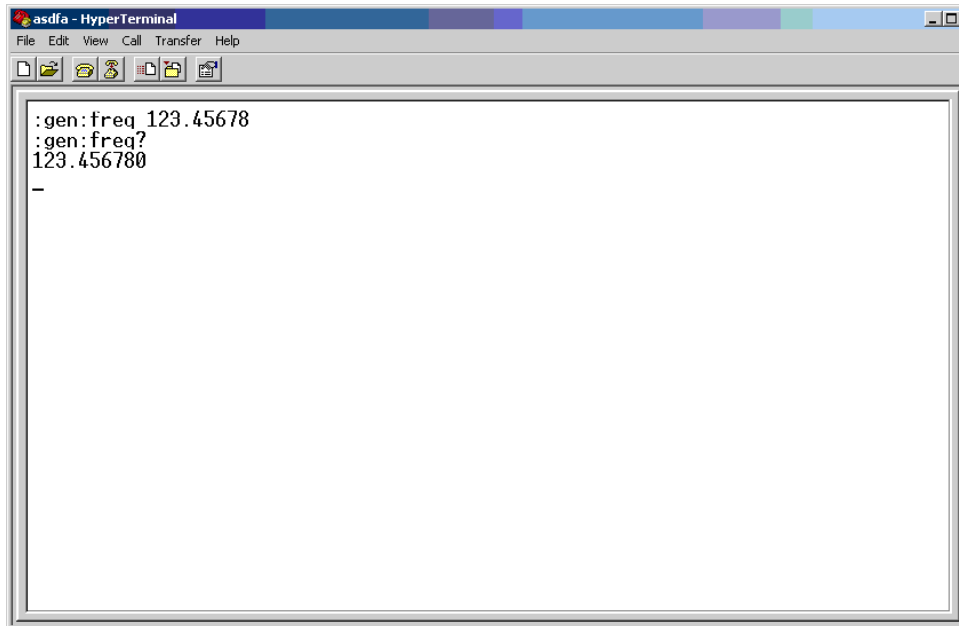
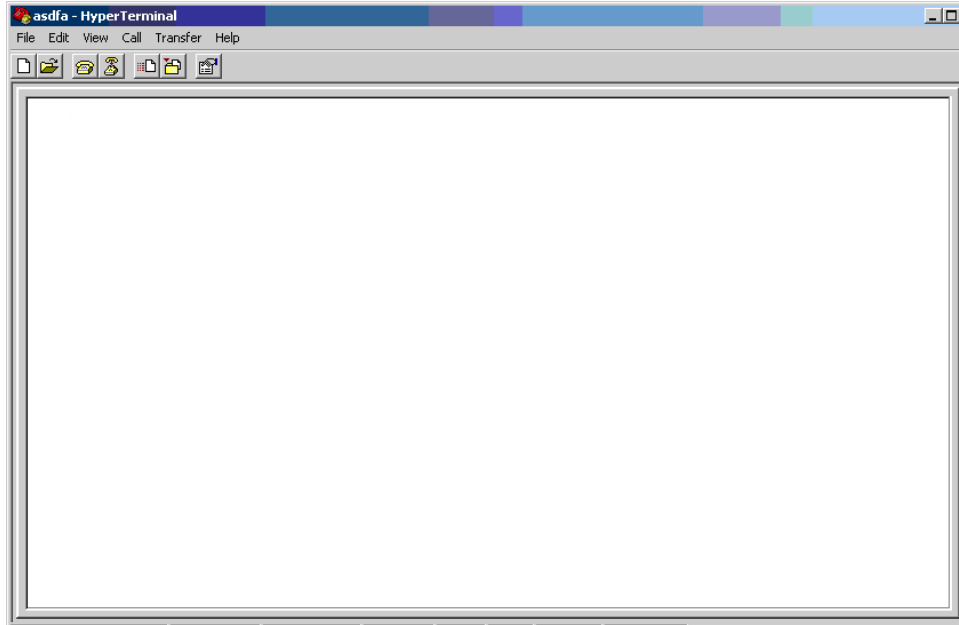

C-4. REMOTE OPERATION COMMANDS (cont)

AF Counter

COMMAND	RANGE	DESCRIPTION
:afctr:alarm:high:limit	15.0 to 20000.0	Sets Alarm high limit value.
:afctr:alarm:high:limit?		Returns Alarm high limit value.
:afctr:alarm:high:state		Sets Alarm high limit state.
:afctr:alarm:high:state?		Returns Alarm high limit state.
:afctr:alarm:low:limit	15.0 to 20000.0	Sets Alarm low limit value.
:afctr:alarm:low:limit?		Returns Alarm low limit value.
:afctr:alarm:low:state		Sets Alarm low limit state.
:afctr:alarm:low:state?		Returns Alarm low limit state.
:afctr:average	1 to 99	Sets number of readings to average.
:afctr:average?		Returns number of readings to average.
:afctr:filter	0 - None 1 - 300 Hz LPF 2 - 3 kHz LPF 3 - 5 kHz LPF 4 - 15 kHz LPF 5 - CMESS BPF 6 - CCITT BPF 7 - 300 Hz HPF 8 - 300 to 3000 Hz BPF 9 - 300 to 5000 Hz BPF 10 - 300 to 20000 Hz BPF	Sets input filter type.
:afctr:range?		Returns AF Counter range information.
:afctr:range:auto		Sets AF Counter autorange state to Auto.
:afctr:range>manual		Sets AF Counter autorange state to Manual.
:afctr:range:state?	0 - Auto 1 - Manual 2 - Manual -Waiting Update	Returns AF Counter autorange state.
:afctr:reading:avg?	0.0 to 20000.0 Hz	Returns AF Counter reading averaged value.
:afctr:reading:clear		Clears AF Counter reading.
:afctr:reading:max?	0.0 to 20000.0 Hz	Returns AF Counter reading maximum value.
:afctr:reading:min?	0.0 to 20000.0 Hz	Returns AF Counter reading minimum value.
:afctr:reading:val?	0.0 to 20000.0 Hz	Returns AF Counter reading with no statistics.
:afctr:resolution	1 - 1 Hz 2 - 0.1 Hz	Sets resolution for the reading.
:afctr:source	0 - EXT_AUD_IN_2_ AFCOUNTER 1 - DEMOD_2_AFCOUNTER 2 - MODULATION_2_ AFCOUNTER 3 - FGEN_2_AFCOUNTER	Sets signal source to count.
:afctr:source?		Returns signal source to count.
:afctr:state		Activates AF Counter.
:afctr:state?		Returns AF Counter state.

C-4. REMOTE OPERATION COMMANDS (cont)

AGC

COMMAND	RANGE	DESCRIPTION
:agc:mode	0 - Manual 1 - Auto	Sets AGC Mode.
:agc:mode?		Returns AGC Mode.
:agc:rfamp_mode	0 - Auto 1 - OFF 2 - ON	Sets Receiver input preamp state.
:agc:rfamp_mode?		Returns Receiver input preamp state.
:agc:state		Activates Receiver AGC.
:agc:state?		Returns Receiver AGC state.
:agc:tos	-90.0 to 10.0 dBm	Sets Top of Scale adjustment for Manual AGC Mode.
:agc:tos?		Returns Top of Scale adjustment for Manual AGC Mode.

C-4. REMOTE OPERATION COMMANDS (cont)

Audio Level Meter

COMMAND	RANGE	DESCRIPTION
:alm:alarm:high:limit	0.0 to 50.0	Sets Alarm high limit value.
:alm:alarm:high:limit?		Returns Alarm high limit value.
:alm:alarm:high:state		Sets Alarm high limit state.
:alm:alarm:high:state?		Returns Alarm high limit state.
:alm:alarm:low:limit	0.0 to 50.0	Sets Alarm low limit value.
:alm:alarm:low:limit?		Returns Alarm low limit value.
:alm:alarm:low:state		Sets Alarm low limit state.
:alm:alarm:low:state?		Returns Alarm low limit state.
:alm:average	1 to 99	Sets the average size.
:alm:average?		Returns the average size.
:alm:coupling	0 - AC 1 - DC 2 - GND	Sets signal coupling.
:alm:coupling?		Returns signal coupling.
:alm:detector	0 - RMS 1 - PEAK PLUS 2 - PEAK MINUS 3 - PK2PK	Sets detector type.
:alm:detector?		Returns detector type.
:alm:dvm:overload?	0 - No Overload 1 - Overload	Returns overload status of DVM Connector.
:alm:range:dbuv:auto		Sets Audio Level autorange state to Auto.
:alm:range:dbuv>manual		Sets Audio Level autorange state to Manual.
:alm:range:dbuv:range?		Returns Audio Level range information.
:alm:range:dbuv:state?	0 - Auto 1 - Manual 2 - Manual - Waiting Update	Returns Audio Level autorange state.
:alm:range:dbm:auto		Sets Audio Level autorange state to Auto.
:alm:range:dbm>manual		Sets Audio Level autorange state to Manual.
:alm:range:dbm:range?		Returns Audio Level range information.
:alm:range:dbm:state?	0 - Auto 1 - Manual 2 - Manual - Waiting Update	Returns Audio Level autorange state.
:alm:range:mv:auto		Sets Audio Level autorange state to Auto.
:alm:range:mv>manual		Sets Audio Level autorange state to Manual.
:alm:range:mv:range?		Returns Audio Level range information.
:alm:range:mv:state?	0 - Auto 1 - Manual 2 - Manual - Waiting Update	Returns Audio Level autorange state.
:alm:range:volt:auto		Sets Audio Level autorange state to Auto.
:alm:range:volt>manual		Sets Audio Level autorange state to Manual.
:alm:range:volt:range?		Returns Audio Level range information.
:alm:range:volt:state?	0 - Auto 1 - Manual 2 - Manual - Waiting Update	Returns Audio Level autorange state.
:alm:range:watts:auto		Sets Audio Level autorange state to Auto.
:alm:range:watts>manual		Sets Audio Level autorange state to Manual.
:alm:range:watts:range?		Returns Audio Level range information.
:alm:range:watts:state?	0 - Auto 1 - Manual 2 - Manual - Waiting Update	Returns Audio Level autorange state.

C-4. REMOTE OPERATION COMMANDS (cont)

Audio Level Meter (cont)

COMMAND	RANGE	DESCRIPTION
:alm:reading:avg?	0.0 to 50.0	Returns Audio Level Meter reading with averaged value.
:alm:reading:clear		Clears the meter readings.
:alm:reading:max?	0.0 to 50.0	Returns Audio Level Meter reading maximum value.
:alm:reading:min?	0.0 to 50.0	Returns Audio Level Meter reading minimum value
:alm:reading:val?	0.0 to 50.0	Returns Audio Level Meter average value.
:alm:scale	1 - 40 V max 2 - 2 V max	Sets hardware input scaling for the DVM connector.
:alm:scale?		Returns hardware input scaling for the DVM connector.
:alm:source	0 - AUD IN 1 - DVM	Sets input signal selection.
:alm:source?		Returns input signal selection.
:alm:state	0 - Disable 1 - Enable	Sets Audio Level Meter state.
:alm:state?		Returns Audio Level Meter state.
:alm:units	0 - V 1 - mV 2 - dB μ V 3 - dBm 4 - W	Sets current units setting.
:alm:units?		Returns current units setting.
:alm:zero		Activates DC offset compensation for the DVM input.
:alm:zero?		Returns DC offset compensation for the DVM input.

C-4. REMOTE OPERATION COMMANDS (cont)

C4FSK

COMMAND	RANGE	DESCRIPTION
:c4fsk:rx:average:ber	1 to 99	Sets number of readings to average.
:c4fsk:rx:average:ber?		Returns current average setting.
:c4fsk:rx:average:dev	1 to 99	Sets number of readings to average.
:c4fsk:rx:average:dev?		Returns current average setting.
:c4fsk:rx:average:freq	1 to 99	Sets number of readings to average.
:c4fsk:rx:average:freq?		Returns current average setting.
:c4fsk:rx:average:freq2	1 to 99	Sets number of readings to average.
:c4fsk:rx:average:freq2?		Returns current average setting.
:c4fsk:rx:average:freq_err	1 to 99	Sets number of readings to average.
:c4fsk:rx:average:freq_err?		Returns current average setting.
:c4fsk:rx:average:mod_fid	1 to 99	Sets number of readings to average.
:c4fsk:rx:average:mod_fid?		Returns current average setting.
:c4fsk:rx:average:pwr	1 to 99	Sets number of readings to average.
:c4fsk:rx:average:pwr?		Returns current average setting.
:c4fsk:rx:average:time	1 to 99	Sets number of readings to average.
:c4fsk:rx:average:time?		Returns current average setting.
:c4fsk:rx:ber:clear		Clears the current BER minimum, maximum and average settings.
:c4fsk:rx:ber:val?	0 - Average 1 - Maximum 2 - Minimum	Returns current value.
:c4fsk:rx:chan_id?		Returns channel ID (DMR Option).
:c4fsk:rx:config		Configures digital receive. (Must be run after setting P25 State to 1 before taking readings.)
:c4fsk:rx:color_code?		Returns color code (DMR Option).
:c4fsk:rx:dev:clear		Clears the current Deviation minimum, maximum and average settings.
:c4fsk:rx:dev:val?	0 - Average 1 - Maximum 2 - Minimum	Returns current value.
:c4fsk:rx:dev2:clear		Clears the current Deviation 2 minimum, maximum and average settings.
:c4fsk:rx:dev2:val?	0 - Average 1 - Maximum 2 - Minimum	Returns current value.
:c4fsk:rx:freq:clear		Clears the current Frequency minimum, maximum and average settings.
:c4fsk:rx:freq:val?	0 - Average 1 - Maximum 2 - Minimum	Returns current value.
:c4fsk:rx:freq2:clear		Clears the current Frequency 2 minimum, maximum and average settings.
:c4fsk:rx:freq2:val?	0 - Average 1 - Maximum 2 - Minimum	Returns current value.
:c4fsk:rx:freq_err:clear		Clears the current Frequency Error minimum, maximum and average settings.
:c4fsk:rx:freq_err:val?	0 - Average 1 - Maximum 2 - Minimum	Returns current value.
:c4fsk:rx:magerr?		Returns Magnitude Error value (DMR Option).
:c4fsk:rx:magerr:clear		Clears the current Magnitude Error minimum, maximum and average settings. (DMR Option).

C-4. REMOTE OPERATION COMMANDS (cont)

C4FSK (cont)

COMMAND	RANGE	DESCRIPTION
:c4fsk:rx:mod_fid:clear		Clears the current Mod Fidelity minimum, maximum and average settings.
:c4fsk:rx:mod_fid:val?	0 - Average 1 - Maximum 2 - Minimum	Returns current value.
:c4fsk:rx:nac:val?		Returns current value of Network Access Code.
:c4fsk:rx:nxdnrate	0 - 2400 1 - 4800	Sets rate data is transmitted (NXDN Option).
:c4fsk:rx:nxdnrate?		Returns rate data is transmitted (NXDN Option).
:c4fsk:rx:pattern	0 - 1011 1 - Cal 2 - 0.153	Sets decode pattern.
:c4fsk:rx:pattern?		Returns decode pattern.
:c4fsk:rx:pwr:clear		Clears the current Power minimum, maximum and average settings.
:c4fsk:rx:pwr:val?	0 - Average 1 - Maximum 2 - Minimum	Returns current value.
:c4fsk:rx:pwr2:val?	0 - Average 1 - Maximum 2 - Minimum	Returns current value.
:c4fsk:rx:ran?		Returns radio access number (NXDN Option).
:c4fsk:rx:reset_acq		Resets variables.
:c4fsk:rx:state	0 - OFF 1 - ON	Sets digital receive state.
:c4fsk:rx:state?		Returns digital receive state.
:c4fsk:rx:time:clear		Clears the current Time minimum, maximum and average settings.
:c4fsk:rx:time:val?	0 - Average 1 - Maximum 2 - Minimum	Returns current value.
:c4fsk:rx:unit_id?		Returns unit ID (DMR Option).
:c4fsk:tx:chan_id	0 - P25 1 - DMR 2 - dPMR 3 - ARIBT98 4 - NXDN 00000000 to 16777215	Sets channel ID (DMR Option).
:c4fsk:tx:color_code	0 - P25 1 - DMR 2 - dPMR 3 - ARIBT98 4 - NXDN 0 to 15	Sets color code (DMR Option).
:c4fsk:tx:err	0 to 20	Sets number of false errors on transmitted signal.
:c4fsk:tx:nac	0 - P25 1 - DMR 2 - dPMR 3 - ARIBT98 4 - NXDN 000 to FFF	Sets digital receive Network Access Code (P25 Option only).

C-4. REMOTE OPERATION COMMANDS (cont)

C4FSK (cont)

COMMAND	RANGE	DESCRIPTION
:c4fsk:tx:nxdnrate	0 - 2400 1 - 4800	Sets rate data is transmitted (NXDN Option).
:c4fsk:tx:nxdnrate?		Returns rate data is transmitted (NXDN Option).
:c4fsk:tx:option?	0 - P25 1 - DMR 2 - dPMR 3 - ARIBT98 4 - NXDN 0 - Disabled 1 - Enabled	Returns digital receive option enable status.
:c4fsk:tx:pattern	0 - P25 1 - DMR 2 - dPMR 3 - ARIBT98 4 - NXDN 0 - 1011 1 - Cal 2 - 0.153	Sets digital receive decode pattern.
:c4fsk:tx:pattern?		Returns digital receive decode pattern.
:c4fsk:tx:state	0 - P25 1 - DMR 2 - dPMR 3 - ARIBT98 4 - NXDN 0 - ON 1 - OFF	Sets digital receive state (DMR Option only).
:c4fsk:tx:state?		Returns digital receive state (DMR Option only).
:c4fsk:tx:unit_id	0 - P25 1 - DMR 2 - dPMR 3 - ARIBT98 4 - NXDN 0 to 15	Returns unit ID (DMR Option).

C-4. REMOTE OPERATION COMMANDS (cont)

Calibration

COMMAND	RANGE	DESCRIPTION
:calibration:continue	0 - GEN 1 - REC 2 - Audio In	Continues individual Calibration.
:calibration:save	0 - GEN 1 - REC 2 - Audio In	Saves individual Calibration.
:calibration:start	0 - GEN 1 - REC 2 - Audio In	Starts individual Calibration.
:calibration:state?	0 - GEN 1 - REC 2 - Audio In 0 - Not Running 1 - Running 2 - Waiting for Continue	Returns individual Calibration state.
:calibration:stop	0 - GEN 1 - REC 2 - Audio IN	Stops individual Calibration.

C-4. REMOTE OPERATION COMMANDS (cont)

DCS Decode

COMMAND	RANGE	DESCRIPTION
:dcs:decode:getcode?	0 - 023 29 -205 58 - 465 1 - 025 30 - 223 59 - 466 2 - 026 31 - 226 60 - 503 3 - 031 32 - 243 61 - 506 4 - 032 33 - 244 62 - 516 5 - 043 34 - 245 63 - 532 6 - 047 35 - 251 64 - 546 7 - 051 36 - 261 65 - 565 8 - 054 37 - 263 66 - 606 9 - 065 38 - 265 67 - 612 10 - 071 39 - 271 68 - 624 11 - 072 40 - 306 69 - 627 12 - 073 41 - 311 70 - 631 13 - 074 42 - 315 71 - 632 14 - 114 43 - 331 72 - 654 15 - 115 44 - 343 73 - 662 16 - 116 45 - 346 74 - 664 17 - 125 46 - 351 75 - 703 18 - 131 47 - 364 76 - 712 19 - 132 48 - 365 77 - 723 20 - 134 49 - 371 78 - 731 21 - 143 50 - 411 79 - 732 22 - 152 51 - 412 80 - 734 23 - 155 52 - 413 81 - 743 24 - 156 53 - 423 82 - 754 25 - 162 54 - 431 83 - OFF 26 - 165 55 - 432 84 - N/S 27 - 172 56 - 445 28 - 174 57 - 464	Returns DCS Decode number code.
:dcs:decode:invert	0 - Non-Inverted 1 - Inverted	Sets DCS Decode Inverted state.
:dcs:decode:state	0 - OFF 1 - ON	Sets DCS Decode state.
:dcs:decode:state?		Returns DCS Decode state.

C-4. REMOTE OPERATION COMMANDS (cont)

Demod

COMMAND	RANGE	DESCRIPTION
:demod:afbw	0 - None 1 - 300 Hz LPF 2 - 3 kHz LPF 3 - 5 kHz LPF 4 - 15 kHz LPF 5 - CMESS BPF 6 - CCITT BPF 7 - 300 Hz HPF 8 - 300 to 3000 Hz HPF 9 - 300 to 5000 Hz HPF 10 - 300 to 20000 Hz HPF	Sets Demod AF Bandwidth.
:demod:afbw?		Returns Demod AF bandwidth setting.
:demod:dcpwr	ON or OFF	Sets DC power to ADC.
:demod:dcpwr?		Returns DC power state.
:demod:state		Activates Analog Demod.
:demod:state?	ON or OFF	Returns Analog Demod state.
:demod:type	0 - FM_DEMOD_DEV_5 1 - FM_DEMOD_DEV_6P25 2 - FM_DEMOD_DEV_8P33 3 - FM_DEMOD_DEV_10 4 - FM_DEMOD_DEV_12P5 5 - FM_DEMOD_DEV_25 6 - FM_DEMOD_DEV_30 7 - FM_DEMOD_DEV_100 8 - FM_DEMOD_DEV_300 9 - AM_DEMOD_DEV_5 10 - AM_DEMOD_DEV_6P25 11 - AM_DEMOD_DEV_8P33 12 - AM_DEMOD_DEV_10 13 - AM_DEMOD_DEV_12P5 14 - AM_DEMOD_DEV_25 15 - AM_DEMOD_DEV_30 25 - SIGSTR_DEMOD_DEV_30K 26 - SIGSTR_DEMOD_DEV_300K 27 - SIGSTR_DEMOD_DEV_3M 28 - SIGSTR_DEMOD_DEV_5M	Sets Demod Modulation.
:demod:type?		Returns Demod Modulation setting.

C-4. REMOTE OPERATION COMMANDS (cont)

Deviation Meter / Modulation Meter

COMMAND	RANGE	DESCRIPTION
:devmod:alarm:high:limit	AM - 0.0% to 100% FM - 0.0 to 100.0 kHz	Sets Alarm high limit value.
:devmod:alarm:high:limit?		Returns Alarm high limit value.
:devmod:alarm:high:state		Sets Alarm high limit state.
:devmod:alarm:high:state?		Returns Alarm high limit state.
:devmod:alarm:low:limit	AM - 0.0% to 100% FM - 0.0 to 100.0 kHz	Sets Alarm low limit value.
:devmod:alarm:low:limit?		Returns Alarm low limit value.
:devmod:alarm:low:state		Sets Alarm low limit state.
:devmod:alarm:low:state?		Returns Alarm low limit state.
:devmod:average	1 to 99	Sets number of readings to average.
:devmod:average?		Returns number of readings to average.
:devmod:range:am:auto		Sets Modulation Meter autorange state to Auto.
:devmod:range:am>manual		Sets Modulation Meter autorange state to Manual.
:devmod:range:am:range?		Returns Modulation Meter range information.
:devmod:range:am:state?	0 - Auto 1 - Manual 2 - Manual - Waiting Update	Returns Modulation Meter autorange state.
:devmod:range:fm:auto		Sets Modulation Meter autorange state to Auto.
:devmod:range:fm>manual		Sets Modulation Meter autorange state to Manual.
:devmod:range:fm:range?		Returns Modulation Meter range information.
:devmod:range:fm:state?	0 - Auto 1 - Manual 2 - Manual - Waiting Update	Returns Modulation Meter autorange state.
:devmod:reading:avg?	AM - 0.0% to 100% FM - 0.0 to 100.0 kHz	Returns Modulation Meter reading new average Peak2Peak value.
:devmod:reading:clear		Clears Meter reading.
:devmod:reading:max?	AM - 0.0% to 100% FM - 0.0 to 100.0 kHz	Returns Modulation Meter reading maximum value.
:devmod:reading:min?	AM - 0.0% to 100% FM - 0.0 to 100.0 kHz	Returns Modulation Meter reading minimum value
:devmod:reading:peak2peak?	AM - 0.0% to 100% FM - 0.0 to 100.0 kHz	Returns Modulation Meter reading Peak2Peak value.
:devmod:reading:pk_state		Enables/disables reading Peak Hold function.
:devmod:reading:type	0 - PEAK_READING_PLUS 1 - PEAK_READING_MINUS 2 - PK_PK_READING	Selects readings sent to CF Meter.
:devmod:reading:type?		Returns readings sent to CF Meter.
:devmod:reading:val?	AM - 0.0% to 100% FM - 0.0 to 100.0 kHz	Returns Modulation Meter reading current average Peak2Peak value.
:devmod:type	0 - AM 1 - FM	Sets Meter Type.
:devmod:type?		Returns Meter Type.

C-4. REMOTE OPERATION COMMANDS (cont)

Distortion Meter

COMMAND	RANGE	DESCRIPTION
:distortion:demod:alarm:high:limit	0.0% to 100%	Sets Alarm high limit value.
:distortion:demod:alarm:high:limit?		Returns Alarm high limit value.
:distortion:demod:alarm:high:state		Sets Alarm high limit state.
:distortion:demod:alarm:high:state?		Returns Alarm high limit state.
:distortion:demod:alarm:low:limit	0.0% to 100%	Sets Alarm low limit value.
:distortion:demod:alarm:low:limit?		Returns Alarm low limit value.
:distortion:demod:alarm:low:state		Sets Alarm low limit state.
:distortion:demod:alarm:low:state?		Returns Alarm low limit state.
:distortion:demod:average	1 to 99	Sets number of readings to average.
:distortion:demod:average?		Returns number of readings to average.
:distortion:demod:reading:avg?	0.0% to 100%	Returns Distortion Meter reading with averaged value.
:distortion:demod:reading:clear		Clear Distortion Meter reading.
:distortion:demod:reading:max?	0.0% to 100%	Returns Distortion Meter reading maximum value.
:distortion:demod:reading:min?	0.0% to 100%	Returns Distortion Meter reading minimum value.
:distortion:demod:reading:val?	0.0% to 100%	Returns Distortion Meter average value.
:distortion:demod:state		Activates Distortion Meter on demod input.
:distortion:demod:state?		Returns Distortion Meter state on demod input.
:distortion:ext_aud_in:alarm:high:limit	0.0% to 100%	Sets Alarm high limit value.
:distortion:ext_aud_in:alarm:high:limit?		Returns Alarm high limit value.
:distortion:ext_aud_in:alarm:high:state		Sets Alarm high limit state.
:distortion:ext_aud_in:alarm:high:state?		Returns Alarm high limit state.
:distortion:ext_aud_in:alarm:low:limit	0.0% to 100%	Sets Alarm low limit value.
:distortion:ext_aud_in:alarm:low:limit?		Returns Alarm low limit value.
:distortion:ext_aud_in:alarm:low:state		Sets Alarm low limit state.
:distortion:ext_aud_in:alarm:low:state?		Returns Alarm low limit state.
:distortion:ext_aud_in:average	1 to 99	Sets number of readings to average.
:distortion:ext_aud_in:average?		Returns number of readings to average.
:distortion:ext_aud_in:filter	0 - No Filter 1 - 15 kHz LP 2 - 300 Hz to 3 kHz BP	Sets audio filter status.
:distortion:ext_aud_in:filter?		Returns audio filter status.
:distortion:ext_aud_in:reading:avg?	0.0% to 100%	Returns Distortion Meter reading with averaged value.
:distortion:ext_aud_in:reading:clear		Clear Distortion Meter reading.
:distortion:ext_aud_in:reading:max?	0.0% to 100%	Returns Distortion Meter reading maximum value.
:distortion:ext_aud_in:reading:min?	0.0% to 100%	Returns Distortion Meter reading minimum value.
:distortion:ext_aud_in:reading:val?	0.0% to 100%	Returns Distortion Meter average value.
:distortion:ext_aud_in:state		Activates Distortion Meter on ext audio input.

C-4. REMOTE OPERATION COMMANDS (cont)

Distortion Meter (cont)

COMMAND	RANGE	DESCRIPTION
:distortion:ext_aud_in:state?		Returns Distortion Meter state on ext audio input.
:distortion:fgen:alarm:high:limit	0.0% to 100%	Sets Alarm high limit value.
:distortion:fgen:alarm:high:limit?		Returns Alarm high limit value.
:distortion:fgen:alarm:high:state		Sets Alarm high limit state.
:distortion:fgen:alarm:high:state?		Returns Alarm high limit state.
:distortion:fgen:alarm:low:limit	0.0% to 100%	Sets Alarm low limit value.
:distortion:fgen:alarm:low:limit?		Returns Alarm low limit value.
:distortion:fgen:alarm:low:state		Sets Alarm low limit state.
:distortion:fgen:alarm:low:state?		Returns Alarm low limit state.
:distortion:fgen:average	1 to 99	Sets number of readings to average.
:distortion:fgen:average?		Returns number of readings to average.
:distortion:fgen:reading:avg?	0.0% to 100%	Returns Distortion Meter reading with averaged value.
:distortion:fgen:reading:clear		Clear Distortion Meter reading.
:distortion:fgen:reading:max?	0.0% to 100%	Returns Distortion Meter reading maximum value.
:distortion:fgen:reading:min?	0.0% to 100%	Returns Distortion Meter reading minimum value.
:distortion:fgen:reading:val?	0.0% to 100%	Returns Distortion Meter average value.
:distortion:fgen:state		Activates Distortion Meter on function generator input.
:distortion:fgen:state?		Returns Distortion Meter state on function generator input.
:distortion:range?		Returns Distortion Meter range information.
:distortion:range:auto		Sets Distortion Meter autorange state to Auto.
:distortion:range>manual		Sets Distortion Meter autorange state to Manual.
:distortion:range:state?	0 - Auto 1 - Manual 2 - Manual - Waiting Update	Returns Distortion Meter autorange state.

External Audio Input

COMMAND	RANGE	DESCRIPTION
:extaudin:gain	0.0001 to 1.0	Sets external audio input gain.
:extaudin:load	0 - Open 1 - 150 Ω 2 - 600 Ω 3 - 1 k Ω (3500A only) 4 - Divide-by-10	Sets output scaling.
:extaudin:mute		Sets input state.
:extaudin:state	ON or OFF	Sets external audio input ON/OFF.
:extaudin:state?		Returns external audio input state.

C-4. REMOTE OPERATION COMMANDS (cont)

External Audio Output

COMMAND	RANGE	DESCRIPTION
:extaudout:source	0 - EXT_AUD_IN_2_EXT_AUD_OUT 1 - DEMOD_2_EXT_AUD_OUT 2 - MODULATION_2_EXT_AUD_OUT 3 - FGEN_2_EXT_AUD_OUT	Selects signal source.
:extaudout:source?		Returns external audio output source.
:extaudout:state	ON or OFF	Sets external audio output ON/OFF.
:extaudout:state?		Returns external audio output state.

Frequency Find

COMMAND	RANGE	DESCRIPTION
:freqfind:peak?	in MHz	Returns next tune frequency.
:freqfind:start	2 to 1000 MHz	Sets tune start frequency.
:freqfind:start?		Returns tune start frequency.
:freqfind:stop	2 to 1000 MHz	Sets tune stop frequency.
:freqfind:stop?		Returns tune stop frequency.
:freqfind:threshold	-110.0 to 40.0 dBm	Sets tune threshold.
:freqfind:threshold?		Returns tune threshold.
:freqfind:channel_boundary	0.001 to 5.000 MHz	Sets channel bandwidth step for frequency search.
:freqfind:channel_boundary?		Returns channel bandwidth step for frequency search.

Function Generator

COMMAND	RANGE	DESCRIPTION
:fgen:enable		Sets Function Generator ON/OFF.
:fgen:enable?		Returns Function Generator condition.
:fgen:freq	1 - Fgen1 2 - Fgen2 0 to 24000 Hz	Sets individual Function Generator frequency.
:fgen:level	1 - Fgen1 2 - Fgen2 0 to 1.7 Vrms	Sets individual Function Generator output level.
:fgen:load	0 - 600 Ω 1 - 150 Ω 2 - Open Circuit	Sets output scaling.
:fgen:state	1 - Fgen1 2 - Fgen2 ON or OFF	Sets individual Function Generator ON/OFF.

C-4. REMOTE OPERATION COMMANDS (cont)

Normalize

COMMAND	RANGE	DESCRIPTION
:normalize:pre:state		Activates pre-normalize.
:normalize:pre:status?	0 - Stopped 1 - Running	Returns pre-normalize status.
:normalize:recall		Issues command to database to recall TABLE_CURRENT_NORMALIZE.
:normalize:run:state		Activates normalize.
:normalize:run:status?	0 - Stopped 1 - Running	Returns normalize status.

C-4. REMOTE OPERATION COMMANDS (cont)

Oscilloscope

COMMAND	RANGE	DESCRIPTION
:scope:coupling	0 - AC 1 - DC 2 - GND	Sets Oscilloscope input coupling.
:scope:coupling?		Returns Oscilloscope input coupling.
:scope:dvm:divby20	0 - 2 V max 1 - 40 V max	Sets input scaling for DVM Connector.
:scope:dvm:divby20?		Returns input scaling for DVM Connector.
:scope:dvm:overload?	0 - No Overload 1 - Overload	Returns DVM overload status.
:scope:offset:horiz		Sets Oscilloscope input horizontal offset.
:scope:offset:horiz?		Returns Oscilloscope input horizontal offset.
:scope:offset:vertical	-100.0 to 100.0	Sets Oscilloscope input vertical offset.
:scope:offset:vertical?		Returns Oscilloscope input vertical offset.
:scope:scale:horiz	0 - 20 μ s/Div 1 - 50 μ s/Div 2 - 0.1 ms/Div 3 - 0.2 ms/Div 4 - 0.5 ms/Div 5 - 1 ms/Div 6 - 2 ms/Div 7 - 4 ms/Div 8 - 6 ms/Div 9 - 10 ms/Div 10 - 20 ms/Div 11 - 50 ms/Div 12 - 0.1 sec/Div	Sets Oscilloscope input horizontal scale.
:scope:scale:horiz?		Returns Oscilloscope input horizontal scale.
:scope:scale:vertical	0 - 10 mV/Div (DVM / AUDIO IN) 0.1 kHz/Div (DEMODO FM) 5%/Div (DEMODO AM) 1 - 20 mV/Div (DVM / AUDIO IN) 0.2 kHz/Div (DEMODO FM) 10%/Div (DEMODO AM) 2 - 50 mV/Div (DVM / AUDIO IN) 0.5 kHz/Div (DEMODO FM) 20%/Div (DEMODO AM) 3 - 0.1 V/Div (DVM / AUDIO IN) 1 kHz/Div (DEMODO FM) 50%/Div (DEMODO AM) 4 - 0.2 V/Div (DVM / AUDIO IN) 2 kHz/Div (DEMODO FM) 5 - 0.5 V/Div (DVM / AUDIO IN) 5 kHz/Div (DEMODO FM) 6 - 1 V/Div (DVM / AUDIO IN) 10 kHz/Div (DEMODO FM) 7 - 2 V/Div (DVM / AUDIO IN) 20 kHz/Div (DEMODO FM) 8 - 5 V/Div (DVM / AUDIO IN) 50 kHz/Div (DEMODO FM) 9 - 10 V/Div (DVM / AUDIO IN)	Sets Oscilloscope input vertical scale.
:scope:scale:vertical?		Returns Oscilloscope input vertical scale.
:scope:source	0 - DVM 1 - DEMODO 2 - AUD IN 3 - FGEN	Sets Oscilloscope input source.
:scope:source?		Returns Oscilloscope input source.

C-4. REMOTE OPERATION COMMANDS (cont)

Oscilloscope (cont)

COMMAND	RANGE	DESCRIPTION
:scope:state	0 - Disable 1 - Enable	Sets Oscilloscope input state.
:scope:state?		Returns Oscilloscope input state.
:scope:trace:length?		Returns maximum Oscilloscope trace elements.
:scope:trace:val?		Returns Oscilloscope trace value.
:scope:trigger:edge	0 - FALL 1 - RISE	Sets Oscilloscope input trigger edge.
:scope:trigger:edge?		Returns Oscilloscope input trigger edge.
:scope:trigger:level		Sets Oscilloscope input trigger level.
:scope:trigger:level?		Returns Oscilloscope input trigger level.
:scope:trigger:mode	0 - NORMAL 1 - AUTO 2 - SINGLE	Sets Oscilloscope input trigger mode.
:scope:trigger:mode?		Returns Oscilloscope input trigger mode.
:scope:trigger:type	0 - NORMAL 1 - AUTO 2 - SINGLE 0 - FALL 1 - RISE LEVEL	Sets Oscilloscope input trigger.

Options

COMMAND	RANGE	DESCRIPTION
:options:flash?	ID Number	Returns unique ID Number.
:options:isactive?	35000001 35000010 35000060 35000070 35000100 0 - Not Installed 1 - Installed	Returns status of installed Option.
:options:man?	Aeroflex	Returns manufacturer's name.
:options:model?	3500	Returns model number.
:options:productid?	3500 or 3500A	Returns product number.
:options:serial?	10 Digit SN	Returns serial number.

C-4. REMOTE OPERATION COMMANDS (cont)

Receiver

COMMAND	RANGE	DESCRIPTION
:rec:atten?	0, 10, 20 or 30 dB	Returns Receiver attenuator setting.
:rec:dcpwr	0 - OFF 1 - ON	Sets Receiver DC Power state.
:rec:extpad	-30.0 to 30.0 dB	Sets compensation of Receiver TOS for external pad.
:rec:extpad?		Returns value of compensation for external pad.
:rec:freq	2.000000 to 1000.000000 MHz	Sets Receiver frequency.
:rec:freq?		Returns Receiver frequency.
:rec:port	0 - T/R 1 - ANT	Sets Receiver Input Connector.
:rec:port?		Returns Receiver Input Connector selected.
:rec:port:protection	0 - OFF 1 - RESET 2 - ON	Resets ANT Connector protection circuit.

RF Error Meter

COMMAND	RANGE	DESCRIPTION
:rferr:alarm:high:limit	0.0 to 200.0 kHz	Sets Alarm high limit value.
:rferr:alarm:high:limit?		Returns Alarm high limit value.
:rferr:alarm:high:state		Sets Alarm high limit state.
:rferr:alarm:high:state?		Returns Alarm high limit state.
:rferr:alarm:low:limit	0.0 to 200.0 kHz	Sets Alarm low limit value.
:rferr:alarm:low:limit?		Returns Alarm low limit value.
:rferr:alarm:low:state		Sets Alarm low limit state.
:rferr:alarm:low:state?		Returns Alarm low limit state.
:rferr:average	1 to 99	Sets number of readings to average.
:rferr:average?		Returns number of readings to average.
:rferr:interval	0.0 to 53.0 sec	Sets RF Counter update interval.
:rferr:interval?		Returns RF Counter interval.
:rferr:range?		Returns RF Error Meter range information.
:rferr:range:auto		Sets RF Error Meter autorange state to Auto.
:rferr:range>manual		Sets RF Error Meter autorange state to Manual.
:rferr:range:state?	0 - Auto 1 - Manual 2 - Manual - Waiting Update	Returns RF Error Meter autorange state.
:rferr:reading:avg?	0.0 to 200.0 kHz	Returns RF Error Counter reading averaged value.
:rferr:reading:clear		Clears RF Error Counter reading.
:rferr:reading:max?	0.0 to 200.0 kHz	Returns RF Error Counter reading maximum value.
:rferr:reading:min?	0.0 to 200.0 kHz	Returns RF Error Counter reading minimum value.
:rferr:reading:val?	0.0 to 200.0 kHz	Returns RF Error Counter reading with no statistics.
:rferr:relative	0 - Absolute 1 - Relative	Sets RF Error to absolute or relative counting using the Receiver RF.
:rferr:relative?		Returns if RF Error set to absolute or relative counting.
:rferr:state		Activates RF Error Counter.
:rferr:state?		Returns state of RF Error Counter.

C-4. REMOTE OPERATION COMMANDS (cont)

RF Generator

COMMAND	RANGE	DESCRIPTION
:gen:ant:protection?	0 - OFF 1 - ON (Overload)	Returns ANT Connector protection state.
:gen:ant:protection:reset		Resets ANT Connector protection state.
:gen:atten?	0 to 63 dB	Returns RF Generator attenuator setting.
:gen:dcpwr	0 - OFF 1 - ON	Sets RF Generator DC Power state.
:gen:extpad	-30.0 to 30.0 dB	Sets compensation of RF Generator output level for external pad.
:gen:extpad?		Returns value of compensation for external pad.
:gen:freq	2.000000 to 1000.000000 MHz	Sets RF Generator frequency.
:gen:freq?		Returns RF Generator frequency.
:gen:lvl:dbm	SWR - -65 to -5 dBm T/R - -120 to -50 dBm ANT - -90 to -30 dBm	Sets RF Generator level on selected output connector.
:gen:lvl:dbm?		Returns RF Generator level on selected output connector.
:gen:lvl:unit	0 - dBm 1 - μ V	Sets RF Generator level units to μ V or dBm.
:gen:lvl:uv	SWR - 125.74 to 125743.34 μ V T/R - 0.22361 to 707.11 μ V ANT - 7.071 to 7071.07 μ V	Sets RF Generator level on selected output connector.
:gen:lvl:uv?		Returns RF Generator level on selected output connector.
:gen:port	0 - T/R 1 - ANT 2 - SWR	Sets RF Generator Output Connector.
:gen:port?		Returns RF Generator Output Connector selected.
:gen:port:protection	0 - OFF 1 - RESET 2 - ON	Resets SWR Connector protection circuit.
:gen:swr:protection?	0 - OFF 1 - ON (Overload)	Returns SWR Connector protection state.
:gen:swr:protection:reset		Resets SWR Connector protection state.
:gen:tr:protection?	0 - OFF 1 - ON (Overload)	Returns T/R Connector protection state.
:gen:tr:protection:reset		Resets T/R Connector protection state.

C-4. REMOTE OPERATION COMMANDS (cont)

RF Power Meter

COMMAND	RANGE	DESCRIPTION
:rfpow:alarm:high:limit	1.0 to 43.0 dBm 0.1 to 20.0 W	Sets Alarm high limit value.
:rfpow:alarm:high:limit?		Returns Alarm high limit value.
:rfpow:alarm:high:state		Sets Alarm high limit state.
:rfpow:alarm:high:state?		Returns Alarm high limit state.
:rfpow:alarm:low:limit	1.0 to 43.0 dBm 0.1 to 20.0 W	Sets Alarm low limit value.
:rfpow:alarm:low:limit?		Returns Alarm low limit value.
:rfpow:alarm:low:state		Sets Alarm low limit state.
:rfpow:alarm:low:state?		Returns Alarm low limit state.
:rfpow:average	1 to 99	Sets number of readings to average.
:rfpow:average?		Returns number of readings to average.
:rfpow:cal:freq:resp?		Returns frequency in MHz at supplied index.
:rfpow:cal:lin:high:calpt		Takes current high power reading and supplied cal value at supplied index.
:rfpow:cal:lin:high:dac?		Returns DAC value at supplied index.
:rfpow:cal:lin:high:pow?		Returns dBm value at supplied index.
:rfpow:cal:lin:high:size		Clears previous high range cal curve and resizes as required.
:rfpow:cal:lin:high:size?		Returns high power cal curve size.
:rfpow:cal:lin:low:calpt		Takes current low power reading and supplied cal value at supplied index.
:rfpow:cal:lin:low:dac?		Returns dac value at supplied index.
:rfpow:cal:lin:low:pow?		Returns dBm value at supplied index.
:rfpow:cal:lin:low:size		Clears previous low range cal curve and resizes as required.
:rfpow:cal:lin:low:size?		Returns low power cal curve size.
:rfpow:cal:recalc		Recalculates Calibration.
:rfpow:cal:recall		Recalls Calibration Data.
:rfpow:cal:resp:calpt		Takes correction freq and index to fill cal table.
:rfpow:cal:resp:calpt?		Returns cal factor value at supplied index.
:rfpow:cal:resp:size		Clears previous response cal curve and resizes as required.
:rfpow:cal:resp:size?		Returns response cal curve size.
:rfpow:cal:save		Saves Calibration Data.
:rfpow:cal:state	0 - Normal PT Operation 1 - Range Cal 2 - Response Cal	Sets Calibration State
:rfpow:cal:state?		Returns Calibration State.
:rfpow:extatten	-30.0 to +30.0 dB	Sets compensation factor for external attenuation.
:rfpow:extatten?		Returns compensation factor for external attenuation.
:rfpow:range	0 - Low Range 1 - High Range 2 - Auto Range	Sets reading range operation.
:rfpow:range:dbm:range?		Returns RF Power Meter range information.
:rfpow:range:dbm:auto		Sets RF Power Meter autorange state to Auto.
:rfpow:range:dbm>manual		Sets RF Power Meter autorange state to Manual.

C-4. REMOTE OPERATION COMMANDS (cont)

RF Power Meter (cont)

COMMAND	RANGE	DESCRIPTION
:rfpow:range:dbm:state?	0 - Auto 1 - Manual 2 - Manual - Waiting Update	Returns RF Power Meter autorange state.
:rfpow:range:watts:range?		Returns RF Power Meter range information.
:rfpow:range:watts:auto		Sets RF Power Meter autorange state to Auto.
:rfpow:range:watts>manual		Sets RF Power Meter autorange state to Manual.
:rfpow:range:watts:state?	0 - Auto 1 - Manual 2 - Manual - Waiting Update	Returns RF Power Meter autorange state.
:rfpow:reading:avg?		Returns RF Power Meter average reading.
:rfpow:reading:clear		Clears the current minimum, maximum and average settings.
:rfpow:reading:dbm:avg?	1.0 to 43.0 dBm	Returns RF Power Meter average reading.
:rfpow:reading:dbm:max?	1.0 to 43.0 dBm	Returns RF Power Meter reading maximum value.
:rfpow:reading:dbm:min?	1.0 to 43.0 dBm	Returns RF Power Meter reading minimum value.
:rfpow:reading:dbm:val?	1.0 to 43.0 dBm	Returns RF Power Meter average reading.
:rfpow:reading:max?	1.0 to 43.0 dBm	Returns RF Power Meter reading maximum value.
:rfpow:reading:min?	1.0 to 43.0 dBm	Returns RF Power Meter reading minimum value.
:rfpow:reading:val?	1.0 to 43.0 dBm	Returns RF Power Meter average reading.
:rfpow:reading:watt:avg?	0.00125 to 20 W	Returns RF Power Meter average reading.
:rfpow:reading:watt:max?	0.00125 to 20 W	Returns RF Power Meter reading maximum value.
:rfpow:reading:watt:min?	0.00125 to 20 W	Returns RF Power Meter reading minimum value.
:rfpow:reading:watt:val?	0.00125 to 20 W	Returns RF Power Meter average reading.
:rfpow:state		Enables/disables RF Power Meter operation.
:rfpow:state?		Returns state of RF Power Meter.
:rfpow:units	0 - dBm 1 - Watts	Sets units for reading.
:rfpow:zero		Starts zero operation required before measurements.

C-4. REMOTE OPERATION COMMANDS (cont)

RSSI Meter

COMMAND	RANGE	DESCRIPTION
:rssi:alarm:high:limit	0 to 20 W	Sets Alarm high limit value.
:rssi:alarm:high:limit?		Returns Alarm high limit value.
:rssi:alarm:high:state		Sets Alarm high limit state.
:rssi:alarm:high:state?		Returns Alarm high limit state.
:rssi:alarm:low:limit	0 to 20 W	Sets Alarm low limit value.
:rssi:alarm:low:limit?		Returns Alarm low limit value.
:rssi:alarm:low:state		Sets Alarm low limit state.
:rssi:alarm:low:state?		Returns Alarm low limit state.
:rssi:average	1 to 99	Sets number of readings to average.
:rssi:average?		Returns number of readings to average.
:rssi:range:dbm:auto		Sets Audio Level autorange state to Auto.
:rssi:range:dbm>manual		Sets Audio Level autorange state to Manual.
:rssi:range:dbm:range?		Returns Audio Level range information.
:rssi:range:dbm:state?	0 - Auto 1 - Manual 2 - Manual - Waiting Update	Returns Audio Level autorange state.
:rssi:range:watts:auto		Sets Audio Level autorange state to Auto.
:rssi:range:watts>manual		Sets Audio Level autorange state to Manual.
:rssi:range:watts:range?		Returns Audio Level range information.
:rssi:range:watts:state?	0 - Auto 1 - Manual 2 - Manual - Waiting Update	Returns Audio Level autorange state.
:rssi:reading:avg?	-110 to 43 dBm	Returns RSSI reading averaged value.
:rssi:reading:dbm:avg?	-110 to 43 dBm	Returns RSSI reading averaged value.
:rssi:reading:dbm:max?	-110 to 43 dBm	Returns RSSI reading maximum value.
:rssi:reading:dbm:min?	-110 to 43 dBm	Returns RSSI reading minimum value.
:rssi:reading:dbm:val?	-110 to 43 dBm	Returns RSSI reading with no statistics.
:rssi:reading:clear		Clears RSSI reading.
:rssi:reading:max?	-110 to 43 dBm	Returns RSSI reading maximum value.
:rssi:reading:min?	-110 to 43 dBm	Returns RSSI reading minimum value.
:rssi:reading:units	0 - dBm 1 - Watts 2 - μ Watts	Sets displayed units.
:rssi:reading:val?	-110 to 43 dBm	Returns RSSI reading with no statistics.
:rssi:reading:watt:avg?	0 to 20 W	Returns RSSI reading averaged value.
:rssi:reading:watt:max?	0 to 20 W	Returns RSSI reading maximum value.
:rssi:reading:watt:min?	0 to 20 W	Returns RSSI reading minimum value.
:rssi:reading:watt:val?	0 to 20 W	Returns RSSI reading with no statistics.
:rssi:state		Activates RSSI readings.
:rssi:state?		Returns state of RSSI Meter.

C-4. REMOTE OPERATION COMMANDS (cont)

Screens

COMMAND	RANGE	DESCRIPTION
:screen:af_counter_meter		Selects AF Counter Meter Screen.
:screen:analyzer		Selects Analyzer Screen.
:screen:annunciator		Selects Annunciator Screen.
:screen:audio		Selects Audio Function Generator Test Screen.
:screen:audio_level_meter		Selects Audio Level Meter Screen.
:screen:audio_setup		Selects Audio Function Generator Setup Screen.
:screen:date_time_config		Selects Date/Time Screen.
:screen:diagnostic_tests		Selects Diagnostic Screen.
:screen:distortion_meter		Selects Distortion Meter Screen.
:screen:duplex_test		Selects Duplex Test Screen.
:screen:duplex_test_setup		Selects Duplex Test Setup Screen.
:screen:hwconfig		Selects HW Config Screen.
:screen:options		Selects Options Screen.
:screen:receiver_test		Selects Receiver Test Screen.
:screen:receiver_test_setup		Selects Receiver Test Setup Screen.
:screen:remote_config		Selects Remote Screen.
:screen:scope		Selects Oscilloscope Screen.
:screen:self_test		Selects Self Test Screen.
:screen:sinad_meter		Selects Sinad Meter Screen.
:screen:swr_test		Selects ANT-Cable Test Screen.
:screen:trackgen		Selects Tracking Generator Screen.
:screen:transmitter_test		Selects Transmitter Test Screen.
:screen:transmitter_test_setup		Selects Transmitter Test Setup Screen.
:screen:unitcopy		Selects Unit Copy Screen.
:screen:usbmanager		Selects USB Manager Screen.
:screen:version		Selects Version Screen.

C-4. REMOTE OPERATION COMMANDS (cont)

Scripting

COMMAND	RANGE	DESCRIPTION
:scripting:alarm	0 to 1000 ms	Sets the duration of the Alarm.
:scripting:checkkey?		Returns Key Code.
:scripting:dialog:close		Closes an open Dialog Box.
:scripting:dialog:create		Creates a Dialog Box.
:scripting:entry:idle	xpos (top left corner) ypos (top left corner) 1 to 16 (size)	Create a box on a Dialog Screen to input data and creates two Soft Keys ("ESC" and "DONE"). "ESC" returns an empty string. "DONE" returns the inputted data. Size is the number of characters to be read.
:scripting:event:enable	1 to 5 Lua Command	Sets the event for the Soft Key to a Lua Command.
:scripting:event:idle		Waits for Key Event.
:scripting:event:idle:dcib		Waits for Key Event without closing Dialog Box.
:scripting:exit		Signals the end of a running script.
:scripting:getkey?		Returns Key Code
:scripting:log:print		Prints diagnostic messages to the console via PPC RS-232. The PPC RS-232 uses a fixed setting of 115200N81.
:scripting:meter:clear		Clears Meters on a Screen.
:scripting:meter:enable		Enables Meters on a Screen.
:scripting:meter:place	<position> Meter Name	Places Meters on a Screen.
:scripting:rci:cmd		Sends RCI Command.
:scripting:rci:resp		Returns RCI Response.
:scripting:rs232:close		Closes the RS-232 connection.
:scripting:rs232:config	Baud Rate: 1200, 2400, 4800, 9600, 19200, 38400, 57600, 115200, 230400 Byte Size: 5, 6, 7, 8 Parity: 0 (no parity), 1 (even parity), 2 (odd parity), 3 (space parity) Stop Bits: 1, 2 Crtscts: 0 (flow off), 1 (flow on) Timeout: Integer Term: Terminating character in hex format	Configures the RS-232 Connector.
:scripting:rs232:open		Opens the RS-232 connection.
:scripting:rs232:pacewrite	<string> in ms (pause time)	Writes to RS-232 Connector, pausing between each character.
:scripting:rs232:read		Reads in from RS-232 until the term character is reached or timeout occurs.

C-4. REMOTE OPERATION COMMANDS (cont)

Scripting (cont)

COMMAND	RANGE	DESCRIPTION
:scripting:rs232:readsize		Reads Number of Characters in RS-232 Buffer.
:scripting:rs232:wait	<string> <timeout>	Waits until the given string is read.
:scripting:rs232:write	<string>	Writes to RS-232 Connector.
:scripting:screen		Returns to the Scripts Screen.
:scripting:screen:print	X_VAL Y_VAL "String"	Prints the given string to the given x,y coordinates on the Dialog Box.
:scripting:screen:print:invert		Prints the given string to the given x,y coordinates on the Dialog Box with Inverted Colors.
:scripting:screen:box		Prints a Box to the Scripting Dialog.
:scripting:screen:image		Prints "xmb" file to a Dialog Box.
:scripting:screen"image:noinvert		Prints "xmb" file to a Dialog Box without color.
:scripting:screen rectangle		Prints a Rectangle to the Scripting Dialog.
:scripting:sleep	in ms	Sets the Sleep time. For time >1 minute, the Sleep time is truncated to 1 minute.
:scripting:softkey:clear		Clears all the Soft Key Labels.
:scripting:softkey:label	1 to 5 Label Name	Sets the Soft Key Label.

C-4. REMOTE OPERATION COMMANDS (cont)

Setup

COMMAND	RANGE	DESCRIPTION
:setup:battery:overload?		Returns battery overload condition.
:setup:battery:remaining?	0 to 99	Returns battery remaining charge capacity.
:setup:database:usb:save		Archives database and transfer file to attached USB flash drive.
:setup:database:usb:recall		Retrieves archive database from USB and restores calcs.
:setup:date:cal:new	Day, Month, Year	Writes next Calibration Date into RTC
:setup:date:cal_due?		Returns next Calibration Date.
:setup:date:current?		Returns the current date.
:setup:date:new	Day, Month, Year	Sets date in RTC.
:setup:ftp:database:recall		Retrieves archive database from FTP and restores calcs.
:setup:ftp:database:save		Archives database and transfers file to FTP server.
:setup:ftp:password		Sets password for FTP server login.
:setup:ftp:password?		Returns password for FTP server login.
:setup:ftp:filepath		Sets path to files on FTP server.
:setup:ftp:filepath?		Returns path to files on FTP server.
:setup:ftp:server		Sets user name for FTP server login.
:setup:ftp:server?		Returns user name for FTP server login.
:setup:ftp:user	10, 10, 10, 193 (10.10.10.193)	Sets Ethernet address of FTP server.
:setup:ftp:user?		Returns Ethernet address of FTP server.
:setup:logkeys:state		Sets login key presses status.
:setup:logkeys:state?		Returns login key presses status.
:setup:mod_source:more	0 - GEN1 and GEN 2 1 - DCS 2 - DTMF 3 - P25	Sets Modulation Source tile tab to a specified tab.
:setup:piezo:alarm	1 - <> Hz 2 - <> Hz 3 - <> ms 4 - <> ms	Sets alarm for a specified duration using two specified frequencies and a rate that the frequencies oscillate back and forth.
:setup:piezo:alarm:mute		Sets alarm mute ON/OFF.
:setup:piezo:alarm:state		Sets alarm state ON/OFF.
:setup:piezo:keyclick		Enables tone on each keypad key press.
:setup:piezo:keyclick?		Returns state of key click.
:setup:piezo:tone		Sets tone for a specified duration using a specified frequency.
:setup:piezo:tone:mute		Sets tone mute ON/OFF.
:setup:piezo:tone:state		Sets tone state ON/OFF.
:setup:powerdown		Enables power down function when timeout timer expires.
:setup:powerdown?		Returns power down function state.
:setup:ppcram:free?		Returns PowerPC free RAM value.
:setup:ppcram:total?		Returns PowerPC total RAM value.
:setup:ppcflash:free?		Returns PowerPC free Flash value.
:setup:ppcflash:total?		Returns PowerPC total Flash value.
:setup:ptt:35xx		Sets PTT ON/OFF.
:setup:ptt:hw?	0 - Aeroflex Mic 1 - H-250 Mic 2 - Headset Mic 3 - Aeroflex Breakout Box	Returns PTT hardware.

C-4. REMOTE OPERATION COMMANDS (cont)

Setup (cont)

COMMAND	RANGE	DESCRIPTION
:setup:rec:more	0 - Ext Atten dB 1 - Cable Offset Preamp	Sets Receiver tile tab to a specified tab.
:setup:rem:in13?		Returns Remote input on Pin 13.
:setup:rem:in14?		Returns Remote input on Pin 14.
:setup:rem:in28?		Returns Remote input on Pin 28.
:setup:rem:in40?		Returns Remote input on Pin 40.
:setup:rem:inall		Returns Remote input on all 4 input pins.
:setup:rem:out15		Sets Remote output on Pin 15.
:setup:rem:out29		Sets Remote output on Pin 29.
:setup:rem:out30		Sets Remote output on Pin 30.
:setup:rem:out41		Sets Remote output on Pin 41.
:setup:report:clear		Clears report.txt file.
:setup:screen:default		Restores current screen settings to default settings.
:setup:screen:default:all		Restores all screens to default settings.
:setup:screen:save		Saves current screen settings to Flash Memory.
:setup:screen:save:status?	1 - Triggered 2 - Started 3 - Completed	Returns save status.
:setup:sleeptime		Sets timeout timer time in minutes.
:setup:sleeptime?		Returns timeout timer time in minutes.
:setup:temp:battery?		Returns battery temperature in degrees.
:setup:temp:internal?		Returns FPGA temperature in degrees.
:setup:temp:remote?		Returns I ² C temperature in degrees.
:setup:time:active?		Returns total time unit has been powered on.
:setup:time:current?		Returns Time.
:setup:time:new	Hours, Minutes, Seconds	Writes Time into RTC.
:setup:version:coldfire?		Returns ColdFire Application Code version number.
:setup:version:cfmacaddr?		Returns ColdFire MAC address.
:setup:version:cpld:digital?		Returns CPLD Digital version number.
:setup:version:cpld:rf?		Returns CPLD RF version number.
:setup:version:fpga?		Returns FPGA version number.
:setup:version:mf_hdw?		Returns Multi-Function PCB Assy version number.
:setup:version:powerpc?		Returns PPC Application Code version number.
:setup:version:rf_hdw?		Returns RF hardware version number (FPGA).

C-4. REMOTE OPERATION COMMANDS (cont)

Signaling

COMMAND	RANGE	DESCRIPTION
:signaling:dcs:disable		Disables DCS Encode (immediate stop).
:signaling:dcs:getcode?		Returns DCS Encode Code.
:signaling:dcs:getpolarity?		Returns DCS Encode Polarity.
:signaling:dcs:setcode	(DCS Code in Decimal)	Sets DCS Encode Code (i.e., Enter 19 for DCS Code 023).
:signaling:dcs:setpolarity	0 - Non-Inverted 1 - Inverted	Sets DCS Encode Polarity.
:signaling:dcs:start		Starts DCS Encode.
:signaling:dcs:state	0 - OFF 1 - ON	Sets DCS Encode State.
:signaling:dcs:turnoff		Disables DCS Encode (200 ms delay).
:signaling:dtmf:decode:idle	0.0 to 100.0 sec	Sets DTMF Decode Idle.
:signaling:dtmf:decode:idle?		Returns DTMF Decode Idle.
:signaling:dtmf:decode:lastmessage?		Returns last complete DTMF message decoded.
:signaling:dtmf:decode:message?		Returns current DTMF Message being decoded.
:signaling:dtmf:decode:state	0 - OFF 1 - ON	Sets DTMF Decode State.
:signaling:dtmf:decode:state?		Returns DTMF Decode State.
:signaling:dtmf:encode:idle	0.0 to 100.0 sec	Sets DTMF Encode Idle.
:signaling:dtmf:encode:idle?		Returns DTMF Encode Idle.
:signaling:dtmf:encode:mark	0 to 1000 ms	Sets DTMF Encode Mark.
:signaling:dtmf:encode:mark?		Returns DTMF Encode Mark.
:signaling:dtmf:encode:message	Up to 20 valid DTMF Tones	Sets DTMF Encode Message.
:signaling:dtmf:encode:message?		Returns DTMF Encode Message.
:signaling:dtmf:encode:oneshot		Transmits DTMF Encode Message Only Once. (Valid only when DTMF Encode Space is set to OFF.)
:signaling:dtmf:encode:space	0 to 1000 ms	Sets DTMF Encode Space.
:signaling:dtmf:encode:space?		Returns DTMF Encode Space.
:signaling:dtmf:encode:state	0 - OFF 1 - ON	Sets DTMF Encode State.
:signaling:dtmf:encode:state?		Returns DTMF Encode State.

C-4. REMOTE OPERATION COMMANDS (cont)

Signal Strength

COMMAND	RANGE	DESCRIPTION
:sigstr:state?		Returns signal strength state.
:sigstr:meas:clearpeak		Clears signal strength peak.
:sigstr:meas:newpeak?		Returns new signal strength state based on sample count.
:sigstr:meas:peak?		Returns current signal strength peak after cleared peak.
:sigstr:meas:sample		Sets number of samples to check for new signal strength peak.
:sigstr:meas:sample?		Returns number of samples to check for new signal strength peak.
:sigstr:meas:currsamples?		Returns number of samples searched through for new signal strength peak.

C-4. REMOTE OPERATION COMMANDS (cont)

Sinad Meter

COMMAND	RANGE	DESCRIPTION
:sinad:demod:alarm:high:limit	0.0 to 60.0 dB	Sets Alarm high limit value.
:sinad:demod:alarm:high:limit?		Returns Alarm high limit value.
:sinad:demod:alarm:high:state		Sets Alarm high limit state.
:sinad:demod:alarm:high:state?		Returns Alarm high limit state.
:sinad:demod:alarm:low:limit	0.0 to 60.0 dB	Sets Alarm low limit value.
:sinad:demod:alarm:low:limit?		Returns Alarm low limit value.
:sinad:demod:alarm:low:state		Sets Alarm low limit state.
:sinad:demod:alarm:low:state?		Returns Alarm low limit state.
:sinad:demod:average	1 to 99	Sets number of readings to average.
:sinad:demod:average?		Returns number of readings to average.
:sinad:demod:reading:avg?	0.0 to 60.0 dB	Returns Sinad Meter reading with averaged value.
:sinad:demod:reading:clear		Clear Sinad Meter reading.
:sinad:demod:reading:max?	0.0 to 60.0 dB	Returns Sinad Meter reading maximum value.
:sinad:demod:reading:min?	0.0 to 60.0 dB	Returns Sinad Meter reading minimum value.
:sinad:demod:reading:val?	0.0 to 60.0 dB	Returns Sinad Meter average value.
:sinad:demod:state		Activates Sinad Meter on demod input.
:sinad:demod:state?		Returns Sinad Meter state on demod input.
:sinad:ext_aud_in:alarm:high:limit	0.0 to 60.0 dB	Sets Alarm high limit value.
:sinad:ext_aud_in:alarm:high:limit?		Returns Alarm high limit value.
:sinad:ext_aud_in:alarm:high:state		Sets Alarm high limit state.
:sinad:ext_aud_in:alarm:high:state?		Returns Alarm high limit state.
:sinad:ext_aud_in:alarm:low:limit	0.0 to 60.0 dB	Sets Alarm low limit value.
:sinad:ext_aud_in:alarm:low:limit?		Returns Alarm low limit value.
:sinad:ext_aud_in:alarm:low:state		Sets Alarm low limit state.
:sinad:ext_aud_in:alarm:low:state?		Returns Alarm low limit state.
:sinad:ext_aud_in:average	1 to 99	Sets number of readings to average.
:sinad:ext_aud_in:average?		Returns number of readings to average.
:sinad:ext_aud_in:filter	0 - No Filter 1 - 15 kHz LP 2 - 300 Hz to 3 kHz BP	Sets audio filter status.
:sinad:ext_aud_in:filter?		Returns audio filter status.
:sinad:ext_aud_in:reading:avg?	0.0 to 60.0 dB	Returns Sinad Meter reading with averaged value.
:sinad:ext_aud_in:reading:clear		Clear Sinad Meter reading.
:sinad:ext_aud_in:reading:max?	0.0 to 60.0 dB	Returns Sinad Meter reading maximum value.
:sinad:ext_aud_in:reading:min?	0.0 to 60.0 dB	Returns Sinad Meter reading minimum value.
:sinad:ext_aud_in:reading:val?	0.0 to 60.0 dB	Returns Sinad Meter average value.
:sinad:ext_aud_in:state		Activates Sinad Meter on ext audio input.
:sinad:ext_aud_in:state?		Returns Sinad Meter state on ext audio input.
:sinad:fgen:alarm:high:limit	0.0 to 60.0 dB	Sets Alarm high limit value.
:sinad:fgen:alarm:high:limit?		Returns Alarm high limit value.

C-4. REMOTE OPERATION COMMANDS (cont)

Sinad Meter (cont)

COMMAND	RANGE	DESCRIPTION
:sinad:fgen:alarm:high:state		Sets Alarm high limit state.
:sinad:fgen:alarm:high:state?		Returns Alarm high limit state.
:sinad:fgen:alarm:low:limit	0.0 to 60.0 dB	Sets Alarm low limit value.
:sinad:fgen:alarm:low:limit?		Returns Alarm low limit value.
:sinad:fgen:alarm:low:state		Sets Alarm low limit state.
:sinad:fgen:alarm:low:state?		Returns Alarm low limit state.
:sinad:fgen:average	1 to 99	Sets number of readings to average.
:sinad:fgen:average?		Returns number of readings to average.
:sinad:fgen:reading:avg?	0.0 to 60.0 dB	Returns Sinad Meter reading with averaged value.
:sinad:fgen:reading:clear		Clear Sinad Meter reading.
:sinad:fgen:reading:max?	0.0 to 60.0 dB	Returns Sinad Meter reading maximum value.
:sinad:fgen:reading:min?	0.0 to 60.0 dB	Returns Sinad Meter reading minimum value.
:sinad:fgen:reading:val?	0.0 to 60.0 dB	Returns Sinad Meter average value.
:sinad:fgen:state		Activates Sinad Meter on function generator input.
:sinad:fgen:state?		Returns Sinad Meter state on function generator input.
:sinad:range?		Returns Sinad Meter range information.
:sinad:range:auto		Sets Sinad Meter autorange state to Auto.
:sinad:range>manual		Sets Sinad Meter autorange state to Manual.
:sinad:range:state?	0 - Auto 1 - Manual 2 - Manual - Waiting Update	Returns Sinad Meter autorange state.

Speaker

COMMAND	RANGE	DESCRIPTION
:speaker:level:squelch:level	-150 to 50	Sets speaker level squelch level.
:speaker:level:squelch:level?		Returns speaker level squelch level.
:speaker:noise:squelch:level	0 to 100	Sets speaker noise squelch level.
:speaker:noise:squelch:level?		Returns speaker noise squelch level.
:speaker:source	0 - EXT_AUD_IN_2_SPEAKER 1 - DEMOD_2_SPEAKER 2 - MODULATION_2_SPEAKER 3 - FGEN_2_SPEAKER	Selects signal source.
:speaker:source?		Returns speaker input source.
:speaker:state	ON or OFF	Turns speaker output ON/OFF.
:speaker:state?		Returns speaker output state.
:speaker:volume	0 to 100	Sets speaker volume.
:speaker:volume?		Returns speaker volume.

C-4. REMOTE OPERATION COMMANDS (cont)

Spectrum Analyzer

COMMAND	RANGE	DESCRIPTION
:analyzer:avg	1 to 99	Sets Spectrum Analyzer average.
:analyzer:avg?		Returns Spectrum Analyzer average.
:analyzer:current:avg?	0 to 99	Returns number of traces for current Spectrum Analyzer trace reading.
:analyzer:freq	2 to 1000 MHz	Sets Spectrum Analyzer center frequency.
:analyzer:freq?		Returns Spectrum Analyzer center frequency.
:analyzer:marker:freq	2 to 1000 MHz	Sets Spectrum Analyzer marker center frequency.
:analyzer:marker:freq?		Returns Spectrum Analyzer marker center frequency.
:analyzer:psd	0 - Spectrum 1 - Power Spectral Density	Sets Spectrum Analyzer power spectral density.
:analyzer:psd?		Returns Spectrum Analyzer power spectral density.
:analyzer:peakhold	0 - OFF 1 - ON	Activates Spectrum Analyzer peak hold.
:analyzer:peakhold?		Returns Spectrum Analyzer peak hold status.
:analyzer:pwrbandspan	1000 Hz 2000 Hz 5000 Hz 10000 Hz 20000 Hz 50000 Hz 100000 Hz 200000 Hz 500000 Hz 1000000 Hz 2000000 Hz 5000000 Hz	Sets Spectrum Analyzer power bandwidth span.
:analyzer:pwrbandspan?		Returns Spectrum Analyzer power bandwidth span.
:analyzer:reading:bwpower?	in dBm	Returns Spectrum Analyzer bandwidth power.
:analyzer:reading:rbwe?	in Hz	Returns Spectrum Analyzer resolution bandwidth equivalent.
:analyzer:sleep	10000 to 500000 μ s	Sets Spectrum Analyzer sleep time.
:analyzer:sleep?		Returns Spectrum Analyzer sleep time.
:analyzer:span	10000 Hz 20000 Hz 50000 Hz 100000 Hz 200000 Hz 500000 Hz 1000000 Hz 2000000 Hz 5000000 Hz	Sets Spectrum Analyzer span.
:analyzer:span?		Returns Spectrum Analyzer span.
:analyzer:state		Activates Spectrum Analyzer signal processing.
:analyzer:state?		Returns Spectrum Analyzer signal processing state.
:analyzer:trace:amplitude?		Returns Spectrum Analyzer trace amplitude.
:analyzer:trace:frequency?		Returns Spectrum Analyzer trace frequency.

C-4. REMOTE OPERATION COMMANDS (cont)

Spectrum Analyzer (cont)

COMMAND	RANGE	DESCRIPTION
:analyzer:trace:length	0 - 768 1 - 256 2 - 180 3 - 128 4 - 90	Sets Spectrum Analyzer graph width.
:analyzer:trace:length?		Returns Spectrum Analyzer graph width.
:analyzer:trace:points?		Returns Spectrum Analyzer graph points.
:analyzer>window	0 - HANNING 1 - FLATTOP 2 - RECTANGULAR 3 - BLACKMAN	Sets Spectrum Analyzer window size.
:analyzer>window?		Returns Spectrum Analyzer window size.

C-4. REMOTE OPERATION COMMANDS (cont)

Tracking Generator

COMMAND	RANGE	DESCRIPTION
:trackgen:state		Activates Tracking Generator signal processing.
:trackgen:state?		Returns Tracking Generator signal processing state.
:trackgen:type	0 - Live 1 - Diff	Sets Tracking Generator type.
:trackgen:type?		Returns Tracking Generator type.
:trackgen:scale	0 - 2 dB/Div 1 - 5 dB/Div 2 - 10 dB/Div 3 - 15 dB/Div 4 - 20 dB/Div	Sets Tracking Generator scale.
:trackgen:scale?		Returns Tracking Generator scale.
:trackgen:setref		Sets Tracking Generator reference.
:trackgen:setreflvl	-70 dBm -60 dBm -50 dBm -40 dBm -30 dBm -20 dBm -10 dBm 0 dBm 10 dBm	Sets Tracking Generator reference level.
:trackgen:setreflvl?		Returns Tracking Generator reference level.
:trackgen:freq	2 to 1000 MHz	Sets Tracking Generator frequency.
:trackgen:freq?		Returns Tracking Generator frequency.
:trackgen:start	2 to 1000 MHz	Sets Tracking Generator start frequency.
:trackgen:start?		Returns Tracking Generator start frequency.
:trackgen:stop	2 to 1000 MHz	Sets Tracking Generator stop frequency.
:trackgen:stop?		Returns Tracking Generator stop frequency.
:trackgen:span	0 - 10 kHz 1 - 20 kHz 2 - 50 kHz 3 - 100 kHz 4 - 200 kHz 5 - 500 kHz 6 - 1 MHz 7 - 2 MHz 8 - 5 MHz 9 - 10 MHz 10 - 20 MHz 11 - 50 MHz 12 - 100 MHz 13 - 200 MHz 14 - 500 MHz 15 - 998 MHz	Sets Tracking Generator span.
:trackgen:span?		Returns Tracking Generator span.

C-4. REMOTE OPERATION COMMANDS (cont)

Upconverter

COMMAND	RANGE	DESCRIPTION
:upconverter:carrier_state		Acts as a PTT. Needs to be ON for normal Generator operation.
:upconverter:carrier_state?		Returns carrier state.
:upconverter:dcs:am	0% to 100%	Sets Modulator DCS AM level.
:upconverter:dcs:fm	0.0 to 100.0 kHz	Sets Modulator DCS FM level.
:upconverter:dcs:state		Sets Modulator DCS Signaling State.
:upconverter:dtmf:am:high	0% to 100%	Sets Modulator DTMF AM high level.
:upconverter:dtmf:am:low	0% to 100%	Sets Modulator DTMF AM low level.
:upconverter:dtmf:fm:high	0.0 to 100.0 kHz	Sets Modulator DTMF FM high level.
:upconverter:dtmf:fm:low	0.0 to 100.0 kHz	Sets Modulator DTMF FM low level.
:upconverter:ext_aud_in:gain	0.0 to 1.0	Sets Modulator External Audio Input Raw Scaling.
:upconverter:ext_aud_in:state		Sets Modulator External Audio Input State.
:upconverter:fgen1:am	0% to 100%	Sets Modulator fgen #1 AM level.
:upconverter:fgen1:fm	0.0 to 100.0 kHz	Sets Modulator fgen #1 FM level.
:upconverter:fgen1:freq	0 to 24000 Hz	Sets Modulator fgen #1 frequency.
:upconverter:fgen1:gain	0.0 to 1.0	Sets Modulator fgen #1 Raw Scaling.
:upconverter:fgen1:state		Sets Modulator fgen #1 ON/OFF.
:upconverter:fgen2:am	0% to 100%	Sets Modulator fgen #2 AM level.
:upconverter:fgen2:fm	0.0 to 100.0 kHz	Sets Modulator fgen #2 FM level.
:upconverter:fgen2:freq	0 to 24000 Hz	Sets Modulator fgen #2 frequency.
:upconverter:fgen2:gain	0.0 to 1.0	Sets Modulator fgen #2 Raw Scaling.
:upconverter:fgen2:state		Sets Modulator fgen #2 ON/OFF.
:upconverter:mic:am	0% to 100%	Sets Modulator Microphone AM level.
:upconverter:mic:fm	0.0 to 100.0 kHz	Sets Modulator Microphone FM level.
:upconverter:mic:gain	0.0 to 1.0	Sets Modulator Microphone State.
:upconverter:mic:select?		Returns the Microphone connected.
:upconverter:mic:state		Sets Modulator Microphone State.
:upconverter:mod_inhibit		Disables modulation for one-time calibrations.
:upconverter:mod_inhibit?		Returns modulation inhibit state.
:upconverter:route:enable		Sets Modulator ON/OFF.
:upconverter:sde:am	0% to 100%	Sets SDE AM level.
:upconverter:sde:fm	0.0 to 100.0 kHz	Sets SDE FM level.
:upconverter:sde:gain	0.0 to 1.0	Sets SDE Gain ffff Scaling.
:upconverter:sde:state		Sets SDE State ON/OFF.
:upconverter:type	0 - AM 1 - FM 2 - None 3 - P25 4 - SDE-AM 5 - SDE-FM 6 - Invalid	Sets Modulator type.
:upconverter:type?		Returns Modulator type.

C-4. REMOTE OPERATION COMMANDS (cont)

VSWR Meter

COMMAND	RANGE	DESCRIPTION
:vswr:cable:len		Estimates cable length to measure.
:vswr:cablelength2span?	in feet	Returns Cable Length to Span.
:vswr:cable:loss	in dB	Sets cable attenuation per 100 feet.
:vswr:cable:velocity	[0.0, 1.0]	Sets cable velocity factor.
:vswr:cal:save		Saves Calibration data.
:vswr:cal:recall		Recalls Calibration data.
:vswr:complete?	0% to 100%	Returns the progress of the sweep through the selected bandwidth.
:vswr:freq		Sets center frequency.
:vswr:freq?		Returns center frequency.
:vswr:marker:delta	1 to 3	Sets Delta Marker.
:vswr:marker:delta:x?	1 to 3	Returns marker delta number at x axis.
:vswr:marker:delta:y?	1 to 3	Returns marker delta number at y axis.
:vswr:marker:enable	1 to 3	Enables Marker.
:vswr:marker:left	1 to 3	Moves marker to the left.
:vswr:marker:lmin	1 to 3	Moves marker to next left min.
:vswr:marker:lpk	1 to 3	Moves marker to next left peak.
:vswr:marker:max	1 to 3	Moves marker to maximum.
:vswr:marker:min	1 to 3	Moves marker to minimum.
:vswr:marker:pos		Sets horizontal position of current Marker.
:vswr:marker:right	1 to 3	Moves marker to the right.
:vswr:marker:rpk	1 to 3	Moves marker to next right peak.
:vswr:marker:rmin	1 to 3	Moves marker to next right min.
:vswr:marker:x?	1 to 3	Returns marker number at x axis.
:vswr:marker:y?	1 to 3	Returns marker number at y axis.
:vswr:meas:type	0 - SWR 1 - DTF 2 - RL 3 - LOSS 4 - Calibration 5 - Raw	Selects type of measurement.
:vswr:meas:type?		Returns type of measurement.
:vswr:postprocess	0 - INVALID_CIRCUIT 1 - OPEN_CIRCUIT 2 - SHORT_CIRCUIT 3 - FIFTY_OHM_CIRCUIT 4 - LOAD_CIRCUIT	Sets Post Process state.
:vswr:runmode	0 - RESULT_INVALID 1 - REQUEST_RUNNING 2 - RUNNING 3 - STOPPED 4 - REQUEST_STOP	Sets Run mode.
:vswr:scale	1 - Top 2 - Bottom	Sets scale for vertical.
:vswr:size?	2 to 512	Returns SWR trace length.
:vswr:span		Sets span.
:vswr:span?		Returns span.
:vswr:span2cablelength?	in MHz	Returns Calculated Span to Cable Length.
:vswr:start		Sets start frequency.
:vswr:start?		Returns start frequency.
:vswr:startswEEP		Starts sweep.

C-4. REMOTE OPERATION COMMANDS (cont)

VSWR Meter (cont)

COMMAND	RANGE	DESCRIPTION
:vswr:state	0 - RESULT_INVALID 1 - REQUEST_RUNNING 2 - RUNNING 3 - STOPPED 4 - REQUEST_STOP	Sets VSWR state.
:vswr:state?		Returns VSWR state.
:vswr:stop		Sets stop frequency.
:vswr:stop?		Returns stop frequency.
:vswr:stopsweep		Stops sweep.
:vswr:trace:count?	0 to 4294967295	Returns trace count of each trace completed then counts increments.
:vswr:trace:dtf?	0 to trace size minus one -50 to 0 dB	Returns DTF trace values by index. (See :vswr:size? command.)
:vswr:trace:loss?	0 to trace size minus one -5 to 0 dB	Returns LOSS trace values by index. (See :vswr:size? command.)
:vswr:trace:rtn_loss?	0 to trace size minus one -5 to 0 dB	Returns Return Loss trace values by index. (See :vswr:size? command.)
:vswr:trace:size?	2 to 512	Returns SWR trace length.
:vswr:trace:vswr?	0 to trace size minus one SWR: 1 to 6	Returns SWR trace values by index. (See :vswr:size? command.)
:vswr:trace:vswr_dump?		Returns VSWR trace values.
:vswr:units	0 - Feet 1 - Meters	Sets the units of measure.
:vswr:val?	0 to trace size minus one SWR: 1 to 6	Returns SWR trace values by index. (See :vswr:size? command.)

THIS PAGE INTENTIONALLY LEFT BLANK.

INDEX

A		F	
Abbreviations	B-1	Features	1-3
Accessories		Function Generator	2-76
Optional Items	xiii	Functions, Other	2-85
Standard Items	viii	Recall Configuration Screen	2-85
Advanced Vehicle Installation Testing	2-96	Save Configuration Screen	2-86
AF Counter Screen	2-49	Fuse Replacement (Procedure)	3-11
Annunciator Setup Screen	2-60		
ANT-Cable Test Screen	2-31	G	
ARIBT98 Option	4-49	General Information	1-1
Digital Receive Screen	4-51	Nomenclature Cross-Reference List	1-1
ARIBT98 Mini-Meter	4-49	Scope	1-1
Features / Functions	4-50		
AUDIO Connector Pin-Out Table		H	
3500	A-3	Handle Replacement (Procedure)	3-14
3500A	A-4	HW Config Setup Screen	2-68
Audio Function Generator Test Screen	2-40		
Audio Level Meter Screen	2-51	I	
		I/O Connectors	
		3500	A-1
		3500A	A-2
		Icons, Screen	2-6
		L	
		Loading Software w/ USB Memory Device	2-112
B			
Battery			
Precautions	3-2		
Recharging (Procedure)	3-7		
Replacement (Procedure)	3-8		
Bumper Replacement (Procedure)	3-16		
C			
Calibration Screen	2-58		
Capabilities	1-2		
Cautions, Screen Warnings and	2-90		
Checking Unpacked Equipment	3-1		
Connector Pin-Out Tables			
AUDIO Connector Pin-Out Table			
3500	A-3		
3500A	A-4		
I/O Connectors			
3500	A-1		
3500A	A-2		
REMOTE Connector Pin-Out Table			
3500	A-5		
3500A	A-6		
Controls, Indicators and Connectors	2-1		
D			
Date / Time Screen	2-67		
DCS Decode Meter	2-74		
Diagnostic Screen	2-55		
Distortion Meter Screen	2-47		
DMR Option	4-35		
Digital Receive Screen	4-35		
DMR Mini-Meter	4-36		
Features / Functions	4-37		
dPMR Option	4-45		
Digital Receive Screen	4-45		
dPMR Mini-Meter	4-46		
Features / Functions	4-47		
DTMF Decode Meter	2-75		
Duplex Test Screen	2-9		
E			
Environment	3-17		
Equipment Capabilities and Features	1-2		
Capabilities	1-2		
Features	1-3		
Equipment Data	1-4		

M

Maintenance Procedures	3-7
Battery Recharging	3-7
Battery Replacement	3-8
Bumper Replacement	3-16
Fuse Replacement	3-11
Handle Replacement	3-14
Measuring	
DTF	2-102
Reverse Power	2-108
SWR	2-97
Menu Configurations, Operation Screens and	2-7
Meters Menu	2-44
AF Counter Screen	2-49
Audio Level Meter Screen	2-51
Distortion Meter Screen	2-47
SINAD Meter Screen	2-45
Screen Icons	2-6
Self Test Menu	2-53
Calibration Screen	2-58
Diagnostic Screen	2-55
Self Test Screen	2-54
System Menu	2-8
ANT-Cable Test Screen	2-31
Audio Function Generator Test Screen	2-40
Duplex Test Screen	2-9
Receiver Test Screen	2-18
Transmitter Test Screen	2-26
Utilities Menu	2-59
Annunciator Setup Screen	2-60
Date / Time Screen	2-67
HW Config Setup Screen	2-68
Options Screen	2-70
Remote Setup Screen	2-61
Unit Copy Screen	2-72
USB Manager Screen	2-71
Version Screen	2-66
Menu / Screen Hierarchy	2-5
Meters Menu	2-44
AF Counter Screen	2-49
Audio Level Meter Screen	2-51
Distortion Meter Screen	2-47
SINAD Meter Screen	2-45
Meters / Functions, Other	2-73
DCS Decode Meter	2-74
DTMF Decode Meter	2-75
Function Generator	2-76
Modulation Meter Screen	2-77
RF Error Meter Screen	2-79
RF Power Meter Screen	2-81
RSSI Meter Screen	2-83
Modulation Meter Screen	2-77

N

Nomenclature Cross-Reference List	1-1
NXDN Option	4-41
Digital Receive Screen	4-41
NXDN Mini-Meter	4-42
Features / Functions	4-43

O

Operating Instructions	2-1
Operating Procedures	2-96
Advanced Vehicle Installation Testing	2-96
Introduction	2-91
Loading Software w/ USB Memory Device	2-112
Measuring DTF	2-102
Measuring Reverse Power	2-108
Measuring SWR	2-97
Typical Vehicle Installation Test	2-92
Operation Screens and Menu Configurations	2-7
Meters Menu	2-44
AF Counter Screen	2-49
Audio Level Meter Screen	2-51
Distortion Meter Screen	2-47
SINAD Meter Screen	2-45
Screen Icons	2-6
Self Test Menu	2-53
Calibration Screen	2-58
Diagnostic Screen	2-55
Self Test Screen	2-54
System Menu	2-8
ANT-Cable Test Screen	2-31
Audio Function Generator Test Screen	2-40
Duplex Test Screen	2-9
Receiver Test Screen	2-18
Transmitter Test Screen	2-26
Utilities Menu	2-59
Annunciator Setup Screen	2-60
Date / Time Screen	2-67
HW Config Setup Screen	2-68
Options Screen	2-70
Remote Setup Screen	2-61
Unit Copy Screen	2-72
USB Manager Screen	2-71
Version Screen	2-66
Operation Under Usual Conditions	2-88
Screen Warnings and Cautions	2-90
Turn-On Procedure	2-88
Options	
ARIBT98	4-49
DMR	4-35
dPMR	4-45
Installing	4-2
NXDN	4-41
Oscilloscope	4-15
P25 Test	4-31
Scripting	4-53
Spectrum Analyzer	4-3
Tracking Generator	4-23
Options Screen	2-70
Oscilloscope Option	4-15
Oscilloscope Screen	4-15
Features / Functions	4-16
Other Functions	2-85
Recall Configuration Screen	2-85
Save Configuration Screen	2-86
Other Meters / Functions	2-73
DCS Decode Meter	2-74
DTMF Decode Meter	2-75
Function Generator	2-76
Modulation Meter Screen	2-77
RF Error Meter Screen	2-79
RF Power Meter Screen	2-81
RSSI Meter Screen	2-83

P		R	
P25 Test Option	4-31	Recall Configuration Screen	2-85
Digital Receive Screen	4-33	Receiver Test Screen	2-18
P25 Mini-Meter	4-31	REMOTE Connector Pin-Out Table	
Features / Functions	4-32	3500	A-5
Packaging	3-17	3500A	A-6
Preliminary Servicing and Adjustment of		Remote Operation	C-1
Equipment	3-2	Commands	
Preparation for Storage or Shipment	3-17	AF Counter	C-9
Packaging	3-17	AGC	C-10
Environment	3-17	Audio Level Meter	C-11
Preventive Maintenance Checks and Services	2-87	C4FSK	C-13
General	2-87	Calibration	C-16
Preventive Maintenance Procedures	2-87	DCS Decode	C-17
Routine Checks	2-87	Demod	C-18
Schedule of Checks	2-87	Deviation Meter / Modulation Meter	C-19
Tools, Materials and Equipment	2-87	Distortion Meter	C-20
Principles of Operation		External Audio Input	C-21
3500	1-15	External Audio Output	C-22
3500A	1-16	Frequency Find	C-22
		Function Generator	C-22
		Normalize	C-23
		Oscilloscope	C-24
		Options	C-25
		Receiver	C-26
		RF Error Meter	C-26
		RF Generator	C-27
		RF Power Meter	C-28
		RSSI Meter	C-30
		Screens	C-31
		Scripting	C-32
		Setup	C-34
		Signaling	C-36
		Signal Strength	C-37
		Sinad Meter	C-38
		Speaker	C-39
		Spectrum Analyzer	C-40
		Tracking Generator	C-42
		Upconverter	C-43
		VSWR Meter	C-44
		Configuration	
		Ethernet	C-2
		RS-232	C-6
		Connection	C-1
		Remote Setup Screen	2-61
		RF Error Meter Screen	2-79
		RF Power Meter Screen	2-81
		RSSI Meter Screen	2-83

S	
Schedule of Checks	2-87
Scope	1-1
Screen Icons	2-6
Screen / Menu Hierarchy	2-5
Screens and Menu Configurations, Operation	2-5
Meters Menu	2-44
AF Counter Screen	2-49
Audio Level Meter Screen	2-51
Distortion Meter Screen	2-47
SINAD Meter Screen	2-45
Screen Icons	2-6
Self Test Menu	2-53
Calibration Screen	2-58
Diagnostic Screen	2-55
Self Test Screen	2-54
System Menu	2-8
ANT-Cable Test Screen	2-31
Audio Function Generator Test Screen	2-40
Duplex Test Screen	2-9
Receiver Test Screen	2-18
Transmitter Test Screen	2-26
Utilities Menu	2-59
Annunciator Setup Screen	2-60
Date / Time Screen	2-67
HW Config Setup Screen	2-68
Options Screen	2-70
Remote Setup Screen	2-61
Unit Copy Screen	2-72
USB Manager Screen	2-71
Version Screen	2-66
Screen Warnings and Cautions	2-90
Scripting Option	4-53
Copy Scripts with Unit Copy Screen	4-57
General Scripting Commands	4-58
Scripting Flowcharts	4-59
Audio	4-59
Receiver	4-61
Transmitter	4-62
Scripts Screen	4-53
Features / Functions	4-54
Transfer Scripts to the 3500 / 3500A	4-55
Self Test Menu	2-53
Calibration Screen	2-58
Diagnostic Screen	2-55
Self Test Screen	2-54
Self Test Screen	2-54
Service Upon Receipt	vii, 3-1
Preliminary Servicing and Adjustment	3-2
Optional Items	xiii
Service Upon Receipt of Material	3-1
Checking Unpacked Equipment	3-1
Unpacking	3-1
Standard Items	viii
SINAD Meter Screen	2-45
Spectrum Analyzer Option	4-3
Spectrum Analyzer Screen	4-4
Features / Functions	4-5
Symptom Index (Troubleshooting)	3-3
System Menu	2-8
ANT-Cable Test Screen	2-31
Audio Function Generator Test Screen	2-40
Duplex Test Screen	2-9
Receiver Test Screen	2-18
Transmitter Test Screen	2-26

T	
Tools, Materials and Equipment Required	2-87
Tracking Generator Option	4-23
Tracking Generator Screen	4-23
Features / Functions	4-24
Transmitter Test Screen	2-26
Troubleshooting	3-3
Symptom Index	3-3
Troubleshooting Table	3-4
Turn-On Procedure	2-88
Typical Vehicle Installation Test	2-92

U	
Unpacking	3-1
USB Manager Screen	2-71
Utilities Menu	2-59
Annunciator Setup Screen	2-60
Date / Time Screen	2-67
HW Config Setup Screen	2-68
Options Screen	2-70
Remote Setup Screen	2-61
USB Manager Screen	2-71
Version Screen	2-66

V	
Vehicle Installation Test	
Advanced Vehicle Installation Testing	2-96
Typical Vehicle Installation Test	2-92
Version Screen	2-66

W	
Warnings and Cautions, Screen	2-90

As we are always seeking to improve our products, the information in this document gives only a general indication of the product capacity, performance and suitability, none of which shall form part of any contract. We reserve the right to make design changes without notice.

CHINA / Beijing	Tel: [+86] (10) 6539 1166	Fax: [+86] (10) 6539 1778
CHINA / Shanghai	Tel: [+86] (21) 5109 5128	Fax: [+86] (21) 6457 7668
FINLAND	Tel: [+358] (9) 2709 5541	Fax: [+358] (9) 804 2441
FRANCE	Tel: [+33] 1 60 79 96 00	Fax: [+33] 1 60 77 69 22
GERMANY	Tel: [+49] 8131 2926-0	Fax: [+49] 8131 2926-130
HONG KONG	Tel: [+852] 2832 7988	Fax: [+852] 2834 5364
INDIA	Tel: [+91] (0) 80 4115 4501	Fax: [+91] (0) 80 4115 4502
JAPAN	Tel: [+81] 3 3500 5591	Fax: [+81] 3 3500 5592
KOREA	Tel: [+82] (2) 3424 2719	Fax: [+82] (2) 3424 8620
SCANDINAVIA	Tel: [+45] 9614 0045	Fax: [+45] 9614 0047
*SINGAPORE	Tel: [+65] 6873 0991	Fax: [+65] 6873 0992
SPAIN	Tel: [+34] (91) 640 11 34	Fax: [+34] (91) 640 06 40
UK / Cambridge	Tel: [+44] (0) 1763 262277	Fax: [+44] (0) 1763 285353
*UK / Stevenage	Tel: [+44] (0) 1438 742200	Fax: [+44] (0) 1438 727601
	Freephone: 0800 282388	
*USA	Tel: [+1] (316) 522 4981	Fax: [+1] (316) 522 1360
	Toll Free: 800 835 2352	

* Indicates Regional Service Center



EXPORT CONTROL WARNING: This document contains controlled technology or technical data under the jurisdiction of the Export Administration Regulations (EAR), 15 CFR 730-774. It cannot be transferred to any foreign third party without the specific prior approval of the U.S. Department of Commerce, Bureau of Industry and Security (BIS). Violations of these regulations are punishable by fine, imprisonment, or both.



Our passion for performance is defined by three attributes represented by these three icons: solution-minded, performance-driven, customer-focused.