

---

**ADVANTEST**<sup>®</sup>  
ADVANTEST CORPORATION

---

**R3753 SERIES**  
**NETWORK ANALYZER**  
**OPERATION MANUAL**

MANUAL NUMBER OED00 9607

---

*Applicable Instruments*

**R3753A**  
**R3753B**  
**R3753E**

Before reselling to other corporations  
or re-exporting to other countries, you  
are required to obtain permission from  
both the Japanese Government under its  
Export Control Act.

www.valuetronics.com

## Safety Summary

To ensure thorough understanding of all functions and to ensure efficient use of this instrument, please read the manual carefully before using. Note that Advantest bears absolutely no responsibility for the result of operations caused due to incorrect or inappropriate use of this instrument.

If the equipment is used in a manner not specified by Advantest, the protection provided by the equipment may be impaired.

- **Warning Labels**

Warning labels are applied to Advantest products in locations where specific dangers exist. Pay careful attention to these labels during handling. Do not remove or tear these labels. If you have any questions regarding warning labels, please ask your nearest Advantest dealer. Our address and phone number are listed at the end of this manual.

Symbols of those warning labels are shown below together with their meaning.

**DANGER:** Indicates an imminently hazardous situation which will result in death or serious personal injury.

**WARNING:** Indicates a potentially hazardous situation which will result in death or serious personal injury.

**CAUTION:** Indicates a potentially hazardous situation which will result in personal injury or a damage to property including the product.

- **Basic Precautions**

Please observe the following precautions to prevent fire, burn, electric shock, and personal injury.

- Use a power cable rated for the voltage in question. Be sure however to use a power cable conforming to safety standards of your nation when using a product overseas.
- When inserting the plug into the electrical outlet, first turn the power switch OFF and then insert the plug as far as it will go.
- When removing the plug from the electrical outlet, first turn the power switch OFF and then pull it out by gripping the plug. Do not pull on the power cable itself. Make sure your hands are dry at this time.
- Before turning on the power, be sure to check that the supply voltage matches the voltage requirements of the instrument.
- Connect the power cable to a power outlet that is connected to a protected ground terminal. Grounding will be defeated if you use an extension cord which does not include a protected ground terminal.
- Be sure to use fuses rated for the voltage in question.
- Do not use this instrument with the case open.
- Do not place anything on the product and do not apply excessive pressure to the product. Also, do not place flower pots or other containers containing liquid such as chemicals near this

product.

- When the product has ventilation outlets, do not stick or drop metal or easily flammable objects into the ventilation outlets.
- When using the product on a cart, fix it with belts to avoid its drop.
- When connecting the product to peripheral equipment, turn the power off.

• **Caution Symbols Used Within this Manual**

Symbols indicating items requiring caution which are used in this manual are shown below together with their meaning.

**DANGER:** Indicates an item where there is a danger of serious personal injury (death or serious injury).

**WARNING:** Indicates an item relating to personal safety or health.

**CAUTION:** Indicates an item relating to possible damage to the product or instrument or relating to a restriction on operation.

• **Safety Marks on the Product**

The following safety marks can be found on Advantest products.



: ATTENTION - Refer to manual.



: Protective ground (earth) terminal.



: DANGER - High voltage.



: CAUTION - Risk of electric shock.

• **Replacing Parts with Limited Life**

The following parts used in the instrument are main parts with limited life.

Replace the parts listed below before their expected lifespan has expired to maintain the performance and function of the instrument.

Note that the estimated lifespan for the parts listed below may be shortened by factors such as the environment where the instrument is stored or used, and how often the instrument is used.

The parts inside are not user-replaceable. For a part replacement, please contact the Advantest sales office for servicing.

Each product may use parts with limited life.

For more information, refer to the section in this document where the parts with limited life are described.

## Main Parts with Limited Life

Part name	Life
Unit power supply	5 years
Fan motor	5 years
Electrolytic capacitor	5 years
LCD display	6 years
LCD backlight	2.5 years
Floppy disk drive	5 years
Memory backup battery	5 years

- **Hard Disk Mounted Products**

The operational warnings are listed below.

- Do not move, shock and vibrate the product while the power is turned on. Reading or writing data in the hard disk unit is performed with the memory disk turning at a high speed. It is a very delicate process.
- Store and operate the products under the following environmental conditions.
  - An area with no sudden temperature changes.
  - An area away from shock or vibrations.
  - An area free from moisture, dirt, or dust.
  - An area away from magnets or an instrument which generates a magnetic field.
- Make back-ups of important data.
  - The data stored in the disk may become damaged if the product is mishandled. The hard disc has a limited life span which depends on the operational conditions. Note that there is no guarantee for any loss of data.

- **Precautions when Disposing of this Instrument**

When disposing of harmful substances, be sure dispose of them properly with abiding by the state-provided law.

Harmful substances: (1) PCB (polycarbon biphenyl)  
 (2) Mercury  
 (3) Ni-Cd (nickel cadmium)  
 (4) Other

Items possessing cyan, organic phosphorous and hexadic chromium and items which may leak cadmium or arsenic (excluding lead in solder).

Example: fluorescent tubes, batteries

# Environmental Conditions

This instrument should be only be used in an area which satisfies the following conditions:

- An area free from corrosive gas
- An area away from direct sunlight
- A dust-free area
- An area free from vibrations
- Altitude of up to 2000 m

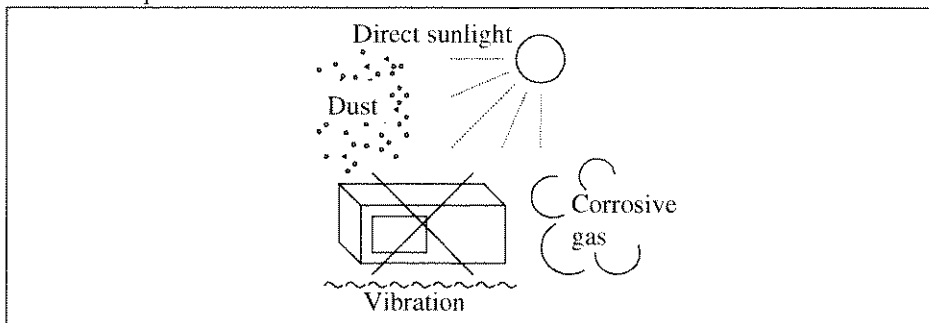

**Figure-1 Environmental Conditions**

- Operating position

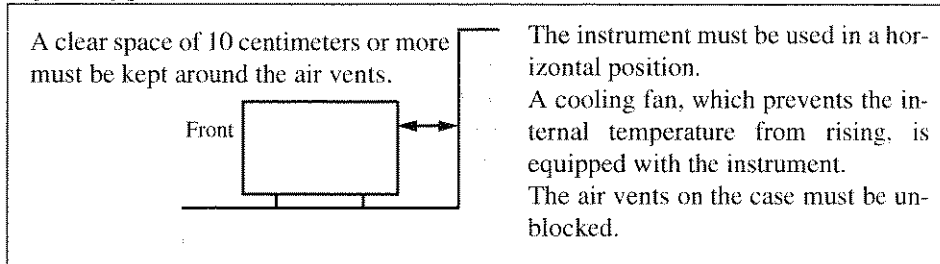

**Figure-2 Operating Position**

- Storage position

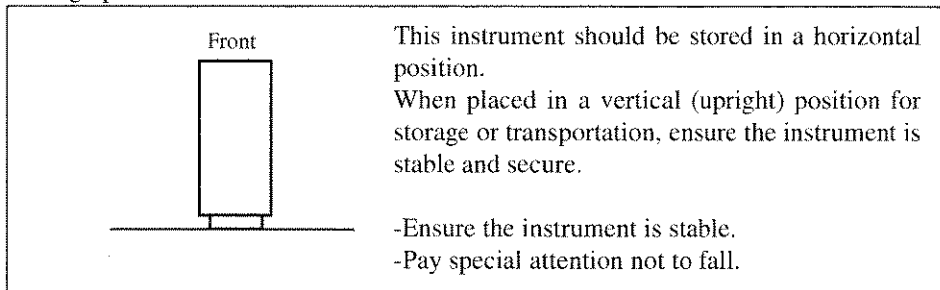

**Figure-3 Storage Position**





- The classification of the transient over-voltage, which exists typically in the main power supply, and the pollution degree is defined by IEC61010-1 and described below.

Impulse withstand voltage (over-voltage) category II defined by IEC60364-4-443

Pollution Degree 2

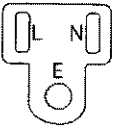
## Types of Power Cable

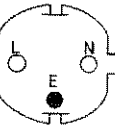
Replace any references to the power cable type, according to the following table, with the appropriate power cable type for your country.

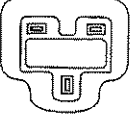
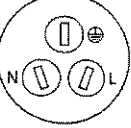
Plug configuration	Standards	Rating, color and length	Model number (Option number)
	PSE: Japan Electrical Appliance and Material Safety Law	125 V at 7 A Black 2 m (6 ft)	Straight: A01402 Angled: A01412
	UL: United States of America CSA: Canada	125 V at 7 A Black 2 m (6 ft)	Straight: A01403 (Option 95) Angled: A01413
	CEE: Europe DEMKO: Denmark NEMKO: Norway VDE: Germany KEMA: The Netherlands CEBEC: Belgium OVE: Austria FIMKO: Finland SEMKO: Sweden	250 V at 6 A Gray 2 m (6 ft)	Straight: A01404 (Option 96) Angled: A01414
	SEV: Switzerland	250 V at 6 A Gray 2 m (6 ft)	Straight: A01405 (Option 97) Angled: A01415
	SAA: Australia, New Zealand	250 V at 6 A Gray 2 m (6 ft)	Straight: A01406 (Option 98) Angled: -----
	BS: United Kingdom	250 V at 6 A Black 2 m (6 ft)	Straight: A01407 (Option 99) Angled: A01417
	CCC: China	250 V at 10 A Black 2 m (6 ft)	Straight: A114009 (Option 94) Angled: A114109

.....



## Table of Power Cable Options

There are six power cable options (refer to following table).

Order power cable options by Model number.

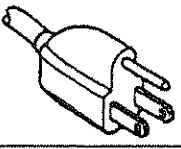
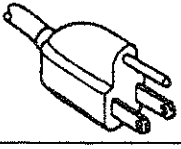
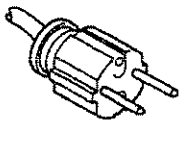
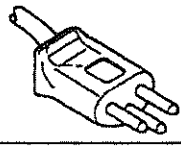
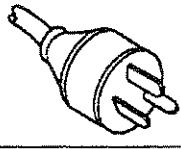
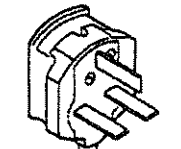
	Plug configuration	Standards	Rating, color and length	Model number (Option number)
1		JIS: Japan Law on Electrical Appliances	125 V at 7 A Black 2 m (6 ft)	Straight: A01402 Angled: A01412
2		UL: United States of America CSA: Canada	125 V at 7 A Black 2 m (6 ft)	Straight: A01403 (Option 95) Angled: A01413
3		CEE: Europe DEMKO: Denmark NEMKO: Norway VDE: Germany KEMA: The Netherlands CEBEC: Belgium OVE: Austria FIMKO: Finland SEMKO: Sweden	250 V at 6 A Gray 2 m (6 ft)	Straight: A01404 (Option 96) Angled: A01414
4		SEV: Switzerland	250 V at 6 A Gray 2 m (6 ft)	Straight: A01405 (Option 97) Angled: A01415
5		SAA: Australia, New Zealand	250 V at 6 A Gray 2 m (6 ft)	Straight: A01406 (Option 98) Angled: -----
6		BS: United Kingdom	250 V at 6 A Black 2 m (6 ft)	Straight: A01407 (Option 99) Angled: A01417

.....

## PREFACE

### In the Beginning

This book explains all processes from the acceptance to actually operation of network analyzer R3753 series. The manual of two volumes related about the R3753 series is shown in the following.

Manual	Outline	Remarks
1. R3753 series Network analyzer Operating Manual (this book)	The following of the R3753 series is explained. <ul style="list-style-type: none"><li>• Method of operation</li><li>• Explanation of function</li><li>• Measurement method</li><li>• Notes on use etc.</li></ul>	Standard attachment
2. R3752/3753 series Programming manual (separate volume)	GPIB and built-in BASIC is explained.	Standard attachment

### Caution

ADVANTEST reserves the right to change the content of this book and other product information without notice.

Do not reproduce and do not reprint all of this book or part without permission ADVANTEST Corporation. The address and the telephone number of ADVANTEST Corporation are described in the end of this book. Refer for the inquiry etc.

## Confirmation of Product and Attachment

When you open packing, confirms the following in the beginning.

If any flaw, damage, and shortage in the product or the attachment, etc., is found, contact the nearest dealer or the sales and support office.

### (1) Product main unit

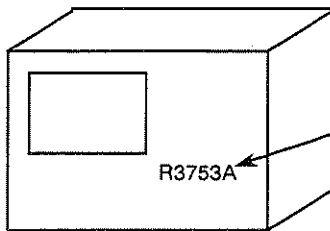

Confirmation position of type and name of product.

Confirm the product the same as the order from the name plate in the front panel.

### (2) Standard attachment lists.

(Note) Order the addition of the attachment etc. with type name or stock No.

Name of articles.	Type name	Parts code	Quantity	Remarks
Power cable	A01402	DCB-DD2428X01	1	3pins plug
		JCD-AL003EX03	1 <sup>*1</sup>	AC adapter
BNC-BNC cable	—	DCB-FF4894X01	2	30cm
	—	DCB-FF4894X04	1	60cm
BNC though connector	BNC-A-JJ	JCF-AB001EX05	1	
Fuse	—	DFT-AA6R3A	2	T6.3A/250V
Operating Manual	—	JR3753	1 <sup>*2</sup>	Japanese
	—	ER3753		English
Programming manual	—	JR3752/3753(P)	1 <sup>*2</sup>	Japanese
	—	ER3752/3753(P)		English

(Note) <sup>\*1</sup>: The AC adaptor is a standard attachment only to Japan-domestic.

<sup>\*2</sup>: Japanese or English is one volume.

## To be Going to Use it Safely

Fulfill undermentioned caution to use R3753 correctly and safely. ADVANTEST Corporation cannot owe responsibility and the guarantee of the trouble caused by use in contradiction to this caution.

(1) The following marks are attached to the product to use R3753 safely.



: This is a mark of the meaning of caution.

The thing to have to refer to Operating Manual is shown to protect human body and instrument.



: It is an earth symbol.

The field wiring terminal for which the earth is necessary is shown before instrument is used to prevent the electric shock.

(2) Do the following caution to prevent the danger to the human body such as the electric shock accidents.

- Power supply voltage:  
Confirm the power supply voltage of R3753 is corresponding to the supply voltage before power-on.
- Fuse:  
Use the fuse of the standard that conforms power supply voltage.
- Power cable:
  - Power cable of a standard attachment conforms to The Law of the Management of Electric Articles of Japan.
  - Case in which use of R3753 in foreign country, use power cable in accordance with the safety standard of each country.
  - When you connect power cable with the outlet, turn off the power switch.  
Have the plug when power cable is inserted and pull out from outlet.
- Protective earth:
  - Connect power cable to the power outlet that has the protective earth terminal.
  - When the code for the extension by which the protective earth terminal is not had is used, the protection earth can not be done.
  - Case in which use of conversion adaptor made two pins from three pins, ground the earth pin of the adaptor to the earth of the outlet. Connect ground terminal of the rear panel with the earth of the outside. Moreover, attend to the contact between the adaptor and the earth pin.
- Removing of case:  
Do not open the case to one except service man of our company.

## How to read this manual

(1) Organization of this manual

Configuration		Remarks
Preface	Explanation for the caution of safety and confirmation of Read the first use of R3753.	Product attachment to the first use of R3753.
Contents	Rough configuration and the description page.	Use it to find necessary information easily.
1.	Necessary information before begins to be measured Installation - setup, cleaning, transportation, and storage. The general remarks	
2.	Explanation of display screen on panel side. Name of each device, functions and method be of operation. Description of display screen	The usage of R3753 can be understood by reading it through.
3.	Easy usage Actual example of operation	
4.	Method of operation	It is a chapter of practice.
5.	Performance test Method of confirming performance of catalog spec. of R3753	Refer if necessary.
6.	The specifications Technical information and general information	
7.	Error message	
Appendix	Initial setting Software key menu list Externals figures	
Index	Associated word and the description page	Use it to find necessary information easily.

(2) Mark of caution level in this enclosing.

 : Uses it for the case with the possibility of the body trouble and the death.

 : Uses for the remarks of safety and the health of the body.

 : Uses for the remarks of the damage of the machine equipment, fire and for the restriction of use.

(Note) : Uses to explain for the supplementation.

(3) Distinction of panel key and software key in this book.

Panel key : Shows with the key of the solid line frame enclosing.

(Example)  , 

Software key: Shows with the key of the dotted line frame enclosing.

(Example)  , 

(4) This book has the page attaching the sign of (\*) to the upper right of the pagination.

The sign of (\*) informs the final page of each chapter.

Pagination: Page number in the margin is called "pagination".

.....

.....

.....

.....



## TABLE OF CONTENTS

1. BEFORE MEASUREMENT START .....	1-1
1.1 About R3753 .....	1-1
1.1.1 Product Outline .....	1-1
1.1.2 Operations .....	1-2
1.1.3 Data Flowchart .....	1-3
1.2 Installation .....	1-4
1.3 Power Cable .....	1-5
1.3.1 The power requirement .....	1-5
1.3.2 Exchange of power fuse .....	1-5
1.3.3 Connection of power cable .....	1-6
1.4 FET Probe .....	1-8
1.5 Caution of System-up .....	1-9
1.5.1 Notes on use of Parallel I/O Port .....	1-9
1.5.2 Notes on use of Serial I/O ports .....	1-9
1.6 Cautions in Adding a Signal Exceeding Available Levels to the Input Part .....	1-9
1.7 Cautions in Setting Up an Output Power .....	1-10
1.8 Cleaning, Storage, and Transportation .....	1-10
1.9 Notes on Use .....	1-11
2. PANEL DESCRIPTION .....	2-1
2.1 Front Panel Descriptions .....	2-2
2.2 Screen Display Descriptions .....	2-5
2.3 Rear Panel Descriptions .....	2-7
3. EASY USAGE .....	3-1
3.1 Basic Operation .....	3-1
3.1.1 Necessary Key for Basic Operation .....	3-1
3.1.2 Example of Basic Key Operation .....	3-10
3.2 Measurement Example .....	3-14
3.2.1 Measurement of Filter .....	3-15
3.2.2 Phase Measurement .....	3-18
3.2.3 Measurement of Group Delay .....	3-20
3.2.4 Sweep Measurement of Narrow-band and Wide-band .....	3-22
3.2.5 Measurement of Amplitude and Phase .....	3-26
3.2.6 Measurement of Amplitude and Group Delay .....	3-28

3.2.7 Measurement of Linear Amplitude and Phase .....	3-31
3.2.8 Measurement for Dual-screen to be Displayed Simultaneously .....	3-34
3.2.9 Measurement of Reflection .....	3-38
3.2.10 Measurement of Crystal Resonator .....	3-49
3.2.11 Measurement with Multi-marker .....	3-55
3.2.12 Measurement with Delta Marker .....	3-59
3.2.13 Delta Section Marker Analysis .....	3-63
3.2.14 Measurement by Marker of → .....	3-69
3.2.15 Measurement with Coupling of Marker Interpolation Marker .....	3-72
3.2.16 Measurement in which Use of Program Sweep .....	3-75
3.2.17 Measurement of Resonance Point and Antiresonance Point of Ceramic Oscillation Element (f = 42.0MHz) .....	3-81
3.2.18 Output of Measured Data to Plotter .....	3-87
3.2.19 Storage/Reproduction of Measured Data (Saving and Recall Register) .....	3-91
3.2.20 Storage and Reproduction of Measured Data .....	3-94
4. OPERATION METHOD .....	4-1
4.1 ACTIVE CHANNEL Block .....	4-2
4.2 ENTRY Block .....	4-3
4.3 STIMULUS Block .....	4-5
4.3.1 Setting Signal Source .....	4-6
4.3.2 Interlocking between Channels .....	4-8
4.4 RESPONSE Block .....	4-9
4.4.1 Setting Input and Parameter Conversion .....	4-10
4.4.2 Display Data Format .....	4-13
4.4.3 Setting Display Coordinate Scale .....	4-15
4.4.4 Split-Screen Display and Selection of Display information .....	4-16
4.4.5 TRACE Operation .....	4-18
4.4.6 Label input .....	4-19
4.4.7 Averaging/Smoothing and Resolution Bandwidth .....	4-21
4.4.8 Selecting Input Attenuator and Input Impedance .....	4-24
4.5 Calibration .....	4-26
4.5.1 Normalizing .....	4-26
4.5.2 One Port Full Calibration .....	4-27
4.5.3 Calibration Method .....	4-29
4.5.4 Extending Measurement Reference Surface .....	4-33
4.5.5 Calibration Data Clear .....	4-39

R3753 SERIES  
NETWORK ANALYZER  
OPERATION MANUAL

Table of Contents

4.6 Marker Function .....	4-40
4.6.1 Setting Marker .....	4-41
4.6.2 Marker Coupling between Channels .....	4-43
4.6.3 Interpolation Between Measurement .....	4-44
4.6.4 Displaying Marker Read out Value .....	4-44
4.6.5 Delta-Marker Function .....	4-45
4.6.6 Marker Menu during Impedance Measurement .....	4-49
4.6.7 Marker Analysis Function .....	4-51
4.7 Sweep .....	4-57
4.7.1 Setting Sweep Type .....	4-58
4.7.2 Editing Segment of User Frequency Sweep .....	4-59
4.7.3 Editing Segment of Program Sweep .....	4-60
4.8 INSTRUMENT STATE Block .....	4-63
4.8.1 System Menu .....	4-64
4.9 GPIB Block .....	4-66
4.9.1 Controller Menu .....	4-67
4.9.2 GPIB Menu .....	4-68
4.10 Save/Recall .....	4-69
4.10.1 Selection of Save Type .....	4-69
4.10.2 Executing Save Register .....	4-70
4.10.3 Executing Store File .....	4-72
4.10.4 Setting Register Name .....	4-73
4.10.5 Setting File Name .....	4-75
4.10.6 Clearing Saved Register .....	4-76
4.10.7 Purging Stored File .....	4-77
4.10.8 Executing Recall .....	4-77
4.11 Hard Copy .....	4-80
4.11.1 Setting Plot Scale .....	4-81
4.11.2 Setting Plot Data .....	4-82
4.11.3 Specifying Pen .....	4-83
4.11.4 Plotter Setup .....	4-84
4.12 Communication with Peripheral Devices .....	4-87
4.12.1 Parallel I/O Port .....	4-87
4.12.2 RS-232 .....	4-96

R3753 SERIES  
NETWORK ANALYZER  
OPERATION MANUAL

Table of Contents

5. PERFORMANCE TEST .....	5-1
5.1 Preparing for Performance Test .....	5-1
5.2 Frequency Accuracy and Range .....	5-3
5.3 Output Level Accuracy and Flatness .....	5-4
5.4 Output Level Linearity .....	5-6
6. SPECIFICATIONS .....	6-1
7. ERROR MESSAGES .....	7-1
7.1 Hardware Trouble .....	7-1
7.2 Overloading an Input Part .....	7-2
7.3 Notice of Hardware Information .....	7-2
7.4 Operating Error .....	7-3
7.5 Warning of Internal Set, Change, etc. ....	7-8
7.6 Notice of Operating Completion, State, etc. ....	7-10
APPENDIX .....	A-1
A.1 Initial Setting .....	A-1
A.2 List of Softkey Menu .....	A-4
MENU .....	A-4
MEAS .....	A-5
FORMAT .....	A-5
SCALE .....	A-5
DISPLAY .....	A-6
AVG .....	A-6
ATT .....	A-6
CAL .....	A-7
MKR .....	A-8
MKR → .....	A-9
SAVE .....	A-10
RECALL .....	A-11
COPY .....	A-12
SYSTEM .....	A-13
RUN .....	A-14
LCL .....	A-14

R3753 SERIES  
NETWORK ANALYZER  
OPERATION MANUAL

*Table of Contents*

A.3 GPIB Command List Corresponding to Panel Key/ Softkey .....	A-15
A.3.1 ACTIVE CHANNEL Block .....	A-16
A.3.2 STIMULUS Block .....	A-16
A.3.3 RESPONSE Block .....	A-21
A.3.4 INSTRUMENT STATE Block .....	A-41
A.3.5 GPIB Block .....	A-47

EXTERNAL VIEW

R3753A EXTERNAL VIEW .....	EXT-1
R3753B EXTERNAL VIEW .....	EXT-2
R3753E EXTERNAL VIEW .....	EXT-3
R3753A FRONT VIEW .....	EXT-4
R3753B FRONT VIEW .....	EXT-5
R3753E FRONT VIEW .....	EXT-6
R3753A/B/E REAR VIEW .....	EXT-7



## 1. BEFORE MEASUREMENT START

### 1.1 About R3753

#### 1.1.1 Product Outline

R3753 series is the 500MHz vector network analyzer, which has newly been designed based on a concept "an optimum tool for each application".

We have fully pursued high throughput such as 0.1ms/points high-speed measurement at a resolution bandwidth (RBW) of 10kHz, 115dB wide dynamic-range measurement, and two-device simultaneous measurement with two-channel/four-trace display. Also, we have added the program sweeping function that can freely change the resolution bandwidth (RBW), output level, and input attenuator during sweep operation for each segment.

Since the analyzer employs semiconductor switches for changing the output level and for switching the input attenuator, it allows the optimum high-speed level sweeping for the drive level test of the oscillator.

With the built-in BASIC controller, a high-speed ATE system can be easily configured with no external controller for processes from adjustment to inspection.

#### Features

- (1) High throughput
  - 0.1ms/point high-speed frequency sweeping and 5ms short blanking time  
When two-channel /four-trace (amplitude/phase) and RBW 10kHz
  - 0.1ms/point high-speed level sweeping  
High speed and long life using semiconductor switches
- (2) Wide dynamic range
  - With automatic switching of input attenuator, 115dB wide dynamic range  
High speed and long life using semiconductor switches for switching input attenuator
- (3) Program sweeping function
  - For each segment, allows setting of frequency, output level, input attenuator, RBW, and settling time.
- (4) MS-DOS format disk
  - By using an MS-DOS personal computer, it is possible to easily create programs and analyze data because of the disk complied with MS-DOS format standard.
  - Three modes of storage capacity available (DD 720KB, HD 1.2MB, and HD 1.44MB)

### 1.1.2 Operations

(1) Signal source

The range of signal output is 5Hz to 500MHz and the range of output power is 21dBm to -63dBm.

(2) Receiver

Signals in the receiver flow as follows:

- ① 5Hz to 500MHz input signal is converted into 820kHz 1st IF signal by the 1st Mixer and transferred to the 2nd Mixer.
- ② The 1st IF signal is converted into 20kHz 2nd IF signal by the 2nd Mixer and output to the A/D circuit.
- ③ The A/D-converted data is calculated at a high speed by the digital signal processor (DSP) and displayed on the display.

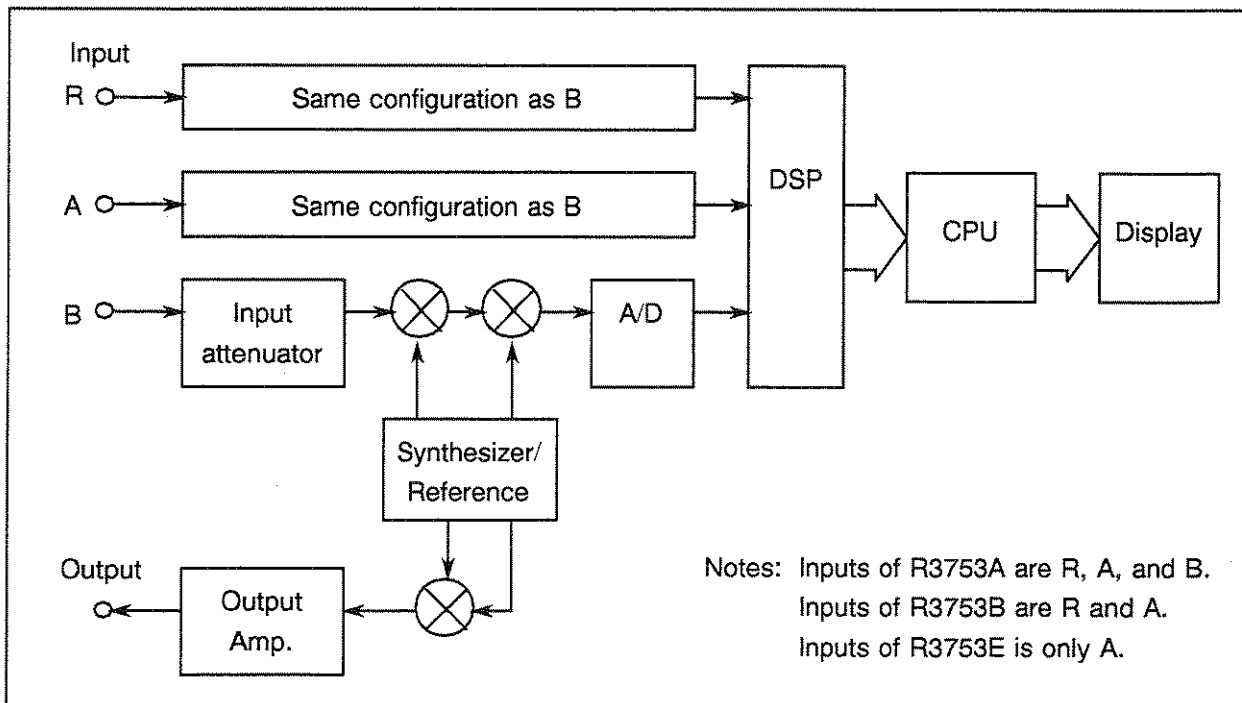

Figure 1-1 Operations at Receiver



### 1.1.3 Data Flowchart

The signal input in the receiver is processed depending on the following flowchart:

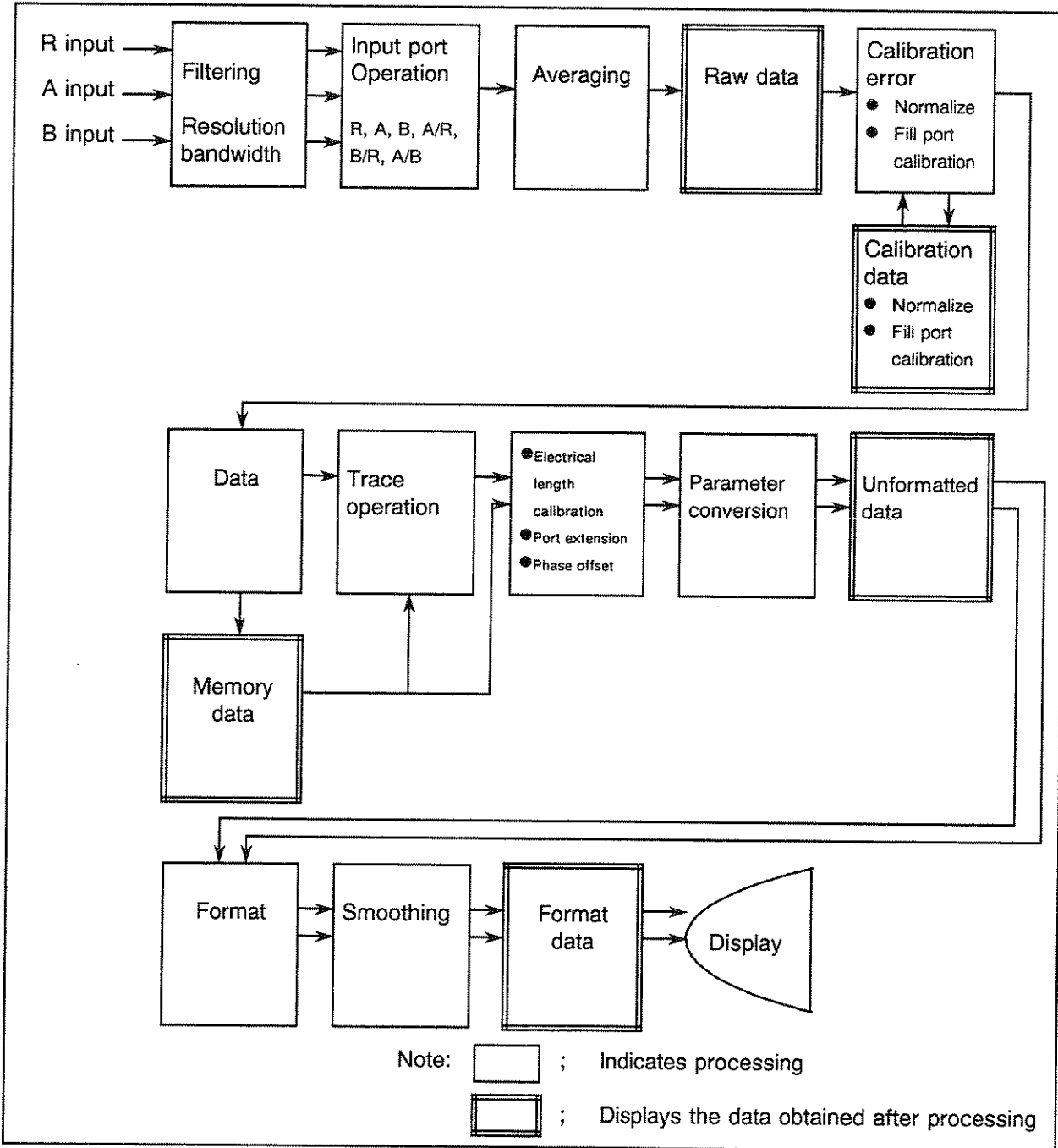

Figure 1-2 Data Flowchart

## 1.2 Installation

### (1) Utilization environment

Set R3753 in the place where the following conditions are satisfied.

- Environmental temperature: 0°C to +50°C
- Relative humidity: RH85% or less  
(Non- condensing)
- Place without exposed to direct sunshine
- Place without corroded gas
- Place without dust
- Place without vibration
- Place where there is minimum noise

As for R3753, this unit is designed for the AC power supply line noise is enough considered. However, use it in the environment without the noise as much as possible. Use the noise rejection filter or equivalent for the case that the noise is not avoided.

### (2) Installation posture

Air cooling fan of the exhaust type is built in the rear panel. Do not close this outlet.

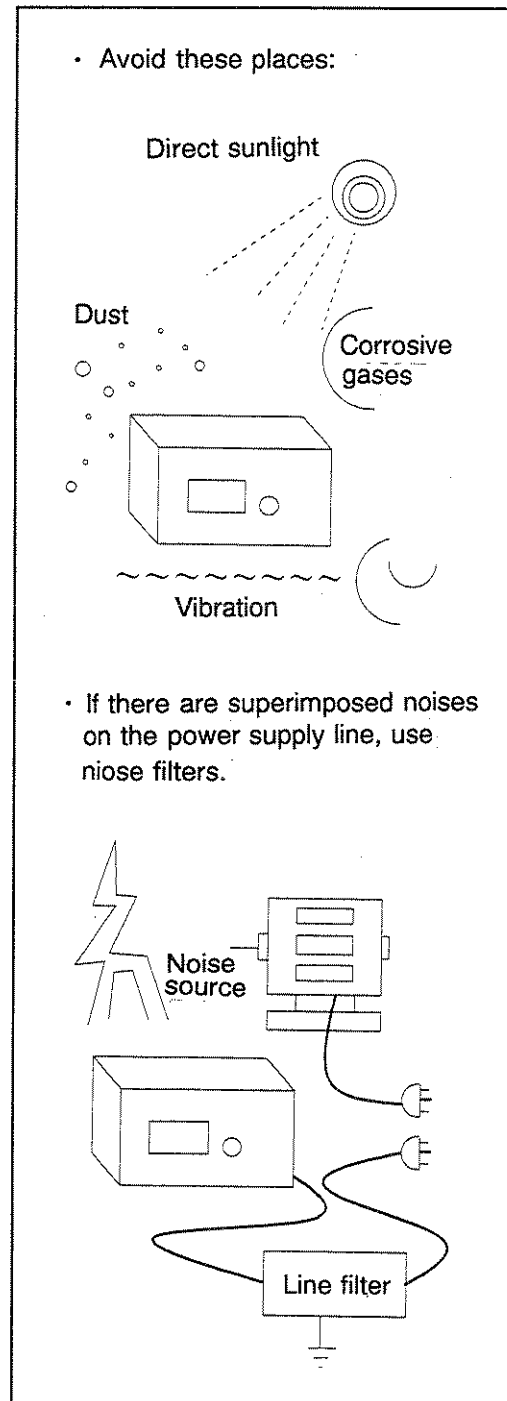

Figure 1-3 Environmental Conditions

### 1.3 Power Cable

#### 1.3.1 The power requirement

— WARNING —

Safely use R3753 according to the power requirement.  
 R3753 might be damaged to the case not following the power requirement.

The power requirement of R3753 is shown in the following.

Input voltage	100V <sub>AC</sub> operation	220V <sub>AC</sub> operation
	AC100V to 120V	AC220V to 240V
Frequency	48Hz to 66Hz	
Fuse	T6.3A/250V	
Power consumption	300VA or less	

\* : This input voltage is automatically changed between 100V<sub>AC</sub> system and 200V<sub>AC</sub> system.  
 The above input voltage is the rating of the unit. The available range of the AC power is 90-132V and 198-250V.

Use the power supply by which the power requirement of R3753 is satisfied.

#### 1.3.2 Exchange of power fuse

— WARNING —

Use the power fuse of the standard by which power supply voltage is satisfied.

The power fuse is in the power connector of the rear panel. Confirm it.  
 Confirm or exchange the power fuse as follows.

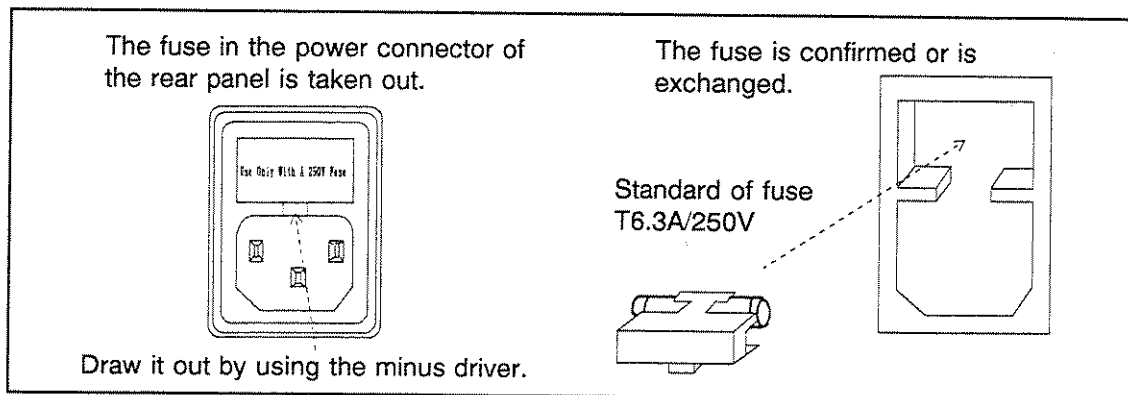

Figure 1-4 Confirmation and exchange of fuses

### 1.3.3 Connection of power cable

WARNING

1. Power cable

- Use power cable of the attachment for the electric shock and the fire prevention. A standard attachment conforms to The Management Row of the Electric Articles of Japan.
- Use power cable in accordance with the safety standard of the country for use excluding Japan.
- When you connect power cable with the outlet, turn off the power switch.
- When you pull out power cable from the outlet, have the plug.

2. Protective earth

- Connect the power plug cable with the power outlet which has the protective earth terminal.
- If the code for the extension without the protective earth terminal is used, the protective earth will become invalid.
- Case in which use of AC adaptor (Three pins to two pins conversion adaptor), the earth pin of the adaptor is grounded to the earth of the outlet, or connect ground terminal of the rear panel with the earth of the outside, and ground it to the earth.

- (1) In Japan-domestic, the electric power connector of three pins is few. Therefore the AC adaptor is attached.

The width between electrodes of the 2 line is different. After confirming the direction of the plug and the outlet, connect the adaptor when inserting it in the outlet.

Use another adaptor (KPR-13) for the case which cannot be connected with the outlet of the adaptor.

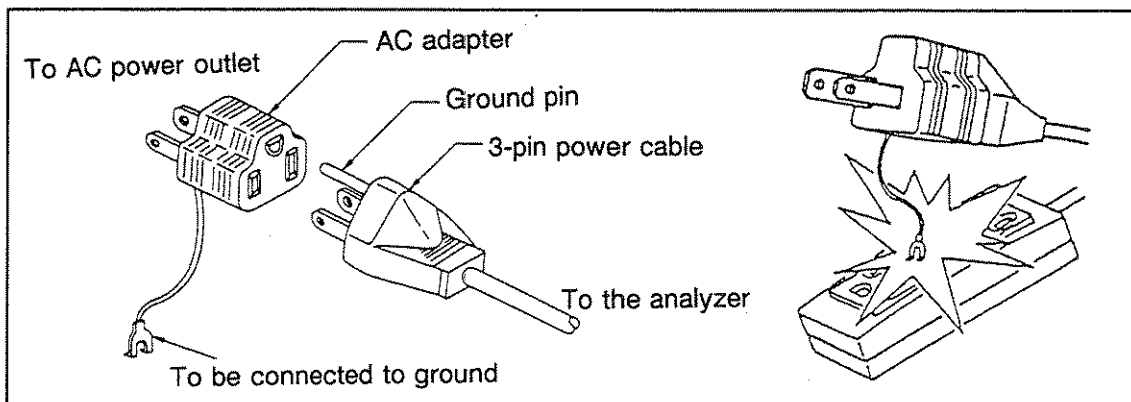

**R3753 SERIES  
NETWORK ANALYZER  
OPERATION MANUAL**

**1.3 Power Cable**

(2) The power plug in the below is sold as an option. Separately consult excluding the following.

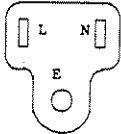
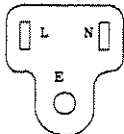
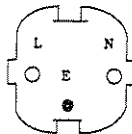
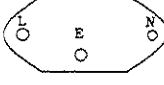
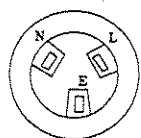
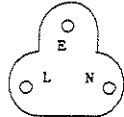
Type name	Straight type	A01402 (Standard)	A01403 (Opt.95)	A01404 (Opt.96)
	Angle type	A01412	A01413	A01414
Applicable standard		JIS: Japan Law on Electrical Appliances	UL: US CSA: Canada	*
Ratings and colors		125V/7A, Black, 2m	125V/7A, Black, 2m	250V/6A, Grey, 2m
Plug				
Type name	Straight type	A01405 (Opt.97)	A01406 (Opt.98)	A01408
	Angle type	A01415		
Applicable standard		SEV: Switzerland	SAA: Australia New Zealand	
Ratings and colors		250V/6A, Grey, 2m	250V/6A, Grey, 2m	250V/5A,
Plug				

\*  
CEE: Europe  
DEMKO: Denmark  
NEMKO: Norway  
VED: Old West  
Germany  
KEMA: Netherlands  
CEBEC: Belgium  
OVE: Austria  
FIMKO: Finland  
SEMKO: Sweden

## 1.4 FET Probe

### (1) Setup

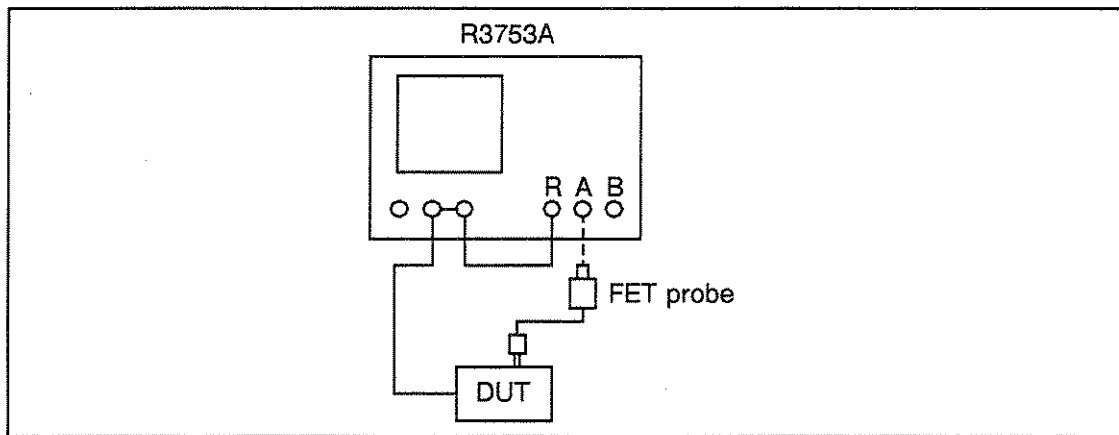

Figure 1-5 Connecting FET Probe to R3753A (Case of measurement)

### (2) Usage precautions

The stability and repeatability of the measurement value are affected by the ground of FET probe tip.

The input impedance of the FET probe is listed in the following Table. In high frequency, it is necessary to consider the effect of parallel capacity.

Model name	Input impedance	Remarks
P6201 type	100kHz $\pm$ 1% parallel 3.0PF Attenuator head 1M $\Omega$ $\pm$ 1%, 1.5PF or less in parallel.	DC to 900MHz Manufactured by SONY Tektronix
P6202A type	10M $\Omega$ $\pm$ 2%    Approx. 2PF Approx. 4PF with the optional coupling cap	DC to 500MHz Manufactured by SONY Tektronix

### (3) Calibration method

#### Operation procedure

- ① Connect the FET probe to the measurement circuit reference point.
- ② Select the calibration menu of the analyzer to normalize the frequency characteristic probe.
- ③ Connect the FET probe to the point to be measured, then perform the measurement.

Note: When measuring the point in high frequency, note that the data repeatability will be changed by the ground condition of the FET probe tip.

## 1.5 Caution of System-up

### 1.5.1 Notes on use of Parallel I/O Port

- (1) In +5 V power output from parallel I/O port, maximum current capacity is 100 mA.  
Use it within 100 mA.
- (2) In +5 V power output from parallel I/O port, there is a fuse.  
The fuse fuses with the over current of 100 mA or more.  
In the case with which the fuse fuses, contact to the nearest dealer or the sales and support offices.
- (3) Use the shield cable for the cable for parallel I/O port. (malfunction prevention by noise)
- (4) The standard of the cable for the radiation test of R3753 is MO-27.
- (5) Cautions of wiring  
Do not bundle I/O cable and the AC line.

### 1.5.2 Notes on use of Serial I/O ports

- (1) Adjust the length of the cable used for serial I/O port to 15m or less.
- (2) Use the shield cable for the cable for serial I/O port. (Malfunction prevention by noise)
- (3) The standard of the cable used for the radiation test of R3753 is A01235.
- (4) Cautions of wiring upper  
Do not bundle I/O cable and the AC line.

## 1.6 Cautions in Adding a Signal Exceeding Available Levels to the Input Part

A maximum level that can be measured at the input part is 0 dBm. (When an input attenuator is set to 20 dB)

If a signal with its level 0 dBm and more, various kinds of messages are displayed.

- (1) If a signal with its level 0 dBm or more and with its frequency 100 kHz or more is added to the input, "over load" is displayed.  
When a signal with its level less than 0 dBm and with its frequency less than 100 kHz is added to the input, "over load" is also displayed. However, the signal measurement is correctly carried out.
- (2) If a signal having much more level than (1) is added to the input, "over load trip" is displayed and the input impedance is automatically switched to 1 M $\Omega$ .  
Decrease the input level and then release the trip.  
(The level in which the input impedance is switched to 1 M $\Omega$  depends on the input frequency.)

## 1.7 Cautions in Setting Up an Output Power

It is possible to set the output power in the range of -63 dBm to +21 dBm, and a 20 dB attenuator is connected by an internal input relay at -43.1 dBm or less.

The operating life of this relay is rated at one million times.

Take care of the operating life if the relay is continuously switched.

The relay switch does not work in the output power range of +21 dBm to -43.0 dBm and of -43.1 dBm to -63.0 dBm.

## 1.8 Cleaning, Storage, and Transportation

### (1) Cleaning

Wipe the dirt of R3753 off with a soft cloth (or cloth that gets damp). At this time, attend to the following points.

Do not remain the fluff of the cloth and do not soak water into the internal of R3753.

Do not use an organic solvent (for example, benzene and acetone, etc.) which changes plastics in quality.

### (2) Storage

The cases in which R3753 is not used for a long time, cover with the vinyl cover or put in the cardboard box and prevent dust. Keep it in a dry place where dust and direct sunshine were prevented.

Storage temperature: -20 °C to +60 °C

### (3) Transportation

When you transport R3753, pack it equally to the first packing material or any more.

Packing procedure.

- ① Wrap R3753 itself with cushion material and put in the cardboard box.
- ② After putting attachment, put cushion again.
- ③ Shut the lid of the cardboard box. Fix the outside with the string or tape.



## 1.9 Notes on Use

(1) Case that abnormality occurs

When smoke rises from R3753 or the nasty smell and the allophone feel, turn off the power switch. Pull out from the outlet. And contact to our company.

The address and the telephone number of our company are in the end of this book.

(2) Electromagnetic interference.

High frequency noise of the small power is generated at R3753 use.

Therefore, the television and the radio are generated electromagnetic interference by an improper installation and use of R3753.

If R3753 is a cause of the electromagnetic interference when the power of R3753 is turned off, it will not be generated.

Prevent electromagnetic interference by the following procedure.

The power of R3753 and the power of the television and the radio use the outlet of another power.

- R3753 is set up to the other side of the television and the radio.
- R3753 is set up to a place away from the television and the radio.
- The power of R3753 and the power of the television and the radio use the outlet of another power.

MEMO 

## **2. PANEL DESCRIPTION**

The front-panel descriptions are described in section 2.1.

The front-panel screen-display descriptions are explained in section 2.2.

The rear-panel descriptions are described in section 2.3.

R3753 SERIES  
 NETWORK ANALYZER  
 OPERATION MANUAL

2.1 Front Panel Description

2.1 Front Panel Descriptions

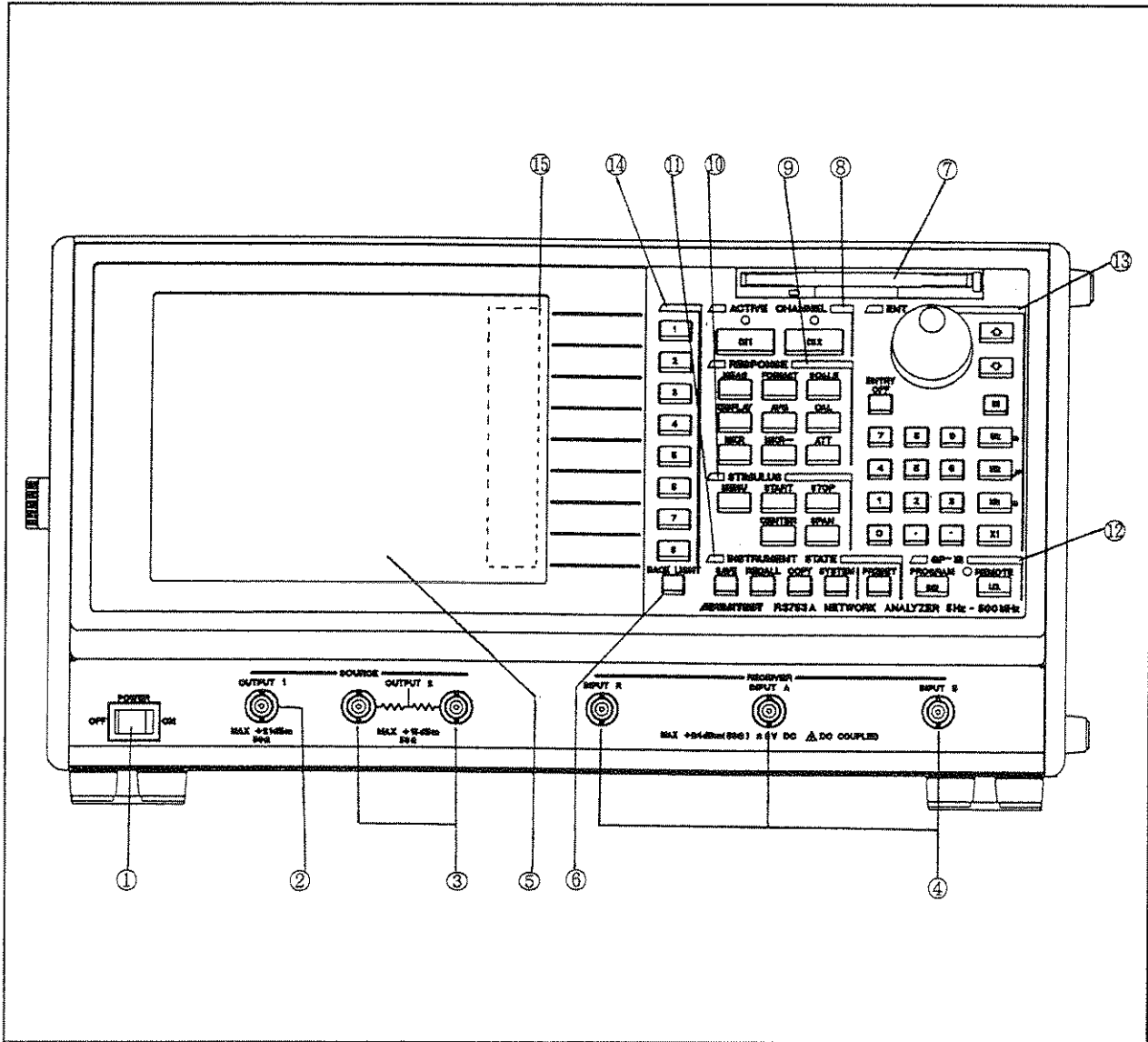

Figure 2-1 Front-Panel Descriptions (R3753A)

**R3753 SERIES  
NETWORK ANALYZER  
OPERATION MANUAL**

**2.1 Front Panel Description**

(1 of 2)

No.	Name	Description
①	POWER switch	Turns on or off the power supply of the analyzer.
②	SIGNAL SOURCE OUTPUT connector (OUTPUT1)	Single output The OUTPUT connector is used to perform a measurement by connecting 3-branch power splitter for absolute measurement or 2-device measurement.
③	SIGNAL SOURCE OUTPUT connector (OUTPUT2)	Power splitter output
④	RECEIVER SECTION INPUT connector INPUT R INPUT A INPUT B	The INPUT connector is used for reference input and measurement input. Note: The input connector differs according to analyzers. R3753A: INPUT A, B, R R3753B: INPUT A, R R3753E: INPUT A
⑤	LED display	Displays measurement data, setting conditions, and other informations.
⑥	BACK LIGHT	Selects the back light ON/OFF of LED display.
⑦	Floppy disk drive	Stores a program and measurement data. Storage capacity corresponds to three modes (DD: 720KB, HD: 1.2MB, HD: 1.44MB).
⑧	ACTIVE CHANNEL block	The ACTIVE CHANNEL block is used to select an active channel between independently two measurement channels. After selecting, functions to be operated are provided for the selected active channel only.
⑨	RESPONSE block	The RESPONSE block is used to set measurement conditions of receiver section, data display, and data analysis.
⑩	STIMULUS block	The STIMULUS block is used to set signal source frequencies and level sweep conditions.
⑪	INSTRUMENT STATE block	The INSTRUMENT STATE block is used set the system functions which have no concern with the measurement.
⑫	GPIB block	The GPIB block is used to set a GPIB and controller functions.

**R3753 SERIES  
NETWORK ANALYZER  
OPERATION MANUAL**

**2.1 Front Panel Description**

(2 of 2)

No.	Name	Description
⑬	ENTRY block	The ENTRY block is used to input numeric data and to perform a marker movement.
⑭	Soft keys	Selects the soft key menu described in ⑮ in each function block.
⑮	Soft key menu	Displays each function menu. To select a menu, use the soft key described in ⑭.

2.2 Screen Display Descriptions

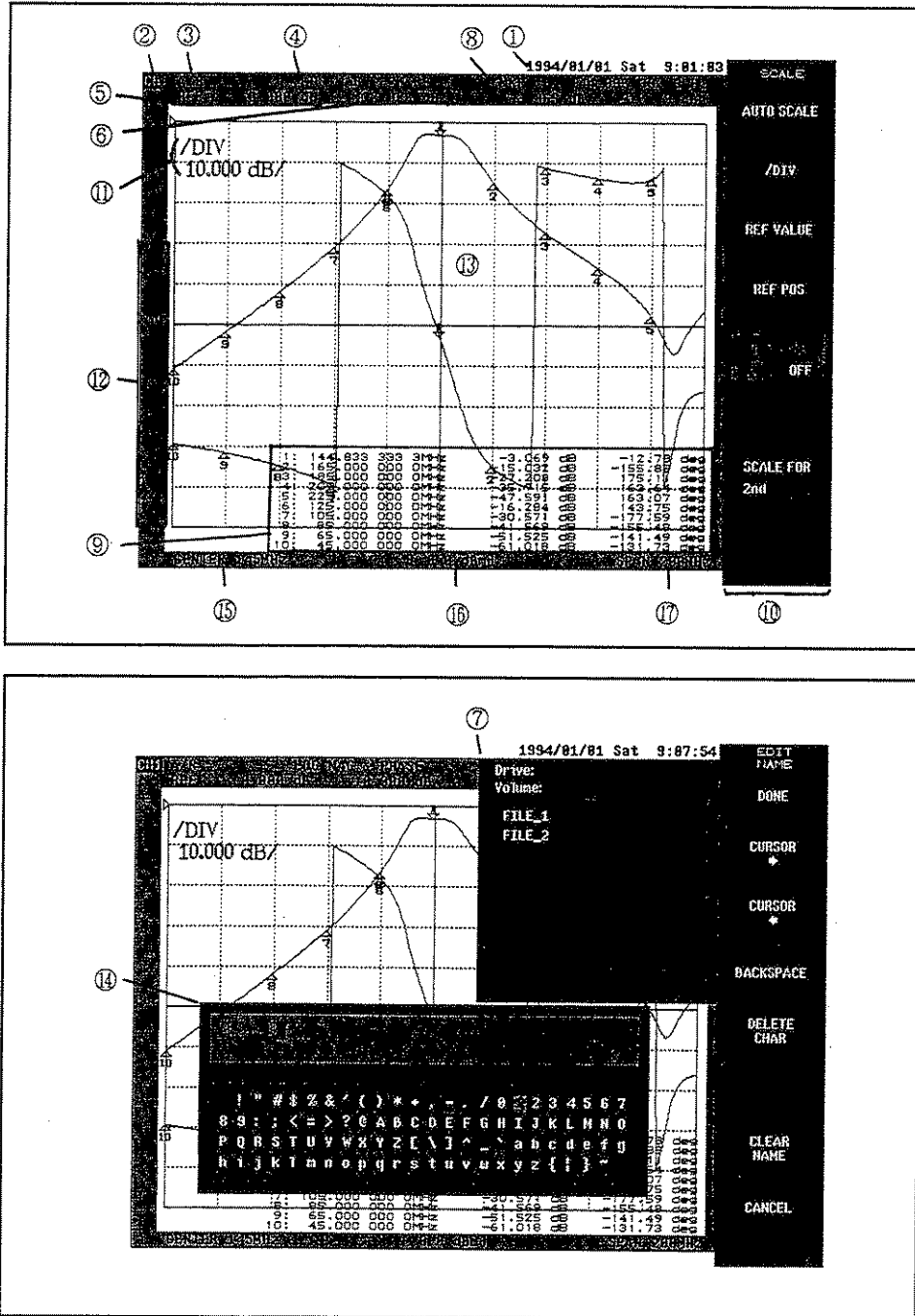



Figure 2-2 Screen Display Descriptions

**R3753 SERIES  
NETWORK ANALYZER  
OPERATION MANUAL**

**2.2 Screen Display Description**

No.	Name	Description
①	Real time clock	Displays year, month, date, and time.
②	Channel	Displays a channel number.
③	INPUT port	Displays an input port.
④	Format	Displays data format (format data).
⑤	Scale reference	Displays a reference value of display coordinate. The reference position is displayed by using  mark.
⑥	Scale/DIV	Displays one scale value of display coordinate.
⑦	Load menu	Displays files in this area when loading program from an internal disk.
⑧	Active marker	Displays an active marker value.
⑨	Marker list	Displays a marker list.
⑩	Soft key menu	Displays a soft key menu.
⑪	Active area	Displays items selected by panel keys or soft keys and those input values.
⑫	Status area	Displays status which shows an operating state of the analyzer.
⑬	Trace display area	Displays measurement data.
⑭	Label window	Displays character lists used for a label and a register name.
⑮	Start/Center	Displays the start/center of signal source.
⑯	Power/CW	Displays the power/CW of signal source.
⑰	Stop/Span	Displays the stop/span of signal source.



R3753 SERIES  
NETWORK ANALYZER  
OPERATION MANUAL

2.3 Rear Panel Description

2.3 Rear Panel Descriptions

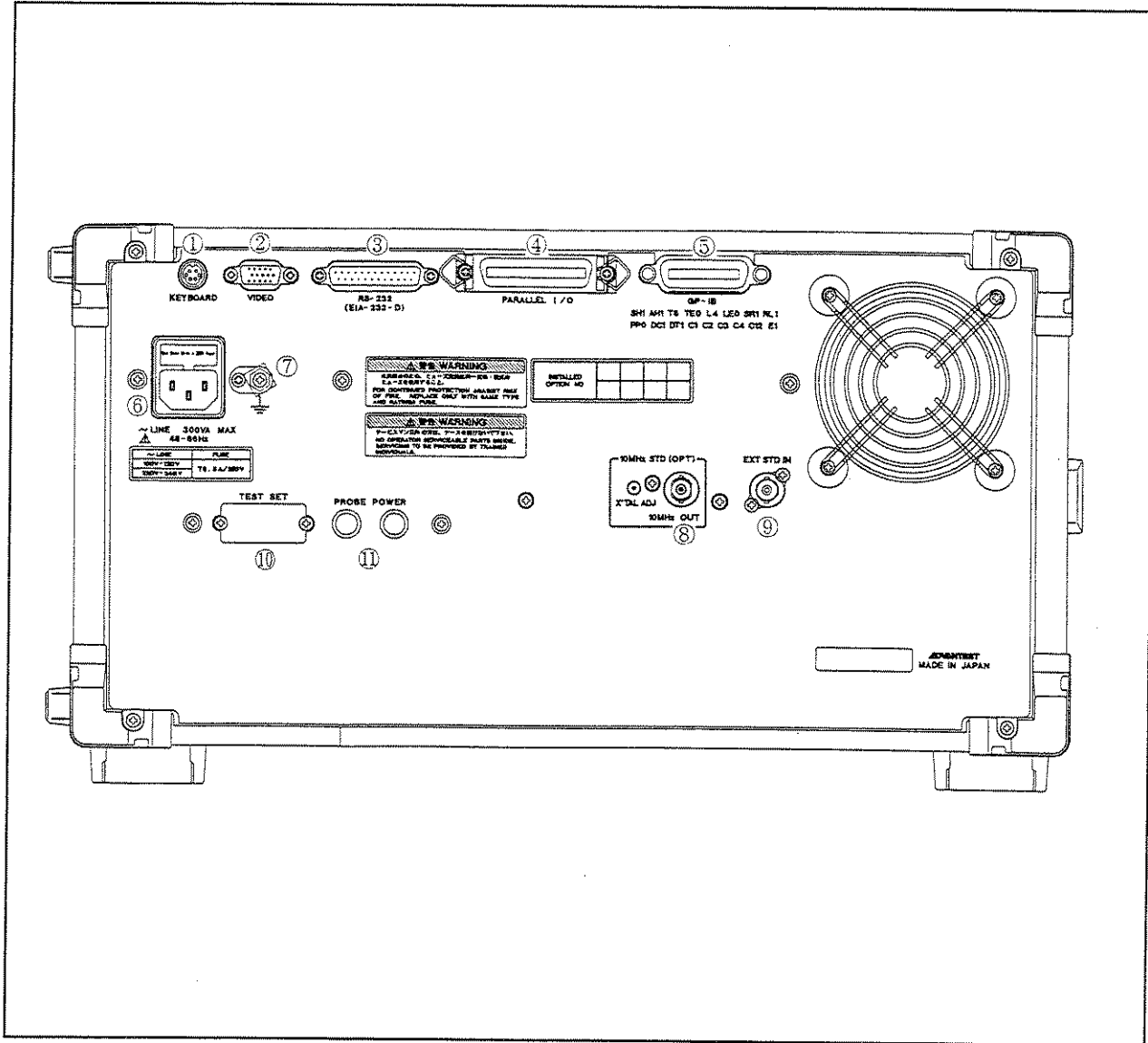

Figure 2-3 Rear Panel Descriptions

**R3753 SERIES  
NETWORK ANALYZER  
OPERATION MANUAL**

**2.3 Rear Panel Description**

No.	Name	Description
①	KEYBOARD INPUT connector	The KEYBOARD INPUT connector is used to connect a keyboard belonging to IBM-PC/AT or PS/2 series. An external keyboard can be used to input a label name, a saving register name and a BASIC text.
②	VIDEO SIGNAL output	Video signal output correspondence to VGA
③	SERIAL I/O	Input/output connector complied with RS-232 standard.
④	PARALLEL I/O connector	The I/O port connector is used to communicate peripheral devices such as an automatic machine and a foot switch. (Output: 8-bit 2 systems, Input/output: 4-bit 2 systems) EXT TRIGGER input (Negative logic, pulse width: 1 $\mu$ s or more, 18-pin terminal) Note: Use shielded cables for connection (to prevent malfunction by noise).
⑤	GPIB connector	The GPIB connector is used to remotely control an external peripheral devices and to be remotely controlled by an external controller.
⑥	AC POWER connector	The AC POWER connector has three-pin structure and an earth terminal. To remove a power fuse, pull out the upper cover.
⑦	Ground terminal	The ground terminal is used to ground from the analyzer only when three-pin connector or two-pin adapter for power cable cannot be used.
⑧	High stability reference frequency output connector (option 20)	This connector is used to output a high stability reference frequency when the option 20 is installed.
⑨	External reference frequency input connector	This connector is used to only input a reference frequency from an external device.
⑩	TEST SET connector	Connector for connecting S parameter test-set.
⑪	PROBE POWER connector	Connector for probe power $\pm 15V$ output

### 3. EASY USAGE

#### 3.1 Basic Operation

##### 3.1.1 Necessary Key for Basic Operation

(1) Front panel key and software key

The panel key and the software key are used for setting various functions of R3753.

The arrangement of the front panel key divides into six following functional blocks.

- ACTIVE CHANNEL block: R3753 has two measurement channels. This selects the active channel that is possible setting and the change.
- ENTRY block: Numeric value is input to the selected function.
- STIMULUS block: This sets it to the signal source.
- RESPONSE block: This sets the receiving part and the information on the display screen.
- INSTRUMENT STATE block: This sets systems such as the saving, the recall, and the hardness copies.
- GPIB block: This sets the controller function and GPIB.

The item (Software key menu) which can be setting that the key of each block of STIMULUS, RESPONSE and INSTRUMENT STATE/GPIB will be pressed among the front panel keys corresponding to the function is displayed on a right side of the display screen.

(2) Key operation

There is of two kinds by the key operation of R3753. And they are shown in the following.

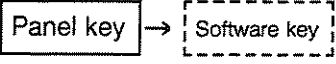
- Case for which numerical data input is necessary: 
- Case selected only by software menu: 

(3) Configuration of software menu

The software menu has two or more pages and hierarchic structures.

- Two or more-page's software menus that are: When  More 1/2 is pushed, the menu will move to the next page.  
When  More 2/2 is pushed, the menu will return to the page of former.
- Software menu of hierarchic structure: When  Return is pushed, the menu will return to the previous layer menu.

(4) Front panel key

Each function of the front panel key is explained in the briefly here. Refer to Chapter 4 for details of each function.

① ACTIVE CHANNEL block

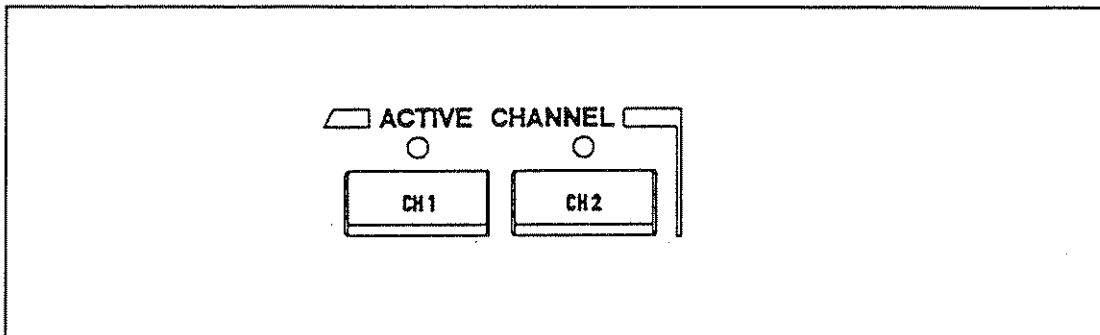

R3753 can measure the reflection and transmission characteristics of the devices at the same time. Moreover, simultaneous measurement by a different frequency can be done. R3753 has two measurement channels. Therefore, measurement and the data display for each channel can be done independently.

In the ACTIVE CHANNEL block, which channel is set to the active channel is selected. The active channel is a channel that can set various conditions such as measurement and data displays. That is, the function depend on the channel is effective only to the active channel. LED is lit to the current active channel.

CH 1 : The channel 1 is set to the active channel.

CH 2 : The channel 1 is set to the active channel.

The signal source can interlock between channels. In this case, the condition set in the active channel is set to other channel automatically.

② ENTRY block

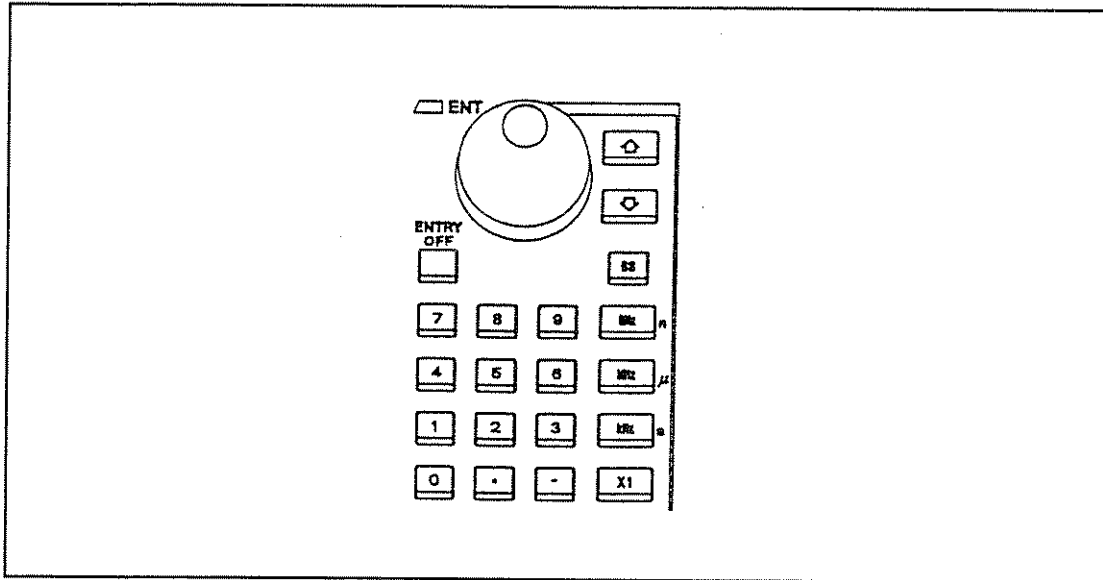

In the ENTRY block, data entry and the change are done to the function selected with the

Panel key and the Software key.







Moreover, this is used to set and to change the marker.

- Numeric keys: 0 to 9 ; It is a numeric key.
- . ; It is a decimal point key.
- ; It is minus sign key.
- BS ; It is a back space key.
- ENTRY OFF   ; It is an entry off key. All numerical data under input is deleted. And input request is canceled.

Note: After operation of a numeric key.  
 Press the unit key.

R3753 SERIES  
NETWORK ANALYZER  
OPERATION MANUAL

3.1 Basic Operation

- Unit keys:  n ; It is giga/nano unit keys.
-   $\mu$  ; It is mega/micro unit key.
-  m ; It is of kilo/milli unit key .
-  ; Base unit key. The case of base unit or Not provided unit is used.  
(dB, dBm, degree, seconds, and Hz etc.)
- Step keys:  to  ; The set value is input by a specific step size.  
After operation of the skip key, the unit input is unnecessary.
- Data knob:  ; The set value can continuously be changed. After operation of the data knob, the unit input is unnecessary.

③ STIMULUS block

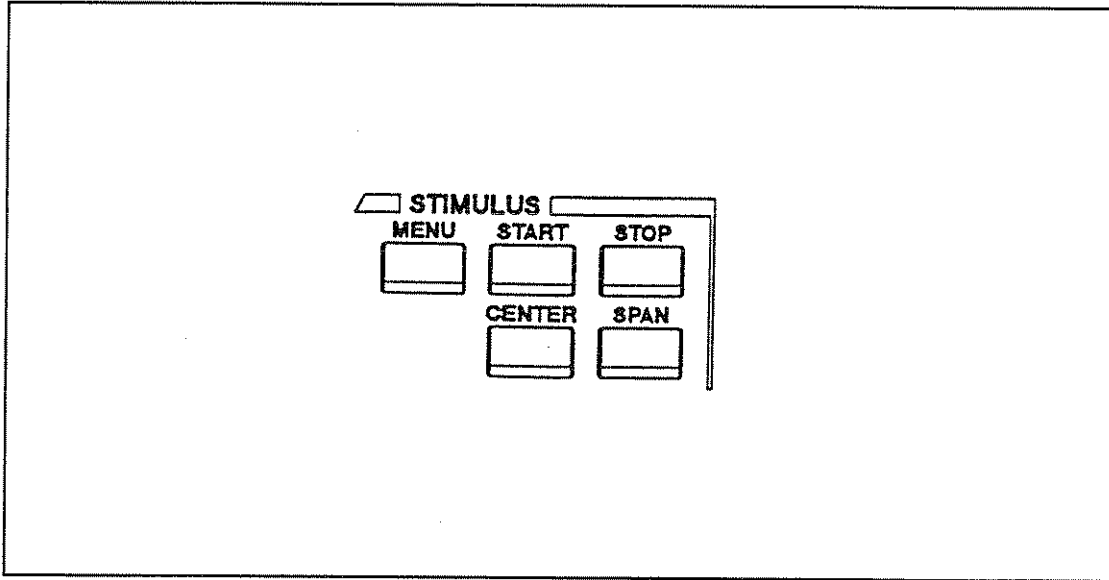

In the STIMULUS block, the condition in the signal sources such as the frequency range, the power level setting, the sweep type, sweep time, and the sweep resolution is set. Moreover, attenuator of S parameter test set can be set when S parameter test set is connected.

- MENU** : The output level, sweep time, the sweep type, and the sweep resolution, etc. are set.
- START** : The start of the sweep is set.  
As for the case of the frequency sweep, the frequency is set. And as for the case of the power sweep, power is set.
- STOP** : The stop of the sweep is set.  
As for the case of the frequency sweep, the frequency is set. And as for the case of the power sweep, power is set.
- CENTER** : The center of the sweep is set. As for the case of the frequency sweep, the frequency is set.
- SPAN** : Span of the sweep is set. As for the case of the frequency sweep, the frequency is set.

The range of the sweep is set with **START** , **STOP** , **CENTER** , and **SPAN** .

Other setting is set by the signal source menu called with **MENU** .

④ RESPONSE block

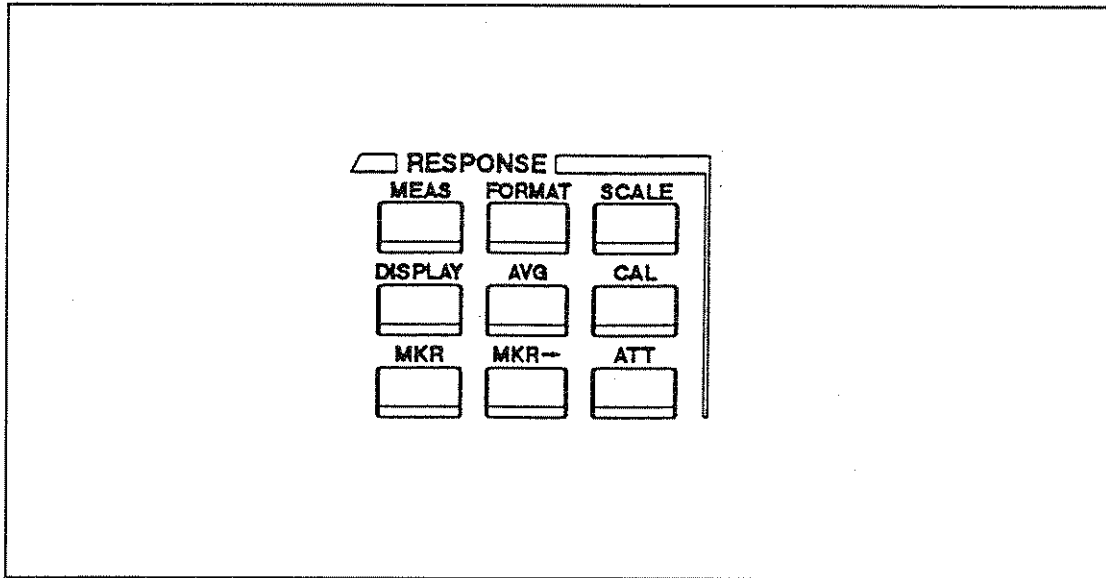

In the RESPONSE block, the measurement condition, the measurement parameter, the measurement format, the display format, and the marker in the receiver section of the active channel are set.

- MEAS** : The input port and the measurement parameter is set.
- FORMAT** : The format of measured data is set.
- SCALE** : Coordinate axis of the display is set.
- DISPLAY** : Two channels simultaneous display, trace operation facility, and the label input are set.
- AVG** : Data average, smoothing, and resolution bandwidths are set.
- CAL** : The calibration function is set.
- MKR** : The marker is set.
- MKR->** : The analysis by the marker is set.
- ATT** : Input attenuator and impedance in the receiver section is set.



⑤ INSTRUMENT STATE block

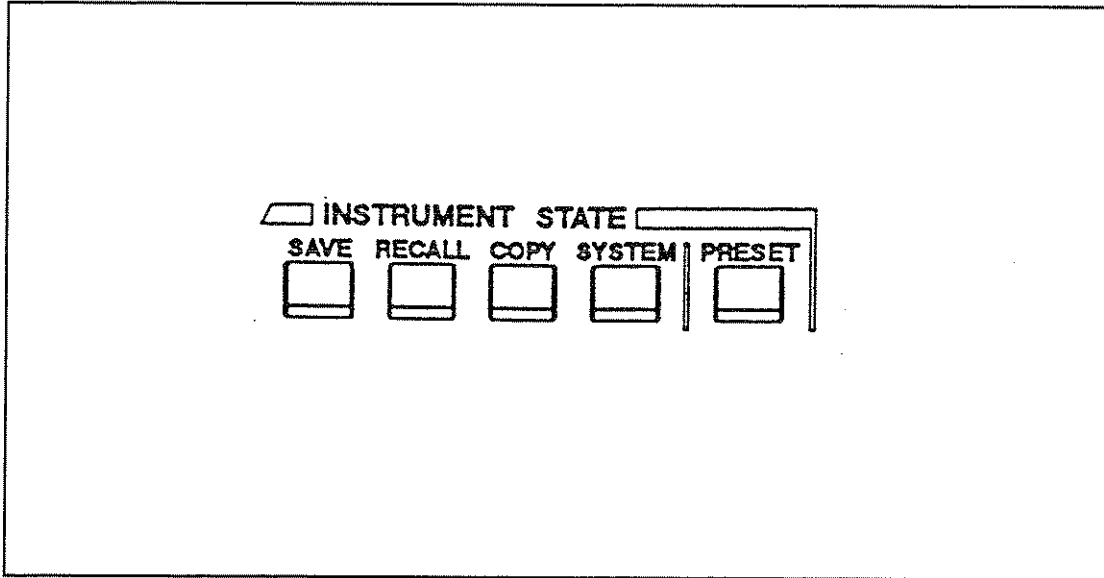

In the INSTRUMENT STATE block, the system control functions that have no effect to the measured data is set.

The displays of the date and time, the limit line test, the saving and the recall, and the hard copies are included in the system control function .

- |               |   |  |
|---------------|---|--|
| <b>SAVE</b>   | : | Setting state and the calibration data of R3753 are preserved.   |
| <b>RECALL</b> | : | Setting state and the calibration data of R3753 are called.  |
| <b>COPY</b>   | : | When the measurement waveform is output to the plotter or measured data is printed, this setting will be used. |
| <b>SYSTEM</b> | : | The display of the date and time are set.  |
| <b>PRESET</b> | : | The setting state of R3753 is initialized.   |

⑥ GPIB block

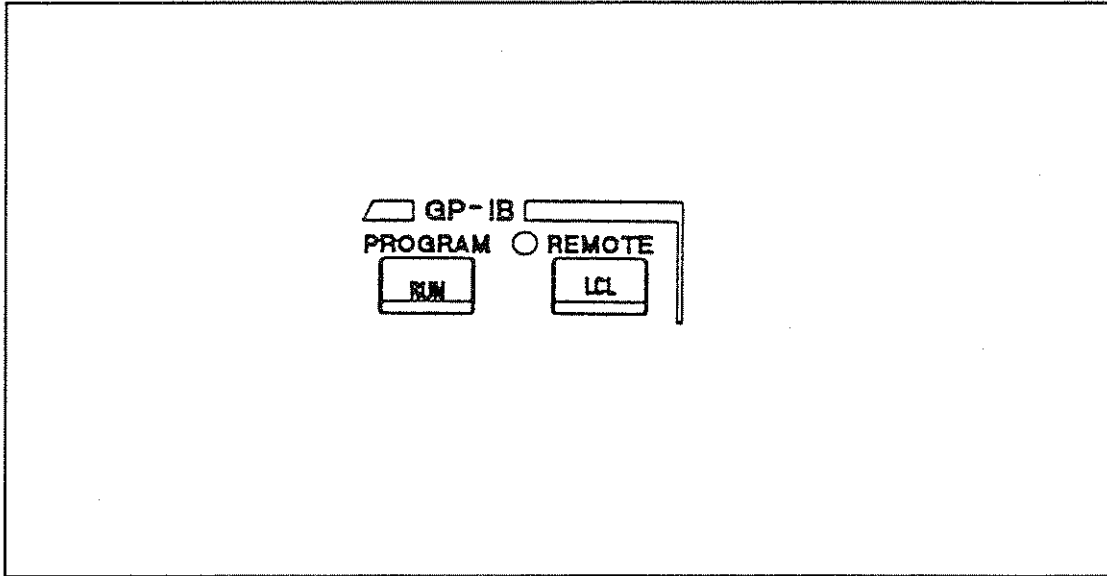

In the GPIB block, the controller function, GPIB-bus, and the GPIB address are set. Refer to the programming manual of the separate volume for programming.

PROGRAM



: The controller function is set.

When this key is pressed while the program by the controller function is running, the execution of the program will be stopped. And the menu is called.

REMOTE



: GPIB is set.

The operation of all panel keys will become invalid when R3753 is remote by GPIB.

If this key is pressed, R3753 will become local status. And the operation of the panel key becomes possible.

(5) Software key

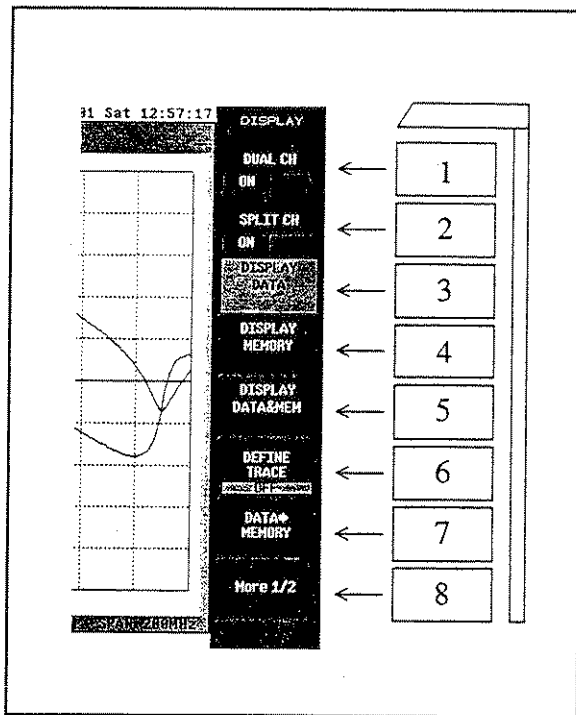

Figure 3-1 Software key

When the panel key is pressed, a set item corresponding to the function of the software key will be displayed. Those items can be chosen with the corresponding software key. (A left figure is example of the software key displayed when the DISPLAY key in the RESPONSE block is pressed. The display and the key of the figure correspond as shown)



(3) Frequency setting of signal source

Set the frequency of the signal source according to the characteristic of the filter. The band pass filter of 145MHz is measured here. Therefore the following are set.

CENTER 1 4 5 MHz

SPAN 1 5 0 MHz

The waveform shown in the following figure is displayed by the above-mentioned operation.

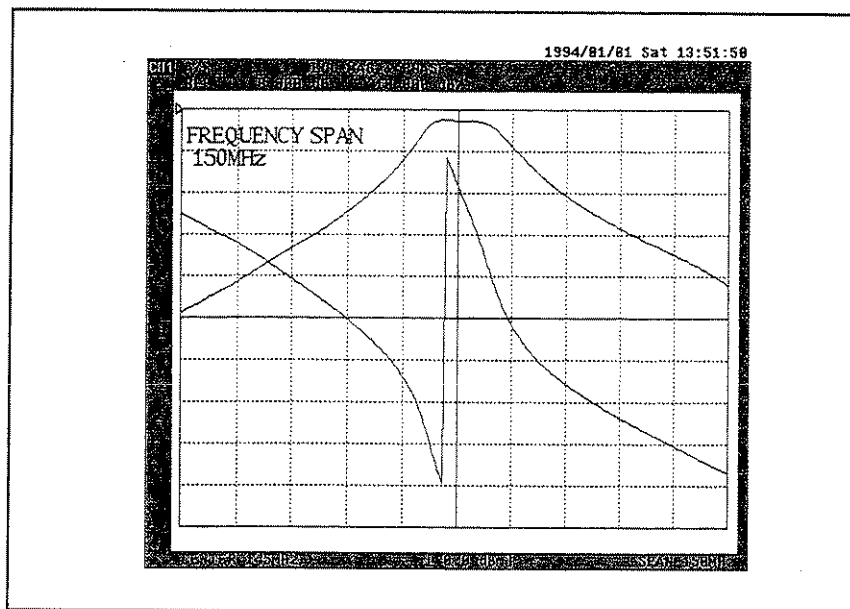

Figure 3-3

Next, the display coordinates are optimized to the display trace.

In current, this is FORMAT of two traces displays of LOG MAG & PHASE. (The first trace: LOG MAG, the second trace: PHASE) AUTO SCALE is executed for each trace. (Automatic setting of display coordinates)

**SCALE** Confirm SCALE FOR of the display menu is in 1ST  
(the first trace) when the SCALE key is pressed.

AUTO SCALE

SCALE FOR  
2nd / 1st (2nd (the second trace) is selected)

AUTO SCALE

The waveform trace is displayed as shown in the following figure by the above-mentioned operation.

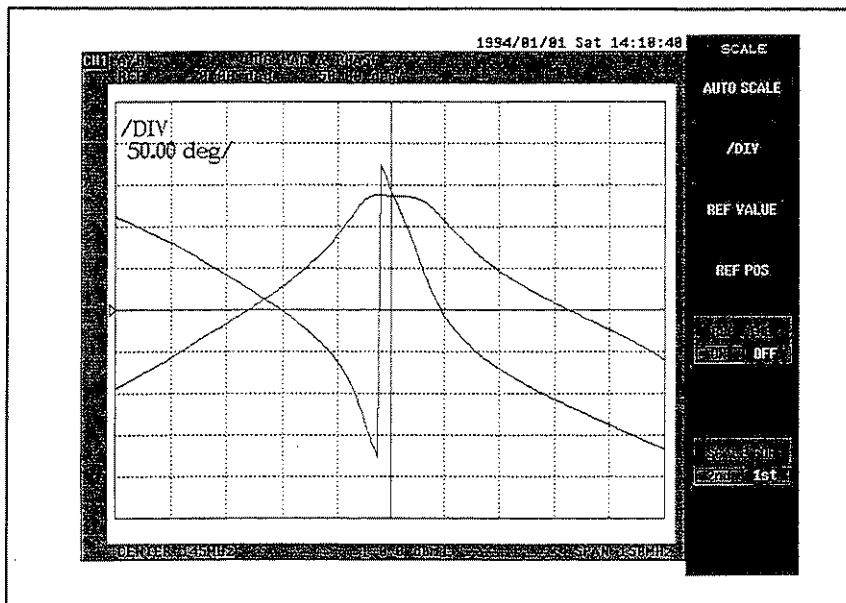

Figure 3-4

(4) Display of marker

Measured value of each point can be directly read by the marker display.



The marker is displayed as shown in the figure below by the above-mentioned operation.

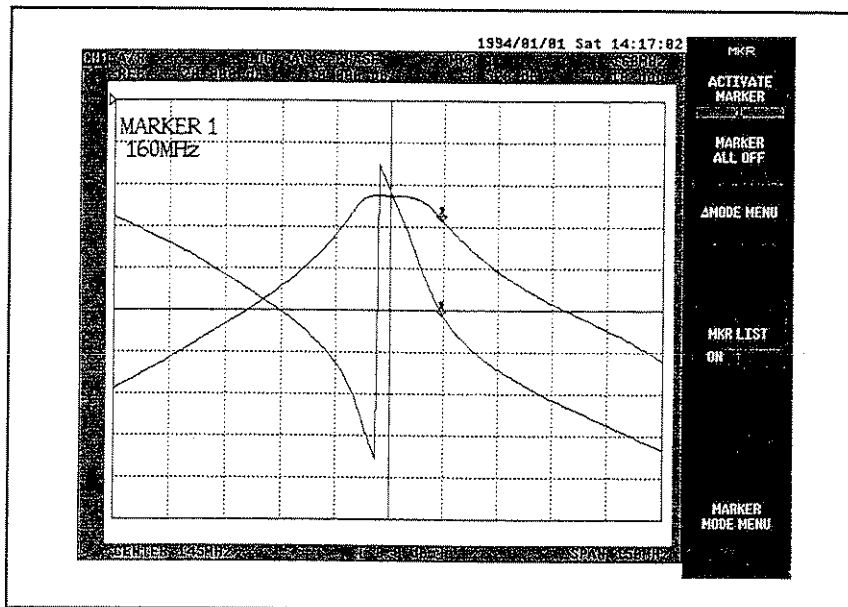

Figure 3-5

## 3.2 Measurement Example

A basic operation method is explained here by the example of measuring for the actual band pass filter (BPF) and crystalline resonator.

The measurement example is shown as follows.

1. Measurement of filter
2. Phase measurement
3. Group delay measurement
4. Sweep measurement of narrow-band/wide-band
5. Measurement of amplitude and phase
6. Measurement of amplitude and group delay
7. Measurement of linear amplitude and phase
8. Measurement in which use of dual-screen simultaneous display
9. Reflection characteristic measurement
10. Measurement of crystalline resonator
11. Measurement with multi-marker
12. Measurement with delta marker
13. Marker analysis of delta section.
14. Measurement by marker→.
15. Measurement with interpolation marker and marker coupling
16. Measurements in which use of program sweep
17. Measurement of point of resonance and antiresonance of ceramic oscillator
18. Output of measured data to plotter
19. Saving and recall of the set value
20. Saving and recall of the measurement

All screen displays here are displays of R3753A.



### 3.2.1 Measurement of Filter

The operation method of filter analysis is explained here by the example of measuring the band pass filter of center frequency 10.7MHz.

- (1) Setup (Filter connection) and presetting (Refer to 3.1.2 subsections and figures 3-2).
- (2) The measurement format is made an amplitude (Logarithm display).



- (3) Set center frequency and span.

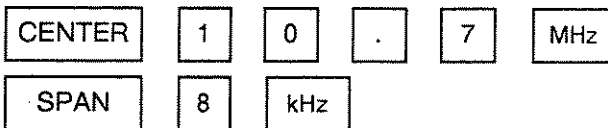

- (4) Make the status of through and do calibration of the frequency characteristic.

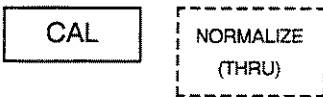

First of all, DUT is removed. And instead, the short adaptor is connected. Under such a condition, execute normalization. The display is shown in the figure below. The CORRECT key automatically enters the state of the turn on.

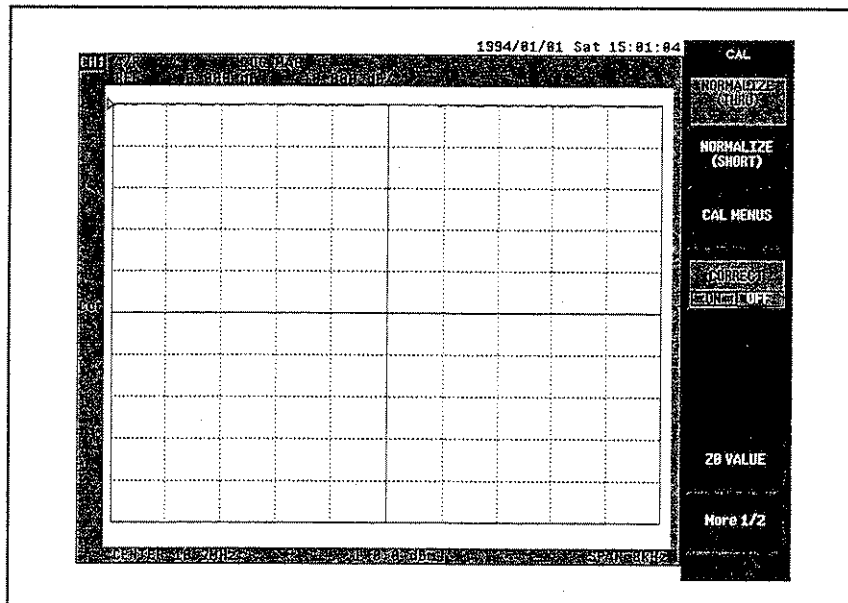

Figure 3-6

After ending, the connection will be returned to DUT (Filter).

(5) Correct the scale of the waveform display. The display comes to see easily.



The display is shown in the figure below.

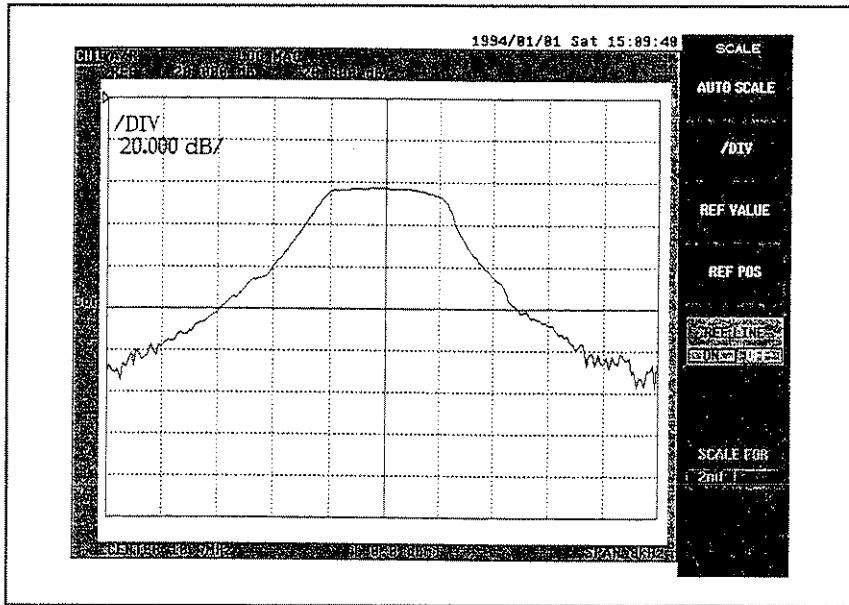

Figure 3-7

R3753 SERIES  
NETWORK ANALYZER  
OPERATION MANUAL

3.2 Measurement Example

(6) It is measurement of bandwidth of 3dB.

The marker is set. And the filter analysis function is started.

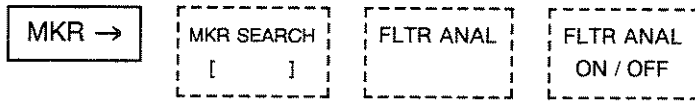

The screen display is shown in the figure below. Measured bandwidth is shown on the waveform by the arrow (↕).

The analysis result is displayed.

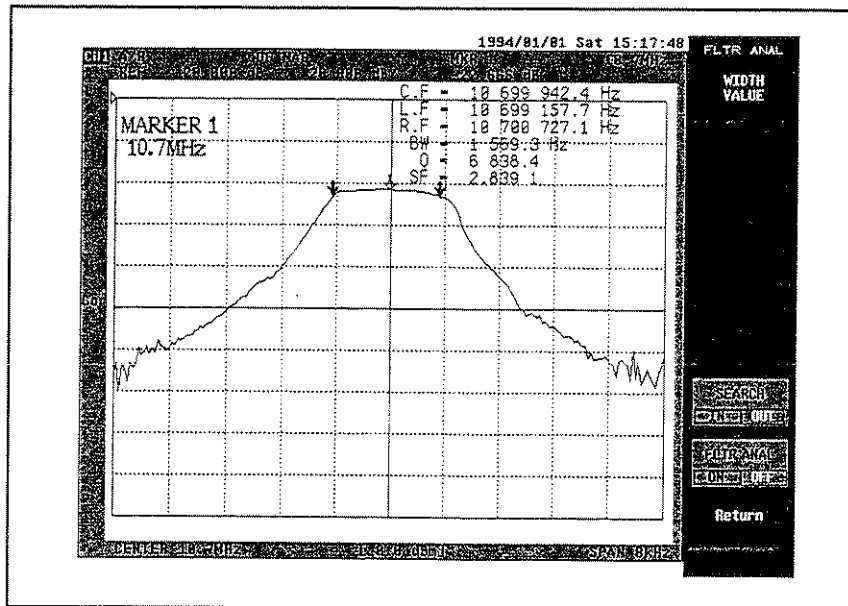

Figure 3-8

- (7) It is measurement of bandwidth of 6dB.  
 WIDTH VALUE (searched bandwidth) is changed from 3dB (initial value) to 6dB.



The display is shown in the figure below.

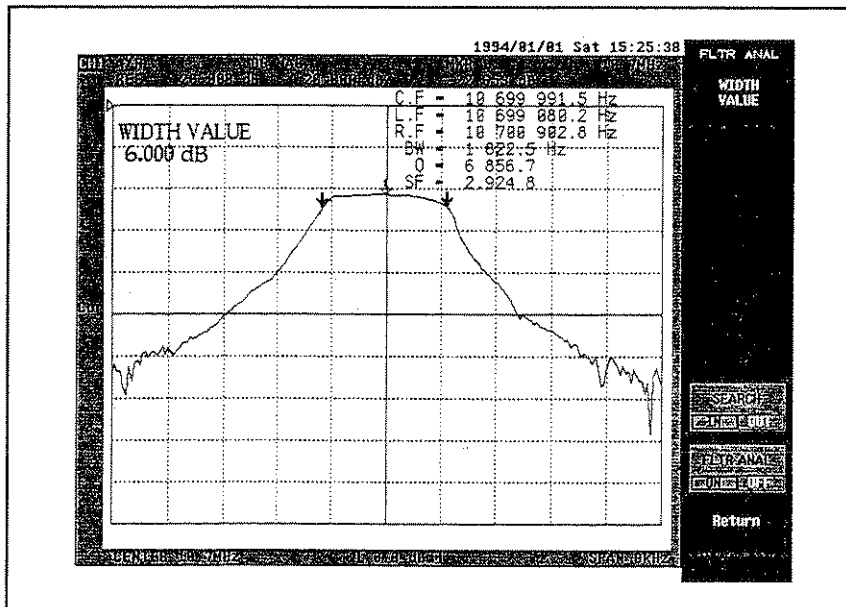

Figure 3-9

### 3.2.2 Phase Measurement

The method of measuring the phase is explained here by the example of the band pass filter of center frequency 10.7MHz as well as the preceding clause.

- (1) Setup (filter connection) and presetting (Refer to 3.1.2 subsections and figures 3-2)
- (2) The measurement format is made a phase display.



- (3) Set center frequency and span.

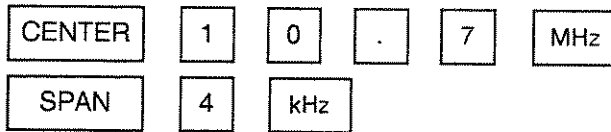

- (4) Do calibration of the frequency characteristic.  
Do similar operation by the item (4) of 3.2.1 Subsection (measurement of the filter).  
The display becomes a usual phase display as shown in the figure below.

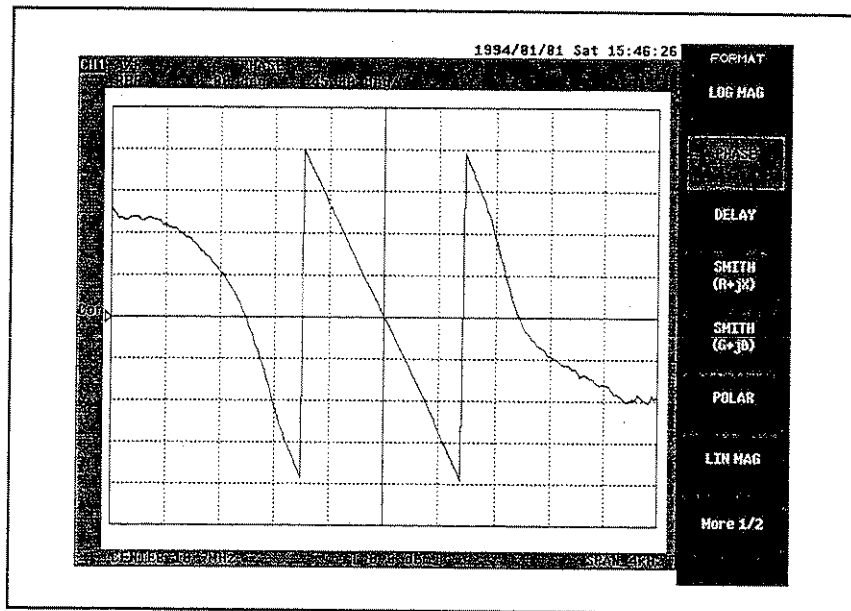
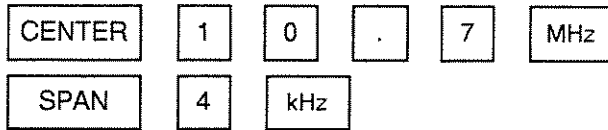

Figure 3-10



- (3) Set center frequency and span.



- (4) Do calibration of the frequency characteristic.  
Do similar operation by the item (4) of 3.2.1 Subsection (measurement of the filter).
- (5) Correct the scale of the display waveform. The display comes to see easily.

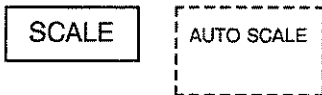

The display is shown in the figure below.

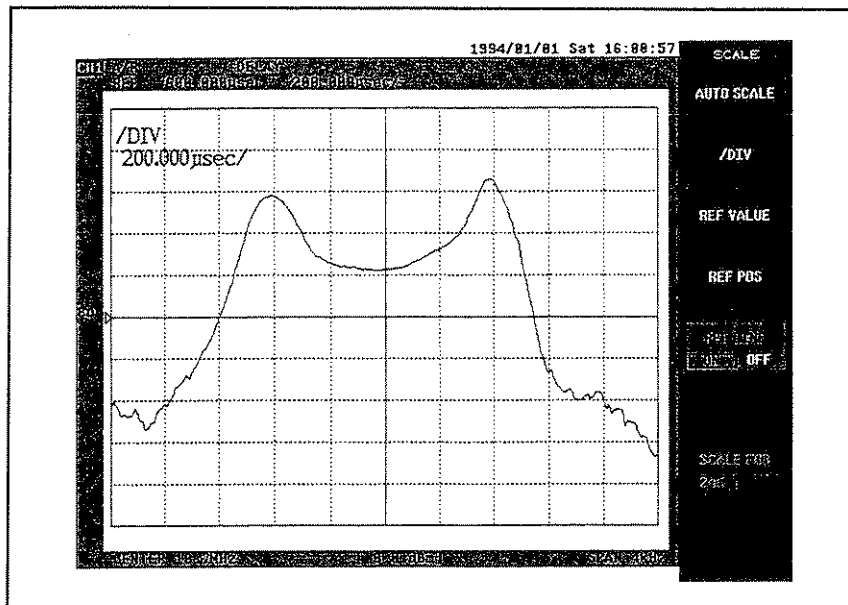

Figure 3-12

(6) The aperture of the group delay is changed to 20 percent.



The display is shown in the figure below.

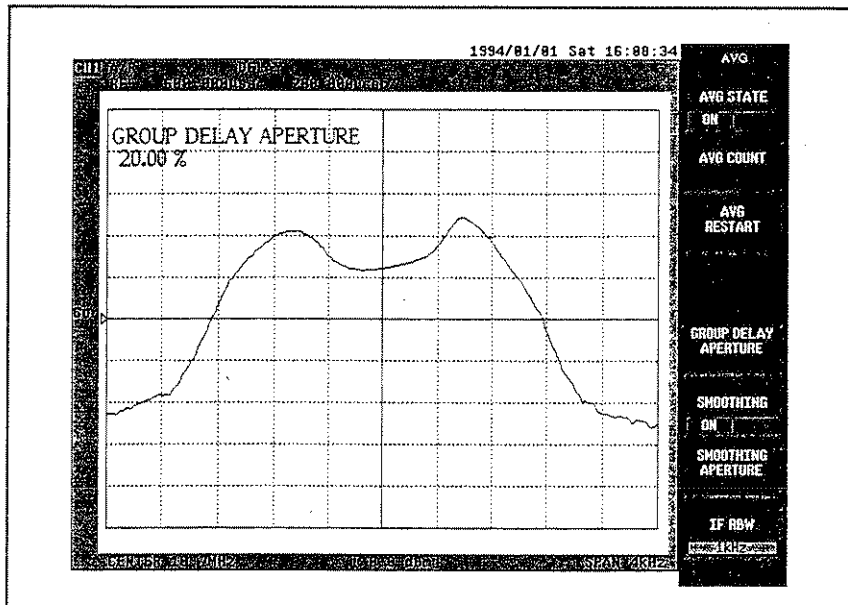
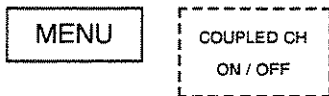

Figure 3-13

### 3.2.4 Sweep Measurement of Narrow-band and Wide-band

The operation methods of setting for the difference measuring condition to the channel 1 and 2 is explained here by the example of the band pass filter of center frequency 10.7MHz.

- (1) Setup (filter connection) and presetting (Refer to 3.1.2 subsections and figures 3-2)
- (2) Make the measuring condition of the channel 1 and 2 set independence.





- (3) Set frequency range of the channel 1.

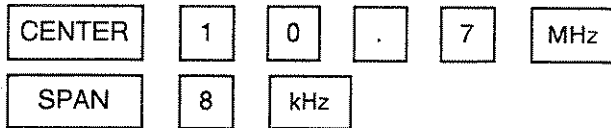

- (4) Set frequency range of the channel 2.

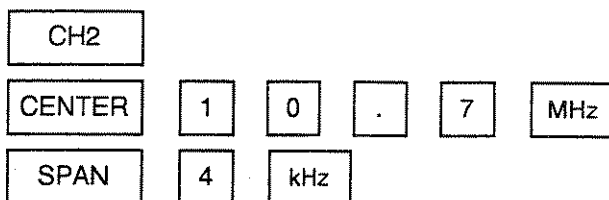

- (5) Do calibration of the frequency characteristic of the channel 1.  
First of all, connect the short adaptor instead of DUT.  
Under such a condition, normalize is done.

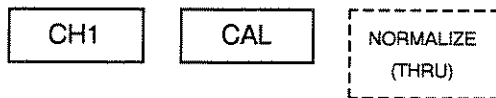

- (6) Calibrate frequency characteristic of the channel 2 similarly.



After ending, return the connection to DUT (filter).

(7) Two channels are made a simultaneous display.



The display is shown in the figure below.

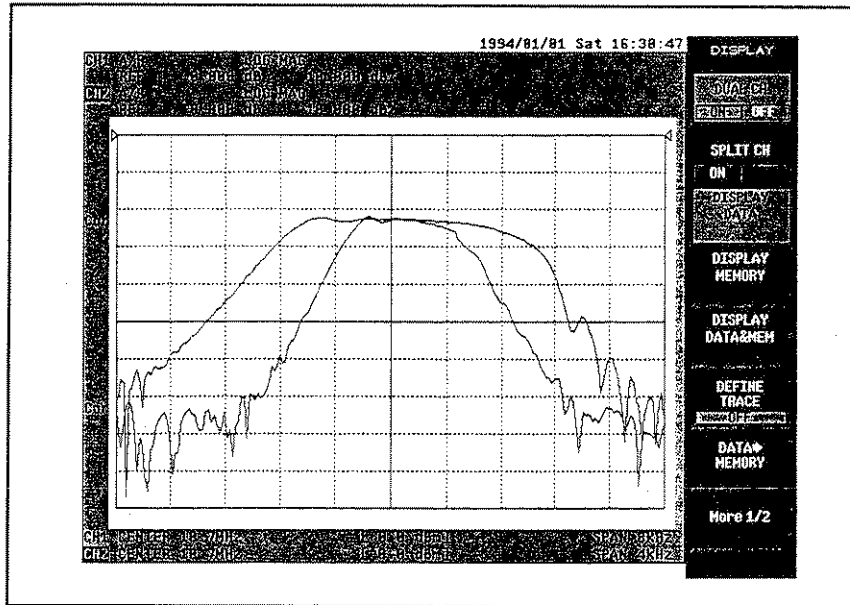

Figure 3-14

R3753 SERIES  
NETWORK ANALYZER  
OPERATION MANUAL

3.2 Measurement Example

- (8) The display is divided into the 2 of up and down.

SPLIT CH  
ON / OFF

The display is shown in the figure below.

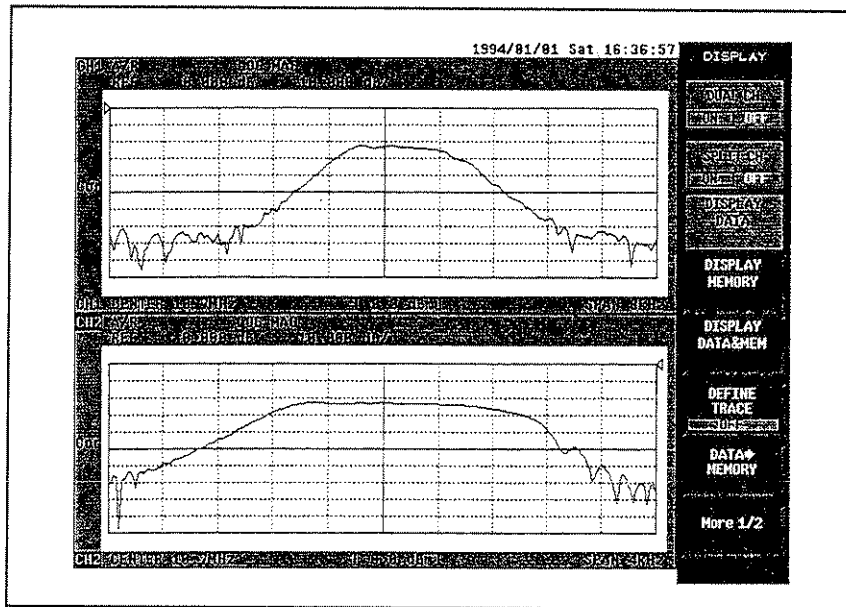
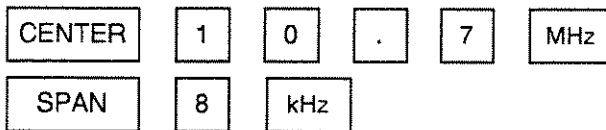

Figure 3-15

### 3.2.5 Measurement of Amplitude and Phase

The measurement method of the amplitude and the phase of two traces simultaneously displayed is explained here by the example of the band pass filter of center frequency 10.7MHz.

- (1) Setup (filter connection) and presetting. (Refer to 3.1.2 subsection and figure 3-2.)
- (2) Set center frequency and span.



- (3) Do calibration of the frequency characteristic.  
 Do similar operation by the item (4) of 3.2.1 Subsection (measurement of the filter).
- (4) Change the scale of the display waveform.  
 When such two traces are simultaneously displayed by format, which waveform is changed can be selected with SCALE FOR.  
 The scale of first waveform (amplitude) is changed.

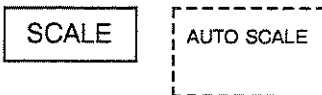

The display is shown in the figure below.

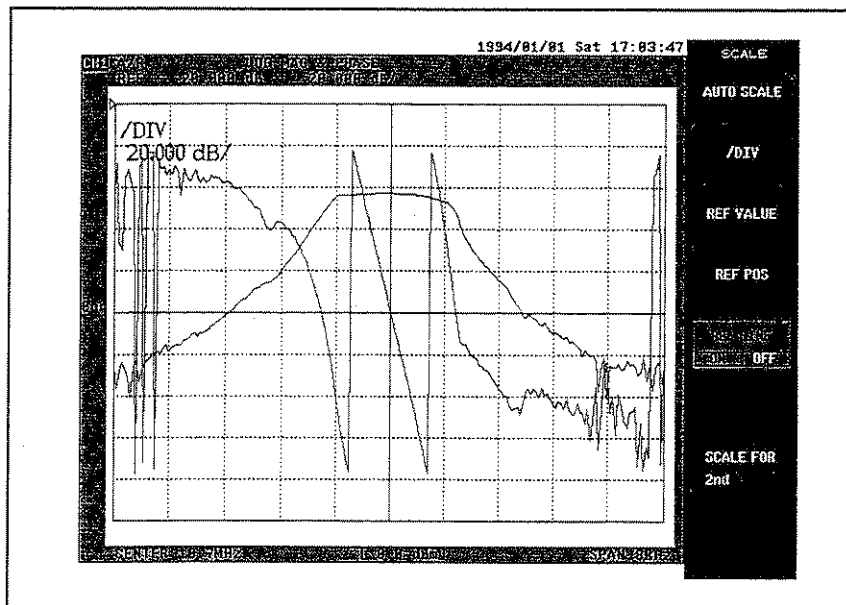

Figure 3-16

- (5) To change scale of the second waveform (phase), 2nd is selected with SCALE FOR. The reference position line changes into the line of the second waveform, too.



The display is shown in the figure below.

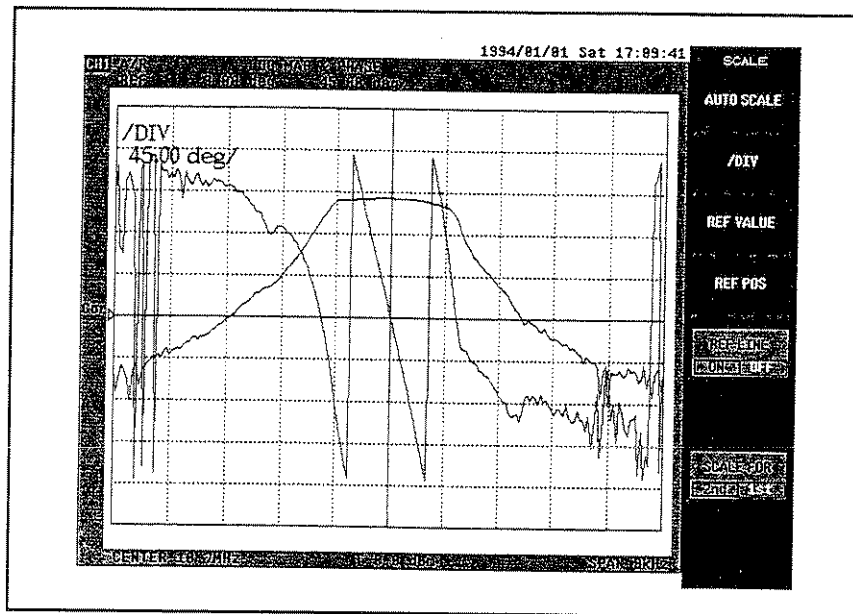
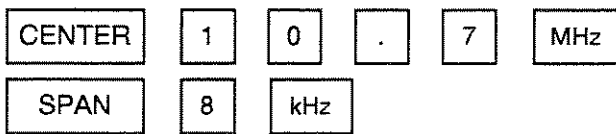

Figure 3-17

### 3.2.6 Measurement of Amplitude and Group Delay

The measurement method for the amplitude and the group delay by which two traces are simultaneously displayed is explained here by the example of the band pass filter of center frequency 10.7MHz.

- (1) Setup (filter connection) and presetting (Refer to 3.1.2 subsections and figures 3-2)
- (2) Set center frequency and span.



- (3) Do calibration of the frequency characteristic.  
Do similar operation by the item (4) of 3.2.1 Subsection (measurement of the filter).
- (4) Set the format in measurement to the amplitude/the group delay.

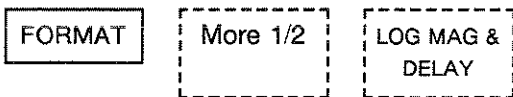

- (5) The scale of the first waveform (amplitude) is changed.



The display is shown in the figure below.

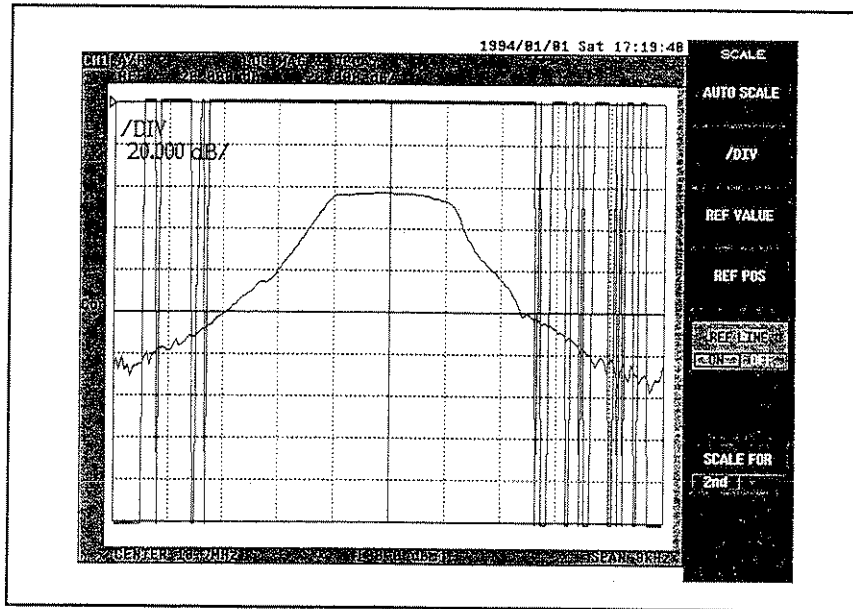
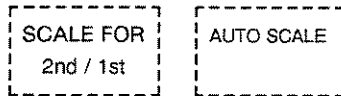

Figure 3-18

(6) The scale of the second waveform (group delay) is changed.



The display is shown in the figure below.

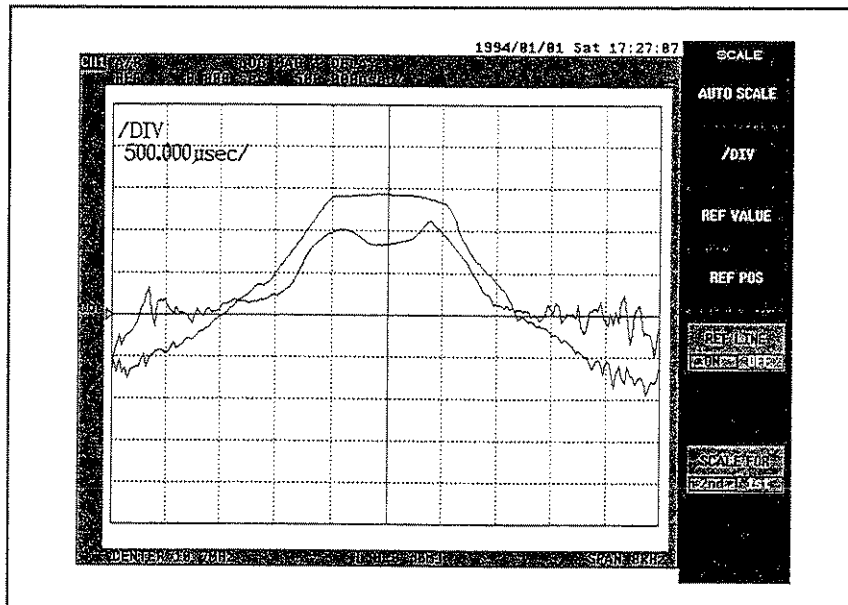

Figure 3-19



### 3.2.7 Measurement of Linear Amplitude and Phase

The measurement method for the linear amplitude and the phase by which two traces are simultaneously displayed is explained here by the example of the band pass filter of center frequency 10.7MHz.

- (1) Setup (filter connection) and presetting (Refer to 3.1.2 subsections and figures 3-2)
- (2) Set center frequency and span.

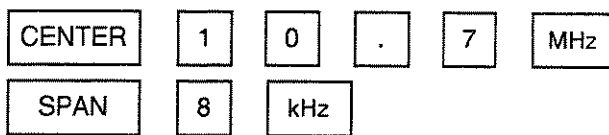

- (3) Do calibration of the frequency characteristic.  
Do similar operation by the item (4) of 3.2.1 Subsection (measurement of the filter).
- (4) The format is set in measurement to the linear amplitude/the phase.

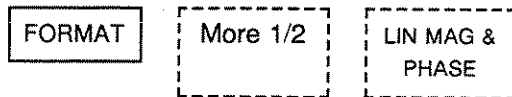

- (5) The scale of the first waveform (linear amplitude) is changed.



The display is shown in the figure below.

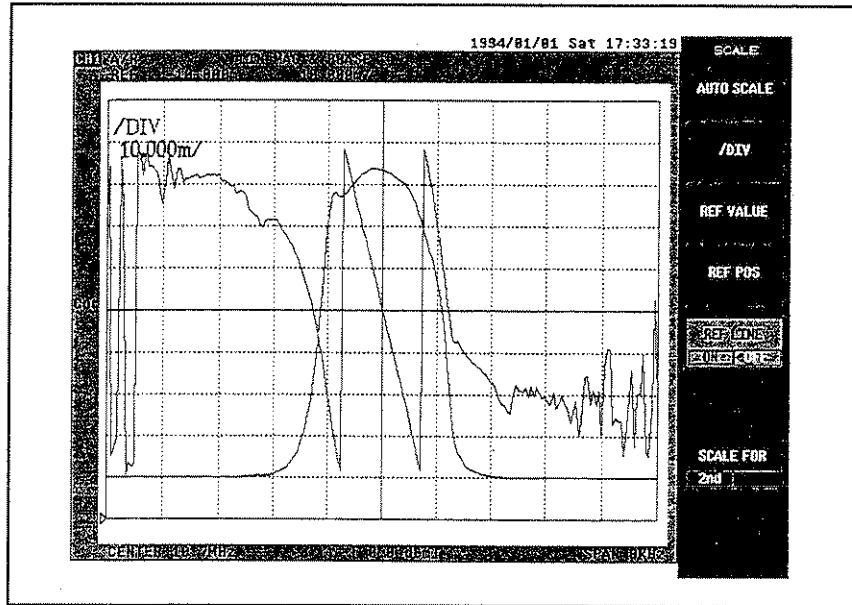

Figure 3-20

- (6) To change scale of the second waveform, 2nd is selected with SCALE FOR for the second waveform (phase).

SCALE FOR  
2nd / 1st

The display is shown in the figure below.

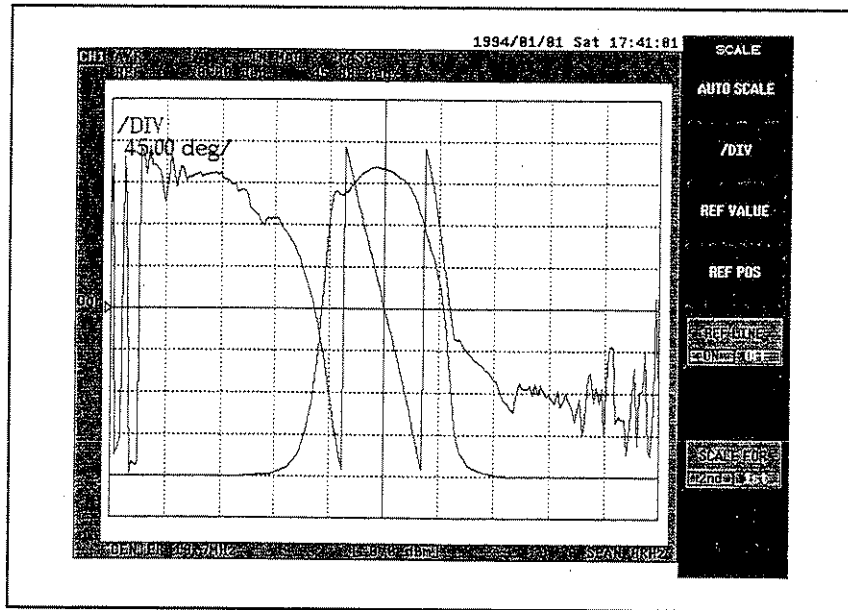
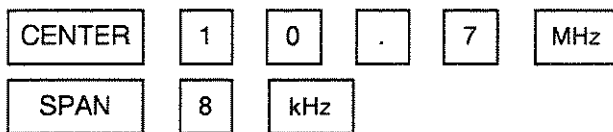

Figure 3-21

### 3.2.8 Measurement for Dual-screen to be Displayed Simultaneously

The operation method of simultaneously display of the channel 1 and 2 is explained here by the example of the band pass filter of center frequency 10.7MHz.

- (1) Setup (filter connection) and presetting (Refer to 3.1.2 subsections and figures 3-2)
- (2) Set center frequency and span. The channels 1 and 2 do the interlock operation.



- (3) Do calibration of the frequency characteristic. Each channel should be calibrated. First of all, the short adaptor is connected instead of DUT. Under such a condition, normalization is done.

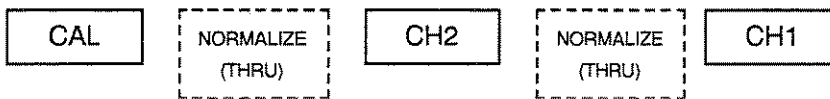

After ending, return the connection to DUT (filter).

- (4) Make it to dual-screen simultaneous display.

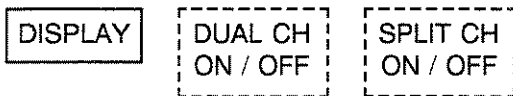

- (5) In dual-screen simultaneous display, the operation of the format and the scale, etc. are done to the active channel independently.

The channel 1 is made an amplitude display. And the scale is changed.



The channel 2 is made a phase display.

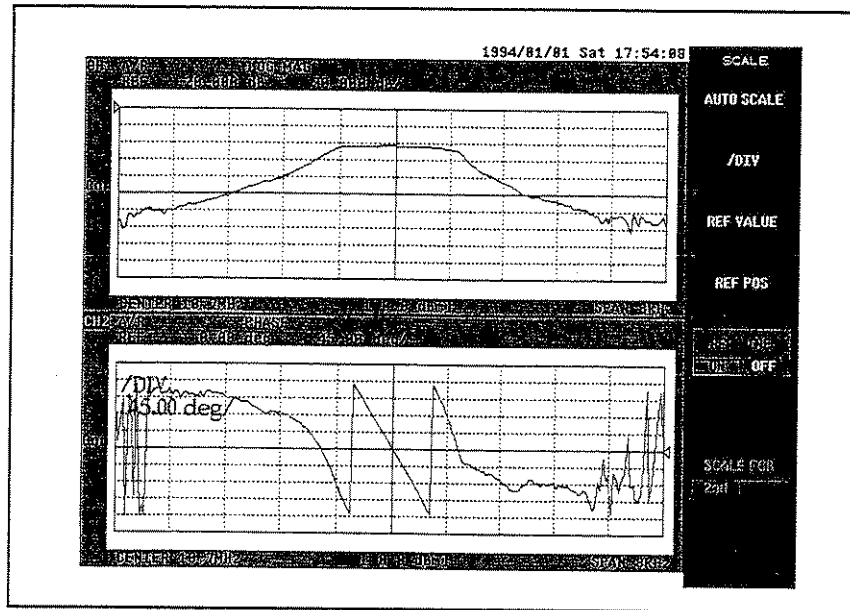
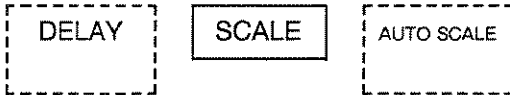

Figure 3-22

(6) The channel 2 is made a group delay display.



The display is shown in the figure below. This corresponds to measurement of the time of the amplitude and the group delay of 3.2.6 subsections.

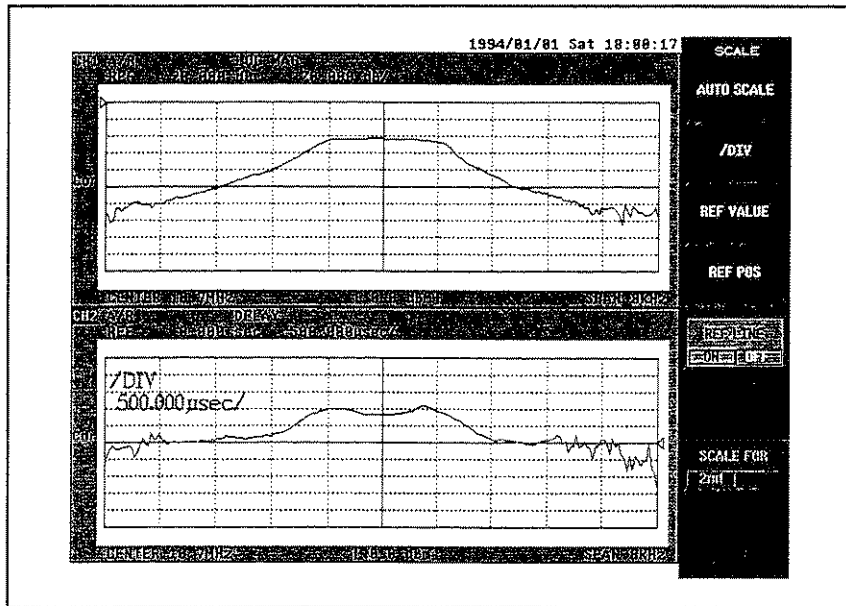
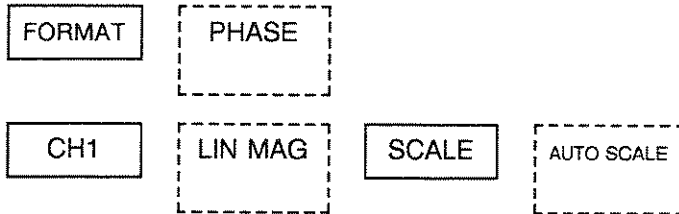

Figure 3-23

(7) The channel 2 is made a phase. And the channel 1 is made a linear amplitude.



The display is shown in the figure below. This corresponds to the measurement of the linear amplitude and the phase of 3.2.7 subsections.

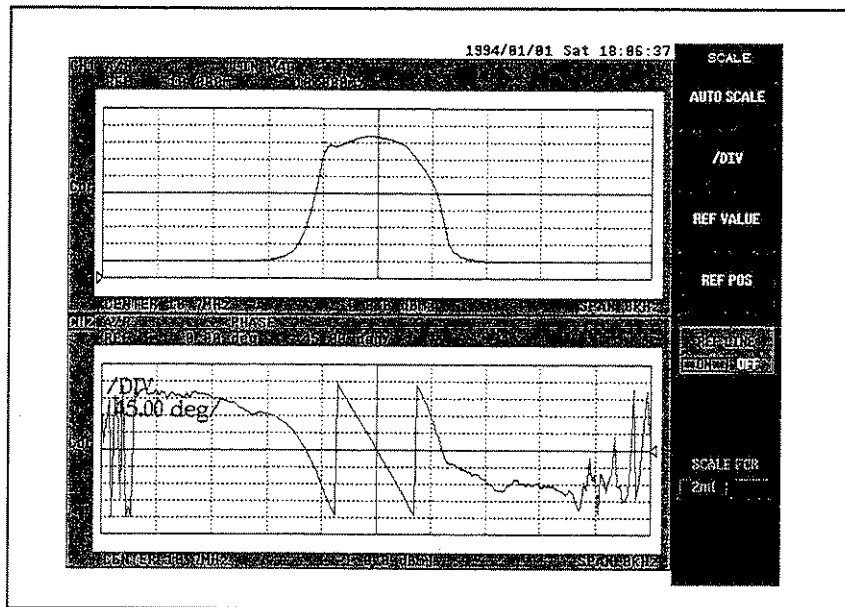
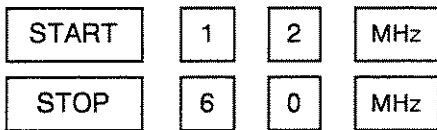

Figure 3-24

### 3.2.9 Measurement of Reflection

The measurement method of the reflection characteristic is explained here by the example of the band pass filter of passing band 24-30MHz.

- (1) Set up it (bridge connection). Use a directional bridge and ZRB2VAR-52 for the bridge.
- (2) Set frequency range of measurement.



- (3) Do the calibration as follows.  
Call one port full calibration menu.

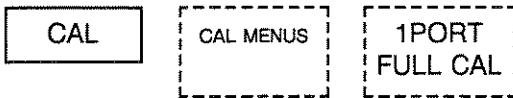



- (4) The open standard is connected with the test port of the bridge. And the calibration data is acquired.



The display is shown in the figure below.

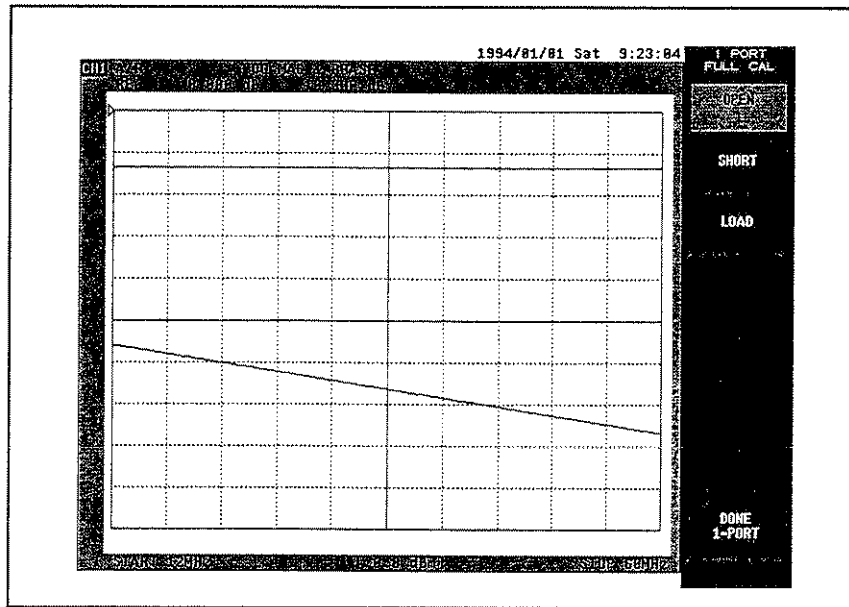

Figure 3-25

- (5) Short standard is connected with the test port of the bridge. And the calibration data is acquired.

SHORT

The display is shown in the figure below.

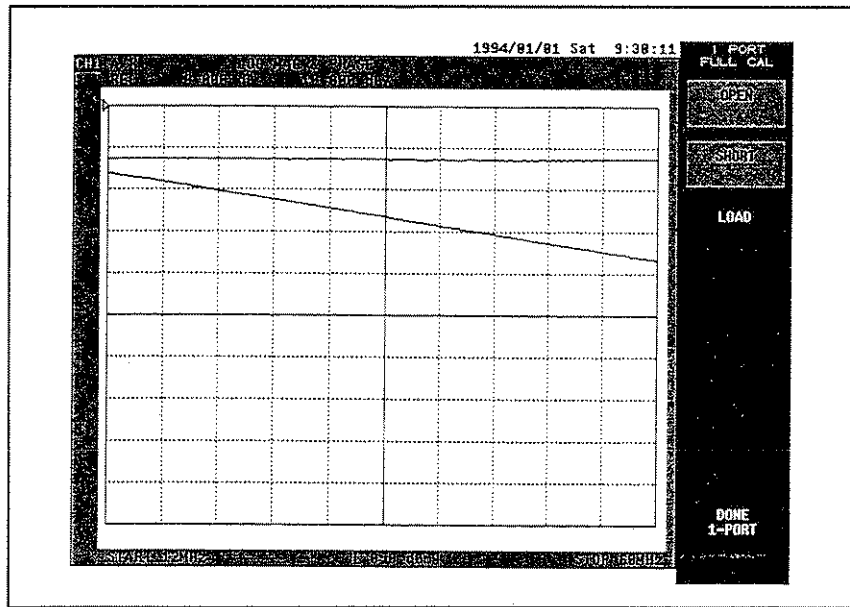

Figure 3-26

- (6) Load standard is connected with the test port of the bridge. And the calibration data is acquired.

LOAD

The display is shown in the figure below.

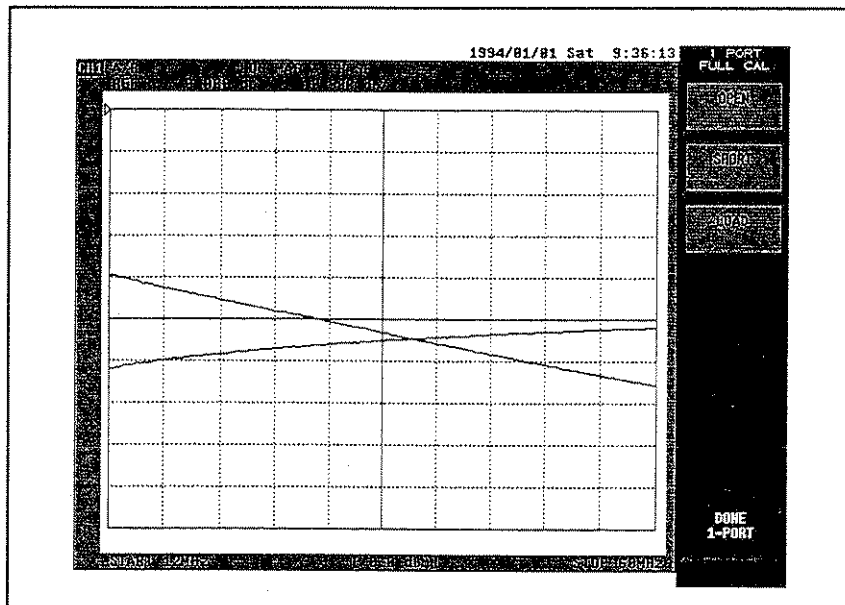

Figure 3-27

- (7) The calibration is ended.

DONE  
1-PORT

The calibration data becomes automatically effective.

(8) DUT (Filter) is connected with the test port of the bridge.

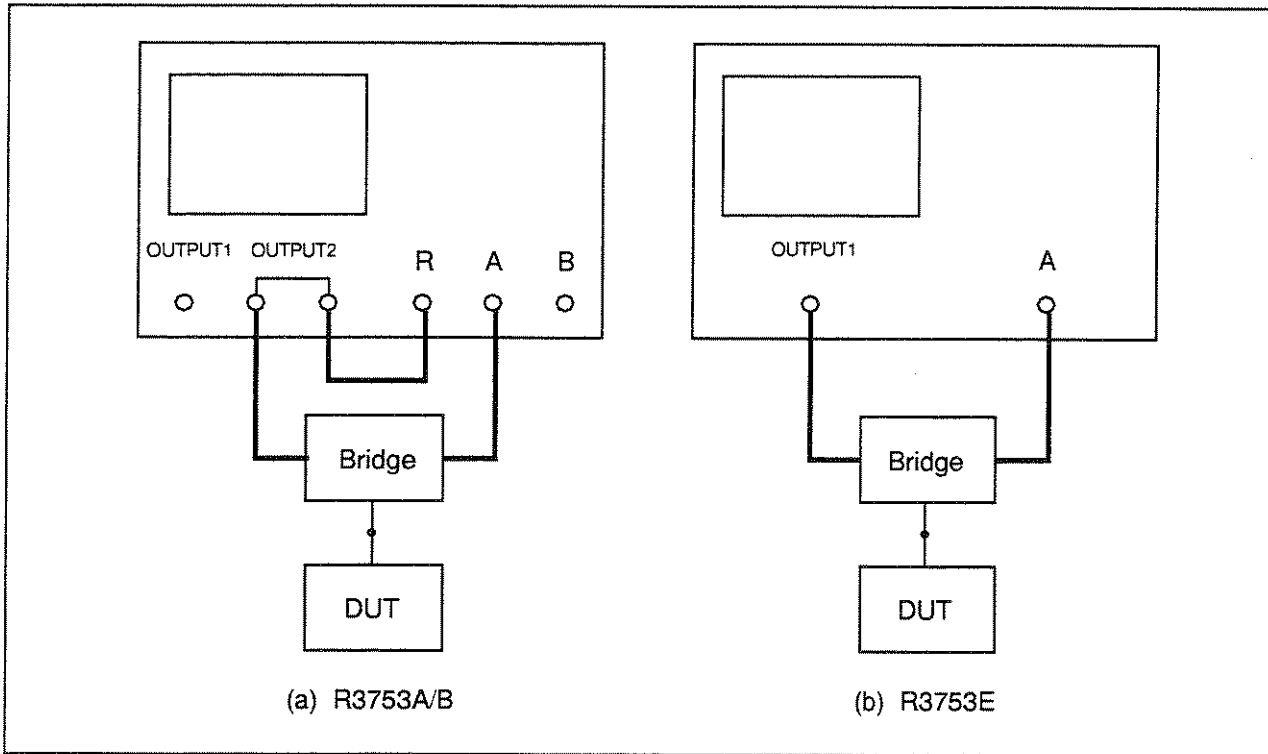

Figure 3-28

- (9) Correct the scale of the display waveform (Amplitude). The display waveform comes to see easily.



The display is shown in the figure below.

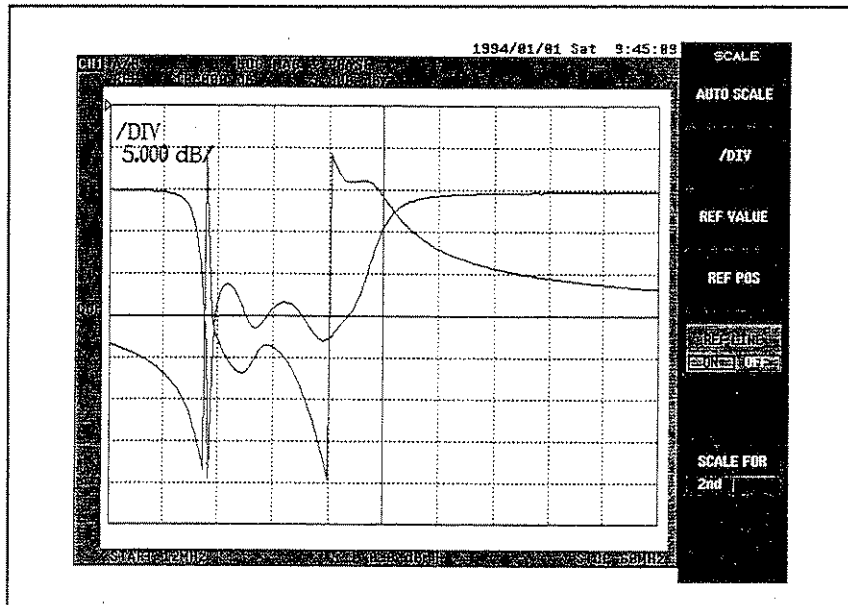

Figure 3-29

(10) Measured data is displayed in Smith chart.



The display is shown in the figure below.

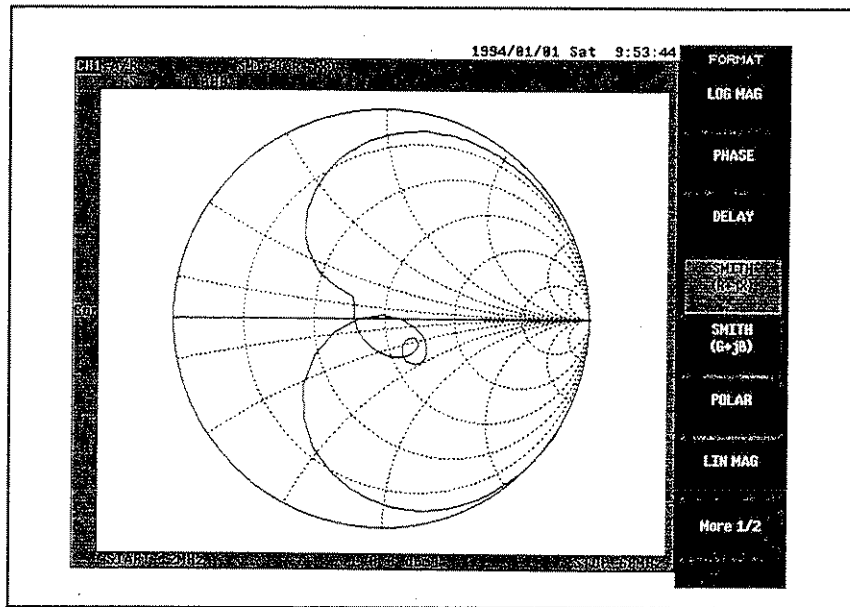

Figure 3-30

(11) Measured data is displayed in the admittance chart.

SMITH  
(G + jB)

The display is shown in the figure below.

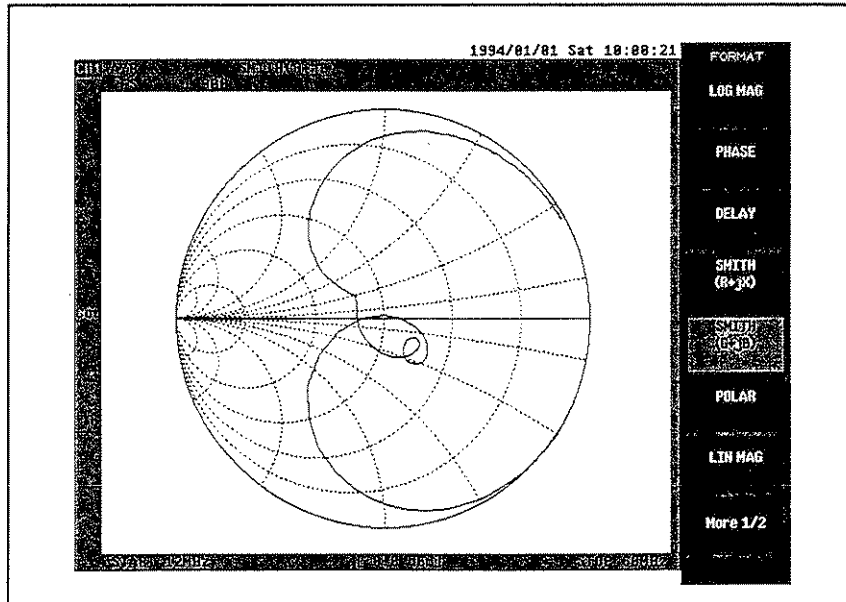

Figure 3-31

(12) Measured data is displayed in the polar coordinates (Polar).

POLAR

The display is shown in the figure below.

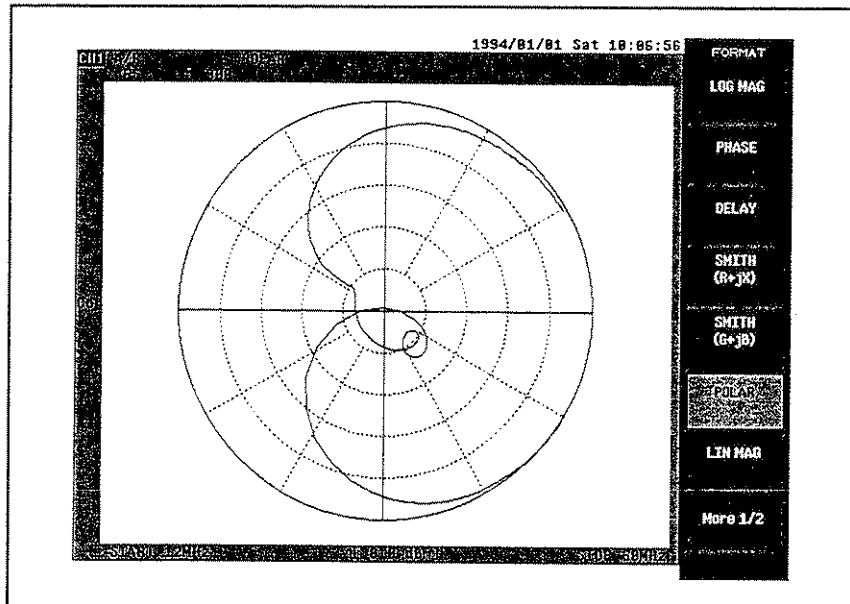

Figure 3-32



(13) The scale is changed. The display is shown in the figure below.



The display is shown in the figure below.

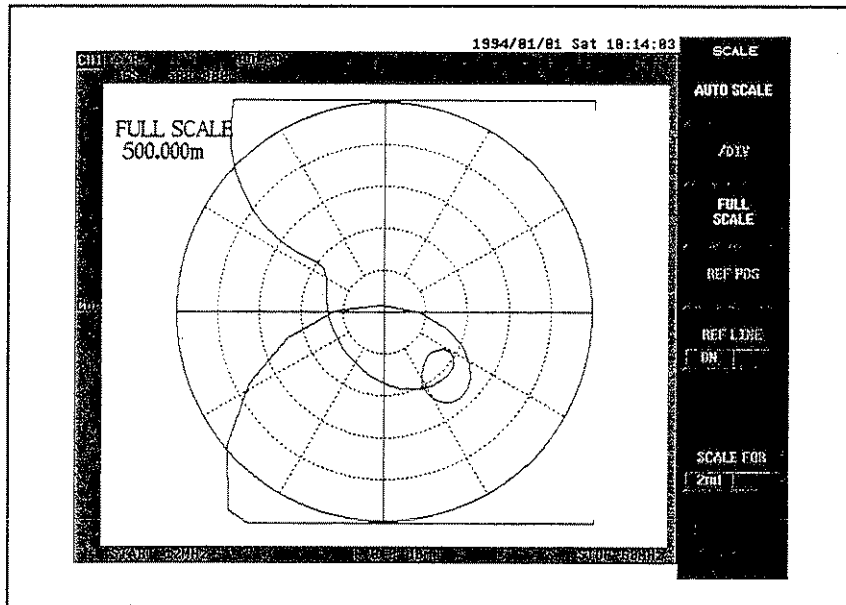

Figure 3-33

2 X1

The display is shown in the figure below.

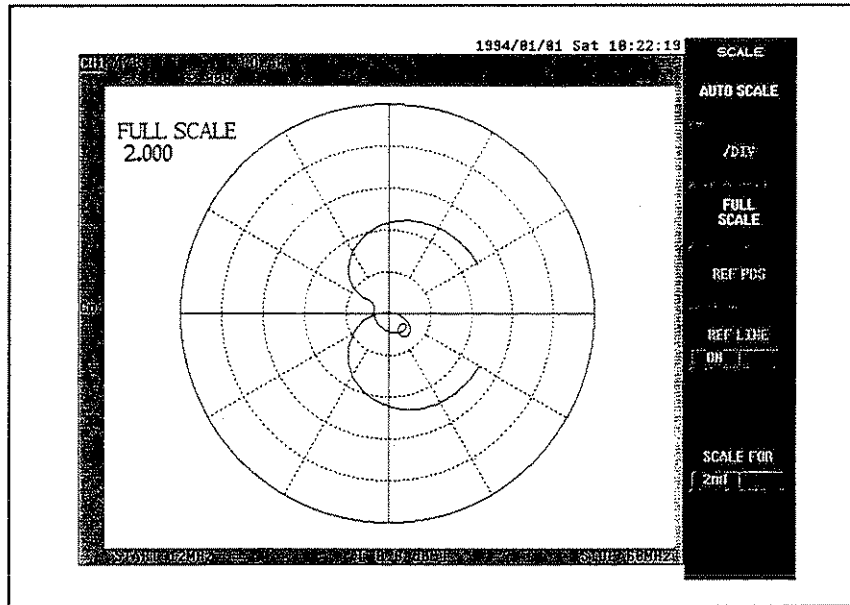

Figure 3-34

### 3.2.10 Measurement of Crystal Resonator

The measurement method the crystal resonator is explained here by the example of the crystal of 42MHz in which  $\pi$  network is used.

- (1) Set it up ( $\pi$  network jig connection). Preset it. Use the PIC-001 pi network jig for the  $\pi$  network jig.
- (2) Install crystal in the test port of the  $\pi$  network jig.

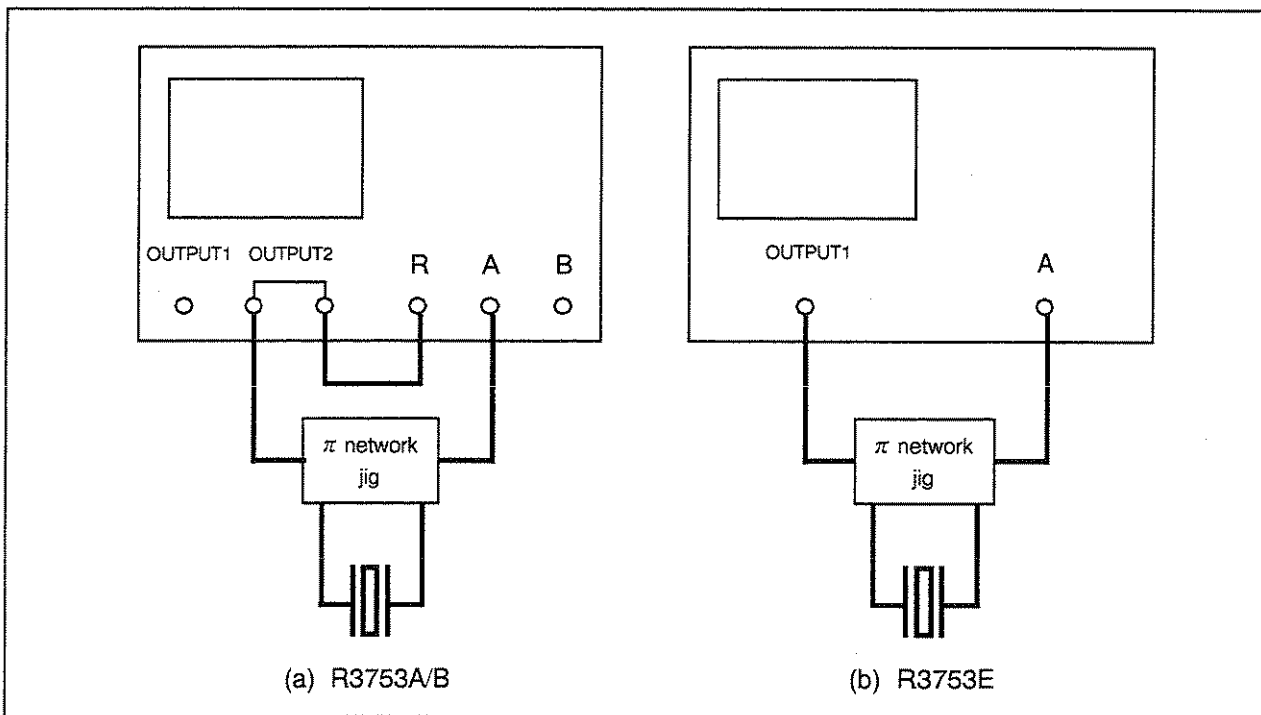
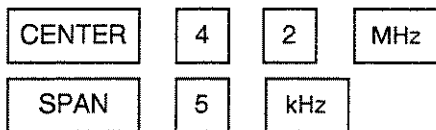
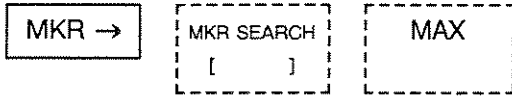

Figure 3-35

- (3) Set center frequency and span.



- (4) The resonance point (Amplitude maximum point) is found by using the marker search function.



The display is shown in the figure below.

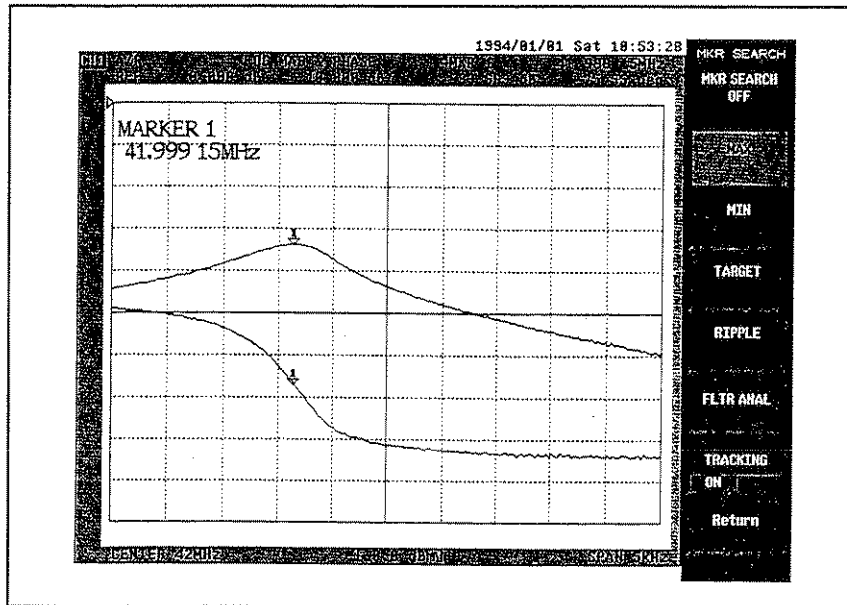

Figure 3-36



- (6) Frequency characteristic is calibrated.  
Install the through (Short) in the test port of the  $\pi$  network jig.

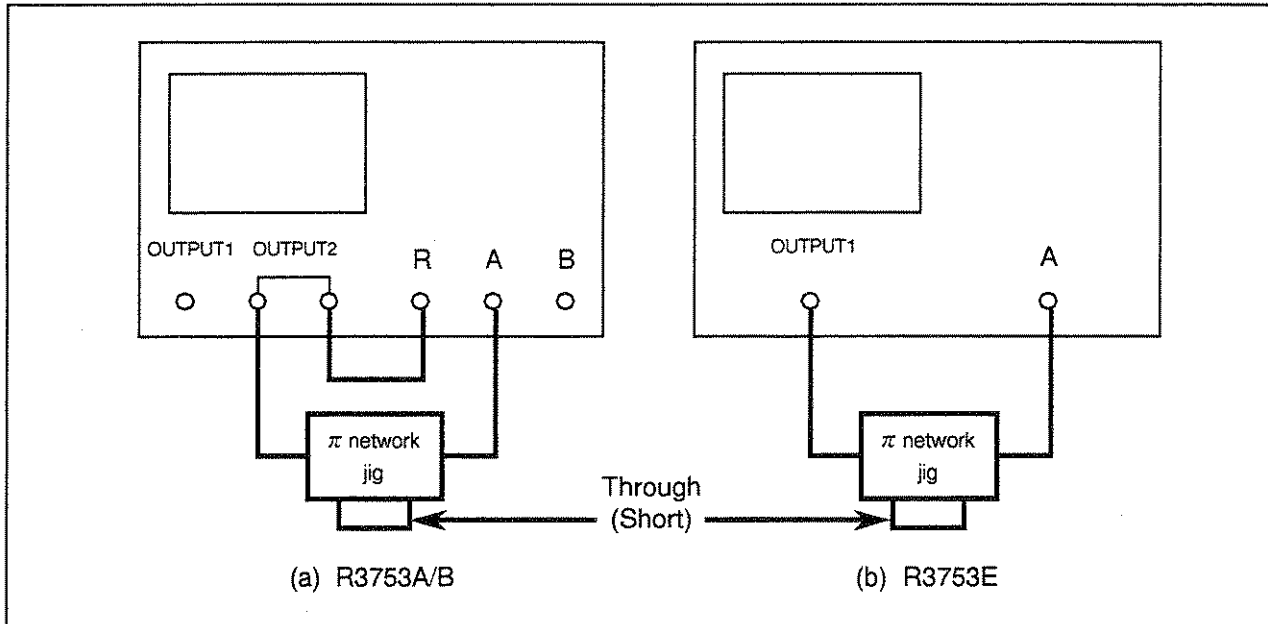
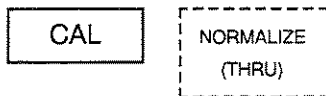

Figure 3-38

Normalization is done.



The display is shown in the figure below.

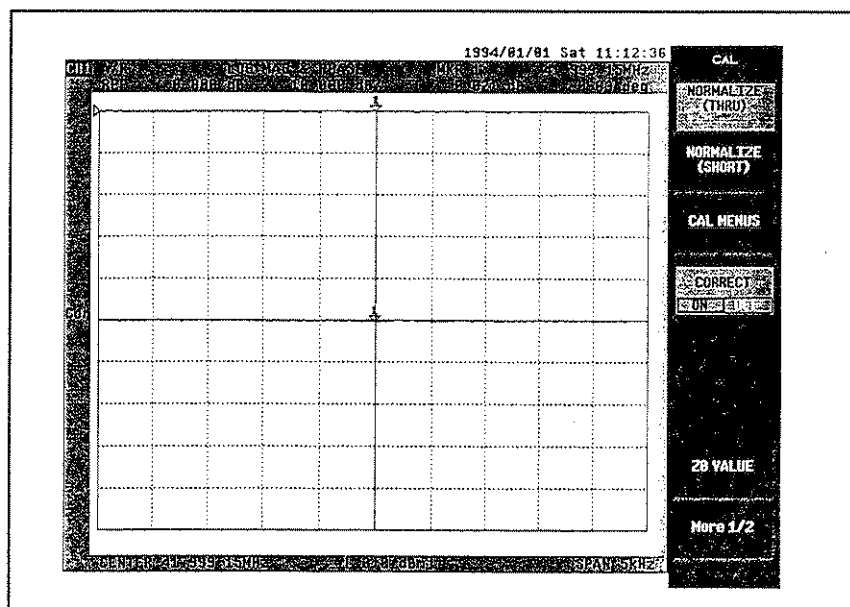
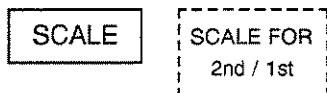

Figure 3-39

Install crystal in the test port of the  $\pi$  network jig again.

- (7) Set the object of the scale change to the second waveform (Phase). As a result, the operation of the marker becomes effective for the second waveform.



(8) The search for phase 0 is executed.



The display is shown in the figure below.

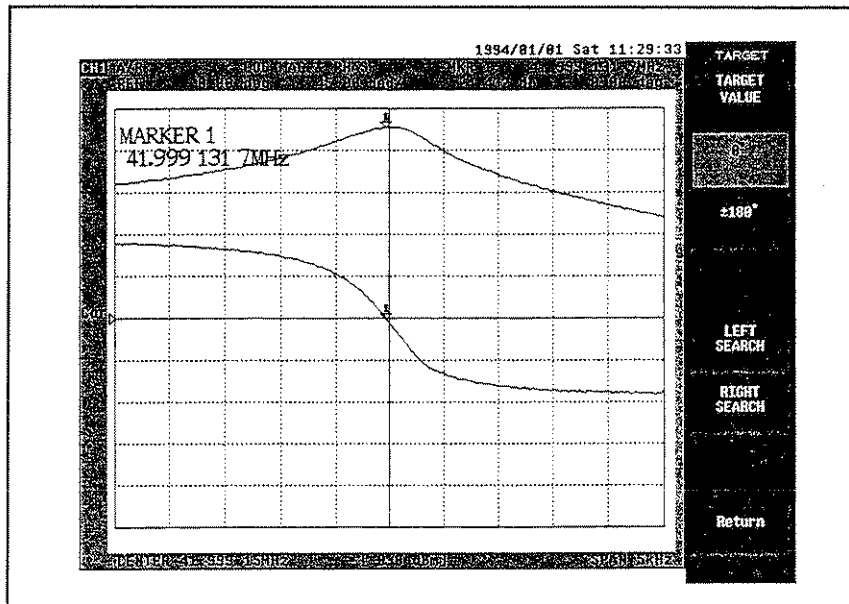

Figure 3-40



- (9) The search for specified phase (45 degree) is executed.



The display is shown in the figure below.

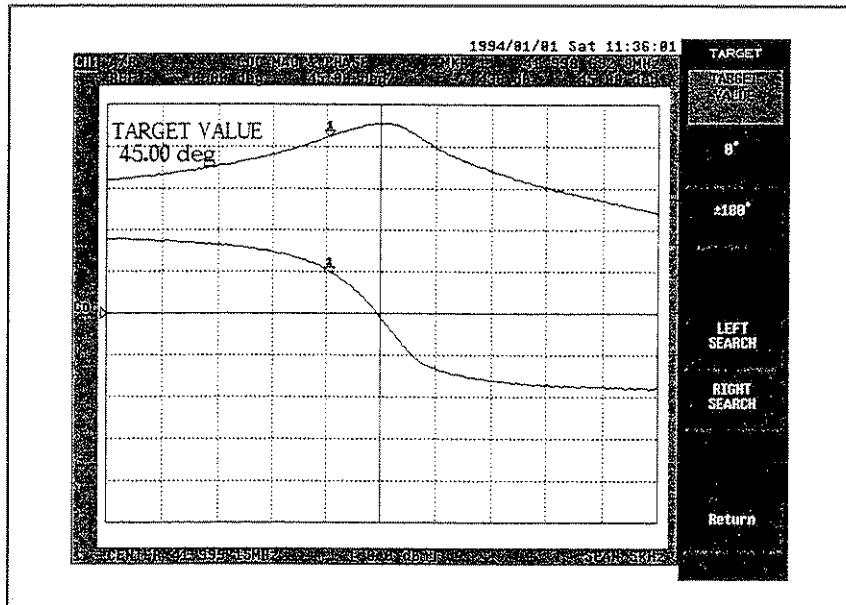
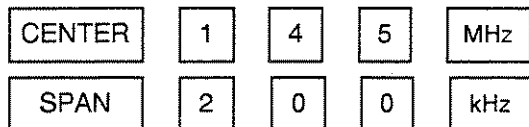

Figure 3-41

### 3.2.11 Measurement with Multi-marker

The method of operation of multi-marker is explained here by example of band pass filter measurement of center frequency 145MHz.

- (1) Setup (Filter connection) and presetting (Refer to 3.1.2 subsections and figures 3-2)
- (2) Set center frequency and span.



- (3) Do calibration of the frequency characteristic.  
 Do similar operation by the item (4) of 3.2.1 Subsection (Measurement of the filter).

(4) Multi-marker is displayed. The marker of 10 maximums a channel can be displayed.

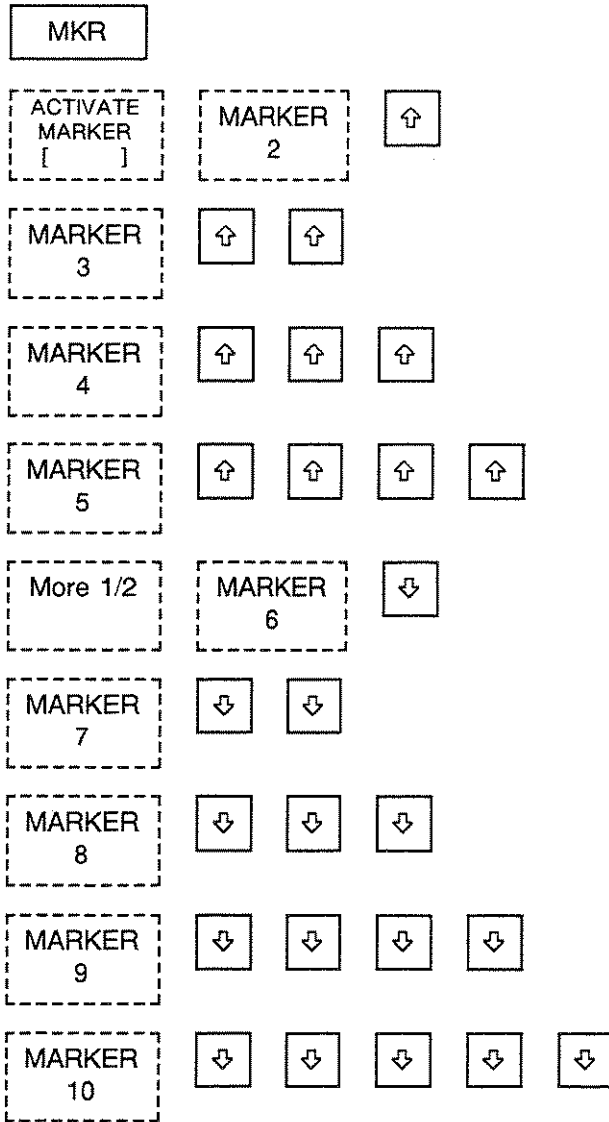

The display is shown in the figure below.

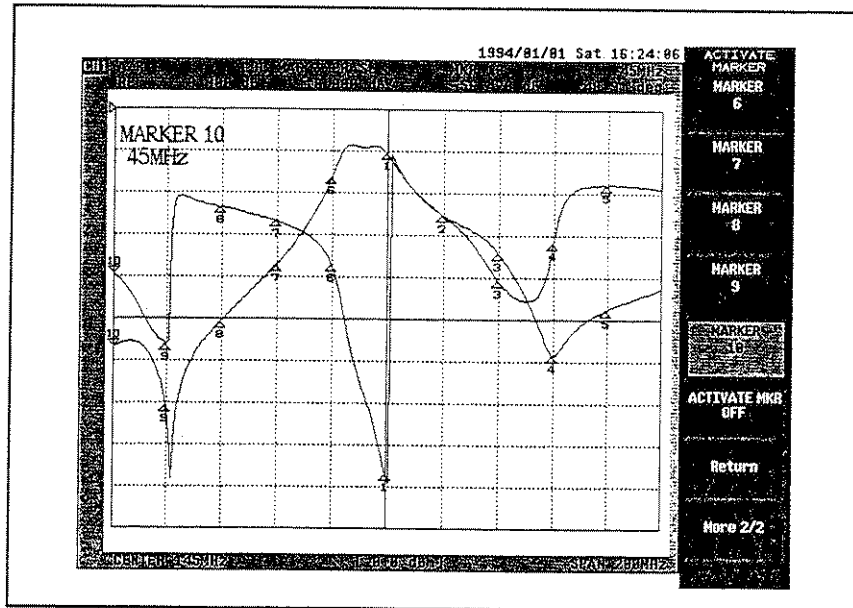

Figure 3-42

(5) The marker list is displayed to read the data of all markers.



The marker list is displayed as shown in the figure below by the above-mentioned operation.

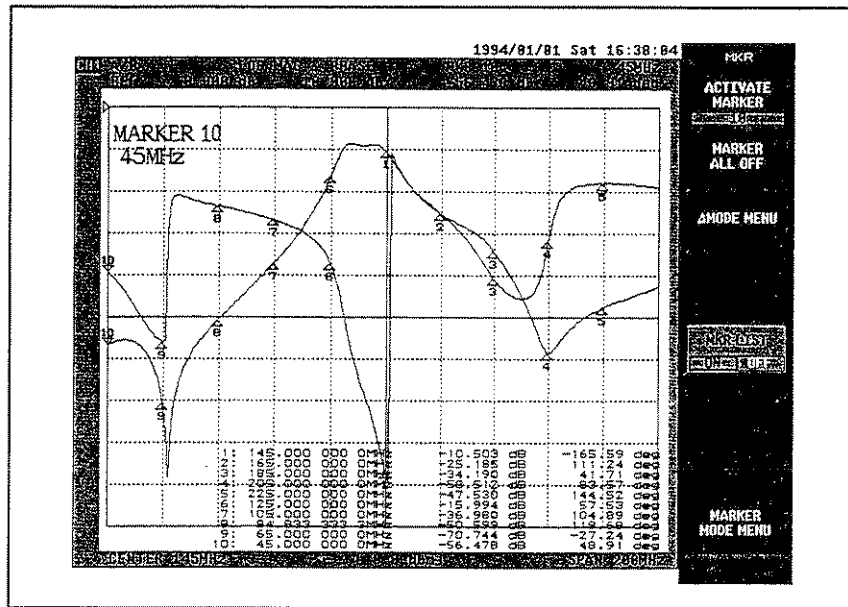
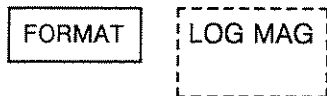

Figure 3-43

### 3.2.12 Measurement with Delta Marker

The operation method for the delta marker is explained here by the example of the band pass filter of center frequency 43MHz.

- (1) Setup (Filter connection) and presetting (Refer to 3.1.2 subsections and figures 3-2)
- (2) Make the measurement format an amplitude (Logarithm display).



- (3) Set center frequency and span.

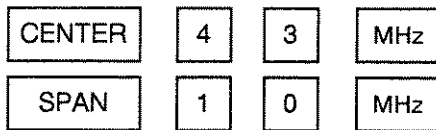

- (4) Correct the scale of the display waveform. The display becomes to see easily.

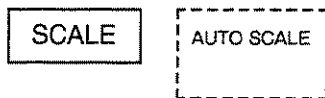

- (5) The difference of the value between two points is requested with a reference marker.



The reference marker appears at the current active marker position. The reference marker is displayed by a red \* sign.

The active marker is moved.

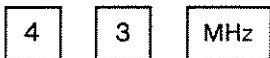

The display is shown in the figure below. The difference of the value of both markers is displayed in the active marker area.

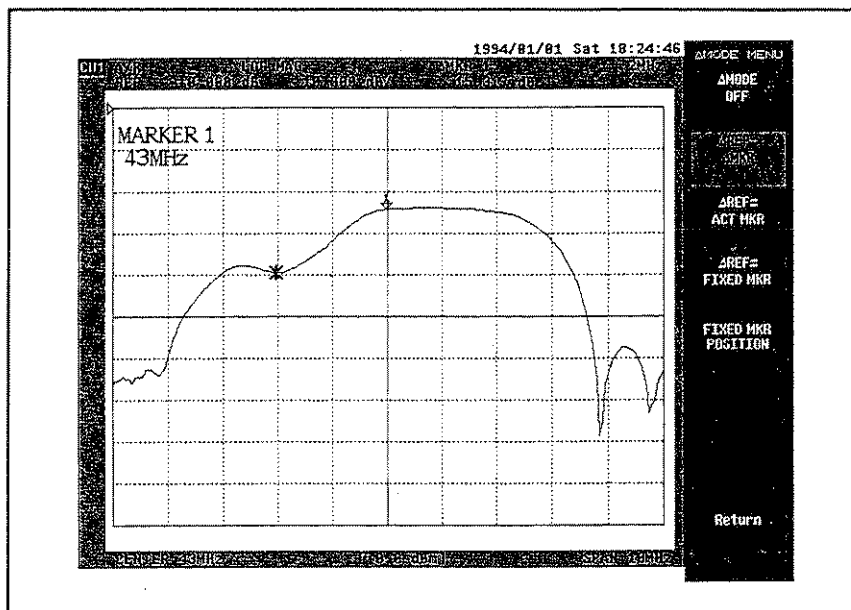
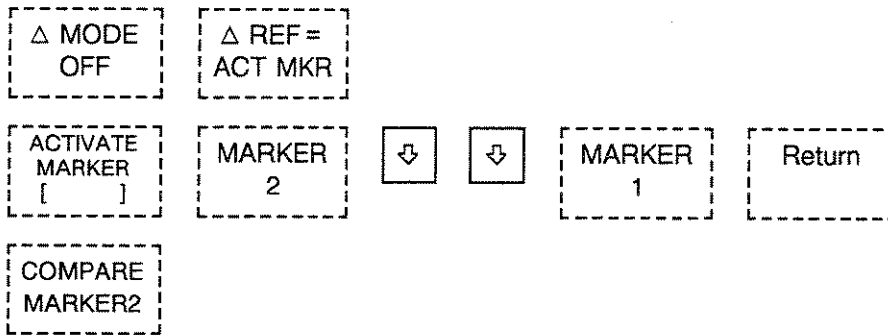

Figure 3-44

- (6) The difference of the value between two points is obtained by using the comparison between markers.



The display is shown in the figure below. The difference of the value of both markers is displayed in the active marker area.

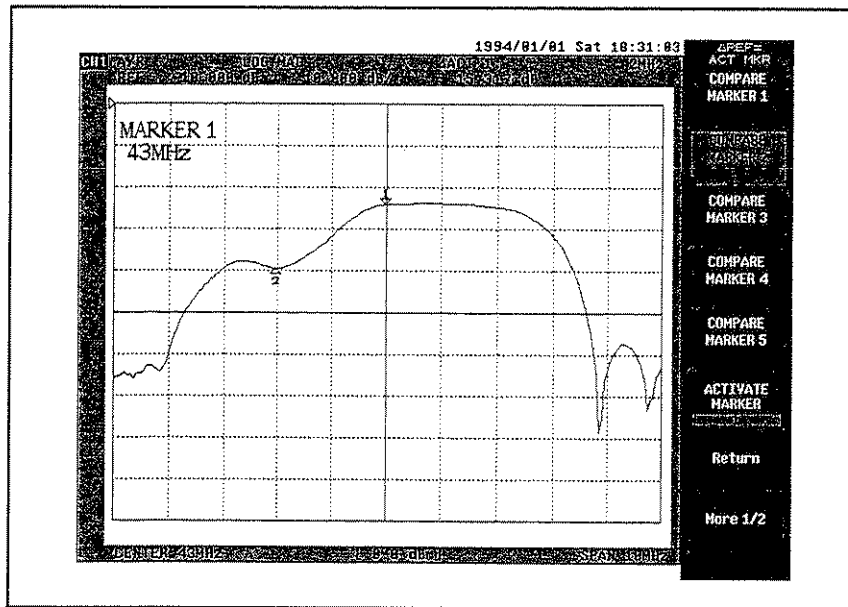
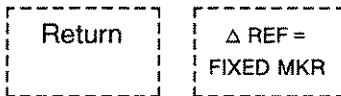

Figure 3-45

- (7) The difference between two points is obtained with a fixed marker.



The fixed marker appears at the center of the screen. The fixed marker is shown by a red  $\diamond$  sign. And it can be fixed to an arbitrary position without any relation to the waveform.

The position of the fixed marker is moved.



The fixed marker moves to the position of -10dB of vertical axis. The display is shown in the figure below. The difference between the fixed marker value and the active marker value is displayed in the active marker area.

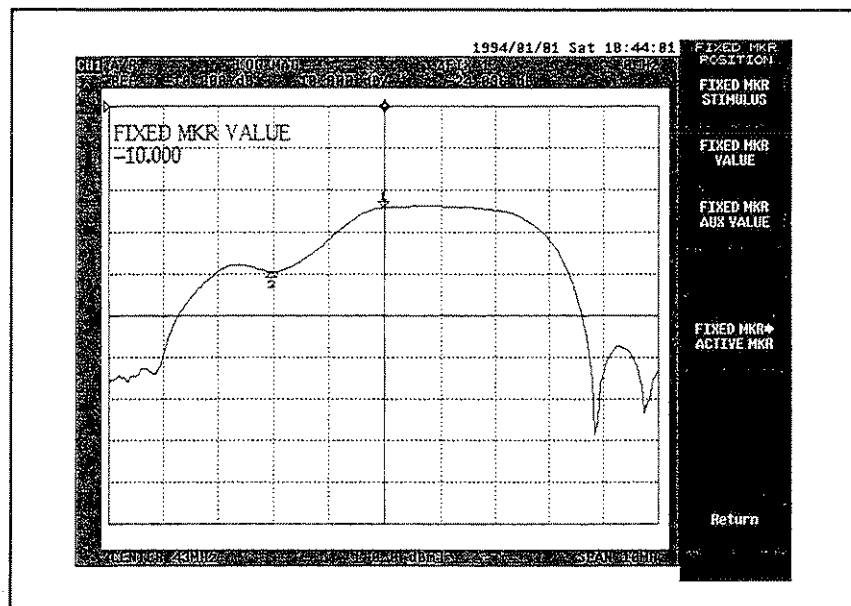

Figure 3-46



### 3.2.13 Delta Section Marker Analysis

The partial (Delta section) analysis operation method is explained here by the example of the band pass filter of center frequency 43MHz.

- (1) Setup (Filter connection) and presetting (Refer to 3.1.2 subsections and figures 3-2)
- (2) The measurement format is made an amplitude (Logarithm display).



- (3) Set center frequency and span.

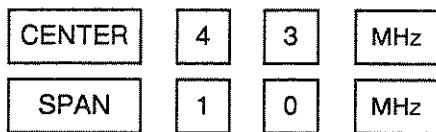

- (4) Correct the scale of the display waveform. The display becomes to see easily.



- (5) The delta section is specified.  
The marker 1 is moved to a suitable position with the data knob.



The reference marker is set up to the position of the marker 1.

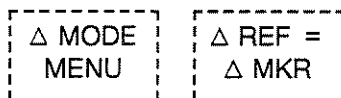

The marker 1 is moved to a suitable position again with the data knob



The display is shown in the figure below. The area between the reference marker and the marker 1 becomes a delta section.

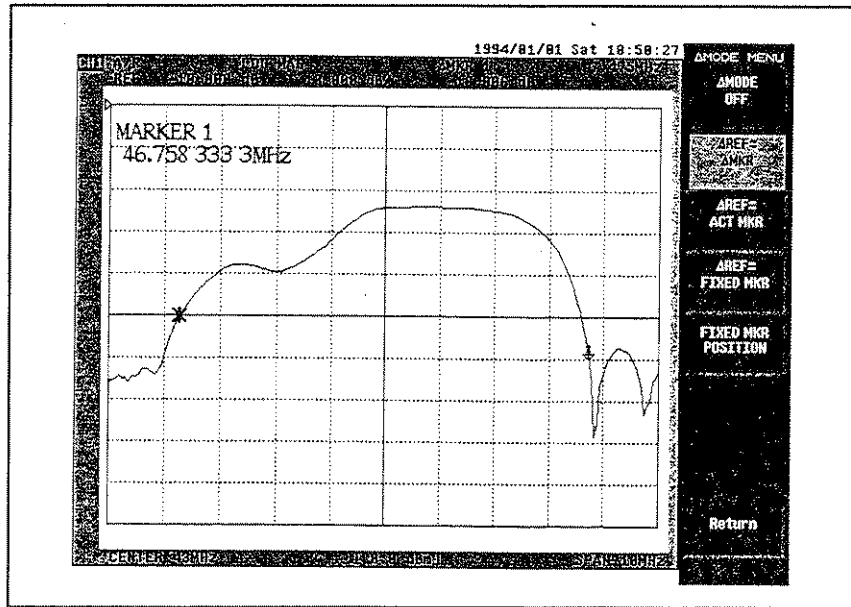
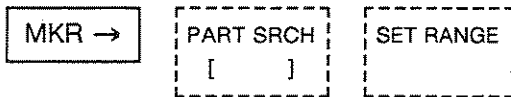

Figure 3-47

- (6) The delta section is specified within the range of a partial analysis.



- (7) A partial analysis is enabled.

PART SRCH  
ON / OFF

The display is shown in the figure below.

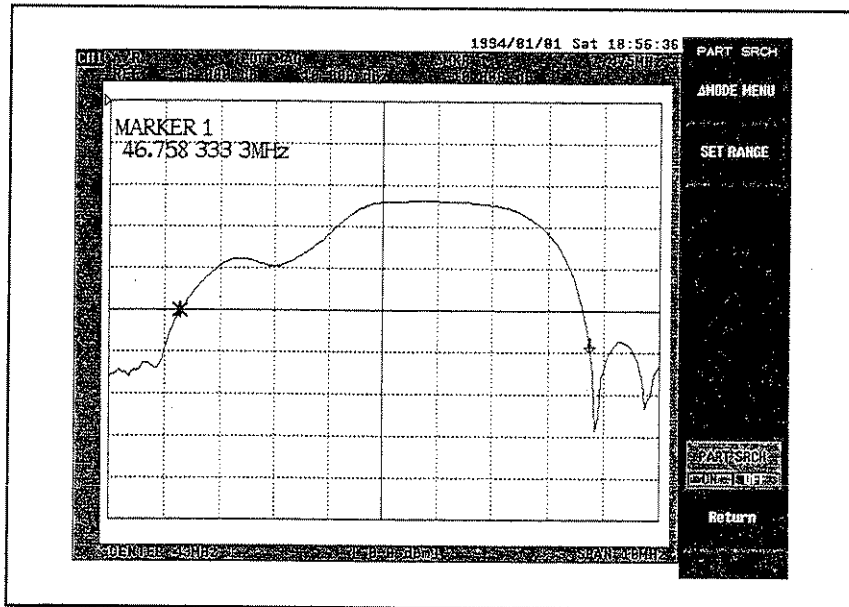

Figure 3-48

(8) The maximum value in the delta section is searched.



The display is shown in the figure below.

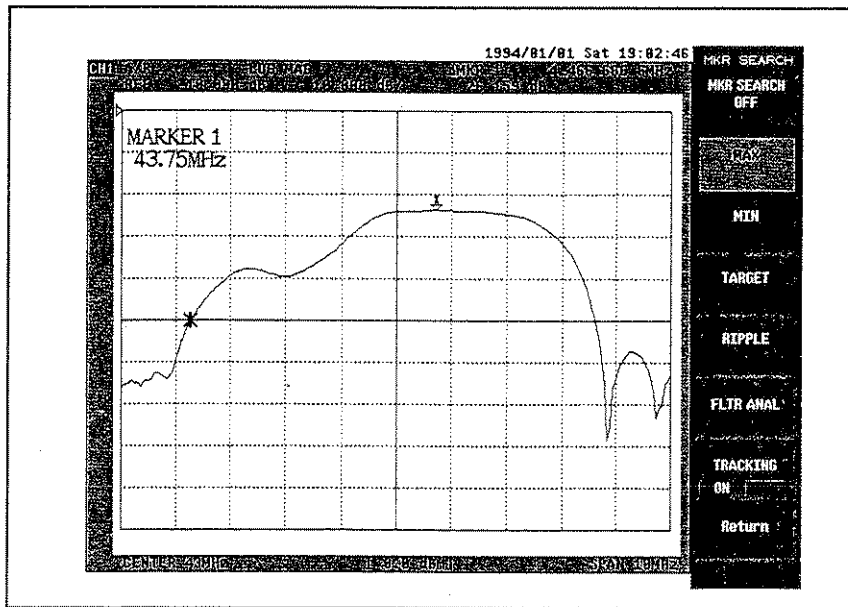

Figure 3-49

- (9) Minimum value search in the delta section is executed.



The display is shown in the figure below.

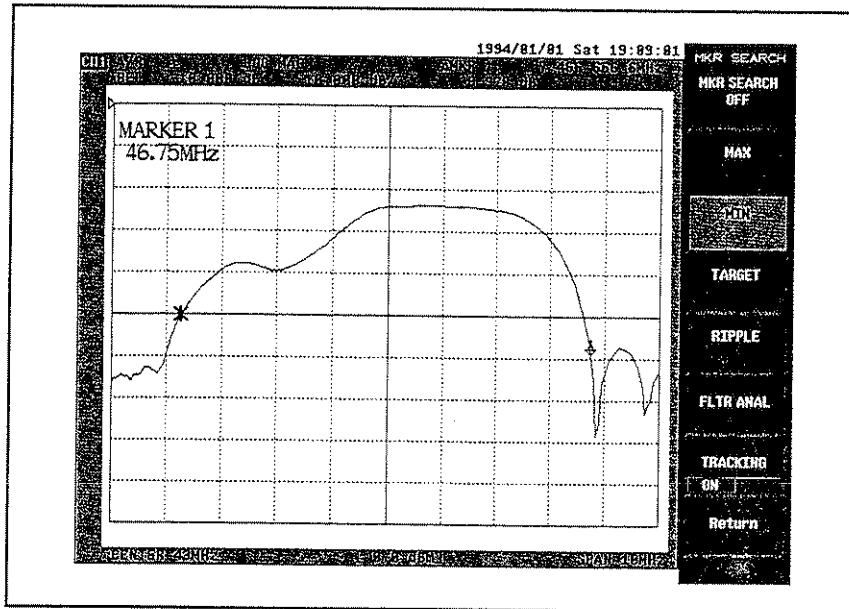
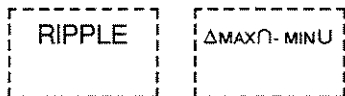

Figure 3-50

(10) The ripple search in the delta section is executed.



The reference marker moves to a minimum point in the local minimum peak. And the active marker moves to the point of the maximum in the local maximum peak. The display is shown in the figure below. The difference of the value of both markers is displayed in the active marker area.

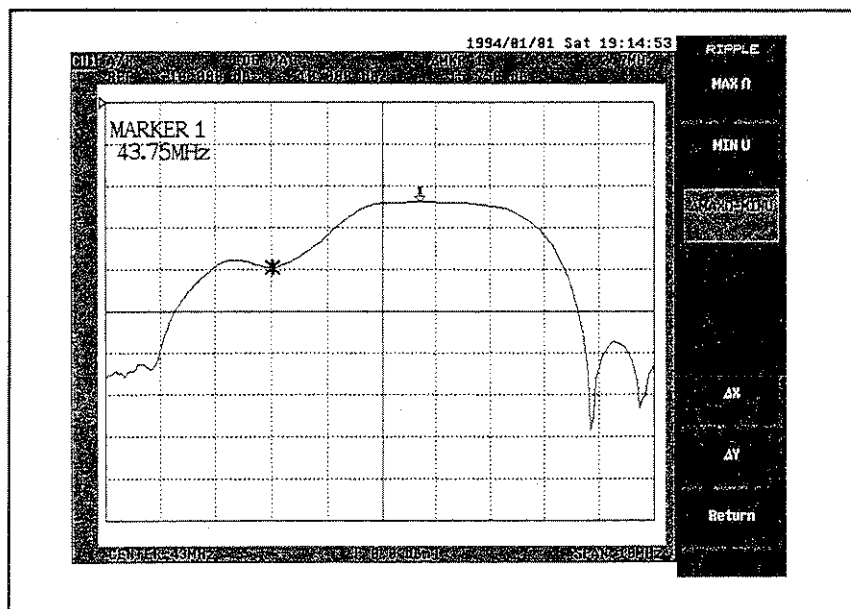
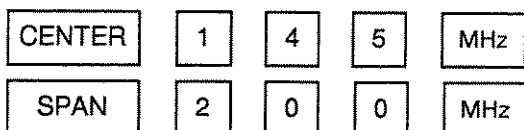

Figure 3-51

### 3.2.14 Measurement by Marker of →

The method of operation of the marker → is explained here by the example the band pass filter measurement of center frequency 145MHz .

- (1) Setup (Filter connection) and presetting (Refer to 3.1.2 subsections and figures 3-2)
- (2) Set center frequency and span.



- (3) The amplitude maximum point is searched by displaying the marker.

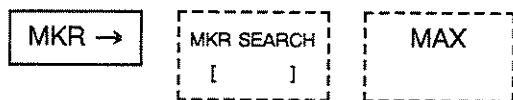

The display is shown in the figure below by the above-mentioned operation.

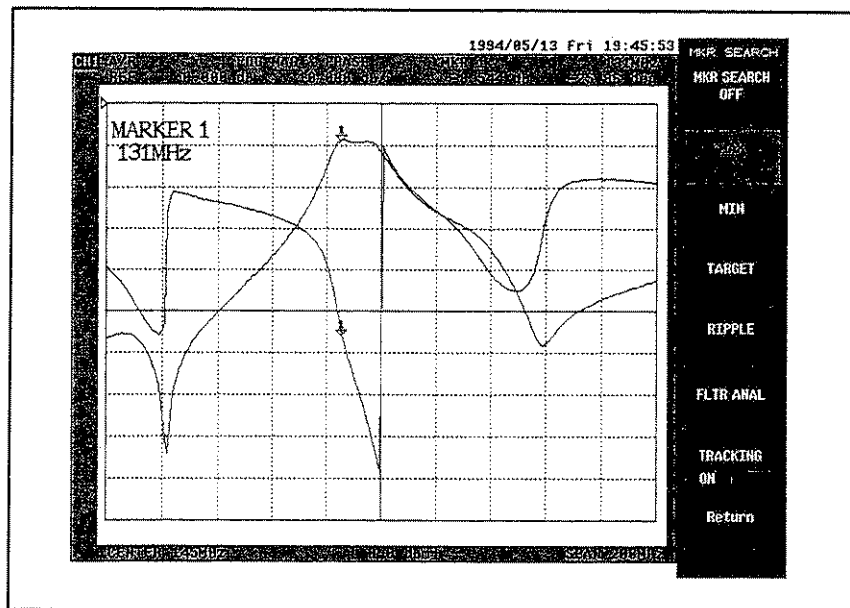

Figure 3-52

- (4) The center frequency is adjusted to the marker value by the marker →.

Return

MARKER →  
CENTER

The display is shown in the figure below by the above-mentioned operation.

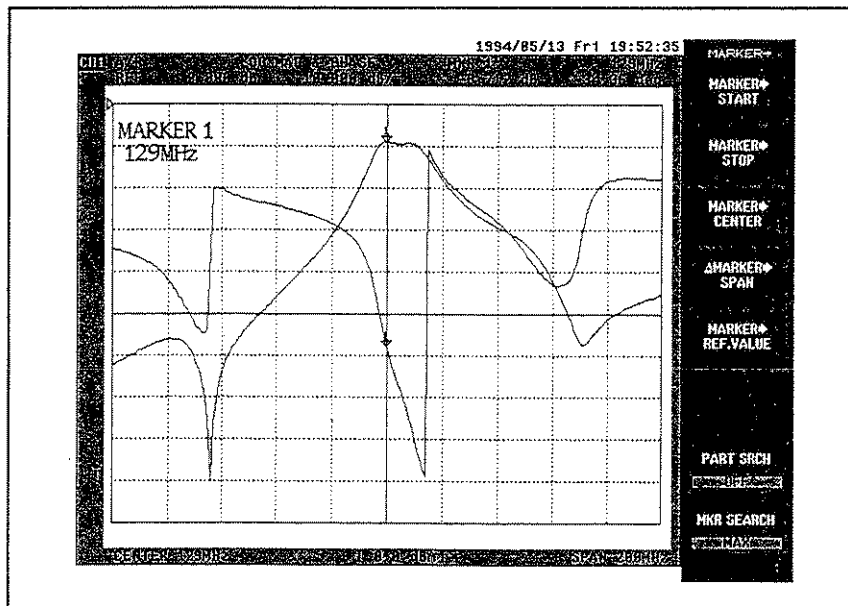

Figure 3-53



(5) Span is expanded by the marker →. From 80MHz to 160MHz is displayed here.

8 0 MHz

: The active marker is moved to 80MHz.

MKR Δ MODE MENU Δ REF =  
Δ MKR

1 6 0 MHz

: The active marker is moved to 160MHz.

MKR → Δ MARKER →  
SPAN

The display is shown in the figure below by the above-mentioned operation.

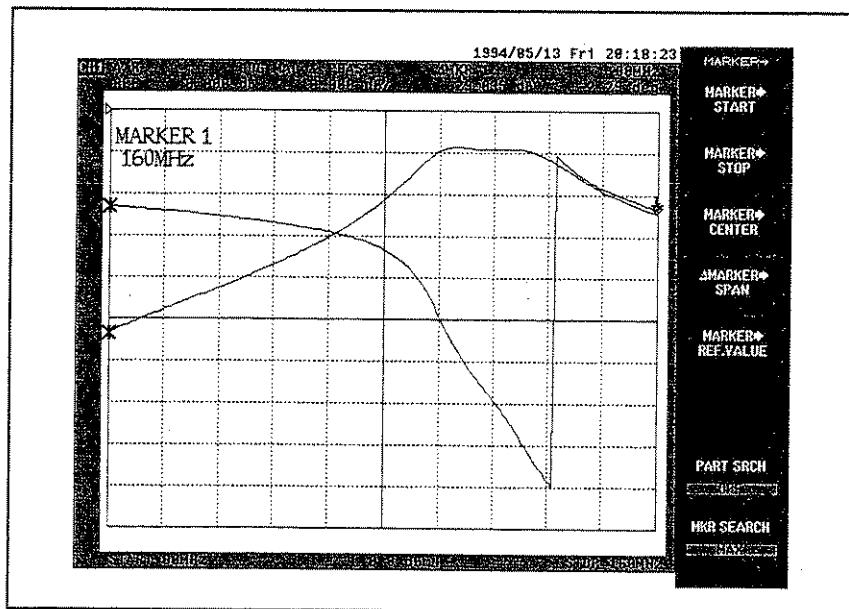

Figure 3-54

The section specified with the delta marker is displayed.

### 3.2.15 Measurement with Coupling of Marker Interpolation Marker

The operation method of the interpolation marker and the coupling marker is explained here by the example the band pass filter measurement of center frequency 145MHz.

- (1) Setup (Filter connection) and presetting (Refer to 3.1.2 subsections and figures 3-2)
- (2) Set center frequency and span.

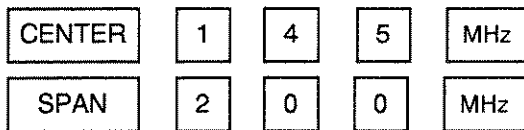

- (3) Make the format of the channel 1 an amplitude (Logarithm display).

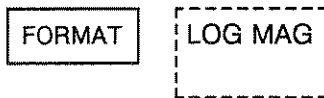

- (4) Set the active channel to the channel 2. Make the format of the channel 2 a phase.

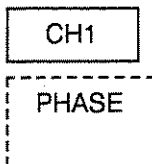

- (5) The active channel is returned to the channel 1. And both channels are displayed simultaneously.

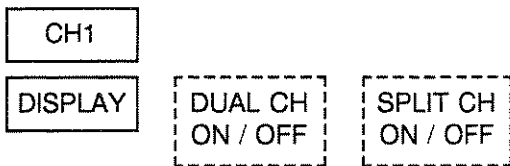

- (6) The marker is displayed and moved to 135.5MHz.

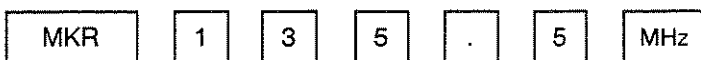

- (7) The marker mode menu is displayed.

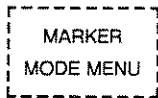

The display is shown in the figure below by the above-mentioned operation.

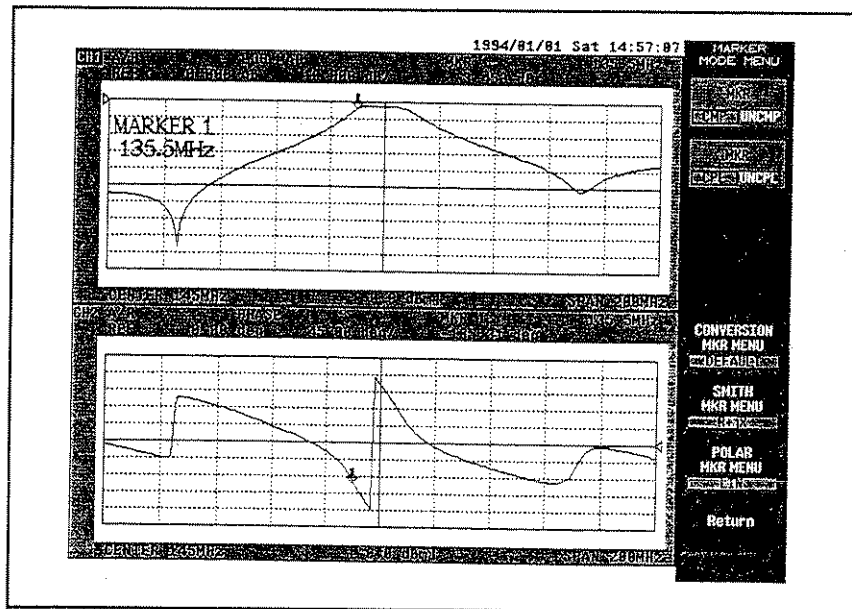
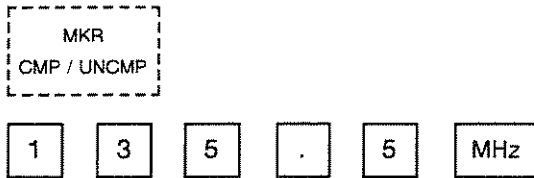

Figure 3-55

MKR CMP (Marker compensation mode) is selected. Therefore, the marker is interpolated. As a result, the value not on the measurement point is displayed by using the value on interpolation point.

Moreover, because MKR CPL (Marker coupling mode) is selected when the marker of the channel 1 moves, the marker of the channel 2 will move according to it.

- (8) Setting MKR UNCMP (Marker un-compensation mode). Move the marker to 135.5MHz.



The display is shown in the figure below by the above-mentioned operation.

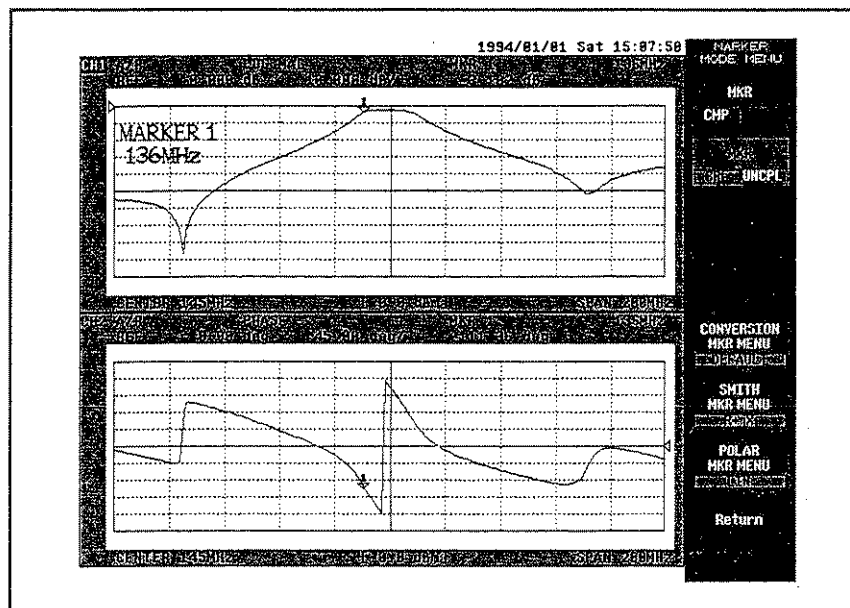

Figure 3-56

When MKR UNCMP (Marker compensation mode) is selected, the marker moves to 136MHz with the actually measured point because the marker will not be interpolated.

- (9) Set it in MKR UNCPL (Markers uncouple mode). Move the marker.

MKR  
 CPL/UNCPL



The display is shown in the figure below by the above-mentioned operation.

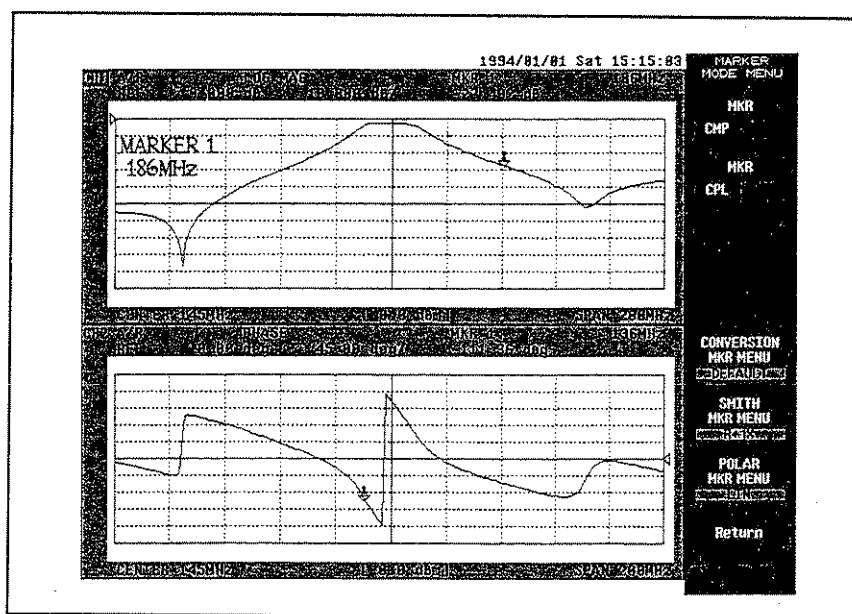

Figure 3-57

MKR UNCPL (Markers uncouple mode) is selected. Therefore the coupling of the marker is not done, and the marker on each channel moves independently.

### 3.2.16 Measurement in which Use of Program Sweep

The program sweep method of operation is explained here by the example of the band pass filter measurement of center frequency 21.4MHz.

- (1) Setup (filter connection) and presetting (Refer to 3.1.2 subsections and figures 3-2)
- (2) The measurement format is made an amplitude (Logarithm display).

FORMAT

LOG MAG

(3) Set center frequency and span.

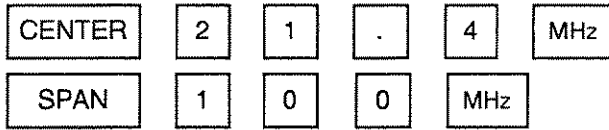

(4) Set the scale (Display coordinates). Set the value of the reference to -20dBm here.



The display is shown in the figure below by the above-mentioned operation.

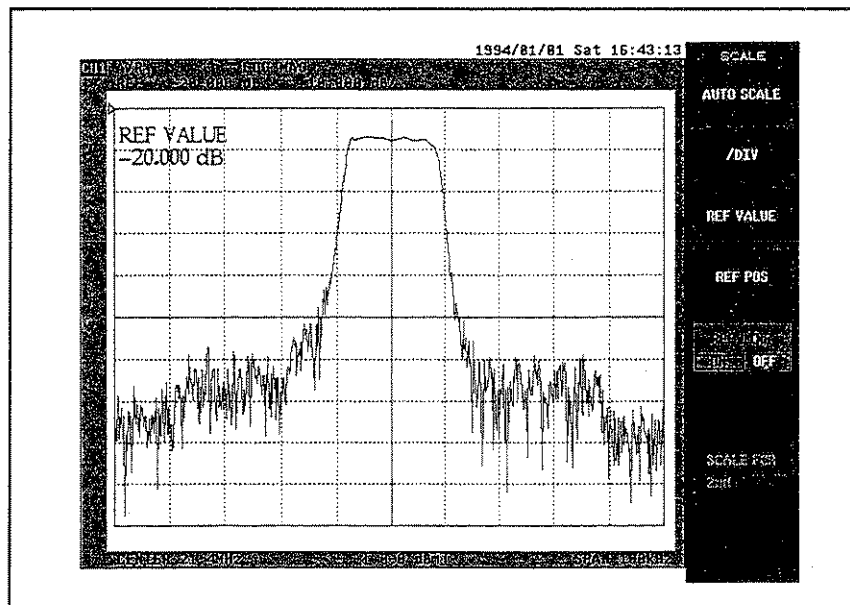

Figure 3-58

Next, specific frequency range of this filter is expanded and is measured by using the program sweep.

Three parts of 21.360MHz to 21.390MHz, 21.392MHz to 21.408MHz, 21.410MHz to 21.440MHz are expanded and are measured here.

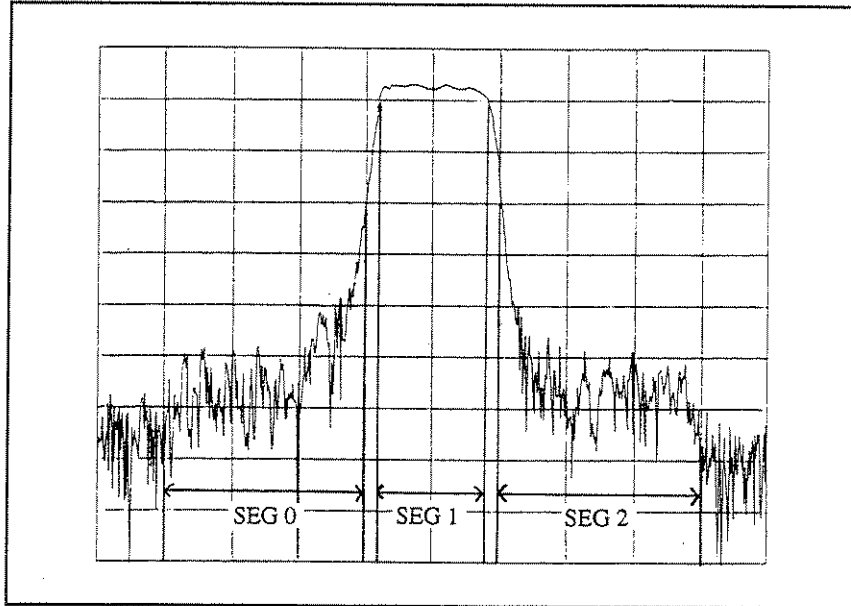

Figure 3-59

- (5) Each set value of the program sweep is edited. The data is set here in the three segments of 0, 1, and 2 separately.

MENU	SWEEP TYPE [ ]		EDIT PROG SWEEP				
SEGMENT NUMBER	0	X1					
START	2	1	.	3	6	0	MHz
STOP	2	1	.	3	9	0	MHz
POINT	2	0	0	X1			
SEGMENT NUMBER	1	X1					
START	2	1	.	3	9	2	MHz
STOP	2	1	.	4	0	8	MHz
POINT	2	0	0	X1			
SEGMENT NUMBER	2	X1					
START	2	1	.	4	1	0	MHz
STOP	2	1	.	4	4	0	MHz
POINT	2	0	0	X1			



- (6) Set the sweep type to the program sweep.



The display is shown in the figure below by the above-mentioned operation.

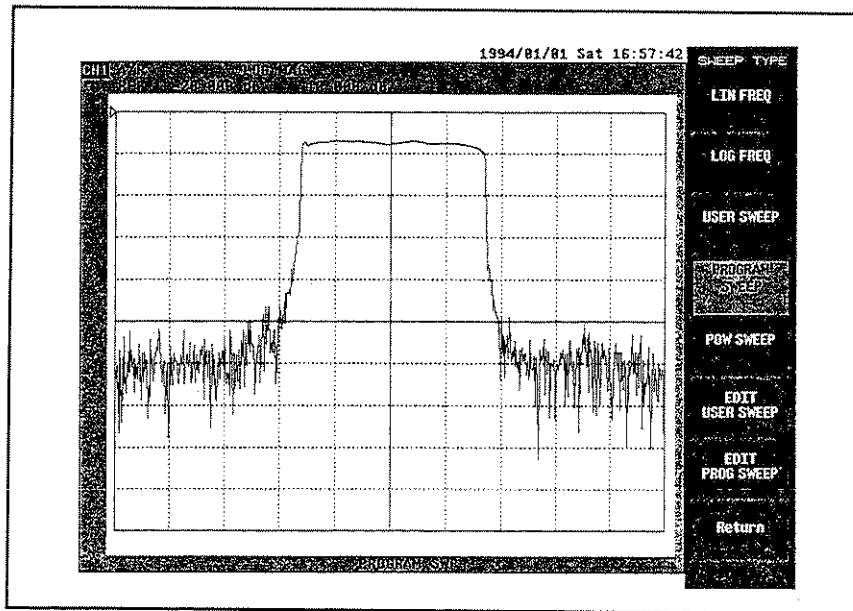

Figure 3-60

(7) Output level and resolution bandwidth of segment 0 are changed.

EDIT PROG SWEEP				
SEGMENT NUMBER	0	X1		
More 1/2				
SEGMENT POWER	5	.	0	X1
IF RBW [ ]	1	kHz		
Return				
PROGRAM SWEEP				

The display is shown in the figure below by the above-mentioned operation.

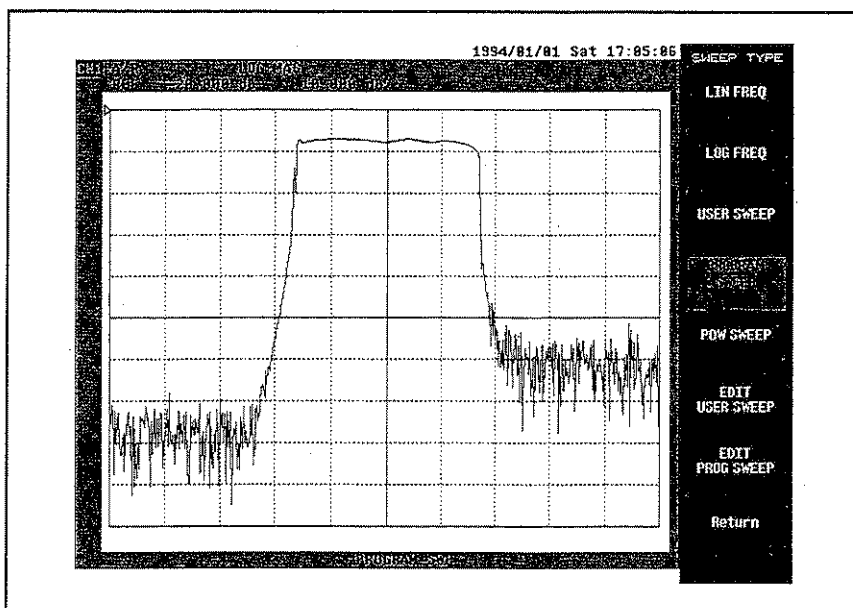

Figure 3-61

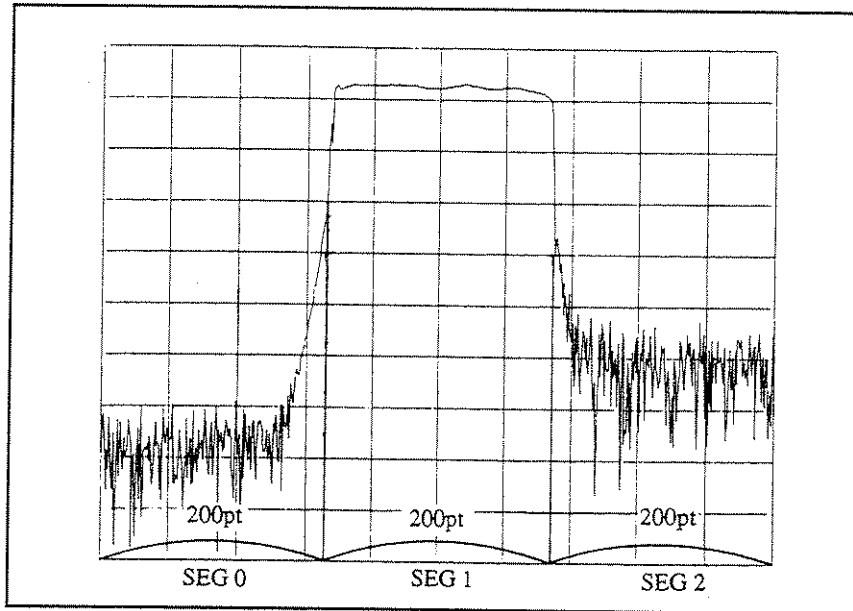

Figure 3-62

The data of each segment is edited and shows the result in the following.

SEG	START	STOP	POWER	IF RBW	POINT
0	21.360MHz	21.390MHz	5.0dBm	1kHz	200
1	21.392MHz	21.408MHz	0.0dBm	10kHz	200
2	21.410MHz	21.440MHz	0.0dBm	10kHz	200

### 3.2.17 Measurement of Resonance Point and Antiresonance Point of Ceramic Oscillation Element (f = 42.0MHz)

The resonance point and antiresonance point of ceramic oscillation element (f = 42.0MHz) are measured here by the transmission measurement.

- (1) Setup ( $\pi$  network jig connection).  
 The PIC-001  $\pi$  network jig is used.

(2) Install crystal in the test port of the  $\pi$  network jig.

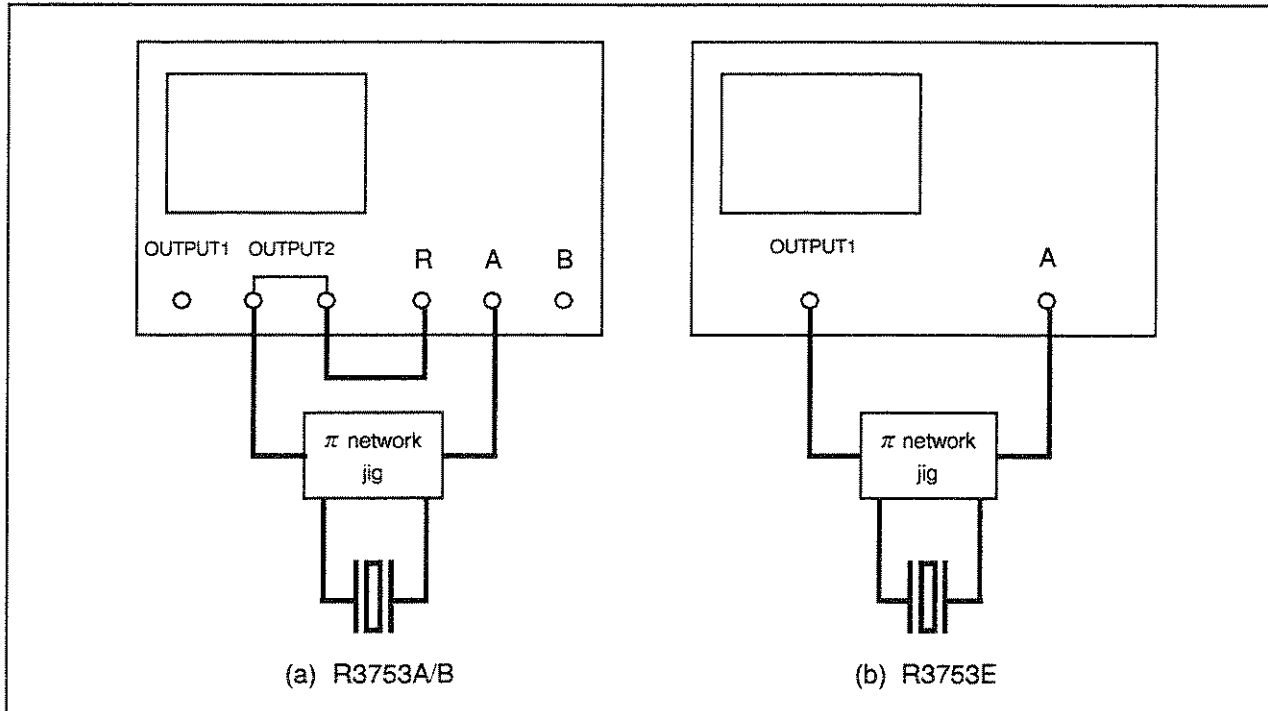
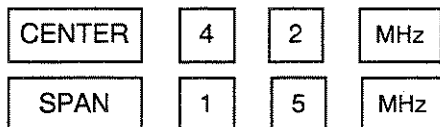
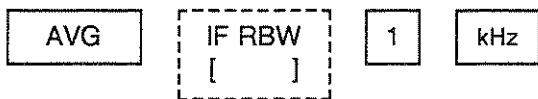

Figure 3-63

(3) Set center frequency and span.



(4) Set resolution bandwidth. At this time, sweep time is automatically set.



(5) Calibrate frequency characteristic.

Install the through (Short) in the test port of the  $\pi$  network jig.

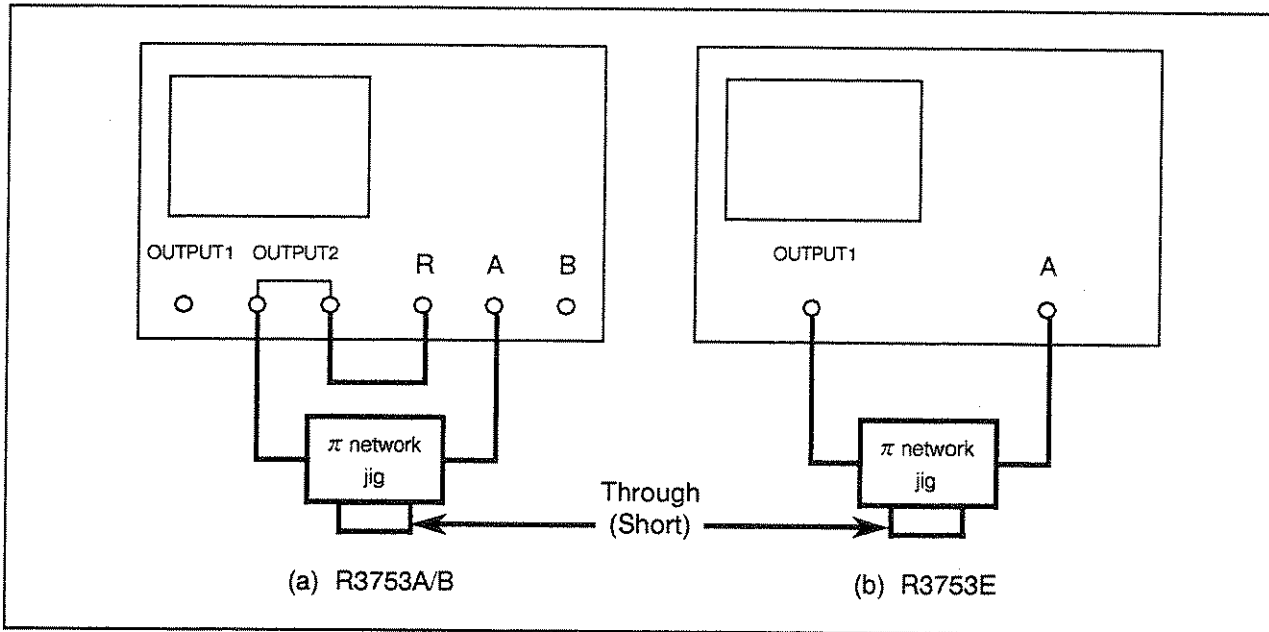
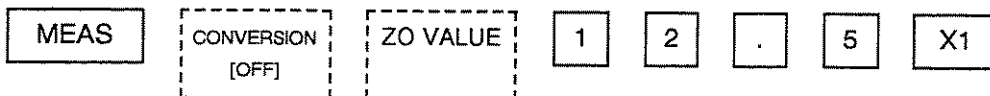

Figure 3-64



After ending, return it to the connection of (1).

- (6) Set the characteristic impedance of the  $\pi$  network jig. The characteristic impedance of the treatment device used is  $12.5\Omega$  at this time. Set this value.



- (7) Select the impedance conversion by the transmission measurement.

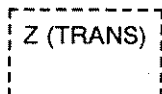

- (8) Correct the scale of the display waveform (Amplitude). The display becomes to see easily.



- (9) The marker is displayed to read the measured value directly. The marker data display modes are changed.

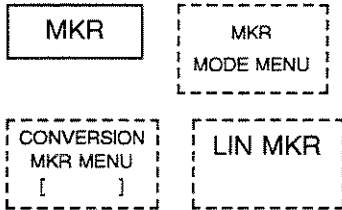

Display screen is shown in the figure below by the above-mentioned operation.

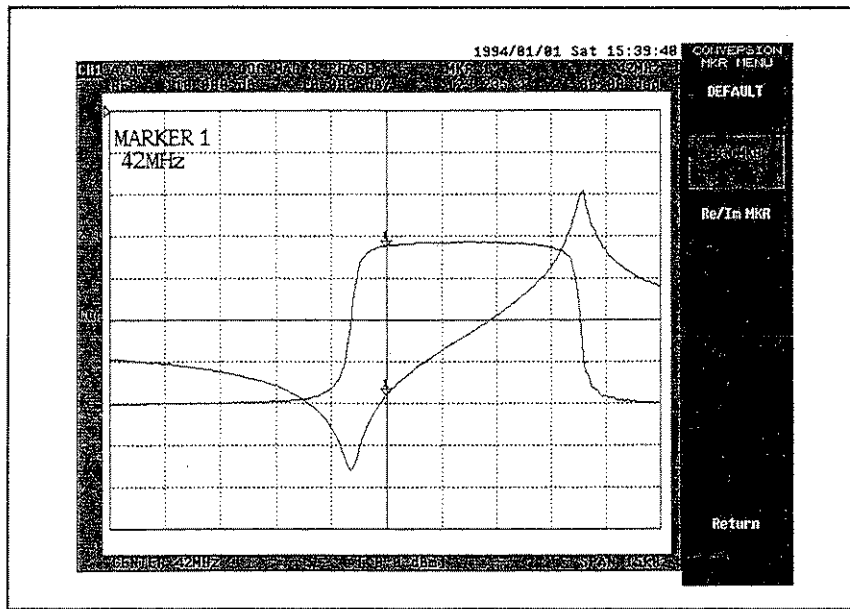
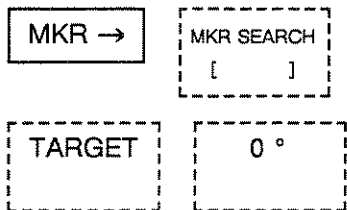

Figure 3-65

Thus, when the impedance conversion is selected, impedance and the phase can be read directly by using the marker.

- (10) The search for the phase  $0^\circ$  is executed to search the resonance point.



(11) Display of marker 2. The search for the phase 0 ° is executed to search antiresonance point.

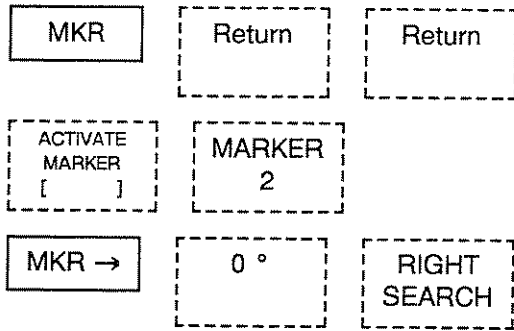

(12) The marker list is displayed to read the values of both marker directly at the same time.

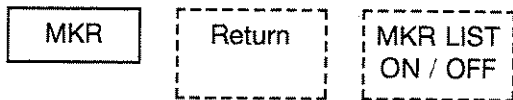

The display is shown in the figure below by the above-mentioned operation.

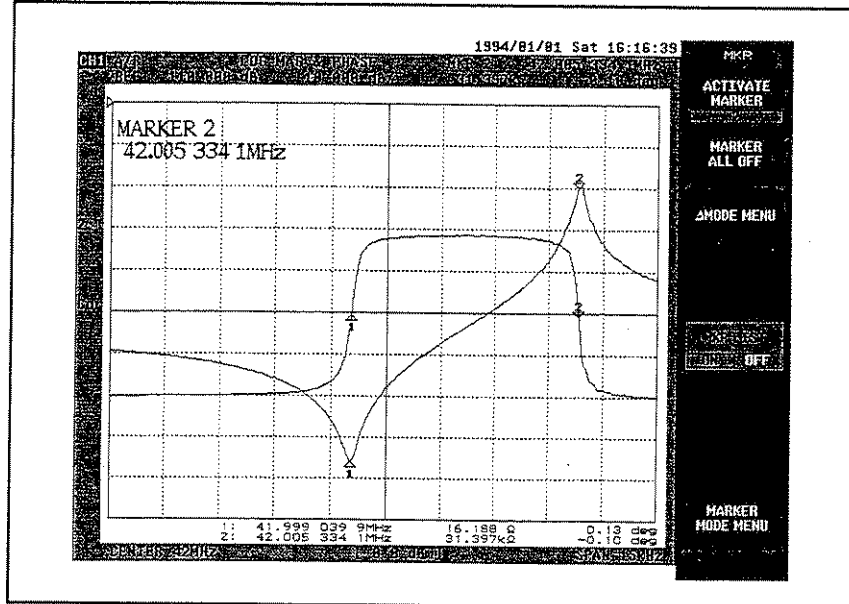

Figure 3-66

(13) Admittance conversion by the transmission measurement is selected.



(14) Correct the scale of the display waveform (Amplitude). The display becomes to see easily.



(15) Specify the marker 1 for the active marker. The search for the phase 0 ° is executed to search the resonance point.

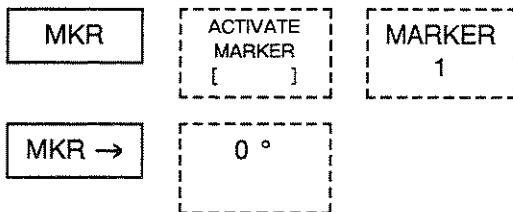

(16) Specify the marker 2 for the active marker. The search for the phase 0 ° is executed to search antiresonance point.

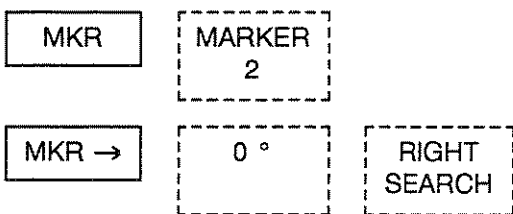



Display screen is shown in the figure below by the above-mentioned operation.

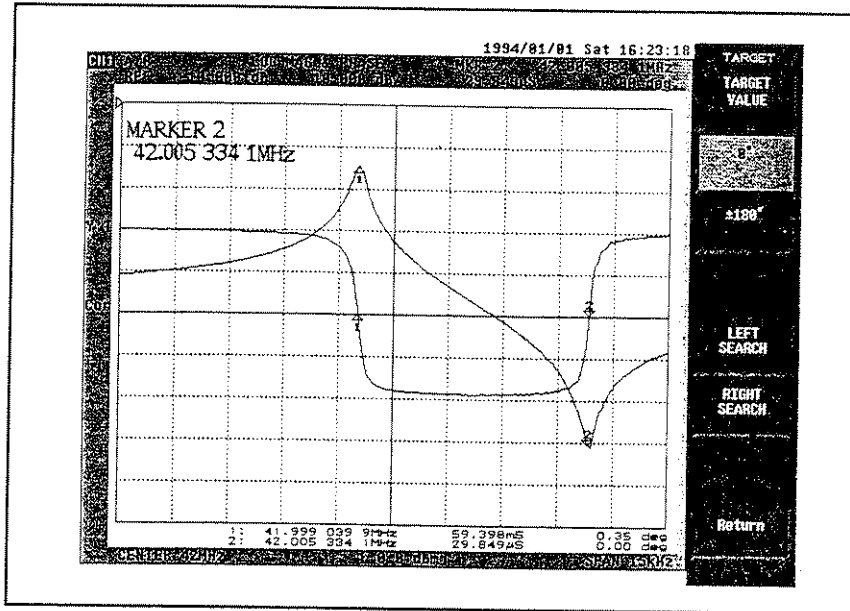

Figure 3-67

### 3.2.18 Output of Measured Data to Plotter

The output method to the plotter of measured data is explained here by the example the band pass filter measurement of 145MHz .

The plotter assumes HP mode and the address to be set 5.

- (1) Setup (Filter connection) and presetting. (Refer to 3.1.2 subsections and figures 3-2)
- (2) The measurement format is made an amplitude (logarithm display).



- (3) Set center frequency and span.

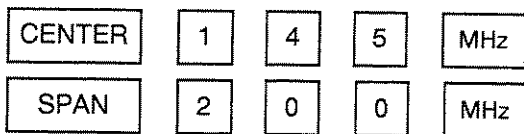

- (4) Correct the scale of the display waveform. The display becomes to see easily.



- (5) The marker is displayed and moved to the measurement point.



- (6) R3753 is set to the system controller to use the plotter.

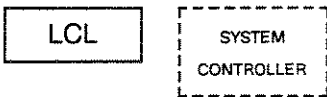

- (7) The GPIB address of the plotter is set.

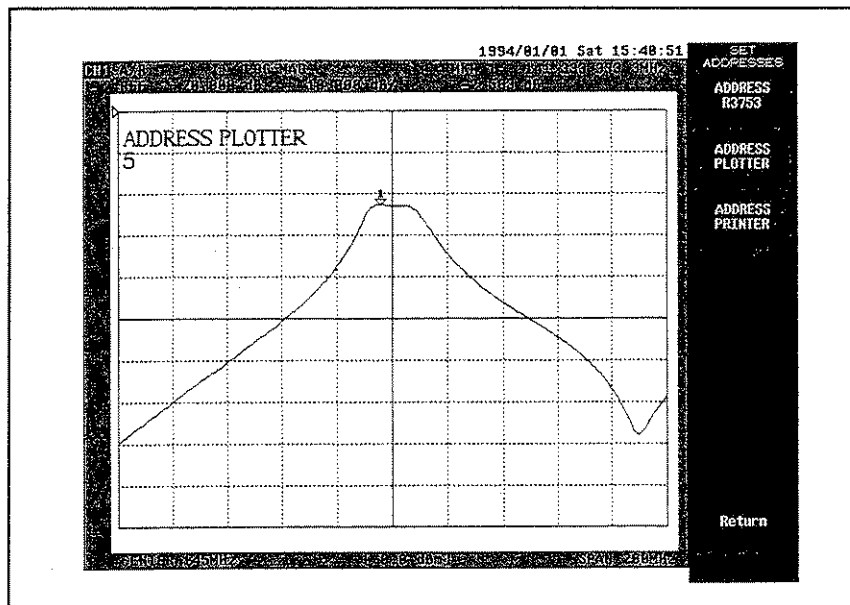
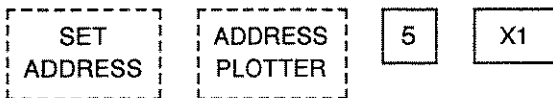
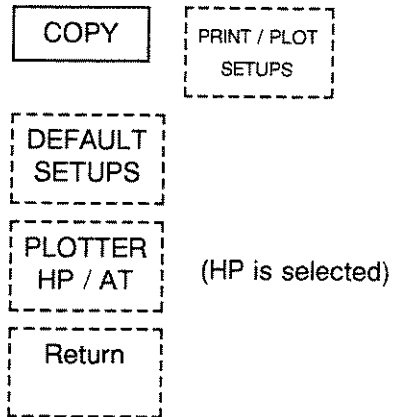

Figure 3-68

- (8) The plotter mode is selected.

According to the mode setting of plotter, plotter mode HP is selected.



- (9) The data output to the plotter is selected. Measured data, the coordinates data, the text data, the marker data, and the reference data are made to set it of the output here. The memory data is made to set it of no output. Initial value is all "ON" (Output it). Only the memory data is made "OFF" (Do not output it).

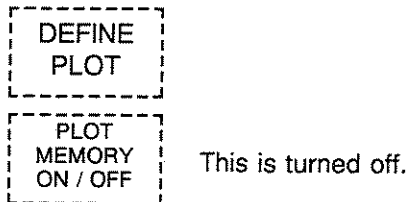



The output copy of the plotter is shown in the figure below.

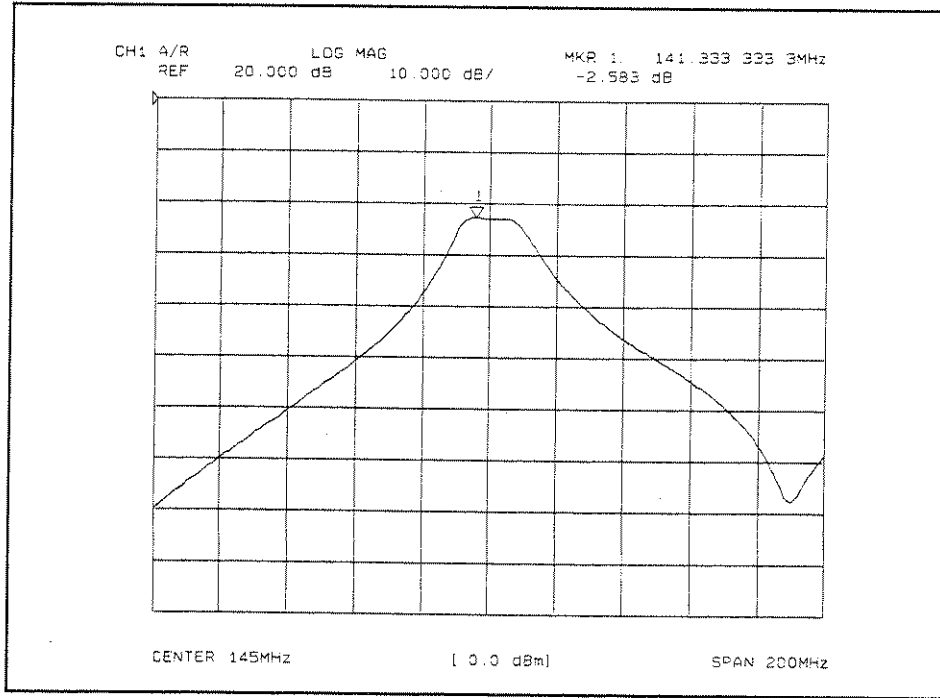

Figure 3-71

(Note) When plotter of HP company is used, the error such as lighting the error lamp will be occasionally displayed even though plotting it normally.

### 3.2.19 Storage/Reproduction of Measured Data (Saving and Recall Register)

The method of operation of the storage and reproducing the set value of measurement is explained here in the saving/the recall register by the example the band pass filter measurement of 145MHz.

- (1) Setup (Filter connection) and presetting (Refer to 3.1.2 subsections and figures 3-2)
- (2) Set center frequency and span.

CENTER	1	4	5	MHz
SPAN	2	0	0	MHz

- (3) Make the measurement format an amplitude (Logarithm display).

FORMAT	LOG MAG
--------	---------

- (4) Select the channel 2. Change the format.

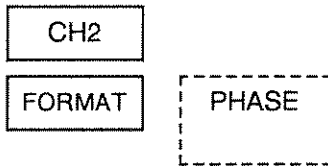

- (5) Dual-screen is simultaneously displayed.

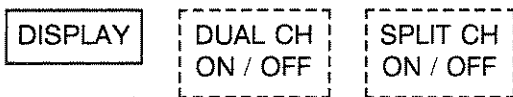

- (6) The marker is displayed.

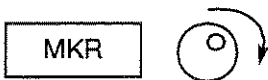

- (7) The above-mentioned setting is preserved with the saving register.



The display is shown in the figure below by the above-mentioned operation.

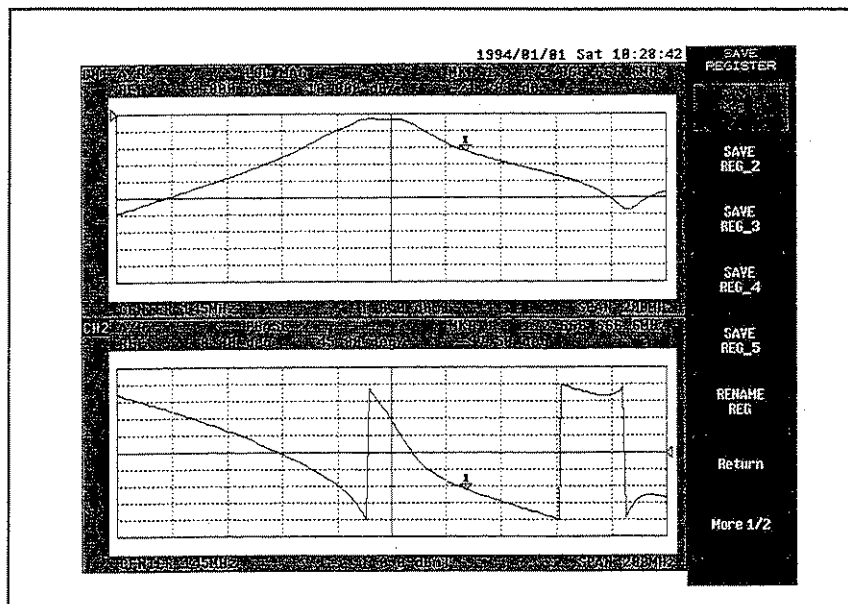

Figure 3-72

Set value storage is completed by the above-mentioned operation.  
Next, the saved set value is reproduced.

- (8) Presetting is executed. And setting is initialized.

PRESET

- (9) The set value is reproduced by the recall register.

RECALL      RECALL  
REG-1

The display is shown in the figure below by the above-mentioned operation.

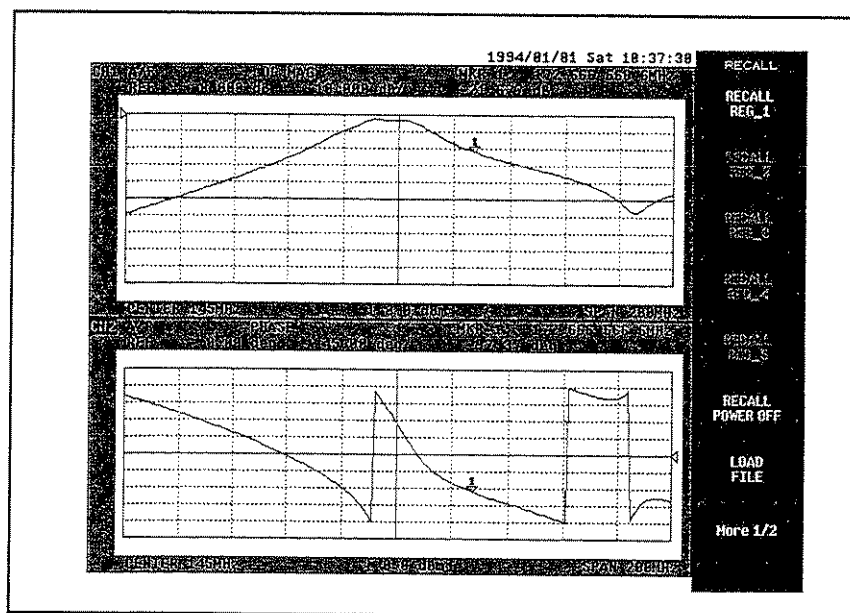

Figure 3-73

As for the case saved with the saving register, setting data is saved to C drive (RAM disk with back up). And the calibration data and the memory waveform data are saved to B drive (RAM disk and the back up none). Therefore, when power OFF is done, the calibration data and the memory waveform data will be deleted. Refer to the store file (3.2.20 subsection Storage and reproduction of measured data (Store and load file)) in the case by which the calibration data and the memory waveform data are preserved.

### 3.2.20 Storage and Reproduction of Measured Data

The operation method of the storage and reproducing the set value of measurement with the store and loading file is explained here by the example of measuring the band pass filter of 145MHz.

In the store/loading file, the data is stored on the floppy disk inserted in A drive.

(Note) Prepare the floppy disk that has been formatted. Available format type is DD 720KB, HD 1.2MB, or HD 1.44MB.

- Formatting procedure of floppy disk
  - ① Insert the floppy disk in the floppy disk drive. The format type in the initial state is DD 720KB or HD 1.2MB(8SECTORS).
  - ② The floppy disk is formatted according to the following procedures.



- (1) Setup (Filter connection). (Refer to 3.1.2 subsections and figures 3-2)
- (2) Set center frequency and span.

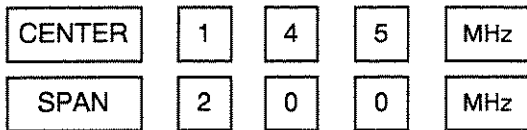

- (3) Do calibration of the frequency characteristic as follows.  
Connect the short adaptor instead of DUT. Under such a condition, R3753 is normalized.

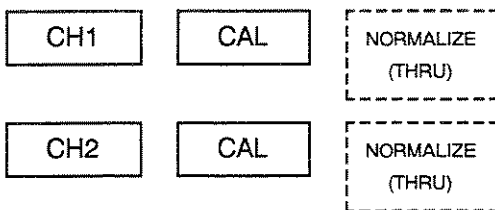

After ending, return the connection to DUT (filter).



- (4) The channel 1 is mode an amplitude (Logarithm) display, and channel 2 a phase display.

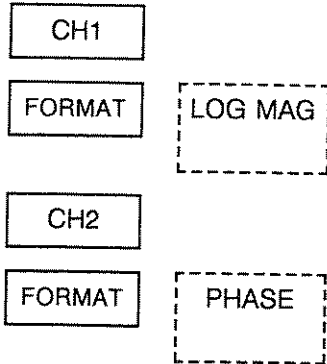

- (5) Dual-screen is displayed at the same time.

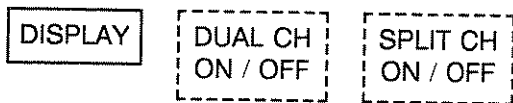

- (6) The marker is displayed.



The display is shown in the figure below by the above-mentioned operation.

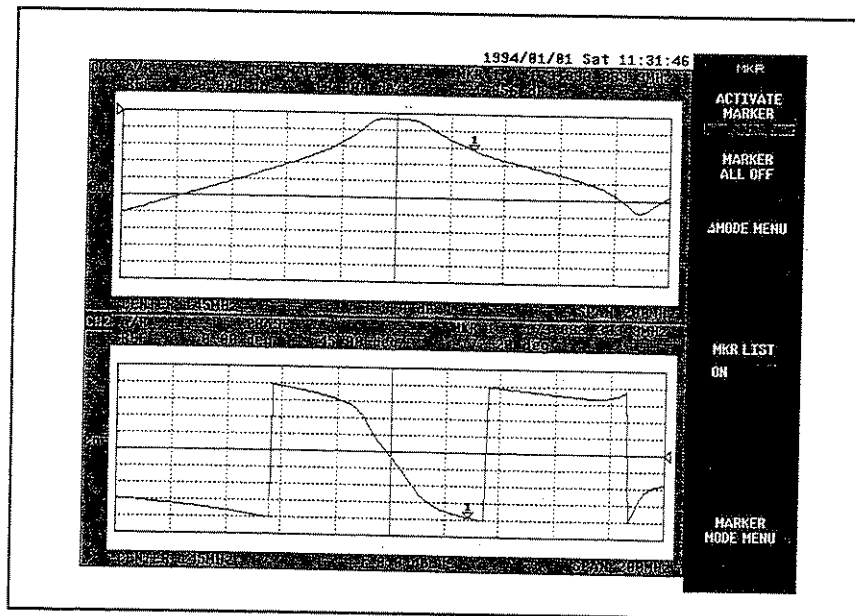

Figure 3-74

- (7) The floppy disk that has been formatted is inserted in A drive. And the store file menu is selected.

(After floppy disk is inserted)



The file list window is displayed here.

- (8) The preserved data is selected. A set condition, the raw data before formatting it, and the calibration data are preserved here.

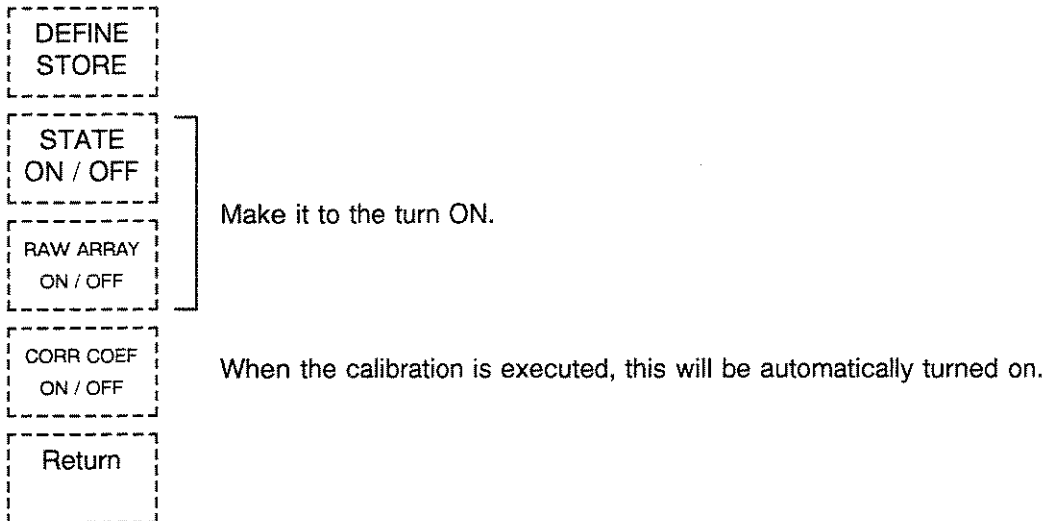

- (9) The name will be set in the file before the data is preserved. This makes retrieval easy. In the case saved by the file name of default, advance it to the following step (10).

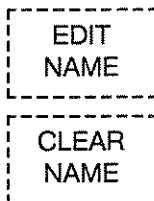

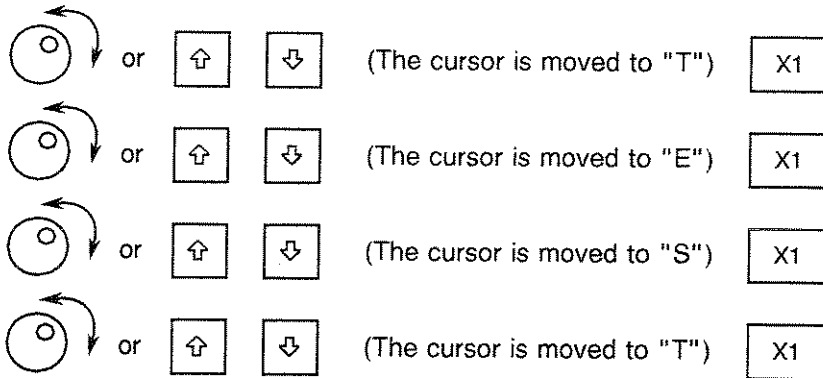

The display is shown in the figure below by the above-mentioned operation.

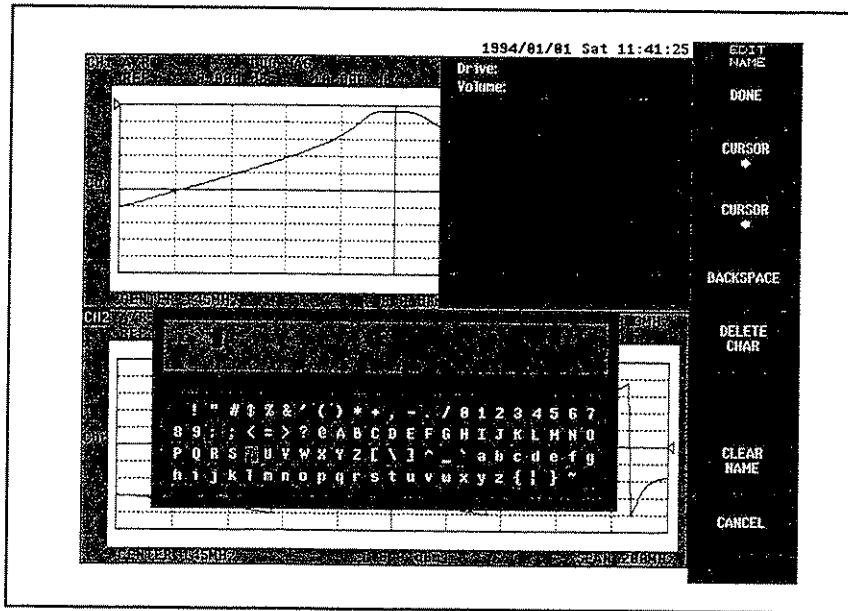

Figure 3-75

DONE

(10) The data is stored.

STORE

The saving of the data is completed by the above-mentioned operation.  
 Next, the saved data is reproduced.

(11) Presetting. The set value is initialized.



PRESET

(12) The storage data is reproduced from the file.

RECALL      LOAD  
FILE

The file list window is displayed here.

(13) The file list window is displayed. The reproducing file is selected from the list.

The cursor is moved to the file that reproduces by  or  .

LOAD

Display screen is shown in the figure below by the above-mentioned operation.

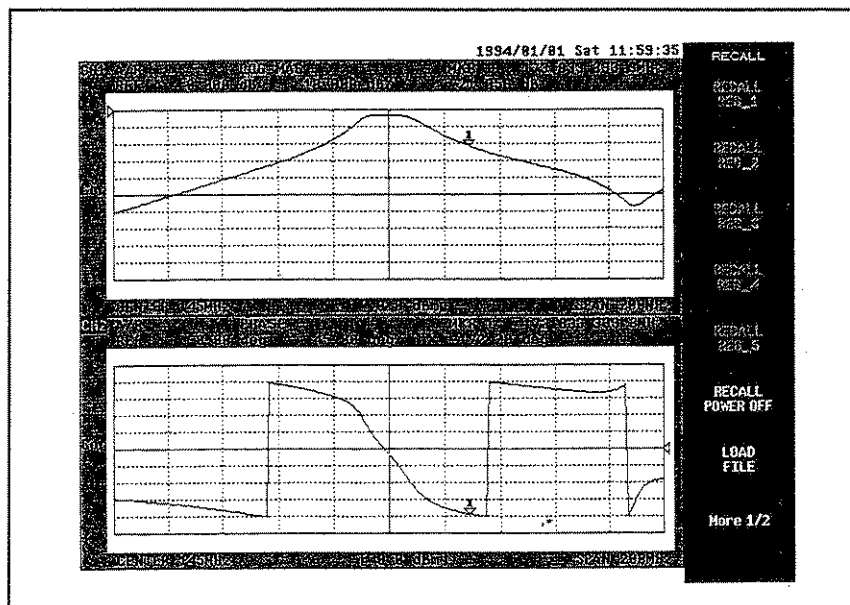

Figure 3-76

After the reproduction ends, the sweep will become a hold status automatically.

\* About stored measured data

There is three ways in the storage of measured data.

1. RAW ARRAY (raw data)
2. DATA ARRAY (format data)
3. MEM ARRAY (memory data)

Among these, 1.RAW ARRAY and 2.DATA ARRAY preserves the display data. The difference of these two data is the following. 1. RAW ARRAY preserves the data before the error correction and the trace operation, etc. are processed. On the other hand, 2. DATA ARRAY preserves the data under the display.

For instance, when the data preserved by RAW ARRAY is reproduced, even if the measurement format is changed, a correct value at the storage can be displayed.

2. In DATA ARRAY, when the display format at the storage is displayed with LOG MAG, a correct value is indicated only by the LOG MAG format.

Refer to the data flow of 1.1.3 subsections for three data flows.

IVI E IVI U 

## 4. OPERATION METHOD

### (1) Functional blocks on front panel

The front panel keys are grouped into six functional blocks as shown below. With a combination of these blocks, the analyzer is operated.

- **ACTIVE CHANNEL block:** The analyzer has two measurement channels. The block is used to select an active channel which can be set or changed. (See section 4.1.)
- **ENTRY block:** Enters a numeric value for the selected function. (See section 4.2.)
- **STIMULUS block:** Selects the settings for the signal source. (See section 4.3.)
- **RESPONSE block:** Selects the settings of the receiver and the setting of the conditions of the display. (See section 4.4.)
- **INSTRUMENT STATE block:** Selects the system settings such as save/recall and hard copy. (See section 4.8.)
- **GPIB block:** Selects the settings of the controller and the GPIB. (See section 4.9.)

### (2) Key operation

Two types of key operations are available for the analyzer as follows:

- When a numeric value is required to be entered:

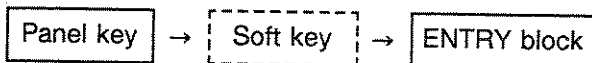

- When only soft key menus are required for selection:

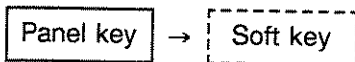

If some key is pressed for more than about 0.5 second, the pressed key is entered repetitively.

However, pressing more than two keys or more at the same time brings nothing.

(3) Structures of soft key menus

The soft key menu has multiple-page structure and hierarchical structure.

- Multiple-page structure type:

Pressing the  moves to next page and pressing the  moves to previous page.

- Hierarchical structure type:

Pressing the  to the previous layer menu.

There are functions that can not be used in a part of R3753 series.

Menus related to those operations are not displayed.

Furthermore, the analyzer checks the connecting condition of the S-parameter set. If the S-parameter set is not connected, the menus related to S-parameter are not displayed.

#### 4.1 ACTIVE CHANNEL Block

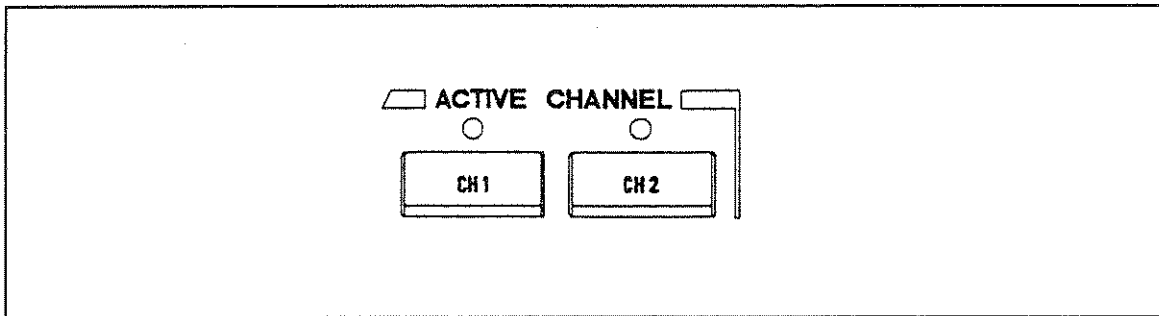

The analyzer can perform the simultaneous measurement for reflection and transfer characteristics of sample devices or the simultaneous measurement under different frequency conditions.

The analyzer has two measurement channels which can be independently used for measurement and data display. ACTIVE CHANNEL block is used to select which channel will be used for the active channel. The active channel is the channel for which various conditions can be set such as measurement and data display, that is, all the channel dependent functions will apply to the active channel. The channel with its LED lit up is the current active channel.

: Sets channel 1 to active channel.

: Sets channel 2 to active channel.

The setting of the signal source can be interlocked between channels.

In the case, The conditions which has been set to the active channel will be also set to the other channel. (See section 4.3.2.)



## 4.2 ENTRY Block

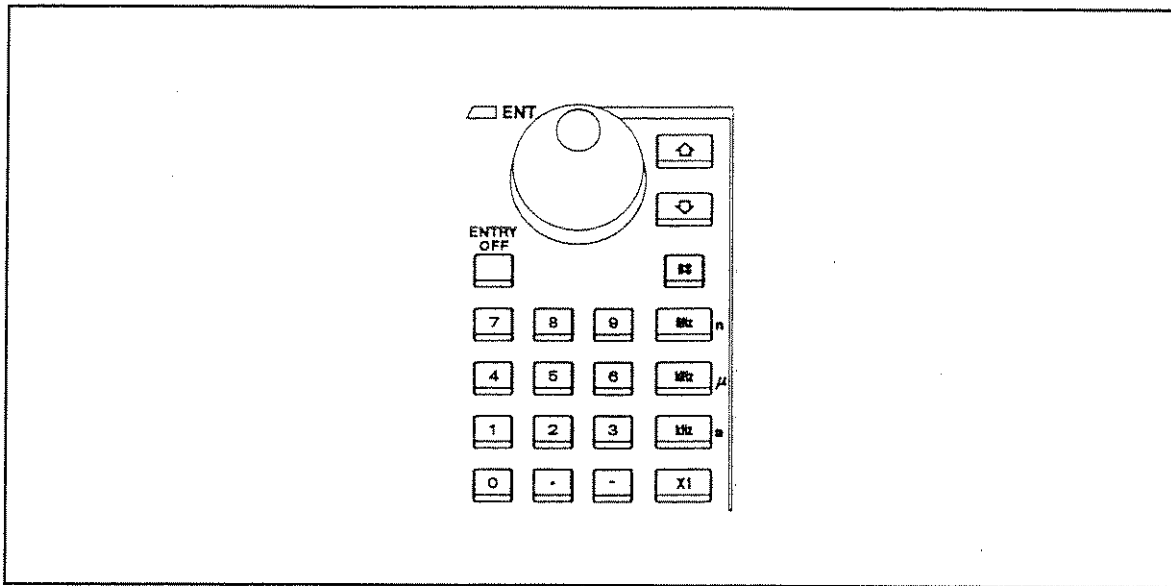

The ENTRY block is used to set data input/change for the selected function by using the

Panel key

and Soft key

This block is also used to set/change a marker.

Numeric keys:  to  ; Numeric keys.

; Decimal point key

; Minus sign key

; Back space key

ENTRY OFF  
 ; Entry off key  
 Clears all numeric data and also cancels an input request.

Note: After numeric key operation, press unit keys.





Input numeric values by using numeric keys, a decimal point key, and a minus sign key. Then, press a unit key after inputting the numeric value.

Pressing the unit key determines the unit of the input numeric values and terminates numeric entry. Namely the numeric entry is not complete until is specified by pressing a unit key.

While an arrow (→) is being displayed on the left side of the active entry area, the numeric entry does not complete.





The suffix for basic units of "Hz, deg, and  $\Omega$ " is commonly supported by the following unit keys.

Unit keys: 

	n;	Giga	( $10^9$ )
	$\mu$ ;	Mega	( $10^6$ )
	m;	Kilo	( $10^3$ )
	;		( $10^0$ )

The suffix for basic units of "sec and m" or for real values without unit is commonly supported by the following unit keys.

Unit keys: 



	n;	Nano	( $10^{-9}$ )
	$\mu$ ;	Micro	( $10^{-6}$ )
	m;	Milli	( $10^{-3}$ )
	;		( $10^0$ )

If a basic unit other than the above is used, its suffix is not supported.

The ENTRY OFF key is a toggle switch. When data entry is displayed, if the ENTRY OFF key is pressed, the current data entry is canceled.

If the ENTRY OFF key is pressed again, the data entry is displayed.

Once the PRESET key is pressed or the data entry is canceled by the analyzer itself, the ENTRY OFF key can not make the data entry displayed again.

Step keys:  to  ; Increases or decreases the setting value with the specific step size.  
After the step key operation, no unit setting is required.

Data knob:  ; Continuously makes the setting value variable.  
After the data knob operation, no unit setting is required.

### 4.3 STIMULUS Block

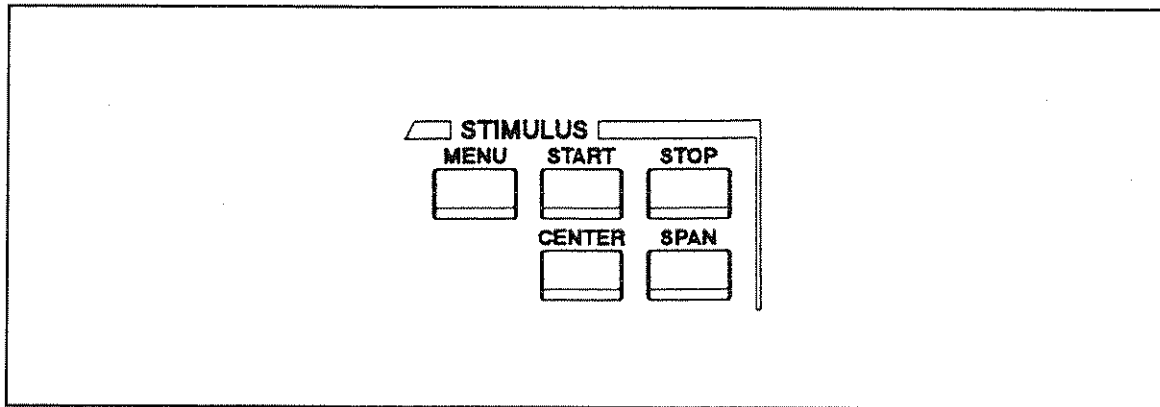

This block is used to set the conditions concerning the signal sources such as a frequency range, power level setting, sweep type, sweep time, and sweep resolution. When an S parameter test-set is connected, the attenuator setting of the S parameter test-set can be also performed.

**MENU** : Calls the signal source menu to be set such as an output level, sweep time, sweep type, and sweep resolution. (See section 4.3.1.)

**START** : Specifies the sweep start.  
Sets each start frequency or start power when the sweep type is a frequency type or power type.

**STOP** : Specifies sweep stop.  
Sets each stop frequency or power when the sweep type is a frequency type or power type.

**CENTER** : Specifies the center sweep.  
Set center frequency when the sweep type is a frequency type.

**SPAN** : Specifies the sweep span.  
Set frequency span when the sweep type is a frequency type.

Set the sweep range by pressing the **START**, **STOP**, **CENTER** or **SPAN**.

For the other settings, press the **MENU** to call the signal source menu, then perform the setting.

### 4.3.1 Setting Signal Source

#### Operation procedure

① Press the **MENU** to call the signal source menu.

② Signal source menu

- |                             |   |  |
|-----------------------------|---|--|
| <b>POWER</b>                | : | Calls the power menu used for selecting an output power and an output port. (See step ③.)  |
| <b>SWEEP TIME</b>           | : | Sets the sweep time.<br>When a zero is set, AUTO is selected.<br>When AUTO is set, the minimum sweep time is set according to the sweep frequency range and receiver section resolution bandwidth. |
| <b>SWEEP TYPE</b><br>[ ]    | : | Calls the sweep type menu for selecting a sweep type.  |
| <b>TRIGGER</b><br>[ ]       | : | Calls the trigger menu for selecting a sweep trigger condition.  |
| <b>POINTS</b>               | : | Sets the number of sweep point. The number of settable points are: 3, 6, 11, 21, 51, 101, 201, 301, 401, 601, 601, 801, or 1201 points.  |
| <b>COUPLED CH</b><br>ON/OFF | : | Selects whether the setting conditions concerning the channels 1 and 2 are same or not. (See section 4.3.2.)   |
| <b>CW FREQ</b>              | : | Sets the frequency at power sweep.   |
| <b>RESTART</b>              | : | Restarts the measurement from sweep start.<br>When this key is pressed, the sweep restarts from the start, even if the sweep is uncompleted.   |

③ Power menu

OUTPUT 1	:	Sets the output port to OUTPUT1 (single output). (See Note 1)
OUTPUT 2	:	Sets the output port to OUTPUT2 (single output). (See Note 1)
POWER	:	Sets the output level during frequency sweep.
ATTENUATOR PORT1	:	Sets the PORT 1 attenuator of S parameter test-set. (See Note 2)
ATTENUATOR PORT2	:	Sets the PORT 2 attenuator of S parameter test-set. (See Note 2)

Note 1: This is not displayed in R3753E.

Note 2: This can be set only the case with which S parameter test set is connected with R3753A.

④ Trigger menu

CONTINUOUS	:	Continuously performs sweep.
SINGLE	:	Performs sweep once. If this key is pressed in the middle of a sweep, the measurement of the sweep is interrupted and a sweep is restarted.
HOLD	:	Stops sweep measurement. If this key is pressed in the middle of sweep, immediately sweep is interrupted.
INT TRIG	:	Automatically starts sweep by an internal source.
EXT TRIG	:	Starts sweep by an external synchronization signal. The external synchronization signal is input through the parallel I/O connector 18-pin of the rear panel. Negative logic, pulse width: 1 $\mu$ s or more
TRIGGER DELAY	:	Sets delay time between receiving the trigger signal and the start of sweep.

### 4.3.2 Interlocking between Channels

Selects whether the measurement condition concerning the signal source is set at the same condition or independently set in each channel when two-channel simultaneous measurement.

For interlock setting: The conditions which has been set to the active channel will be automatically set to the other channel as same.

For independent setting: Different measuring condition can be set to channel 1 and 2, respectively.

The setting conditions which can be interlocked between channels are shown below:

- Sweep type
- Frequency
- Output level
- Sweep time
- Number of measurement point
- Resolution bandwidth

#### Operation procedure

① Press the  to call the signal source menu.

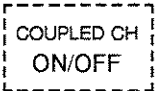
② Press the  to select whether the setting condition concerning the measurement between the channel 1 and channel 2 is set at the same condition or not.

ON: Measures the channel 1 and channel 2 simultaneous at the same condition.

OFF: Measures the channel 1 and channel 2 alternately.(Performs the measurement of channel 1, then channel 2.)

#### 4.4 RESPONSE Block

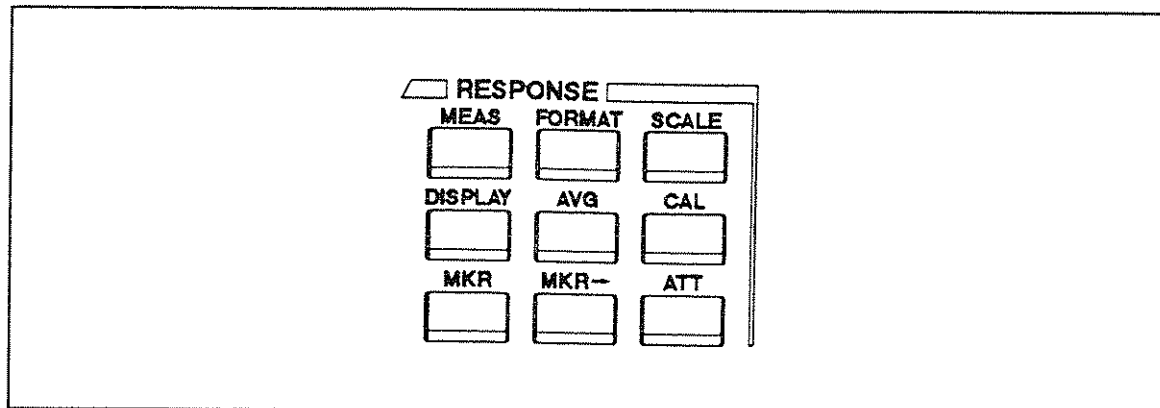

The RESPONSE block is used to set the measurement conditions of receiver section, measurement parameters, measurement format, display format, and marker for an active marker.

- MEAS** : Calls the measurement menu for selecting an input port and measurement parameters. (See section 4.4.1.)
- FORMAT** : Calls the format menu for selecting the format of measurement data. (See section 4.4.2.)
- SCALE** : Calls the scale menu for setting the display coordinate axis. (See section 4.4.3.)
- DISPLAY** : Calls the display menu for executing 2-channel simultaneous display, trace operation function, and label input. (See section 4.4.4.)
- AVG** : Calls the average menu for executing data average, smoothing, resolution bandwidth setting. (See section 4.4.7.)
- CAL** : Calls the calibration menu for setting calibration function. (See section 4.5.)
- MKR** : Calls the marker menu for setting a marker. (See section 4.6.)
- MKR →** : Calls the marker search menu for setting analysis by using a marker. (See section 4.6.)
- ATT** : Calls the attenuator menu for selecting a receiver section input attenuator and impedance. (See section 4.4.8.)

#### 4.4.1 Setting Input and Parameter Conversion

Selects the receiver section input port.

The data which is measured in the selected input port is a "complex data". This data is also formatted such as the amplitude, phase, group delay. Data before formatting can be changed to impedance, admittance, reverse S parameter. Also, when the S parameter test-set is connected, perform the selection of S parameter.

Operation procedure

① Press the **MEAS** to call the measurement menu.

② Measurement menu

**A/R** : Sets the input port to A/R. (Note 2)

**B/R** : Sets the input port to B/R. (Note 1)

**A/B** : Sets the input port to A/B. (Note 1)

**R** : Sets the input port to R. (Note 2)

**A** : Sets the input port to A.

**B** : Sets the input port to B. (Note 1)

**CONVERSION**  
[ ] : Calls the parameter menu for converting the measured data to an impedance, admittances, or reverse S parameters. (See step ③.)

**S**  
**PARAMETERS** : Calls the S parameter menu for selecting an S parameter. (See step ④.)

(Note 1) This is not displayed in R3753B/E

(Note 2) This is not displayed in R3753B.



③ Parameter conversion menu

Z(REFL) : Executes the impedance conversion by the reflection measurement.  
 Conversion expression =  $\frac{1 + \rho}{1 - \rho} \times Z_0$  (Note)

Z(TRANS) : Executes the impedance conversion by the transmission measurement.  
 Conversion expression =  $\frac{2(1-T)}{T} \times Z_0$  (Note)

Y(REFL) : Executes the admittance conversion by the reflection measurement.  
 Conversion expression =  $\frac{1 - \rho}{1 + \rho} \times \frac{1}{Z_0}$  (Note)

Y(TRANS) : Executes the admittance conversion by the transmission measurement.  
 Conversion expression =  $\frac{T}{2(1-T)} \times \frac{1}{Z_0}$  (Note)

1/S : Converts the S parameter to the reverse S parameter.  
 Conversion expression =  $\frac{1}{S}$  (Note)

OFF : Turns off the conversion function.

ZO VALUE : Sets the characteristics impedance.

(Note)  $\rho$ : Reflection coefficient  
 T: Gain  
 S: Reflection coefficient or gain  
 $Z_0$ : Characteristics impedance

④ S parameter menu

- |                        |   |   |
|------------------------|---|---|
| S11<br>REFL FWD        | : | Sets to the S11 measurement (input reflection coefficient).<br>(Note)           |
| S21 (B/R)<br>TRANS FWD | : | Sets to the S21 measurement (forward direction transfer coefficient).<br>(Note) |
| S12 (A/R)<br>TRANS REV | : | Sets to the S12 measurement (reverse direction transfer coefficient).<br>(Note) |
| S22 (B/R)<br>REFL REV  | : | Sets to the S22 measurement (output reflection coefficient).<br>(Note)          |
| CONVERSION<br>[     ]  | : | Calls the parameter conversion menu. (See step ③.)                              |
| INPUT<br>PORTS         | : | Calls the measurement menu. (See step ②.)                                       |

(Note) This can be set by only when S parameter test set is connected with R3753A being displayed.

## 4.4.2 Display Data Format

Formats the measurement data. Data is displayed as the type formatted.

Operation procedure

① Press the **FORMAT** to call the format menu.

② Format menu

● Format menu (1 of 2)

**LOG MAG** : Sets to the logarithm amplitude display.

**PHASE** : Sets to the phase display.  
The display is changed to the loop back display in  $\pm 180^\circ$ .

**DELAY** : Sets to the group delay display.

**SMITH  
(R+jX)** : Sets to the Smith chart.

**SMITH  
(G+jB)** : Sets to the admittance chart.

**POLAR** : Sets to the polar coordinates display.

**LIN MAG** : Sets to the liner amplitude.

• Format menu (2 of 2)

- SWR** : Sets to the SWR (standing wave ratio) display.
- REAL** : Sets to the measurement data real display.
- IMAG** : Sets to the measurement data imaginary display.
- PHASE**  
-∞, +∞ : Sets to the continuous phase display.  
The phase is changed to the no loopback display in  $\pm 180^\circ$  based on the one point data.
- LOG MAG &  
PHASE** : Sets to the simultaneous display with logarithm amplitude and phase.
- LOG MAG &  
DELAY** : Sets to the simultaneous display with logarithm amplitude and group delay.
- LIN MAG &  
PHASE** : Sets to the simultaneous display with linear amplitude and phase.

### 4.4.3 Setting Display Coordinate Scale

The coordinate in accordance with selected format is displayed on the screen.  
The coordinate scale is changed on the scale menu.

Operation procedure

① Press the **SCALE** to call the scale menu.

② Scale menu

- |                                |   |  |
|--------------------------------|---|--|
| <b>AUTO SCALE</b>              | : | Automatically sets the display coordinate to be an optimize value for display trace. |
| <b>/DIV</b>                    | : | For the cartesian format, sets the value of the vertical axis 1 scale.               |
| <b>REF VALUE</b>               | : | Sets the reference position value of the display coordinate.                         |
| <b>REF POS</b>                 | : | Specifies the reference position of the display coordinate.                          |
| <b>REF LINE<br/>ON/OFF</b>     | : | Selects ON/OFF of the reference position display.                                    |
| <b>FULL SCALE</b>              | : | Sets a full scale value for a smith chart and polar coordinate display.              |
| <b>SCALE FOR<br/>2nd / 1st</b> | : | Selects a preferred trace in displaying two traces simultaneously.                   |

#### 4.4.4 Split-Screen Display and Selection of Display information

The 2-channel simultaneous display can be performed.

The selection of trace data, the coordinate display ON/OFF, the label input can be performed.

Operation procedure

① Press the **DISPLAY** to call the display menu.

② Display menu

● Display menu (1 of 2)

DUAL CH  
ON/OFF

: Selects ON/OFF of the 2-channel simultaneous display.

SPLIT CH  
ON/OFF

: Selects ON/OFF of the split-screen (upper/lower) display.

When the split-screen is selected, upper screen for channel 1 and lower screen for channel 2 are set.

DISPLAY  
DATA

: Displays the measurement data only.

DISPLAY  
MEMORY

: Displays the memory data only.

DISPLAY  
DATA & MEM

: Displays both the measurement data and memory data.

DEFINE  
TRACE  
[ ]

: Calls the trace operation menu.

Perform the fundamental arithmetic operation between measurement data and memory data in the trace operation. (See subsection 4.4.5)

DATA ⇨  
MEMORY

: Sets the measurement data to the memory.

- Display menu (2 of 2)

 : Selects ON/OFF of the coordinate display.

 : Calls the label menu for entering the label. (See section 4.4.6.)

### 4.4.5 TRACE Operation

The trace operation is used to execute fundamental arithmetic operation between the measurement data and memory data.

Operation procedure

① Press the **DISPLAY** to call the display menu.

② Press the **DEFINE TRACE** to call the trace operation.

③ Trace operation menu

- |                 |   |   |
|-----------------|---|---|
| <b>DATA/MEM</b> | : | Executes the division of measurement data and memory data, then displays the result as the measurement data.          |
| <b>DATA-MEM</b> | : | Executes the subtraction of measurement data and memory data, then displays the result as the measurement data.       |
| <b>DATA*MEM</b> | : | Executes the of multiplication of measurement data and memory data, then displays the result as the measurement data. |
| <b>DATA+MEM</b> | : | Executes the addition of measurement data and memory data, then displays the result as the measurement data.          |
| <b>OFF</b>      | : | Cancels the operation (calculation).  |



#### 4.4.6 Label input

An annotation of measurement data and so on is input as a label.  
Maximum 64 characters can be input.

##### Operation procedure

- ① Press the **DISPLAY** to call the display menu.
- ② Press the **More 1/2** .
- ③ Press the **LABEL** to call the label window and label menu.
- ④ Label menu (Select the character of label menu by using the data knob, and press the

**X1** .)

**DONE**

: Completes the label input.

**CURSOR**  
➡

: Shifts the cursor indicating the label input position to the right.

**CURSOR**  
⬅

: Shifts the cursor indicating the label input position to the left.

**BACK SPACE**

: Backspaces.

**DELETE  
CHAR**

: Deletes one character.

**CLEAR  
LINE**

: Deletes all characters.

**CANCEL**

: Cancels the edit.

R3753 SERIES  
NETWORK ANALYZER  
OPERATION MANUAL

4.4 RESPONSE Block

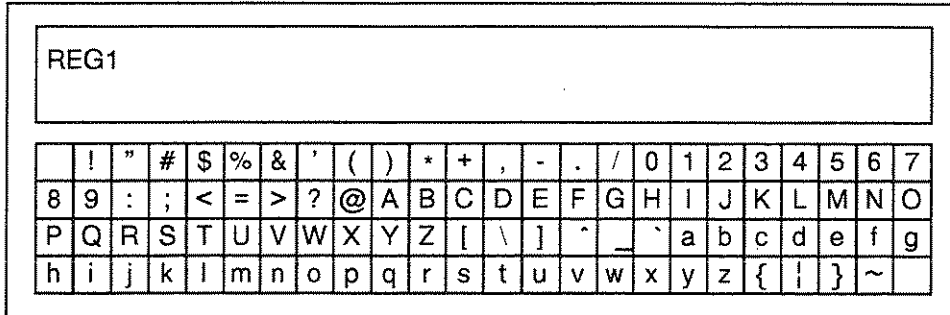

Figure 4-1 Label Window Display

#### 4.4.7 Averaging/Smoothing and Resolution Bandwidth

Averaging (time average) and smoothing (moving average) are provided as the function which statistically reduces random errors that cannot be reproduced. Narrow resolution bandwidth will reduce noise component, thus decreasing random errors. However, the case will increase the sweeping time.

Operation procedure

① Press the AVG to call the average menu.

② Average menu

- AVG STATE  
ON/OFF
 : Selects ON/OFF of averaging. (Note 1)
- AVG COUNT
 : Sets the number of times for averaging. (Note 1)
- AVG  
RESTART
 : Resets the averaging and restarts at the average time 1. (Note 1)
- GROUP DELAY  
APERTURE
 : Sets the aperture for group delay measurement. The aperture should be considered in the same manner as the smoothing aperture. (Note 1)
- SMOOTHING  
ON/OFF
 : Selects ON/OFF of smoothing. (Note 1)
- SMOOTHING  
APERTURE
 : Sets the smoothing aperture. (Note 1)
- IF RBW  
[    ]
 : Sets the resolution bandwidth. If "0" is set, it is set to "AUTO" which automatically sets the bandwidth according to the measurement frequency.

Resolution bandwidth	Maximum sweeping per point
10kHz	0.1ms/POINTS
3kHz	0.35ms/POINTS
1kHz	1.0ms/POINTS
300Hz	3.5ms/POINTS
100Hz	10ms/POINTS
30Hz	35ms/POINTS
10Hz	100ms/POINTS
3Hz	350ms/POINTS

When IF RBW AUTO function is selected, the resolution bandwidth is not defined uniquely by the range of sweeping frequency. This automatically switches the resolution bandwidth according to the frequency under sweeping.

When AUTO is set, bandwidth of the resolution as the figure below is selected and is measured automatically corresponding to the frequency of the measurement point .

Measurement frequency	Bandwidth of resolution
5Hz to 300Hz	3Hz
300Hz to 1kHz	10Hz
1kHz to 3kHz	30Hz
3kHz to 10kHz	100Hz
10kHz to 30kHz	300Hz
30kHz to 100kHz	1kHz
100kHz to 300kHz	3kHz
300kHz to 500MHz	10kHz

Note 1: In the averaging function, the measured data are averaged with time weight before formatting it. Since vector quantity is averaged, there also is an effect that reduces the noise level.

The smoothing obtains the moving average between adjacent pieces of formatted data. Since scaler quantity is averaged, the noise width is reduced but the noise level will not be reduced.

- Averaging process

$$\bar{Y}(n) = \frac{n-1}{n} \times \bar{Y}(n-1) + \frac{1}{n} \times Y(n) \quad (n \leq N)$$

$$\bar{Y}(n) = \frac{N-1}{N} \times \bar{Y}(n-1) + \frac{1}{N} \times Y(n) \quad (n > N)$$

$\bar{Y}(n)$ : nth averaged data

$Y(n)$ : nth data not averaged yet

N: Number of times for averaging

- Smoothing process

$$\bar{D}(n) = \frac{D(n-m) + \dots + D(n) + \dots + D(n+m)}{2m+1}$$

$\bar{D}(n)$ : nth format data already smoothed

$D(n)$ : nth format data not smoothed yet

$2m$ : Smoothing aperture

The aperture for the setting value is obtained using the following equation:

$$\text{Aperture} \langle 2m \rangle = \frac{(\text{measurement points})-1}{100} \times \langle \text{value} \rangle$$

That equation means that the aperture is set by the percentage for the number of the measurement points. Even if the number of the measurement points has been changed, the setting value of the aperture will be maintained and the aperture  $\langle 2m \rangle$  will be calculated again by the number of the measurement points after the change.

(Example)

Number of measurement points: 101(Point)

$$\text{Aperture: } 2(\%) \rightarrow \text{Aperture}(2m) = \frac{101-1}{100} \times 2 = 2$$

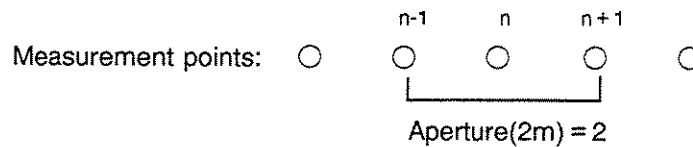

#### 4.4.8 Selecting Input Attenuator and Input Impedance

The input attenuator and impedance are selected. Two types of input attenuators are provided: 0dB and 20dB. These attenuator values determine a maximum value and a noise level of the input power. To set the measurement dynamic range to the maximum value, it is required to set the attenuator value to an optimum value according to the input power.

Since the value is automatically set to the optimum value according to the input power when the attenuator is set to AUTO, the maximum dynamic range will be obtained. Typical values are as follows:

Note: If the input power exceeds a maximum permissible input level, "over load trip" is displayed and the input impedance is forcefully switched to 1 M $\Omega$

Attenuator	Maximum input power	Noise level Dynamic range	Dynamic range
0dB	-20dBm	-115dBm	95dB
20dB	0dBm	-95dBm	95dB
AUTO	0dBm	-115dBm	115dB

Operation procedure

- ① Press the  to call the attenuator menu.

② Attenuator menu

- R ch : ATT  
[ ] : Calls the menu which selects the R input attenuator. (See step ③.)  
(Note 2)
- R ch : IMP  
1M $\Omega$ /50 $\Omega$  : Sets the R input impedance to 50 $\Omega$  or 1M $\Omega$ .  
(Note 2)
- A ch : ATT  
[ ] : Calls the menu which selects the A input attenuator. (See step ③.)
- A ch : IMP  
1M $\Omega$ /50 $\Omega$  : Sets the A input impedance to 50 $\Omega$  or 1M $\Omega$ .
- B ch : ATT  
[ ] : Calls the menu which selects B input attenuator. (See step ③.)  
(Note 1)
- B ch : IMP  
1M $\Omega$ /50 $\Omega$  : Sets the B input impedance to 50 $\Omega$  or 1M $\Omega$   
(Note 1)
- CLEAR  
TRIP : Cancels the case where an over input has forcibly set the impedance  
to 1M $\Omega$ .

(Note) This is not displayed in R3753B/E.

(Note) This is not displayed in R3753E.

③ Attenuator selection menu

- INPUT ATT  
AUTO : Automatically sets an optimum value according to an input power.
- INPUT ATT  
0 dB : Sets to 0dB.
- INPUT ATT  
20 dB : Sets to 20dB.

## 4.5 Calibration

There are five types of calibration methods to reduce the system errors, as follows:

- Normalizing ..... ① (See section 4.5.1.)
- 1-port full calibration ..... ② (See section 4.5.2.)
- 2-port full calibration ..... ③ (See section 4.5.3.)
- Averaging ..... ④ (See section 4.4.7.)
- Smoothing ..... ⑤ (See section 4.4.7.)

The methods of ①, ② and ③ are used to remove error factors which can be reproduced. These methods measure the standard whose real value has been known. The result is used to obtain the real value of the measurement according to the error model.

The methods of ④ and ⑤ are used to statistically reduce random errors by obtaining the time average and moving average respectively.

Note: The calibration methods of ①, ②, and ③ can not be performed simultaneously. Since the methods of ④ and ⑤ can be independently operated, they can be performed simultaneously.

### 4.5.1 Normalizing

Calibrates the frequency characteristics of the amplitude and phase. This method can be easily performed but cannot obtain a high accuracy.

(1) For measuring transfer

Calibrates the frequency characteristics including that on the connection cable and connector by connecting the through standard with the condition where any sample is removed.

(2) For measuring reflection

An open standard or a short standard can be selected for the calibration standard. The frequency characteristics is calibrated in the reflection measurement by connecting the calibration standard.

Both the open standard and short standard are full reflection and the phase for the short standard is shifted by 180°.

For the open standard, make sure that the reflection measurement port is actually made open. For example, the calibration can be made when the measurement port is open (unloading condition) without the open standard for a calibrated N type connector.

However, if the open capacity is uncertain or if the open condition cannot be obtained because the measurement port is the line on the base board, the short standard should be used or the calibration should be made with the line made short.



### 4.5.2 One Port Full Calibration

Calibrates the directivity, source match, and frequency tracking in the reflection measurement. This method highly accurately measures the reflection of a one port device or a two port device whose one end is terminated.

Note: Three kinds of calibration standards are required as follows:

- Open standard
- Short standard
- Load standard

The signal flow graph below shows the error model.

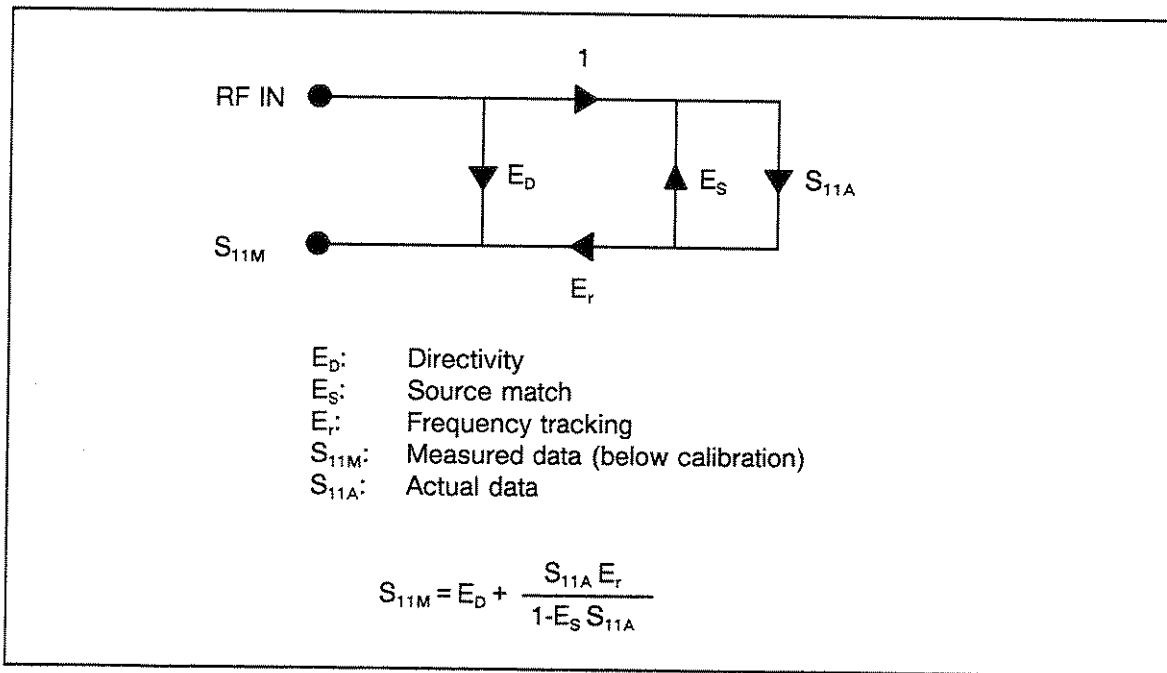

**Directivity:** The directivity connector/bridge which is used for the reflection measurement detects the reflection signal from the sample device. However, it actually detects not only the reflection signal but also a few incidence signals. The limitation where the reflection signal and the incidence signal can be separated is called a "directivity".

**Source match:** The reflection signal from the sample device reflects at the signal source and is injected in the sample to make errors. The reflection coefficient at that signal source is called a "source match".

**Frequency tracking:** Is the frequency characteristics of the measurement system including the cable and connector.

**R3753 SERIES  
NETWORK ANALYZER  
OPERATION MANUAL**

**4.5 Calibration**

---

(This page has been intentionally left blank.)

### 4.5.3 Calibration Method

#### (1) Normalizing (transfer)

Operation procedure

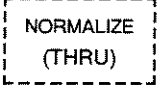
- ① Set up the analyzer to the transfer measurement.
- ② Connect a through standard between the measurement ports.
- ③ Press the  to call the calibration menu.
- ④ Press the .

The message "Wait for Sweep" is displayed and the calibration data are obtained. The calibration is completed when the message disappears.

- ⑤ Connects a sample to perform the measurement.

#### (2) Normalizing (reflection)

Operation procedure

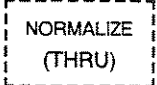
- ① Set up the analyzer to the reflection measurement.
- ② Connect a open standard or a short standard to the measurement port.
- ③ Press the  to call the calibration menu.
- ④ When the open standard is used, then press the .

When the short standard is used, then press the

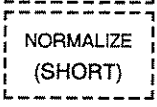

The message "Wait for Sweep" is displayed and the calibration data are obtained. The calibration ends when the message disappears.

- ⑤ Connects a sample to perform the measurement.

Note: Do not move the analyzer, the cable, the connector, the stand, and others when the the message is displayed.

**R3753 SERIES  
NETWORK ANALYZER  
OPERATION MANUAL**

**4.5 Calibration**

---

(This page has been intentionally left blank.)

(3) 1-port full calibration

Operating procedure

- ① Sets the analyzer to the reflection measurement.
- ② Press the **CAL** to call the calibration menu.
- ③ Press the **CAL MENUS** to call the full calibration selection menu.
- ④ Press the **1PORT FULL CAL** to select the 1-port full calibration selection menu, and call the 1-port full calibration menu.
- ⑤ Connect the open standard to the measurement port and press the **OPEN**.  
The message "Wait for Sweep" is displayed and the calibration data are obtained. The calibration is completed when the message disappears. (See Note)
- ⑥ Connect the short standard to the measurement port and press the **SHORT**.  
The message "Wait for Sweep" is displayed and the calibration data are obtained. The calibration is completed when the message disappears. (See Note)
- ⑦ Connect the long standard to the measurement port and press the **LOAD**.  
The message "Wait for Sweep" is displayed and the calibration data are obtained. The calibration is completed when the message disappears. (See Note)
- ⑧ Press the **DONE 1-PORT** to execute the 1-port full calibration.
- ⑨ Connect a sample to perform the measurement.

Note :Do not move the analyzer, the cable, the connector, the stand, and others when the the message is displayed.

CAUTION

1. When the measurement has already been executed, set the calibration setting to OFF and clear the measurement data, then restart the calibration. The full calibration cannot perform the measurement operation to prevent the calibration data loss by miss operation during the calibration or if the data existed. (See section 4.5.6.)

2. Each calibration data can be obtained again before pressing the

**DONE  
1-PORT**

(This page has been intentionally left blank.)

### 4.5.4 Extending Measurement Reference Surface

Is the function which moves the calibration surface to the end of the cable when the extension cable is connected to the test port after calibration. The function calibrates the addition of the electrical length, assuming that the cable having no loss completely has been added. That is, it obtains the phase characteristics only for a sample by calibrating the phase shift for the addition.

- **Electrical length calibration**  
Calibrates the electrical length which has been set to the measurement data. The measurement port type is not identified. It can be used not only for calibration but also measuring the electrical length of the cable. Also, it can be used to measure flatness of the phase by removing phase change due to the electrical length of the actual sample.
- **Port extension**  
Measurement is made, assuming that the extension cable with the electrical length already set is connected to the measurement port. That is, the electrical length already set is automatically calibrated according to the change of the measurement port. For example, if a calibration value 10ns is set to the port 1 and a value 20ns is set to the port 2 when S parameter test-set is used, the calibration is automatically made as follows:

For S11 measurement: (PORT 1) × 2 = 20ns

For S21 measurement: (PORT 1) + (PORT 2) = 30ns

- **Phase offset**  
This function does not calibrate the electrical length. It adds a constant phase value as an offset regardless of the frequency.
- **Transfer constant ( $V_t$ )**  
Sets the transfer constant value to be used to calculate the electrical length. The initial setting is  $V_t = 1$ .

$$V_t = \frac{1}{\sqrt{\epsilon_R}}$$

$$\begin{aligned} \text{Phase offset value/compensation value } \Phi \text{ (deg)} &= \frac{L}{c} \times \frac{1}{V_t} \times f \times 360 \\ &= S \times f \times 360 \end{aligned}$$

$V_t$ : Transfer constant  
 $L$ : Electrical length (distance)  
 $c$ : Light speed  
 $S$ : Electrical length (time)  
 $f$ : Frequency  
 $\epsilon_R$ : Dielectric constant

**R3753 SERIES  
NETWORK ANALYZER  
OPERATION MANUAL**

**4.5 Calibration**

---

(This page has been intentionally left blank.)



Operation procedure

Page 2 of 2 in the calibration menu includes the menu with which the reference surface is extended.

- ① Press the **CAL** to call the calibration menu (1 of 2).
- ② Press the **More 1/2** to call the calibration menu (2 of 2).
- ③ Calibration menu (2 of 2)

- |                               |   |   |
|-------------------------------|---|---|
| <b>ELEC DELAY<br/>ON/OFF</b>  | : | Selects ON/OFF of the electrical length calibration.                        |
| <b>ELECTRICAL<br/>DELAY</b>   | : | Sets the calibration value for the electrical length in a unit of time.     |
| <b>ELECTRICAL<br/>LENGTH</b>  | : | Sets the calibration value for the electrical length in a unit of distance. |
| <b>VELOCITY<br/>FACTOR</b>    | : | Sets the transfer constant value.   |
| <b>PHASE<br/>OFFSET VALUE</b> | : | Sets the phase offset value.  |
| <b>PORT<br/>EXTENSION</b>     | : | Calls the port extension menu. (See step ④)                                 |

(This page has been intentionally left blank.)

④ Port extension menu

- EXTENSION ON/OFF** : Selects ON/OFF of the port extension.
- EXTENSION INPUT R** : Sets the value of the input port R extension by time.  
(Note 2)
- EXTENSION INPUT A** : Sets the value of the input port A extension by time.
- EXTENSION INPUT B** : Sets the value of the B input port B extension by time.  
(Note 1)
- EXTENSION PORT 1** : Sets the value of the S parameter test-set port 1 extension by time.  
(Note 3)
- EXTENSION PORT 2** : Sets the value of the S parameter test-set port 2 extension by time.  
(Note 3)

(Note 1) This is not displayed in R3753B/E.

(Note 2) This is not displayed in R3753E.

(Note 3) This can be set only the case with which S parameter test set is connected with R3753A.

**R3753 SERIES  
NETWORK ANALYZER  
OPERATION MANUAL**

**4.5 Calibration**

---

(This page has been intentionally left blank.)

### 4.5.5 Calibration Data Clear

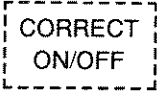
Once the calibration is executed, the  which indicates the calibration being executed is set to ON. For re-calibration, the calibration data must be cleared.

Note :The re-calibration operations differs between the normalize and the full calibration.

(1) For normalize

Whether calibrated or not, the data is re-calibrated by pressing the





Note : The normalize calibration data is overwritten by the re-calibration operation so that the function for creating the calibration data is not provided.

(2) For full calibration

If the full-port calibration data has already existed, whether the calibration is effective or not, the re-calibration cannot be executed. To re-calibrate the data, clear the data.

The calibration data cannot be cleared during calibration operation to prevent miss operation.

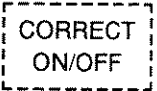
#### Operation procedure

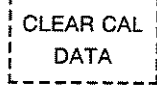
- ① Press the  to call the calibration menu.
- ② Sets the  to OFF.
- ③ Press the  to call the full-calibration selection menu.
- ④ Press the  to clear the calibration data.
- ⑤ Select any one of 1-port/2-port full calibration and enter the calibration operation.

#### CAUTION

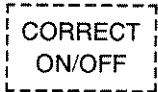
If the  is set to OFF, unless the calibration data is not cleared, the calibration can be set to ON again,

## 4.6 Marker Function

The value of the data displayed can be read out with the marker. Also, the marker can find out the maximum or minimum value and change the settings of the signal source and the display.

Up to ten markers can be set for each channel and one of them is set to the active marker. The change of the marker setting is made to the active marker. The values on active marker is displayed on the screen. Also, the marker list function can display all the values on other markers than the active marker at the same time.

**MKR** : Calls a marker menu to set a marker.

**MKR→** : Calls a marker search menu for a marker analysis.

An active marker and a normal marker are shown in the following.

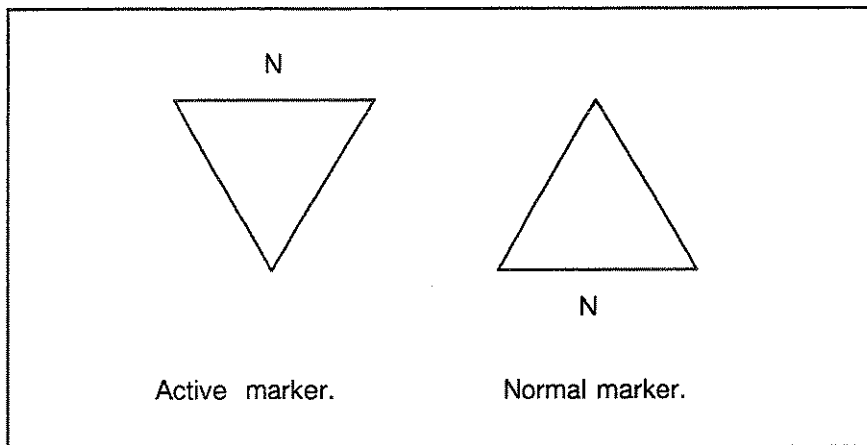



### 4.6.1 Setting Marker

Up to ten markers can be set for each channel and the marker which is displayed at the marker area on the screen is called an "active marker".

This function sets the active marker or changes the marker already set.

Operation procedure

① Press the  to call the marker menu.

② Press the  to call the active marker menu.

③ active marker menu

• active marker menu (1 of 2)

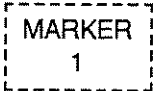
 : Sets the marker 1 for the active menu.

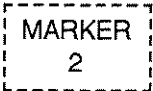
 : Sets the marker 2 for the active menu.

 : Sets the marker 3 for the active menu.

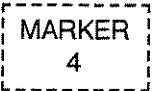
 : Sets the marker 4 for the active menu.

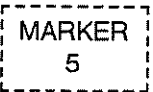
 : Sets the marker 5 for the active menu.

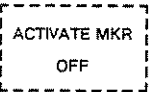
 : Sets off only the active marker.  
If plural markers are set, a marker of the smallest number becomes an active marker.

Only when a marker frequency is displayed in the active area, its marker is controlled with the ten - key and the UP/DOWN key.

- active marker menu (2 of 2)

MARKER  
6 : Sets the marker 6 for the active menu.

MARKER  
7 : Sets the marker 7 for the active menu.

MARKER  
8 : Sets the marker 8 for the active menu.

MARKER  
9 : Sets the marker 9 for the active menu.

MARKER  
10 : Sets the marker 10 for the active menu.

ACTIVATE MKR  
OFF : Sets off only the active marker.





### 4.6.2 Marker Coupling between Channels

The analyzer has two channels. The function is used to select if the markers are interlocked between the channels or not.

"Marker interlock between channels" means that the marker which has been set for the active channel is automatically set for the non-active channel regardless of ON/OFF of the dual channel display. "Non-interlock" means that the markers are made to independently operate for each channel.

#### Operation procedure

- ① Press the  to call the marker menu.
- ② Press the  to call the marker mode menu.
- ③ Press the  to select the marker coupling between the channels.  
 CPL : Coupling ON (interlock between channels)  
 UNCPL : Coupling OFF (non interlock between channels)

If sweep time satisfies the following conditions, even if the MKR CPL is specified, a marker is not coupled.

1. When the sweep type of either of CH1/2 is set to the USER SWEEP or the PROG SWEEP.
2. When both a frequency sweep and a level sweep are set simultaneously.
3. When CH 1/2 is set to the zero span mode.

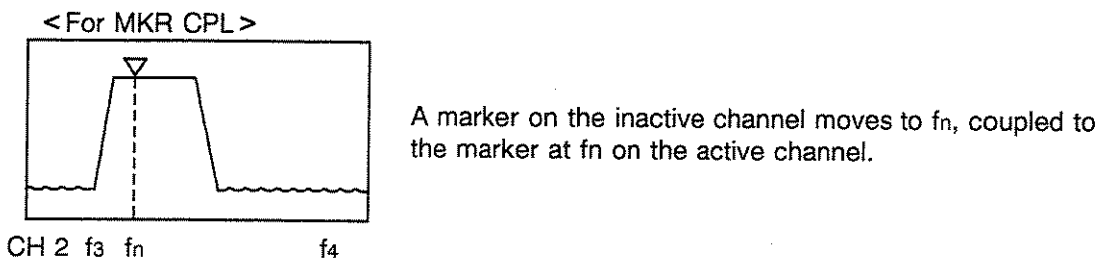
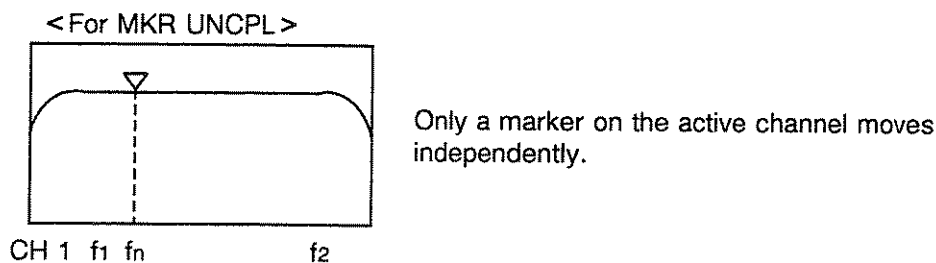

### 4.6.3 Interpolation Between Measurement

The marker can be assigned to either of one mode that sets markers and reads data of each marker by interpolating linearly between measuring points and another mode that sets markers to only actual measuring points.

Operation procedure

① Press the **MKR** to call the marker menu.

② Press the **MARKER MODE MENU** to call the marker mode menu.

③ Interpolation between measurement points is selected by **MKR CMP/UNCMP**.

CMP: Interpolation ON

UNCMP: Interpolation OFF

When the sweep type is set to USER SWEEP/PROG SWEEP, even if CMP is selected, the interpolation depends on the number of set points.

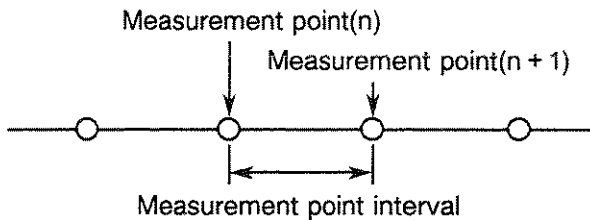

### 4.6.4 Displaying Marker Read out Value

The marker value displayed on the screen always indicates the active marker. To display other than that marker, use the marker list function to list all the marker settings at a time.

Operation procedure

① Press the **MKR** to call the marker menu.

② Press the **MKR LIST ON/OFF** to select ON/OFF of the marker list display.

### 4.6.5 Delta-Marker Function

The delta-marker function is used to find out the difference between the active marker and the specified marker. Three kinds of modes are available depending on the marker to be specified, as follows:

- $\Delta$  MKR mode: Obtains the difference between the child and active markers by setting the child marker to the position of the active marker. The difference between the current position and the previous position (child marker) can be obtained by moving the active marker.
- ACT MKR mode: Obtains the difference between the active marker and the other marker.
- FIXED MKR mode: Obtains the difference between the active marker and the fixed marker by freely setting the fixed marker regardless of the trace data. The fixed marker is set with the stimulus and response values.

The response values for the other markers including the child marker are on the trace data. However, the fixed marker is always fixed to the position of the stimulus and response values regardless of the trace data.

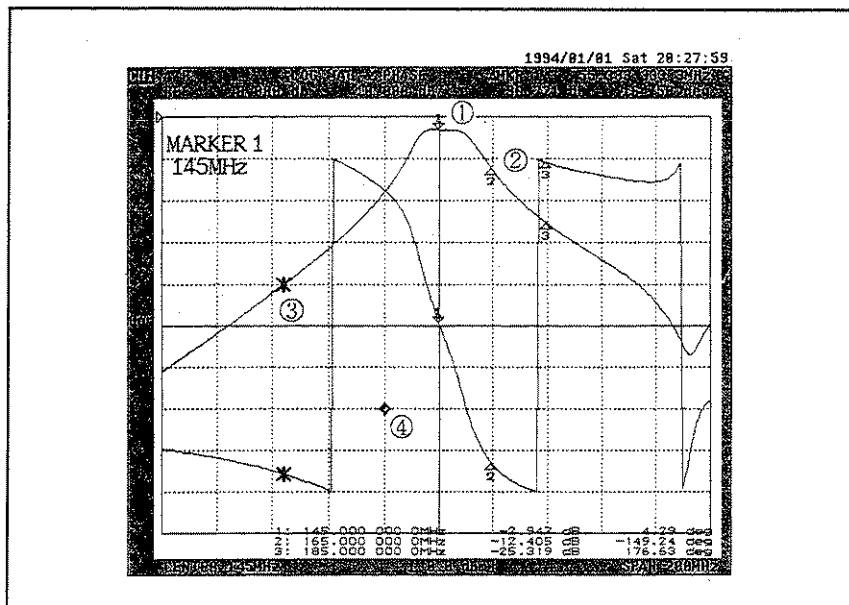

- $\Delta$ REF =  $\Delta$ MKR: The delta value of active marker ① and the child marker ③ is measured.
- $\Delta$ REF = ACT MKR: The delta values of active marker ① and compare marker ② is measured.
- $\Delta$ REF = FIXED MKR: The delta value of active marker ① and the Fixed marker ④ is measured.

Operation procedure

① Press the **MKR** to call the marker menu.

② Press the **ΔMODE MENU** to call the delta-mode menu.

③ Delta mode menu

- ΔMODE OFF** : Sets OFF the delta mode.
- ΔREF = ΔMKR** : Selects the ΔMKR mode. (See step ④.)
- ΔREF = ACT MKR** : Selects the ACT MKR mode to call the ACT MKR menu. (See step ⑤.)
- ΔREF = FIXED MKR** : Selects the FIXED MKR mode.
- FIXED MKR POSITION** : Calls the FIXED MKR setting menu. (See step ⑥.)

④ For Δ MKR mode

Pressing the **ΔREF = ΔMKR** in step ③ causes the child marker (\*) to be displayed on the active marker position and the result to be displayed at the active area on the screen.

Since the active marker setting can be changed, obtain the data by moving the active marker using the data knob.

⑤ For ACT MKR mode

Pressing the **ΔREF = ACT MKR** in step ③ calls the ACT MKR menu. Set the marker for comparison. Since the menu has also the key to change the active marker, it is possible to change the active marker without returning to the **MKR**.

● Delta mode menu (1 of 2)

COMPARE MARKER 1	:	Changes the marker for comparison to the marker 1.
COMPARE MARKER 2	:	Changes the marker for comparison to the marker 2.
COMPARE MARKER 3	:	Changes the marker for comparison to the marker 3.
COMPARE MARKER 4	:	Changes the marker for comparison to the marker 4.
COMPARE MARKER 5	:	Changes the marker for comparison to the marker 5.
ACTIVATE MARKER [ ]	:	Calls the active marker selection menu. (See section 4.6.1.)

● Delta mode menu (2 of 2)



COMPARE MARKER 6	:	Changes the marker for comparison to the marker 6.
COMPARE MARKER 7	:	Changes the marker for comparison to the marker 7.
COMPARE MARKER 8	:	Changes the marker for comparison to the marker 8.
COMPARE MARKER 9	:	Changes the marker for comparison to the marker 9.
COMPARE MARKER 10	:	Changes the marker for comparison to the marker 10.
ACTIVATE MARKER [ ]	:	Calls the active marker selection menu. (See section 4.6.1.)

⑥ For FIXED MKR mode

Pressing the  in step ③ displays the difference between the active MKR and the FIXED MKR (◇) on the active area of the screen.

To set the FIXED MKR position, press the  on the same menu to call the FIXED MKR setting menu.

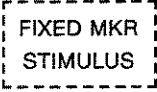
● FIXED MKR setting menu

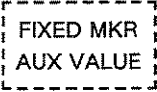
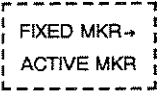
-  : Sets the FIXED MKR stimulus value.
-  : Sets the FIXED MKR response value.
-  : Sets the response value (that is, the imaginary part) of FIXED MKR in the display of a smith chart and polar coordinate.
-  : Sets the FIXED MKR to the active marker position.

If changing the stimulus value, reference value, or others cause the fixed marker to move outside the screen, the fixed marker is not displayed.

The fixed marker can be displayed and set even if the delta mode is off.

If a parameter other than "1/S" has been set to CONVERSION ON in the measure or parameter conversion menu, the fixed marker can not be set nor displayed.

\* FIXED MKR STIMULUS/VALUE/AUX VALUE can be set only with the ten-key.

### 4.6.6 Marker Menu during Impedance Measurement

The marker menu can select the impedance from three modes (parameter conversion, Smith chart display, polar coordinate) during parameter conversion or impedance measurement by the marker to directly read the impedance.

① Press the MKR to call the marker menu.

② Press the MARKER  
MODE MENU to call the marker mode menu.

③ Marker mode menu

CONVERSION  
MKR MENU  
[ ] : Calls the conversion marker menu which sets the marker data display mode during the parameter conversion. (See step ④.)

SMITH  
MKR MENU  
[ ] : Calls the Smith marker menu which sets the marker data display mode during the Smith chart display. (See step ⑤.)

POLAR  
MKR MENU  
[ ] : Calls the menu which sets the marker data display mode during the polar coordinate display. (See step ⑥.)

④ Conversion marker menu

DEFAULT : Displays the value corresponding to the data format.

LIN MKR : Displays the linear amplitude value and the phase value.  
 When a format is selected except SMITH and POLAR in the format menu, if SMOOTHING is set to ON, a correct value can not be obtained.

Re/Im MKR : Displays the complex data.  
 When some format is selected except SMITH and POLAR in the format menu, if SMOOTHING is set to ON, a correct value can not be obtained.

⑥ Smith marker

- LIN MKR : Displays the liner amplitude value and the phase value.
- LOG MKR : Displays the logarithm amplitude value and the phase value.
- Re/Im MKR : Displays the complex data.
- R + jX MKR : Displays the complex impedance.
- G + jB MKR : Displays the complex admittance.
- ZO VALUE : Sets the characteristic impedance.

⑥ Polar marker menu

- LIN MKR : Displays the liner amplitude value and the phase value.
- LOG MKR : Displays the logarithm amplitude value and the phase value.
- Re/Im MKR : Displays the complex data.
- ZO VALUE : Sets the characteristic impedance.



### 4.6.7 Marker Analysis Function

The marker analysis function has the search functions for obtaining the values such as maximum value and minimum value.

This function also provides the functions to change the signal source and the display scale setting by the marker value.

The following items are provided for search functions:

- Maximum value
- Minimum value
- Phase: 0 deg
- Phase:  $\pm 180$  deg
- Specified response value (amplitude, phase)
- Filter analysis (bandwidth, Q, shaping factor)

To perform the analysis operation, two modes are provided. Select any one of the mode for only one execution, or the mode for repeating every sweeping. The analysis area is selected the all measurement area, or the part search mode performing within the area specified by the marker delta mode.

#### CAUTION

Even if a parameter other than "1/S" is set in the parameter conversion menu and also "LIN MKR,Re/Im MKR" is set in the conversion marker menu, data specified in the format menu is searched. (However, for a smith chart and a polar coordinate, LOG MAG type of data is searched.)

#### Operation procedure

- ① Press the **MKR →** to call the marker search menu.
- ② Marker search menu (This menu is used to change the signal source or the display scale.)

- |                            |   |  |
|----------------------------|---|--|
| <b>MARKER ⇄<br/>START</b>  | : | Changes the sweep-start value of the signal source to the active marker position.  |
| <b>MARKER ⇄<br/>STOP</b>   | : | Changes the sweep-stop value of the signal source to the active marker position.   |
| <b>MARKER ⇄<br/>CENTER</b> | : | Changes the sweep-center value of the signal source to the active marker position. |

- Δ MARKER ⇨  
 SPAN

:
Changes the span of the signal source to the area specified by the Δ MARKER.
- MARKER ⇨  
 REF. VALUE

:
Changes the reference value of the display scale to the response value of the active marker.
- PART SRCH  
 [     ]

:
Calls the part search menu. (See step ⑦.)
- MKR SARCH  
 [     ]

:
Calls the search menu. (See step ③.)

③ Search menu

- MKR SEARCH  
 OFF

:
The search function is released.
- MAX

:
Moves the active marker to the maximum value position.  
 If SMITH or POLAR is set in the format menu, the active marker moves to the maximum value position of LOG MAG type of data.  
 However, if SMOOTHING is set to ON, the active marker does not move to a correct data.
- MIN

:
Moves the active marker to the minimum value position.  
 If SMITH or POLAR is set in the format menu, the active marker moves to the minimum value position of LOG MAG type of data.  
 However, if SMOOTHING is set to ON, the active marker does not move to a correct data.
- TARGET

:
Calls the target menu which searches the specified value.  
 (See step ④.)
- RIPPLE

:
Calls the ripple menu which searches the ripple. (See step ⑤.)
- FLTR ANAL

:
Calls the filter analysis menu. (See step ⑥.)
- TRACKING  
 ON/OFF

:
Selects the function for searching every sweep.  
 OFF: Searches one time.  
 ON: Searches every sweep. When ON is selected, the search is performed on the search menu, and the search is repeated/executed every sweep.

④ Target menu

TARGET  
VALUE

: Searches the specified value (response value).  
If SMITH or POLAR is set in the format menu, LOG MAG type of data is searched as TARGET VALUE.  
However, if SMOOTHING is set to ON, the active marker does not move to a correct data.

0°

: Searches the phase 0°.  
The phase data is surely searched without regard to any format.  
If SMOOTHING is set to ON, the active marker does not move to a correct data.

± 180°

: Searches the phase 180°.  
The phase data is surely searched without regard to any format.  
If SMOOTHING is set to ON, the active marker does not move to a correct data.

LEFT  
SEARCH

: Searches specified value of left side from current mark position.

RIGTH  
SEARCH

: Searches specified value of right side from current mark position.

\* TARGET VALUE can be specified only with the ten-key.

⑤ Ripple menu

MAX  $\cap$

: Searches for the maximum of local maximum peak values.  
If SMITH or POLAR is set in the format menu, LOG MAG type of data is searched.  
However, if SMOOTHING is set to ON, the active marker does not move to a correct data.

MIN U

: Searches for the minimum of local minimum peak values.  
If SMITH or POLAR is set in the format menu, LOG MAG type of data is searched.  
However, if SMOOTHING is set to ON, the active marker does not move to a correct data.

$\Delta\text{MAXn-MINU}$  : Calculates the difference between the maximum of local maximum peak values and the minimum of local minimum peak values.  
 Moves the active marker to the position of the maximum of local maximum peak values and moves the delta marker (other than FIXED MKR) to the position of the minimum of local minimum peak values.  
 If SMITH or POLAR is set in the format menu, LOG MAG type of data is searched.  
 However, if SMOOTHING is set to ON, a correct data cannot be searched.

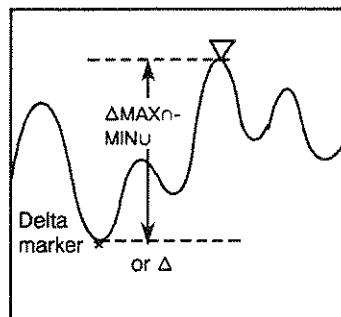

$\Delta X$  : Specifies the detecting sensitivity for the ripple search.  
 The differential coefficient  $\Delta X$  is specified here.  
 Specify a ratio, regarding the full scale of the horizontal axis as 100%.

$\Delta Y$  : Specifies the detecting sensitivity for the ripple search.  
 The differential coefficient  $\Delta Y$  is specified here.  
 \*  $\Delta X$  and  $\Delta Y$  are specified only with the ten-key.

For obtaining ripple (local maximum peak value)

To obtain ripple value under the detecting sensitivity  $\Delta Y/\Delta X$ , search for a point (a) where the gradient (Y/X) of the waveform is larger than  $\Delta Y/\Delta X$ .

Next, search a point (d) where the reverse gradient (Y/X) of the waveform is larger than  $\Delta Y/\Delta X$ . Then the maximum value between (a) and (d) is obtained as a local maximum peak value.

A local minimum peak value can be obtained by reversing the polarity of  $\Delta Y/\Delta X$  in the above procedure.

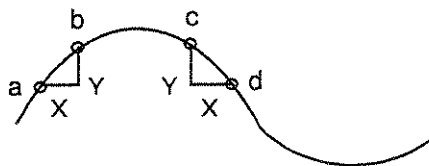

⑥ Filter analysis menu

- WIDTH VALUE** : Specifies the bandwidth to be searched.  
 The bandwidth is determined by specifying loss (X dB) off the active marker position.
- SEARCH IN/OUT** : IN: Searches from the active marker position to the screen edge.  
 OUT: Searches from the screen edge to the active marker position.
- FILTR ANAL ON/OFF** : Displays the result of filter analysis on the screen.  
 C.F: Center frequency in the bandwidth determined by specifying loss (X dB) off the active marker position.  
 L.F: Left side frequency in the bandwidth  
 R.F: Right side frequency in the bandwidth  
 BW: Bandwidth  
 Q: Q factor  
 SF: Shaping factor

\* Q factor and Shaping factor are determined by minimum loss value.

When the format type is set except LOG MAG, MAG&PHASE/LOG, and MAG&DELAY, if SMOOTHING is set to ON, a correct data cannot be searched.

Examples of the result of filter analysis

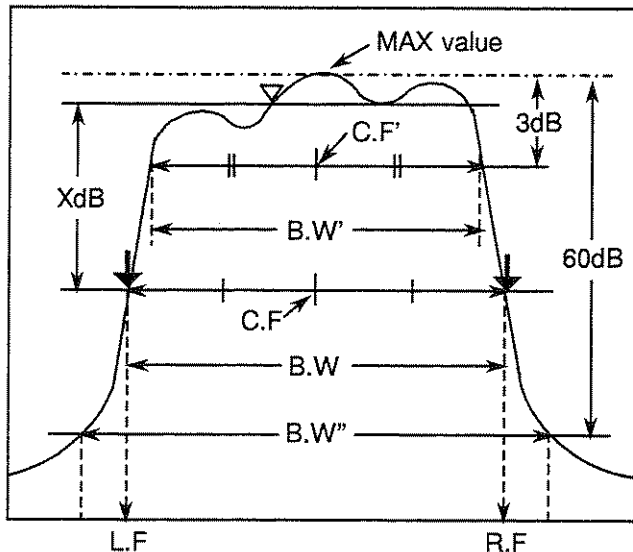

Q factor is calculated from a bandwidth B.W.' where data is 3 dB or less off a minimum loss value of the measured data, and the center frequency C.F.' in the bandwidth B.W.'.

$$Q = \frac{C.F'}{B.W'}$$

Shaping factor is calculated from a bandwidth B.W.' where data is 3 dB or less off minimum loss value of the measured data, and a bandwidth B.W.' where data is 60 dB or less off the minimum loss value.

$$S.F = \frac{B.W''}{B.W'}$$

Example of filter analysis execution

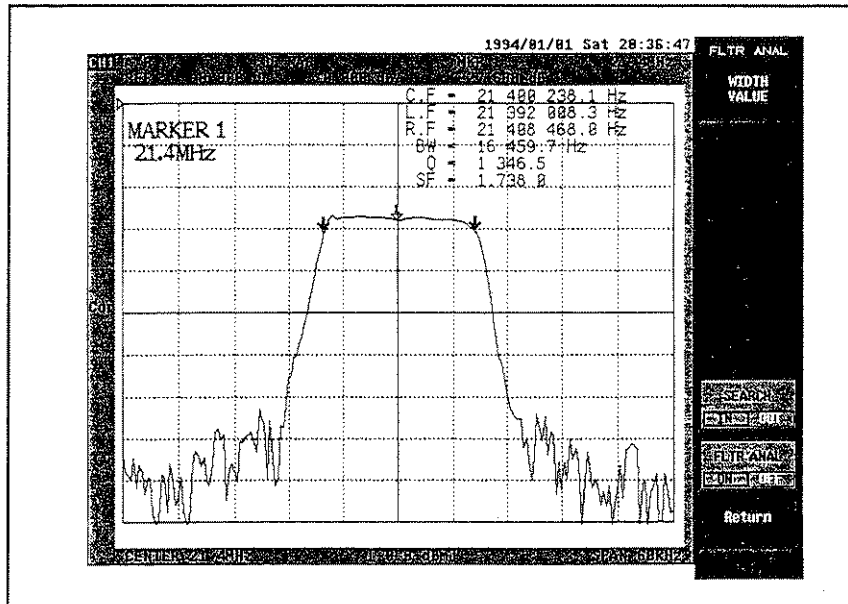

- ⑦ Part search menu (This menu is used to search specified area instead of the whole measurement area for obtaining the analysis which obtains the maximum value and minimum value.)

- △ MODE MENU : Calls the △ marker mode menu. (See section 4.6.5.)
- SET RANGE : Sets partially search range which was set at △ marker mode.
- PART SRCH ON/OFF : Selects ON/OFF of the part search.  
 ON: Part search  
 OFF: All search

Measurement example by MAX search

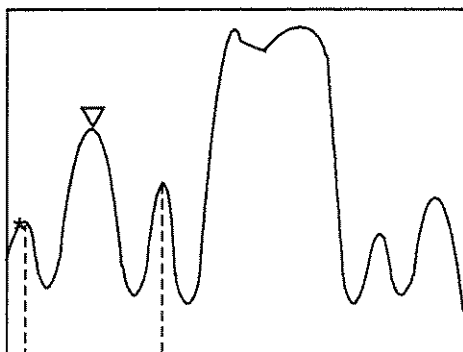

A range specified with △ marker.

At OFF  
 Searches a maximum response value within measurement frequency.

At ON  
 Set a range specified with \*marker mode as a partial search range with SET RANGE. Then set PART SRCH to ON and a marker begins to search the maximum value in the set range.

## 4.7 Sweep

The following five types are provided for sweeping the signal source.

- Linear frequency sweep: The frequency sweep between measurement points is performed in equal steps linearly.
- Log (logarithm) frequency sweep: The frequency sweep between measurement points is performed in logarithmic step.
- User frequency sweep: The user frequency sweep is used to perform in every segments by dividing the measurement points into maximum 30 segments. For example, if the segments are set in the stop area, pass area, twofold pass area of the band pass filter, then high data throughput can be obtained because of no sweeping in unnecessary area.
- Program sweep: The program sweep is used to perform in every segments by dividing the measurement points into maximum 30 segments. Other than frequency, the output level, receiver section resolution bandwidth, settling time, and attenuator can be set in every segments. The optimum sweep condition can be set, including throughput and dynamic range.
- Power sweep: The power sweep is used for level characteristic measurement.

### 4.7.1 Setting Sweep Type

Operation procedure

- ① Press the **MENU** to call the signal source menu.
- ② Press the **SWEEP TYPE** to call the sweep type menu.
- ③ Sweep type menu

<b>LIN FREQ</b>	:	Sets to the liner frequency sweep.
<b>LOG FREQ</b>	:	Sets to the log (logarithm) frequency sweep.
<b>USER SWEEP</b>	:	Sets to the user frequency sweep.
<b>PROGRAM SWEEP</b>	:	Sets to the program sweep.
<b>POW SWEEP</b>	:	Sets to the power sweep.
<b>EDIT USER SWEEP</b>	:	Calls the segment editing menu of the user frequency sweep. (See section 4.7.2.)
<b>EDIT PROG SWEEP</b>	:	Calls the segment editing menu of the program frequency sweep. (See section 4.7.3.)

Sweep area settings for the linear frequency sweep, log frequency sweep, and power sweep are performed as follows:

Press the **START** , **STOP** , **CENTER** , or **SPAN** .

For the user sweep and program sweep, set the sweep area on each segment editing menu.

CAUTION

If **USER SWEEP** or **PROGRAM SWEEP** is set, input segments are detected and arranged internally in increasing order of frequency.  
If **STOP** frequency of a segment is higher than **START** frequency of the next segment in the arranged segments, an error occurs.



## 4.7.2 Editing Segment of User Frequency Sweep

Operation procedure

① Press the **MENU** to call the signal source menu.

② Press the **SWEEP TYPE**  
[ ] to call the sweep type menu.

③ Press the **EDIT**  
**USER SWEEP** to call the user frequency sweep segment editing menu.

④ User frequency sweep segment editing menu

<b>SEGMENT:</b> <b>NUMBER</b>	:	Specifies the segment number in the range of 0 to 29.
<b>START</b>	:	Sets the start frequency of the specified segment number.
<b>STOP</b>	:	Sets the stop frequency of the specified segment number.
<b>FREQ</b>	:	When the specified segment number is set to 1 point, sets the frequency of the specified point. In reverse, if this frequency is set, then point number automatically becomes 1 point.
<b>POINT</b>	:	Sets the point number of the specified segment number.
<b>CLEAR</b> <b>SEG</b>	:	Clears the specified segment.
<b>CLEAR</b> <b>ALL SEG</b>	:	Clears all segments.

CAUTION (1 of 2)

1. If the same segment number is edited on the segment editing menu of the program sweep, then the user frequency segment is also changed. (Segment holds the program sweep in common.)

CAUTION (2 of 2)

2. The setting is not available such as the total setting point number of each segment by user frequency scan exceeds 1201 points. (The maximum value of measurement point number is 1201 points.)



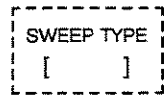
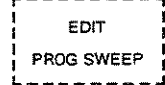

### 4.7.3 Editing Segment of Program Sweep

Operation procedure

- ① Press the  to call the signal source menu.
- ② Press the  to call the sweep type menu.
- ③ Press the  to call the program sweep segment editing menu.

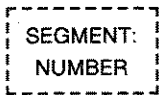
Note : Editing cannot be performed during the user frequency sweep and program sweep.

- ④ Program sweep segment editing menu
  - Program sweep segment editing menu (1 of 2)

-  : Specifies the segment number in the range of 0 to 19.
-  : Sets the start frequency of the specified segment number.
-  : Sets the stop frequency of the specified segment number.
-  : Sets the point number of the specified segment number.

CLEAR  
SEG : Clears the specified segment.

CLEAR  
ALL SEG : Clears all segments.

- Program sweep segment editing menu (2 of 2)

SEGMENT:  
POWER : Sets the output level of the set segment number.

IF RBW : Sets the receiver section resolution bandwidth of the set segment number.

SETTLING  
TIME : Sets the settling time of the set segment number.

R ATT  
0dB/20dB : Sets the R input attenuator of the set number. (Note 2)

A ATT  
0dB/20dB : Sets the A input attenuator of the set number.

B ATT  
0dB/20dB : Sets the B input attenuator of the set number. (Note 1)

(Note 1) This is not displayed in R3753B/E.

(Note 2) This is not displayed in R3753E.

CAUTION

1. If the same segment number is edited on the segment editing menu of the program sweep, then the user frequency segment is also changed. (Segment holds the program sweep in common.)
2. The setting is not available such as the total setting point number of each segment by user frequency scan exceeds 1201 points. (The maximum value of measurement point number is 1201 points.)

R3753 SERIES  
 NETWORK ANALYZER  
 OPERATION MANUAL

4.7 Sweep

< Example of program sweep execution >

The waveform of the screen upper shown as follows is measured by using program sweep.

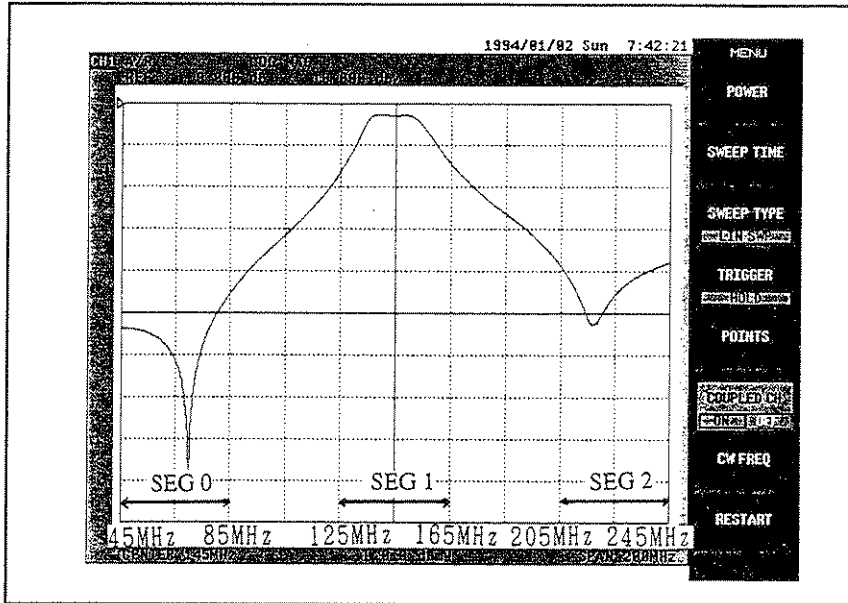

SEG	START	STOP	POWER	IF RBW	POINT
0	45MHz	85MHz	0.5dBm	1kHz	200
1	125MHz	165MHz	0.0dBm	10kHz	200
2	205MHz	245MHz	0.0dBm	10kHz	200

Each segment is shown like the above-mentioned.

And edits and the result of execution is shown in the following.

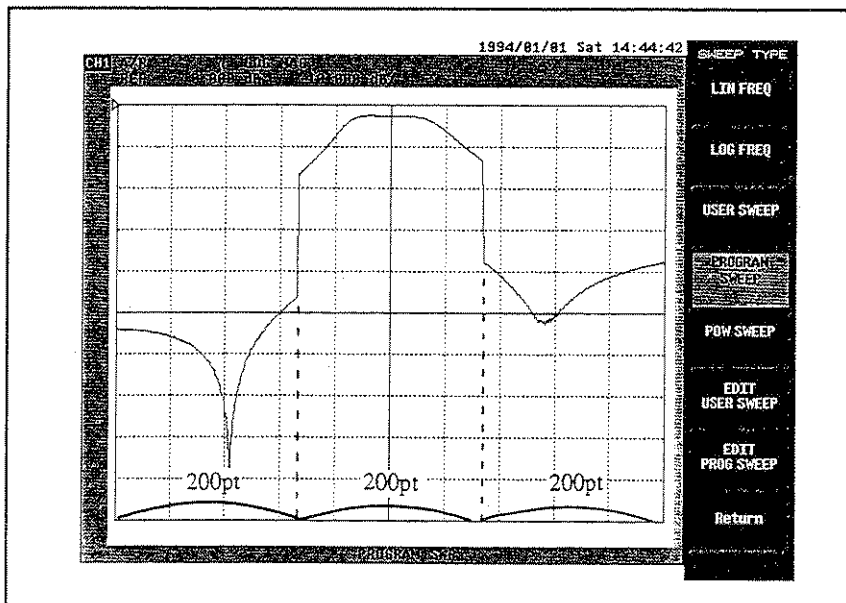

## 4.8 INSTRUMENT STATE Block

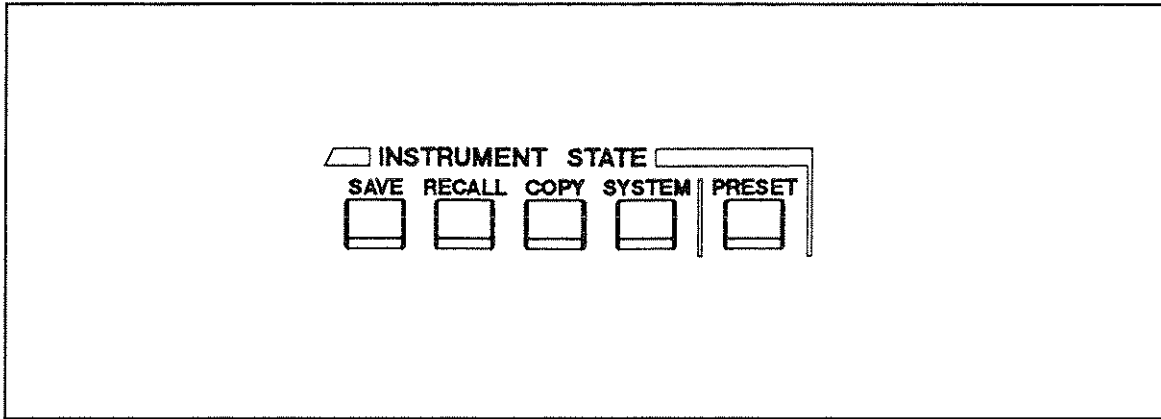

The INSTRUMENT STATE block is used to set the system control functions which have no concern with the measurement. The functions are provided such as a time/date set, limit-line test, save/recall, and hard copy.

- SAVE** : Calls the save menu to be saved such as a setting data and calibration data of the analyzer. (See section 4.10.)
- RECALL** : Calls the recall menu to be recalled such as a setting data and calibration data of the analyzer. (See section 4.10.)
- COPY** : Calls the copy menu to execute the hard copy of screen for a plotter/printer. (See section 4.11.)
- SYSTEM** : Calls the system menu to be set such as an internal disk and date/time display. (See section 4.8.1.)
- PRESET** : Initializes the settings of the analyzer.

### 4.8.1 System Menu

#### Operation procedure

① Press the **SYSTEM** to call the system menu.

② System menu

**SYSTEM DRIVE** : Calls the system for selecting a drive and disk to be used and its format type. (See step ③.)

**SET CLOCK** : Calls the real-time clock menu for setting a date/time. (See step ⑥.)

③ System drive menu

**DEFAULT DRIVE** : Calls the default drive menu. (See step ④ )  
A drive selected on this menu is set as a current drive when power is turned on.

**FORMAT TYPE** : Calls the disk format menu for selecting a initialize format type.  
(See step ⑤ )

④ Default drive menu

**A:** : Selects the drive A.  
Floppy disk drive

**B:** : Selects the drive B.  
RAM disk drive (Without backup)

**C:** : Selects the drive C.  
RAM disk drive (With backup)

**D:** : Select the drive D.  
ROM disk drive (Read only)

⑤ Disk format menu

**1.2MB  
8 SECTORS** : Specifies the 1.2Mbyte 8 sectors per track when initializing a 2HD floppy disk. (Same as NEC PC9801 series, 2HD floppy disk format)

**1.2MB  
15 SECTORS** : Specifies the 1.2Mbyte 15 sectors per track when initializing a 2HD floppy disk. (Same as TOSHIBA J3800 series, 2HD floppy disk format)

**1.44MB  
18 SECTORS** : Specifies the 1.44Mbyte 15 sectors per track when initializing a 2HD floppy disk. (Same as IBM PC series, 2HD floppy disk format)

⑥ Real-time clock menu

**YEAR** : Sets an year.

**MONTH** : Sets a month.

**DAY** : Sets a date.

**HOUR** : Sets an hour.

**MINUTE** : Sets a minute.

**SECOND** : Sets a second.

## 4.9 GPIB Block

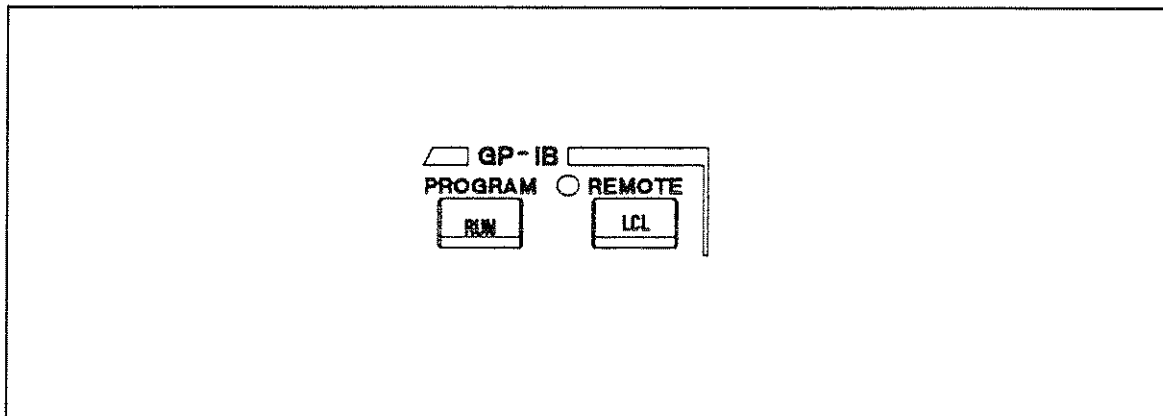

The GPIB block is used to set the controller function, GPIB bus, and GPIB address. For procedure how to create a program, refer to the programming manual of the separate volume.

### PROGRAM

**RUN** : Calls the controller menu. (See section 4.9.1.)

### REMOTE

**LCL** : Calls the GPIB menu. (See section 4.9.2.)  
Moreover, when R3753 is the remote mode by GPIB, it return back to the local mode by pressing the key.

(Note) The operation key of all the panel key becomes disable in the remote mode except this key.





### 4.9.1 Controller Menu

Operation procedure

① Press the  to call the controller menu.

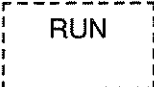
② Controller menu

 : Starts a program.

 : Displays a file list and calls the load menu. (See step ③.)

 : Displays a program list.

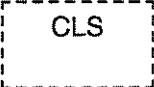
 : Clears the text display on the screen.

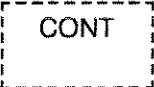
 : Restarts a program from the next line immediately after program pauses.

 : Stops a program.

③ Load menu

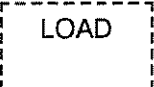
 : Loads the file specified by the cursor.

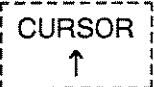
 : Shifts up the cursor used for specifying a file.

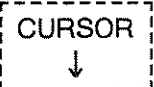
 : Shifts down the cursor used for specifying a file.

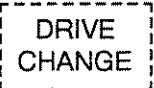
 : Calls the drive menu to change the current drive. (See step 4)

④ Drive menu

A:	:	Selects the drive A. Floppy disk drive
B:	:	Selects the drive B. RAM disk drive (without backup)
C:	:	Selects the drive C. RAM disk drive (with backup)
D:	:	Selects the drive D. ROM disk drive (Read only)

### 4.9.2 GPIB Menu

Operation procedure

① Press the 

REMOTE
LCL

 to call the GPIB menu.

② GPIB menu

SYSTEM CONTROLLER	:	Sets the analyzer to the system controller.
TALKER LISTENER	:	Sets the analyzer to the talker/listener.
SET ADDRESSES	:	Calls the address menu used for setting the GPIB address. (See step ③.)

③ Address menu

ADDRESS R3753	:	Sets the GPIB address of the analyzer.
ADDRESS PLOTTER	:	Sets the GPIB address of the plotter.
ADDRESS PRINTER	:	Sets the GPIB address of the printer.

## 4.10 Save/Recall

By using an internal disk, the analyzer setting and the data saving/recalling (store/read) can be performed.

The following two methods for saving data are provided in accordance with informations to be saved and an internal disk.

- Save register: Saves the analyzer setting and calibration data into RAM disk.
  - Setting; Drive C (RAM disk, backup)
  - Calibration data; Drive B (RAM disk, backup)
  - Memory waveform data; Drive B (RAM disk, without backup)

Note: Since the calibration data and the memory waveform data can not be backed up, if the power is turned off, they are erased.
- Store file: Store the analyzer setting, calibration data, and measurement data on a floppy disk.
  - All informations; Drive A (floppy disk)

### 4.10.1 Selection of Save Type

Operation procedure

① Press the SAVE to call the save menu.

② Save menu

- SAVE REGISTER : Calls the save register menu.(See section 4.10.2.)
- CLEAR REGISTER : Calls the clear register menu used for clearing the stored save register. (See section 4.10.6.)
- STORE FILE : Calls the store file menu used for storing files or setting file names. (See section 4.10.3.)  
The file list (Figure 4-2) will be displayed on the screen.
- PURGE FILE : Calls the purge file menu used for clearing the stored file. (See section 4.10.7.)  
The file list (Figure 4-2) will be displayed on the screen.
- FORMAT DISK : Initializes a floppy disk inserted in drive A.

Note: Before STORE FILE or PURGE FILE is executed, be sure to insert a formatted floppy disk to the drive.

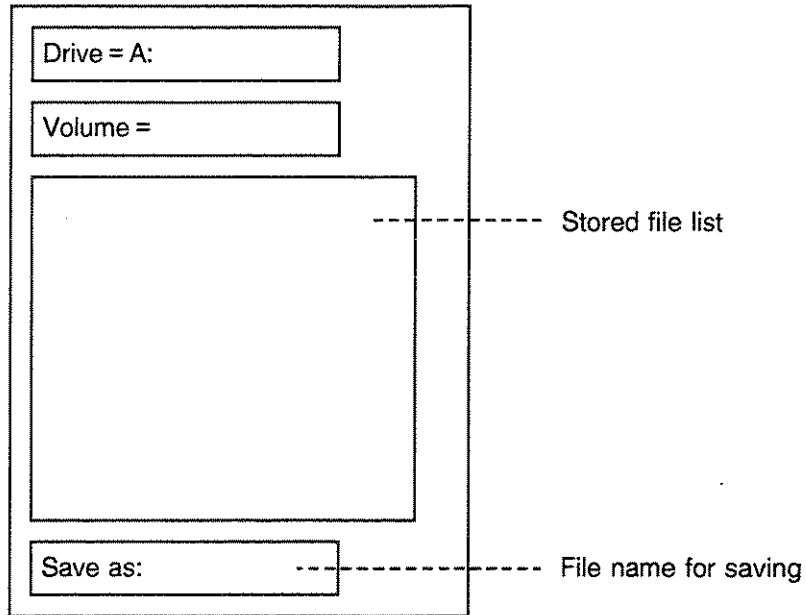

Figure 4-2 File List Display

### 4.10.2 Executing Save Register

Note: When storing data into the saved register, execute the save register operation after erasing data on the clear register menu . (See subsection 4.10.7.)

Operation procedure

- ① Press the SAVE to call the save source menu.
- ② Press the SAVE  
REGISTER to call the save register menu.

③ Save register menu

● Save register menu (1 of 2)



SAVE REG-1	:	Saves the settings, and calibration data, and memory waveform data into the register 1.
SAVE REG-2	:	Saves the settings, and calibration data, and memory waveform data into the register 2.
SAVE REG-3	:	Saves the settings, and calibration data, and memory waveform data into the register 3.
SAVE REG-4	:	Saves the settings, and calibration data, and memory waveform data into the register 4.
SAVE REG-5	:	Saves the settings, and calibration data, and memory waveform data into the register 5.
RENAME REG	:	Calls the rename editing menu used to define a register name. (See section 4.10.4.)







● Save register menu (2 of 2)

SAVE REG-6	:	Saves the settings, and calibration data, and memory waveform data into the register 6.
SAVE REG-7	:	Saves the settings, and calibration data, and memory waveform data into the register 7.
SAVE REG-8	:	Saves the settings, and calibration data, and memory waveform data into the register 8.
SAVE REG-9	:	Saves the settings, and calibration data, and memory waveform data into the register 9.
SAVE REG-10	:	Saves the settings, and calibration data, and memory waveform data into the register 10.
RENAME REG	:	Calls the rename editing menu used to define a register name. (See section 4.10.4.)

### 4.10.3 Executing Store File

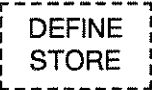
Operation procedure

- ① Press the  to call the save menu.
- ② Press the  to call the store file menu.
- ③ Store file menu

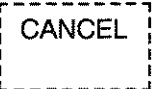
-  : Stores the setting data and calibration data as a file name for storing.
-  :  
 : Shifts the cursor up/down of the saved file list.
-  : Calls the file data menu used to select informations to be stored. (See step ④)
-  : Calls the menu of character editor to define the file name for storing.
-  :  
 : Shifts the cursor up/down of the file name for saving.
-  : Cancels the file store.

④ File data menu (When ON is selected, saves data.)

STATE ON/OFF	:	Saves setting condition.
RAW ARRAY ON/OFF	:	Saves the raw data before formatting.
CORR COEF ON/OFF	:	Saves the calibration data. When the calibration is preferment, ON is automatically selected.
DATA ARRAY ON/OFF	:	Stores the format data.
MEM ARRAY ON/OFF	:	Stores the memory data.

#### 4.10.4 Setting Register Name

The register name is used to set a name for searching easily. When recalling, the register is called as the named resister set.

Operation procedure

- ① Press the SAVE to call the save menu.
- ② Press the SAVE  
REGISTER to call the store file menu.
- ③ Press the RENAME  
REG to display the label window and calls the name editing menu.

④ Name editing menu

EDIT NAME	:	Displays the label window (Figure 4-3) and calls the character editing menu.
CURSOR ↑	:	Shifts the cursor up/down of the register list (Figure 4-4). Edits the register name of the cursor position.
CURSOR ↓	:	

⑤ Character editing menu

DONE	:	Completes editing.
CURSOR →	:	Shifts the label cursor right.
CURSOR ←	:	Shifts the label cursor left.
BACKSPACE	:	Executes the back space operation.
DELETE CHAR	:	Deletes the character of the cursor position.
CLEAR NAME	:	Clears all the characters (names).
CANCEL	:	Cancels editing.

REG1																							
	!	"	#	\$	%	&	'	(	)	*	+	,	-	.	/	0	1	2	3	4	5	6	7
8	9	:	;	<	=	>	?	@	A	B	C	D	E	F	G	H	I	J	K	L	M	N	O
P	Q	R	S	T	U	V	W	X	Y	Z	[	\	]	^	_	`	a	b	c	d	e	f	g
h	i	j	k	l	m	n	o	p	q	r	s	t	u	v	w	x	y	z	{		}	~	

Figure 4-3 Label Window Display

REGISTER LIST:	
1:	REG1
2:	REG2
3:	REG3
4:	REG4
5:	REG5
6:	REG6
7:	REG7
8:	REG8
9:	REG9
10:	REG10





Figure 4-4 Register List Display





### 4.10.5 Setting File Name

The file name is used to set a name for searching easily. When recalling, the file is called as the named file set.

Operation procedure

- ① Press the  to call the save menu.
- ② Press the  to call the store file menu.
- ③ Press the ,  to select a desired file name.
- ④ Press the  to display the label window and calls the character editing menu.

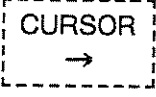
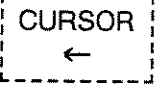
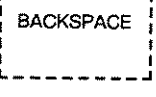
#### ⑤ Character menu

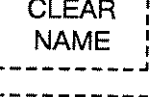
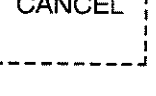
-  : Completes editing.
-  : Shifts the label cursor right.
-  : Shifts the label cursor left.
-  : Executes the back space operation.
-  : Deletes the character of the cursor position.
-  : Clears all the characters (names).
-  : Cancels editing.

### 4.10.6 Clearing Saved Register

Clears registers. When the register name is defined, the defined register name is displayed on the screen.

Operation procedure

- ① Press the 

SAVE
------

 to call the save menu.
- ② Press the 

CLEAR REGISTER
-------------------

 to call the clear register menu.
- ③ Clear register menu

- Clear register menu (1 of 2)

CLEAR REG-1	:	Clears the register 1.
CLEAR REG-2	:	Clears the register 2.
CLEAR REG-3	:	Clears the register 3.
CLEAR REG-4	:	Clears the register 4.
CLEAR REG-5	:	Clears the register 5.



- Clear register menu (2 of 2)

CLEAR REG-6	:	Clears the register 6.
CLEAR REG-7	:	Clears the register 7.
CLEAR REG-8	:	Clears the register 8.
CLEAR REG-9	:	Clears the register 9.
CLEAR REG-10	:	Clears the register 10.

### 4.10.7 Purging Stored File

Purges files. When the file name is defined, the defined file name is displayed on the screen.

Operation procedure

- ① Press the  to call the save menu.
- ② Press the  to call the purge file menu.
- ③ Purges files menu

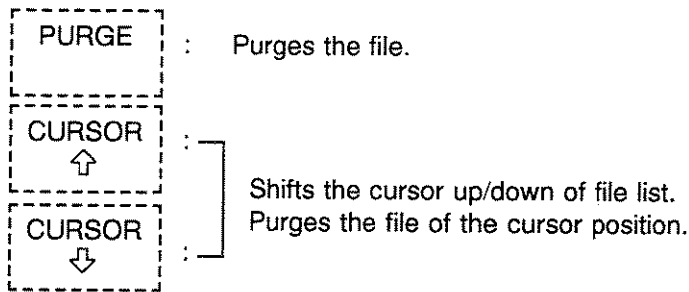

### 4.10.8 Executing Recall

Recalls register or file. When the register/file name is defined, the defined name is displayed on the screen.

Operation procedure

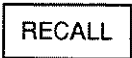
- ① Press the  to call the recall menu.
- ② Recall menu (1 of 2)

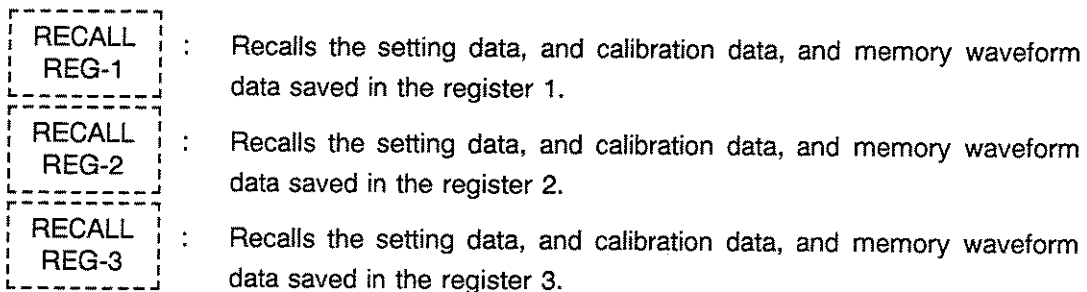

- RECALL REG-4 : Recalls the setting data, and calibration data, and memory waveform data saved in the register 4.
- RECALL REG-5 : Recalls the setting data, and calibration data, and memory waveform data saved in the register 5.
- RECALL POWER OFF : Saves the current setting when the power of the analyzer is turned off. When the power is turned on again, the setting for the analyzer is set as a default (initial state). By pressing this key, the default setting is changed to the stored data reproduction for this recall operator.
- LOAD FILE : Calls the load file menu used to load the all informations stored in the file. (See step ③ or Figure 4-2.)

● Recall menu (2 of 2)

- RECALL REG-6 : Recalls the setting data, and calibration data, and memory waveform data saved in the register 6.
- RECALL REG-7 : Recalls the setting data, and calibration data, and memory waveform data saved in the register 7.
- RECALL REG-8 : Recalls the setting data, and calibration data, and memory waveform data saved in the register 8.
- RECALL REG-9 : Recalls the setting data, and calibration data, and memory waveform data saved in the register 9.
- RECALL REG-10 : Recalls the setting data, and calibration data, and memory waveform data saved in the register 10.
- RECALL POWER OFF : Saves the current setting when the power of the analyzer is turned off. When the power is turned on again, the setting for the analyzer is set as a default (initial state). By pressing this key, the default setting is changed to the stored data setting for this recall operator.
- LOAD FILE : Calls the load file menu used to load the all informations stored in the file. (See step ③ or Figure 4-2.)

Note: Before LOAD FILE is executed, be sure to insert a formatted floppy disk to the drive.

③ Load file menu

- |             |   |   |
|-------------|---|---|
| LOAD        | : | Loads all informations stored in the file.  |
| CURSOR<br>↑ | : | ] Shifts the cursor up/down of file list.<br>Recalls the file of the cursor position. |
| CURSOR<br>↓ | : |   |
| Return      | : | Makes the control return to the recall menu.  |

Note: If a file stored with RAW ARRAY or DATA ARRAY ON is loaded, the sweep becomes HOLD without reservation.

## 4.11 Hard Copy

By using a GPIB bus, data output can be performed directly to peripheral devices such as a graphic printer and a plotter. Set the analyzer as a controller on the GPIB block, furthermore, specify the GPIB address of the printer or the plotter. (See section 4.9.)

### Operation procedure

① Press the COPY to call the copy menu.

② Copy menu

- |                     |   |  |
|---------------------|---|--|
| PLOT                | : | Executes hard copy. (Note)   |
| ABORT               | : | Aborts the hard copy operation. Continued operation cannot be performed.                                     |
| SELECT<br>QUADRANT  | : | Calls the plot scale menu used to select the size and location of the hard copy. (See subsection 4.11.1.)    |
| DEFINE<br>PLOT      | : | Calls the plot data menu used to define the items for hard copy operation. (See subsection 4.11.2.)          |
| CONFIGURE<br>PLOT   | : | Calls the plotter pen menu used to select pen number and data-line type to be used. (See subsection 4.11.3.) |
| PRINT/PLOT<br>SETUP | : | Calls the setup menu used to set up the setting of printer or plotter. (See subsection 4.11.4.)              |

(Note) In using the plotter of HP company, the indication of the error such as error lamp lighting will be occasionally done.

### 4.11.1 Setting Plot Scale

Specifies the output position and the size for plotting on A4 size paper.

Operation procedure

- ① Press the COPY to call the copy menu.
- ② Press the SELECT QUADRANT to call the plot scale menu.
- ③ Plot scale menu

FULL PAGE	:	Selects the plot scale to output one data on A4 size paper with full page.
LEFT	:	Selects the plot scale to output data to the left position by dividing A4 size paper into two blocks.
RIGHT	:	Selects the plot scale to output data to the right position by dividing A4 size paper into two blocks.
LEFT UPPER	:	Selects the plot scale to output data to upper left position by dividing A4 size paper into four blocks.
LEFT LOWER	:	Selects the plot scale to output data to lower left position by dividing A4 size paper into four blocks.
RIGHT UPPER	:	Selects the plot scale to output data to upper right position by dividing A4 size paper into four blocks.
RIGHT LOWER	:	Selects the plot scale to output data to lower right position by dividing A4 size paper into four blocks.

(Hard copy example)

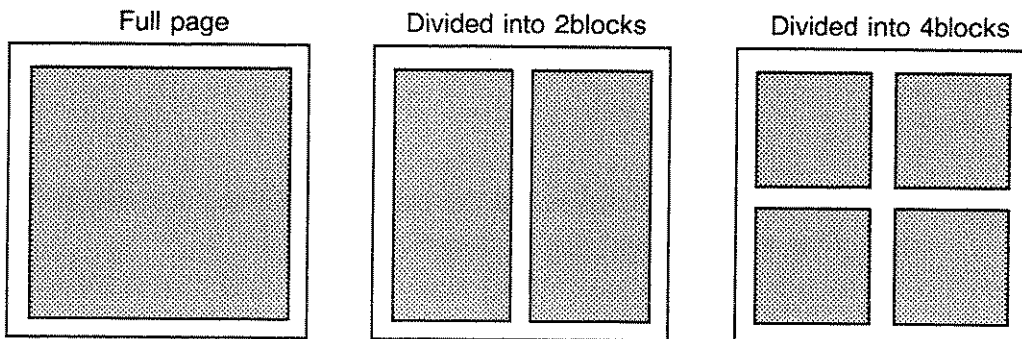

### 4.11.2 Selecting Plot Data

Selects items to be hard-copied.

Since the items to be set in this menu are interlocking to the channels, they are set to the active channel only.

Operation procedure

- ① Press the COPY to call the copy menu.
- ② Press the DEFINE  
PLOT to call the plot data menu.
- ③ Plot data menu

- |                             |   |   |
|-----------------------------|---|---|
| PLOT<br>DATA<br>ON/OFF      | : | Sets ON/OFF of the measurement data output. |
| PLOT<br>MEMORY<br>ON/OFF    | : | Sets ON/OFF of the memory data output.      |
| PLOT<br>GRATICULE<br>ON/OFF | : | Sets ON/OFF of the coordinate output.       |
| PLOT<br>TEXT<br>ON/OFF      | : | Sets ON/OFF of the text data output.        |
| PLOT<br>MARKER<br>ON/OFF    | : | Sets ON/OFF of the marker data output.      |
| PLOT<br>REF LINE<br>ON/OFF  | : | Sets ON/OFF of the reference line output.   |





Note: When both the text data output and the marker data output are set to ON, the output of the marker list and filter analysis result is also set.



### 4.11.3 Specifying Pen

Selects the pen number and line type to be used.

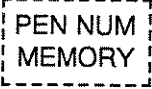
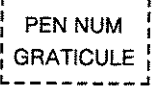
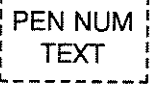
Operation procedure

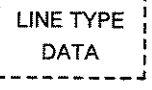
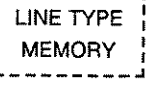
- ① Press the  to call the copy menu.
- ② Press the  to call the plotter pen menu.
- ③ Plotter pen menu
  -  : Specifies the pen number of the measurement data.
  -  : Specifies the pen number of the memory data.
  -  : Specifies the pen number of the coordinate data.
  -  : Specifies the pen number of the text data.
  -  : Specifies the pen number of the marker data.
  -  : Selects the line type of the measurement data.
  -  : Selects the line type of the memory data.

The selection of the line type is as follows.

- 0: Solid line
- 1: Dotted line
- 2: Dashed line
- 3: Chain line

### 4.11.4 Plotter Setup

Selects the pen number and line type to be used.

Operation procedure

- ① Press the COPY to call the copy menu.
- ② Press the PRINT/PLOT  
SETUPS to call the setup menu.
- ③ Setup menu

PLOT LABEL ON/OFF	:	Selects ON/OFF of the label and real-time clock output.
PLOT P. TXT ON/OFF	:	Sets ON/OFF of output of the characters which have been written on the screen using the controller function.
DEFAULT SETUPS	:	Returns all the copy menu to the initial settings.
PLOTTER HP/AT	:	Selects the HP or AT plotter.

(Note) In using the plotter of HP company, the indication of the error such as error lamp lighting will be occasionally done.

- ④ Setting R9833 DIP switches  
 The DIP switches should be set to the standard values as shown in Figure 4-5. These switched are used to set the initial conditions at powering on and the interface conditions.

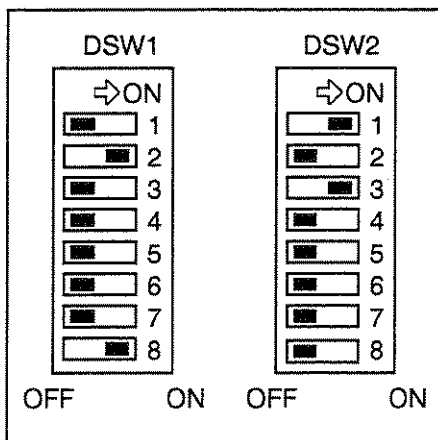

DSW1: HP mode when SW No.8 is ON.  
 GP-GL mode when SW No.8 is OFF.  
 (In AT mode, it is required to set OFF SW No.8 and ON SW No.4.) (See Table 4-1)

DSW2: Sets the plotter address to 5.  
 (See Table 4-2)

Figure 4-5 Setting DIP Switches

**R3753 SERIES  
NETWORK ANALYZER  
OPERATION MANUAL**

4.11 *Hard Copy*

Table 4-1 DSW1 Function

SW No.	Functions (ON = 1)	Standards																				
1 to 3	Paper size setting (SW3 = 0) (SW3 = 1)	SW1 = 0 SW2 = 1 SW3 = 0  A4 long side way																				
	<table border="1" style="width: 100%; border-collapse: collapse;"> <thead> <tr> <th style="width: 5%;">SW1</th> <th style="width: 5%;">SW2</th> <th style="width: 45%;">ISO/JIS</th> <th style="width: 45%;">ANSI</th> </tr> </thead> <tbody> <tr> <td style="text-align: center;">0</td> <td style="text-align: center;">0</td> <td>A3 maximum width and depth</td> <td>B maximum width and depth</td> </tr> <tr> <td style="text-align: center;">1</td> <td style="text-align: center;">0</td> <td>A3 long vertical way direction filling up</td> <td>B long vertical way direction filling up</td> </tr> <tr> <td style="text-align: center;">0</td> <td style="text-align: center;">1</td> <td>A4 long side way direction filling up</td> <td>A long side way direction filling up</td> </tr> <tr> <td style="text-align: center;">1</td> <td style="text-align: center;">1</td> <td>A4 long vertical way direction filling up</td> <td>A long vertical way direction filling up</td> </tr> </tbody> </table>		SW1	SW2	ISO/JIS	ANSI	0	0	A3 maximum width and depth	B maximum width and depth	1	0	A3 long vertical way direction filling up	B long vertical way direction filling up	0	1	A4 long side way direction filling up	A long side way direction filling up	1	1	A4 long vertical way direction filling up	A long vertical way direction filling up
	SW1		SW2	ISO/JIS	ANSI																	
	0		0	A3 maximum width and depth	B maximum width and depth																	
	1		0	A3 long vertical way direction filling up	B long vertical way direction filling up																	
0	1	A4 long side way direction filling up	A long side way direction filling up																			
1	1	A4 long vertical way direction filling up	A long vertical way direction filling up																			
4	Setting rotational coordinates 1: rotational coordinates ON	0																				
5	Selection of unit length for step number 0: normal 1: switch	0																				
6	Paper detection disable 0: with paper detection function 1: not with paper detection function	0																				
7	Switching input buffer capacity 1: maximum (12KB) 0: 1KB	0																				
8	FP-GL-I/FP-GL-II select 1:FP-GL-I 0:FP-GL-II	1																				

Table 4-2 DSW2 Function

SW No.	Functions (ON = 1)	Standards			
1 to 5	Setting plotter address defines the device address with all bits.	SW1 = 1 SW2 = 1 SW3 = 1 SW4 = 1 SW5 = 1			
	Bit structure <table border="1" style="display: inline-table; margin-left: 20px;"> <tr> <td style="width: 20px; text-align: center;">SW5</td> <td style="width: 20px; text-align: center;">SW4</td> <td style="width: 20px; text-align: center;">SW3</td> <td style="width: 20px; text-align: center;">SW2</td> <td style="width: 20px; text-align: center;">SW1</td> </tr> </table> Address 31 is for listen only mode.		SW5	SW4	SW3
SW5	SW4	SW3	SW2	SW1	
6	Selection of EOI signal control 0: EOI disabled 1: EOI enabled However, available only when using FP-GL-II. Not defined for FP-GL-I.	0			
7	Not defined	0			
8	Selection of reduced drawing mode (only when using FP-GL-II). 1: Selects reduced drawing mode (0.9 time)	0			

**R3753 SERIES  
NETWORK ANALYZER  
OPERATION MANUAL**

---

**4.11 Hard Copy**

If EOI signal is set to ON (enable) and EOI terminal receives "L" when using FP-GL-II, the plotter operates in the same manner as the terminator.

When the plotter sends data, EOI terminal is set to "L" at the same time as it outputs the last "LF" code of sending data.

If the reduced drawing mode is selected when using FP-GL-II, the plotter outputs the drawing being reduced to 0.9 time, based on the global origin. Then, the actual size of the valid drawing range is not changed and the range to be specified by the program is extended.

## 4.12 Communication with Peripheral Devices

As standard, the analyzer is equipped with the parallel I/O interface and RS-232 interface as well as the GPIB interface. With these interfaces, it can communicate with peripherals.

- Parallel I/O: Used for communication with peripheral devices such as the handler.  
(See subsection 4.12.1.)
- RS-232: Used for data communication with the host CPU or data transfer of pattern program. (See subsection 4.12.2.)

### 4.12.1 Parallel I/O Port

#### (1) Outline

The parallel I/O port is the input/output port to communicate with the handler or peripherals. Use always the shield cable for the condition.

The parallel I/O connector on the back panel is used for communication. Figure 4-7 shows the internal pin assignment and signals of the connector. These I/O port is controlled with ENTER and OUTPUT commands.

- Input/output port  
There are two output ports and two input/output ports, as follows:
  - Port only for output: A port: 8-bit width  
B port: 8-bit width
  - Input/output port: C port: 4-bit width  
D port: 4-bit width
- Port C status output, port D status output  
Shows the settings of the input of the input/output ports C and D. It is low when C or D port is set to input, it is high when it is set to output
- Write strobe output for output port  
By generating a negative pulse on the write strobe output, it shows which output port is used for data output.

Figure below shows the timing chart of the write strobe output and data output.

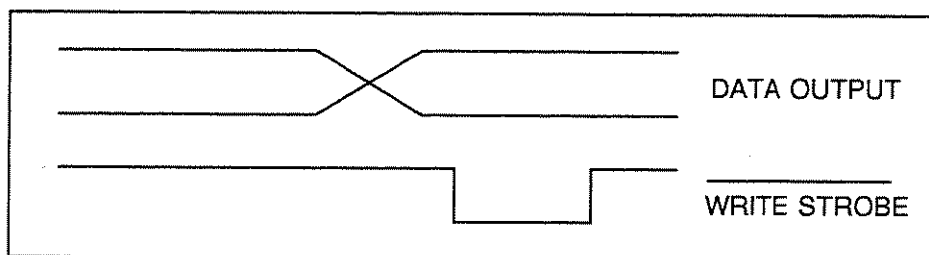
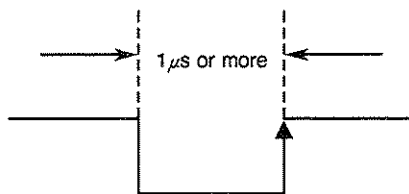

Figure 4-6 Timing Chart of WRITE STROBE

- INPUT 1  
By entering a negative pulse on the INPUT 1, the outputs 1 and 2 are set to LOW. The pulse width of the input signal to be entered in the INPUT 1 should be more than  $1\mu\text{s}$ .
- OUTPUT 1 and 2  
These two signal lines are the latch output terminals set to LOW when a negative pulse is entered on the INPUT 1. It can be set to LOW or HIGH with the BASIC command (OUTPUT).
- PASS/FAIL output  
Generates LOW when the result of the limit test is PASS and HIGH when the result is FAIL. This function is available only when the limit test function is ON.
- Write strobe output for PASS/FAIL output  
When the limit test result is output to the PASS/FAIL output line, generates a negative pulse.
- SWEEP END  
When the analyzer finishes the sweeping, generates a negative pulse with a width of  $10\mu\text{s}$ .
- +5V output  
+5 V output is provided for the external device. The maximum current to be supplied is 100mA. This line has a fuse which will be blown when overcurrent flows for circuit protection. The blown fuse needs to be replaced.
- EXT TRIG input  
By entering a negative pulse on this line, it is possible to trigger the sweeping measurement. The pulse width should be at least  $1\mu\text{s}$ . The sweeping starts at the rising edge of the pulse. When this signal line is used, the trigger mode should be set external source.



**R3753 SERIES  
NETWORK ANALYZER  
OPERATION MANUAL**

**4.12 Communication with Peripheral Devices**

(2) Connector Internal Pin Assigned and Signal Standard

Pin No.	Signal name	Function
1	GND	Ground
2	INPUT 1	Negative logic pulse input of TTL level (width: 1 $\mu$ s or more)
3	OUTPUT 1	Negative logic latch output of TTL level
4	OUTPUT 2	Negative logic latch output of TTL level
5	Output port A0	Negative logic latch output of TTL level
6	Output port A1	Negative logic latch output of TTL level
7	Output port A2	Negative logic latch output of TTL level
8	Output port A3	Negative logic latch output of TTL level
9	Output port A4	Negative logic latch output of TTL level
10	Output port A5	Negative logic latch output of TTL level
11	Output port A6	Negative logic latch output of TTL level
12	Output port A7	Negative logic latch output of TTL level
13	Output port B0	Negative logic latch output of TTL level
14	Output port B1	Negative logic latch output of TTL level
15	Output port B2	Negative logic latch output of TTL level
16	Output port B3	Negative logic latch output of TTL level
17	Output port B4	Negative logic latch output of TTL level
18	EXT TRIG	EXTERNAL TRIGGER input (width: 1 $\mu$ s or more),negative logic
19	Output port B5	Negative logic latch output of TTL level
20	Output port B6	Negative logic latch output of TTL level
21	Output port B7	Negative logic latch output of TTL level
22	Input/output port C0	Negative logic state input/latch output of TTL level
23	Input/output port C1	Negative logic state input/latch output of TTL level
24	Input/output port C2	Negative logic state input/latch output of TTL level
25	Input/output port C3	Negative logic state input/latch output of TTL level
26	Input/output port D0	Negative logic state input/latch output of TTL level
27	Input/output port D1	Negative logic state input/latch output of TTL level
28	Input/output port D2	Negative logic state input/latch output of TTL level
29	Input/output port D3	Negative logic state input/latch output of TTL level
30	Port C status	TTL level, Input mode: LOW, Output mode: HIGH
31	Port D status	TTL level, Input mode: LOW, Output mode: HIGH
32	Write strobe signal	TTL level, Negative logic, Pulse output
33	PASS/FAIL signal	TTL level, PASS: LOW, FAIL: HIGH, latch output
34	SWEEP END signal	TTL level, Negative logic, Pulse output (width: 10 $\mu$ s or more)
35	+5V	+5V $\pm$ 10% 100mA MAX
36	Write strobe signal (PASS/FAIL)	TTL level, Negative logic, Pulse output

Figure 4-7 36-pin Connector Internal Pin Assignment and Signal

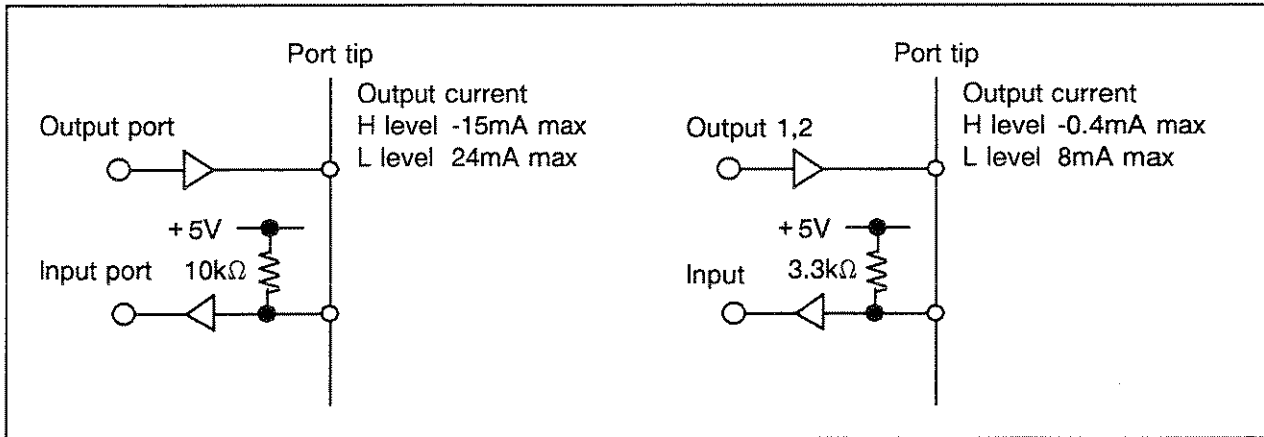

(3) Mode setting of port

Command	Output port	Input port
OUTPUT 36 ;16	A, B, C, D	
OUTPUT 36 ;17	A, B, D	C
OUTPUT 36 ;18	A, B, C	D
OUTPUT 36 ;19	A, B	CD

To use a parallel I/O port, first set the mode setting of port. The combination of the setting command and the input port is referred the above table.

Example

```
10 OUTPUT 36;19
20 OUTPUT 33;255
30 ENTER 37;A
:
```

Set the output port for port A and port B, and the input port for port CD.

(4) Each port operation method

Describes the operation method by built-in BASIC.

OUTPUT statement (for output) and ENTER statement (for input) are used for data input/output.

In the BASIC command (OUTPUT and ENTER statements), each port is distinguished by the address used in the statement.



① BASIC format

OUTPUT (address); (output data)

ENTER (address); [variable]

(Input data are assigned to specified variable.)

② Address and data range

Address	Port to be used
33	Port A (Output only: OUTPUT statement only)
34	Port B (Output only: OUTPUT statement only)
35	Port C (Input/output: ENTER, OUTPUT)
36	Port D (Input/output: ENTER, OUTPUT)
37	Port CD (Input/output: ENTER, OUTPUT)

● OUTPUT 33, 34, 37

OUTPUT x x ; 0 to 255 (8bit)

● OUTPUT 35, 36

OUTPUT x x ; 0 to 15 (4bit)

Note: The OUTPUT 35 concerns with the Set/Reset of Flip Flop.

● ENTER 35, 36

ENTER x x ; numeric variable (4bit) (Data from 0 to 15 are assigned.)

● ENTER 37

ENTER 37 ; numeric variable (8bit) (Data from 0 to 255 are assigned.)

(5) INPUT 1, OUTPUT 1, and OUTPUT 2 Terminals

By combining with the signal lines of INPUT 1, OUTPUT 1, and OUTPUT 2, convenient functions are provided to easily control external devices.

The functions are; function which sets two latch outputs to LOW by pulse input to INPUT 1, and function which detects the state of variable OUTPUT 1 by INPUT 1. Also, the state of OUTPUTs 1 and 2 can be controlled by OUTPUT command.

(a) Setting OUTPUT 1 and OUTPUT 2, and Reset

The following four types are provided for set/reset as follows:

●Setting OUTPUT 1: OUTPUT 35 ; 16

●Setting OUTPUT 2: OUTPUT 35 ; 48

●Resetting OUTPUT 1: OUTPUT 35 ; 80

●Resetting OUTPUT 2: OUTPUT 35 ; 112

(b) INPUT 1 (external input)

The state of variable OUTPUT 1 by INPUT 1 can be observed by ENTER statement.

ENTER 34; (numeric variable)

If the numeric variable is set to 1, OUTPUT 1 will become ON (Low level: negative logic), if 0, the result will become OFF (High level).

```
Example  10 OUTPUT 36 ; 16  
         20 ENTER 34 ; A  
         30 IF A < > 1 THEN GOTO 20  
         40 OUTPUT 33 ; 1  
         :
```

By observing the state of OUTPUT 1, if OUTPUT 1 is set to ON, then 1 is output to the port A.

① Examples of INPUT 1, OUTPUT 1, and OUTPUT 2

When program is executed by trigger switch:

● Circuit example

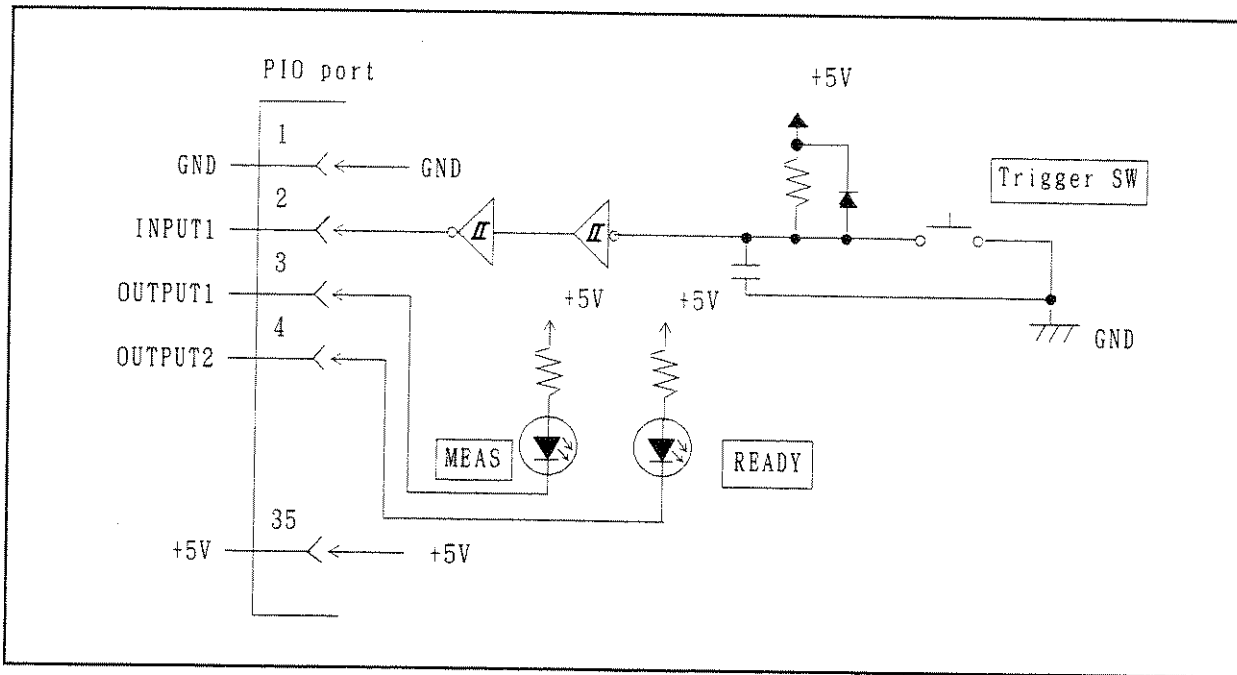

● Program example

	Waiting time for measurement: Represents	<b>READY</b>
	During measurement operation: Represents	<b>MEAS</b>
10	OUTPUT 35 ; 80	
20	OUTPUT 35 ; 112 )	<b>READY</b> <b>MEAS</b> turns OFF.
:	:	Network analyzer initial setup
:	:	
100	OUTPUT 35 ; 48	<b>READY</b> turns ON.
110	ENTER 34 ; A	
120	IF A <> 1 THEN GOTO 110 )	Recognition of Trigger SW
130	OUTPUT 35 ; 112	<b>READY</b> turns OFF.
:	:	
:	:	Measurement routine
500	OUTPUT 35 ; 80	<b>MEAS</b> turns OFF.
510	GOTO 100	When repeating the measurement
520	STOP	

② Usage example of output ports A and B

When LED is used for selecting devices (when port A is used):

● Circuit example

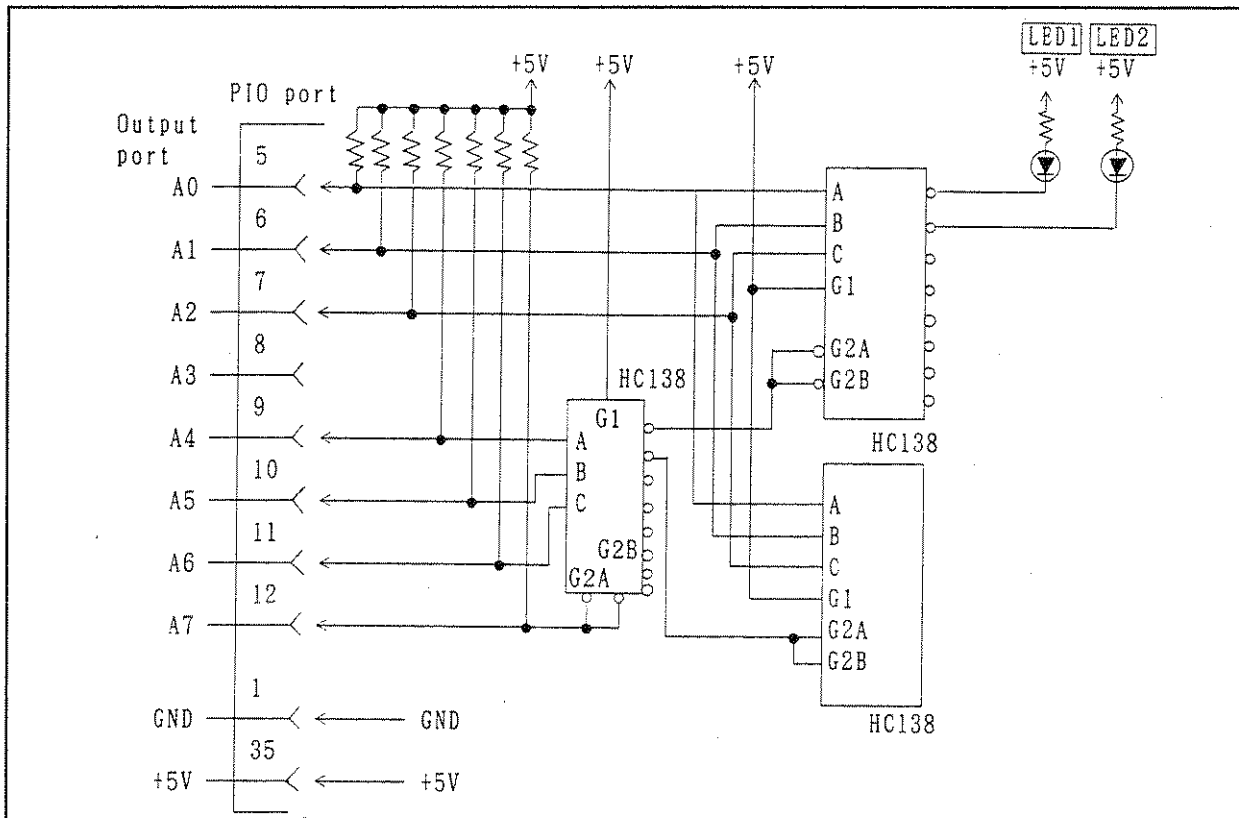

● Program example

```

10  OUTPUT 36 ; 16      Defines ports A, B, C, and D as output port.
20  OUTPUT 33 ; 0      Initializes LED.
30
:
:      Measurement and judgment
:      measurement variable: A
:      ( judgment range: JED0 to JED1, JED1 to JED2.. )
500 IF A >= JED0 AND A < JED1 THEN OUTPUT 33 ; 0xFF
      (when JED0 to JED1, lights up LED 1.)
510 IF A >= JED1 AND A < JED2 THEN OUTPUT 33 ; 0xFF
      (when JED1 to JED2, lights up LED 2.)
:
800 GOTO 30
810 STOP
    
```

③ Usage example of input ports C and D

Example to change routine whether bit 0 of I/O port C is 0 or 1

● Circuit example

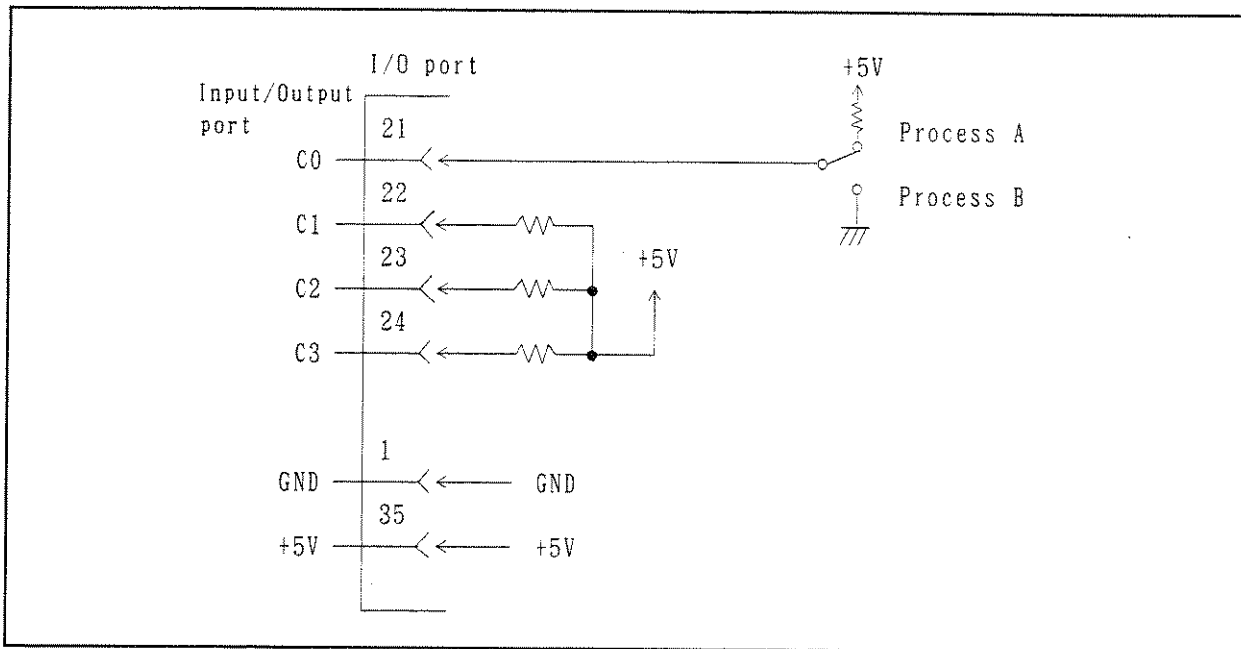

● Program example (Check the port C by pressing Trigger SW in example ①.)

```

10  OUTPUT 36 ; 19           Defines ports A and B as output port.
20  OUTPUT 35 ; 80          Defines ports C and D as input port.
30  OUTPUT 35 ; 112
   :
100 *TRIG                   Network analyzer initial setup
110 ENTER 34 ; A
120 IF A > 1 THEN GOTO *TRIG
130 ENTER 35 ; B            Obtains value of port C.
140 IF B = 1 THEN GOTO *ROUT.B
150 *ROUT.A
   :                       Process A
490 GOTO *TRIG
500 *ROUT.B
   :                       Process B
900 GOTO *TRIG
910 STOP
    
```

### 4.12.2 RS-232

The analyzer is equipped with an RS-232 interface as a standard. Therefore, data such as a communication with host CPU or pattern program can be output to an RS-232 printer.

The RS-232 interface defines data terminal standardized by Electronic Industries Association (EIA) and mechanical and electrical characteristics of interface for connecting between data communication devices.

(1) Connection connector and signal table

Connection connector : 25-pin D-sub connector (male type)

Signal table

Pin No.	Signal name	Description
1	FG	Ground for security
2	TxD	Sending data
3	RxD	Receiving data
4	RTS	Sending request
5	CTS	Can be sending
6	DSR	Data set ready
7	SG	Signal ground
20	DTR	Data terminal ready

Signals TxD, RTS, and DTR are transferred with SN75188N (power:  $\pm 12V$ ).

Signals RxD, CTS, and DSR are received with SN75189AN.

(2) Printer output method

The LLIST or LPRINT instruction is used to output to the RS-232 printer of the analyzer.

The setting such as a baud rate is defined by the CONTROL statement.

LLIST: Outputs BASIC program to the printer.

LPRINT: Outputs the contents of character strings, numeric values, and variables.

CONTROL: Sets the values such as a baud rate, character length, and others.

Recommended devices:

- Printer: FP-80 and equivalents  
Manufactured by EPSON Co, Ltd.
- Interface: 8148 (intelligent serial interface)  
Manufactured by EPSON Co, Ltd.

## 5. PERFORMANCE TEST

### 5.1 Preparing for Performance Test

(1) Warm up

Warm up the analyzer for at least 30 minutes (pre-heating). Also, warm up each calibration standards as well.

(2) Preparing measurement instrument

The following measurement instruments are required referring to the test items listed in Table 5-1.

Table 5-1 Required Measurement Instrument for Calibration

Test items	Measurement Instrument		Remarks
1. Frequency accuracy and range	<ul style="list-style-type: none"> <li>● Counter Frequency 5Hz to 500MHz Display 7 digits or more Accuracy 0.1ppm or less</li> </ul>	R5372 (to 18GHz) or R5373 (to 26GHz) (Manufactured by ADVANTEST)	Section 5.2
	<ul style="list-style-type: none"> <li>● BNC-BNC cable</li> </ul>		
2. Output/input level and flatness	<ul style="list-style-type: none"> <li>● Power meter Frequency 100kHz to 500MHz Power range -63dBm to +23dBm</li> </ul>	HP436A HP437B HP438A (Calibrated under the national standard)	Section 5.3
	<ul style="list-style-type: none"> <li>● Power sensor Frequency 100kHz to 500MHz Power range -63dBm to +21dBm</li> </ul>	HP8482A	
3. Output level linearity	<ul style="list-style-type: none"> <li>● Power meter Frequency 100kHz to 500MHz Power range -63dBm to +21dBm</li> </ul>	HP436A HP437B HP438A (Calibrated under the national standard)	Section 5.4
	<ul style="list-style-type: none"> <li>● Power sensor Frequency 100kHz to 500MHz Power range -63dBm to +21dBm</li> </ul>	HP8482A	

(3) General note

- Use an AC power source having a voltage of 100V-120V, 220V-240V and a frequency of 48Hz to 66Hz.
- When connecting the power supply cable, OFF the POWER switch.
- The analyzer must be calibrated under the following conditions:
  - Temperature : +5°C to +40°C (when floppy disk is used)
  - : 0°C to +50°C (when floppy disk is not used)
  - Humidity: 85% RH or less
  - Free from dust, vibration, and noise.



## 5.2 Frequency Accuracy and Range

Operation procedure

- ① Setup the analyzer as follows:

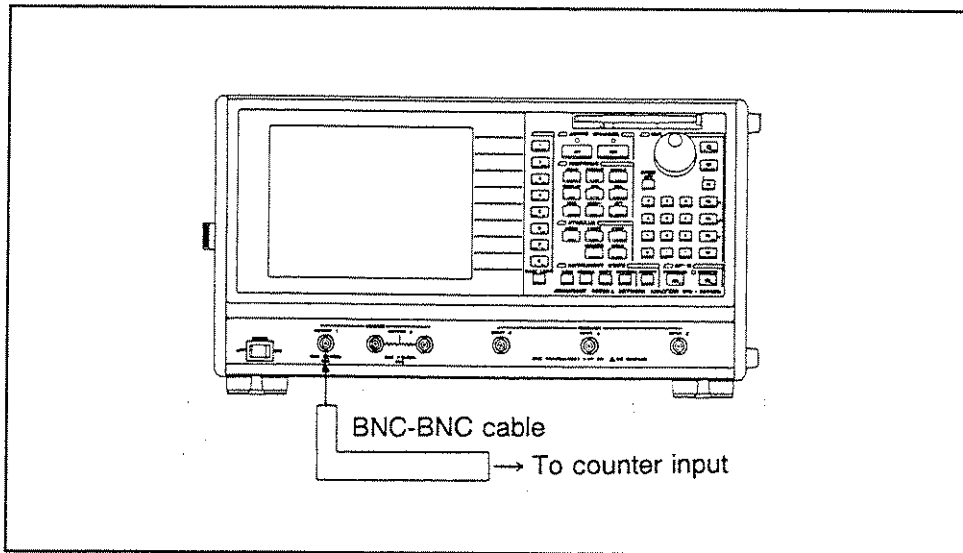

Figure 5-1 Frequency Accuracy and Range

- ② Set the analyzer as follows:

Span: 0Hz

Sweep mode: SINGLE

- ③ Change any center frequency in the range of 5Hz to 500MHz.

- ④ Check: Counter read frequency  $<$  center frequency  $\pm$  center frequency  $\times 20 \times 10^{-6}$

(Example)

When the center frequency is 10MHz: 10MHz  $\pm$  200Hz

That is, 9,999,800Hz to 10,000, 200Hz is enable.

## 5.3 Output Level Accuracy and Flatness

### Operation procedure

- (1) Set up the analyzer as follows:

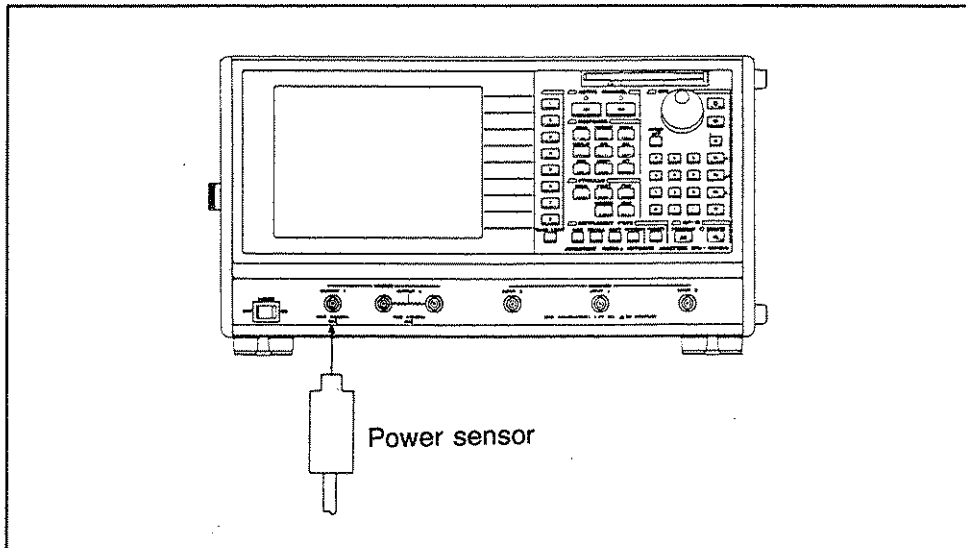

Figure 5-2 Output Level Accuracy and Flatness

- (2) Output level accuracy

- ① Calibrate the power meter to zero.
- ② Set analyzer as follows.  
Center frequency: 50MHz  
Span: 0Hz  
Output level: 0dBm
- ③ Connect the power sensor to the output terminal and perform the measurement.  
Note: The calibration factor is set to 50MHz.
- ④ Check: Output level accuracy (at 0dBm and 50MHz)  $\pm 0.5$ dB

(3) Flatness

- ① Calibrate the power meter to zero.
- ② Set the analyzer as follows:  
Center frequency: 50MHz  
Span: 0Hz  
Output level: 0dBm
- ③ Press the REL of the power meter and set to 0dB (ratio test mode).
- ④ The span and output level are fixed. Change the center frequency and obtain data from the power meter.

Note: Use the calibration factor at the center frequency.

⑤ Check: Flatness (at 0dBm)	5Hz to 100kHz	± 4.0dB
	100kHz to 1MHz	± 2.0dB
	1MHz to 300MHz	± 1.5dB
	300MHz to 500MHz	± 2.0dB

## 5.4 Output Level Linearity

Operation procedure

- ① Calibrate the power meter to zero.
- ② Set analyzer as follows.  
Center frequency: 50MHz  
Span: 0Hz  
Output level: 0dBm
- ③ Connect the power sensor to the output terminal and perform the measurement.

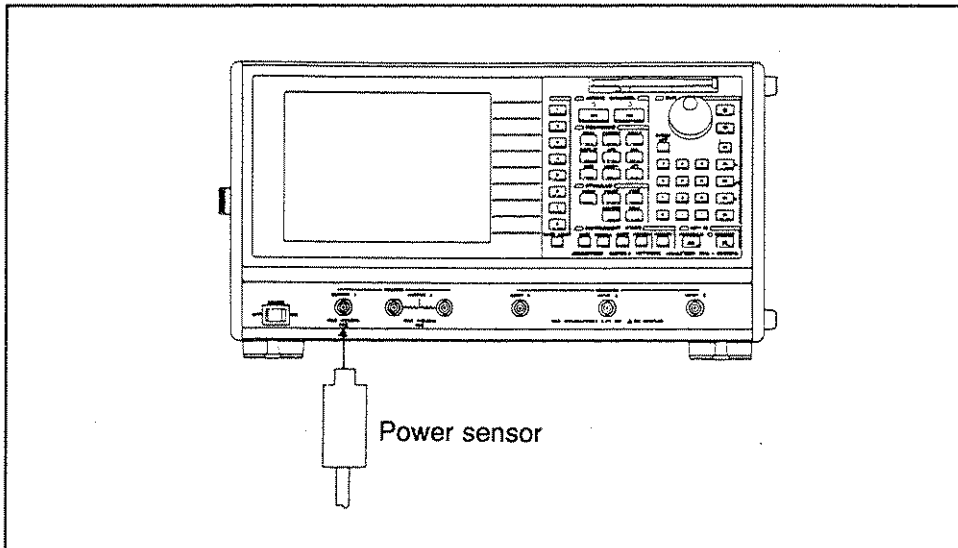

Figure 5-3 Output Level Linearity

- ④ Press the **REL** and set to 0dB (ratio test mode)
- ⑤ When changing the output level, obtain linearity data.  
Note: The calibration factor is set to 50MHz.

⑥ Check:	(Reference 0dBm)	
	+21dBm to -35dBm	± 0.5dB
	-35dBm to -63dBm	± 1.5dB

## 6. SPECIFICATIONS

Note: Unless otherwise described, these specifications are guaranteed in the temperature range of 25°C ± 5°C.

### (1) Measure function

Amplitude ratio	A/R, B/R, A/B (dB, linear ratio)	R3753A
Phase	A/R	R3753B
Group delay time	$\theta$ (deg)	
Absolute amplitude	$\tau$	
	R, A, B (V, dBm)	R3753A
	R, A	R3753B
	A	R3753E

### (2) Signal source section

Frequency	
Range	5Hz to 500MHz
Resolution	0.1Hz
stability	$\pm 5 \times 10^{-6}$ /Day
Accuracy	$\pm 20$ ppm
Output level	
Range	+21.0dBm to -63.0dBm (Output port 1)
Resolution	0.1dB
Accuracy	$\pm 0.5$ dB (0dBm, 50MHz)
Linearity	+21dBm to -35dBm $\pm 0.5$ dB -35dBm to -63dBm $\pm 1.5$ dB
Flatness	5Hz to 1MHz $\pm 2.0$ dB (0dBm output) 1MHz to 300MHz $\pm 1.5$ dB 300MHz to 500MHz $\pm 2.0$ dB
Output Impedance	50 $\Omega$ Return loss: 13dB or more (Typ) (0dBm output)
Signal purity	
Harmonic distortion	$\leq -20$ dBc
Non harmonic spurious	Larger one either $< -30$ dBc or $-70$ dBm
Phase noise	$< -75$ dBc/Hz (10kHz offset)

**R3753 SERIES  
NETWORK ANALYZER  
OPERATION MANUAL**

**6. SPECIFICATIONS**

<p>Sweep function</p> <p>Sweep parameter</p> <p>Maximum sweep range</p> <p>Range setting</p> <p>Sweep type</p> <p>Sweep trigger</p> <p>Sweep mode</p> <p>Sweep speed</p> <p>Measuring point</p>	<p>Frequency, Signal level</p> <p>Frequency: 5Hz to 500MHz</p> <p>Signal level: -43dBm to +21dBm</p> <p>Start/Stop or Center/Span</p> <p>Linear, Logarithm, program sweep</p> <p>Repeat, Single, EXT</p> <p>2ch simultaneous sweep, alternate sweep</p> <p>0.1ms/point (RBW 10kHz)</p> <p>3, 6, 11, 21, 51, 101, 201, 301, 401, 601, 801, 1201 point</p>
<p>Output format</p> <p>Output</p> <p>Connector</p> <p>Internal power splitter</p> <p>Insertion loss (Typ)</p> <p>Output tracking (Typ)</p> <p>5Hz to 100MHz</p> <p>100MHz to 500MHz</p> <p>Equivalent output SWR (Typ)</p>	<p>Single, Dual R3753A/B</p> <p>Single R3753E</p> <p>(Internal splitter is used for Dual.)</p> <p>50Ω, BNC</p> <p>6dB</p> <p>&lt; 0.1dB, &lt; 1° R3753A/B only</p> <p>&lt; 0.2dB, &lt; 1°</p> <p>&lt; 100MHz, 1. 2</p> <p>≥ 100MHz, 1. 4</p>

(3) Analysis section

<p>Input characteristic</p> <p>Input terminal</p> <p>Input impedance</p> <p>Return loss</p> <p>Connector</p>	<p>3-channel (Rch, Ach, Bch) R3753A</p> <p>2-channel (Rch, Ach) R3753B</p> <p>1-channel (Ach) R3753E</p> <p>50Ω, 1MΩ/20pF or less</p> <p>5Hz to 300MHz: 20dB or more (ATT 0dB)</p> <p>23dB or more (ATT 20dB)</p> <p>300MHz to 500MHz: 15dB or more (ATT 0dB)</p> <p>20dB or more (ATT 20dB)</p> <p>50Ω, BNC</p>
--	--



**R3753 SERIES  
NETWORK ANALYZER  
OPERATION MANUAL**

**6. SPECIFICATIONS**

<p>Amplitude characteristic</p> <p>Measurement range (RBW 1kHz)</p> <p>Absolute amplitude</p> <p>Amplitude ratio</p> <p>Amplitude resolution</p> <p>Frequency response</p> <p>Absolute value measurement(R, A, B)</p> <p>Ratio measurement (A/R, B/R, A/B) (when attenuation value is the same)</p> <p>Dynamic accuracy</p>	<p>Attenuator AUTO, 0dBm to -120dBm</p> <p>Attenuator 0dB, -20dBm to -120dBm</p> <p>Attenuator 20dB, 0dBm to -100dBm</p> <p>0 ± 120dB</p> <p>0.001dB</p> <p>50Ω input: 2dBp-p (5Hz to 300MHz) 3dBp-p (300MHz to 500MHz)</p> <p>1MΩ input: 10dBp-p (5Hz to 1kHz) 1.5dBp-p (1kHz to 100MHz)</p> <p>50Ω input: 1.0dBp-p (5Hz to 100MHz) 2.0dBp-p (100MHz to 300MHz) 3.0dBp-p (300MHz to 500MHz)</p> <p>1MΩ input 5dBp-p (5Hz to 1kHz) 1.5dBp-p (1kHz to 100MHz)</p> <p>0dB to -10dB ± 0.10dB</p> <p>-10dB to -50dB ± 0.05dB</p> <p>-50dB to -60dB ± 0.05dB</p> <p>-60dB to -70dB ± 0.10dB</p> <p>-70dB to -80dB ± 0.30dB</p> <p>-80dB to -90dB ± 0.90dB</p>
<p>Phase characteristic</p> <p>Ratio measurement</p> <p>Measurement range</p> <p>Phase resolution</p> <p>Frequency response (when attenuation value is the same)</p> <p>Dynamic accuracy</p>	<p>(A/R, B/R, and A/B) are available</p> <p>± 180°</p> <p>(Long display function enables continuous display.)</p> <p>0.01°</p> <p>50Ω input: 5°p-p (5Hz to 100MHz) 15°p-p (100MHz to 300MHz) 20°p-p (300MHz to 500MHz)</p> <p>1MΩ input 20°p-p (5Hz to 1kHz) 10°p-p (1kHz to 100MHz)</p> <p>0dB to -10dB ± 1.0°</p> <p>-10dB to -50dB ± 0.3°</p> <p>-50dB to -60dB ± 0.5°</p> <p>-60dB to -70dB ± 1.0°</p> <p>-70dB to -80dB ± 3.0°</p> <p>-80dB to -90dB ± 8.0°</p>



<p>Group delay time characteristic (Linear frequency sweep, When the ratio measurement, When the 50Ω input is available)</p>	<p>Solve expression</p> $\tau = \frac{\Delta\phi}{360 \times \Delta f}$ <p style="text-align: right;">Δφ: Phase Δf: Aperture frequency (Hz)</p>
<p>Measurement range</p> <p>Group delay time resolution</p> <p>Aperture frequency</p> <p>Accuracy</p>	<p>1ps to 250s</p> <p>1ps</p> <p>0.01% to 50% of the frequency span (equivalents to Δf)</p> <hr style="width: 50%; margin-left: auto; margin-right: auto;"/> <p style="text-align: center;">Phase accuracy</p> <hr style="width: 50%; margin-left: auto; margin-right: auto;"/> <p style="text-align: center;">360 × Aperture frequency (Hz)</p>

(4) Specification of display

<p>Display section</p> <p>TFT color liquid crystal display</p> <p>Resolution</p> <p>Display mode</p>	<p>7.8-inch</p> <p>640 × 480 dots</p> <p>Character, Graphic display</p>
--	---

(5) Others function

<p>System function</p>	
<p>Error calibration function</p> <p>    Normalize</p> <p>    One port calibration</p> <p>    Two port calibration</p>	<p>Corrects the frequency response (Both amplitude and phase) for transmission and reflection measurement.</p> <p>Corrects the bridge directivity, frequency response, and source match for reflection measurement. Requires short, open, and load standards.</p> <p>Corrects the directivity, source match, load match, frequency response and isolation for the two port device measurement.</p> <p>Requires short, open, and load standards.</p>

**R3753 SERIES  
NETWORK ANALYZER  
OPERATION MANUAL**

**6. SPECIFICATIONS**

System function	
Data averaging	Data (vector value) is averaged every sweep.
Data smoothing	An averaging factor can be set, ranging from 2 to 999. Performs moving averaging between adjacent measurement points.
External equipment	
External monitor output	VGA conforms
GPIB	Supports common commands complied with IEEE standards 488.2. Enables to correspond with SCPI.
24bits input/output	TTL level
RS-232	Serial output conforms to RS-232.
Programming function	
Internal BASIC controller function	Standard equipped Includes Built-in function

(6) General specification

External trigger	PIO 18pin, TTL level, LOW enable
External reference frequency input	Frequency: 1, 2, 5, 10MHz Connector: BNC Input level range: 0dBm to 20dBm
Operating environment	+5°C to 40°C, RH85% or less (when floppy disk used.) 0°C to 50°C, RH85% or less (when floppy disk not used.)
Storage temperature range	-20°C to 60°C
Power source	AC100V to 120V } (Automatic switching) AC220V to 240V } 48Hz to 66Hz 300VA or less
Outside dimension	About 424 (W) × 220 (H) × 400 (D) mm
Dimensions	About 15kg or less

(7) The calibration period: 1 year.

It is necessary to execute the calibration every 1 year period for the guarantee to the measurement accuracy of R3753.

Regarding to the calibration service, contact the dealer or the nearest sales branch.

## 7. ERROR MESSAGES

This chapter explains the error messages displayed on the screen.

Error messages are classified into the following groups.

- 7.1 Hardware trouble
- 7.2 Overloading an input part
- 7.3 Notice of hardware information
- 7.4 Operating error
- 7.5 Warning of the change of internal setting and the like
- 7.6 Notice of the completion of an operation, the operating state, and the like

These error message are displayed as following.

- Error messages are left displayed on the fixed position. In other words, the error message is displayed over the former message, and the latest message remains on the screen.
- The error message does not disappear until some panel key is pressed. However, the messages in section 7.1 and 7.2 disappear if the analyzer is returned to the correct state.
- The message of section of 7.4 to 7.6 are not displayed in GPIB operation (also including an internal BASIC operation).

Note: ▶marks explain supplemental remarks of error message list and problem-solving methods.

### 7.1 Hardware Trouble

LOCAL #1 Unlock.

LOCAL #2 Unlock.

LOCAL has been unlocked.

SYNTHE Unlock.

SYNTHE has been unlocked.

VCXO Unlock.

VCXO has been unlocked.

- ▶ If these error message appear, call the nearest dealer or sales-and-support office.

## 7.2 Overloading an Input Part

Ach Over load.

Bch Overload.

Rch Over load.

A signal exceeding a maximum permissible level has been input to the channel.

Ach Over load Trip.

Bch Overload Trip.

Rch Over load Trip.

A signal exceeding a maximum permissible level has been input to the displayed channel. Then a protection circuit has started.

- ▶ Check the input signal level. Then release the trip state by executing CLEAR-TRIP.

## 7.3 Notice of Hardware Information

External Standard In.

An external reference signal has been input.

External Trigger ignored.

An input external trigger was ignored. (That does not mean a prohibiting state.)

- ▶ An external trigger (PIO-18pin) has been input in a state of not waiting for the external trigger. The state of waiting for the external trigger is not under sweeping but in a state of initiating an external trigger source (that is, in a state that TRIGGER[CONT] or TRIGGER[SINGLE] on the panel).  
If next trigger pulse is input during a sweep in using an external trigger source, the above error occurs.  
Check the trigger setting and the specification of an external trigger signal.

## 7.4 Operating Error

### Already Memorized.

Memorizing calibration data which DONE operation was already executed was attempted.

- ▶ Clear the already- memorized calibration data with CLEAR-CAL-DATA.

### Calibration aborted.

Memorizing calibration data was aborted.

- ▶ While calibration data is being memorized, if the setting is changed, the calibration is aborted.  
Do not change the setting until the calibration is finished.

### Calibration data not found.

CORRECT ON was executed without memorized calibration data.

- ▶ Memorize the calibration data.

### Can't ...When CORRECT ON.

To Memorize calibration data or to execute CLEAR CAL DATA was attempted in the state of CORRECT ON.

- ▶ Choose CORRECT OFF.

### Can't ... When PROG-SWEEP.

To Specify the number of points or to clear segments was attempted in the state of CORRECT ON.

- ▶ Specify s sweep type other than PROGRAM SWEEP and USER SWEEP.

### Can't ... When USER-SWEEP.

To Set the number of points or to clear segments was attempted in the state of CORRECT ON.

- ▶ Specify a sweep type other than PROGRAM SWEEP and USER SWEEP.

Can't find plotter !!!

A plotter was not found in a plot output.

- ▶ The plotter is not connected or GPIB address of the plotter is not correct.

Data and Coef not matched.

To execute CORRECT ON was attempted under a condition differing from a measurement condition where correction data was obtained.

- ▶ Specify the same measurement condition where the correction data was obtained.

Data and Memory not matched.

A trace operation (DATA/MEM, etc.) or a memory waveform display (DISPLAY-MEMORY, DISPLAY DATA&MEM) was specified under a condition differing from a measurement condition where a memory waveform was obtained.

- ▶ Specify the measurement condition where the memory waveform was obtained.

Disk not found

Data in a floppy disk was not able to be read with the LOAD-MENU, STORE-FILE, or LOAD-FILE key in R3753 series.

- ▶ The floppy disk has some scratches or has not be formatted or inserted. Check the floppy disk.

Duplicate name

The same name that has already been edited or a reserved name is input with the SAVE, STORE-FILE, or EDIT NAME key in R3753 series.

- ▶ Input a different name.

File load error.

An error occurred in a LOAD-FILE execution.

- ▶ Something is wrong with the floppy disk, or a file other than files stored in the analyzer was specified. Check the floppy disk.

File store error

An error occurred in a STORE-FILE execution.

- ▶ The floppy disk has no available space, or the floppy disk is not formatted or is in a write-protect state. Check the floppy disk.

Formatting failure

Something was wrong in the formatting operation.

- ▶ The floppy disk has some scratches or is in a write-protect state. Check the floppy disk.

Illegal PROG-SWEEP points.

With the number of total points of all segments being less than 3 or more than 1201, the program sweep was specified.

- ▶ Specify the number of the segment point again.

Illegal USER-SWEEP points.

With the number of total points of all segments being less than 3 or more than 1201, the program sweep was specified.

- ▶ Specify the number of the segment point again.

Memory not found.

A trace operation (DATA/MEM, etc.) or a memory waveform display (DISPLAY-MEMORY, DISPLAY-DATA&MEM) was specified, with a memory waveform not stored.

- ▶ Obtain the memory waveform.

None Controller

A plot output was specified in a mode other than a system controller mode.

- ▶ Set to the system controller mode.

Now plotting !!!

Another plot output was specified in the course of executing a plot output.

- ▶ Until the current plot output is complete, the following plot can not be executed. Wait until the current plot output is completed.

Please set 1-trace FORMAT

With the measurement format two traces (LOGMAG&PHASE, LOGMAG&DELAY, LOGMAG&PHASE), the memory waveform display (DISPLAY-MEMORY, DISPLAY-DATA&MEM) was specified.

- ▶ The memory waveform display is invalid with the measurement format two traces.  
Set the measurement format to one trace (other than LOGMAG&PHASE, LOGMAG&DELAY, or LOGMAG&PHASE).

Register recall error.

An error occurred in recalling a register.

- ▶ A register that had not been saved was specified or the register was broken by some factor.  
Clear the register with CLEAR REG and save again.

Register save error.

An error occurred in saving a register.

- ▶ Available space is not in C: drive.  
Delete unwanted files.

Segment #x error.

The PROGRAM SWEEP or USER SWEEP was specified in a state that STOP FREQ of the Xth segment is higher than START FREQ of the following segment.

- ▶ Specify the frequency of the Xth segment again.



Segment not entried.

The PROGRAM SWEEP or USER SWEEP was specified without setting any segment.

- ▶ Specify the segment.

Segment STD not memorized.

To execute the DONE operation was attempted without obtaining all related calibration data.

- ▶ Obtain all calibration data.

## 7.5 Warning of Internal Set, Change, etc.

### CH1 INPUT-MEAS changed.

### CH2 INPUT-MEAS changed.

The INPUT-MEAS setting at the channel 1 or channel 2 was internally changed.

- ▶ When a S-parameter test set is connected, a INPUT-MEAS setting that a Forward direction and Reverse direction of the S-parameter test set, respectively, are simultaneously assigned to either CH1 or CH2 is invalid for a dual sweep (DUAL-CH ON, COUPLE-CH on).  
These messages are displayed when the above setting is executed.

When above message is displayed, the direction assigned to the channel described in the message is internally made the same direction as the other channel has been assigned to in INPUT-MEAS setting. (Settings of reflection or transmission measurement are not changed.)

### CORRECT turned off.

The CORRECT setting was internally altered to OFF.

- ▶ The measuring condition in which the correction data was obtained must be the same as the current measuring condition in the correcting measurement (CORRECT ON).  
Therefore, when the number of points or a sweep type is altered in a state of CORRECT ON, this message is displayed and CORRECT OFF is set.

### CORR or MEM can't be saved.

The correction data or memory waveform data was not able to be saved in executing SAVE REGISTER.

- ▶ The correction data or memory waveform data must be saved in B: drive with SAVE REGISTER.  
If available space is not in B: drive, this message is displayed. (However, the setting condition of the analyzer is saved.)  
Clear unwanted register.

### Data file can't be stored.

The waveform data (RAW, COEF, MEM, DATA) was not able to be saved with STORE-FILE.

- ▶ Available space is not in A: drive (floppy disk). (However, the setting condition of the analyzer is saved.)  
Clear unwanted registers or use another floppy disk.

Display Mode changed.

The display mode setting was internally altered to DISPLAY-DATA.

- ▶ A measuring condition in which the memory waveform was obtained must be the same as the current measuring condition and the measuring format must be set to one trace in the memory waveform display mode (DISPLAY-MEMORY, DISPLAY-DATA&MEM).

Therefore, when the number of points or the sweep type is altered in a state that the memory waveform is displayed, or when the measuring format is set to two traces (LOGMAG&PHASE, LOGMAG&DELAY, LINMAG&PHASE), this message is displayed and the display mode is altered to DISPLAY-DATA.

Overwrite

Data is being written over an already-existing file with STORE FILE.

- ▶ Specify a different file name to prevent to write over.

Sweep time increased.

The setting of the sweep time was internally altered and the sweep time was increased.

- ▶ The minimum setting of the sweep time depends on the RBW setting or others. When the sweep time is set to AUTO, this message is not displayed.

Therefore, when the sweep time is not set to AUTO, if this message is displayed by altering the setting of the RBW or and the sweep time is increased.

Afterward, even if the RBW setting is set to the previous setting, the sweep time setting can not be reset to the previous setting.

Trace-Math turned off.

The setting of the trace operation (DATA/MEM and others) was internally altered to OFF.

- ▶ The measuring condition in which the memory waveform was obtained must be the same as the current measuring condition in the trace operation.

Therefore, when the number of points or the sweep type was altered with the trace operation executed, this message is displayed and the trace operation is set to OFF.

## 7.6 Notice of Operating Completion, State, etc.

### Abort PLOT !!!

The plot output was interrupted by pushing the ABORT key, PRESET key, or STOP key.

### Clear Completed.

The memorized calibration data was cleared with CLEAR-CAL-DATA.

### Clear Input Trip.

The trip state of the input part was released with CLEAR-TRIP.

### Formatting now...

The floppy disk is now under formatting.

### Formatting complete

Formatting the floppy disk was correctly complete.

### Store Completed

A data waveform was copied into a memory waveform with DATA→MEMORY.

### Wait for sweep.

A sweep is being executed to obtain the calibration data.

## APPENDIX

### A.1 Initial Setting

#### (1) Initial setting

(1 of 3)

Function	Initialize method	
	Power on or preset	*RST
<b>Stimulus</b> Sweep type Continuous sweep Trigger source Trigger delay Sweep time Measurement point Start frequency Stop frequency Center frequency Frequency span Frequency display Fixed frequency of level sweep Output level Start level Stop level Trip Two-channel interlocking Program sweep segment Output port	Linear frequency sweep ON Internal (FREE RUN) OFF (0sec) 30msec (Manual) 201 5Hz 500MHz 250.0000025MHz 499.999995MHz Start/Stop 100MHz 0dBm -43dBm 0dBm Clear ON All clear Port 2 *1	Linear frequency sweep OFF Internal (FREE RUN) OFF (0sec) 120msec (Auto) 1201 5Hz 500MHz 250.0000025MHz 499.999995MHz Start/Stop 100MHz 0dBm -43dBm 21dBm Clear ON All clear Port 2 *1
<b>Response</b> Dual channel Active channel Resolution bandwidth Selection item of input port Average Trace operation Conversion Characteristic impedance Measurement format Group delay aperture Smoothing Display Split/Overlap Label	OFF 1 10kHz A/R *2 OFF (Number of times 16) NONE NONE 50Ω LOGMAG&PHASE 10% OFF (Aperture 10%) Data Overlap NONE	OFF 1 10kHz A/R *2 OFF (Number of times 16) NONE NONE 50Ω LOGMAG&PHASE 0.01% OFF (Aperture 0.01%) Data Overlap NONE

\*1: Port 1 is used for R3753E.

\*2: A is used for R3753E.

**R3753 SERIES  
NETWORK ANALYZER  
OPERATION MANUAL**

**A.1 Initial setting**

(2 of 3)

Function	Initialize method	
	Power on or preset	*RST
Calibration Correct measurement Calibration data Electrical length calibration Phase offset Measurement end extension correction R input A input B input Port 1 Port 2 Transfer constant	OFF Clear OFF (0sec) OFF (0°) OFF 0sec 0sec 0sec 0sec 0sec 0sec 1	OFF Clear OFF (0sec) OFF (0°) OFF 0sec 0sec 0sec 0sec 0sec 0sec 1
The value per division of Y-axis Logarithm amplitude Phase Group delay Smith chart Polar coordinate Linear amplitude SWR Real part Imaginary part Continuous phase	10dB 45° 0.1 μsec — — 0.1 1 1 1 360°	10dB 45° 0.1 μsec — — 0.1 1 1 1 360°
Reference position Logarithm amplitude Phase Group delay Smith chart Polar coordinate Linear amplitude SWR Real part Imaginary part Continuous phase	100% 50% 50% — — 0% 0% 100% 100% 50%	100% 50% 50% — — 0% 0% 100% 100% 50%

**R3753 SERIES  
NETWORK ANALYZER  
OPERATION MANUAL**

**A.1 Initial setting**

(3 of 3)

Function	Initialize method	
	Power on or preset	*RST
Reference value		
Logarithm amplitude	0dB	0dB
Phase	0°	0°
Group delay	0sec	0sec
Smith chart	1	1
Polar coordinate	1	1
Linear amplitude	0	0
SWR	1	1
Real part	10	10
Imaginary part	10	10
Continuous phase	0°	0°
Input attenuator		
R input	AUTO	AUTO
A input	AUTO	AUTO
B input	AUTO	AUTO
Input impedance		
R input	50Ω	50Ω
A input	50Ω	50Ω
B input	50Ω	50Ω

(2) Setting backup memory (factory default settings)

GPIB address	11
System controller/Addressable	Addressable
Printer GPIB address	18
Plotter GPIB address	5
Setting of serial port	Baud rate: 9600 Character length: 8 bits Parity: None Stop bit: 1
Save register	All clear

A.2 List of Softkey Menu

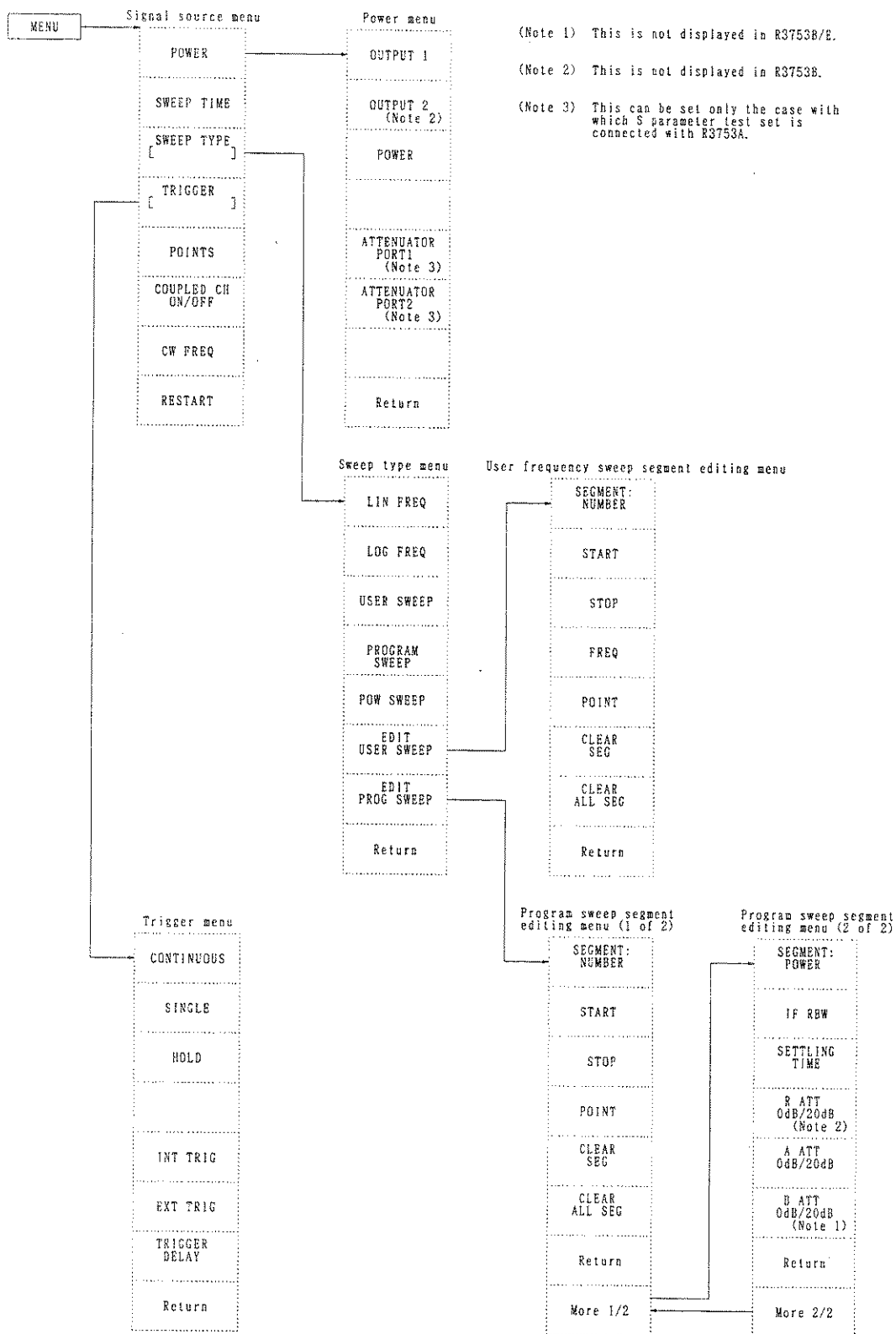



**R3753 SERIES  
NETWORK ANALYZER  
OPERATION MANUAL**

**A.2 LIST OF SOFTKEY MENU**

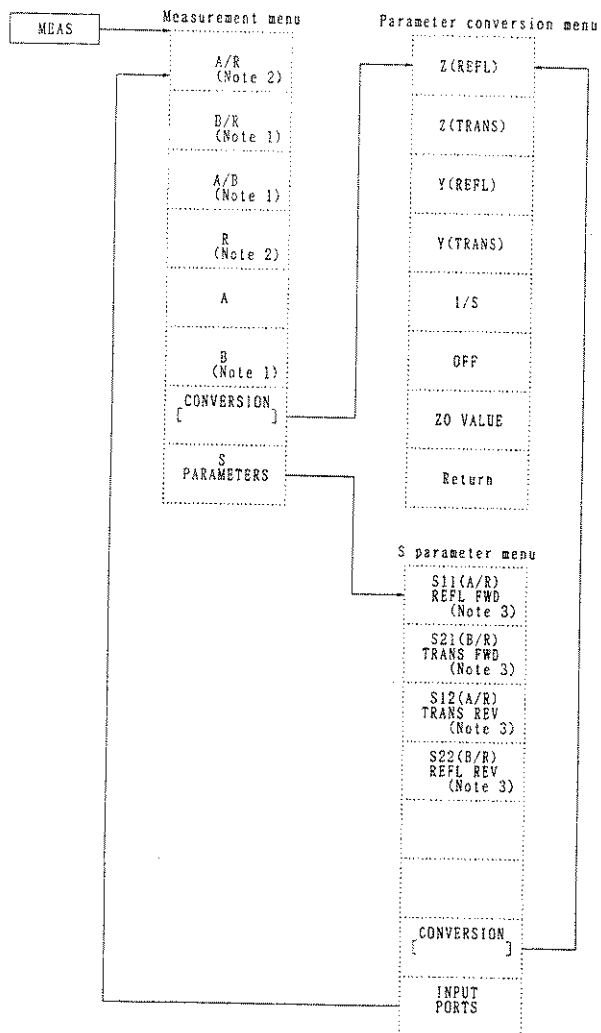

(Note 1) This is not displayed in R3753B/E.

(Note 2) This is not displayed in R3753B.

(Note 3) This can be set only the case with which S parameter test set is connected with R3753A.

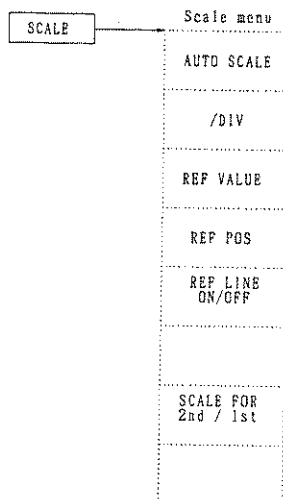
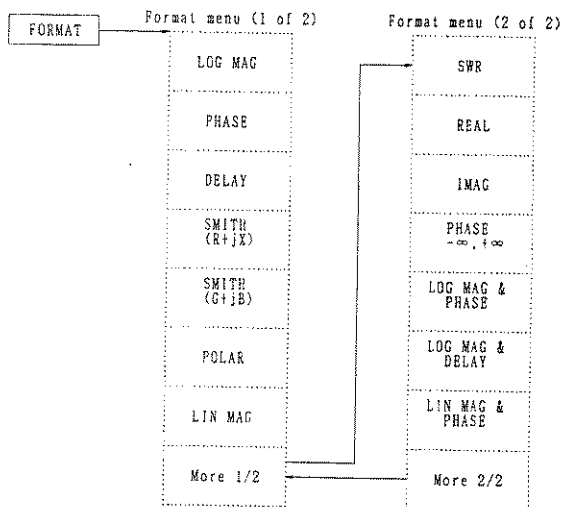

**R3753 SERIES  
NETWORK ANALYZER  
OPERATION MANUAL**

**A.2 LIST OF SOFTKEY MENU**

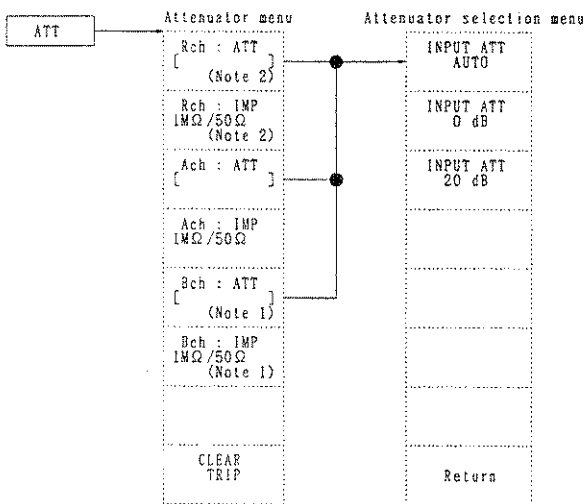
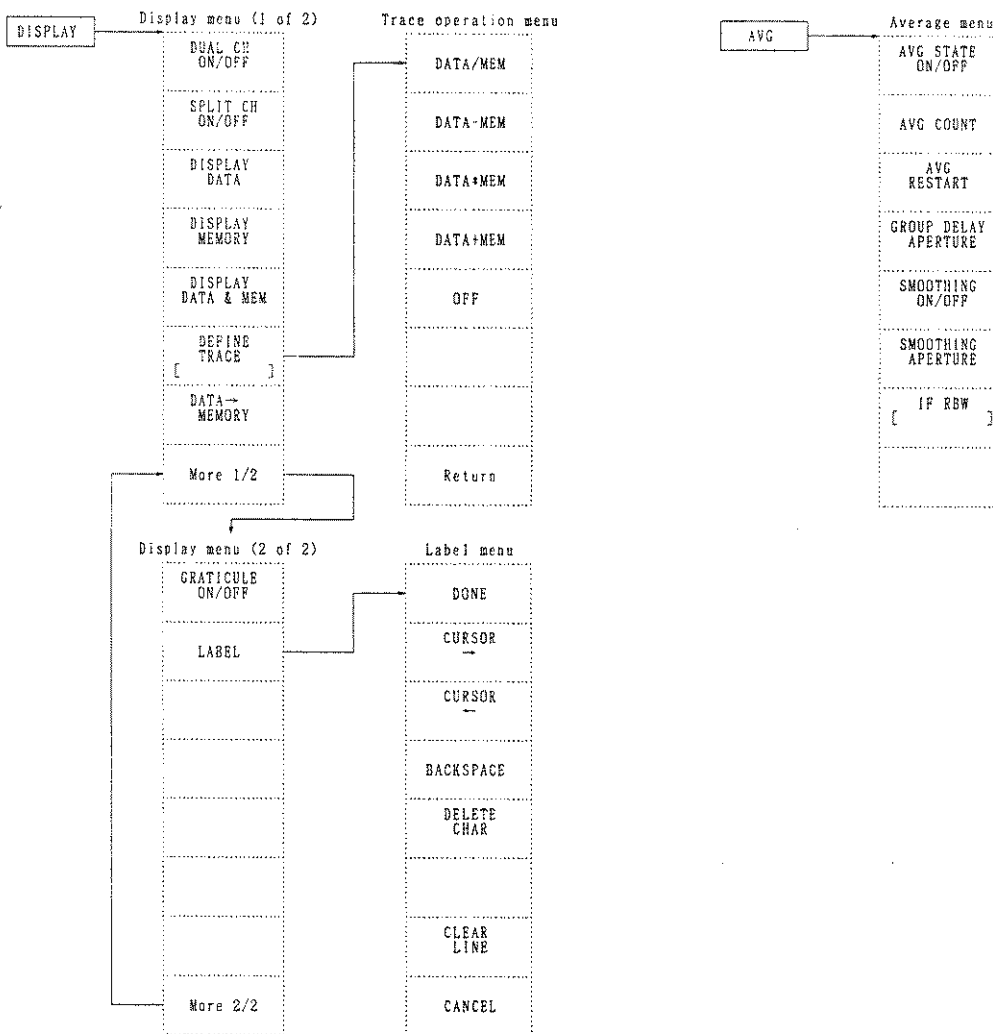

(Note 1) This is not displayed in R3753B/E.

(Note 2) This is not displayed in R3753B.

**R3753 SERIES  
NETWORK ANALYZER  
OPERATION MANUAL**

**A.2 LIST OF SOFTKEY MENU**

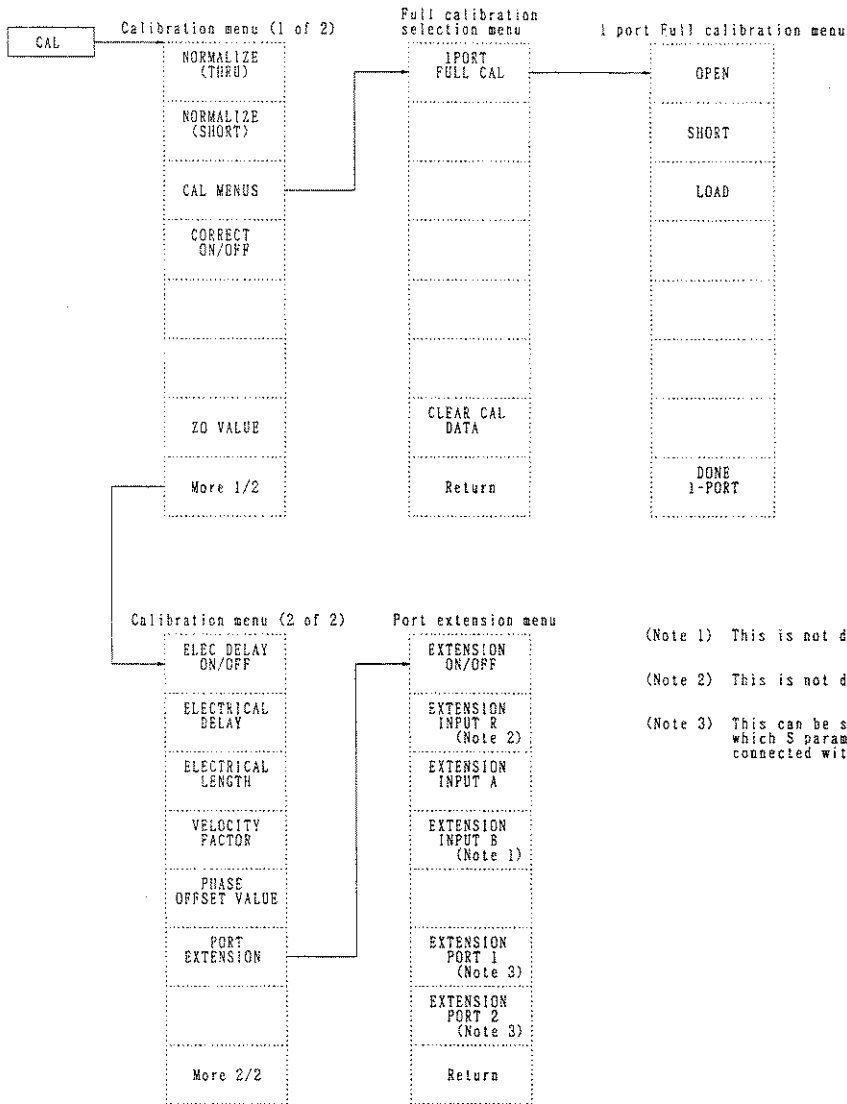

(Note 1) This is not displayed in R3753B/E.

(Note 2) This is not displayed in R3753B.

(Note 3) This can be set only the case with which S parameter test set is connected with R3753A.

**R3753 SERIES  
NETWORK ANALYZER  
OPERATION MANUAL**

**A.2 LIST OF SOFTKEY MENU**

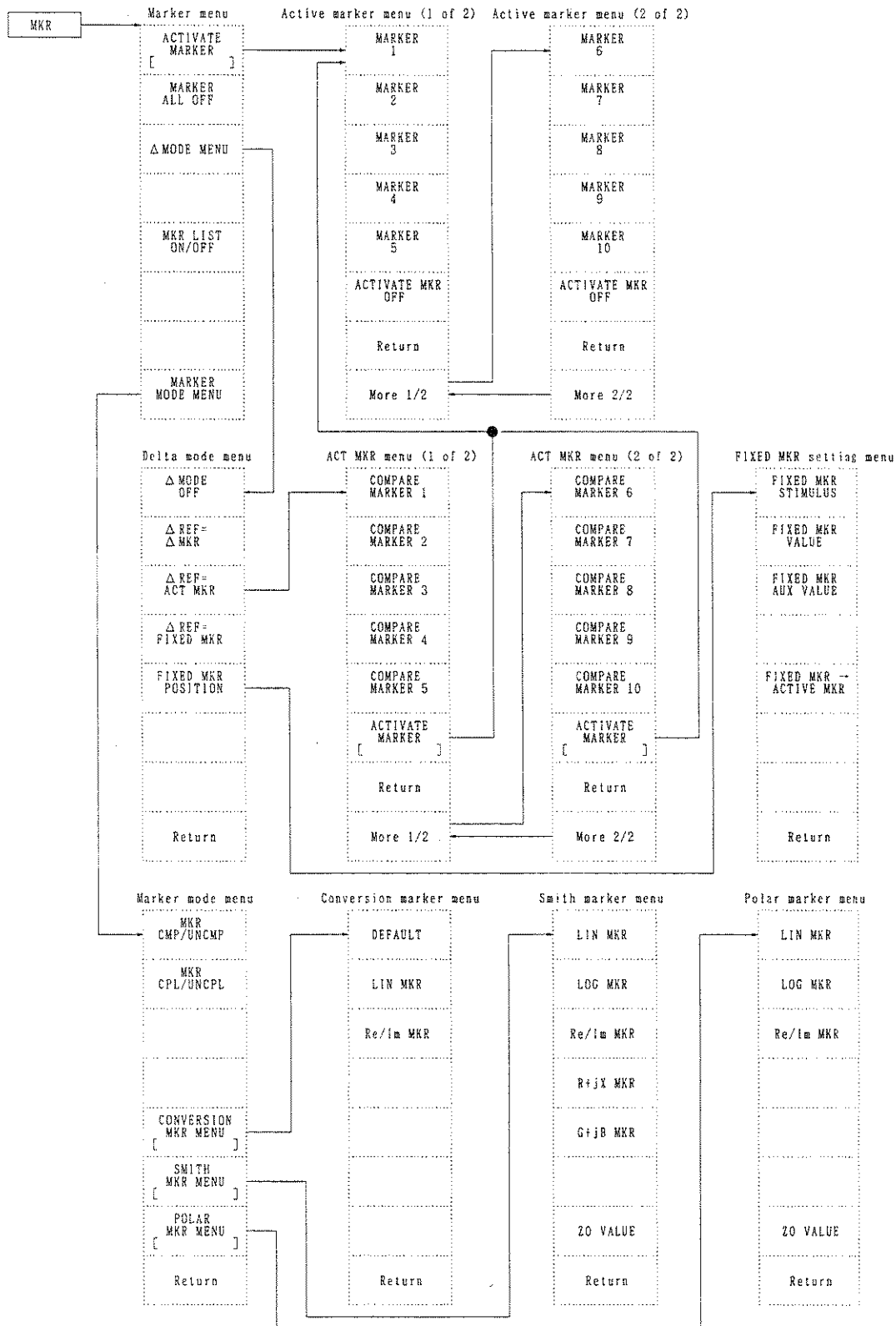

**R3753 SERIES  
NETWORK ANALYZER  
OPERATION MANUAL**

**A.2 LIST OF SOFTKEY MENU**

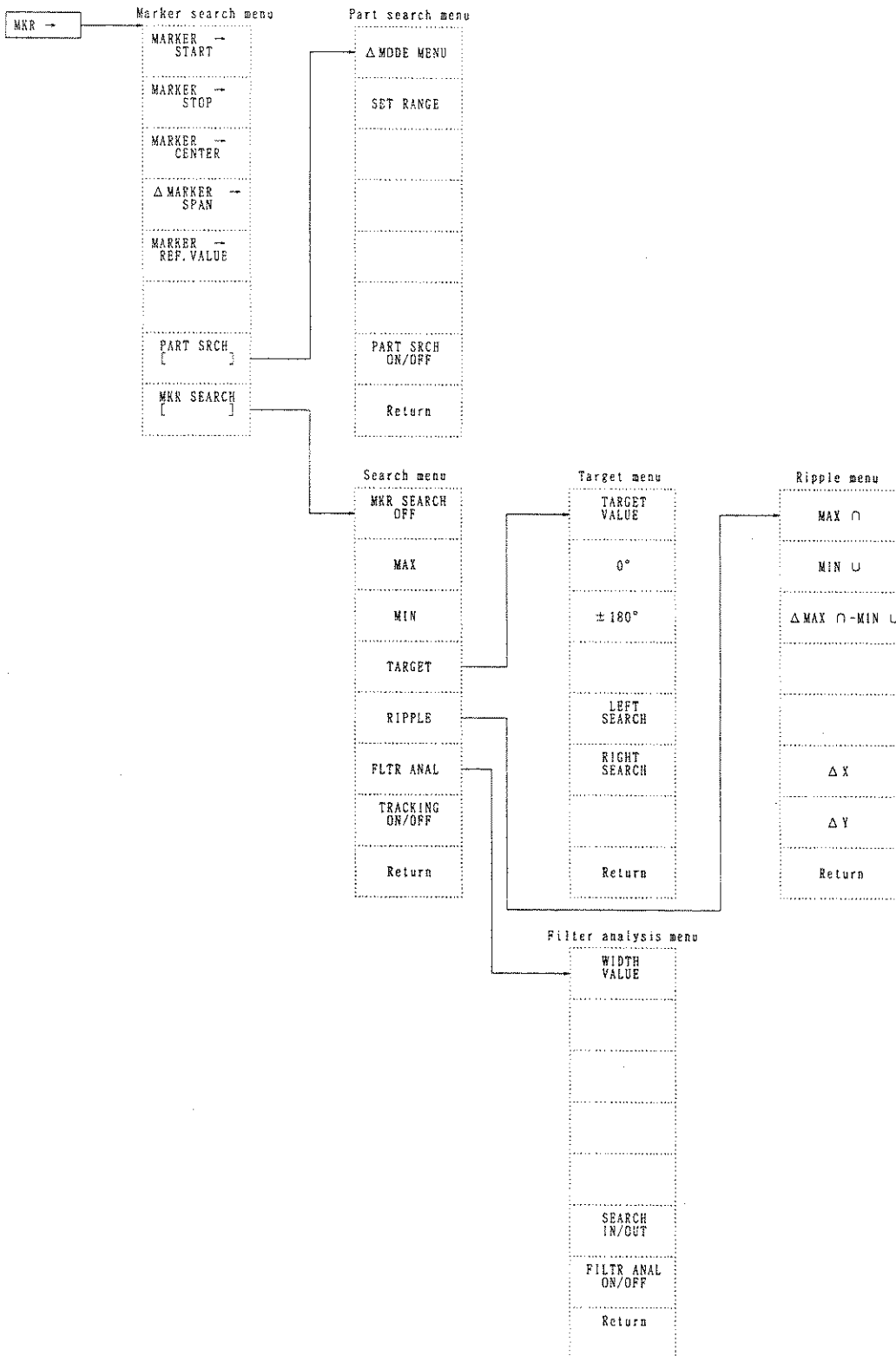

**R3753 SERIES  
NETWORK ANALYZER  
OPERATION MANUAL**

**A.2 LIST OF SOFTKEY MENU**

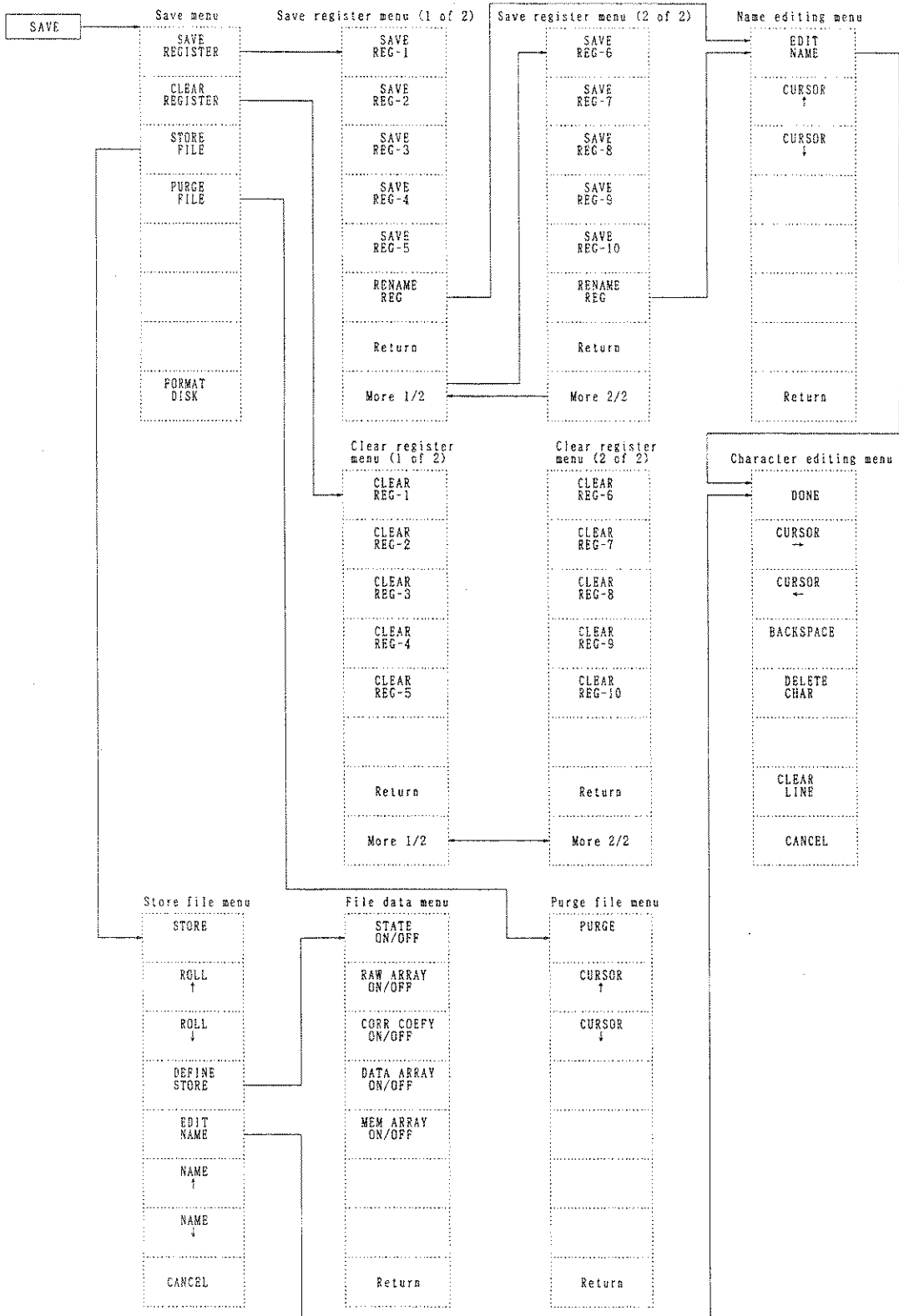

R3753 SERIES  
NETWORK ANALYZER  
OPERATION MANUAL

A.2 LIST OF SOFTKEY MENU

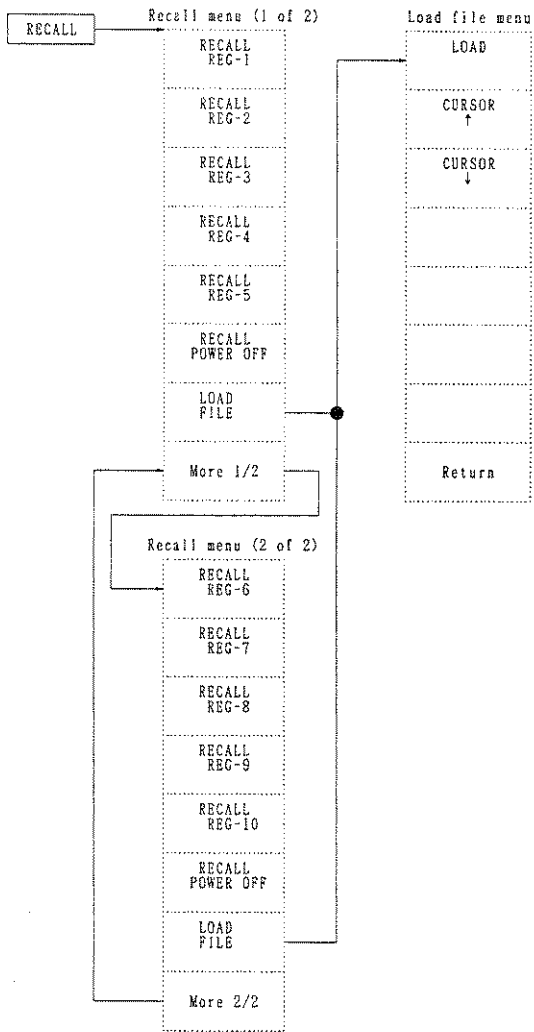

**R3753 SERIES  
NETWORK ANALYZER  
OPERATION MANUAL**

**A.2 LIST OF SOFTKEY MENU**

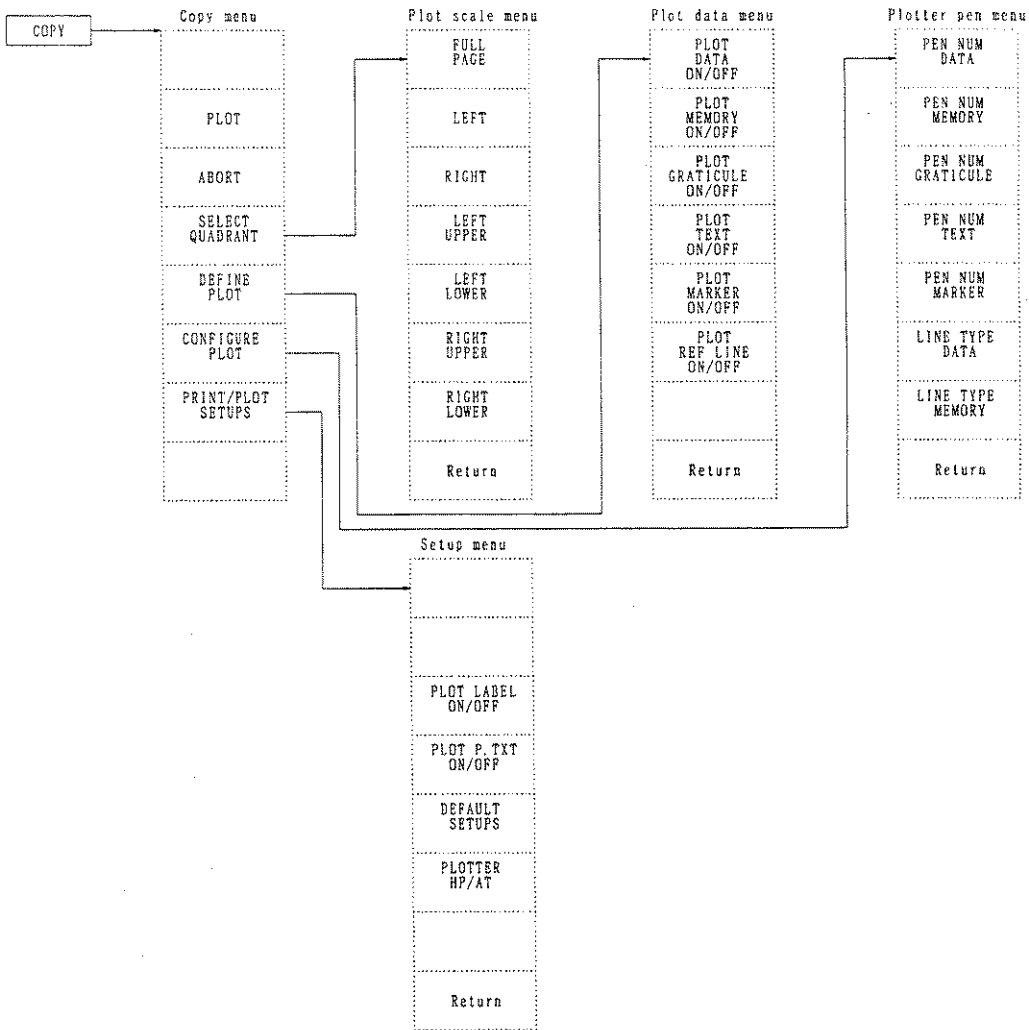



R3753 SERIES  
NETWORK ANALYZER  
OPERATION MANUAL

A.2 LIST OF SOFTKEY MENU

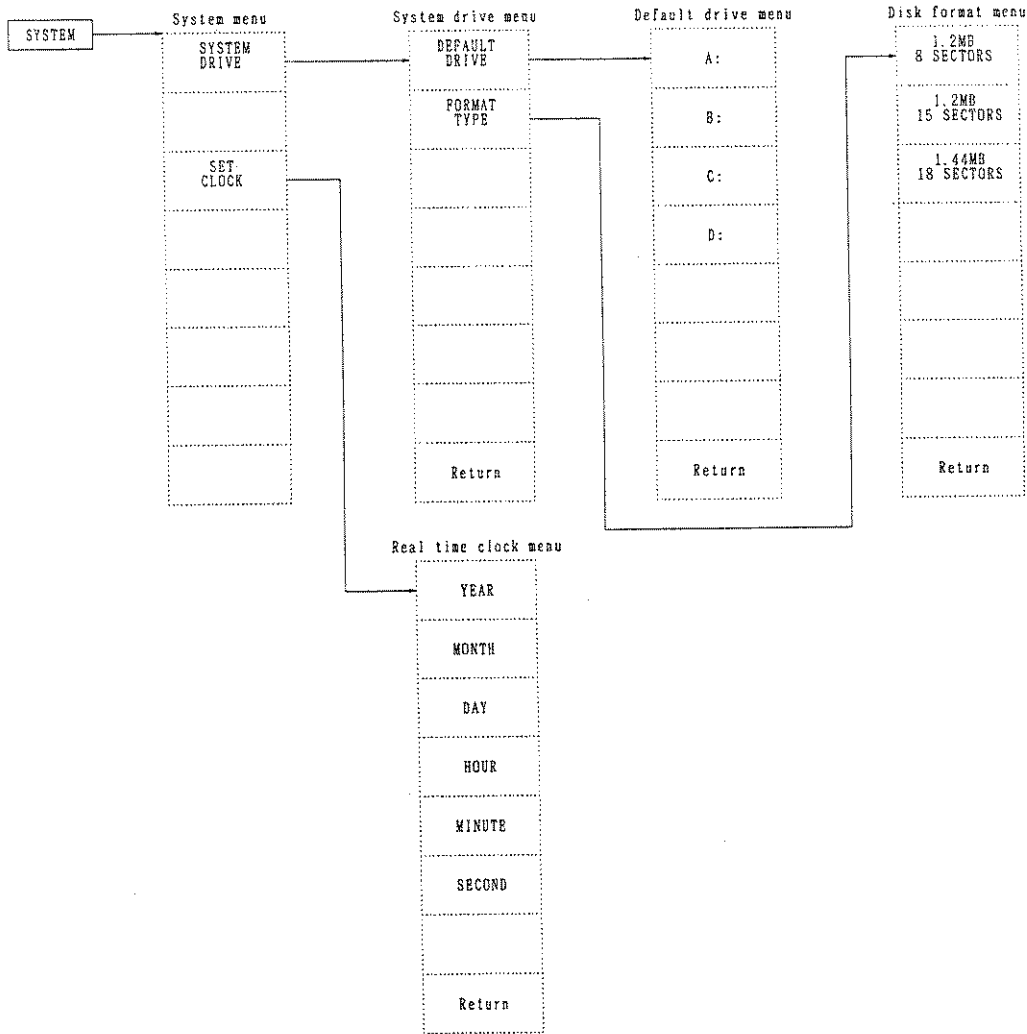

**R3753 SERIES  
NETWORK ANALYZER  
OPERATION MANUAL**

**A.2 LIST OF SOFTKEY MENU**

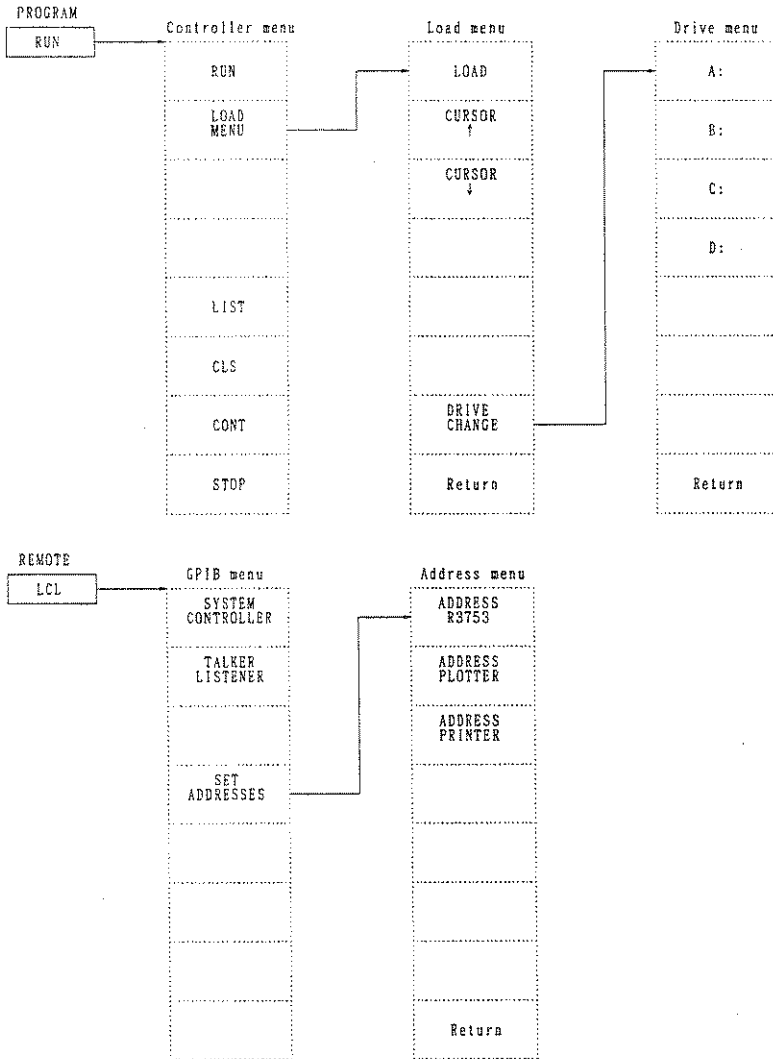

**R3753 SERIES  
NETWORK ANALYZER  
OPERATION MANUAL**

**A.3 GPIB COMMAND LIST CORRESPONDING TO PANEL KEY / SOFTKEY**

**A.3 GPIB Command List Corresponding to Panel Key / Softkey**

Shows the GPIB command corresponding to the panel key or the softkey. Refer to the separate volume "R3752/53 Programming Manual" for the details of each command.

- Describes depending on the item in the following panel.

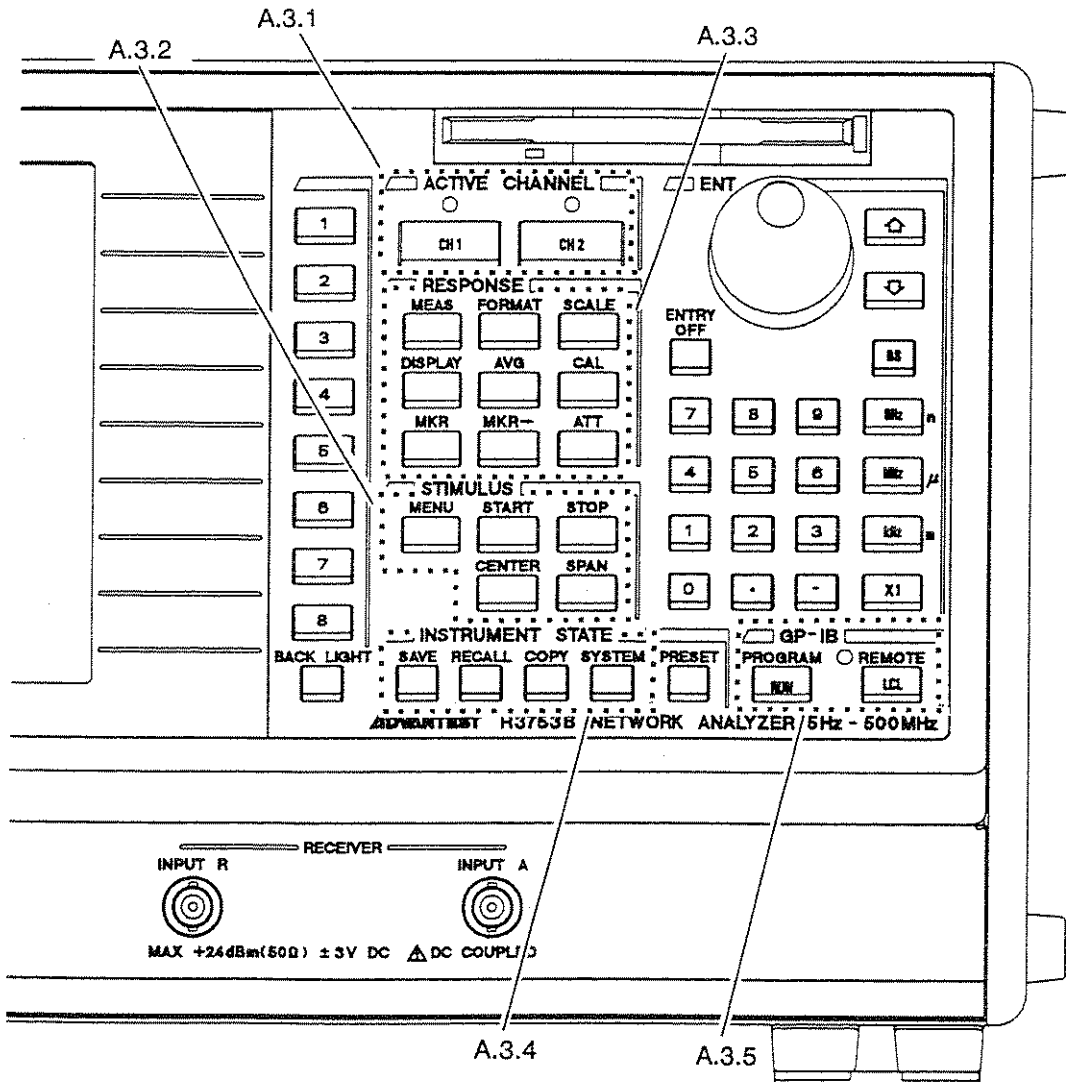

- Explanation of "O" and "N"  
 O: R3751 command mode  
 N: R3752/53 command mode

### A.3.1 ACTIVE CHANNEL Block

(1) CH1

CH1	O: CH1 N: DISPLAY:ACTIVE 1
-----	-------------------------------

(2) CH2

CH2	O: CH2 N: DISPLAY:ACTIVE 2
-----	-------------------------------

### A.3.2 STIMULUS Block

(1) MENU

Signal source menu

POWER	Calls the power menu. (See step (1-1).)
SWEEP TIME [            ]	O: STIME <real> STIMEAUTO N: [SOURCE:]SWEep[<chno>]:TIME <real> [SOURCE:]SWEep[<chno>]:TIME:AUTO <bool>
SWEEP TYPE [            ]	Calls the sweep type menu. (See step (1-3).)
TRIGGER [            ]	Calls the trigger menu. (See step (1-2).)
POINTS	O: M{1201 601 301 201 101 51 21 11 6 3}P/ POIN <int> N: [SOURCE:]SWEep[<chno>]:POINts <int>
COUPLED CH ON/OFF	O: COUPLE <bool> N: [SOURCE:]COUPle <bool>
CW FREQ	O: CWFREQ <real> N: [SOURCE:]FREQuency[<chno>]:CW <real>
RESTART	O: MEAS N: ABORT;INITiate[:IMMediate]

**R3753 SERIES  
NETWORK ANALYZER  
OPERATION MANUAL**

**A.3 GPIB COMMAND LIST CORRESPONDING TO PANEL KEY / SOFTKEY**

(1-1) Power menu

OUTPUT 1	O: PORT1 N: OUTPut1[:STATe] ON
OUTPUT 2 (Note 1)	O: PORT2 N: OUTPut2[:STATe] ON
POWER	O: OUTLEV <real> N: [SOURce:]POWER[<chno>][:LEVEl][:AMPLitude] <real>
ATTENUATOR PORT 1 (Note 2)	
ATTENUATOR PORT 2 (Note 2)	
Return	Returns to the signal source menu. (See step (1).)

(Note 1) This is not displayed in R3753E.

(Note 2) This can be set only when S parameter test set is connected with R3753A.

(1-2) Trigger menu

CONTINUOUS	O: CONT N: INITiate:CONTinuous ON
SINGLE	O: SINGLE N: INITiate:CONTinuous OFF;;ABORT;INITiate
HOLD	O: SWPHLD N: INITiate:CONTinuous OFF;;ABORT
INT TRIG	O: FREE N: TRIGger[:SEQuence]:SOURce IMMEDIATE
EXT TRIG	O: EXTERN N: TRIGger[:SEQuence]:SOURce EXTERNAL
TRIGGER DELAY	O: SETLTIME <real> N: TRIGger[:SEQuence]:DELay <real>
Return	Returns to the signal source menu. (See step (1).)

**R3753 SERIES  
NETWORK ANALYZER  
OPERATION MANUAL**

**A.3 GPIB COMMAND LIST CORRESPONDING TO PANEL KEY / SOFTKEY**

(1-3) Sweep type menu

LIN FREQ	O: LINFREQ N: [SOURCE:]SWEep[<chno>]:SPACing LINear [SOURCE:]FREQuency[<chno>]:MODE SWEep	} Use these commands together.
LOG FREQ	O: LOGFREQ N: [SOURCE:]SWEep[<chno>]:SPACing LOGarithmic [SOURCE:]FREQuency[<chno>]:MODE SWEep	
USER SWEEP	O: USRFSWP N: [SOURCE:]PSWep[<chno>]:MODE FREQuency	} Use these commands together.
PROGRAM SWEEP	O: USRARWP N: [SOURCE:]PSWep[<chno>]:MODE ALL	
POW SWEEP	O: LEVEL N: [SOURCE:]POWer[<chno>]:MODE SWEep	
EDIT USER SWEEP	Calls the user frequency sweep segment editing menu. (See step (1-3-1).)	
EDIT PROG SWEEP	Calls the program sweep segment editing menu. (See step (1-3-2).)	
Return	Returns to the signal source menu. (See step (1).)	

(1-3-1) User frequency sweep segment editing menu

SEGMENT: NUMBER	O: USEG <n> N: See Note.
START	O: USTART<start> N: [SOURCE:]PSWep[<chno>]:FREQuency[<n>] <start>[,<stop>]
STOP	O: USTOP<stop> N: [SOURCE:]PSWep[<chno>]:FREQuency[<n>] <start>[,<stop>]
FREQ	O: UFREQ<real> N: [SOURCE:]PSWep[<chno>]:FREQuency[<n>] <start>
POINT	O: UPOINT <int> N: [SOURCE:]PSWep[<chno>]:POINts[<n>] <int>
CLEAR SEG	O: There is no GPIB command to be applied. N: [SOURCE:]PSWep[<chno>]:CLEar[<n>]
CLEAR ALL SEG	O: USEGCL N: [SOURCE:]PSWep[<chno>]:CLEar[<n>]:ALL
Return	Returns to the sweep type menu.

<start> and <stop> are <real>.

Note: In R3752/53 command mode, the segment number is specified by the parameter <n> in each GPIB command.

**R3753 SERIES  
NETWORK ANALYZER  
OPERATION MANUAL**

**A.3 GPIB COMMAND LIST CORRESPONDING TO PANEL KEY / SOFTKEY**

(1-3-2) Program sweep segment editing menu (1 of 2)

SEGMENT: NUMBER	O: USEG <n> N: See Note 1.
START	O: USTART<start> / UFREQ<real> N: [SOURCE:]PSweep[<chno>]:FREQuency[<n>] <start>[,<stop>]
STOP	O: USTOP<stop> N: [SOURCE:]PSweep[<chno>]:FREQuency[<n>] <start>[,<stop>]
POINT	O: UPOINT <int> N: [SOURCE:]PSweep[<chno>]:POINts[<n>] <int>
CLEAR SEG	O: There is no GPIB command to be applied. N: [SOURCE:]PSweep[<chno>]:CLEar[<n>]
CLEAR ALL SEG	O: USEGCL N: [SOURCE:]PSweep[<chno>]:CLEar[<n>]:ALL
Return	Returns to the sweep type menu. (See step (1-3).)
More 1/2	Calls the program sweep segment editing menu (2 of 2).

< start > and < stop > are real.

Program sweep segment editing menu (2 of 2)

SEGMENT: POWER	O: ULEVEL <real> N: [SOURCE:]PSweep[<chno>]:POWER[<n>] <real>
IF RBW	O: URBW <int> N: [SOURCE:]PSweep[<chno>]:BANDwidth[<n>] <int>
SETTLING TIME	O: USETLT <real> N: [SOURCE:]PSweep[<chno>]:SETTLing[<n>] <real>
R ATT 0dB/20dB (Note 2)	O: UATTIR <int> N: [SOURCE:]PSweep[<chno>]:INPut1:ATTenuation[<n>] <int>
A ATT 0dB/20dB	O: UATTIA <int> N: [SOURCE:]PSweep[<chno>]:INPut2:ATTenuation[<n>] <int>
B ATT 0dB/20dB (Note 3)	O: UATTIB <int> N: [SOURCE:]PSweep[<chno>]:INPut3:ATTenuation[<n>] <int>
Return	Returns to the sweep type menu. (See step (1-3).)
More 2/2	Calls the program sweep segment editing menu (1 of 2).

Note 1: In R3752/53 command mode, the segment number is specified by the parameter <n> in each GPIB command.

Note 2: This is not displayed in R3753E.

Note 3: This is not displayed in R3753B/E.

R3753 SERIES  
NETWORK ANALYZER  
OPERATION MANUAL

A.3 GPIB COMMAND LIST CORRESPONDING TO PANEL KEY / SOFTKEY

(2) START

START

O: STARTF <real>  
STLEVEL <real>  
N: [SOURCE:]FREQUENCY[<chno>]:START <real>  
[SOURCE:]POWER[<chno>]:START <real>

(3) STOP

STOP

O: STOPF <real>  
STLEVEL <real>  
N: [SOURCE:]FREQUENCY[<chno>]:STOP <real>  
[SOURCE:]POWER[<chno>]:STOP <real>

(4) CENTER

CENTER

O: CENTERF <real>  
N: [SOURCE:]FREQUENCY[<chno>]:CENTER <real>

(5) SPAN

SPAN

O: SPANF <real>  
N: [SOURCE:]FREQUENCY[<chno>]:SPAN <real>



### A.3.3 RESPONSE Block

- (1) MEAS  
Measurement menu

A/R  (Note 1)	O: ARIN N: [SENSE:]FUNCTION[<chno>][:ON] 'POWER:AC:RATio 2,1' [SENSE:]FUNCTION[<chno>]:POWER AR
B/R  (Note 2)	O: BRIN N: [SENSE:]FUNCTION[<chno>][:ON] 'POWER:AC:RATio 3,1' [SENSE:]FUNCTION[<chno>]:POWER BR
A/B  (Note 2)	O: ABIN N: [SENSE:]FUNCTION[<chno>][:ON] 'POWER:AC:RATio 2,3' [SENSE:]FUNCTION[<chno>]:POWER AB
R  (Note 1)	O: RIN N: [SENSE:]FUNCTION[<chno>][:ON] 'POWER:AC 1' [SENSE:]FUNCTION[<chno>]:POWER R
A	O: AIN N: [SENSE:]FUNCTION[<chno>][:ON] 'POWER:AC 2' [SENSE:]FUNCTION[<chno>]:POWER A
B  (Note 2)	O: BIN N: [SENSE:]FUNCTION[<chno>][:ON] 'POWER:AC 3' [SENSE:]FUNCTION[<chno>]:POWER B
CONVERSION [        ]	Calls the parameter conversion menu. (See step (1-1).)
S PARAMETERS	Calls S parameter menu. (See step (1-2).)

Note 1: This is not displayed in R3753E.

Note 2: This is not displayed in R3753B/E.

**R3753 SERIES  
NETWORK ANALYZER  
OPERATION MANUAL**

**A.3 GPIB COMMAND LIST CORRESPONDING TO PANEL KEY / SOFTKEY**

(1-1) Parameter conversion menu

Z(REFL)	O: CONVRZ N: CALCulate[<chno>]:TRANSform:IMPedance:TYPE ZREFlection
Z(TRANS)	O: CONVTZ N: CALCulate[<chno>]:TRANSform:IMPedance:TYPE ZTRansmit
Y(REFL)	O: CONVRY N: CALCulate[<chno>]:TRANSform:IMPedance:TYPE YREFlection
Y(TRANS)	O: CONVTY N: CALCulate[<chno>]:TRANSform:IMPedance:TYPE YTRansmit
1/S	O: CONV1DS N: CALCulate[<chno>]:TRANSform:IMPedance:TYPE INVersion
OFF	O: CONVOFF N: CALCulate[<chno>]:TRANSform:IMPedance:TYPE NONE
Z0 VALUE	O: SETZ0 <real> / MKRZ0{50i75} N: CALCulate[<chno>]:TRANSform:IMPedance:CIMPedance <real>
Return	Returns to the measurement menu. (See step (1).)

(1-2) S parameter menu

S11(A/R) REFL FWD (Note)	O: S11 N: [SENSe:]FUNctioN[<chno>][:ON] 'POWer:S11' [SENSe:]FUNctioN[<chno>]:POWer S11
S21(B/R) TRANS FWD (Note)	O: S21 N: [SENSe:]FUNctioN[<chno>][:ON] 'POWer:S21' [SENSe:]FUNctioN[<chno>]:POWer S21
S12(A/R) TRANS REV (Note)	O: S12 N: [SENSe:]FUNctioN[<chno>][:ON] 'POWer:S12' [SENSe:]FUNctioN[<chno>]:POWer S12
S22(B/R) REFL REV (Note)	O: S22 N: [SENSe:]FUNctioN[<chno>][:ON] 'POWer:S22' [SENSe:]FUNctioN[<chno>]:POWer S22
CONVERSION [ ]	Calls the parameter conversion menu. (See step (1-1).)
INPUT PORTS	Calls the measurement menu. (See step (1).)

Note: This can be set only when S parameter test set is connected with R3753A.

**R3753 SERIES  
NETWORK ANALYZER  
OPERATION MANUAL**

**A.3 GPIB COMMAND LIST CORRESPONDING TO PANEL KEY / SOFTKEY**

(2) **FORMAT**

Format menu (1 of 2)

LOG MAG	O: LOGMAG N: CALCulate[<chno>]:FORMat MLOGarithmic
PHASE	O: PHASE N: CALCulate[<chno>]:FORMat PHASE
DELAY	O: DELAY N: CALCulate[<chno>]:FORMat GDElay
SMITH (R + jX)	O: SRJX N: CALCulate[<chno>]:FORMat SCHart
SMITH (G + jB)	O: SGJB N: CALCulate[<chno>]:FORMat ISCHart
POLAR	O: POLAR N: CALCulate[<chno>]:FORMat POLar
LIN MAG	O: LINMAG N: CALCulate[<chno>]:FORMat MLINear
More 1/2	Calls the format menu (2 of 2).

Format menu (2 of 2)

SWR	O: SWR N: CALCulate[<chno>]:FORMat SWR
REAL	O: REAL N: CALCulate[<chno>]:FORMat REAL
IMAG	O: IMAG N: CALCulate[<chno>]:FORMat IMAGinary
PHASE -∞, +∞	O: UNWRAP N: CALCulate[<chno>]:FORMat UPHase
LOG MAG & PHASE	O: LOGMP N: CALCulate[<chno>]:FORMat MLOPhase
LOG MAG & DELAY	O: LOGMD N: CALCulate[<chno>]:FORMat MLODelay
LIN MAG & PHASE	O: LINMP N: CALCulate[<chno>]:FORMat MLIPhase
More 2/2	Calls the format menu (1 of 2).

A.3 GPIB COMMAND LIST CORRESPONDING TO PANEL KEY / SOFTKEY

(3) SCALE

Scale menu

AUTO SCALE	O: AUTO N: DISPLAY[:WINDOW[<chno>]]:Y[<trace>][:SCALE]:AUTO ONCE
/DIV	O: SDIV <real> N: DISPLAY[:WINDOW[<chno>]]:Y[<trace>][:SCALE]:PDIVision <real>
REF VALUE	O: REFL <real> N: DISPLAY[:WINDOW[<chno>]]:Y[<trace>][:SCALE]:RLEVEL <real>
REF POS	O: REFP <real> N: DISPLAY[:WINDOW[<chno>]]:Y[<trace>][:SCALE]:RPOSITION <real>
REF LINE	O: REFL <bool> N: DISPLAY[:WINDOW[<chno>]]:Y[<trace>]RLINE <bool>
SCALE FOR 2nd / 1st	O: SCALF{1ST 2ND} N: See Note.

Note: In R3752/53 command mode, TRACE is selected by the parameter <trace> in each GPIB command.

<trace> = 0,1,8,9 (0:CH1 TRACE 1st, 1:CH2 TRACE 1st, 8:CH1 TRACE 2nd, 9:CH2 TRACE 2nd)

R3753 SERIES  
NETWORK ANALYZER  
OPERATION MANUAL

A.3 GPIB COMMAND LIST CORRESPONDING TO PANEL KEY / SOFTKEY

(4) DISPLAY

Display menu (1 of 2)

DUAL CH ON/OFF	O: DUAL <bool> N: DISPLAY:DUAL <bool>
SPLIT CH ON/OFF	O: SPLIT <bool> N: DISPLAY:FORMAT {ULOWER FBACK} (See Note.)
DISPLAY DATA	O: DISPDATA N: DISPLAY[:WINDOW[<chno>]]:TRACE:ASSIGN DATA
DISPLAY MEMORY	O: DISPMEM N: DISPLAY[:WINDOW[<chno>]]:TRACE:ASSIGN MEMORY
DISPLAY DATA & MEM	O: DISPDM N: DISPLAY[:WINDOW[<chno>]]:TRACE:ASSIGN DMEMORY
DEFINE TRACE [ ]	Calls the trace operation menu. (See step (4-2).)
DATA→ MEMORY	O: DTOM N: TRACE[<chno>]:COPY DATA
More 1/2	Calls the display menu (2 of 2).

Note: SPLIT CH: Split display  
ULOWER; Over-wrap display  
FBACK;

Display menu (2 of 2)

GRATICULE ON/OFF	O: GRAT <bool> N: DISPLAY[:WINDOW[<chno>]]:TRACE:GRATICULE[:STATE] <bool>
LABEL	Calls the label menu. (See step (4-1).)
More 2/2	Calls the display menu (1 of 2).

**R3753 SERIES  
NETWORK ANALYZER  
OPERATION MANUAL**

**A.3 GPIB COMMAND LIST CORRESPONDING TO PANEL KEY / SOFTKEY**

**(4-1) Label menu**

DONE	O: LABEL <str> N: DISPlay[:WINDow[<chno>]]:TEXT[:DATA] {<str> <bblock>}
CURSOR →	There is no GPIB command to be applied.
CURSOR ←	There is no GPIB command to be applied.
BACKSPACE	There is no GPIB command to be applied.
DELETE CHAR	There is no GPIB command to be applied.
CLEAR LINE	There is no GPIB command to be applied.
CANCEL	Calls the display menu (2 of 2). (See step (4).)

**(4-2) Trace operation menu**

DATA/MEM	O: DISPDDM ON N: CALCulate[<chno>]:MATH[:EXPRession]:NAME DDM
DATA-MEM	O: There is no GPIB command to be applied. N: CALCulate[<chno>]:MATH[:EXPRession]:NAME DSM
DATA*MEM	O: There is no GPIB command to be applied. N: CALCulate[<chno>]:MATH[:EXPRession]:NAME DMM
DATA + MEM	O: There is no GPIB command to be applied. N: CALCulate[<chno>]:MATH[:EXPRession]:NAME DAM
OFF	O: DISPDDM OFF N: CALCulate[<chno>]:MATH[:EXPRession]:NAME NONE
Return	Returns to the display menu (1 of 2). (See step (4).)

**R3753 SERIES  
NETWORK ANALYZER  
OPERATION MANUAL**

**A.3 GPIB COMMAND LIST CORRESPONDING TO PANEL KEY / SOFTKEY**

(5) AVG

Average menu

AVG STATE ON/OFF	O: AVER <bool> N: [SENSe:]AVERAge[<chno>][:STATe] <bool>
AVG COUNT	O: AVERFACT <int>/ AVR{2I4I8I16I32I64I128} N: [SENSe:]AVERAge[<chno>]:COUNT <int>
AVG RESTART	O: AVERREST N: [SENSe:]AVERAge[<chno>]:REStArt
GROUP DELAY APERTURE	O: APERTP <real> N: CALCuLate[<chno>]:GDAPerture:APERture <real>
SMOOTHING ON/OFF	O: SMOO <bool> N: CALCuLate[<chno>]:SMOothing:STATe <bool>
SMOOTHING APERTURE	O: SMOOAPER <REAL> N: CALCuLate[<chno>]:SMOothing:APERture <real>
IF RBW [            ]	O: RBW <int> / RBW{1KI300I100I30I10}HZ / RBWAUTO N: [SENSe:]BANDwidth[:RESolution] <real> [SENSe:]BANDwidth[:RESolution]:AUTO <bool>

**R3753 SERIES  
NETWORK ANALYZER  
OPERATION MANUAL**

**A.3 GPIB COMMAND LIST CORRESPONDING TO PANEL KEY / SOFTKEY**

**(6) ATT**

Attenuator menu

Rch : ATT [            ] (Note 1)	<p>Calls the attenuator selection menu. (See step (6-1).)</p> <p>O: ATTIR &lt;int&gt;/ ATTIRAUTO/ RI{50i1}A{20i0}</p> <p>N: INPut1:ATTenuation &lt;int&gt;/ INPut1:ATTenuation:AUTO &lt;bool&gt;</p>
Rch : IMP 1MΩ/50Ω (Note 1)	<p>O: IMPIR &lt;int&gt;/ RI{50i1}A{20i0}</p> <p>N: INPut1:IMPedance &lt;int&gt;</p>
Ach : ATT [            ]	<p>Calls the attenuator selection menu. (See step (6-1).)</p> <p>O: ATTIA &lt;int&gt;/ ATTIAAUTO/ AI{50i1}A{20i0}</p> <p>N: INPut2:ATTenuation &lt;int&gt;/ INPut2:ATTenuation:AUTO &lt;bool&gt;</p>
Ach : IMP 1MΩ/50Ω	<p>O: IMPIA &lt;int&gt;/ AI{50i1}A{20i0}</p> <p>N: INPut2:IMPedance &lt;int&gt;</p>
Bch : ATT [            ] (Note 2)	<p>Calls the attenuator selection menu. (See step (6-1).)</p> <p>O: ATTIB &lt;int&gt;/ ATTIBAUTO/ BI{50i1}A{20i0}</p> <p>N: INPut3:ATTenuation &lt;int&gt;/ INPut3:ATTenuation:AUTO &lt;bool&gt;</p>
Bch : IMP 1MΩ/50Ω (Note 2)	<p>O: IMPIB &lt;int&gt;/ BI{50i1}A{20i0}</p> <p>N: INPut3:IMPedance &lt;int&gt;</p>
CREAR TRIP	<p>O: CLRTRIP</p> <p>N: [SENSe:]POWer:AC:PROTection:CLEAr</p>

Note 1: This is not displayed in R3753E.

Note 2: This is not displayed in R3753B/E.

**(6-1) Attenuator selection menu**

INPUT ATT AUTO	<p>O: ATTI{RIAIB}AUTO</p> <p>N: INPut[&lt;input&gt;]:ATTenuation:AUTO &lt;bool&gt;</p>
INPUT ATT 0dB	<p>O: ATTI{RIAIB}0</p> <p>N: INPut[&lt;input&gt;]:ATTenuation 0</p>
INPUT ATT 20dB	<p>O: ATTI{RIAIB}20</p> <p>N: INPut[&lt;input&gt;]:ATTenuation 20</p>
Return	<p>Returns to the attenuator menu. (See step (6).)</p>

<input> = {1|2|3} (1:Rch, 2:Ach, 3:Bch)



**R3753 SERIES  
NETWORK ANALYZER  
OPERATION MANUAL**

**A.3 GPIB COMMAND LIST CORRESPONDING TO PANEL KEY / SOFTKEY**

**(7) CAL**

Calibration menu (1 of 2)

NORMALIZE (THRU)	O: NORM ON N: [SENSe:]CORRection[<chno>]:COLLect[:ACQuire] NORMalize
NORMALIZE (SHORT)	O: NORMS ON N: [SENSe:]CORRection[<chno>]:COLLect[:ACQuire] SNORMalize
CAL MENU	Calls the full calibration selection menu. (See step (7-1).)
CORRECT ON/OFF	O: CORRECT <bool> N: [SENSe:]CORRection[<chno>]:CSET:STATe <bool>
Z0 VALUE	O: SETZ0 <real> / MKRZ0{50175} N: CALCulate[<chno>]:TRANSform:IMPedance:CIMPedance <real>
More 1/2	Calls the calibration menu (2 of 2).

Calibration menu (2 of 2)

ELEC DELAY ON/OFF	O: LENGTH <bool> N: [SENSe:]CORRection[<chno>]:EDELay:STATe <bool>
ELECTRICAL DELAY	O: ELED <real> N: [SENSe:]CORRection[<chno>]:EDELay[:TIME] <real>
ELECTRICAL LENGTH	O: LENGVAL <real> N: [SENSe:]CORRection[<chno>]:EDELay:DISTance <real>
VELOCITY FACTOR	O: VELOFACT <real> N: [SENSe:]CORRection[<chno>]:RVELocity:COAX <real>
PHASE OFFSET VALUE	O: PHAO N: [SENSe:]CORRection[<chno>]:OFFSet:PHASe <real>
PORT EXTENSION	Calls the port extension menu. (See step (7-2).)
More 2/2	Calls the calibration menu (1 of 2).

(7-1) Full calibration selection menu

1PORT FULL CAL	Calls the 1 port full calibration menu. (See step (7-1-1).)
CLEAR CAL DATA	O: CLEAR N: [SENSe:]CORRection[<chno>]:COLLect:DELeTe
Return	Returns to the calibration menu (1 of 2). (See step (7).)

(7-1-1) 1 port full calibration menu

OPEN	O: OPEN N: [SENSe:]CORRection[<chno>]:COLLect[:ACQuire] OPEN
SHORT	O: SHORT N: [SENSe:]CORRection[<chno>]:COLLect[:ACQuire] SHORT
LOAD	O: LOAD N: [SENSe:]CORRection[<chno>]:COLLect[:ACQuire] LOAD
DONE 1-PORT	O: DONE / DONE1PORT N: [SENSe:]CORRection[<chno>]:COLLect:SAVE

(7-2) Port extension menu

EXTENSION ON/OFF	O: PORE <bool> N: [SENSe:]CORRection[<chno>]:PEXTension:STATe <bool>
EXTENSION INPUT R (Note 1)	O: EPORTR <real> N: [SENSe:]CORRection[<chno>]:PEXTension:TIME1 <real>
EXTENSION INPUT A	O: EPORTA <real> N: [SENSe:]CORRection[<chno>]:PEXTension:TIME2 <real>
EXTENSION INPUT B (Note 2)	O: EPORTB <real> N: [SENSe:]CORRection[<chno>]:PEXTension:TIME3 <real>
EXTENSION PORT 1 (Note 3)	O: EPORT1 <real> N: [SENSe:]CORRection[<chno>]:PEXTension:TIME4 <real>
EXTENSION PORT 2 (Note 3)	O: EPORT2 <real> N: [SENSe:]CORRection[<chno>]:PEXTension:TIME5 <real>
Return	Returns to the calibration menu (2 of 2).

Note 1: This is not displayed in R3753E.

Note 2: This is not displayed in R3753B/E.

Note 3: This can be set only when S parameter test set is connected with R3753A.

R3753 SERIES  
NETWORK ANALYZER  
OPERATION MANUAL

A.3 GPIB COMMAND LIST CORRESPONDING TO PANEL KEY / SOFTKEY

(8) MKR

Marker menu

ACTIVATE MARKER [ ]	Calls the active marker menu (1 of 2). (See step (8-1).)
MARKER ALL OFF	O: MKRAOFF N: MARKer[<chno>]:AOFF
ΔMODE MENU	Calls the delta mode menu. (See step (8-2).)
MKR LIST ON/OFF	O: There is no GPIB command to be applied. N: MARKer[<chno>]:LIST <bool>
MARKER MODE MENU	Calls the marker mode menu. (See step (8-3).)

For acquiring the marker data, the following commands can be used.

O: MKR{1|2|3|4|5|6|7|8|9|10}A?

N: FETch[<chno>][:MARKer][:ACTivate]?  
FETch[<chno>][:MARKer]:NUMBer<n>?

**R3753 SERIES  
NETWORK ANALYZER  
OPERATION MANUAL**

**A.3 GPIB COMMAND LIST CORRESPONDING TO PANEL KEY / SOFTKEY**

(8-1) Active marker menu (1 of 2)

MARKER 1	O: MKR1A <real> N: MARKer[<chno>]:ACTivate[:NUMBer] 1[,<real>]
MARKER 2	O: MKR2A <real> N: MARKer[<chno>]:ACTivate[:NUMBer] 2[,<real>]
MARKER 3	O: MKR3A <real> N: MARKer[<chno>]:ACTivate[:NUMBer] 3[,<real>]
MARKER 4	O: MKR4A <real> N: MARKer[<chno>]:ACTivate[:NUMBer] 4[,<real>]
MARKER 5	O: MKR5A <real> N: MARKer[<chno>]:ACTivate[:NUMBer] 5[,<real>]
ACTIVATE MKR OFF	O: MKROFF N: MARKer[<chno>]:ACTivate:STATe <bool>
Return	Returns to the marker menu. (See step (8).)
More 1/2	Calls the active marker menu (2 of 2).

Active marker menu (2 of 2)

MARKER 6	O: MKR6A <real> N: MARKer[<chno>]:ACTivate[:NUMBer] 6[,<real>]
MARKER 7	O: MKR7A <real> N: MARKer[<chno>]:ACTivate[:NUMBer] 7[,<real>]
MARKER 8	O: MKR8A <real> N: MARKer[<chno>]:ACTivate[:NUMBer] 8[,<real>]
MARKER 9	O: MKR9A <real> N: MARKer[<chno>]:ACTivate[:NUMBer] 9[,<real>]
MARKER 10	O: MKR10A <real> N: MARKer[<chno>]:ACTivate[:NUMBer] 10[,<real>]
ACTIVATE MKR OFF	O: MKROFF N: MARKer[<chno>]:ACTivate:STATe <bool>
Return	Returns to the marker menu. (See step (8).)
More 2/2	Calls the active marker menu (1 of 2).

**R3753 SERIES  
NETWORK ANALYZER  
OPERATION MANUAL**

**A.3 GPIB COMMAND LIST CORRESPONDING TO PANEL KEY / SOFTKEY**

(8-2) Delta mode menu

ΔMODE OFF	O: DMKROF N: MARKer[<chno>]:DELTA[:MODE] OFF
ΔREF = ΔMKR	O: DMKRC N: MARKer[<chno>]:DELTA[:MODE] CHILd
ΔREF = ACT MKR	Calls the ACT MKR menu. (See step (8-2-1).) O: DMKRA N: MARKer[<chno>]:DELTA[:MODE] COMPare
ΔREF = FIXED MKR	O: DMKRF N: MARKer[<chno>]:DELTA[:MODE] FIXed
FIXED MKR POSITION	Calls FIXED MKR setting menu. (See step (8-2-2).)
Return	Returns to the marker menu. (See step (8).)

Select the compare marker before setting the delta mode to ΔREF = ACT MKR.  
(See ACT MKR menu.)

(8-2-1) ACT MKR menu (1 of 2)

COMPARE MARKER 1	O: DMKR10 <real> N: MARKer[<chno>]:DELTA:COMPare 1[,<real>]
COMPARE MARKER 2	O: DMKR20 <real> N: MARKer[<chno>]:DELTA:COMPare 2[,<real>]
COMPARE MARKER 3	O: DMKR30 <real> N: MARKer[<chno>]:DELTA:COMPare 3[,<real>]
COMPARE MARKER 4	O: DMKR40 <real> N: MARKer[<chno>]:DELTA:COMPare 4[,<real>]
COMPARE MARKER 5	O: DMKR50 <real> N: MARKer[<chno>]:DELTA:COMPare 5[,<real>]
ACTIVATE MARKER [ ]	Calls the active marker menu (1 of 2). (See step (8-1).)
Return	Returns to the delta mode menu. (See step (8-2).)
More 1/2	Calls ACT MKR menu (2 of 2).

**R3753 SERIES  
NETWORK ANALYZER  
OPERATION MANUAL**

**A.3 GPIB COMMAND LIST CORRESPONDING TO PANEL KEY / SOFTKEY**

ACT MKR menu (2 of 2)

COMPARE MARKER 6	O: DMKR60 <real> N: MARKer[<chno>]:DELTA:COMPare 6[,<real>]
COMPARE MARKER 7	O: DMKR70 <real> N: MARKer[<chno>]:DELTA:COMPare 7[,<real>]
COMPARE MARKER 8	O: DMKR80 <real> N: MARKer[<chno>]:DELTA:COMPare 8[,<real>]
COMPARE MARKER 9	O: DMKR90 <real> N: MARKer[<chno>]:DELTA:COMPare 9[,<real>]
COMPARE MARKER 10	O: DMKR100 <real> N: MARKer[<chno>]:DELTA:COMPare 10[,<real>]
ACTIVATE MARKER [            ]	Calls the active marker menu (1 of 2). (See step (8-1).)
Return	Returns to the delta mode menu. (See step (8-2).)
More 2/2	Calls ACT MKR menu (1 of 2).

(8-2-2) FIXED MKR setting menu (1 of 2)

FIXED MKR STIMULUS	O: FMKRS <real> N: MARKer[<chno>]:FIXed:STIMulus <real>
FIXED MKR VALUE	O: FMKRV <real> N: MARKer[<chno>]:FIXed:VALue <real>
FIXED MKR AUX VALUE	O: There is no GPIB command to be applied. N: MARKer[<chno>]:FIXed:AVALue <real>
FIXED MKR→ ACTIVE MKR	O: MKRFIX N: MARKer[<chno>]:LET FIXed
Return	Calls the delta mode menu. (See step (8-2).)

A.3 GPIB COMMAND LIST CORRESPONDING TO PANEL KEY / SOFTKEY

(8-3) Marker mode menu

MKR CMP/UNCMP	O: MKRCMP/ MKRUCMP N: MARKer[<chno>]:COMPensate <bool>
MKR CPL/UNCPL	O: MKRCOUP/ MKRUCOUP N: MARKer[<chno>]:COUPle <bool>
CONVERSION MKR MENU [ ]	Calls the conversion marker menu. (See step (8-3-1).)
SMITH MKR MENU [ ]	Calls the smith marker menu. (See step (8-3-2).)
POLAR [ ] MKR MENU	Calls the polar marker menu . (See step (8-3-3).)
Return	Returns to the marker menu. (See step (8).)

(8-3-1) Conversion marker menu

DEFAULT	O: ZYMKDFLT N: MARKer[<chno>]:CONVert[:MODE] DEFault
LIN MKR	O: ZYMKLIN N: MARKer[<chno>]:CONVert[:MODE] LINear
Re/Im	O: ZYMKRI N: MARKer[<chno>]:CONVert[:MODE] RIMaginary
Return	Calls the marker mode menu. (See step (8-3).)



R3753 SERIES  
NETWORK ANALYZER  
OPERATION MANUAL

A.3 GPIB COMMAND LIST CORRESPONDING TO PANEL KEY / SOFTKEY

(8-3-2) Smith marker menu

LIN MKR	O: SMKRLIN N: MARKer[<chno>]:SMITH MLINear
LOG MKR	O: SMKRLOG N: MARKer[<chno>]:SMITH MLOGarithmic
Re/Im MKR	O: SMKRRRI N: MARKer[<chno>]:SMITH RIMaginary
R + jX MKR	O: SMKRRX N: MARKer[<chno>]:SMITH IMPedance
G + jB MKR	O: SMKRGB N: MARKer[<chno>]:SMITH ADMittance
Z0 VALUE	O: SETZ0 <real> / MKRZ0{50 75} N: CALCulate[<chno>]:TRANSform:IMPedance:CIMPedance <real>
Return	Returns to the marker mode menu. (See step (8-3).)

(8-3-3) Polar marker menu

LIN MKR	O: PMKRLIN N: MARKer[<chno>]:POLar MLINear
LOG MKR	O: PMKRLOG N: MARKer[<chno>]:POLar MLOGarithmic
Re/Im MKR	O: PMKRRI N: MARKer[<chno>]:POLar RIMaginary
Z0 VALUE	O: SETZ0 <real> / MKRZ0{50 75} N: CALCulate[<chno>]:TRANSform:IMPedance:CIMPedance <real>
Return	Returns to the marker mode menu. (See step (8-3).)

**R3753 SERIES  
NETWORK ANALYZER  
OPERATION MANUAL**

**A.3 GPIB COMMAND LIST CORRESPONDING TO PANEL KEY / SOFTKEY**

(9) MKR→  
Marker search menu

MARKER→ START	O: MKRSTAR N: MARKer[<chno>]:LET START
MARKER→ STOP	O: MKRSTOP N: MARKer[<chno>]:LET STOP
MARKER→ CENTER	O: MKRCENT N: MARKer[<chno>]:LET CENTER
MARKER→ SPAN	O: MKRSPAN N: MARKer[<chno>]:LET SPAN
MARKER→ REF.VALUE	O: MKRREF N: MARKer[<chno>]:LET RLEVe1
PART SRCH [            ]	Calls the partial search menu. (See step (9-1).)
MKR SEARCH [            ]	Calls the search menu. (See step (9-2).)

(9-1) Partial search menu

ΔMODE MENU	Calls the delta mode menu. (See step (8-2).)
SET RANGE	O: There is no GPIB command to be applied. N: MARKer[<chno>]:SEARCh:PART1a1:SRANge
PART SRCH ON/OFF	O: MKRPART <boo1> N: MARKer[<chno>]:SEARCh:PART1a1[:STATe] <boo1>
Return	Returns to the marker search menu. (See step (9).)

**R3753 SERIES  
NETWORK ANALYZER  
OPERATION MANUAL**

**A.3 GPIB COMMAND LIST CORRESPONDING TO PANEL KEY / SOFTKEY**

(9-2) Search menu

MKR SEARCH	O: SRCHOFF
OFF	N: MARKer[<chno>]:SEARCh[:MODE] OFF
MAX	O: MAXSRCH
	N: MARKer[<chno>]:SEARCh[:MODE] MAX
MIN	O: MINSRCH
	N: MARKer[<chno>]:SEARCh[:MODE] MIN
TARGET	Calls the target menu. (See step (9-2-1).)
	O: ZRPSRCH (0° SEARCH)
	N: MARKer[<chno>]:SEARCh[:MODE] TARGet
RIPPLE	Calls the ripple menu. (See step (9-2-2).)
	O: DRIPPL1
	N: MARKer[<chno>]:SEARCh[:MODE] RIPPle
FLTR ANAL	Calls the filter analysis menu. (See step (9-2-3).)
TRACKING ON/OFF	O: MKRTRAC <bool>
	N: MARKer[<chno>]:SEARCh:TRACking <bool>
Return	Returns to the marker search menu. (See step (9).)

(9-2-1) Target menu

TARGET VALUE	O: There is no command to be applied.
	N: MARKer[<chno>]:SEARCh:TARGet[:MODE] VALue MARKer[<chno>]:SEARCh:TARGet:VALue <real>
0°	O: ZRPSRCH
	N: MARKer[<chno>]:SEARCh:TARGet[:MODE] ZERO
± 180°	O: There is no command to be applied.
	N: MARKer[<chno>]:SEARCh:TARGet[:MODE] PI
LEFT SEARCH	O: There is no command to be applied.
	N: MARKer[<chno>]:SEARCh:TARGet:LEFT
RIGHT SEARCH	O: There is no command to be applied.
	N: MARKer[<chno>]:SEARCh:TARGet:RIGHT
Return	Returns to the search menu. (See step (9-2).)

A.3 GPIB COMMAND LIST CORRESPONDING TO PANEL KEY / SOFTKEY

(9-2-2) Ripple menu

MAX $\cap$	O: There is no command to be applied. N: MARKer[<chno>]:SEARCh:RIPPLe[:MODE] MAX
MIN $\cup$	O: There is no command to be applied. N: MARKer[<chno>]:SEARCh:RIPPLe[:MODE] MIN
$\Delta$ MAX $\cap$ -MIN $\cup$	O: DRIPPL1 N: MARKer[<chno>]:SEARCh:RIPPLe[:MODE] BOTH
$\Delta$ X	O: DLTx <real> N: MARKer[<chno>]:SEARCh:RIPPLe:DX <real>
$\Delta$ Y	O: DLTy <real> N: MARKer[<chno>]:SEARCh:RIPPLe:DY <real>
Return	Returns to the search menu. (See step (9-2).)

(9-2-3) Filter analysis menu

WIDTH VALUE	O: T{3 6 60}DB/ T{3 6}DEG/ TXDB <real>/ TXDEG <real> N: MARKer[<chno>]:FANalysis:WIDTh <real>
SEARCH IN/OUT	O: TIN/ TOUT N: MARKer[<chno>]:FANalysis:DIRection {IN OUT}
FILTER ANAL ON/OFF	O: FLTANA <bool> N: MARKer[<chno>]:FANalysis[:STATe] <bool>
Return	Returns to the search menu. (See step (9-2).)

The data of filter analysis can be acquired by the following command.

O: TXDB?/ TXDEG?

N: FETCh[<chno>][:MARKer]:FANalysis?

A.3 GPIB COMMAND LIST CORRESPONDING TO PANEL KEY / SOFTKEY

A.3.4 INSTRUMENT STATE Block

- (1) SAVE  
 Save menu

SAVE REGISTER	Calls the save register menu (1 of 2). (See step (1-1).)
CLEAR REGISTER	Calls the clear register menu (1 of 2). (See step (1-2).)
STORE FILE	Calls the store file menu. (See step (1-3).)
PURGE FILE	Calls the purge file menu. (See step (1-4).)
FORMAT DISK	There is no GPIB command to be applied.

- (1-1) Label menu

SAVE REG-1	O: SAVEREG1 N: *SAV 1/ REGISTER:SAVE 1
SAVE REG-2	O: SAVEREG2 N: *SAV 2/ REGISTER:SAVE 2
SAVE REG-3	O: SAVEREG3 N: *SAV 3/ REGISTER:SAVE 3
SAVE REG-4	O: SAVEREG4 N: *SAV 4/ REGISTER:SAVE 4
SAVE REG-5	O: SAVEREG5 N: *SAV 5/ REGISTER:SAVE 5
RENAME REG	There is no GPIB command to be applied.
Return	Returns to the save menu. (See step (1).)
More 1/2	Calls the save register menu (2 of 2).

**R3753 SERIES  
NETWORK ANALYZER  
OPERATION MANUAL**

**A.3 GPIB COMMAND LIST CORRESPONDING TO PANEL KEY / SOFTKEY**

Save register menu (2 of 2)

SAVE REG-6	O: SAVEREG6 N: *SAV 6/ REGister:SAVE 6
SAVE REG-7	O: SAVEREG7 N: *SAV 7/ REGister:SAVE 7
SAVE REG-8	O: SAVEREG8 N: *SAV 8/ REGister:SAVE 8
SAVE REG-9	O: SAVEREG9 N: *SAV 9/ REGister:SAVE 9
SAVE REG-10	O: SAVEREG10 N: *SAV 10/ REGister:SAVE 10
RENAME REG	There is no GPIB command to be applied.
Return	Returns to the save menu. (See step (1).)
More 2/2	Calls the save register menu (2 of 2).

(1-2) Clear register menu (1 of 2)

CLEAR REG-1	O: CLRREG1 N: REGister:CLEar 1
CLEAR REG-2	O: CLRREG2 N: REGister:CLEar 2
CLEAR REG-3	O: CLRREG3 N: REGister:CLEar 3
CLEAR REG-4	O: CLRREG4 N: REGister:CLEar 4
CLEAR REG-5	O: CLRREG5 N: REGister:CLEar 5
Return	Returns to the save menu. (See step (1).)
More 1/2	Calls the clear register menu (2 of 2).

**R3753 SERIES  
NETWORK ANALYZER  
OPERATION MANUAL**

**A.3 GPIB COMMAND LIST CORRESPONDING TO PANEL KEY / SOFTKEY**

Clear register menu (2 of 2)

CLEAR REG-6	O: CLRREG6 N: REGister:CLEar 6
CLEAR REG-7	O: CLRREG7 N: REGister:CLEar 7
CLEAR REG-8	O: CLRREG8 N: REGister:CLEar 8
CLEAR REG-9	O: CLRREG9 N: REGister:CLEar 9
CLEAR REG-10	O: CLRREG10 N: REGister:CLEar 10
Return	Returns to the save menu. (See step (1).)
More 1/2	Calls the clear register menu (1 of 2).

(1-3) Store file menu

STORE	O: STFILE <str> N: FILE:STORe <str>
ROLL ↑	There is no GPIB command to be applied.
ROLL ↓	There is no GPIB command to be applied.
DEFINE STORE	Calls the file data menu. (See step (1-3-1).)
EDIT NAME	There is no GPIB command to be applied.
NAME ↑	There is no GPIB command to be applied.
NAME ↓	There is no GPIB command to be applied.
CANCEL	There is no GPIB command to be applied.

<str> in "STORE" is file name.

**R3753 SERIES  
NETWORK ANALYZER  
OPERATION MANUAL**

**A.3 GPIB COMMAND LIST CORRESPONDING TO PANEL KEY / SOFTKEY**

(1-3-1) File data menu

STATE ON/OFF	O: DSSTATE <bool> N: FILE:STATE:CONDition <bool>
RAY ARRAY ON/OFF	O: RAWARY <bool> N: FILE:STATE:RAW <bool>
CORR COEF ON/OFF	O: CORARY <bool> N: FILE:STATE:CORRection <bool>
DATA ARRAY ON/OFF	O: DATAARY <bool> N: FILE:STATE:DATA <bool>
MEM ARRY ON/OFF	O: MEMARY <bool> N: FILE:STATE:MEMory <bool>
Return	Returns to the save menu. (See step (1).)

(1-4) Purge file menu

PURGE	O: PURGE <str> N: FILE:DELeTe <str>
CURSOR ↑	There is no GPIB command to be applied.
CURSOR ↓	There is no GPIB command to be applied.
Return	Returns to the save menu. (See step (1).)

<str> in "PURGE" is file name.



**R3753 SERIES  
NETWORK ANALYZER  
OPERATION MANUAL**

**A.3 GPIB COMMAND LIST CORRESPONDING TO PANEL KEY / SOFTKEY**

(2) RECALL

Recall menu (1 of 2)

RECALL REG-1	O: RECLREG1 N: *RCL 1/ REGISTER:RECa11 1
RECALL REG-2	O: RECLREG2 N: *RCL 2/ REGISTER:RECa11 2
RECALL REG-3	O: RECLREG3 N: *RCL 3/ REGISTER:RECa11 3
RECALL REG-4	O: RECLREG4 N: *RCL 4/ REGISTER:RECa11 4
RECALL REG-5	O: RECLREG5 N: *RCL 5/ REGISTER:RECa11 5
RECALL POWER OFF	O: RECLPOFF N: *RCL POFF/ REGISTER:RECa11 POFF
LOAD FILE	O: LDFILE <str> N: FILE:LOAD <str>
More 1/2	Calls the recall menu (2 of 2).

<str> in "LOAD FILE" is file name.

Recall menu (2 of 2)

RECALL REG-6	O: RECLREG6 N: *RCL 6/ REGISTER:RECa11 6
RECALL REG-7	O: RECLREG7 N: *RCL 7/ REGISTER:RECa11 7
RECALL REG-8	O: RECLREG8 N: *RCL 8/ REGISTER:RECa11 8
RECALL REG-9	O: RECLREG9 N: *RCL 9/ REGISTER:RECa11 9
RECALL REG-10	O: RECLREG10 N: *RCL 10/ REGISTER:RECa11 10
RECALL POWER OFF	O: RECLPOFF N: *RCL POFF/ REGISTER:RECa11 POFF
LOAD FILE	O: LDFILE <str> N: FILE:LOAD <str>
More 2/2	Calls the recall menu (1 of 2).

<str> in "LOAD FILE" is file name.

(3) SYSTEM

System menu

SYSTEM DRIVE	There is no GPIB command to be applied. See Note.
SET CLOCK	Calls the real time clock menu. (See step (3-1).)

Note: Specify the drive name with the file name as follows:  
 "[drive name:] <file name> "

(3-1) Real time clock menu

YEAR	O: YEAR <int> N: SYSTEM:DATE <year>,<month>,<day>
MONTH	O: MONTH <int> N: SYSTEM:DATE <year>,<month>,<day>
DAY	O: DAY <int> N: SYSTEM:DATE <year>,<month>,<day>
HOUR	O: HOUR <int> N: SYSTEM:TIME <hour>,<minute>,<second>
MINUTE	O: MINUTE <int> N: SYSTEM:TIME <hour>,<minute>,<second>
SECOND	O: SECOND <int> N: SYSTEM:TIME <hour>,<minute>,<second>
Return	Returns to the system menu. (See step (3).)

**R3753 SERIES  
NETWORK ANALYZER  
OPERATION MANUAL**

---

**A.3 GPIB COMMAND LIST CORRESPONDING TO PANEL KEY / SOFTKEY**

(4) PRESET

**PRESET**

O: IP

N: SYSTem:PRESet

A.3.5 GPIB Block

(1) PROGRAM

**PROGRAM**

There is no GPIB command to be applied to the following menus which are called by this key.

- Controller menu
- Load menu
- Drive menu

R3753 SERIES  
NETWORK ANALYZER  
OPERATION MANUAL

A.3 GPIB COMMAND LIST CORRESPONDING TO PANEL KEY / SOFTKEY

(2) REMOTE/LCL  
GPIB menu

SYSTEM CONTROLLER	There is no GPIB command to be applied.
TALKER LISTENER	There is no GPIB command to be applied.
SET ADDRESSES	Calls the address menu. (See step (2-1).)

(2-1) Address menu

ADDRESS R3753	There is no GPIB command to be applied.
ADDRESS PLOTTER	There is no GPIB command to be applied.
ADDRESS PRINTER	There is no GPIB command to be applied.
Return	Returns to the GPIB menu. (See step (2).)

## ALPHABETICAL INDEX

<b>[A]</b>		<b>[E]</b>	
About R3753 .....	1-1	EASY USAGE .....	3-1
ACTIVE CHANNEL block .....	3-2	Editing Segment of	
	4-2	Program Sweep .....	4-73
	A-16	Editing Segment of	
ATT .....	A-6	Program Sweep .....	4-60
Averaging/Smoothing and Resolution		Editing Segment of User Frequency	
Bandwidth .....	4-21	Sweep .....	4-59
AVG .....	A-6	ENTRY block .....	3-3
			4-3
<b>[B]</b>		ERROR MESSAGES .....	7-1
Basic Operation .....	3-1	Example of Basic Key Operation .....	3-10
		Exchange of power fuse .....	1-5
<b>[C]</b>		Executing Recall .....	4-77
CAL .....	A-7	Executing Save Register .....	4-70
Calibration .....	4-26	Executing Store File .....	4-72
Calibration Data Clear .....	4-39	Extending Measurement Reference	
Calibration Method .....	4-29	Surface .....	4-33
Caution of System-up .....	1-9		
Cautions in Adding a Signal Exceeding		<b>[F]</b>	
Available Levels to the Input Part .....	1-9	FET Probe .....	1-8
Cautions in Setting Up an		FORMAT .....	A-5
Output Power .....	1-10	Frequency Accuracy and Range .....	5-3
Cleaning, Storage, and		Front Panel Descriptions .....	2-2
Transportation .....	1-10	Front panel key .....	3-2
Communication with			
Peripheral Devices .....	4-88	<b>[G]</b>	
Connection of power cable .....	1-6	GPIB block .....	3-8
Controller Menu .....	4-67		4-66
COPY .....	A-12		A-47
		GPIB Menu .....	4-68
<b>[D]</b>			
Data Flowchart .....	1-3	<b>[H]</b>	
Deleting Save Register .....	4-76	Hard Copy .....	4-81
Deleting Store File .....	4-77	Hardware Trouble .....	7-1
Delta Section Marker Analysis .....	3-63		
Delta-Marker Function .....	4-45		
DISPLAY .....	A-6		
Display Data Format .....	4-13		
Displaying Marker Read out Value .....	4-44		

<b>[I]</b>		Measurement with Multi-marker . . . . .	3-55
Initial Setting . . . . .	A-1	MENU . . . . .	A-4
Installation . . . . .	1-4	MKR . . . . .	A-8
INSTRUMENT STATE block . . . . .	3-7	MKR → . . . . .	A-9
	4-63		
	A-41	<b>[N]</b>	
Interlocking between Channels . . . . .	4-8	Necessary Key for Basic Operation . . . . .	3-1
Interpolation Between Measurement . . . . .	4-44	Normalizing . . . . .	4-26
		Notes on Use . . . . .	1-11
<b>[L]</b>		Notes on use of Parallel I/O Port . . . . .	1-9
Label input . . . . .	4-19	Notes on use of Serial I/O ports . . . . .	1-9
LCL . . . . .	A-14	Notice of Hardware Information . . . . .	7-2
List of Softkey Menu . . . . .	A-4	Notice of Operating Completion, State, etc. . . . .	7-10
<b>[M]</b>		<b>[O]</b>	
Marker Function . . . . .	4-40	1 Parallel I/O Port . . . . .	4-88
Marker Analysis Function . . . . .	4-51	One Port Full Calibration . . . . .	4-27
Marker Coupling between Channels . . . . .	4-43	Operating Error . . . . .	7-3
Marker Menu during Impedance Measurement . . . . .	4-49	OPERATION METHOD . . . . .	4-1
MEAS . . . . .	A-5	Operations . . . . .	1-2
Measurement by Marker of → . . . . .	3-69	Output Level Accuracy and Flatness . . . . .	5-4
Measurement Example . . . . .	3-14	Output Level Linearity . . . . .	5-6
Measurement for Dual-screen to be Displayed Simultaneously . . . . .	3-34	Output of Measured Data to Plotter . . . . .	3-87
Measurement in which Use of Program Sweep . . . . .	3-75	Overloading an Input Part . . . . .	7-2
Measurement of Amplitude and Group Delay . . . . .	3-28		
Measurement of Amplitude and Phase . . . . .	3-26	<b>[P]</b>	
Measurement of Crystal Resonator . . . . .	3-49	PANEL DESCRIPTION . . . . .	2-1
Measurement of Filter . . . . .	3-15	PERFORMANCE TEST . . . . .	5-1
Measurement of Group Delay . . . . .	3-20	Phase Measurement . . . . .	3-18
Measurement of Linear Amplitude and Phase . . . . .	3-31	Plotter Setup . . . . .	4-85
Measurement of Reflection . . . . .	3-38	Power Cable . . . . .	1-5
Measurement of Resonance Point and Antiresonance Point of Ceramic Oscillation Element (f = 42.0MHz) . . . . .	3-81	Preparing for Performance Test . . . . .	5-1
Measurement with Coupling of Marker Interpolation Marker . . . . .	3-72	Product Outline . . . . .	1-1
Measurement with Delta Marker . . . . .	3-59		
		<b>[R]</b>	
		Rear Panel Descriptions . . . . .	2-7
		RECALL . . . . .	A-11
		RESPONSE block . . . . .	3-6
		RESPONSE Block . . . . .	4-9
			A-21
		RS-232 . . . . .	4-97
		RUN . . . . .	A-14

[S]

SAVE .....	A-10
Save/Recall .....	4-69
SCALE .....	A-5
Screen Display Descriptions .....	2-5
Selection of Save Type .....	4-69
Setting Display Coordinate Scale .....	4-15
Setting File Name .....	4-75
Setting Input and Parameter Conversion .....	4-10
Setting Marker .....	4-41
Setting Plot Data .....	4-83
Setting Plot Scale .....	4-82
Setting Signal Source .....	4-6
Setting Sweep Type .....	4-58
Selecting Input Attenuator and Input Impedance .....	4-24
Software key .....	3-9
SPECIFICATIONS .....	6-1
Specifying Pen .....	4-84
Split-Screen Display and Selection of Display information .....	4-16
STIMULUS block .....	3-5
.....	4-5
Storage and Reproduction of Measured Data .....	3-94
Storage/Reproduction of Measured Data (Saving and Recall Register) .....	3-91
Sweep .....	4-57
Sweep Measurement of Narrow-band and Wide-band .....	3-22
SYSTEM .....	A-13
System Menu .....	4-64

[T]

The power requirement .....	1-5
TRACE Operation .....	4-18

[W]

Warning of Internal Set, Change, etc. ....	7-8
---	-----

.....

.....





.....

.....









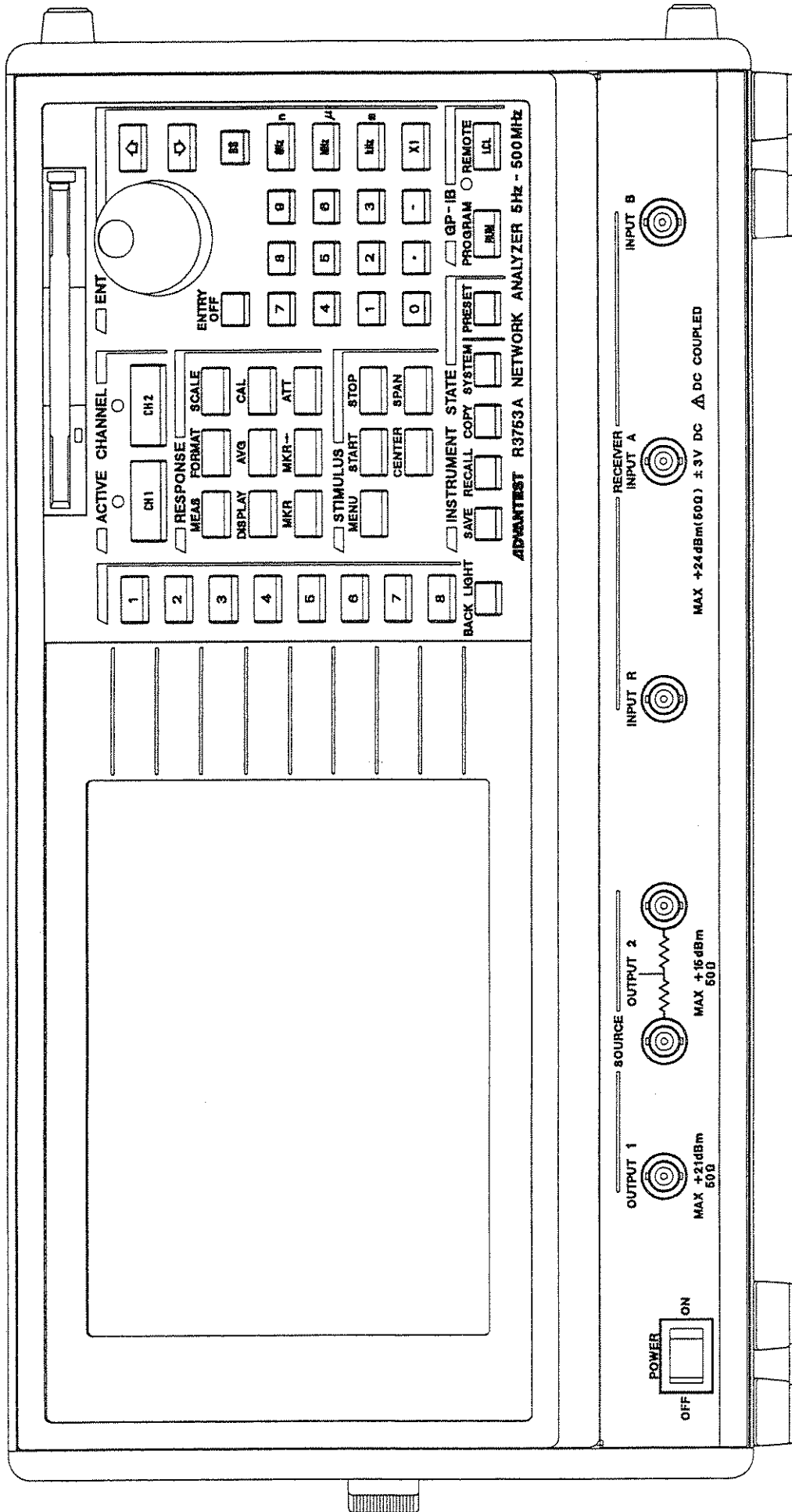

# R3753A FRONT VIEW





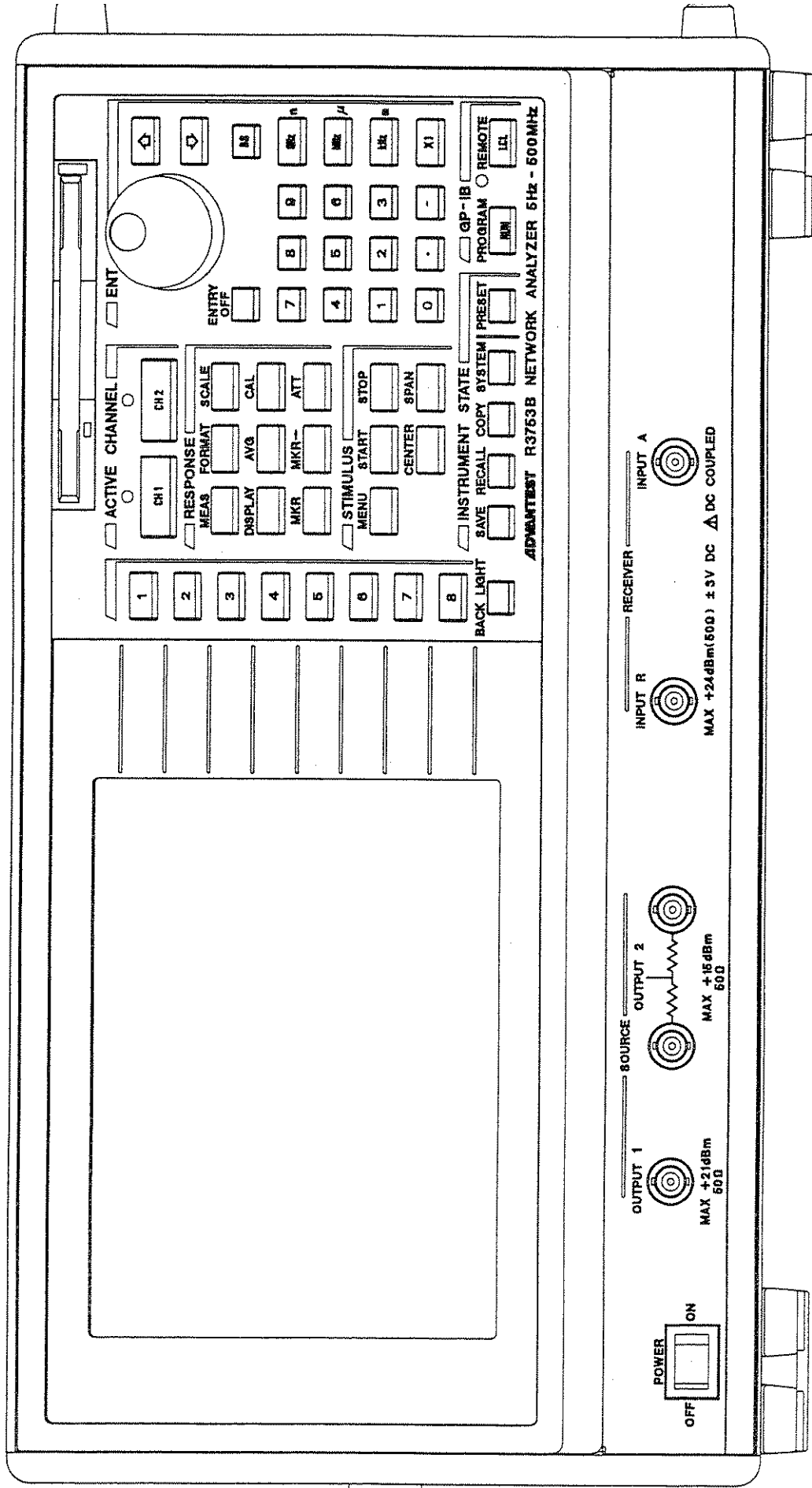

# R3753B FRONT VIEW



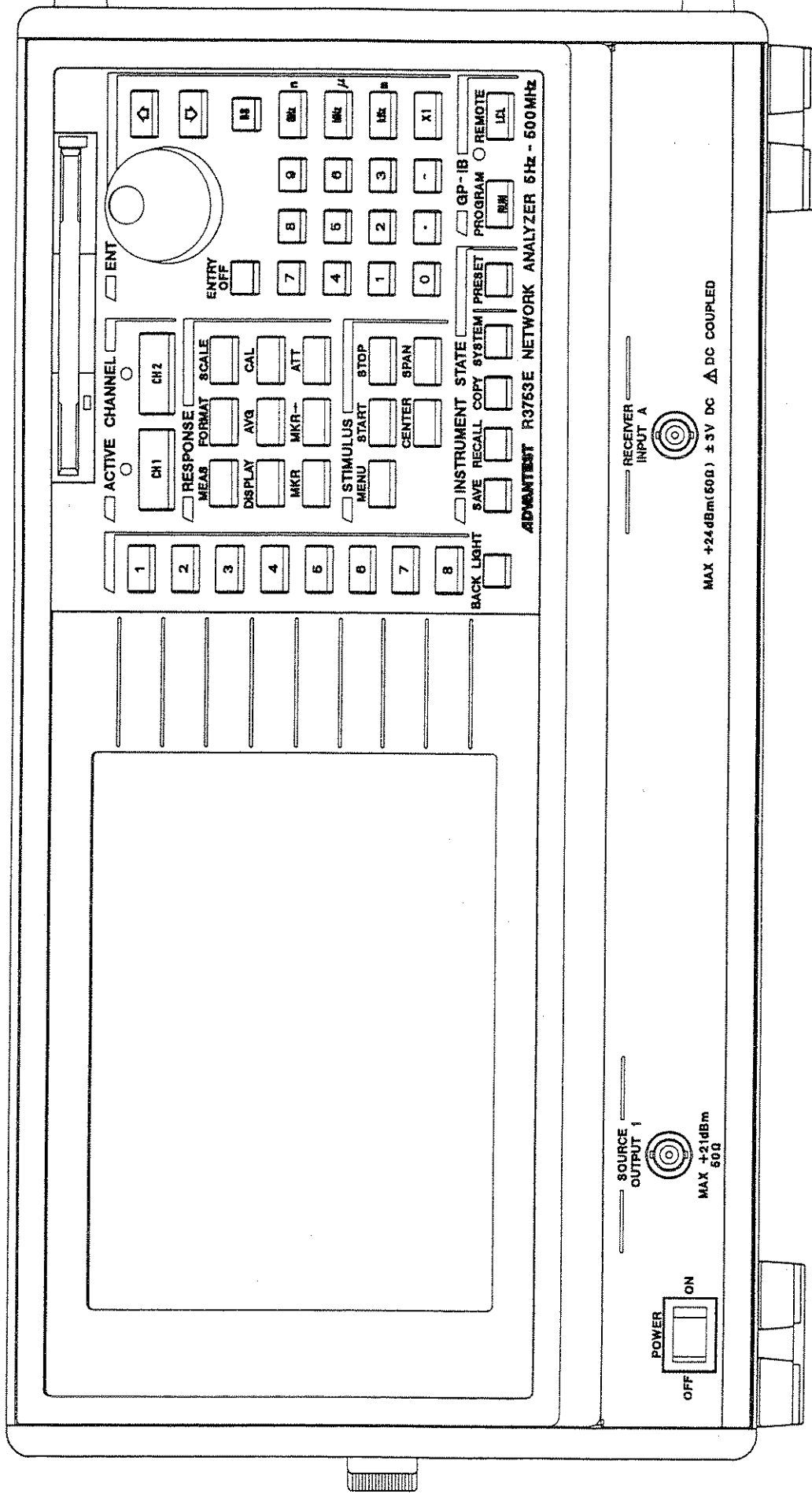

# R3753E FRONT VIEW



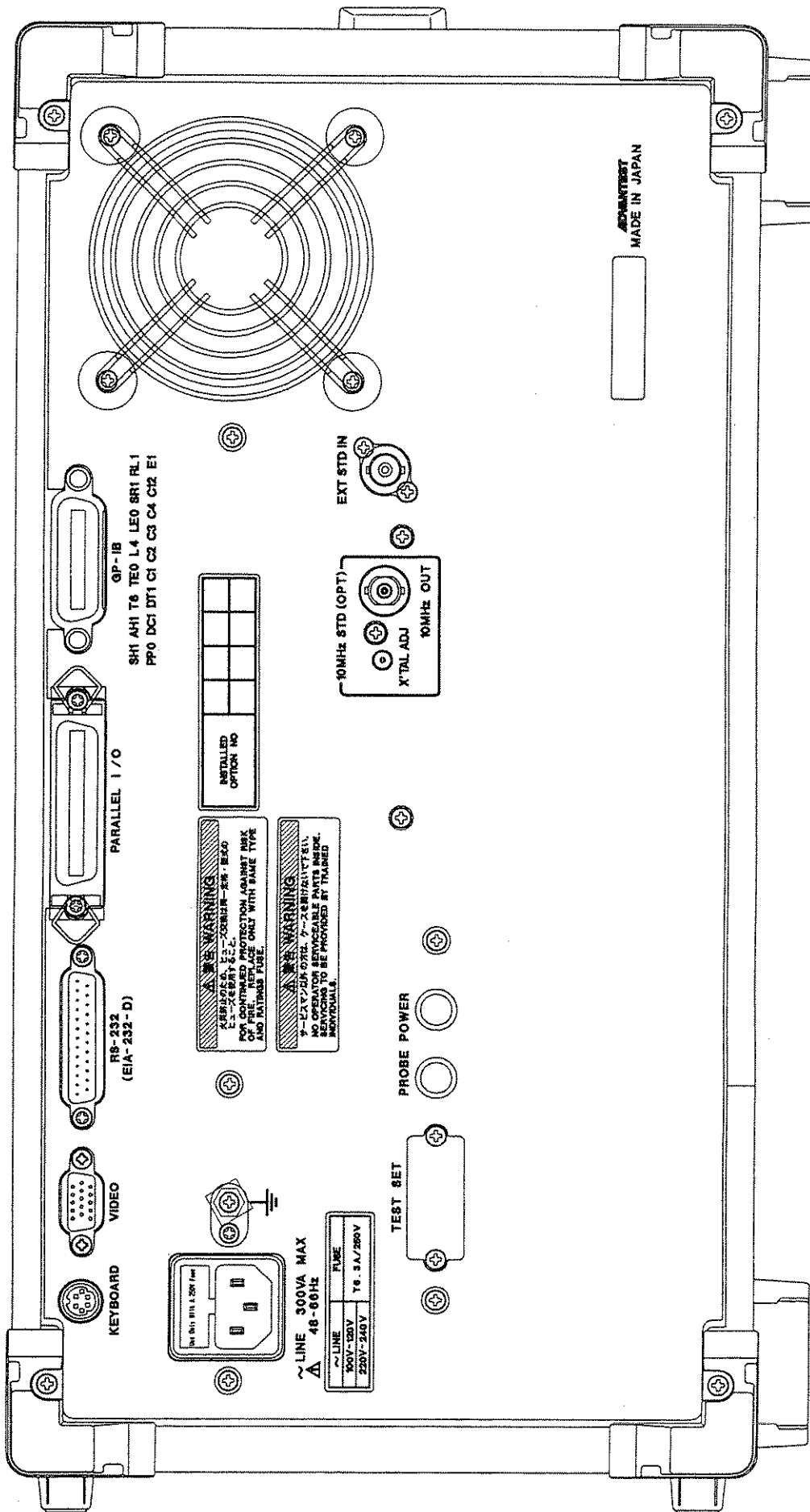

# R3753A/B/E REAR VIEW



# IMPORTANT INFORMATION FOR ADVANTEST SOFTWARE

PLEASE READ CAREFULLY: This is an important notice for the software defined herein. Computer programs including any additions, modifications and updates thereof, operation manuals, and related materials provided by ADVANTEST (hereafter referred to as "SOFTWARE"), included in or used with hardware produced by ADVANTEST (hereafter referred to as "PRODUCTS").

## SOFTWARE License

All rights in and to the SOFTWARE (including, but not limited to, copyright) shall be and remain vested in ADVANTEST. ADVANTEST hereby grants you a license to use the SOFTWARE only on or with ADVANTEST PRODUCTS.

## Restrictions

- (1) You may not use the SOFTWARE for any purpose other than for the use of the PRODUCTS.
- (2) You may not copy, modify, or change, all or any part of, the SOFTWARE without permission from ADVANTEST.
- (3) You may not reverse engineer, de-compile, or disassemble, all or any part of, the SOFTWARE.

## Liability

ADVANTEST shall have no liability (1) for any PRODUCT failures, which may arise out of any misuse (misuse is deemed to be use of the SOFTWARE for purposes other than it's intended use) of the SOFTWARE. (2) For any dispute between you and any third party for any reason whatsoever including, but not limited to, infringement of intellectual property rights.

# LIMITED WARRANTY

1. Unless otherwise specifically agreed by Seller and Purchaser in writing, ADVANTEST will warrant to the Purchaser that during the Warranty Period this Product (other than consumables included in the Product) will be free from defects in material and workmanship and shall conform to the specifications set forth in this Operation Manual.
2. The warranty period for the Product (the "Warranty Period") will be a period of one year commencing on the delivery date of the Product.
3. If the Product is found to be defective during the Warranty Period, ADVANTEST will, at its option and in its sole and absolute discretion, either (a) repair the defective Product or part or component thereof or (b) replace the defective Product or part or component thereof, in either case at ADVANTEST's sole cost and expense.
4. This limited warranty will not apply to defects or damage to the Product or any part or component thereof resulting from any of the following:
  - (a) any modifications, maintenance or repairs other than modifications, maintenance or repairs (i) performed by ADVANTEST or (ii) specifically recommended or authorized by ADVANTEST and performed in accordance with ADVANTEST's instructions;
  - (b) any improper or inadequate handling, carriage or storage of the Product by the Purchaser or any third party (other than ADVANTEST or its agents);
  - (c) use of the Product under operating conditions or environments different than those specified in the Operation Manual or recommended by ADVANTEST, including, without limitation, (i) instances where the Product has been subjected to physical stress or electrical voltage exceeding the permissible range and (ii) instances where the corrosion of electrical circuits or other deterioration was accelerated by exposure to corrosive gases or dusty environments;
  - (d) use of the Product in connection with software, interfaces, products or parts other than software, interfaces, products or parts supplied or recommended by ADVANTEST;
  - (e) the occurrence of an event of force majeure, including, without limitation, fire, explosion, geological change, storm, flood, earthquake, tidal wave, lightning or act of war; or
  - (f) any negligent act or omission of the Purchaser or any third party other than ADVANTEST.
5. **EXCEPT TO THE EXTENT EXPRESSLY PROVIDED HEREIN, ADVANTEST HEREBY EXPRESSLY DISCLAIMS, AND THE PURCHASER HEREBY WAIVES, ALL WARRANTIES, WHETHER EXPRESS OR IMPLIED, STATUTORY OR OTHERWISE, INCLUDING, WITHOUT LIMITATION, (A) ANY WARRANTY OF MERCHANTABILITY OR FITNESS FOR A PARTICULAR PURPOSE AND (B) ANY WARRANTY OR REPRESENTATION AS TO THE VALIDITY, SCOPE, EFFECTIVENESS OR USEFULNESS OF ANY TECHNOLOGY OR ANY INVENTION.**
6. **THE REMEDY SET FORTH HEREIN SHALL BE THE SOLE AND EXCLUSIVE REMEDY OF THE PURCHASER FOR BREACH OF WARRANTY WITH RESPECT TO THE PRODUCT.**
7. **ADVANTEST WILL NOT HAVE ANY LIABILITY TO THE PURCHASER FOR ANY INDIRECT, INCIDENTAL, SPECIAL, CONSEQUENTIAL OR PUNITIVE DAMAGES, INCLUDING, WITHOUT LIMITATION, LOSS OF ANTICIPATED PROFITS OR REVENUES, IN ANY AND ALL CIRCUMSTANCES, EVEN IF ADVANTEST HAS BEEN ADVISED OF THE POSSIBILITY OF SUCH DAMAGES AND WHETHER ARISING OUT OF BREACH OF CONTRACT, WARRANTY, TORT (INCLUDING, WITHOUT LIMITATION, NEGLIGENCE), STRICT LIABILITY, INDEMNITY, CONTRIBUTION OR OTHERWISE.**



## **CUSTOMER SERVICE DESCRIPTION**

In order to maintain safe and trouble-free operation of the Product and to prevent the incurrence of unnecessary costs and expenses, ADVANTEST recommends a regular preventive maintenance program under its maintenance agreement.

ADVANTEST's maintenance agreement provides the Purchaser on-site and off-site maintenance, parts, maintenance machinery, regular inspections, and telephone support and will last a maximum of ten years from the date the delivery of the Product. For specific details of the services provided under the maintenance agreement, please contact the nearest ADVANTEST office listed at the end of this Operation Manual or ADVANTEST's sales representatives.

Some of the components and parts of this Product have a limited operating life (such as, electrical and mechanical parts, fan motors, unit power supply, etc.). Accordingly, these components and parts will have to be replaced on a periodic basis. If the operating life of a component or part has expired and such component or part has not been replaced, there is a possibility that the Product will not perform properly. Additionally, if the operating life of a component or part has expired and continued use of such component or part damages the Product, the Product may not be repairable. Please contact the nearest ADVANTEST office listed at the end of this Operation Manual or ADVANTEST's sales representatives to determine the operating life of a specific component or part, as the operating life may vary depending on various factors such as operating condition and usage environment.

### **CLAIM FOR DAMAGE IN SHIPMENT TO ORIGINAL BUYER**

The product should be thoroughly inspected immediately upon original delivery to buyer. All material in the container should be checked against the enclosed packing list or the instruction manual alternatively. ADVANTEST will not be responsible for shortage unless notified immediately.

If the product is damaged in any way, a claim should be filed by the buyer with carrier immediately. (To obtain a quotation to repair shipment damage, contact ADVANTEST or the local supplier.) Final claim and negotiations with the carrier must be completed by buyer.

# SALES & SUPPORT OFFICES

## Advantest America, Inc.(North America)

New Jersey Office

258 Fernwood Avenue Edison, NJ 08837, U.S.A.

Phone: +1-732-346-2600 Facsimile: +1-732-346-2610

## Advantest Taiwan Inc. (Taiwan)

No.1 Alley 17, Lane 62, Chung-Ho Street,

Chu-Pei, Hsin-Chu Hsien, Taiwan R.O.C. 302

Phone: +886-3-5532111 Facsimile: +886-3-5541168

## Advantest (Singapore) Pte. Ltd. (Singapore)

438A Alexandra Road, #08-03/06

Alexandra Technopark Singapore 119967

Phone: +65-6274-3100 Facsimile: +65-6274-4055

## Advantest Korea Co., Ltd. (Korea)

22BF, Kyobo KangNam Tower, 1303-22,

Seocho-Dong, Seocho-Ku, Seoul #137-070, Korea

Phone: +82-2-532-7071 Facsimile: +82-2-532-7132

## Advantest (Suzhou) Co., Ltd. (China)

Shanghai Branch Office

5F, No.46 Section Factory Building, No.555 Gui Ping Road,

Caohejing, Hi-Tech Area, Shanghai, China 200233

Phone: +86-21-6485-2725 Facsimile: +86-21-6485-2726

Beijing Branch Office

406/F, Ying Building, Quantum Plaza, No. 23 Zhi Chun Road,

Hai Dian District, Beijing, China 100083

Phone: +86-10-8235-3377 Facsimile: +86-10-8235-6717

## ROHDE & SCHWARZ Europe GmbH (Europe)

Mühlendorfstraße 15

D-81671 München, Germany

(P.O.B. 80 14 60

D-81614 München, Germany)

Phone: +49-89-4129-13711

Facsimile:+49-89-4129-13723

Technology Support on the Leading Edge

# ADVANTEST®

## ADVANTEST CORPORATION

Shin-Marunouchi Center Building, 1-6-2 Marunouchi, Chiyoda-ku, Tokyo 100-0005, Japan