

---

---

**ADVANTEST<sup>®</sup>**  
ADVANTEST CORPORATION

---

***R3132 Series***  
***Spectrum Analyzer***  
***Operation Manual***

MANUAL NUMBER FOE-8335156H00

---

***Applicable models***

***R3132***  
***R3132N***  
***R3162***  
***R3172***  
***R3182***



## Safety Summary

To ensure thorough understanding of all functions and to ensure efficient use of this instrument, please read the manual carefully before using. Note that Advantest bears absolutely no responsibility for the result of operations caused due to incorrect or inappropriate use of this instrument.

If the equipment is used in a manner not specified by Advantest, the protection provided by the equipment may be impaired.

- **Warning Labels**

Warning labels are applied to Advantest products in locations where specific dangers exist. Pay careful attention to these labels during handling. Do not remove or tear these labels. If you have any questions regarding warning labels, please ask your nearest Advantest dealer. Our address and phone number are listed at the end of this manual.

Symbols of those warning labels are shown below together with their meaning.

**DANGER:** Indicates an imminently hazardous situation which will result in death or serious personal injury.

**WARNING:** Indicates a potentially hazardous situation which will result in death or serious personal injury.

**CAUTION:** Indicates a potentially hazardous situation which will result in personal injury or a damage to property including the product.

- **Basic Precautions**

Please observe the following precautions to prevent fire, burn, electric shock, and personal injury.

- Use a power cable rated for the voltage in question. Be sure however to use a power cable conforming to safety standards of your nation when using a product overseas.
- When inserting the plug into the electrical outlet, first turn the power switch OFF and then insert the plug as far as it will go.
- When removing the plug from the electrical outlet, first turn the power switch OFF and then pull it out by gripping the plug. Do not pull on the power cable itself. Make sure your hands are dry at this time.
- Before turning on the power, be sure to check that the supply voltage matches the voltage requirements of the instrument.
- Connect the power cable to a power outlet that is connected to a protected ground terminal. Grounding will be defeated if you use an extension cord which does not include a protected ground terminal.
- Be sure to use fuses rated for the voltage in question.
- Do not use this instrument with the case open.
- Do not place anything on the product and do not apply excessive pressure to the product. Also, do not place flower pots or other containers containing liquid such as chemicals near this

product.

- When the product has ventilation outlets, do not stick or drop metal or easily flammable objects into the ventilation outlets.
- When using the product on a cart, fix it with belts to avoid its drop.
- When connecting the product to peripheral equipment, turn the power off.

- **Caution Symbols Used Within this Manual**

Symbols indicating items requiring caution which are used in this manual are shown below together with their meaning.

**DANGER:** Indicates an item where there is a danger of serious personal injury (death or serious injury).

**WARNING:** Indicates an item relating to personal safety or health.

**CAUTION:** Indicates an item relating to possible damage to the product or instrument or relating to a restriction on operation.

- **Safety Marks on the Product**

The following safety marks can be found on Advantest products.



: ATTENTION - Refer to manual.



: Protective ground (earth) terminal.



: DANGER - High voltage.



: CAUTION - Risk of electric shock.

- **Replacing Parts with Limited Life**

The following parts used in the instrument are main parts with limited life.

Replace the parts listed below before their expected lifespan has expired to maintain the performance and function of the instrument.

Note that the estimated lifespan for the parts listed below may be shortened by factors such as the environment where the instrument is stored or used, and how often the instrument is used.

The parts inside are not user-replaceable. For a part replacement, please contact the Advantest sales office for servicing.

Each product may use parts with limited life.

For more information, refer to the section in this document where the parts with limited life are described.

## Main Parts with Limited Life

Part name	Life
Unit power supply	5 years
Fan motor	5 years
Electrolytic capacitor	5 years
LCD display	6 years
LCD backlight	2.5 years
Floppy disk drive	5 years
Memory backup battery	5 years

- **Hard Disk Mounted Products**

The operational warnings are listed below.

- Do not move, shock and vibrate the product while the power is turned on.  
Reading or writing data in the hard disk unit is performed with the memory disk turning at a high speed. It is a very delicate process.
- Store and operate the products under the following environmental conditions.  
An area with no sudden temperature changes.  
An area away from shock or vibrations.  
An area free from moisture, dirt, or dust.  
An area away from magnets or an instrument which generates a magnetic field.
- Make back-ups of important data.  
The data stored in the disk may become damaged if the product is mishandled. The hard disc has a limited life span which depends on the operational conditions. Note that there is no guarantee for any loss of data.

- **Precautions when Disposing of this Instrument**

When disposing of harmful substances, be sure dispose of them properly with abiding by the state-provided law.

Harmful substances: (1) PCB (polycarbon biphenyl)  
(2) Mercury  
(3) Ni-Cd (nickel cadmium)  
(4) Other  
Items possessing cyan, organic phosphorous and hexadic chromium and items which may leak cadmium or arsenic (excluding lead in solder).

Example: fluorescent tubes, batteries

---

# Environmental Conditions

This instrument should be only be used in an area which satisfies the following conditions:

- An area free from corrosive gas
- An area away from direct sunlight
- A dust-free area
- An area free from vibrations
- Altitude of up to 2000 m

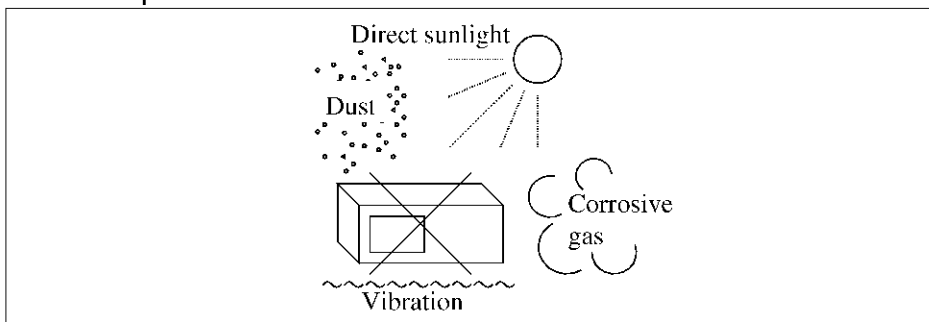

**Figure-1 Environmental Conditions**

- Operating position

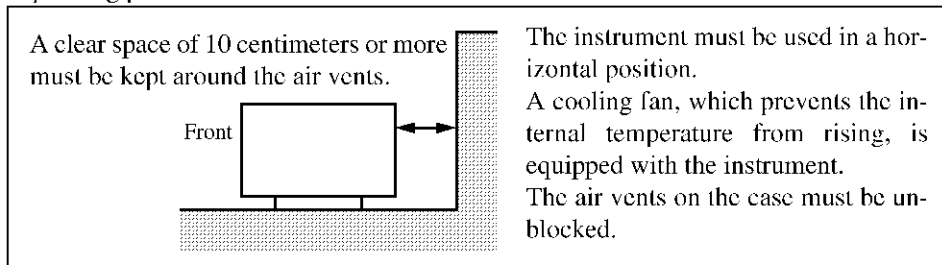

**Figure-2 Operating Position**

- Storage position

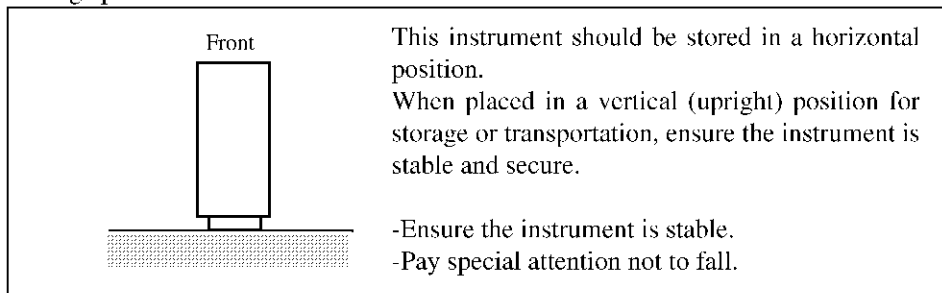

**Figure-3 Storage Position**

- The classification of the transient over-voltage, which exists typically in the main power supply, and the pollution degree is defined by IEC61010-1 and described below.

Impulse withstand voltage (over-voltage) category II defined by IEC60364-4-443

Pollution Degree 2

## Types of Power Cable

Replace any references to the power cable type, according to the following table, with the appropriate power cable type for your country.

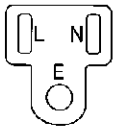
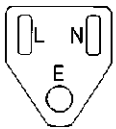
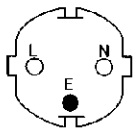
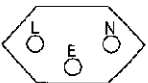
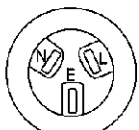
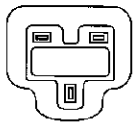
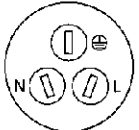
Plug configuration	Standards	Rating, color and length	Model number (Option number)
	PSE: Japan  Electrical Appliance and Material Safety Law	125 V at 7 A Black 2 m (6 ft)	Straight: A01402  Angled: A01412
	UL: United States of America  CSA: Canada	125 V at 7 A Black 2 m (6 ft)	Straight: A01403 (Option 95)  Angled: A01413
	CEE: Europe DEMKO: Denmark NEMKO: Norway VDE: Germany KEMA: The Netherlands CEBEC: Belgium OVE: Austria FIMKO: Finland SEMKO: Sweden	250 V at 6 A Gray 2 m (6 ft)	Straight: A01404 (Option 96)  Angled: A01414
	SEV: Switzerland	250 V at 6 A Gray 2 m (6 ft)	Straight: A01405 (Option 97)  Angled: A01415
	SAA: Australia, New Zealand	250 V at 6 A Gray 2 m (6 ft)	Straight: A01406 (Option 98)  Angled: -----
	BS: United Kingdom	250 V at 6 A Black 2 m (6 ft)	Straight: A01407 (Option 99)  Angled: A01417
	CCC: China	250 V at 10 A Black 2 m (6 ft)	Straight: A114009 (Option 94)  Angled: A114109





## CAUTIONS

The front two feet beneath the front panel have small extensions which can be used to provide a better viewing angle (12-degree tilt).

Note the following when using the extensions:

- Use the analyzer on flat surfaces so that the weight of the analyzer is evenly distributed.
- Do not put any objects on the analyzer.
- Do not lean on the analyzer.
- Do not place anything (hands or other objects) under the analyzer.
- Do not slide the analyzer.
- Do not use excessive force when pressing keys (more than 1 kg).

Make sure the extensions are folded shut when:

- Transporting the analyzer.
- Connecting or disconnecting cables.
- Using the analyzer on a cart.
- The analyzer is not in use.
- The analyzer is in storage.

Do not use the extensible feet if they show signs of excessive wear.

- The extensions may wear out over time. If this occurs, contact ADVANTEST or our service agency for information on how to replace them.



# Certificate of Conformity



This is to certify, that

**Spectrum Analyzer**

---

**R3132 Series**

---

instrument, type, designation

complies with the provisions of the EMC Directive 89/336/EEC in accordance with EN61326 and Low Voltage Directive 73/23/EEC in accordance with EN61010.

**ADVANTEST Corp.**

Tokyo, Japan

**ROHDE&SCHWARZ**

Engineering and Sales GmbH

Munich, Germany

3132.03



## PREFACE

This manual provides the information necessary to check functionality, operate and program the R3132 Series Spectrum Analyzer. Be sure to read this manual carefully in order to use the spectrum analyzer safely.

- Organization of this manual

This manual consists of the following chapters:

<p><b>1. INTRODUCTION</b></p> <ul style="list-style-type: none"> <li>• Product Description</li> <li>• Accessories</li> <li>• Options</li> <li>• Operating Environment</li> <li>• System Checkout</li> <li>• Cleaning, Storing and Transporting the R3132 Series Spectrum Analyzer</li> <li>• Calibration</li> <li>• Replacing Parts with Limited Life</li> </ul>	<p>Includes a description of the spectrum analyzer and its' parts along with information on its' operating environment and how to perform a system checkout.</p>
<p><b>2. OPERATION</b></p> <ul style="list-style-type: none"> <li>• Panel Description</li> <li>• Basic Operation</li> <li>• Measurement Examples</li> <li>• Other Functions</li> </ul>	<p>Describes the names and the functions of each part on the panels. You can learn the basic operation of the spectrum analyzer through the examples shown in this chapter.</p>
<p><b>3. REFERENCE</b></p> <ul style="list-style-type: none"> <li>• Menu Index</li> <li>• Menu Map</li> <li>• Menu Function Descriptions</li> <li>• List of Settings</li> </ul>	<p>Shows a list of operation keys, and describes the function of each key.</p>
<p><b>4. REMOTE PROGRAMMING</b></p> <ul style="list-style-type: none"> <li>• GPIB Command Index</li> <li>• GPIB Remote Programming</li> <li>• RS-232 Remote Control Function</li> </ul>	<p>Gives an outline of the GPIB and RS-232 interfaces, and how to connect and set them up. Also included are a list of commands necessary for programming and using the program examples.</p>
<p><b>5. PERFORMANCE VERIFICATION</b></p> <ul style="list-style-type: none"> <li>• General</li> <li>• Procedures of Performance Verification</li> <li>• Tracking Generator Performance Verification Procedure</li> <li>• Performance Verification for OPT73 (FM Demodulation)</li> <li>• Performance Verification Record Sheet</li> </ul>	<p>Describes the performance verification.</p>
<p><b>6. PERFORMANCE VERIFICATION (External Mixer)</b></p> <ul style="list-style-type: none"> <li>• External Mixer OPT16</li> <li>• External Mixer OPT17</li> <li>• External Mixer OPT18</li> <li>• External Mixer OPT19</li> </ul>	<p>Describes the performance verification(External Mixer).</p>

---

7. SPECIFICATIONS

- R3132 Specifications
- R3132N Specifications
- R3162 Specifications
- R3172 Specifications
- R3182 Specifications
- Options

Shows the specifications of the spectrum analyzer.

---

- Key notations in this manual  
Typeface conventions used in this manual.

Panel keys: In bold type

Example: **MKR, MEAS**

Soft keys: In bold and italic type

Example: ***Normal, Noise/Hz***

The ***1/2, more*** and ***2/2, more*** soft keys are designated by ***1/2\_more*** and ***2/2\_more*** in this manual.

## TABLE OF CONTENTS

1	INTRODUCTION .....	1-1
1.1	Product Description .....	1-1
1.2	Accessories .....	1-3
1.3	Options .....	1-5
1.4	Operating Environment .....	1-6
1.4.1	Environmental Conditions .....	1-6
1.4.2	Power Requirements .....	1-7
1.4.3	Power Fuse .....	1-7
1.4.4	Power Cable .....	1-9
1.5	System Checkout .....	1-10
1.6	Cleaning, Storing and Transporting the R3132 Series Spectrum Analyzer .....	1-13
1.6.1	Cleaning .....	1-13
1.6.2	Storing .....	1-14
1.6.3	Transporting .....	1-14
1.7	Calibration .....	1-15
1.8	Replacing Parts with Limited Life .....	1-15
2	OPERATION .....	2-1
2.1	Panel Description .....	2-1
2.1.1	Front Panel .....	2-1
2.1.2	Screen Annotation .....	2-12
2.1.3	Rear Panel .....	2-14
2.2	Basic Operation .....	2-16
2.2.1	Operating Menus and Entering Data .....	2-16
2.2.2	Displaying Spectrums and Operating the Markers .....	2-19
2.2.3	Measuring Window and the Display Line .....	2-24
2.2.4	Measuring Frequency Using Counter .....	2-27
2.2.5	Auto Tuning .....	2-29
2.2.6	Tracking Operations .....	2-31
2.2.7	UNCAL Message .....	2-33
2.2.8	Separating Two Signals .....	2-35
2.2.9	Measuring low level signals .....	2-38
2.2.10	Input Saturation .....	2-42
2.2.11	Harmonic Distortion .....	2-44
2.2.12	Intermodulation .....	2-46
2.2.13	Calibration .....	2-49
2.2.14	Entering User-definable Antenna Correction Data .....	2-49
2.2.15	External Mixer (OPT16 thru OPT19) .....	2-52
2.3	Measurement Examples .....	2-55
2.3.1	Measuring the Channel Power .....	2-55
2.3.2	Measuring the Occupied Bandwidth (OBW) .....	2-58

## Table of Contents

2.3.3	Measuring Adjacent Channel Leakage Power (ACP) .....	2-61
2.3.3.1	Full Screen Mode .....	2-61
2.3.3.2	SEPARATE Display .....	2-67
2.3.4	Measuring Burst Signals Using the Gated Sweep .....	2-71
2.3.5	Measuring Burst Signals in the Time Domain .....	2-75
2.3.6	Pass/Fail Judgments Using the Limit line Function .....	2-79
2.3.7	Measurements Using TG (OPT74) .....	2-85
2.3.8	Spectrum Mask Measurement .....	2-89
2.3.9	Measuring Output Levels Using the Software Image Suppression function (OPT16 thru OPT19) .....	2-94
2.3.10	FM Demodulation Function (OPT73) .....	2-97
2.4	Other Functions .....	2-104
2.4.1	Using Floppy Disks .....	2-104
2.4.2	Saving or Recalling Data .....	2-107
2.4.3	Outputting Screen Data .....	2-115
2.4.4	Setting Date and Time .....	2-118
2.4.5	Setting the Screen Title .....	2-119
3	REFERENCE .....	3-1
3.1	Menu Index .....	3-1
3.2	Menu Map .....	3-7
3.3	Menu Function Descriptions .....	3-19
3.3.1	AUTO TUNE Key (Auto Tuning) .....	3-19
3.3.2	BW Key (Bandwidth) .....	3-20
3.3.3	CAL Key (Calibration) .....	3-21
3.3.4	CONFIG Key (Configuration) .....	3-23
3.3.5	COPY Key (Hard Copy) .....	3-29
3.3.6	COUNTER Key (Frequency Counter) .....	3-30
3.3.7	DISPLAY Key (Line and Window) .....	3-31
3.3.8	EMC Key (EMC Measurement) .....	3-33
3.3.9	FREQ Key (Frequency) .....	3-36
3.3.10	Hold Mode .....	3-41
3.3.11	LEVEL Key (Frequency Level) .....	3-42
3.3.12	LOCAL Key (GPIB Remote Control) .....	3-44
3.3.13	MEAS Key (Measurement) .....	3-45
3.3.14	MKR Key (Marker) .....	3-50
3.3.15	MKR → Key (Marker →) .....	3-53
3.3.16	PAS/FAIL Key (Pass/Fail Judgment) .....	3-54
3.3.17	PK SRCH Key (Peak Search) .....	3-56
3.3.18	POWER MEASURE Key (Power Measurement) .....	3-57
3.3.19	PRESET Key (Initialization) .....	3-66
3.3.20	RECALL Key (Data Readout) .....	3-67
3.3.21	REPEAT Key (Continuous Sweep) .....	3-68



3.3.22	SAVE Key (Saving Data) .....	3-69
3.3.23	Self Test Key (Self Test) .....	3-71
3.3.24	SINGLE Key (Single Sweep) .....	3-72
3.3.25	SPAN Key (Frequency Span) .....	3-73
3.3.26	SWEEP Key (Sweep Time) .....	3-74
3.3.27	TG Key (Tracking Generator) (OPT74) .....	3-76
3.3.28	TRACE Key (Trace Data) .....	3-77
3.3.29	TRIG Key (Trigger) .....	3-81
3.3.30	UTILITY Key (Utility) .....	3-83
3.4	List of Settings .....	3-85
3.4.1	Factory Defaults .....	3-85
3.4.2	Defaults Configuration Values .....	3-89
4	REMOTE PROGRAMING .....	4-1
4.1	GPIB Command Index .....	4-1
4.2	GPIB Remote Programming .....	4-8
4.2.1	GPIB .....	4-8
4.2.2	GPIB Setup .....	4-9
4.2.3	GPIB Interface Functions .....	4-10
4.2.4	Responses to Interface Messages .....	4-11
4.2.5	Message Exchange Protocol .....	4-12
4.2.6	Command Syntax .....	4-13
4.2.7	Data Formats .....	4-14
4.2.8	Status Byte .....	4-15
4.2.9	GPIB Command Codes .....	4-22
4.2.10	Example Programs .....	4-49
4.2.10.1	Sample Programs for Setting or Reading Measurement Conditions .....	4-49
4.2.10.2	Sample Programs for Reading Data .....	4-51
4.2.10.3	Sample Programs for Inputting or Outputting Trace Data .....	4-56
4.2.10.4	Example program using the TS (Take Sweep) command .....	4-60
4.2.10.5	Program Examples Using the Status Byte .....	4-61
4.2.10.6	Example Program Used to Read Screen Data .....	4-62
4.3	RS-232 Remote Control Function .....	4-63
4.3.1	GPIB and RS-232 Compatibility .....	4-63
4.3.2	Features of RS-232 Remote Control .....	4-63
4.3.3	Parameter Setup Window .....	4-63
4.3.4	Interface connection .....	4-64
4.3.5	Data Format .....	4-65
4.3.6	Differences Between RS-232 and GPIB .....	4-66
4.3.7	Panel Control .....	4-66
4.3.8	Remote Control Usage Examples .....	4-67
5	PERFORMANCE VERIFICATION .....	5-1

## Table of Contents

5.1	General .....	5-1
5.2	Procedures of Performance Verification .....	5-7
5.2.1	Frequency Reference Source Output Accuracy .....	5-7
5.2.2	Calibrator Amplitude Accuracy .....	5-9
5.2.3	Displayed Average Noise Level .....	5-11
5.2.4	Resolution Bandwidth Switching Uncertainty .....	5-16
5.2.5	Resolution Bandwidth Accuracy and Selectivity .....	5-19
5.2.6	QP Bandwidth Accuracy .....	5-23
5.2.7	IF Gain Uncertainty .....	5-25
5.2.8	Input Attenuator Switching Accuracy (R3132/32N/62) .....	5-29
5.2.9	Input Attenuator Switching Accuracy (R3172/82) .....	5-32
5.2.10	Scale Fidelity .....	5-35
5.2.11	Residual FM .....	5-41
5.2.12	Noise Sidebands .....	5-45
5.2.13	Image, Multiple and Out-of-Band Responses .....	5-47
5.2.14	Accuracy of Frequency Readout and Count Frequency Marker .....	5-51
5.2.15	Second Harmonic Distortion .....	5-55
5.2.16	Frequency Response .....	5-59
5.2.17	Frequency Span Accuracy .....	5-68
5.2.18	Third Order Intermodulation Distortion .....	5-72
5.2.19	Gain Compression .....	5-77
5.2.20	Sweep Time Accuracy .....	5-83
5.2.21	Residual Response .....	5-86
5.3	Tracking Generator Performance Verification Procedure .....	5-90
5.3.1	Absolute Output Level Accuracy .....	5-90
5.3.2	Output Level Flatness .....	5-92
5.3.3	Output Level Switching Accuracy .....	5-95
5.3.4	Harmonic Distortion .....	5-102
5.3.5	Non Harmonic Distortion .....	5-105
5.3.6	TG Leakage .....	5-107
5.4	Performance Verification for OPT73 (FM Demodulation) .....	5-109
5.4.1	Offset Error (Internal Mixer Mode) .....	5-109
5.4.2	Linearity Error (Internal Mixer Mode) .....	5-111
5.4.3	Offset Error (External Mixer Mode) .....	5-114
5.4.4	Linearity Error (External Mixer Mode) .....	5-116
5.5	Performance Verification Record Sheet .....	5-119
6	PERFORMANCE VERIFICATION (External Mixer) .....	6-1
6.1	External Mixer OPT16 .....	6-1
6.1.1	External Mixer Performance Verification Test Procedures .....	6-3
6.1.1.1	Noise Level .....	6-3
6.1.1.2	Frequency Response .....	6-5
6.1.2	Performance Verification Test Record Sheets .....	6-9

6.2	External Mixer OPT17 .....	6-14
6.2.1	External Mixer Performance Verification Test Procedures .....	6-16
6.2.1.1	Noise Level .....	6-16
6.2.1.2	Frequency Response .....	6-18
6.2.2	Performance Verification Test Record Sheets .....	6-22
6.3	External Mixer OPT18 .....	6-29
6.3.1	External Mixer Performance Verification Test Procedures .....	6-31
6.3.1.1	Noise Level .....	6-31
6.3.1.2	Frequency Response .....	6-34
6.3.2	Performance Verification Test Record Sheets .....	6-39
6.4	External Mixer OPT19 .....	6-52
6.4.1	External Mixer Performance Verification Test Procedures .....	6-54
6.4.1.1	Noise Level .....	6-54
6.4.1.2	Frequency Response .....	6-56
6.4.2	Performance Verification Test Record Sheets .....	6-60
7	SPECIFICATIONS .....	7-1
7.1	R3132 Specifications .....	7-1
7.2	R3132N Specifications .....	7-5
7.3	R3162 Specifications .....	7-9
7.4	R3172 Specifications .....	7-14
7.5	R3182 Specifications .....	7-19
7.6	Options .....	7-25
	APPENDIX .....	A-1
A.1	ERROR MESSAGE .....	A-1
	DIMENSIONAL OUTLINE DRAWING .....	EXT-1
	ALPHABETICAL INDEX .....	I-1



## LIST OF ILLUSTRATIONS

No.	Title	Page
1-1	Operating Environment .....	1-6
1-2	Replacing the Power Fuse .....	1-8
1-3	Power Cable .....	1-9
1-4	Connecting the Power Supply Cable .....	1-10
1-5	Screen Display after Self Tests have Completed .....	1-11
1-6	Self Test Screen .....	1-11
1-7	Screen Shown after Executing Self Test .....	1-12
1-8	Removing the Display Filter .....	1-13
2-1	Front Panel (R3132/32N/62) .....	2-1
2-2	Front Panel (R3172) .....	2-2
2-3	Front Panel (R3182) .....	2-2
2-4	Screen Annotation .....	2-12
2-5	Rear Panel .....	2-14
2-6	Factory Defaults Screen .....	2-20
2-7	Active Area Display .....	2-21
2-8	Setting the Center Frequency .....	2-21
2-9	Measuring Settings Screen .....	2-22
2-10	Peak Search Display Screen .....	2-22
2-11	Activating the Display Line .....	2-25
2-12	Making a Comparison Between Peaks Using Reference Lines .....	2-25
2-13	Screen Display Showing the Measuring Window .....	2-26
2-14	Measuring Settings Screen .....	2-28
2-15	Frequency Counter Measurement (Resolution: 1 kHz) .....	2-28
2-16	Frequency Counter Measurement (Resolution: 10 Hz) .....	2-29
2-17	Screen Display Prior to Auto Tuning .....	2-30
2-18	Screen Display after Auto Tuning .....	2-30
2-19	Signal Tracking Screen .....	2-32
2-20	Continuous Peak Search Screen .....	2-33
2-21	Screen with UNCAL Message .....	2-34
2-22	UNCAL Message Removed .....	2-35
2-23	Setup for Measuring Two Signals Separately .....	2-35
2-24	Two Superimposed Peaks .....	2-36
2-25	Two Discernible Peaks .....	2-37
2-26	Two Distinct Peaks Can Now Be Seen .....	2-37
2-27	Setup for Verifying the Dynamic Range .....	2-38
2-28	Screen Display Prior to Changing the RBW .....	2-39
2-29	Screen Display after Changing the RBW .....	2-39
2-30	Screen Display after Changing the VBW .....	2-40
2-31	The Trace after Averaging .....	2-40
2-32	Spectrum Displayed when the pre-amplifier is Used .....	2-41
2-33	Setup for Input Saturation .....	2-42
2-34	Screen Display without Saturation .....	2-43
2-35	Screen Display Showing Saturation .....	2-44
2-36	Setup for Measuring Harmonic Distortion .....	2-44
2-37	Screen Display Showing Harmonic Distortion .....	2-45

## List of Illustrations

No.	Title	Page
2-38	Screen Display Showing Reduced Harmonic Distortion .....	2-46
2-39	Setup for Measuring Intermodulation .....	2-46
2-40	Screen Display Showing Intermodulation Distortion .....	2-48
2-41	Screen Display without Intermodulation Distortion .....	2-48
2-42	Screen Display Showing the Cal Menu .....	2-49
2-43	Editing the Correction Data Table .....	2-50
2-44	Screen for the EMC Menu .....	2-51
2-45	Screen Display Showing the User-Definable Correction Data Table .....	2-51
2-46	Setup for the R3172 and Waveguide Mixer .....	2-53
2-47	Setup for the R3182 and Waveguide Mixer .....	2-53
2-48	Setup for Measuring the Channel Power .....	2-55
2-49	Setting the Offset Level .....	2-56
2-50	Measuring the Channel power .....	2-57
2-51	Setup for Measuring the Occupied Bandwidth .....	2-58
2-52	Setting the Detector Mode .....	2-59
2-53	OBW Measurement Screen .....	2-60
2-54	OBW(95%) Measurement Screen .....	2-60
2-55	Setup Measuring Adjacent Channel Leakage Power .....	2-62
2-56	PDC trace .....	2-63
2-57	CS/BS Setup dialog box .....	2-64
2-58	Root Nyquist Filter dialog box .....	2-65
2-59	ACP Measurement Display in Full Screen Mode .....	2-65
2-60	Measurement Using ACP GRAPH .....	2-66
2-61	ACP at the 100 kHz .....	2-66
2-62	Setup Measuring Adjacent Channel Leakage Power .....	2-67
2-63	PHS Trace .....	2-68
2-64	CS/BS Setup dialog box .....	2-69
2-65	Measurement Result in ACP Separate Screen Mode .....	2-70
2-66	Setup for Measuring a Burst Signal .....	2-71
2-67	Burst Signal Displayed in Split Screen Mode .....	2-72
2-68	Trigger Setup .....	2-73
2-69	Gate Setup .....	2-73
2-70	Burst Signal by Use of the Gated Sweep (Separate Screen Mode) .....	2-74
2-71	Burst Signal by Use of the Gated Sweep (Full Screen Mode) .....	2-74
2-72	Setup for Measuring a Burst wave signal .....	2-75
2-73	Burst Signal in the Time Domain .....	2-76
2-74	Burst Signal in the Time Domain .....	2-76
2-75	Burst Signal in Synchronization with the Trigger Signal .....	2-77
2-76	Measuring Burst Signal Leading Edge .....	2-77
2-77	Measuring Burst Signal Trailing Edge .....	2-78
2-78	Screen Displayed after Limit Line 1 Data Has Been Entered .....	2-81
2-79	Screen Displayed after Limit Line 2 Data Has Been Entered .....	2-81
2-80	PASS/FAIL Result using Limit Line 1 (PASS) .....	2-82
2-81	PASS/FAIL Result using Limit Lines 1 and 2 (FAIL) .....	2-82
2-82	PASS/FAIL Result using Limit Lines 1 and 2 (PASS) .....	2-83
2-83	Judgment Result after the Offset Has Been Changed (FAIL) .....	2-83
2-84	Judgment Result after the Offset Has Been Changed (PASS) .....	2-84
2-85	Setup for TG Measurements .....	2-85

No.	Title	Page
2-86	Measurement Screen after a Normalization Calibration .....	2-86
2-87	Connecting the Unit under Test .....	2-87
2-88	Insertion Loss Measurement Screen .....	2-88
2-89	3-dB Bandwidth Measurement Screen .....	2-88
2-90	Setup for Measuring the Spectrum Mask .....	2-89
2-91	A Trace Used with IS-95 .....	2-91
2-92	CS/BS Setup Dialog Box .....	2-92
2-93	Spectrum Mask Measurement Screen .....	2-93
2-94	Setup for measuring VCO Output Levels .....	2-94
2-95	Measurement Signal with an Image Signal .....	2-95
2-96	Measurement Signal with the Image Signal Eliminated .....	2-95
2-97	Software Image Suppression Function in Split Screen Mode .....	2-96
2-98	Setup for Measurements Using the FM Demodulation Function .....	2-97
2-99	FM Deviation Measurement .....	2-99
2-100	How to Calculate the Sensitivity .....	2-99
2-101	Sensitivity Measurement Screen .....	2-100
2-102	Simultaneously Displaying Sensitivity and Demodulation .....	2-101
2-103	Setting Offset and Slope Used for Linearity Measurements .....	2-101
2-104	Setting Offset and Slope when Using the Measuring Window .....	2-102
2-105	Linearity Measurement .....	2-102
2-106	Floppy Disk Write Protection .....	2-104
2-107	Screen for the F.Disk Menu .....	2-106
2-108	Screen Display Showing Floppy Disk as the Destination .....	2-108
2-109	Display for Selecting the Data to be Saved .....	2-109
2-110	Display after Data has been Saved to a File .....	2-110
2-111	Screen Display Showing File Protection Enabled .....	2-111
2-112	Screen Display Showing the Selected File .....	2-112
2-113	Screen Display showing Recalled Data .....	2-112
2-114	Screen as Shown when Deleting a File .....	2-113
2-115	Screen as Shown after Deleting File Data .....	2-114
2-116	Screen Display Showing Floppy Disk as the Specified Destination .....	2-115
2-117	Printer Setup Screen .....	2-117
2-118	Time/Date Menu .....	2-118
2-119	Dialog Box Used to Enter Titles .....	2-119
2-120	Displaying the Screen Title .....	2-120
4-1	Arrangement of the Three Status Registers .....	4-16
4-2	Details of the Three Status Registers .....	4-17
4-3	Structure of the Status Byte Register .....	4-19
4-4	Relationship between Screen Graticule and Trace Data .....	4-56
4-5	Parameter Setup .....	4-63
4-6	Connection Between the Controller and the Spectrum Analyzer .....	4-64
4-7	Cable Wiring Diagram .....	4-65
4-8	Data Format .....	4-65
5-1	Setup of Frequency Reference Source Accuracy Test .....	5-8
5-2	Setup of CAL OUT Level Accuracy Test .....	5-10
5-3	Setup of Displayed Average Noise Level Test .....	5-12

List of Illustrations

No.	Title	Page
5-4	Setup of Resolution Bandwidth Switching Uncertainty .....	5-16
5-5	Setup of Resolution Bandwidth Accuracy and Selectivity Test .....	5-20
5-6	Setup of QP Bandwidth Accuracy Test .....	5-23
5-7	Setup of IF Gain Uncertainty Test .....	5-26
5-8	Setup of Input Attenuator Switching Accuracy Test (R3132/32N/62) .....	5-29
5-9	Setup of Input Attenuator Switching Accuracy Test (R3172/82) .....	5-33
5-10	Setup of Scale Fidelity Test .....	5-36
5-11	Setup of Residual FM Test .....	5-42
5-12	Setup of Noise Sidebands Test .....	5-46
5-13	Setup of Image, Multiple and Out-of-Band Responses Test .....	5-48
5-14	Setup of Accuracy of Frequency Readout and Frequency Counter Test .....	5-52
5-15	Setup of Second Harmonic Distortion Test .....	5-56
5-16	Setup of Frequency Response Test .....	5-61
5-17	Setup of Frequency Span Accuracy Test .....	5-68
5-18	Setup of Third Order Intermodulation Distortion Test .....	5-74
5-19	Setup of Gain Compression Test .....	5-79
5-20	Setup of Sweep Time Accuracy Test .....	5-83
5-21	Setup of Residual Response Test .....	5-87
5-22	Setup of Absolute Output Level Accuracy Test .....	5-90
5-23	Setup of Output Level Flatness Test .....	5-92
5-24	Setup of Output Switching Accuracy Test .....	5-96
5-25	Setup of Harmonic Distortion Test .....	5-102
5-26	Setup of Non Harmonic Distortion Test .....	5-105
5-27	Setup of TG Leakage Test .....	5-107
5-28	Setup for Checking the Offset Error (Internal Mixer Mode) .....	5-109
5-29	Setup for Checking the Linearity Error (Internal Mixer Mode) .....	5-111
5-30	Setup for Checking the Offset Error (External Mixer Mode) .....	5-114
5-31	Setup for Checking the Linearity Error (External Mixer Mode) .....	5-116
6-1	Setup of Noise Level Test .....	6-3
6-2	Setup of Source Module Calibration .....	6-5
6-3	Setup of Frequency Response Test .....	6-6
6-4	Setup of Noise Level Test .....	6-16
6-5	Setup of Source Module Calibration .....	6-18
6-6	Setup of Frequency Response Test .....	6-19
6-7	Setup of Noise Level Test .....	6-31
6-8	Setup of Source Module Calibration .....	6-34
6-9	Setup of Frequency Response Test .....	6-35
6-10	Setup of Noise Level Test .....	6-54
6-11	Setup of Source Module Calibration .....	6-56
6-12	Setup of Frequency Response Test .....	6-57



## LIST OF TABLES

No.	Title	Page
1-1	Standard Accessories List .....	1-3
1-2	Power Cable Options .....	1-4
1-3	Power Supply Specifications .....	1-7
2-1	Product Summary .....	2-52
2-2	Configuration of the Options .....	2-52
2-3	File Names .....	2-54
2-4	Setting Limit Line 1 .....	2-80
2-5	Setting Limit Line 2 .....	2-80
2-6	Setting Limit Line1 .....	2-90
2-7	Relationship Between Frequency Range and the Value of RBW .....	2-98
2-8	Recommended Compatible Printers .....	2-116
3-1	Factory Defaults (R3132/N) .....	3-85
3-2	Factory Defaults (R3162) .....	3-86
3-3	Factory Defaults (R3172) .....	3-87
3-4	Factory Defaults (R3182) .....	3-88
3-5	Values for Default Config .....	3-89
4-1	Frequency (1 of 3) .....	4-22
4-2	Level .....	4-25
4-3	BW .....	4-25
4-4	Sweep .....	4-26
4-5	Trigger .....	4-27
4-6	Trace (1 of 2) .....	4-28
4-7	Pass/Fail .....	4-30
4-8	Display .....	4-31
4-9	MKR (1 of 2) .....	4-32
4-10	MKR → .....	4-34
4-11	Meas (1 of 3) .....	4-35
4-12	Auto Tune .....	4-38
4-13	Counter .....	4-38
4-14	Power (1 of 3) .....	4-38
4-15	EMC .....	4-41
4-16	CAL .....	4-42
4-17	Save Recall .....	4-43
4-18	Config .....	4-44
4-19	Preset .....	4-44
4-20	Test .....	4-45
4-21	GPIB .....	4-45
4-22	Others .....	4-46
4-23	FM Demodulation (OPT73) (1 of 2) .....	4-46
4-24	TG (OPT74) .....	4-47
4-25	Entry .....	4-48
4-26	Trace Accuracy Specification Codes .....	4-56
4-27	I/O format .....	4-57

## List of Tables

No.	Title	Page
5-1	Performance Verification Items .....	5-1
5-2	Performance Verification Items for Tracking Generator .....	5-2
5-3	Performance Verification Items for FM Demodulation .....	5-2
5-4	Instrument Required (1 of 3) .....	5-4
5-4	Center Frequency Setting for Display Average Noise Level .....	5-13
5-5	Start and Stop Frequencies Setting .....	5-15
5-6	RBW Switching Uncertainty Test Setting .....	5-18
5-7	RBW and Span for 3 dB Down Width Measurement Setting .....	5-21
5-8	RBW Selectivity Test Setting .....	5-22
5-9	RBW and Span for 6 dB Down Width Measurement Setting .....	5-24
5-10	IF Gain Uncertainty Measurement Setting .....	5-28
5-11	Input Attenuator Switching Accuracy Test Setting for R3132/32N .....	5-31
5-12	Input Attenuator Switching Accuracy Test Setting for R3162 .....	5-31
5-13	Input Attenuator Switching Accuracy Test Setting for R3172/82 .....	5-34
5-14	1 dB/div Scale Fidelity Test Setting .....	5-37
5-15	10 dB/div Scale Fidelity Test Setting .....	5-38
5-16	Linear Scale Fidelity Test Setting .....	5-40
5-17	Image, Multiple, Out-of-Band Response Test Setting .....	5-50
5-18	Frequency Readout Accuracy Test Setting .....	5-54
5-19	Count Frequency Marker Accuracy Test Setting .....	5-54
5-20	Center and Span Frequencies for the R3132 series .....	5-70
5-21	Center and Span Frequencies for the R3162/72/82 .....	5-70
5-22	Center and Span Frequencies for the R3172/82 .....	5-71
5-23	Center and Span Frequencies for the R3182 .....	5-71
5-24	Third Order Intermodulation Distortion Test Setting .....	5-75
5-25	Third Order Intermodulation Distortion Test Setting for the R3162/72/82 .....	5-76
5-26	Sweep Time Accuracy Test Setting .....	5-85
5-27	Output Flatness Test Setting .....	5-94
5-28	TG Output Level Switching Accuracy Test Setting (1) .....	5-97
5-29	TG Output Level Switching Accuracy Test Setting (2) (1 of 5) .....	5-97
5-30	Harmonic Distortion Test Setting .....	5-104
5-31	Relationship Between the Frequency Range and Signal Generator Frequency Setting (Used on the R3132 Series) .....	5-113
5-32	Relationship Between the Frequency Range and Signal Generator Frequency Setting (Used on the R3132 Series) .....	5-118
6-1	List of Performance Verification Test Items .....	6-1
6-2	Equipment List for Performance Verification Test .....	6-1
6-3	List of Performance Verification Test Items .....	6-14
6-4	Equipment List for Performance Verification Test .....	6-14
6-5	List of Performance Verification Test Items .....	6-29
6-6	Equipment List for Performance Verification Test .....	6-29
6-7	List of Performance Verification Test Items .....	6-52
6-8	Equipment List for Performance Verification Test .....	6-52

## 1 INTRODUCTION

This chapter provides the following information:

- Product description
- A list of standard accessories and power cable options
- Options
- Operating environment
- How to verify that the spectrum analyzer is functioning properly
- How to clean, store, and transport the spectrum analyzer
- Calibration
- Replacing Parts with Limited Life

### 1.1 Product Description

The R3132 Series spectrum analyzer uses the synthesized local method and allow the user highly stable and highly precise spectrum analysis.

The key features of the R3132 Series spectrum analyzer are listed below.

- (1) Frequency Range: 9 kHz to 3 GHz (R3132/N)  
9 kHz to 8 GHz (R3162)  
9 kHz to 26.5 GHz (R3172)  
9 kHz to 40 GHz (R3182)  
Frequency span: Zero, 1 kHz to 3 GHz (R3132/N)  
Zero, 1 kHz to 8 GHz (R3162)  
Zero, 1 kHz to 26.5 GHz (R3172)  
Zero, 1 kHz to 40 GHz (R3182)
- (2) High-speed and high-precision sweep  
Frequency span accuracy: 1% or less  
Sweep time: 20 ms
- (3) Wide dynamic range  
Maximum input level: +30 dBm  
Built-in pre-amplifier: -132 dBm noise level
- (4) Frequency counter function with a resolution of 1Hz.
- (5) A power measurement function useful for evaluating radio instruments using measurements such as occupied bandwidth (OBW), adjacent channel power (ACP), channel power, etc.
- (6) An auto tuning function that searches for a signal with the maximum input level.
- (7) Save and recall functions which you can use to store measurement conditions and data in TEXT format.
- (8) A 3.5-inch floppy disk drive which you can use to save screen images in BMP format.
- (9) Support for ESC/P, ESC/P-R and PCL compatible printers.

## 1.1 Product Description

- (10) Remote control capabilities which allow you to setup an automatic measurement system. This remote control function complies with GPIB and RS-232 specifications.
- (11) High-precision color LCD

## 1.2 Accessories

Table 1-1 lists the standard accessories shipped with the spectrum analyzer. If any of the accessories are damaged or missing or, to order additional accessories, contact the nearest ADVANTEST Field Office or representative.

**Table 1-1 Standard Accessories List**

Name of accessory	Type name	Quantity			Remarks
		R3132/ 62/72	R3182	R3132N	
Power cable	A01402	1	1	1	*1
Input cable (50 Ω)	A01261-30	1	1	—	
Input cable (75 Ω)	A01045	—	—	1	
N to BNC adapter	JUG-201A/U	1	—	—	*2
C15 Type adapter	NCP-NFJ	—	—	1	*2
NC to BNC adapter	BA-A165	—	—	1	*2
K to K adapter	5A-SFF40(A)	—	1	—	
SMA to SMA adapter	HRM-501	—	1	—	
SMA to BNC adapter	HRM-517(09)	—	1	—	
Operation manual (This manual)	ER3132/62	1	1	1	

\* 1: The cable supplied with the spectrum analyzer depends on what type (specified by model number above) was ordered when the spectrum analyzer was purchased.  
There are 11 types of power cable available (see Table 1-2).  
To order another power cable, contact an ADVANTEST Field Office or representative. When ordering, refer to power cables by their option number or model number.

\* 2: Quantity is 2 when the instrument is equipped with TG option (OPT74).

1.2 Accessories

**Table 1-2 Power Cable Options**

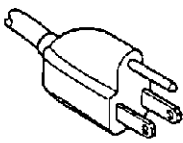
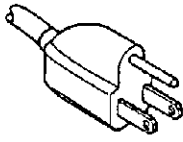
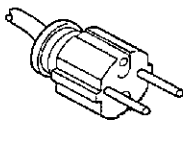
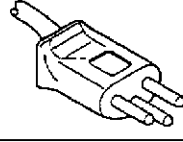
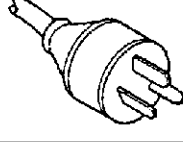
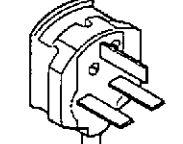
Plug configuration	Standards	Rating, color and length	Model number (Option number)
	JIS: Japan  Law on Electrical Appliances	125 V at 7 A Black 2 m (6 ft)	Straight:A01402  Angled:A01412
	UL: United States of America  CSA: Canada	125 V at 7 A Black 2 m (6 ft)	Straight:A01403 (OPT95) Angled:A01413
	CEE:Europe DEMKO:Denmark NEMKO:Norway VDE:Germany KEMA:The Netherlands CEBEC:Belgium OVE:Austria FIMKO:Finland SEMKO:Sweden	250 V at 6 A Gray 2 m (6 ft)	Straight:A01404 (OPT96) Angled:A01414
	SEV: Switzerland	250 V at 6 A Gray 2 m (6 ft)	Straight:A01405 (OPT97) Angled:A01415
	SAA: Australia, New Zealand	250 V at 6 A Gray 2 m (6 ft)	Straight:A01406 (OPT98) Angled:-----
	BS: United Kingdom	250 V at 6 A Black 2 m (6 ft)	Straight:A01407 (OPT99) Angled:A01417

### 1.3 Options

The following options are available for this spectrum analyzer.

- (1) OPT20 Highly Stable Reference Frequency Crystal Oscillator
- (2) OPT27 Narrow-band Resolution Bandwidth
- (3) OPT29 High-Speed Time-Domain Sweep
- (4) OPT73 FM Demodulation
- (5) OPT74 Tracking Generator  
(This option can be installed on the R3132, R3132N, R3162 and R3172.)

1.4 Operating Environment

**1.4 Operating Environment**

This section describes the environmental conditions and power requirements necessary to use the spectrum analyzer.

**1.4.1 Environmental Conditions**

The R3132 Series should be only be used in an area which satisfies the following conditions:

- Ambient temperature: 0 °C to +50 °C (operating temperature)
- Relative humidity: 85% or less (without condensation)
- An area free from corrosive gas
- An area away from direct sunlight
- A dust-free area
- An area free from vibrations
- A low noise area

Although the R3132 Series has been designed to withstand a certain amount of noise riding on the AC power line, it should be used in an area of low noise. Use a noise cut filter when ambient noise is unavoidable.

- An area allowing unobstructed air flow

The R3132 Series has an exhaust cooling fan on the rear panel and an exhaust vent on the bottom side toward the front. Never block these areas as the resulting internal temperature rise will affect measurement accuracy.

- Avoid operation in the following areas.
- Use a noise cut filter when there is a large amount of noise riding on the power line.

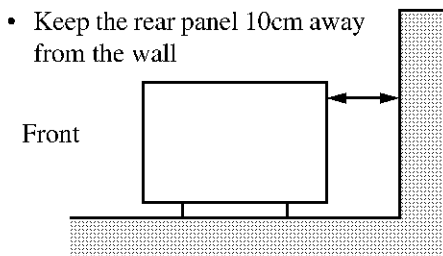
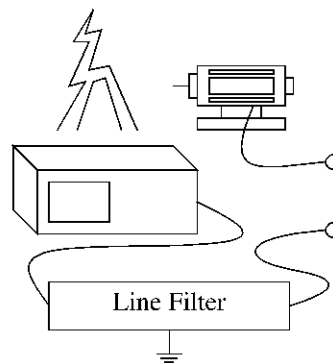
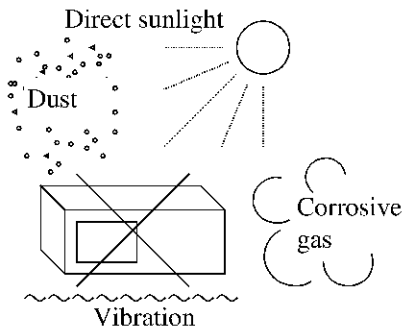

- Keep the rear panel 10cm away from the wall

**Figure 1-1 Operating Environment**



The R3132 Series can be used safely under the following conditions:

- Altitude: 2000 m maximum above the sea level
- Installation category II
- Pollution degree 2

## 1.4.2 Power Requirements

The power supply specifications of the spectrum analyzer are listed in Table 1-3.

**Table 1-3 Power Supply Specifications**

	100 VAC Operation	200 VAC Operation
Input voltage range	90 V - 132 V	198 V - 250 V
Frequency range	48 Hz - 66 Hz	
Power consumption	200 VA or below	

---

**CAUTION**    *To prevent damage, operate the spectrum analyzer within the specified input voltage and frequency ranges.*

---

During operation, the power supply automatically switches between input voltage levels of 100 VAC and 200 VAC. Be sure, however, to use a power cable that matches the input voltage and meets the related standard (see Table 1-2).

## 1.4.3 Power Fuse

---

**CAUTION:**

1. *When a fuse blows, there may be some problem with the analyzer so contact a qualified ADVANTEST service representative before replacing the fuse.*
  2. *To prevent fires, use the same rating and same model of a fuse.*
- 

The power fuse is placed in the fuse holder which is mounted on the rear panel. A spare fuse is located in the fuse holder.

To check or replace the power fuse, use the following procedure:

1. Press the **POWER** switch to the OFF position.
2. Disconnect the power cable from the AC power supply.
3. Remove the fuse holder on the rear panel.
4. Check (and replace if necessary) the power fuse and put it back in the fuse holder.

1.4.3 Power Fuse

Pull out the fuse holder using a slotted head screwdriver.

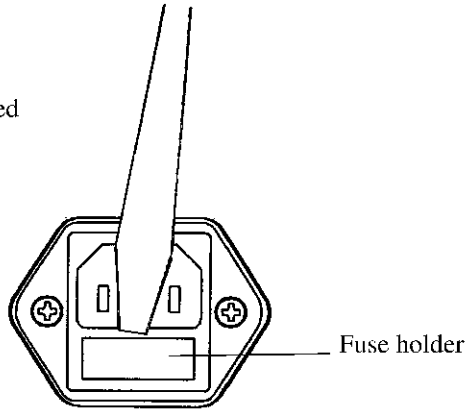

Check (and replace if necessary) the power fuse and put it back into the fuse holder.

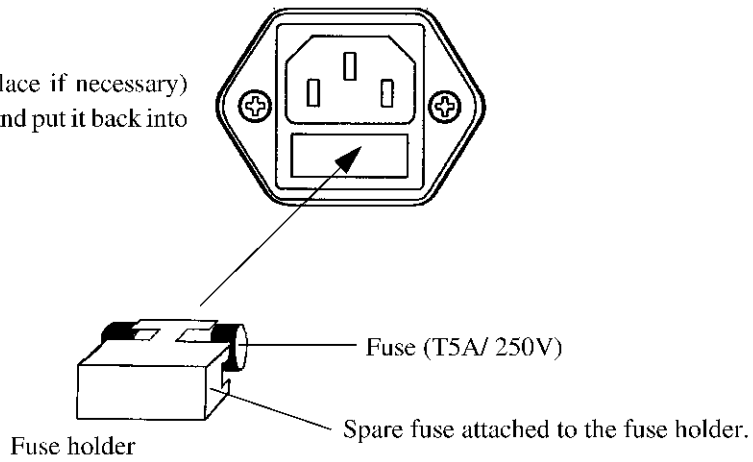

**Figure 1-2 Replacing the Power Fuse**

#### 1.4.4 Power Cable

A detachable power cable with a three-contact plug is included with the spectrum analyzer. The protective earth ground contact on the plug connects (through the power cable) to the accessible metal parts of the instrument. For protection against electrical shock, insert the plug into a power-source outlet that has a properly grounded, protective-ground contact.

The manufacturer ships a power cable, as ordered, with the spectrum analyzer. A list of other available power cables is shown in Table 1-2. Contact your ADVANTEST representative or the local ADVANTEST Field Office for information on how to order these.

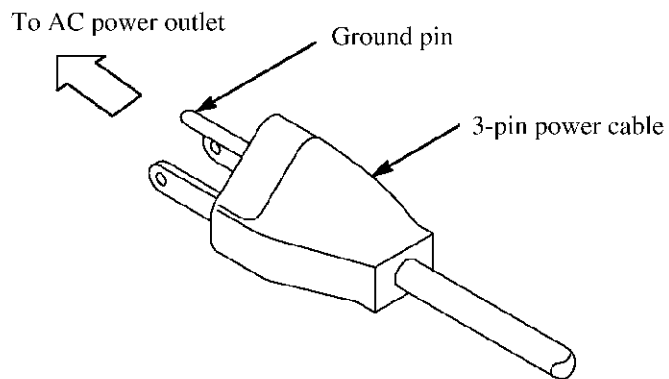

Figure 1-3 Power Cable

1.5 System Checkout

**1.5 System Checkout**

This section describes the Self Test which must be performed when operating the spectrum analyzer for the first time. Follow the procedure below:

---

**CAUTION:** *Wait at least 30 minutes after turning on the power before using to ensure accurate measurements.*

---

1. Make sure that the **POWER** switch on the front panel is in the OFF position.
2. Connect the power cable provided to the AC power supply connector on the rear panel.

---

**CAUTION:** *To prevent damage, operate the spectrum analyzer within specified input voltage and frequency ranges.*

---

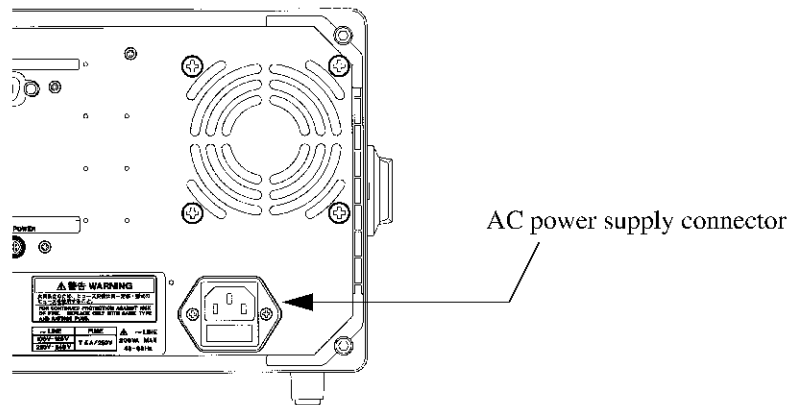

**Figure 1-4 Connecting the Power Supply Cable**

3. Connect the power cable to the outlet.
4. Press the **POWER** switch to the ON position.  
The spectrum analyzer performs the Initial test for approximately three seconds, then displays the startup screen as shown in Figure 1-5.

---

**CAUTION:** *There is a possibility that the screen display is different from the one shown in Figure 1-5, depending on previously saved conditions.*

---

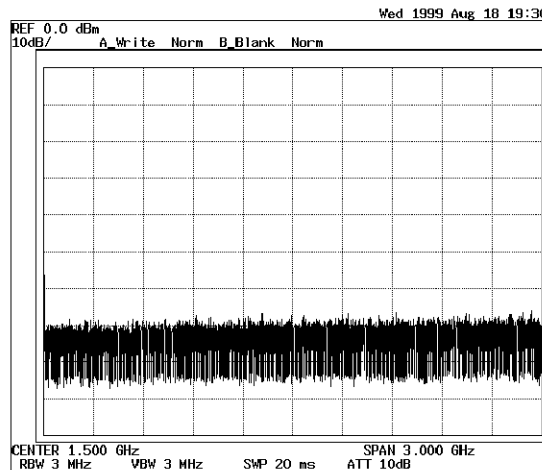

Figure 1-5 Screen Display after Self Tests have Completed

**CAUTION:** Allow 30 minutes for the R3132 Series to warm up before proceeding the next step.

5. Press **SHIFT**.  
The SHIFT lamp lights.
6. Press **CONFIG(PRESET)**.  
The factory defaults are reset.  
The startup screen is displayed as shown in Figure 1-5.
7. Press **SHIFT** and **0**.  
The Self Test menu is displayed.

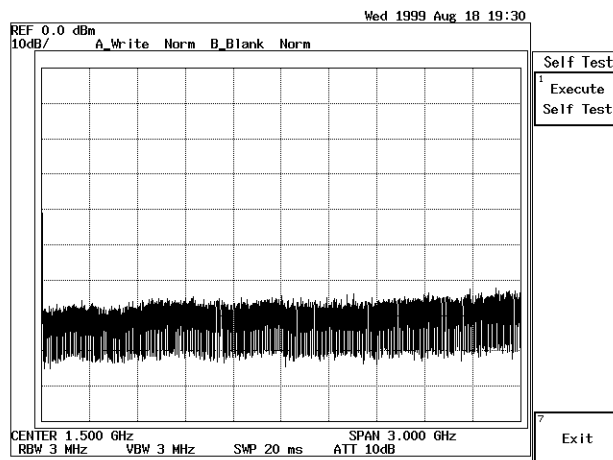

Figure 1-6 Self Test Screen

1.5 System Checkout

---

**NOTE:** Pressing *SHIFT* and *0* turns the Self Test mode on. In this mode, only the *SHIFT*, *PRESET* and *COPY* keys, and the currently displayed soft menu can be used. All other panel keys are disabled.

---

8. Press *Execute Self Test*.  
The five test items are executed in order and then the test results are displayed as shown below.

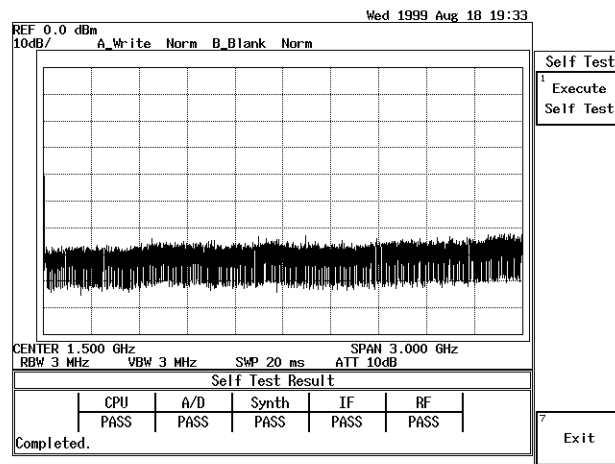

Figure 1-7 Screen Shown after Executing Self Test

---

**CAUTION:** If the Self Test detects any errors, do not attempt to use the spectrum analyzer any further. Contact an ADVANTEST service representative as soon as possible.

---

9. Press *Exit*.  
This exits the Self Test mode.

This completes the system checkout.

## 1.6 Cleaning, Storing and Transporting the R3132 Series Spectrum Analyzer

### 1.6.1 Cleaning

Remove dust from the outside of the spectrum analyzer by wiping or brushing the surface with a soft cloth or small brush. Use a brush to remove dust from around the panel keys. Hardened dirt can be removed by using a cloth which has been dampened in water containing a mild detergent.

---

**CAUTION:**

1. Do not allow water to get inside the spectrum analyzer.
  2. Do not use organic cleaning solvents, such as benzene, toluene, xylene, acetone or similar compounds, since these solvents may damage the plastic parts.
  3. Do not use abrasive cleaners.
- 

- Cleaning the Display Filter

Normally cleaning the display filter from the front should be sufficient. However, if necessary, the filter itself can be detached from the spectrum analyzer by removing the two screws on the front. Clean the backside of the filter with a soft cloth.

---

**CAUTION:** Do not touch the LCD display with your finger when the filter has been removed.

---

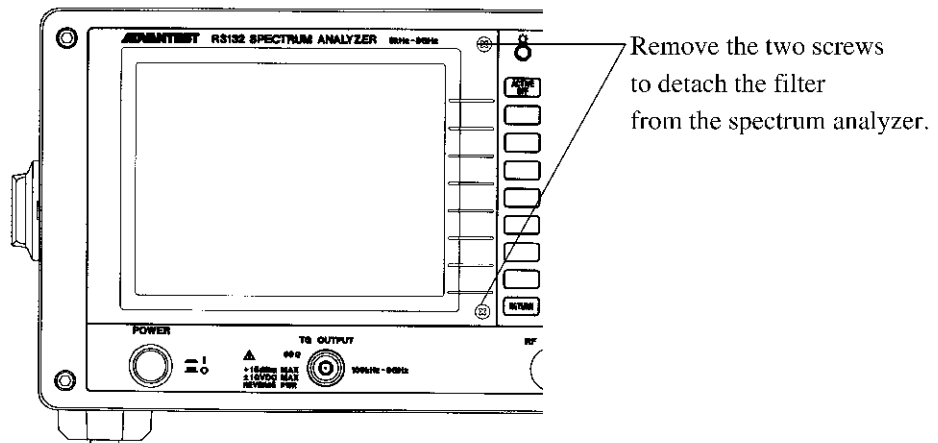

Figure 1-8 Removing the Display Filter

## 1.6.2 Storing

### 1.6.2 Storing

Store the spectrum analyzer in an area which has a temperature from  $-20^{\circ}\text{C}$  to  $+60^{\circ}\text{C}$ . If you plan to store the spectrum analyzer for a long period (more than 90 days), put the spectrum analyzer in a vapor-barrier bag with a drying agent and store the spectrum analyzer in a dust-free location out of direct sunlight.

### 1.6.3 Transporting

When you ship the spectrum analyzer, use the original container and packing material. If the original packaging is not available, pack the spectrum analyzer using the following guidelines:

- To allow for cushioning, use a corrugated cardboard container with inner dimensions that are at least 15 centimeters more than those of the spectrum analyzer.
- Surround the spectrum analyzer with plastic sheeting to protect the finish.
- Cushion the spectrum analyzer on all sides with packing material or plastic foam.
- Seal the container with shipping tape or a heavy-duty, industrial stapler.

If you are shipping the spectrum analyzer to a service center for service or repair, attach a tag to the spectrum analyzer that shows the following information:

- Owner and address
- Name of a contact person at your location
- Serial number of the spectrum analyzer (located on the rear panel)
- Description of the service requested



## 1.7 Calibration

The R3132 Series requires yearly calibration. Calibration work should be performed at an ADVANTEST CORPORATION site. Please contact ADVANTEST CORPORATION concerning the calibration.

## 1.8 Replacing Parts with Limited Life

The R3132 Series uses the following parts with limited life that are not listed in Safety Summary.

Replace the parts listed below after their expected lifespan has expired.

Part name	Life
Input attenuator	R3132/32N/62: 2 million cycles
	R3172/82: 2.5 million cycles
Rotary encoder	100,000 cycle



## 2 OPERATION

This chapter describes the following:

- Front and rear panel controls and connectors
- Screen annotation
- Basic operation
- Measurement examples
- Expanded functions

### 2.1 Panel Description

#### 2.1.1 Front Panel

This section contains detailed views of the front panel and explanations for the panel keys or connectors shown in those views. Figure 2-1 shows the front panel location of the nine detail views.

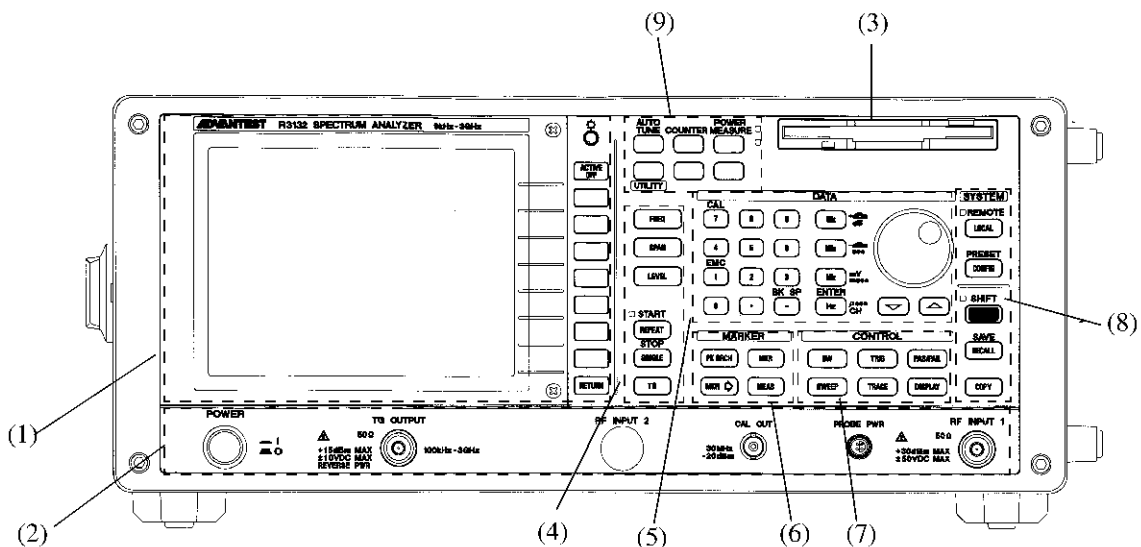

Figure 2-1 Front Panel (R3132/32N/62)

2.1.1 Front Panel

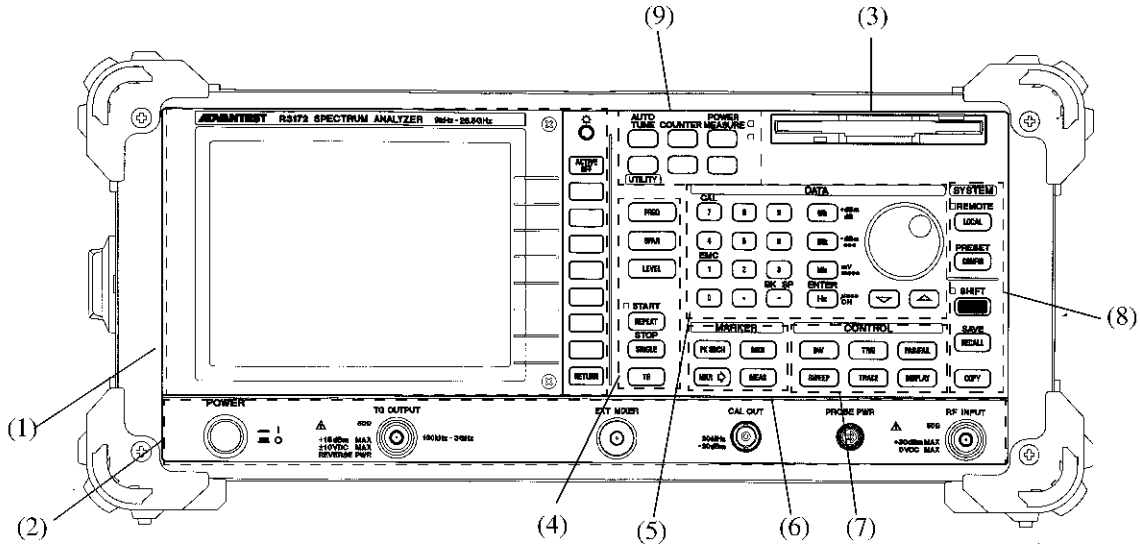

Figure 2-2 Front Panel (R3172)

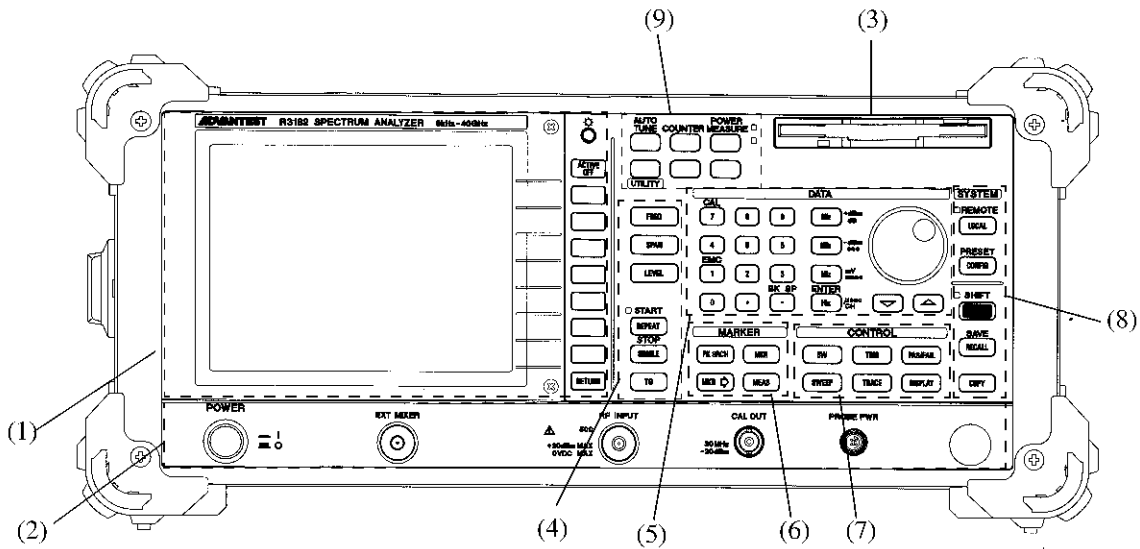
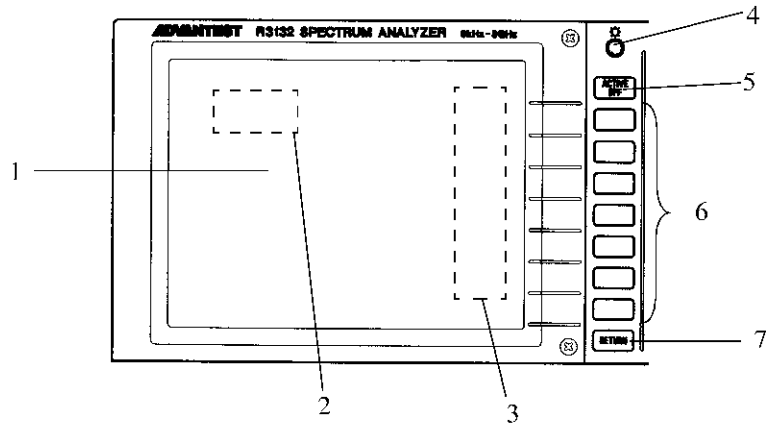

Figure 2-3 Front Panel (R3182)

## (1) Display Section





Control		Description
1	Liquid crystal display (LCD)	Displays trace and measured data
2	Active area	Displays input data and measurement data
3	Soft-menu display	Displays the function of each soft key (up to 7 at one time)
4	Intensity	Adjusts the brightness of the display back light.
5	<b>ACTIVE OFF</b> key	Turns off the active area removing any displayed information
6	Soft keys	Seven keys corresponding to the soft-menu display on the left; pressing a soft key selects the corresponding menu item
7	<b>RETURN</b> key	Used to return the screen display to the previous level of the hierarchical soft-menu structure

2.1.1 Front Panel

(2) Power Switch/Connector Section

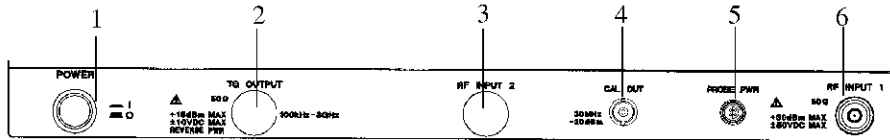
- R3132/32N/62



Control	Description
1	<b>POWER</b> switch Turns the power on or off
2	<b>TG OUTPUT</b> connector (Option) TG output connector Frequency range is 100 kHz to 3 GHz
3	<b>RF INPUT 2</b> connector (Unused)
4	<b>CAL OUT</b> connector Calibration signal output connector 30 MHz, -20 dBm
5	<b>PROBE PWR</b> connector Power output for the accessory. The maximum current is 100 mA <div style="display: flex; align-items: center; justify-content: center;">  <div style="margin-left: 20px;"> <p>1: NC 2: GND 3: -12V 4: +12V</p> </div> </div>
6	<b>RF INPUT 1</b> connector Inputs the signal to be measured.

- R3172

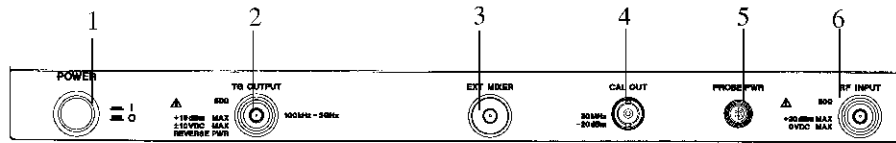

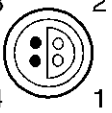
Control		Description
1	<b>POWER</b> switch	Turns the power on or off
2	<b>TG OUTPUT</b> connector	(Option) TG output connector Frequency range is 100 kHz to 3 GHz
3	<b>EXT MIXER</b> connector	(Option) Connects an external mixer to increase the measurement frequency range.
4	<b>CAL OUT</b> connector	Calibration signal output connector 30 MHz, -20 dBm
5	<b>PROBE PWR</b> connector	Power output for the accessory. The maximum current is 100 mA <div style="display: flex; align-items: center; justify-content: center;">  <div style="margin-left: 20px;"> <p>3      2      1: NC</p> <p>4      1      2: GND</p> <p>                         3: -12V</p> <p>                         4: +12V</p> </div> </div>
6	<b>RF INPUT</b> connector	Inputs the signal to be measured.

2.1.1 Front Panel

- R3182

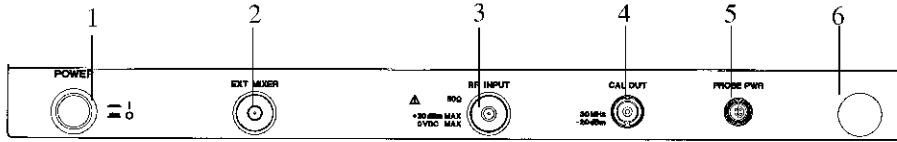

Control	Description
1 <b>POWER</b> switch	Turns the power on or off
2 <b>EXT MIXER</b> connector	Connects an external mixer to increase the measurement frequency range.
3 <b>RF INPUT</b> connector	Inputs the measurement signal.
4 <b>CAL OUT</b> connector	Calibration signal output connector 30 MHz, -20 dBm
5 <b>PROBE PWR</b> connector	Power output for the accessory. The maximum current is 100 mA <div style="display: flex; align-items: center; justify-content: center;"> <div style="margin-right: 10px;"> </div> <div> <p>1: NC 2: GND 3: -12V 4: +12V</p> </div> </div>
6	(Unused)

(3) Floppy Disk Drive Section

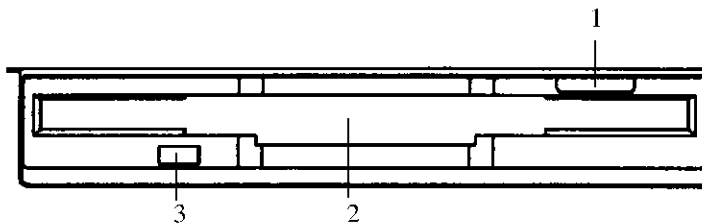

Control	Description
1 Eject button	Used to eject floppy disks from the drive
2 Floppy disk drive door	Insert floppy disks here
3 Access lamp	Turns on when the floppy disk in the drive is being accessed



## (4) MEASUREMENT Section

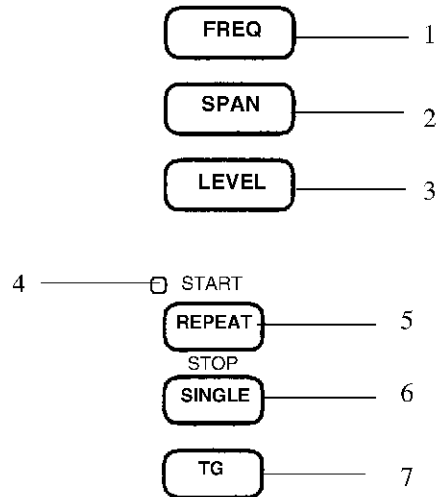

Control		Description
1	<b>FREQ</b> key	Used to set center frequencies
2	<b>SPAN</b> key	Used to set frequency spans
3	<b>LEVEL</b> key	Used to set the reference level
4	<b>SWEEP</b> lamp	Turns on when a sweep is being performed
5	<b>REPEAT (START/STOP)</b> key	Used to execute continuous sweeps or to reset a sweep
6	<b>SINGLE</b> key	Used to execute single sweeps or to reset a sweep
7	<b>TG</b> key	(Option) Used to control tracking generator output

2.1.1 Front Panel

(5) DATA Section

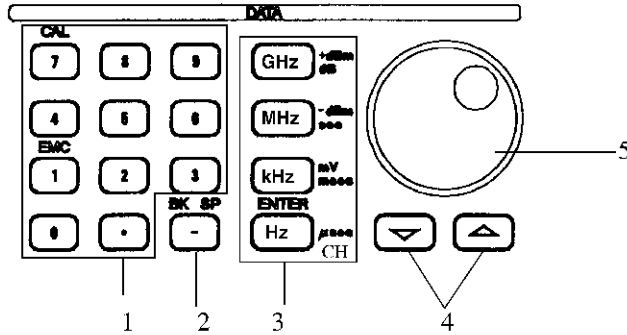

Control	Description
1 Numeric keys (additional function keys)  EMC  CAL	There are ten number keys (0 through 9) and a decimal point key. You can access additional functions by pressing the <b>SHIFT</b> key  Used to set up the conditions for an EMC measurement  Displays the Cal menu
2 -(BK SP) key	Used to remove data you have entered or to enter a minus(-) sign
3 Units keys  GHz key MHz key kHz key Hz (ENTER) key	These are used to select a unit and enter a value Sets GHz, + dBm or dB Sets MHz, - dBm, sec, V or W Sets kHz, mV, msec or mW Sets Hz, $\mu$ sec, CH, $\mu$ V or $\mu$ W This key is also used to specify the channel and as a general <b>ENTER</b> key
4 Step keys	Used to enter data in steps
5 Data knob	Used to make fine adjustments when inputting data

## (6) MARKER Section

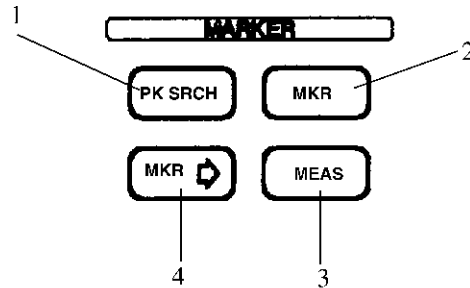

Control		Description
1	<b>PK SRCH</b> key	Used to search for the peak point on the trace
2	<b>MKR</b> key	Used to display the marker
3	<b>MEAS</b> key	Used to set the measurement mode
4	<b>MKR →</b> key	Used to obtain marker values so that they can be used as data for other functions

## (7) CONTROL Section

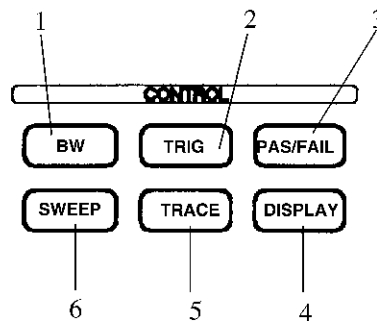

Control		Description
1	<b>BW</b> key	Used to set the resolution bandwidth (RBW) and video bandwidth (VBW)
2	<b>TRIG</b> key	Used to set the trigger conditions
3	<b>PAS/FAIL</b> key	Used to set the conditions in the limit line and check if those conditions have been met
4	<b>DISPLAY</b> key	Used to set the display line, the reference line, etc.
5	<b>TRACE</b> key	Used to set the trace function
6	<b>SWEEP</b> key	Used to set the sweep time

2.1.1 Front Panel

(8) SYSTEM Section

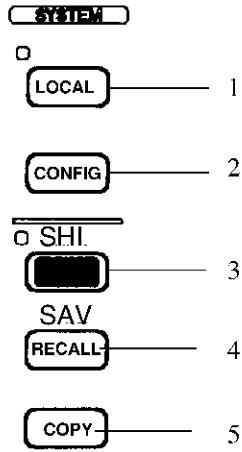

Control		Description
1	<b>LOCAL</b> key <b>REMOTE</b> lamp	Used to disengage GPIB remote control Indicates the spectrum analyzer is in Remote mode when lit
2	<b>CONFIG</b> key <b>PRESET</b> key ( <b>SHIFT, CONFIG</b> )	Used to set the operational conditions for the interface, etc. Used to reset the spectrum analyzer to the factory default settings
3	<b>SHIFT</b> key	Allows you to access additional functions for certain keys (keys that have labels in blue above them). The LED lamp next to the key turns on when SHIFT is pressed.
4	<b>RECALL</b> key <b>SAVE</b> key ( <b>SHIFT, RECALL</b> )	Used to recall previous data Used to save data
5	<b>COPY</b> key	Used to obtain a hard copy of the screen data

## (9) Miscellaneous Section

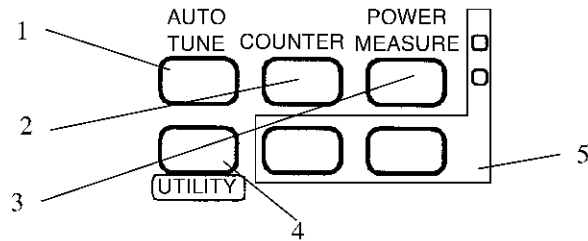

Control		Description
1	<b>AUTO TUNE</b> key	Used to automatically display the maximum peak
2	<b>COUNTER</b> key	Used to measure frequency as a counter
3	<b>POWER MEASURE</b> key	Used to make power measurements
4	<b>UTILITY</b> key	Used to set the measurement mode for the option
5		(Unused)

2.1.2 Screen Annotation

2.1.2 Screen Annotation

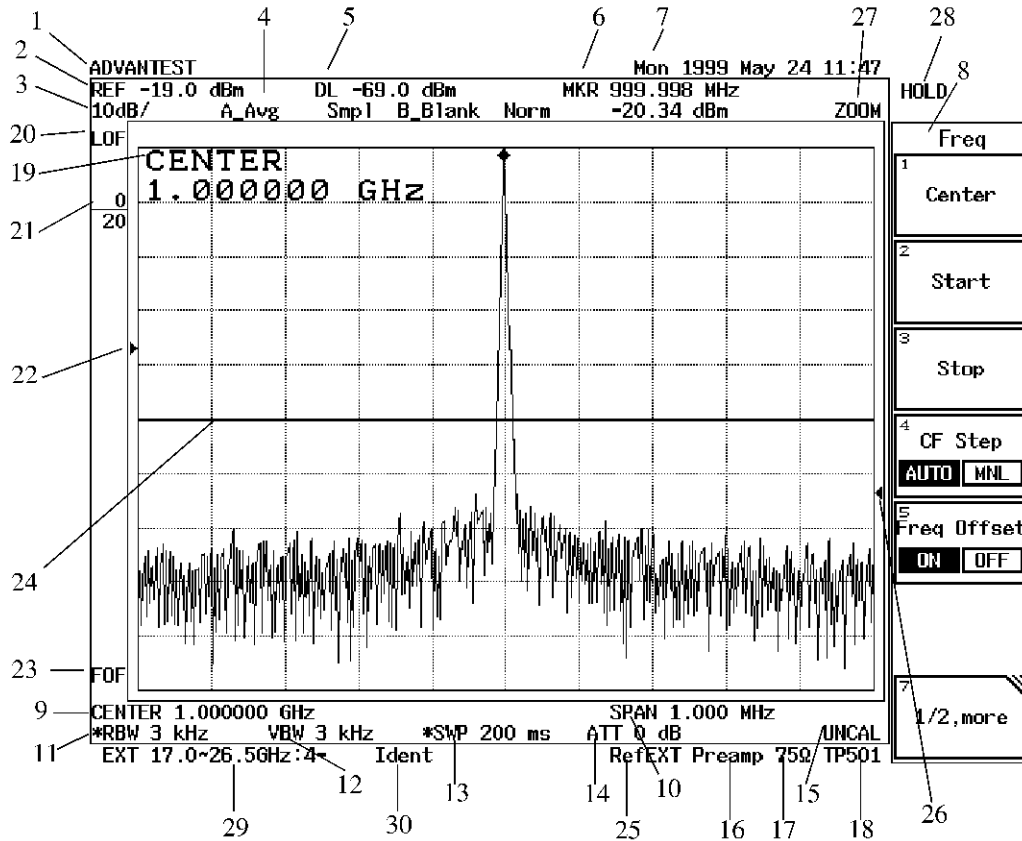

Figure 2-4 Screen Annotation

Annotation	Description
1	Title Displays the title you have entered to distinguish the current data from other data
2	Reference level Current reference level
3	Amplitude scale Current amplitude scale graduation
4	Trace Trace mode and search mode which are currently selected
5	Line setup display Shows values for the display line
6	Marker area Frequency and level of a marker
7	Date Current date and time
8	Soft-menu Menu item corresponding to the soft key
9	Center frequency or Start frequency Indicates the frequency at the center of the current display

	Annotation	Description
10	Frequency span or Stop frequency	Frequency span of the current display (displays may differ depending on the currently active function)
11	Resolution bandwidth (RBW)	Displays the current resolution bandwidth (RBW is preceded by an asterisk (*) when set in manual mode)
12	Video bandwidth (VBW)	Frequency selected for the video bandwidth filter. VBW value is preceded by an asterisk (*) when set in manual mode.
13	Sweep time	Time required to make a single sweep. SWP is preceded by an asterisk (*) when set in manual mode
14	RF attenuator	Current attenuator level. ATT is preceded by an asterisk (*) when set in the manual mode
15	UNCAL message	Indicates that the measurement has not been calibrated
16	Preamp indication	Indicates that Preamp is using.
17	75Ω mode indicator	Indicates that the input impedance is 75Ω (nothing is displayed if the input impedance is 50Ω).
18	Trace point indication	Indicates that the trace points are 501 points (nothing is displayed if the trace points are 1001 points).
19	Active area	Used to display the currently active functions (note that the data can be changed) and their related values
20	Level offset	Displayed when Level Offset is toggled on.
21	Average times	Indicates the number of sweep cycles and the current number of times frequencies has been swept.
22	Video and external trigger levels	Indicates the current trigger level.
23	Frequency offset	Displayed when Frequency Offset is toggled on.
24	Display Line	Indicates the current display line.
25	10MHz External	Displayed when the external 10-MHz signal is used as the reference signal.
26	Squelch level	Indicates the level where the voice is demodulated.
27	Multi-screen mode	ZOOM, F/T, T/T, ACP, GATE or FMLN(OPT73) is displayed in Multi-screen mode.
28	HOLD mode	Indicates that panel keys are locked in the HOLD mode.
29	External mixer mode setting display	Displays frequency ranges, harmonic orders and harmonic polarities.
30	Signal identification function display	Displays whether the Signal Identification function (Ident) or Software Image Suppression function (Suppr) is turned on.

2.1.3 Rear Panel

2.1.3 Rear Panel

This subsection shows the rear panel and describes its terminals and connectors.

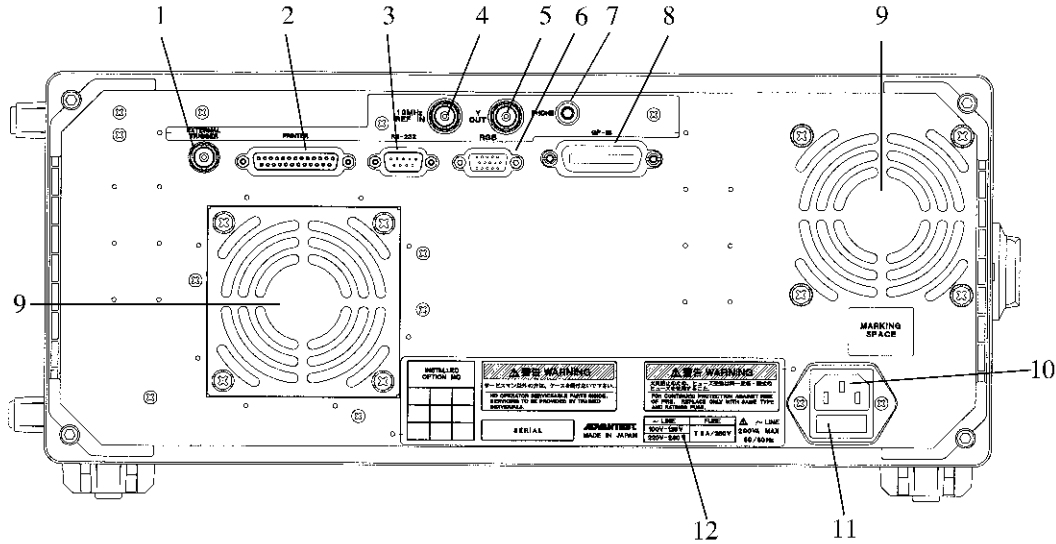

Figure 2-5 Rear Panel

Control		Description
1	<b>EXTERNAL TRIGGER</b> terminal	The input impedance is approximately 10 k $\Omega$ . The R3132 and R3162 start sweeping frequencies when the input signal rises or trails. (The timing is selectable.) This signal can be used as the gated sweep signal source.
2	<b>PRINTER</b> connector	Connector used when attaching a Centronix printer
3	<b>RS-232</b> connector	Connector for an external unit used to control the spectrum analyzer through an RS-232 interface
4	<b>10 MHz REFERENCE INPUT</b> terminal	Input terminal for 10 MHz reference frequency signal Input impedance: Approximately 500 $\Omega$ Input level: -10 dBm to +10 dBm
5	<b>Y-OUT</b> terminal	10 dB/div Y signal output
6	<b>RGB</b> connector	Connector for an external monitor compatible with VGA specifications.
7	<b>PHONE</b> connector	Connector for an 8 $\Omega$ earphone used for AM/FM demodulated audio output
8	<b>GPIB</b> connector	Connector for an external controller cable



Control		Description
9	Exhaust vent	Used to vent excess heat buildup in the spectrum analyzer CAUTION: Do not block this vent
10	AC power connector	3-pin type
11	Fuse holder	Holds the line fuse and one spare fuse which is supplied with the spectrum analyzer
12	Fuse information	Lists the line voltages and fuse requirements

2.2 Basic Operation

**2.2 Basic Operation**

**2.2.1 Operating Menus and Entering Data**

You use panel keys and soft keys to operate the spectrum analyzer. When you press a panel key, a menu is usually displayed on the right side of the screen. However, there are some keys, such as **AUTO TUNE** and **COPY**, which do not have an associated soft menu.

Each menu selection is aligned with a soft key. To make a menu selection, press the associated soft key. In some cases, pressing the soft key displays additional selections. The following example shows how the panel and soft keys function.

(1) Selecting the Menu

Press **LEVEL** to display the menu used for setting up a measurement.

A reference level value is displayed in the active area, and the Level menu is displayed on the right side of the screen as shown below.

```

Ref Level
ATT AUTO/MNL
dB/div
Linear
Units
Hi Sens ON/OFF
1/2_more
    
```

(2) Entering Data

When a value is displayed in the active area, you can change it using the numeric keys, the step keys, or the data knob.

- Entering Data Using the Numeric Keys

You use the following keys to enter data: the number keys (0 through 9), the decimal point key, and the backspace (**BK SP**) or minus (-) key. If you make a mistake when using the numeric keys, you can use the backspace (**BK SP**) key to delete the last digit entered. If you have not entered any data, pressing the **BK SP** key enters a minus (-) sign. After entering the data, pressing the **ENTER** key or one of the other unit keys completes the operation.

---

*NOTE: Data entered with the numeric keys that is not terminated with a units terminator is aborted when you press any panel key. In addition, there is a possibility that displayed data may have a unit different from that of the value entered resulting in the displayed number being different from the number entered even though the two values are the same.*

---

Example: The following example sets the reference level to -20 dBm using the numeric keys: Press the **-, 2, 0 and GHz(+dBm)** keys or the **2, 0 and MHz(-dBm)** keys.

- Entering Data Using the Step Keys

The step keys are used to enter data by a predefined step size. Press the ▼ step key to decrement the data; press the ▲ step key to increment the data. You can enter data while looking at the active area on the screen using the step keys.

Example: The following example sets the reference level to 0.0 dBm using the step keys:

Press the ▼ step key. This sets the reference level to -10.0 dBm. If you press the ▲ step key once more, the level is set to 0.0 dBm.

- Entering Data Using the Data Knob

The data knob is used to enter data in units of predefined display resolution. This is convenient when making fine adjustments to data which has already been entered.

Example: To set the reference level to 0.5 dBm using the data knob, turn the knob clockwise.

This increases the reference level in increments of 0.1 dBm.

Continue to turn it until the indication in the active area is 0.5 dBm.

Turning the data knob counter clockwise decreases the reference level.

- ACTIVE OFF

Pressing **ACTIVE OFF** turns off the active area and removes any information displayed. You cannot enter data if the active area is off. To turn the active area on again, press any panel or soft key.

(3) Menu structure

You can access the following submenu by pressing either *1/2\_more* or the soft key with a mark in the right-hand corner.

In addition, there is another type of soft key which is used to toggle between two settings (ON/OFF, AUTO/MNL etc.). The current setting is displayed with a red box around it.

Pressing **MKR** displays the Marker menu as shown below.

*Normal*  
*Delta*  
*Peak Menu*  
*Sig Track ON/OFF*  
*MKR Trace A/B*  
*Marker OFF*  
*1/2\_more*

- Displaying submenus

Pressing the soft key with a mark in the right-hand corner displays a submenu as shown below. Press *Peak Menu*. The following Peak menu is displayed.

*Next Peak*  
*Next Peak Left*  
*Next Peak Right*  
*Next Peak Max-Min*  
*Min Peak*  
*Cont Peak ON/OFF*  
*1/2\_more*

- Switching between settings

To switch the currently active setting for soft keys such as AUTO/MNL, press the key. Pressing the key again changes back the setting. A selected item and an unselected item are displayed in white characters and black characters, respectively.

Example: Press *Cont Peak ON/OFF*.

ON is selected to execute marker peak search for each sweep. Press the Cont Peak again to return to OFF.

### 2.2.1 Operating Menus and Entering Data

- RETURN  
Used to go back to displaying the Marker menu.  
Press **RETURN** to return from the submenu to the original menu.
- 1/2\_more and 2/2\_more  
Pressing *1/2\_more* shows the rest of the soft key menu (those items not currently visible). Likewise, pressing *2/2\_more* at the bottom of this display returns to the top of the soft key display (the previous set of items).  
Press *1/2\_more*. The rest of the Marker menu (menu 2), is displayed as shown below.  
*Fixed MKR ON/OFF*  
*MKR Step AUTO/MNL*  
*Multi Marker*  
*2/2\_more*  
  
Press *2/2\_more*. The previous items (menu 1) are displayed.

#### (4) Using SHIFT

**SHIFT** is used to select the functions that are labeled in blue above the panel keys. There are four such functions:

- PRESET
- SAVE
- CAL
- EMC

To select one of these functions, press **SHIFT** and the desired panel key. Pressing **SHIFT** lights the adjacent LED indicating that the Shift function is active. To cancel the shift function before selecting a blue-labeled function, press **SHIFT** a second time. The green LED goes off, indicating that the Shift function is no longer active. **SHIFT** is also used to activate the hold function which disables the data knob: the hold function is activated when you press **SHIFT** until the green LED goes off. When you want to disable the hold function, repeat the above procedure; when the LED goes off, the hold function has been reset.

#### (5) Dialog boxes

Pressing some soft keys will display a dialog box. One or more of the following operations may be required.

- To select items  
Use the data knob to select items.
- To select conditions  
Use the step keys to select conditions, then press the corresponding unit (ENTER) keys to set them.
- To enter numeric values  
Use the numeric keys and the corresponding unit keys.
- To close the dialog box  
Press the same key that was used to open the dialog box again.

## 2.2.2 Displaying Spectrums and Operating the Markers

As an example, the procedure for measuring the difference between calibration signal level and secondary harmonic signal level is explained below.

Power on

---

**NOTE:** *To take accurate measurements, use the spectrum analyzer within the specified temperature range, and wait at least 30 minutes after turning the power on before using it. For these practice examples, you do not need to warm up the spectrum analyzer.*

---

1. Make sure that the **POWER** switch on the front panel is in the OFF position.
2. Connect the power cable provided to the AC power supply connector on the rear panel.

---

**CAUTION:** *To avoid damage, operate the spectrum analyzer within the specified input voltage and frequency ranges.*

---

3. Connect the power cable to the outlet.
4. Turn the **POWER** switch on.  
When the self-test has completed, the startup screen is displayed.

---

**NOTE:** *The screen display after the power-on may differ from the one shown here due to previous settings.*

---

Initialization

This resets the current settings to the factory defaults.

5. Press **SHIFT**.  
This activates the shift mode so that functions labeled in blue can be used.
6. Press **CONFIG(PRESET)**.  
This resets all spectrum analyzer settings.

2.2.2 Displaying Spectrums and Operating the Markers

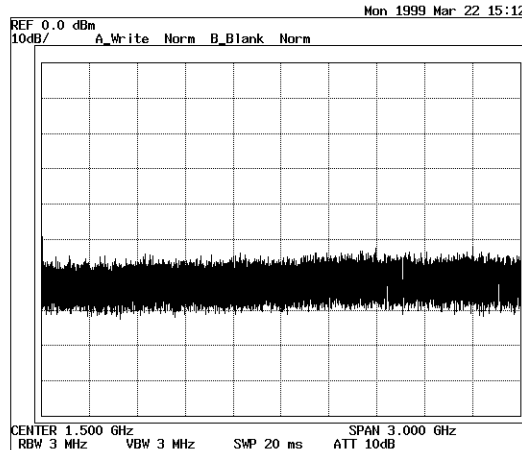

**Figure 2-6 Factory Defaults Screen**

Input signal connection

Connect the calibration signal used for the measurement.

7. Connect the N-BNC adapter to the INPUT connector on the front panel.  
For the R3182, first connect the SMA-SMA adapter to the SMA-BNC adapter, then connect this combined adapter to the INPUT connector on the front panel.
8. Connect the INPUT connector and the CAL OUT connector on the front panel using the input cable provided as an accessory.

Setting the measurement conditions

This changes the analyzer settings so that the input signal is displayed more clearly.

9. Press **FREQ**.

The current center frequency is displayed in the active area, and the Freq menu used to select the frequency type appears on the right.

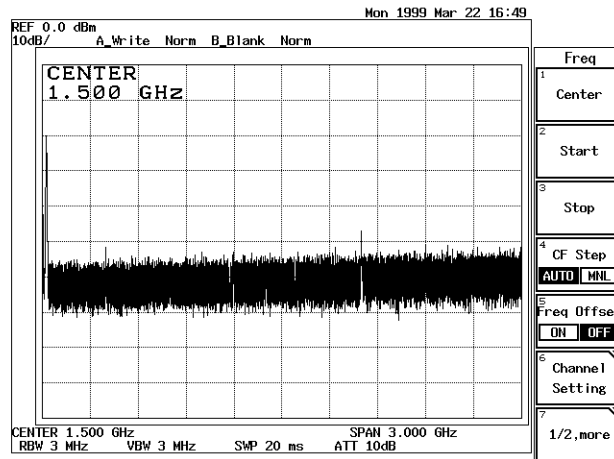

Figure 2-7 Active Area Display

10. Press **5, 0** and **MHz**.

A center frequency of 50 MHz is set.

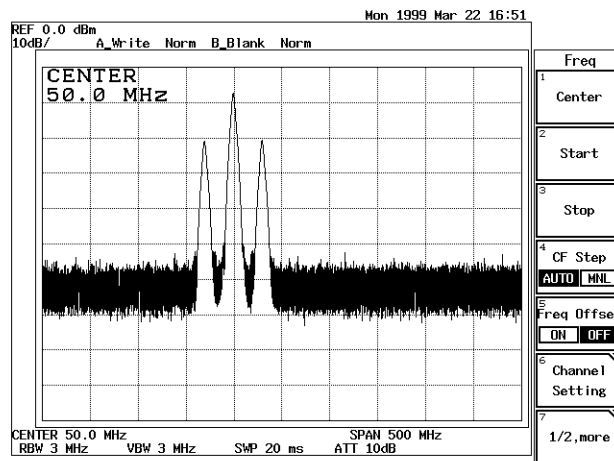

Figure 2-8 Setting the Center Frequency

11. Press **SPAN**.

The current frequency span is displayed in the active area, and the Span menu used for setting the frequency span appears on the right.

12. Press **8, 0** and **MHz**.

A frequency span of 80 MHz is set.

13. Press **LEVEL**.

The current reference level is displayed in the active area, and the Level menu used for setting the level appears on the right.

2.2.2 Displaying Spectrums and Operating the Markers

14. Press **2, 0, MHz(-dBm)**.  
A reference level of -20 dBm is set.

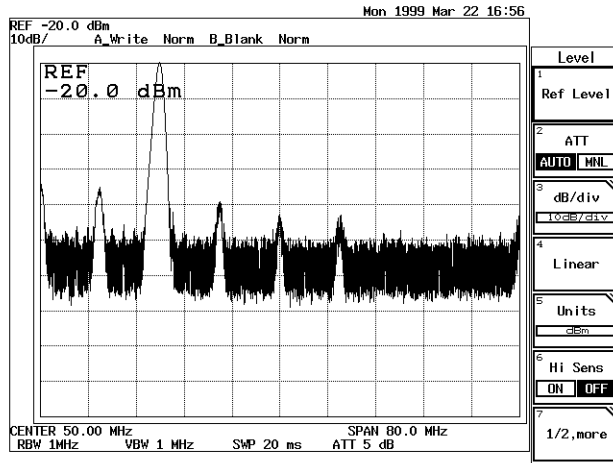

Figure 2-9 Measuring Settings Screen

Displaying a marker on the trace peak

15. Press **PK SRCH**.  
The marker is displayed on the trace peak, and the marker frequency (approximately 30 MHz) and level (approximately -20 dBm) are listed in the marker area.

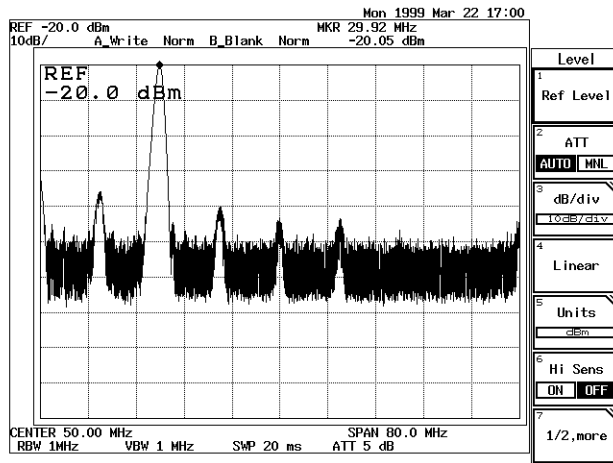

Figure 2-10 Peak Search Display Screen

Using the delta marker

16. Press **MKR**.  
The Marker menu used with the marker function is displayed.
17. Press **Delta**.  
The delta marker is displayed on the trace peak, and the differences between the marker and delta marker frequency and level are listed in the marker area.



18. Press **3**, **0**, and **MHz(-dBm)**.  
The active marker gets a secondary harmonic signal at a distance of 30 MHz.  
Move the marker to the signal peak using the data knob.  
The marker area displays the frequency difference and the level difference between the two signals.

## 2.2.3 Measuring Window and the Display Line

### 2.2.3 Measuring Window and the Display Line

This section describes the measuring window which is used to display measurements within a limited area, and the display and reference lines which are used to compare traces.

#### Power on

1. Turn the spectrum analyzer power on.

#### Initialization

This resets the current settings to the factory defaults.

2. Press **SHIFT** and **CONFIG(PRESET)**.  
The default settings have now been reset.

#### Input signal connection

Connect the calibration signal used for the measurement.

#### Setting the measurement conditions

This changes the analyzer settings so that the input signal is displayed more clearly.

3. Press **FREQ, 3, 0** and **MHz**.  
A center frequency of 30 MHz is set.
4. Press **SPAN, 5, 0** and **MHz**.  
A frequency span of 50 MHz is set.
5. Press **LEVEL, 2, 0** and **MHz(-dBm)**.  
A reference level of -20 dBm is set.

#### Activating the display line

The display line is convenient for comparing one trace level to another.

6. Press **DISPLAY** and **Disp Line ON/OFF(ON)**.  
The display line is activated.
7. Move the display line vertically so that it aligns with the peak on the right side by turning the data knob.  
This makes it easier to compare trace levels.

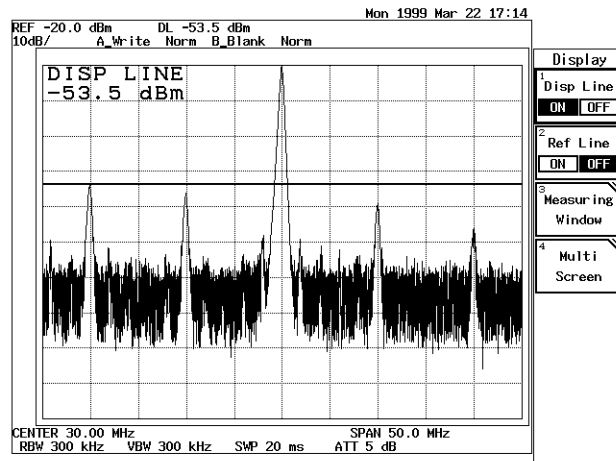

Figure 2-11 Activating the Display Line

Activating the reference line

This activates the reference line allowing you to enter reference level settings.

8. Press **Ref Line ON/OFF**(ON).  
The reference line appears, and the reference level can now be set.
9. Move the reference line vertically until it is aligned with the maximum peak so that you can obtain a display line value relative to the maximum peak.

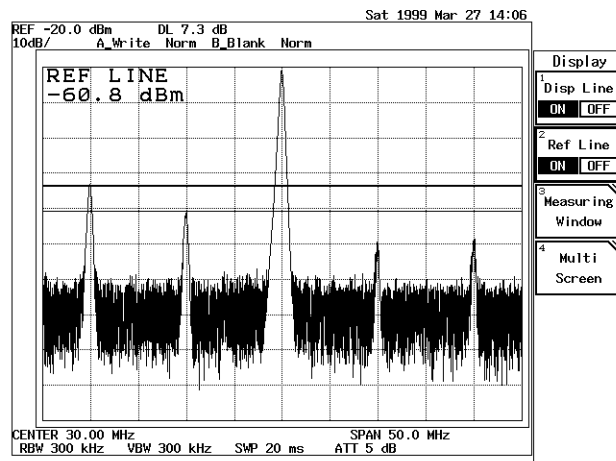

Figure 2-12 Making a Comparison Between Peaks Using Reference Lines

2.2.3 Measuring Window and the Display Line

Removing the lines

This removes the display and reference lines.

10. Press **Disp Line ON/OFF** two times.  
OFF is selected and the display line is removed.
11. Press **Ref Line ON/OFF** two times.  
OFF is selected and the reference line is removed.

Setting up the measuring window

12. Press **Measuring Window**.  
The measuring window appears and the Window menu associated with the window settings is displayed.  
The frequency for the current window position is listed in the active area, and the window position can now be changed.
13. Move the measuring window by turning the data knob so that the measuring window center is aligned with the center of the peak to the right.
14. Press **Window Width, 5, and MHz**.  
The width of the measuring window is set to 5 MHz.  
(The width depends on the set frequency span.)

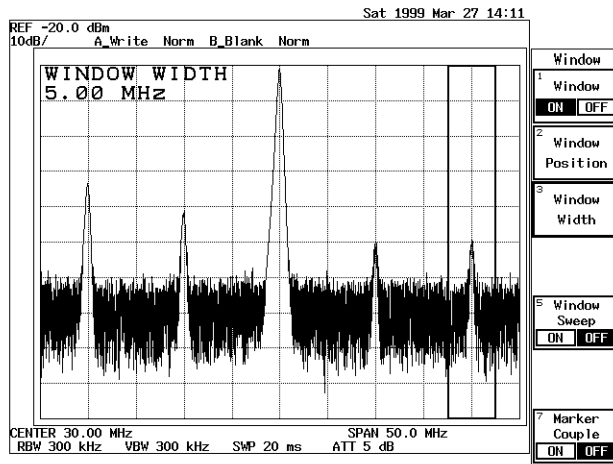

Figure 2-13 Screen Display Showing the Measuring Window

Stopping/starting a sweep within the measuring window:

15. Press **Window Sweep ON/OFF(ON)**.  
The area within the measuring window is swept.
16. Press **Window Sweep ON/OFF(OFF)**.  
The area within the measuring window is not swept.

Removing the window

17. Press **Window ON/OFF**(OFF).  
The measuring window is turned off.

## 2.2.4 Measuring Frequency Using Counter

The counter function measures the signal frequency at the marker with high accuracy.

You do not have to precisely position the marker on the peak you wish to measure however you should note that the displayed amplitude value corresponds to the marker position.

The maximum resolution possible for the counter function display is 1 Hz. As the resolution becomes higher, the gate time becomes longer. As a result, the sweep period becomes longer.

---

### NOTE:

1. *The counter function may not work normally if the span is greater than 200 MHz or the difference between the marker and the noise level is 25 dB or less.*
  2. *The signal track mode cannot be used with this function.*
- 

The following example shows how to measure the frequency.

Power on

1. Turn the spectrum analyzer power on.

Initialization

This resets the current settings to the factory defaults.

2. Press **SHIFT** and **CONFIG(PRESET)**.  
The default settings have now been reset.

Input signal connection

Connect the calibration signal used for the measurement.

Setting the measurement conditions

This changes the analyzer settings so that the input signal is displayed more clearly.

3. Press **FREQ, 3, 0** and **MHz**.  
A center frequency of 30 MHz is set.
4. Press **SPAN, 5, 0** and **MHz**.  
A frequency span of 50 MHz is set.

2.2.4 Measuring Frequency Using Counter

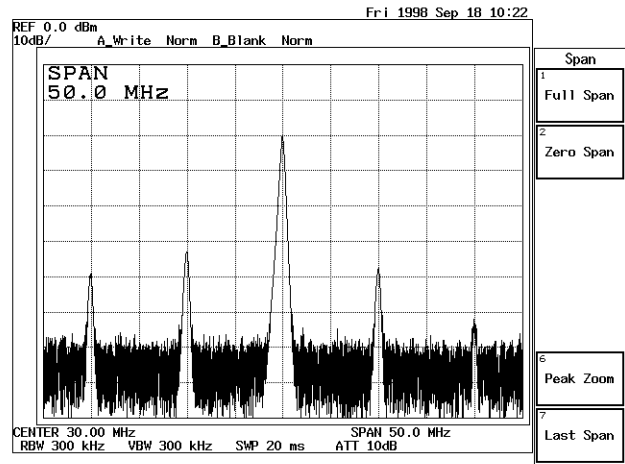

Figure 2-14 Measuring Settings Screen

Measuring frequency by counter

This measures the frequency using the counter function.

- Press **COUNTER**.  
The Counter menu (used for setting the frequency counter resolution) and the Frequency Counter window are displayed. The default resolution is 1 kHz.

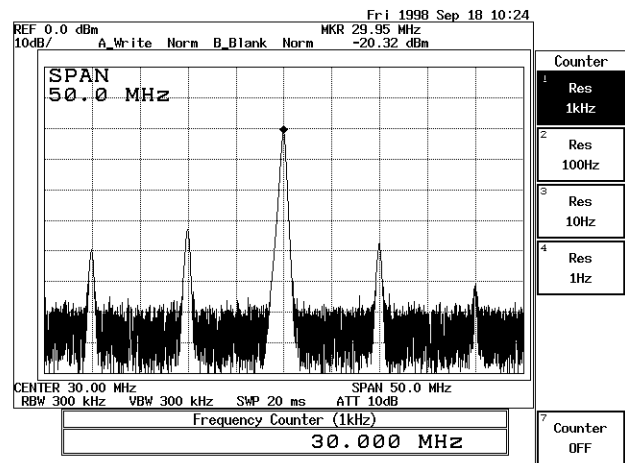

Figure 2-15 Frequency Counter Measurement (Resolution: 1 kHz)

6. Press **Res 10 Hz**.  
The frequency counter resolution is set to 10 Hz and is displayed in the Frequency Counter window.

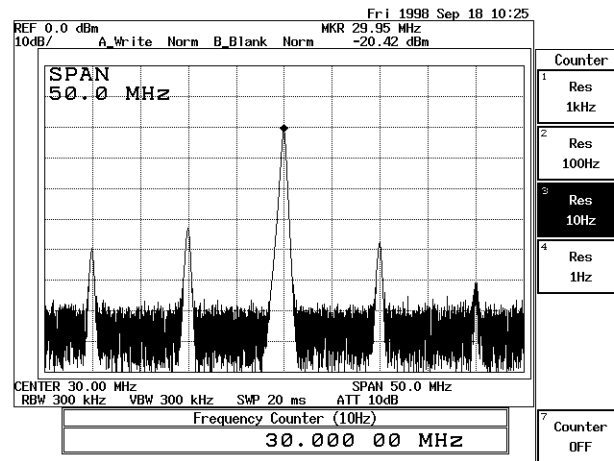

Figure 2-16 Frequency Counter Measurement (Resolution: 10 Hz)

7. Press **Counter OFF**.  
The counter function is turned off.

## 2.2.5 Auto Tuning

You can display a signal with an unknown frequency using the auto tuning function.

Power on

1. Turn the spectrum analyzer power on.

Initialization

This resets the current settings to the factory defaults.

2. Press **SHIFT** and **CONFIG(PRESET)**.  
The default settings have now been reset.

Input signal connection

Connect the calibration signal used for the measurement.

Frequency span

This sets the frequency span in preparation for auto-tuning.

3. Press **SPAN, 1** and **MHz**.  
A frequency span of 1 MHz is set.

2.2.5 Auto Tuning

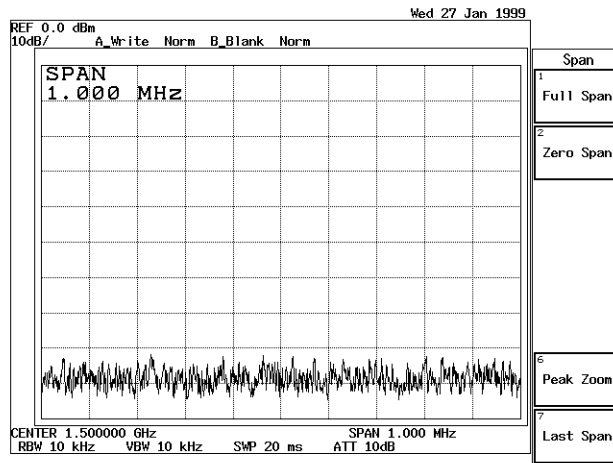

Figure 2-17 Screen Display Prior to Auto Tuning

Auto tuning

4. Press **AUTO TUNE**.  
Normally, peak searches cover the entire band, and the span gradually returns to the original setting by keeping track of that peak signal. With this function, the maximum peak is automatically displayed. The reference level is set to the tuned peak level under these conditions.

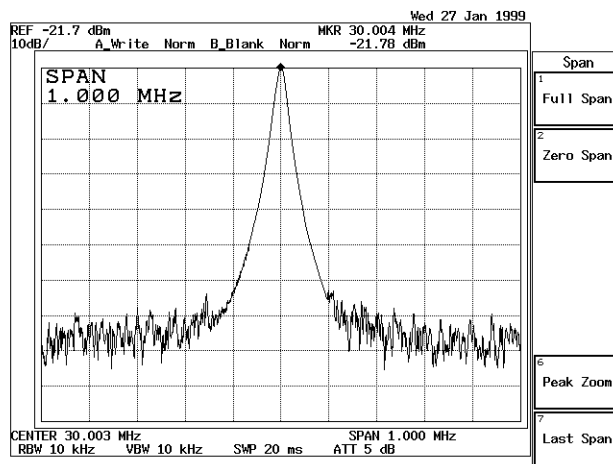

Figure 2-18 Screen Display after Auto Tuning



## 2.2.6 Tracking Operations

Tracking operations consist of signal tracking (which is useful for measuring a signal whose frequency is variable) and continuous peak search functions.

### Power on

1. Turn the spectrum analyzer power on.

### Initialization

This resets the current settings to the factory defaults.

2. Press **SHIFT** and **CONFIG(PRESET)**.  
The default settings have now been reset.

### Input signal connection

Connect the calibration signal used for the measurement.

### Setting the measurement conditions

This changes the analyzer settings so that the input signal is displayed more clearly.

3. Press **FREQ, 2, 9, ., 9, 9** and **MHz**.  
A center frequency of 29.99 MHz is set.
4. Press **SPAN, 5, 0** and **kHz**.  
A frequency span of 50 kHz is set.

### Signal tracking

This function performs a peak search using a signal with the marker in each sweep, and the detected frequency is set to the center frequency. The detected peak frequency is always set as the center frequency.

5. Press **PK SRCH, MKR** and **Sig Track ON/OFF(ON)**.  
Signal tracking is turned on. The detected peak frequency is always set as the center frequency even if the input signal frequency varies.

---

**NOTE:** *When the signal tracking function has been turned on and ten keys are used to change the frequency span, the auto-zooming function automatically tracks the signal and changes the frequency span until an optimum span is achieved.*

---

2.2.6 Tracking Operations

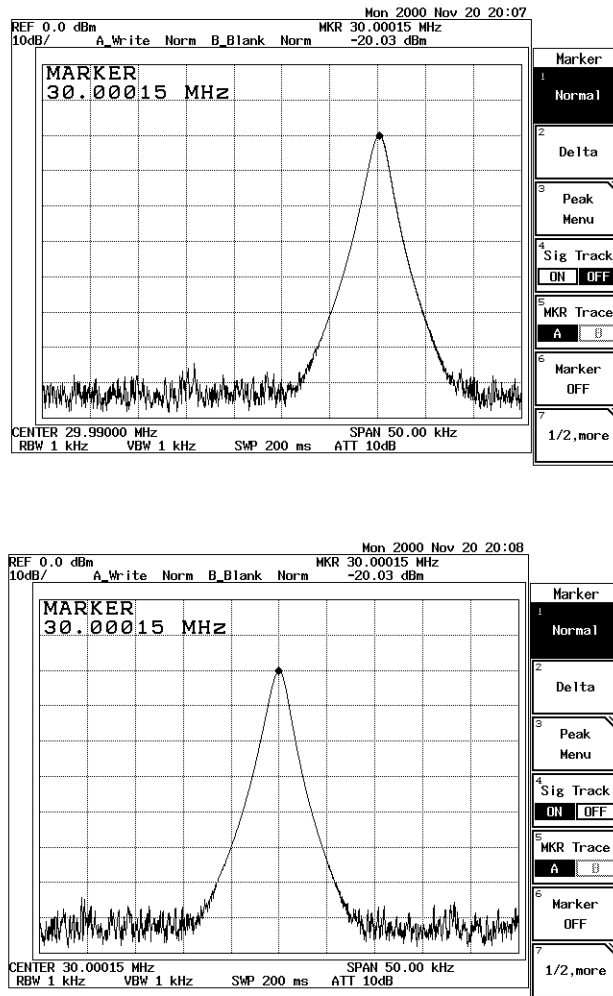

Figure 2-19 Signal Tracking Screen

6. Press **Sig Track ON/OFF(OFF)**.  
Signal tracking is turned off.

Continuous peak search

This function allows you to detect a peak and move the marker to the peak in each sweep. If the delta marker is being used at that time, the normal marker is displayed on the peak and the delta marker is displayed the delta frequency away from the peak (unless the zero span is set).

7. Press **Peak Menu** and **Cont Peak ON/OFF(ON)**.  
The Cont peak search is turned on. A peak is detected in each sweep and the marker is always moved to that peak even if the input signal frequency varies.
8. Press **Cont Peak ON/OFF(OFF)**.  
Continuous peak search is turned off.

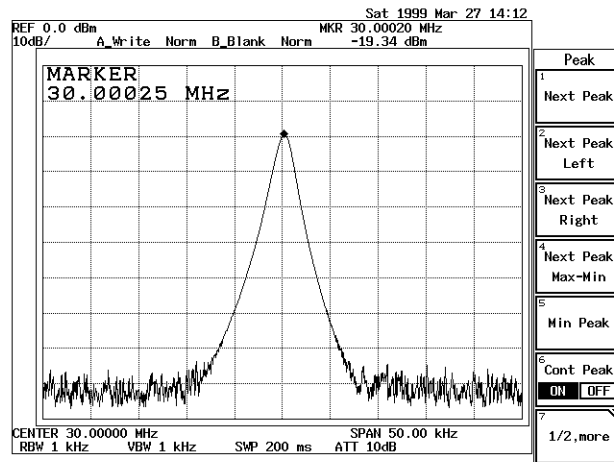

Figure 2-20 Continuous Peak Search Screen

## 2.2.7 UNCAL Message

The settings of the resolution bandwidth (RBW), video bandwidth (VBW), frequency span (SPAN) and sweep time (SWP) are interrelated. The message UNCAL is displayed in the lower right of the screen when any item is inappropriately set. If this happens, proceed as follows to remove the UNCAL message.

- Make the resolution bandwidth (RBW) wider.
- Make the video bandwidth (VBW) wider.
- Make the sweep time (SWP) longer.
- Make the frequency span (SPAN) narrower when the RBW or VBW cannot be changed.

---

**CAUTION** *Measured data may be inaccurate if you take measurements while the UNCAL message is displayed.*

---

In this section, the following example shows how to remove an UNCAL message, which was caused by making the sweep time shorter, by changing the RBW setting.

Power on

1. Turn the analyzer and the signal generator power on.

Initialization

This resets the current settings to the factory defaults or user-defined presets.

2. Press **SHIFT** and **CONFIG(PRESET)**.  
This sets the analyzer to its presets values.

2.2.7 UNCAL Message

Input signal connection

Connect the calibration signal used for the measurement.

Setting the measurement conditions

3. Press **FREQ, 3, 0** and **MHz**.  
A center frequency of 30 MHz is set.
4. Press **SPAN, 5, 0** and **kHz**.  
A frequency span of 50 kHz is set.  
The following are automatically set:  
RBW = 1 kHz, VBW = 1 kHz, Sweep time = 200 ms.
5. Press **SWEEP, SWP Time AUTO/MNL(MNL), 4, 0** and **kHz(ms)**.  
Sweep time is set to 40 ms and UNCAL is displayed in the lower right hand on the screen. A Sweep time of 40 msec is too short.

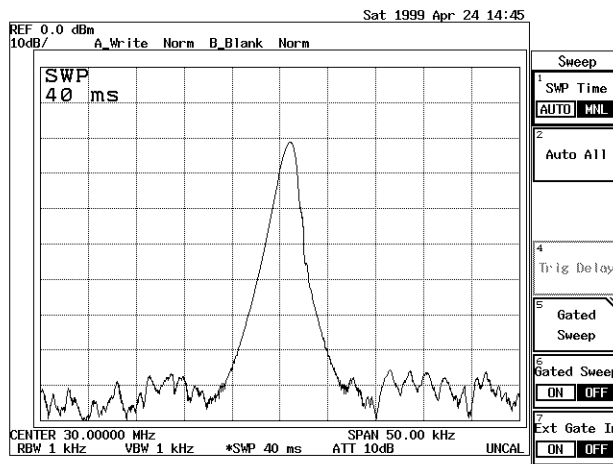

Figure 2-21 Screen with UNCAL Message

Coping with the UNCAL message

6. Press **BW, RBW AUTO/MNL(MNL), 3** and **kHz**.  
Once the RBW is set to 3 kHz, the UNCAL message will disappear because a sweep time of 40 msec meets the required condition.

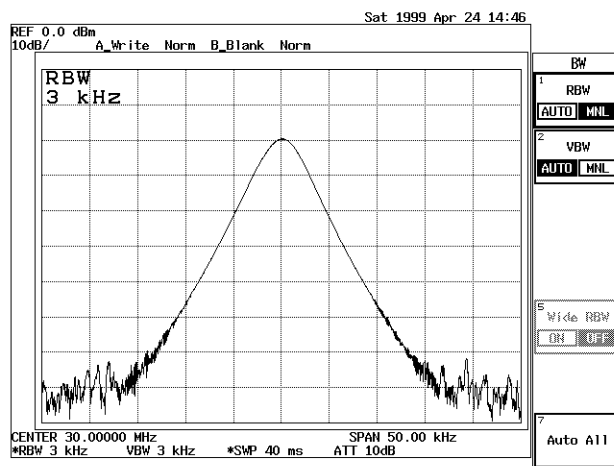

Figure 2-22 UNCAL Message Removed

### 2.2.8 Separating Two Signals

This section describes how RBW should be set to properly observe adjacent signals using the spectrum analyzer.

Setup

1. Connect the signal generators as shown in Figure 2-23.

R3132 Series Spectrum analyzer

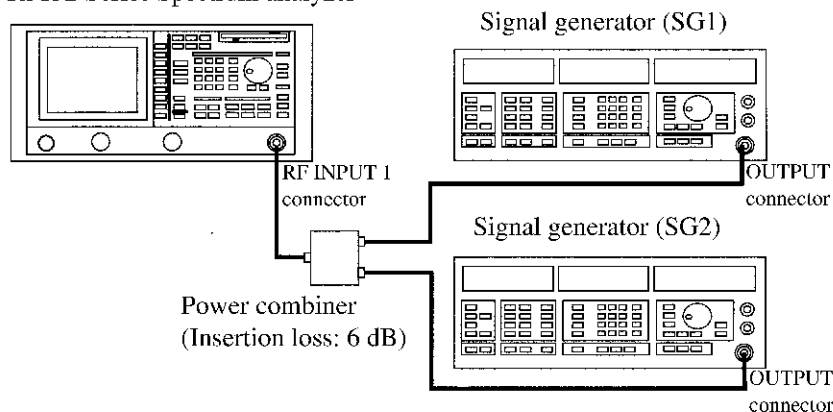

Figure 2-23 Setup for Measuring Two Signals Separately

Power on

2. Turn the power on.

2.2.8 Separating Two Signals

Setting the signal generators

This prepares the signal generators for output.

3. Set the SG1 frequency to 200.00 MHz; the SG1 level to -10 dBm; and the SG1 output to ON.
4. Set the SG2 frequency to 200.25 MHz; the SG2 level to -20 dBm; and the SG2 output to ON.

Initialization

This resets the current settings to the factory defaults.

5. Press **SHIFT** and **CONFIG(PRESET)**.  
The default settings have now been reset.

Setting the measurement conditions

This changes the analyzer settings so that the input signal is displayed more clearly.

6. Press **FREQ, 2, 0, 0** and **MHz**.  
A center frequency of 200 MHz is set.
7. Press **SPAN, 1, 0** and **MHz**.  
A frequency span of 10 MHz is set.

The spectrums are not fully separated because the RBW default setting is 100 MHz. As a result, the display shows only one input signal even though there are actually two.

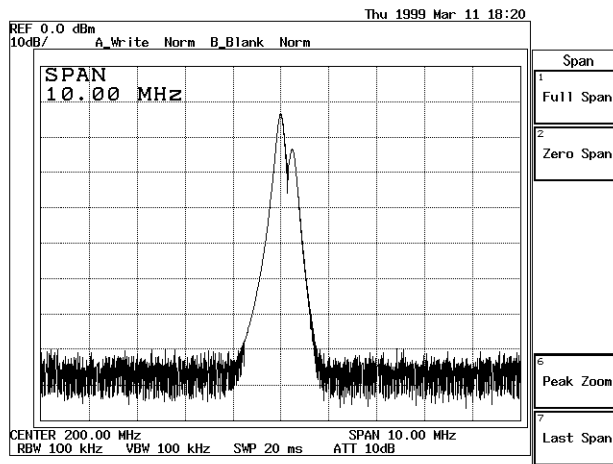

Figure 2-24 Two Superimposed Peaks

8. Press **BW, RBW AUTO/MNL(MNL), 3, 0** and **kHz**.  
The RBW is set to 30 kHz.  
Two peaks are now discernible but they are still not clearly separated.

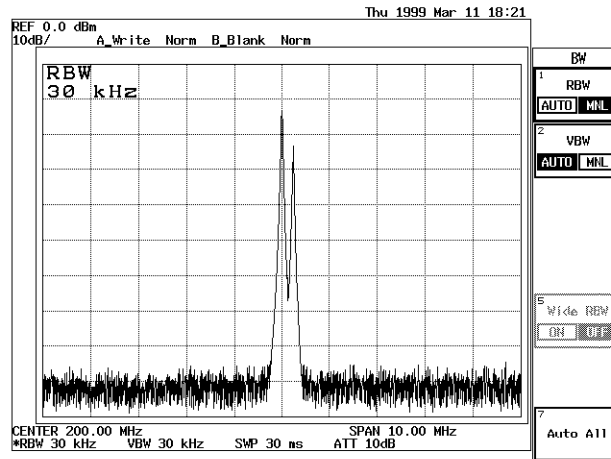

Figure 2-25 Two Discernible Peaks

9. Press **1, 0** and **kHz**.  
The RBW is set to 10 kHz.  
Two peaks can now be distinctly seen.

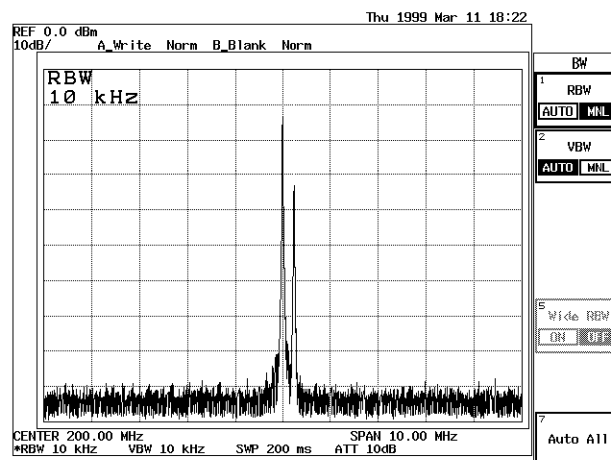

Figure 2-26 Two Distinct Peaks Can Now Be Seen

2.2.9 Measuring low level signals

### 2.2.9 Measuring low level signals

Reducing the noise level allows you to measure low-level signals. The noise level can be reduced by narrowing the resolution bandwidth. If the video bandwidth is set or the averaging function is used, you can observe the signals that are lost in the noise. Additionally, using the built-in pre-amplifier allows you to measure still lower level signals.

Setup

1. Connect the signal generator as shown in Figure 2-27.

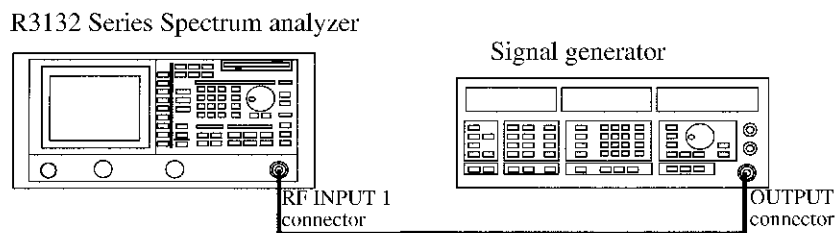

**Figure 2-27 Setup for Verifying the Dynamic Range**

Power on

2. Turn the power on.

Setting the signal generator

This prepares the signal generators for output.

3. Set the SG frequency to 200 MHz; the SG1 level to -80 dBm; modulation mode to non-modulated; and output to ON.

Initialization

This resets the current settings to the factory defaults

4. Press **SHIFT** and **CONFIG(PRESET)**.  
The default settings have now been reset.

Setting the measurement conditions

This changes the analyzer settings so that the input signal is displayed more clearly.

5. Press **FREQ, 2, 0, 0** and **MHz**.  
A center frequency of 200 MHz is set.
6. Press **SPAN, 5, 0, 0** and **kHz**.  
A frequency span of 500 kHz is set.



7. Press **LEVEL, 5, 0** and **MHz(-dBm)**.  
The reference level is set to -50 dBm.

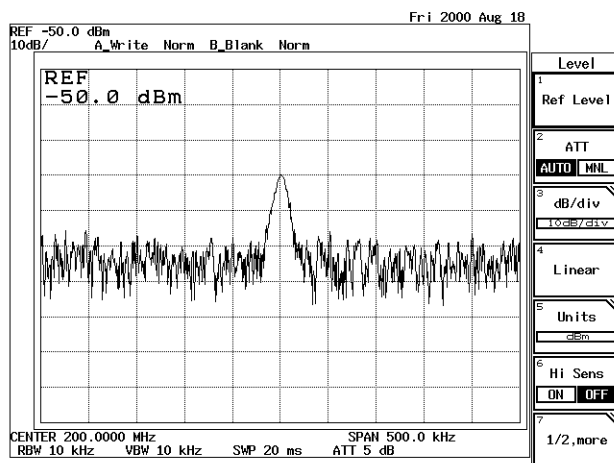

Figure 2-28 Screen Display Prior to Changing the RBW

#### Changing the RBW

The RBW default setting is 10 kHz. The noise level can be reduced by decreasing this value.

8. Press **BW, RBW AUTO/MNL(MNL), 1** and **kHz**.  
The RBW mode is changed to manual, and the resolution bandwidth is set to 1 kHz. As a result, the dynamic range has increased and this has reduced the noise level by approximately 10 dB.

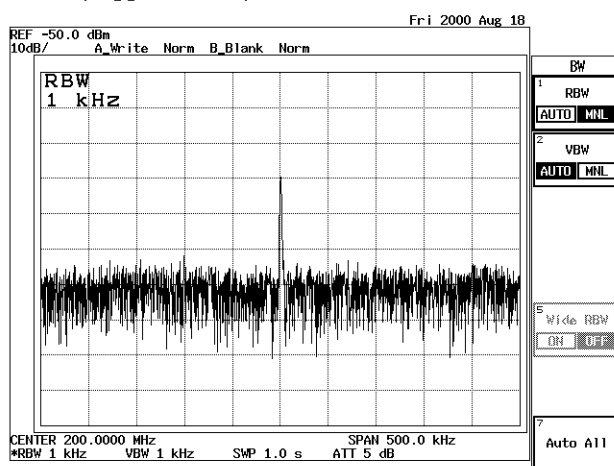

Figure 2-29 Screen Display after Changing the RBW

#### Changing VBW

The noise width can be further reduced by setting the VBW to 1/10 of the RBW.

2.2.9 Measuring low level signals

9. Press **VBW AUTO/MNL(MNL)**, **1, 0, 0** and **Hz**.  
 VBW is set to MNL, and a video resolution bandwidth of 100 Hz is entered. As a result, the noise width has been reduced.

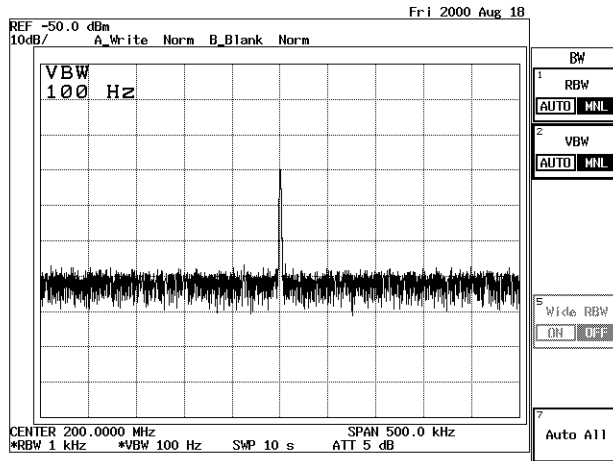

Figure 2-30 Screen Display after Changing the VBW

10. Press **BW** and **VBW AUTO/MNL(AUTO)**.  
 The VBW function is switched to the AUTO mode.

Performing the averaging function

This function can improve the S/N ratio faster than the VBW method shown above. This function makes it possible to quantify random components and measure signals buried in the noise.

11. Press **TRACE**, **1/2\_more** and **AVG A**.  
 AVG A (with a default setting of 20) has reduced the noise level considerably.

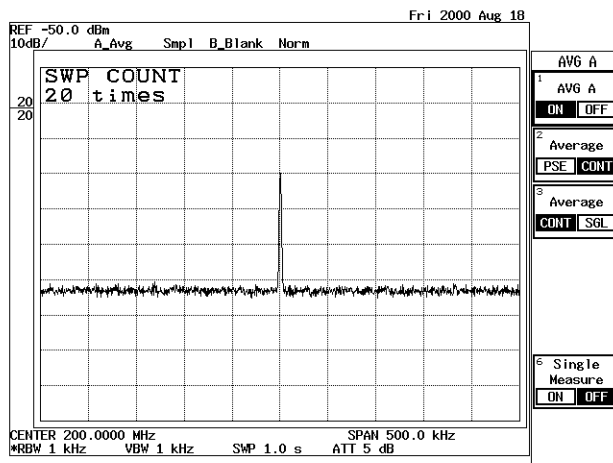

Figure 2-31 The Trace after Averaging

## Built-in pre-amplifier

The analyzer include a pre-amplifier for frequency band of 3 GHz and are available for high sensitive measurements.

The averaging function is turned off, and the RBW and VBW functions are set to AUTO mode.

12. Press **AVG A ON/OFF(OFF)**.  
The averaging function is turned off.
13. Press **BW, RBW AUTO/MNL(AUTO)** and **VBW AUTO/MNL(AUTO)**.  
The RBW and VBW functions are set to AUTO mode.
14. Press **LEVEL** and **Hi Sens ON/OFF(ON)**.  
The noise level decreases by approximately 25 dB.

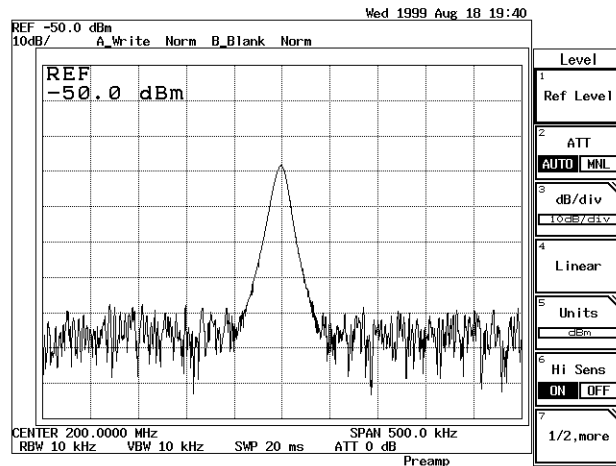

Figure 2-32 Spectrum Displayed when the pre-amplifier is Used

2.2.10 Input Saturation

**2.2.10 Input Saturation**

After a signal being sent to the input mixer reaches a certain level, the displayed value is not proportional to the signal input because of saturation. An input level producing a 1 db error due to saturation is defined as the gain compression. In this example, you apply two input signals and verify that an input signal whose value is less than the limit of gain compression produces less output than it would under perfect linearity. This phenomenon is caused by another input signal whose value is larger than the gain compression limit.

Setup

1. Connect the signal generators as shown in Figure 2-33.

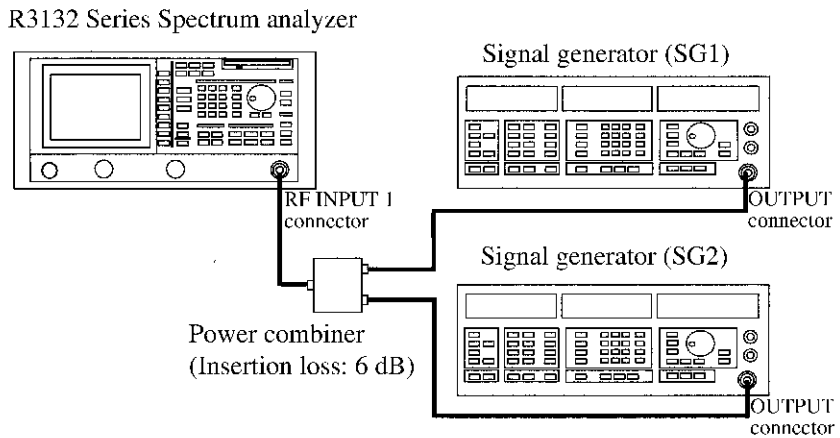

**Figure 2-33 Setup for Input Saturation**

Power on

2. Turn the power on.

Setting the signal generators

This prepares the signal generator outputs.

3. Set SG1 as follows: the frequency to 99.8 MHz; level to -10 dBm; modulation to non-modulated; and output to ON.
4. Set SG2 as follows: the frequency to 100.3 MHz; level to -40 dBm; modulation to non-modulated; and output to ON.

Initialization

This resets the current settings to the factory defaults.

5. Press **SHIFT** and **CONFIG(PRESET)**.  
The default settings have now been reset.

## Setting the measurement conditions

This changes the analyzer settings so that the input signal is displayed more clearly.

6. Press **FREQ, 1, 0, 0** and **MHz**.  
A center frequency of 100 MHz is set.
7. Press **SPAN, 1** and **MHz**.  
A frequency span of 1 MHz is set.
8. Press **LEVEL, ATT AUTO/MNL(MNL), 0** and **GHz(dB)**.  
The Attenuator level is set to 0 dB.  
Under these conditions, the input level at the mixer is -16 dBm (-16 dBm -0dB), and the measurement is correct without saturation.

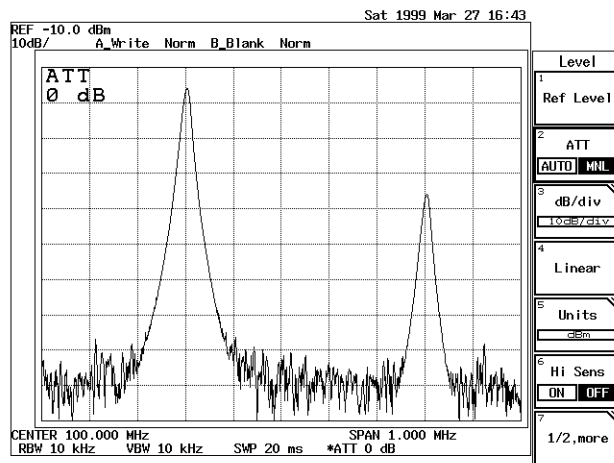

Figure 2-34 Screen Display without Saturation

## Changing the input signal level

Saturation can be observed as the left side signal level is increased.

9. Set SG1 level to +10 dBm.  
Under these conditions, the input level for the mixer is +4 dBm (= +4 dBm -0dB), and the right hand signal level is reduced due to saturation caused by gain compression.

2.2.11 Harmonic Distortion

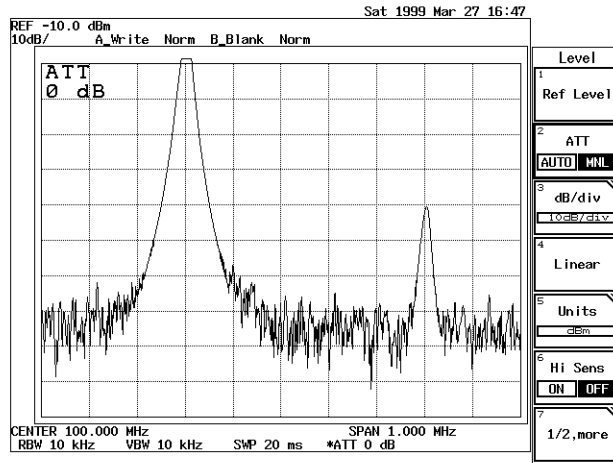

Figure 2-35 Screen Display Showing Saturation

2.2.11 Harmonic Distortion

Harmonic distortion is produced by non-linearity from the input mixer if the input exceeds a certain limit. As a result, spurious signals which do not come from the input signal may be observed.

Setup

1. Connect the signal generator as shown in Figure 2-36.

R3132 Series Spectrum analyzer

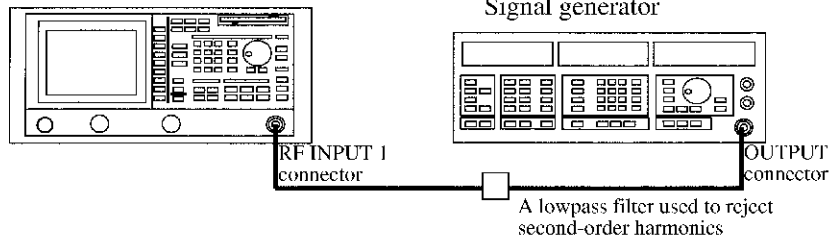

Figure 2-36 Setup for Measuring Harmonic Distortion

Power on

2. Turn the power on.

Setting the signal generator

This prepares the signal generator output.

3. Set the frequency to 270 MHz; the level to 0 dBm; mode of modulation to non-modulated; and output to ON.

### Initialization

This resets the current settings to the factory defaults.

4. Press **SHIFT** and **CONFIG(PRESET)**.  
The default settings have now been reset.

### Setting the measurement conditions

This changes the analyzer settings so that the input signal is displayed more clearly.

5. Press **FREQ, 3, 5, 0** and **MHz**.  
A center frequency of 350 MHz is set.
6. Press **SPAN, 5, 0, 0** and **MHz**.  
A frequency span of 500 MHz is set.
7. Press **BW, RBW AUTO/MNL(MNL), 1, 0, kHz, VBW AUTO/MNL(MNL), 1** and **kHz**.  
An RBW of 10 kHz is set, and a VBW of 1 kHz is set.

### Verifying harmonic distortion

8. Confirm that harmonic distortion is occurring on the right hand side of the screen.  
When the attenuator is set to 10 dB (default setting), and the mixer input is -10 dBm (= 0 dBm - 10 dB), harmonic distortion occurs.

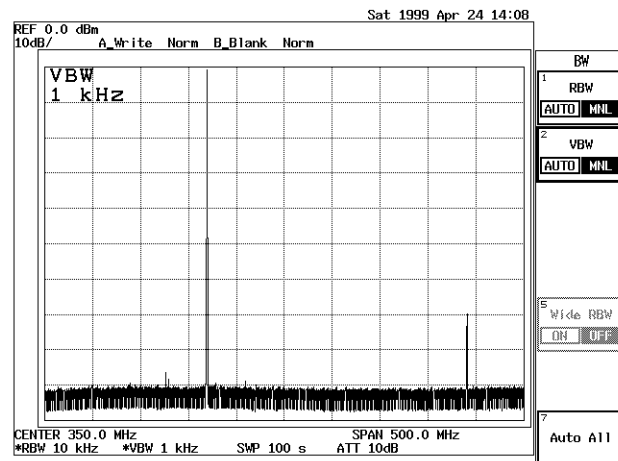

Figure 2-37 Screen Display Showing Harmonic Distortion

2.2.12 Intermodulation

- Press **LEVEL**, **ATT AUTO/MNL(MNL)**, **2, 0** and **GHz(dB)**.  
The attenuator level is set to 20 dB.

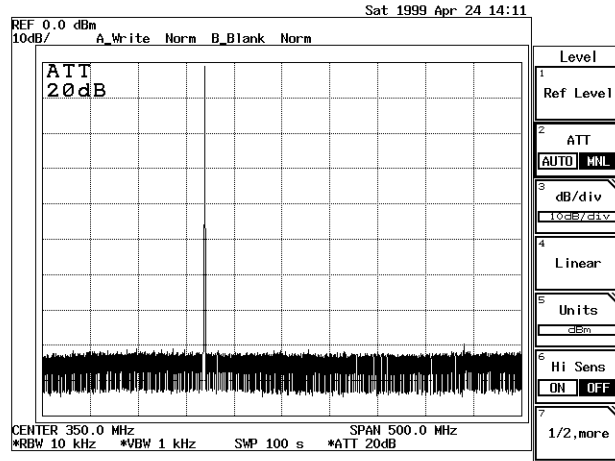

Figure 2-38 Screen Display Showing Reduced Harmonic Distortion

The input to the mixer becomes -20 dB, and the secondary harmonic distortion generated in the spectrum analyzer decreases by 10 dB.

2.2.12 Intermodulation

This section describes how to set up the attenuator (ATT) when using a spectrum analyzer which is receiving more than one input signal.

When signals with an excess amplitude are input, spurious signals produced by intermodulation are displayed. It is important that the ATT be adjusted to moderate the mixer input.

Setup

- Connect the signal generators as shown in Figure 2-39.

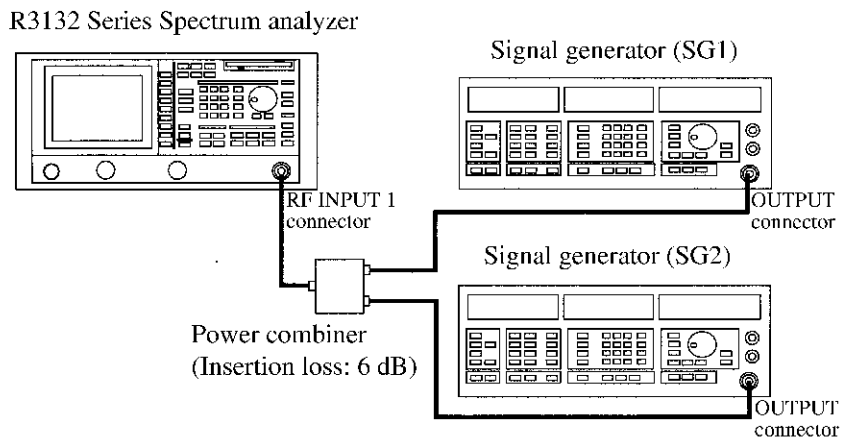

Figure 2-39 Setup for Measuring Intermodulation



#### Power on

2. Turn the power on.

#### Setting the signal generators

This prepares the signal generator outputs.

3. Set SG1 as follows: the frequency to 200.0 MHz; level to -4 dBm; modulation to non-modulated mode; and output to ON.
4. Set SG2 as follows: the frequency to 200.2 MHz; level to -4 dBm; modulation to non-modulated mode; and output to ON.  
Each signal has an input level of -10 dBm.

#### Initialization

This resets the current settings to the factory defaults.

5. Press **SHIFT** and **CONFIG(PRESET)**.  
The default settings have now been reset.

#### Setting the measurement conditions

This changes the analyzer settings so that the input signal is displayed more clearly.

6. Press **FREQ, 2, 0, 0** and **MHz**.  
A center frequency of 200 MHz is set.
7. Press **SPAN, 1** and **MHz**.  
A frequency span of 1 MHz is set.
8. Press **BW, RBW AUTO/MNL(MNL), 3** and **kHz**.  
The RBW is set to 3 kHz.
9. Press **VBW AUTO/MNL(MNL), 3, 0, 0** and **Hz**.  
The VBW is set to 300Hz.  
The attenuator level default setting is 10 dB, which makes the input to the mixer -20 dBm (= -10 dBm - 10 dBm). Since the mixer level exceeds the distortion limit, spurious peaks (3 and 4) appear in addition to the normal peaks (1 and 2).

2.2.12 Intermodulation

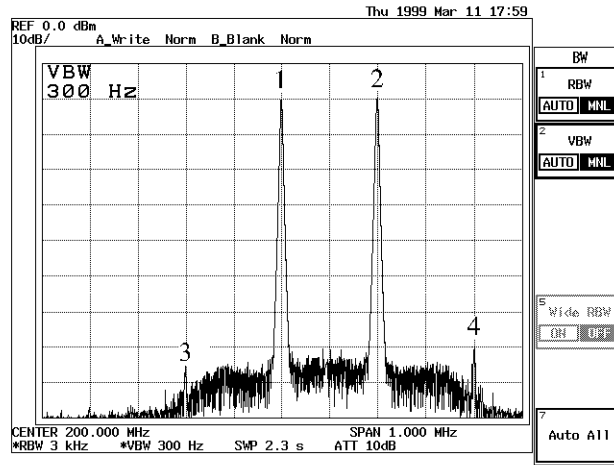

Figure 2-40 Screen Display Showing Intermodulation Distortion

Changing the attenuator

10. Press **LEVEL**, **ATT AUTO/MNL**(MNL), **2, 0** and **GHz(dB)**.  
 The attenuator level is set to 20 dB.  
 Under these conditions, the mixer input level is -30 dBm (= -10 dBm - 20 dB),  
 and spurious peaks (peaks 3 and 4 in Figure 2-40) are not produced.

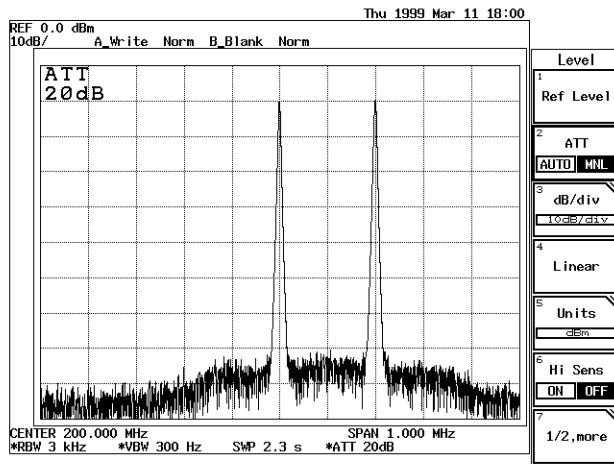

Figure 2-41 Screen Display without Intermodulation Distortion

The current spectrum has no intermodulation distortion. It is important that the ATT be adjusted in order to moderate the mixer input when using more than one input.

### 2.2.13 Calibration

Wait at least 30 minutes after turning on the spectrum analyzer before attempting to perform any measurements, or the measurements may not be accurate.

Set up

Connecting the calibration signal.

1. Connect the N-BNC adapter to the INPUT connector on the front panel. For the R3182, first connect the SMA-SMA adapter to the SMA-BNC adapter, then connect this combined adapter to the INPUT connector on the front panel.
2. Connect the INPUT connector and the CAL OUT connector on the front panel using the input cable provided as an accessory.

Performing the calibration

3. Press **SHIFT** and **7(CAL)**.  
The Cal menu used for calibration appears.

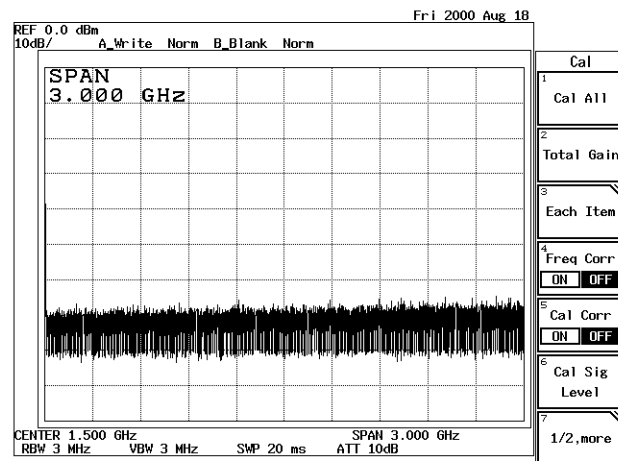

Figure 2-42 Screen Display Showing the Cal Menu

4. Press **Cal All**.  
Calibrates the spectrum analyzer. After all calibration items have been completed, the spectrum analyzer enters the error correction mode. Press **Each Item**, then select an item you wish to calibrate.

---

**NOTE:** You may hear some clicking noises during calibration, but this is normal.

---

### 2.2.14 Entering User-definable Antenna Correction Data

You can define your own antenna correction data in addition to the four regular types of antenna correction data. This section describes how to do this.

Creating a correction data table

Save an empty correction data table to a floppy disk using the following procedure.

2.2.14 Entering User-definable Antenna Correction Data

1. Insert the floppy disk in the disk drive.
2. Press **SHIFT** and **RECALL(SAVE)**.  
The Save menu and file list are displayed.
3. Press **Device RAM/FD** to select FD.  
The floppy disk is selected as the destination for the data table.
4. Press **Save Item**.  
The Save Item menu used for selecting data is displayed
5. Set **Ant Corr** to ON in the Save Item menu (do not turn any other settings on).
6. Press **Save Item**.  
The empty correction data table is saved to the floppy disk.
7. Specify the file, and press **Save**.  
This copies the empty correction data table to the floppy disk.

Editing the correction data table

The correction data table can be edited using a personal computer.

8. Open the data in the folder SVRCL on the floppy disk.
9. Add the data for frequency (Hz) and correction (dB) after the row <ANT CORR>.

	A	B	C
1	ADVANTEST	R3162	
2	DATE	1999/3/18 13:55	
3	TITLE	*	
4	SYSTEM	062X00	
5	TYPE		0
6	SERIES		1
7	BIND		8
8	<ANT CORR>		
10	50000000		-25
11	80000000		-35
12	100000000		-15
13	120000000		-5
14	140000000		0

Figure 2-43 Editing the Correction Data Table

10. Save the data to the floppy disk in text data format.

Importing the correction data table

This reads the edited correction data table into the spectrum analyzer.

2.2.14 Entering User-definable Antenna Correction Data

11. Press **RECALL**.  
The Recall menu used and the file list are displayed.
12. Press *Device RAM/FD* to specify FD.  
Floppy disk is selected.
13. Select the file and press *Recall*.  
The correction data table is read out.

Verifying the imported correction data table

This confirms that the correction data table has been read into the spectrum analyzer.

14. Press **SHIFT** and **1(EMC)**.  
The EMC menu is displayed.

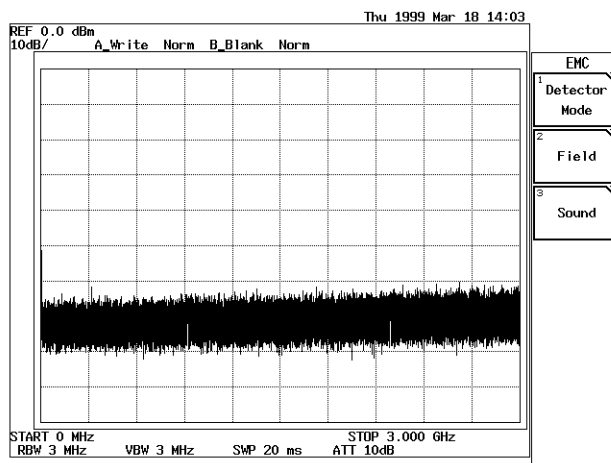

Figure 2-44 Screen for the EMC Menu

15. Press *Field, User ANT Corr*.  
The edited data in the correction data table is displayed.

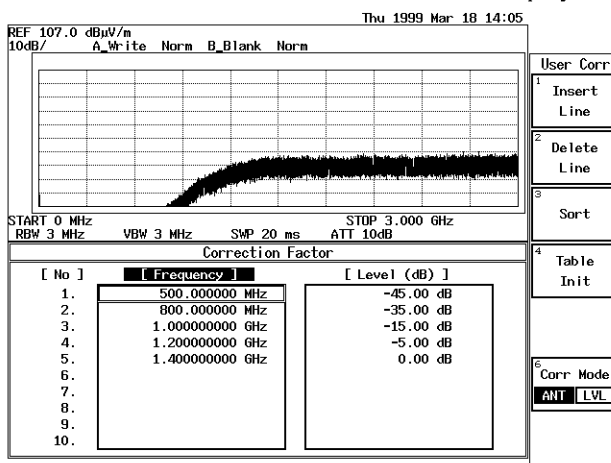

Figure 2-45 Screen Display Showing the User-Definable Correction Data Table

2.2.15 External Mixer (OPT16 thru OPT19)

**2.2.15 External Mixer (OPT16 thru OPT19)**

The external mixers WHMB-28S (OPT16), WHMB-19S (OPT17), WHMB-15S (OPT18) and WHMB-10S (OPT19) are used to analyze frequencies together with an R3172/82 and an external waveguide mixer. The R3172/82 is used to analyze frequencies in one of the input ranges shown below.

**Table 2-1 Product Summary**

OPT No.	Frequency range	External mixer used
OPT16	26.5 to 40 GHz	WHMB-28S
OPT17	40 to 60 GHz	WHMB-19S
OPT18	50 to 75 GHz	WHMB-15S
	70 to 80 GHz	
OPT19	75 to 110 GHz	WHMB-10S

These options are provided with a floppy disk drive. Level correction data can be saved to a floppy so that it can be loaded automatically before using the spectrum analyzer.

---

**CAUTION** To install the mixer option on the R3172, OPT 03 (Local output to an external mixer) must be provided separately.

---

The configuration of the options is shown below.

**Table 2-2 Configuration of the Options**

Name	Model	Qty	Remarks
Waveguide mixer	For OPT16	WHMB-28S	1
	For OPT17	WHMB-19S	
	For OPT18	WHMB-15S	
	For OPT19	WHMB-10S	
Connection cable		1	SMA cable
Floppy disk		1	Contains level correction values

This section explains how to set up the R3172/82 and waveguide mixer, and how to operate them.

Setup

---

**CAUTION:**

1. When connecting the R3172/82 to the waveguide mixer, be sure to connect the cable to the EXT MIXER connector on the R3172/82, and then the other side of the cable to the waveguide mixer.  
An internal diode in the mixer may be damaged due to piezoelectricity voltage generated in the cable.
  2. The maximum allowable input level to the waveguide mixer is +20 dBm. If the input level exceeds this value, insert an attenuator into the input.
-

1. Connect one end of the cable to the EXT MIXER connector on the R3172/82.
2. Connect the other end of the cable to the Lo input connector on the waveguide mixer.

R3172 Spectrum analyzer

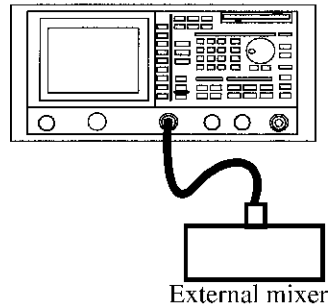

Figure 2-46 Setup for the R3172 and Waveguide Mixer

R3182 Spectrum analyzer

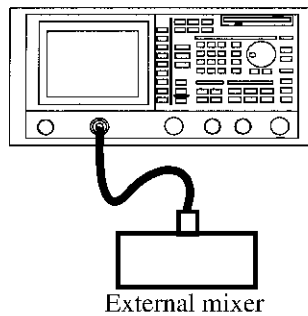

Figure 2-47 Setup for the R3182 and Waveguide Mixer

Power on

3. Turn the instrument power on.

Initializing the set conditions

This resets the current settings to the factory defaults.

4. Press **SHIFT** and **CONFIG(PRESET)**.  
The factory defaults are loaded.

Switching to External Mixer Mode

5. Press **FREQ, 1/2\_more** and **Mixer INT/EXT(EXT)**.

2.2.15 External Mixer (OPT16 thru OPT19)

Loading frequency correction data

This operation loads frequency correction data and setting conditions from a floppy disk compatible with the external mixer being used.

6. Press **RECALL** and *Device RAM/FD*(FD).
7. Select a file to be opened from the file list using the data knob. The relationships between the frequency ranges (of the external mixer being used) and the file names are shown below.

**Table 2-3 File Names**

OPT No.	Frequency range	External mixer used	File names
OPT16	26.5 to 40 GHz	WHMB-28S	WHMB28
OPT17	40 to 60 GHz	WHMB-19S	WHMB19
OPT18	50 to 75 GHz	WHMB-15S	WHMB15-1
	70 to 80 GHz		WHMB15-2
OPT19	75 to 110 GHz	WHMB-10S	WHMB10

8. Press *Recall*.  
Frequency correction data is automatically loaded and External Mixer Mode is automatically set.



## 2.3 Measurement Examples

### 2.3.1 Measuring the Channel Power

The spectrum analyzer has a power measurement function which can be used to conveniently measure various types of power. This section describes how to measure the power of a specified channel bandwidth using the example below.

#### Measurement conditions:

This example shows how to measure channel power for a unit similar to PHS outputting a frequency of 1917.950 MHz and a level of 20 dBm.

Use appropriate parameter values to make the measurements shown below.

#### Setup

1. Connect the transmitter as shown in Figure 2-48.

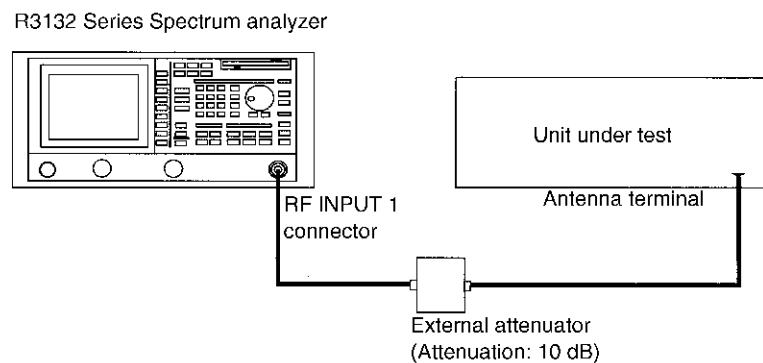

**Figure 2-48 Setup for Measuring the Channel Power**

#### Power on

2. Turn the power on.

#### Setting the unit under test

3. Turn on the signal output for the unit under test.

#### Initialization

This resets the current settings to the factory defaults.

4. Press **SHIFT** and **CONFIG(PRESET)**.  
The default settings have now been reset.

2.3.1 Measuring the Channel Power

Setting the measurement conditions

This changes the analyzer settings so that the input signal is displayed more clearly.

5. Press **FREQ, 1, 9, 1, 7, ., 9, 5, 0** and **MHz**.  
A center frequency of 1917.950 MHz is set.
6. Press **SPAN, 1** and **MHz**.  
A frequency span of 1 MHz is set.
7. Press **BW, RBW AUTO/MNL(MNL), 1, 0** and **kHz**.  
The RBW is set to 10 kHz.
8. Press **LEVEL, 1, 0** and **GHz(+dBm)**.  
The reference level is set to 10 dBm.

Setting the offset level

9. Press **1/2\_more, Ref Offset ON/OFF(ON), 1, 0** and **GHz(dB)**.  
The offset level is set to 10 dB.  
The measurement values, including values for the external attenuator, are now displayed.

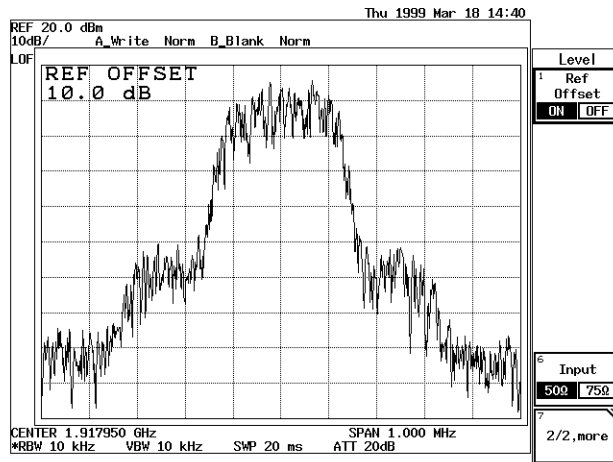

Figure 2-49 Setting the Offset Level

Measuring the power

10. Press **POWER MEASURE**.  
The Power menu is displayed.
11. Press **Channel Power**.  
The CH Power menu is displayed.
12. Press **Window Position, 1, 9, 1, 7, ., 9, 5, 0** and **MHz**.  
The channel is set to 1917.950 MHz.

13. Press *Window Width, CH BW POS/WD, 3, 0, 0* and kHz.

The channel width is set to 300 kHz.

The Channel Power window is displayed, the channel power is measured and the measurement value is displayed in the Channel Power window. In addition, the display line showing the previously measured channel power is displayed.

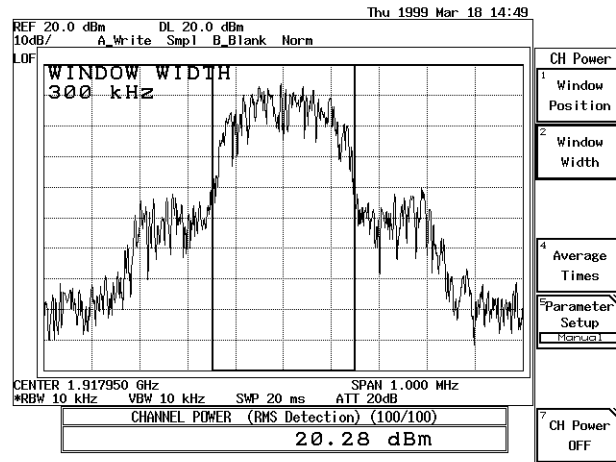

Figure 2-50 Measuring the Channel power

2.3.2 Measuring the Occupied Bandwidth (OBW)

2.3.2 Measuring the Occupied Bandwidth (OBW)

The occupied bandwidth can be calculated from the measured screen data using the OBW function. In this operation, the ratio of the OBW to the total power ranges from 10.0 to 99.8%. The initial setting is 99%.

**Measurement conditions:**

This example shows how to measure the occupied bandwidth for a unit similar to PHS outputting a frequency of 1917.950 MHz, an OBW of 288 kHz and a level of 20 dBm.

Use appropriate parameter values to make the measurements shown below.

---

**NOTE:** *NOTE: Set the reference level and the frequency span so that the signal amplitude on the screen is 50 dB or more in order to reduce operation error (when the signal amplitude on the screen does not exceed 50 dB, the operation error is large). The optimum span is approximately three times the occupied bandwidth.*

---

Setup

1. Connect the unit under test as shown in Figure 2-51.

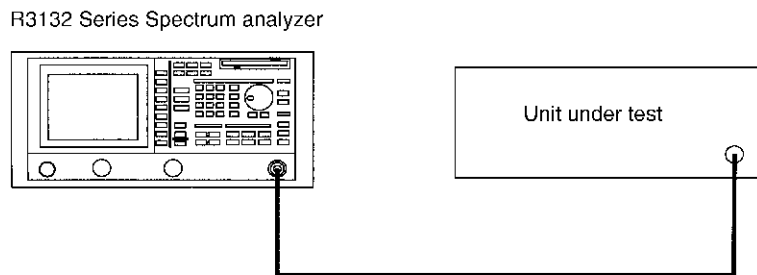

**Figure 2-51 Setup for Measuring the Occupied Bandwidth**

Power on

2. Turn the power on.

Setting the unit under test

3. Turn on the signal output for the unit under test.

Initialization

This resets the current settings to the factory defaults.

4. Press **SHIFT** and **CONFIG(PRESET)**.  
The default settings have now been reset.

## Setting the measurement conditions

This changes the analyzer settings so that the input signal is displayed more clearly.

5. Press **FREQ, 1, 8, 9, 5, ,, 1, 5** and **MHz**.  
A center frequency of 1895.15 MHz is set.
6. Press **SPAN, 8, 0, 0** and **kHz**.  
A frequency span of 800 kHz is set.

## Setting the detector mode

7. Press **TRACE, Detector** and **Posi**.  
The trace is set to positive detector mode.

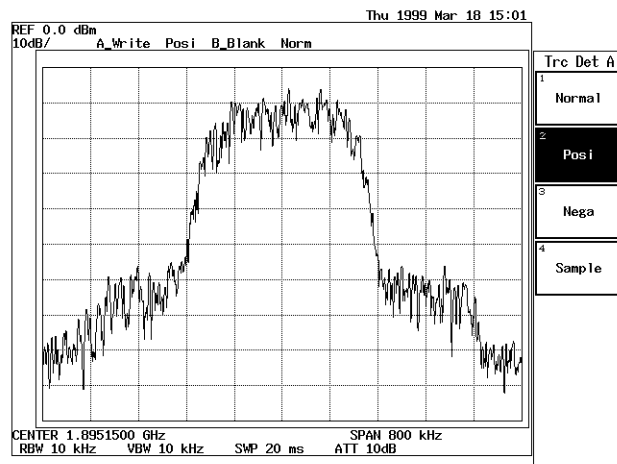

Figure 2-52 Setting the Detector Mode

## Measuring the OBW

8. Press **POWER MEASURE** and **OBW**.  
The OBW measurement is activated and the result displayed.

2.3.2 Measuring the Occupied Bandwidth (OBW)

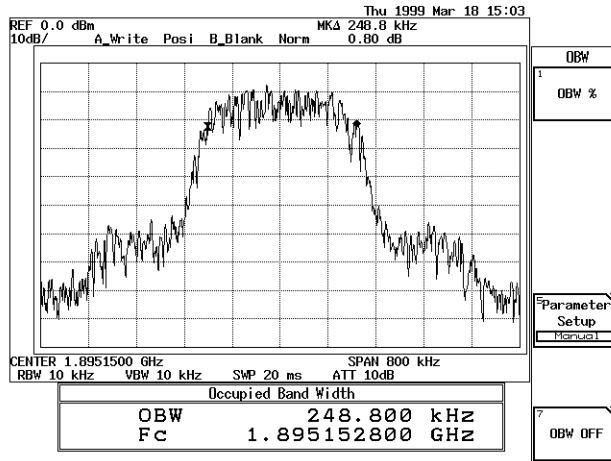

Figure 2-53 OBW Measurement Screen

When the measurement has been completed, a window showing the OBW and Fc of the occupied bandwidth is displayed (center refers to center frequency not carrier frequency), and two markers are placed at either end of the occupied bandwidth. In this example, which has a ratio of 99.0% (initial value), each marker is displayed at 0.5% and 99.5% of the total power.

Changing the ratio to the total power

This changes the ratio to 95%.

9. Press **OBW%**, **9**, **5** and **Hz(ENTER)**.  
The ratio to the total power is now 95%.

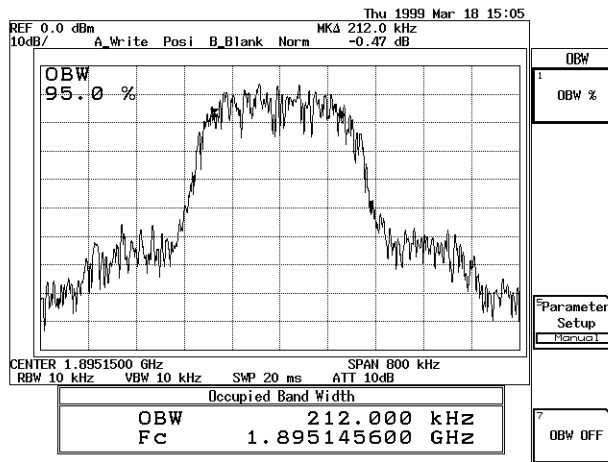

Figure 2-54 OBW(95%) Measurement Screen

### 2.3.3 Measuring Adjacent Channel Leakage Power (ACP)

One of the most important items to be measured of the digital modulating signal, which is used in the Personal Handy Phone and so on, is the adjacent channel leakage power (ACP).

In this section, the following two modes are explained: PDC digital modulating signal measurements in Full screen mode using the Root Nyquist filter, the adjacent (or the second adjacent) channel leakage power measurements for PHS in Separate screen mode.

**Full screen mode:** Calculates the total power using the data on the entire screen, calculates the channel leakage power of the upper and lower adjacent channels by integration to the specified bandwidth (BS), and calculates the ratio of the previously obtained values. The time required for taking measurements using this mode is shorter than the other mode since all necessary data is collected in a single sweep. In addition, a graphic function, which permits you to display the power at a point by integrating the leakage power over the specified bandwidth with respect to this point, is available.

**Separate screen mode:** Automatically sets the frequency span to the specified bandwidth, measures Carrier wave power (on the upper screen), measures the adjacent channel leakage powers (on the lower screens) (or the second adjacent leakage powers on the lower screens), and calculates the ratios separately. Using this mode, a higher accuracy is obtained when the channel spacing is large enough in relation to the specified bandwidth.

---

**CAUTION:**

1. *Set the values to meet the following unless otherwise specified.*

$$RBW \leq \frac{1}{40} \times \text{Specified bandwidth}$$

*Detection mode: Sample*

*Trace Average function: OFF*

2. *The VBW must meet the following.*

$$VBW \geq RBW$$

---

#### 2.3.3.1 Full Screen Mode

This section describes how to measure PDC digital modulating signal using the Root Nyquist Filter in Full screen mode.

**Measurement conditions:** The unit used in this measurement must output a PDC signal with a frequency of 917.950 MHz and a level of 0 dBm.

Use appropriate parameter values to make the measurements shown below.

ACP Measurement Setup

1. Connect the unit under test as shown in Figure 2-55.

2.3.3 Measuring Adjacent Channel Leakage Power (ACP)

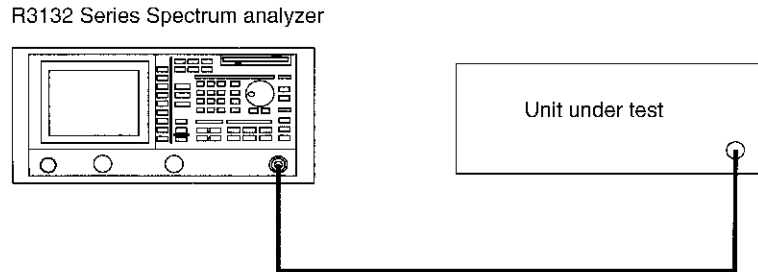

Figure 2-55 Setup Measuring Adjacent Channel Leakage Power

Power on

2. Turn the analyzer and the unit under test power on.

Setting the unit under test

3. Activate the signal output for the unit under test.

Initialization

This resets the current settings to the factory defaults or user-defined presets.

4. Press **SHIFT** and **CONFIG(PRESET)**.  
This sets the analyzer to its presets values.

Setting the measuring conditions

This changes the analyzer settings so that the input signal is displayed more clearly.

5. Press **SPAN, 2, 5, 0** and **kHz**.  
A frequency span of 250 kHz is set.

---

**CAUTION:** *The frequency span must meet the conditions shown below.*  
 $SPAN \geq 2 \times \text{Channel spacing} + X$   
*When specifying a Root Nyquist Filter:*  
 $X = (1 + \text{Rolloff factor}) \times \text{Symbol rate}$   
*When not specifying a Root Nyquist Filter:*  
 $X = \text{Specified bandwidth}$

---

6. Press **FREQ, 9, 1, 7, ., 9, 5, 0** and **MHz**.  
A center frequency of 917.950 MHz is set.
7. Press **BW, RBW AUTO/MNL(MNL), 1** and **kHz**.  
The RBW is set to 1 kHz.
8. Press **VBW AUTO/MNL(MNL), 3** and **kHz**.  
The VBW is set to 3 kHz.



## 2.3.3 Measuring Adjacent Channel Leakage Power (ACP)

9. Press **TRACE**, *Detector* and *Posi*.  
This sets the trace detector to the Positive mode.
10. Press **LEVEL** and adjust the trace using the data knob so that the trace peak can be within 1 graduation in relation to the reference level.

---

**NOTE:** *Measurement errors increase when the signal level is much lower than the reference level.*

---

11. Press **SWEEP**, *SWP Time AUTO/MNL(MNL)*, **2**, **1** and **MHz(sec)**.  
A sweep time of 21 seconds is set.

---

**NOTE:** *The sweep time must meet the following.*  
*Sweep time  $\geq$  Number of trace points  $\times$  Period of the burst signal*

---

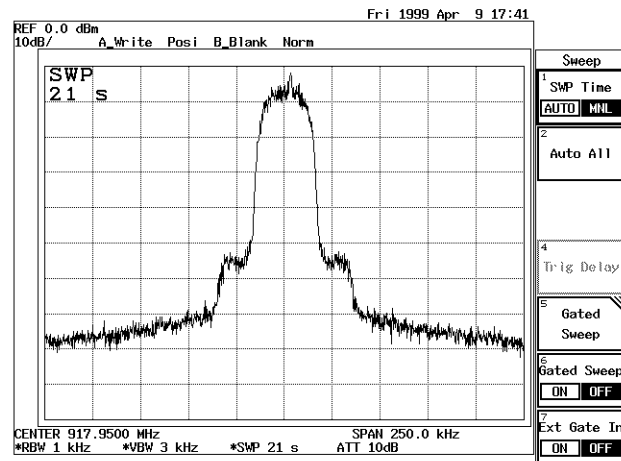

Figure 2-56 PDC trace

Channel spacing and specified bandwidth

Channel spacing and channel bandwidth are specified in PDC mode.

12. Press **POWER MEASURE**, *ACP* and *CS/BS Setup*.  
The dialog box for setting the channel spacing and specified bandwidth is displayed. The cursor is moved to the 1st channel's Channel Space.
13. Press **5**, **0** and **kHz**.  
The channel spacing for channel 1 is set to 50 kHz. The cursor is moved to the 1st channel's Band Width.

2.3.3 Measuring Adjacent Channel Leakage Power (ACP)

14. Press **2, 1** and **kHz**.  
The specified bandwidth for channel 1 is set to 21 kHz. The cursor is moved to the 2nd channel's Channel Space.
15. Press **1, 0, 0** and **kHz**.  
The channel spacing for the channel 2 is set to 100 kHz. The cursor is moved to the 2nd channel's Band Width.
16. Press **2, 1** and **kHz**.  
The specified bandwidth for channel 2 is set to 21 kHz.

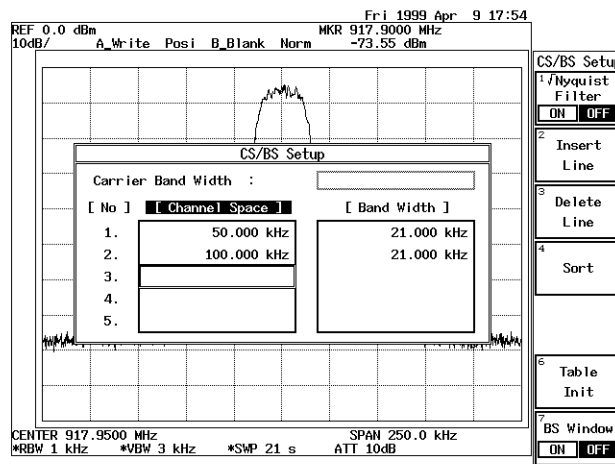

Figure 2-57 CS/BS Setup dialog box

17. Press **RETURN**.  
This closes the CS/BS Setup dialog box.

---

**NOTE:** An ACP measurement cannot be carried out if the frequency span for the specified bandwidth and channel spacing is inappropriately set or not set.

---

Setting the Root Nyquist filter's correction function

18. Press  $\sqrt{\text{Nyquist Filter Setup}}$ .  
The dialog box used to set Root Nyquist Filter parameters is displayed.
19. Move the cursor to **Symbol Rate 1/T** using the step keys and press **2, 1** and **kHz**.  
A symbol rate of 21 kHz is set, and the cursor is moved to Rolloff Factor.
20. Press **0, ., 5** and **Hz(ENTR)**.  
A rolloff factor of 0.5 is set.
21. Set  $\sqrt{\text{Nyquist Filter ON/OFF}}$ (ON).  
Allows you to set parameters and displays the data enter.

2.3.3 Measuring Adjacent Channel Leakage Power (ACP)

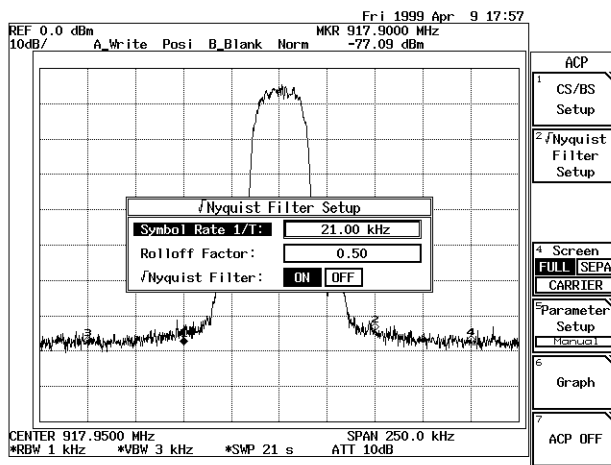

Figure 2-58 Root Nyquist Filter dialog box

22. Press  $\sqrt{\text{Nyquist Filter Setup}}$ .  
The Root Nyquist Filter dialog box is closed.

Performing ACP

23. One marker is displayed in each of the upper and lower adjacent channels each time a sweep is performed, and the lower adjacent channel leakage power as well as the upper adjacent channel leakage power is displayed. When you press **SINGLE**, only one measurement is taken.

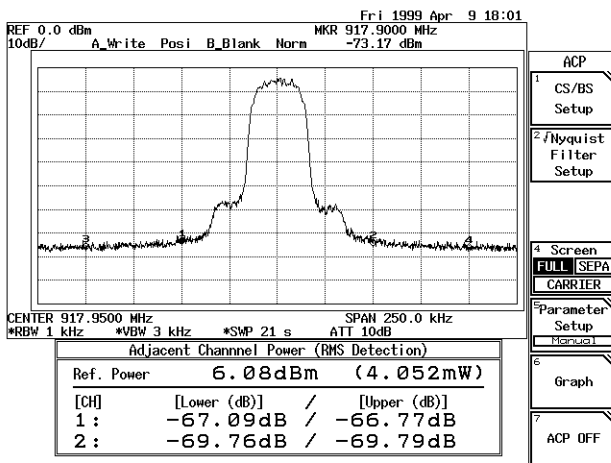

Figure 2-59 ACP Measurement Display in Full Screen Mode

2.3.3 Measuring Adjacent Channel Leakage Power (ACP)

Making observations using ACP GRAPH

24. Press **Graph**.

The calculation result of the adjacent channel leakage power and the delta marker are displayed.

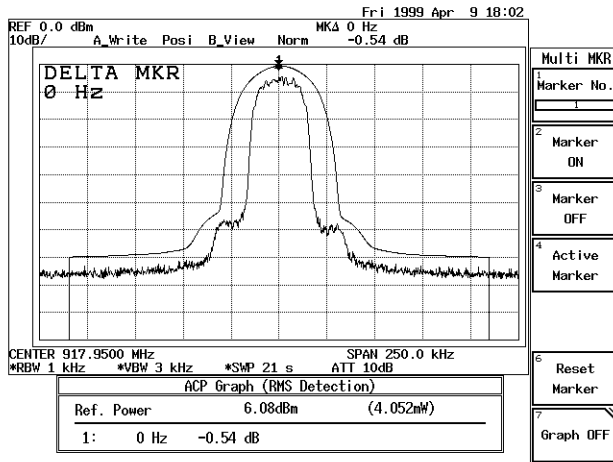

Figure 2-60 Measurement Using ACP GRAPH

Specifying measurement points

Moving the marker to another channel.

25. Move the marker to 100 kHz using the data knob.  
The adjacent channel leakage power at 100 kHz is displayed in the result area.

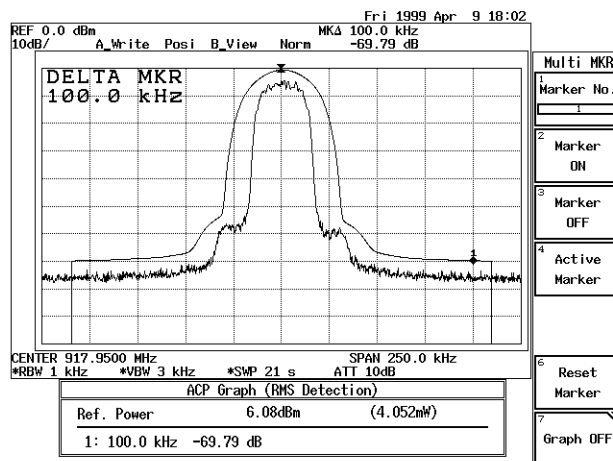

Figure 2-61 ACP at the 100 kHz

### 2.3.3.2 SEPARATE Display

This section describes how to measure PHS digital modulating signal in Separate screen mode.

Measurement conditions: The unit used in this measurement must output a PHS signal with a frequency of 1917.950 MHz and a level of +10 dBm.

Use appropriate parameter values to make the measurements shown below.

#### ACP Measurement Setup

1. Connect the unit under test as shown in Figure 2-62.

R3132 Series Spectrum analyzer

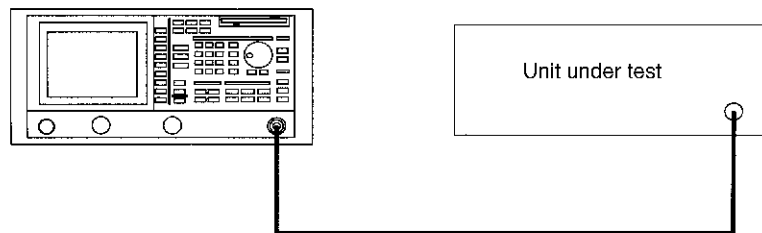

Figure 2-62 Setup Measuring Adjacent Channel Leakage Power

#### Power on

2. Turn the analyzer and the unit under test power on.

#### Setting the unit under test

3. Activate the signal output for the unit under test.

#### Initialization

This resets the current settings to the factory defaults or user-defined presets.

4. Press **SHIFT** and **CONFIG(PRESET)**.  
This sets the analyzer to its presets values.

#### Setting the measuring conditions

This changes the analyzer settings so that the input signal is displayed more clearly.

5. Press **FREQ, 1, 9, 1, 7, ,, 9, 5, 0** and **MHz**.  
A center frequency of 1917.950 MHz is set.
6. Press **SPAN, 3** and **MHz**.  
A frequency span of 3 MHz is set.
7. Press **LEVEL, ATT AUTO/MNL(MNL), 3, 0** and **GHz(dB)**.  
The attenuator is set to 30 dB.
8. Press **LEVEL, 0** and **GHz(+dBm)**.  
The reference level of 0 dBm is set.

2.3.3 Measuring Adjacent Channel Leakage Power (ACP)

9. Press **BW**, **RBW AUTO/MNL(MNL)**, **3** and **kHz**.  
The RBW is set to 3 kHz.
10. Press **VBW AUTO/MNL(MNL)**, **1, 0** and **kHz**.  
The VBW is set to 10 kHz.
11. Press **TRACE**, **Detector** and **Posi**.  
This sets the trace detector to the Positive mode.
12. Press **LEVEL** and adjust the trace using the data knob so that the trace peak can be within 1 graduation in relation to the reference level.

---

**NOTE:** *Measurement errors increase when the signal level is much lower than the reference level.*

---

13. Press **SWEEP**, **SWP Time AUTO/MNL(MNL)**, **5** and **MHz(sec)**.  
A sweep time of 5 seconds is set.

---

**NOTE:** *The sweep time must meet the following.  
Sweep time ≥ Number of trace points × Period of the burst signal*

---

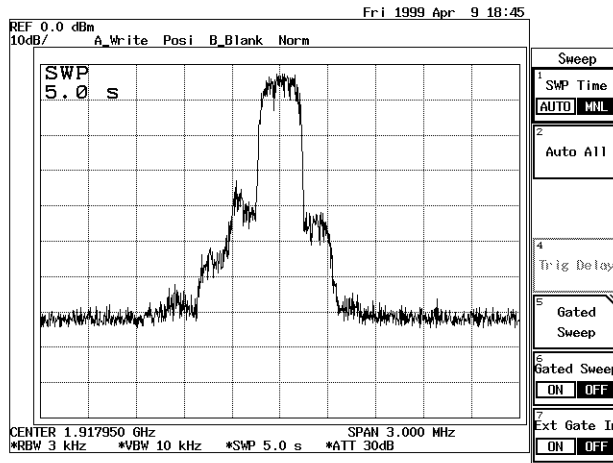

Figure 2-63 PHS Trace

Setting the Channel spacing and Specified Bandwidth

Channel spacing and channel bandwidth are specified in PHS.

14. Press **POWER MEASURE**, **ACP**, **Screen FULL/SEPA/CARRIER(SEPA)**.  
The screen mode is set to the separate.

15. Press **CS/BS Setup**.  
The dialog box for setting the channel spacing and specified bandwidth is displayed.
16. Press **1, 9, 2** and **kHz**.  
Carrier Band Width is now set to 192 kHz. The cursor is moved to the 1st channel's Channel Space.
17. Press **6, 0, 0** and **kHz**.  
The channel spacing for channel 1 is set to 600 kHz. The cursor is moved to the 1st channel's Band Width.
18. Press **1, 9, 2** and **kHz**.  
The specified bandwidth for channel 1 is set to 192 kHz. The cursor is moved to the 2nd channel's Channel Space.
19. Press **9, 0, 0** and **kHz**.  
The channel spacing for the channel 2 is set to 900 kHz. The cursor is moved to the 2nd channel's Band Width.
20. Press **1, 9, 2** and **kHz**.  
The specified bandwidth for channel 2 is set to 192 kHz.

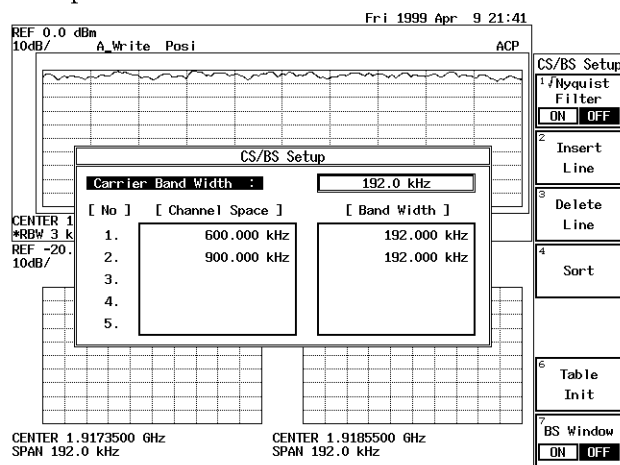

Figure 2-64 CS/BS Setup dialog box

21. Press **RETURN**.  
This closes the CS/BS Setup dialog box.

---

**NOTE:** This operation will not function correctly when the specified bandwidth is inappropriate or not set.

---

2.3.3 Measuring Adjacent Channel Leakage Power (ACP)

Performing ACP using Separate screen

- 22. Each time a sweep is performed, the trace of a carrier signal is displayed on the upper screen, and the upper and lower adjacent channel traces are displayed on each of the two lower screens. The ACP values for both adjacent channels are displayed once every 5 sweeps. When you press **SINGLE**, only five measurements are taken.

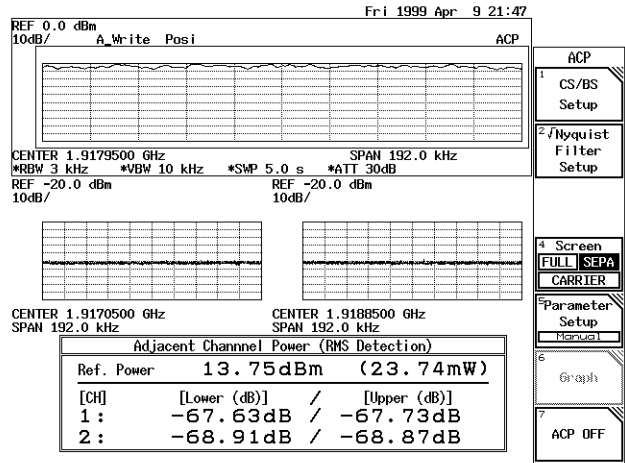

Figure 2-65 Measurement Result in ACP Separate Screen Mode



### 2.3.4 Measuring Burst Signals Using the Gated Sweep

This section describes how pulse modulation signals are measured using the gated sweep function.

Measurement conditions: The signal used in this measurement has an output frequency of 1 GHz, a level of 0 dBm, a pulse width of 1 msec and a period of 10 msec.

Use appropriate parameter values to make the measurements shown below.  
(Opt29 is required.)

#### Setup

1. Connect the unit as shown in Figure 2-66.

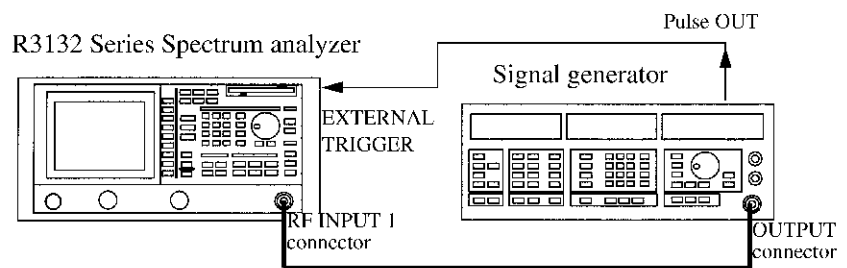

Figure 2-66 Setup for Measuring a Burst Signal

#### Power on

2. Turn the analyzer and the signal generator power on.

#### Setting the signal generator

This prepares the signal generator for output.

3. Set the frequency to 1 GHz; the level to 0 dBm; the pulse width to 1 msec; the period to 10 msec; and output to ON.

#### Initialization

This resets the current settings to the factory defaults or user-defined presets.

4. Press **SHIFT** and **CONFIG(PRESET)**.  
This sets the analyzer to its presets values.

#### Setting the measurement conditions

This changes the analyzer settings so that the input signal is displayed more clearly.

5. Press **FREQ, 1** and **GHz**.  
A center frequency of 1 GHz is set.
6. Press **SPAN, 5, 0, 0** and **kHz**.  
A frequency span of 500 kHz is set.

2.3.4 Measuring Burst Signals Using the Gated Sweep

7. Press **LEVEL, 5** and **GHz(+dBm)**.  
The reference level is set to +5 dBm.
8. Press **BW, RBW AUTO/MNL(MNL), 3** and **kHz**.  
An RBW of 3 kHz is set.
9. Press **SWEEP, SWP Time AUTO/MNL(MNL), 2, 0, 0** and **kHz(ms)**.  
Sweep time is set to 200 ms.

Setting the gated sweep

This sets the conditions of the gated sweep to bring the gated sweep into sync with the input signal.

10. Press **SWEEP** and **Gated Sweep**.  
The Gated Sweep menu is displayed, and the gated sweep mode is set.  
The upper screen displays the spectrum and the lower screen displays the waveform in the time domain in Split screen mode.

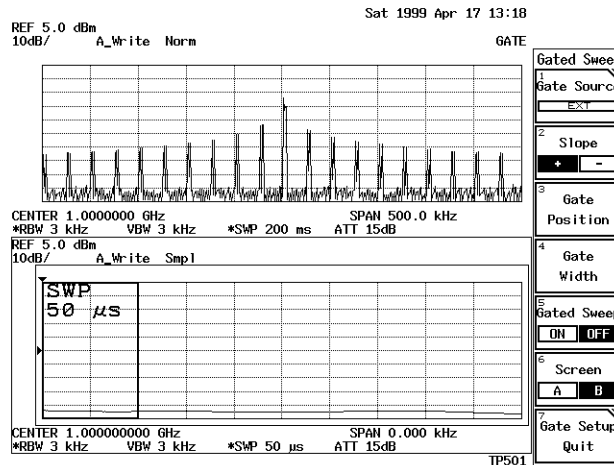

Figure 2-67 Burst Signal Displayed in Split Screen Mode

11. Press **2** and **kHz(ms)**.  
A sweep time of 2 msec for the lower screen is set.

2.3.4 Measuring Burst Signals Using the Gated Sweep

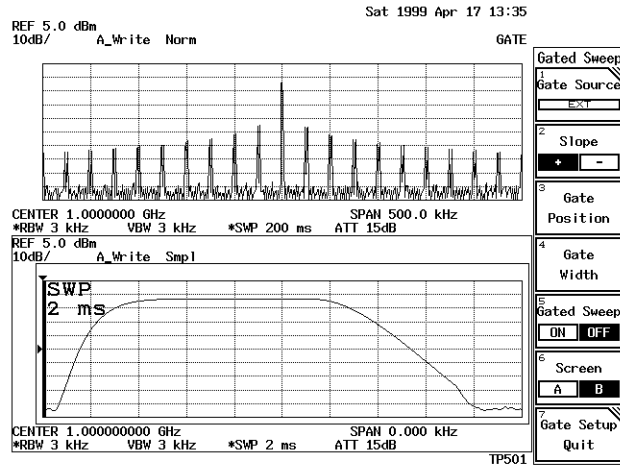

Figure 2-68 Trigger Setup

12. Press *Gate Position*, 0, ., 6 and kHz(ms).  
The gate start position is set to 0.6 msec.
13. Press *Gate Width*, 0, ., 3 and kHz(ms).  
A gate width of 0.3 msec is set.

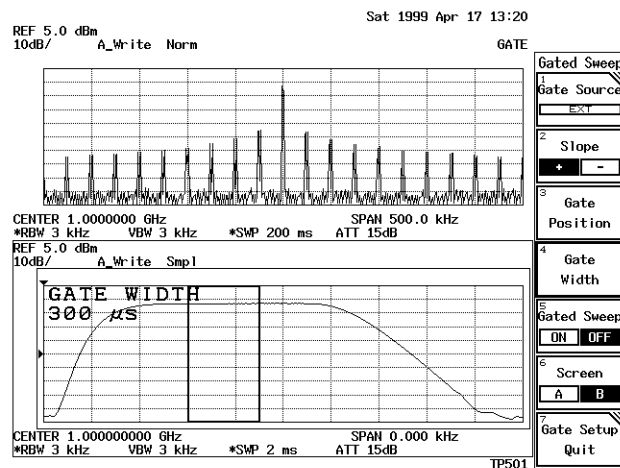

Figure 2-69 Gate Setup

14. Press *Gate Sweep ON/OFF*(ON).  
A spectrum without the effect caused by a burst signal will be displayed on the upper part of the screen.

2.3.4 Measuring Burst Signals Using the Gated Sweep

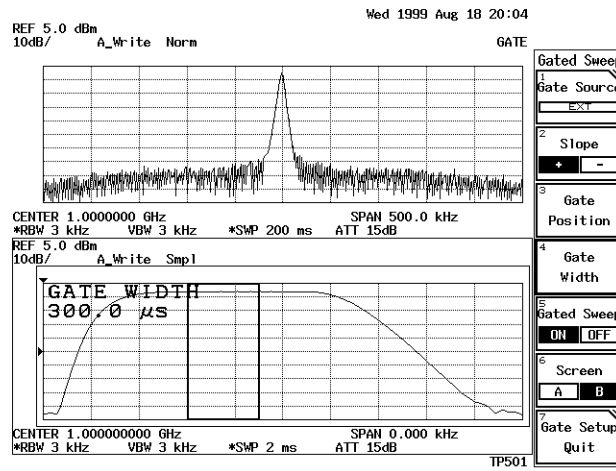

Figure 2-70 Burst Signal by Use of the Gated Sweep (Separate Screen Mode)

15. Press **Gate Setup Quit**.

The display shows the gated sweep trace in Full screen mode. You can now change the frequency span and reference level if desired.

**NOTE:** Check the gated sweep for its settings after you have changed the resolution bandwidth and video bandwidth of the spectrum (displayed on the upper screen) when measuring a burst signal using the gated sweep.

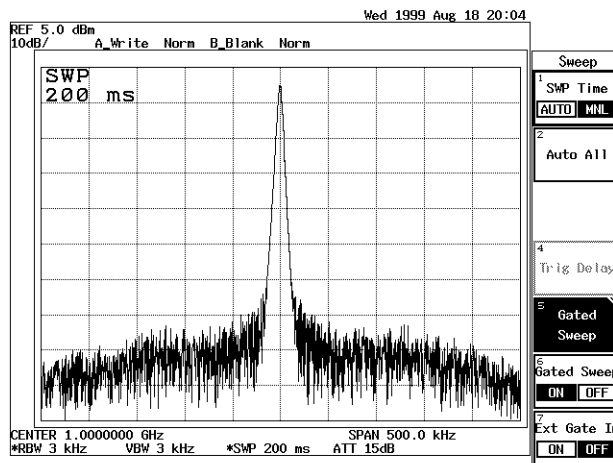

Figure 2-71 Burst Signal by Use of the Gated Sweep (Full Screen Mode)

### 2.3.5 Measuring Burst Signals in the Time Domain

This section describes how to measure the leading and trailing edges of the TDMA signal used in PHS and so on, using the time domain function.

Measurement conditions: The signal used in this measurement has an output frequency of 1917.950 MHz, a level of 0 dBm, a pulse width of 600  $\mu$ sec, a pulse period of 5 msec, a leading time of 13  $\mu$ sec, a trailing time of 13  $\mu$ sec of the burst signal.

Use appropriate parameter values to make the measurements shown below.  
(Opt29 is required.)

#### Setup

1. Connect the unit as shown in Figure 2-72.

R3132 Series Spectrum analyzer

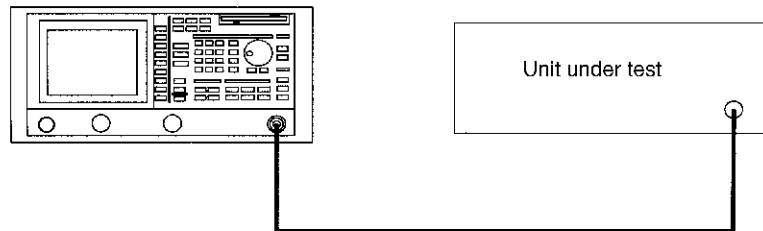

Figure 2-72 Setup for Measuring a Burst wave signal

#### Power on

2. Turn the analyzer and the unit under test power on.

#### Setting the unit under test

3. This prepares the unit under test for signal output.

#### Initialization

This resets the current settings to the factory defaults or user-defined presets.

4. Press **SHIFT** and **CONFIG(PRESET)**.  
This sets the analyzer to its presets values.

#### Setting the measurement conditions

This changes the analyzer settings so that the input signal is displayed more clearly.

5. Press **FREQ, 1, 9, 1, 7, ,, 9, 5** and **MHz**.  
A center frequency of 1917.95 MHz is set.
6. Press **SPAN, 0** and **MHz**.  
The frequency span is set to zero span.

2.3.5 Measuring Burst Signals in the Time Domain

7. Press **LEVEL**, **5** and **GHz(+dBm)**.  
The reference level is set to +5 dBm.

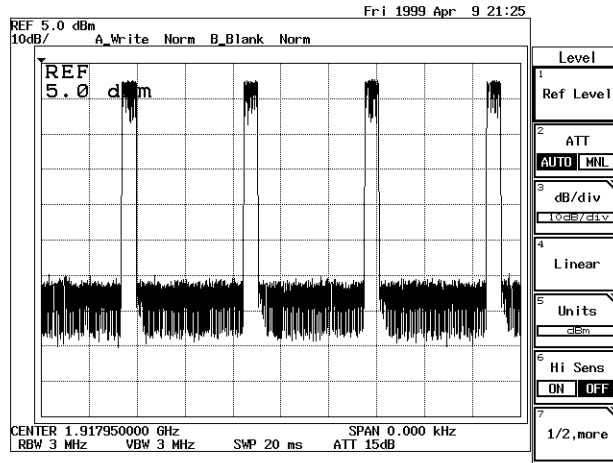

Figure 2-73 Burst Signal in the Time Domain

8. Press **SWEEP**, **SWP Time AUTO/MNL(MNL)**, **5** and **kHz(ms)**.  
A sweep time of 5 msec is set.

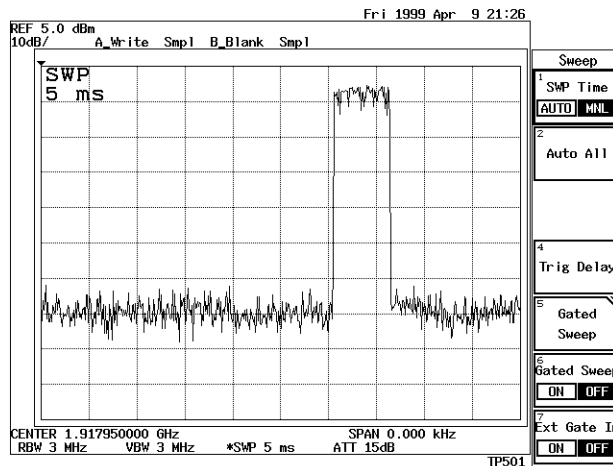

Figure 2-74 Burst Signal in the Time Domain

Setting the video trigger

9. Press **TRIG**, **Trig Source** and **Video Trig**.  
Video is selected.  
The trigger level mark (→) is displayed on the left edge vertical axis.

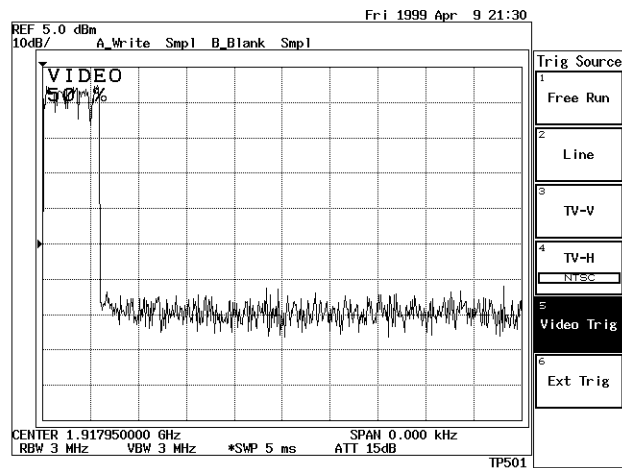

Figure 2-75 Burst Signal in Synchronization with the Trigger Signal

- Adjusts the trigger level to 70% using the knob.

Setting the leading edge of a waveform

- Press **SWEEP, 5, 0** and **Hz( $\mu$ s)**.  
A Sweep time of 50  $\mu$ sec is set.
- Press **Trig Delay, -, 2, 5** and **Hz( $\mu$ s)**.  
The waveform is displayed 25  $\mu$ sec before the triggering point so you can observe the leading edge of the burst signal.

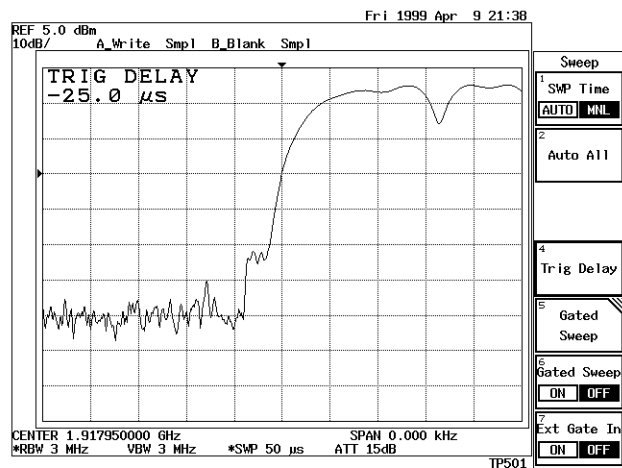

Figure 2-76 Measuring Burst Signal Leading Edge

2.3.5 Measuring Burst Signals in the Time Domain

Setting the trailing edge of a waveform

13. Press **Trig Delay, 5, 7, 5** and **Hz(μs)**.  
The waveform is displayed 575 μsec after the triggering point so you can observe the trailing edge of the burst signal.

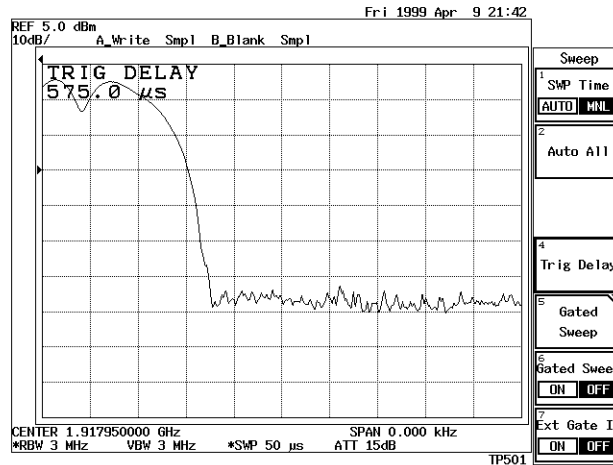

Figure 2-77 Measuring Burst Signal Trailing Edge



### 2.3.6 Pass/Fail Judgments Using the Limit line Function

Pass/fail judgments for traces on the screen can easily be made by storing the upper (Line 1) and lower (Line 2) limit values using the limit line function.

Power on

1. Turn the power on.

Connecting the input signal cable

2. Connect the calibration signal used in the measurement.

Initialization

This resets the current settings to the factory defaults or user-defined presets.

3. Press **SHIFT** and **CONFIG(PRESET)**.  
This sets the analyzer to its presets values.

Setting the measurement conditions

This changes the analyzer settings so that the input signal is displayed more clearly.

4. Press **FREQ, 3, 0** and **MHz**.  
The center frequency is set to 30 MHz.
5. Press **SPAN, 2, 0** and **MHz**.  
A frequency span of 20 MHz is set.
6. Press **LEVEL, 0** and **GHz(+dBm)**.  
The reference level is set to 0 dBm.

2.3.6 Pass/Fail Judgments Using the Limit line Function

Setting the limit line

Each limit line uses the data in the table.

**Table 2-4 Setting Limit Line 1**

	Frequency	Level
1	22 MHz	-70 dBm
2	27 MHz	-70 dBm
3	28.5 MHz	-5 dBm
4	31.5 MHz	-5 dBm
5	33 MHz	-70 dBm
6	38 MHz	-70 dBm

**Table 2-5 Setting Limit Line 2**

	Frequency	Level
1	22 MHz	-95 dBm
2	29 MHz	-95 dBm
3	29.5 MHz	-60 dBm
4	30.5 MHz	-60 dBm
5	31 MHz	-95 dBm
6	38 MHz	-95 dBm

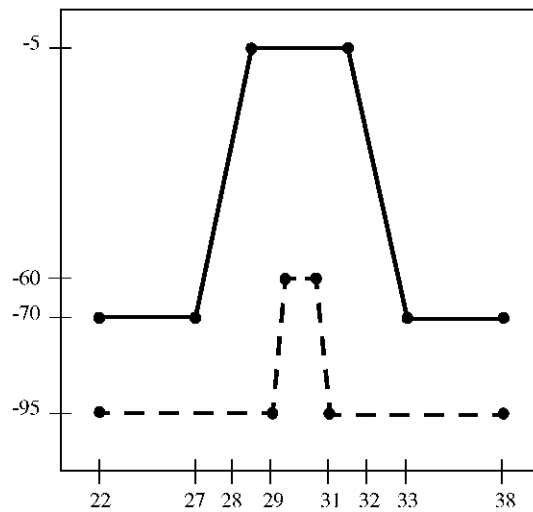

7. Press **PAS/FAIL**, and *Limit Line Edit*.  
The Edit menu and editor used for Limit Line 1 are displayed.
8. Press **2, 2** and **MHz**.  
22 MHz is set in the first frequency entry, and the cursor moves to the level entry.
9. Press **7, 0** and **MHz(-dBm)**.  
-70 dBm is set in the first level entry, and the cursor moves to the second row.

- Continue entering data into Table 2-4, repeating steps 8 and 9.

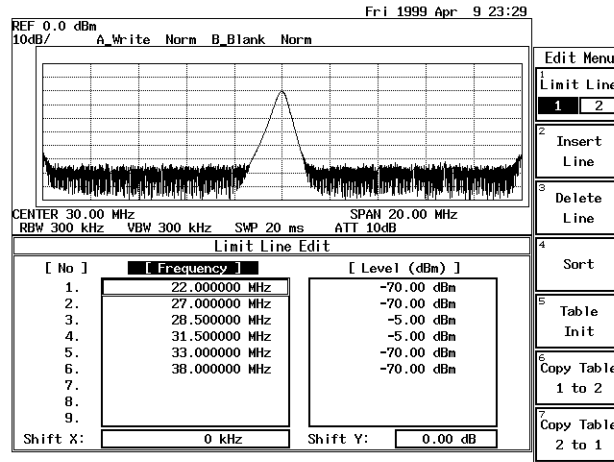

Figure 2-78 Screen Displayed after Limit Line 1 Data Has Been Entered

- Press **Limit Line 1/2(2)**.  
The editor is changed from the Limit line 1 mode to the Limit line 2 mode.
- Press **2, 2** and **MHz**.  
A frequency of 22 MHz is set in the frequency entry used for Limit Line 2. The cursor moves to the level entry.
- Press **9, 5** and **MHz(-dBm)**.  
A level of -95 dBm is set in the first level entry.
- Continue entering data into Table 2-5, repeating steps 12 and 13.

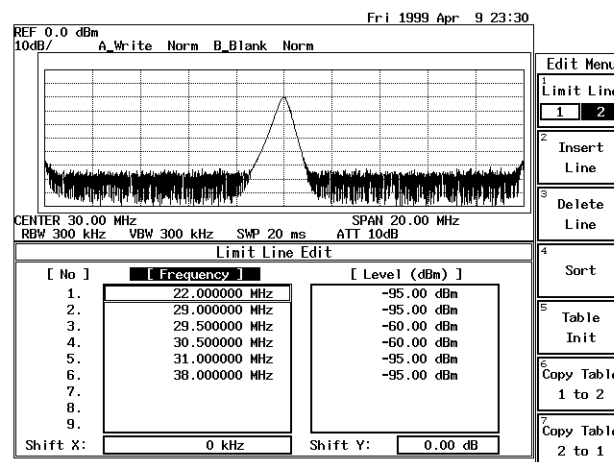

Figure 2-79 Screen Displayed after Limit Line 2 Data Has Been Entered

2.3.6 Pass/Fail Judgments Using the Limit line Function

15. Press **RETURN**.  
The editor for Limit line 2 is closed and the Pass/Fail menu is displayed.

Displaying the Limit Line 1 and setting the Pass/Fail criteria

16. Press **Line1 ON/OFF(ON)**.  
Limit Line 1 is displayed, and then the Pass/Fail result is displayed.

Limit Line 1 displays a higher limit for waveform data.  
When waveform data values are lower than Limit Line 1, the result is Pass.

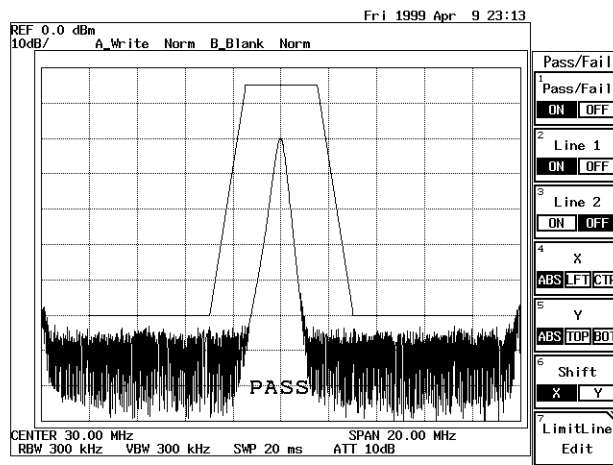

Figure 2-80 PASS/FAIL Result using Limit Line 1 (PASS)

Displaying the Limit Line 2 and setting the Pass/Fail criteria

17. Press **Line2 ON/OFF(ON)**.  
Limit Line 2 is displayed, and then the Pass/Fail result is displayed.

Limit Line 2 displays a lower limit for waveform data.  
When waveform data values are higher than Limit Line 2, the result is Pass.

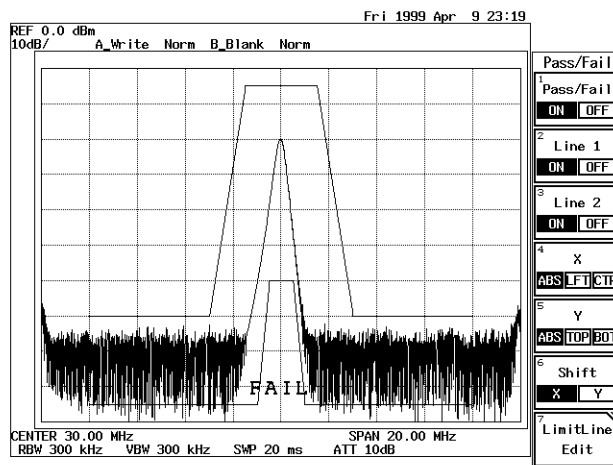

Figure 2-81 PASS/FAIL Result using Limit Lines 1 and 2 (FAIL)

18. Press **BW**, **VBW AUTO/MNL(MNL)**, **3, 0** and **kHz**.  
The VBW is set to 30 kHz.  
Waveform data values become higher than Limit Line 2, the result becomes Pass accordingly.

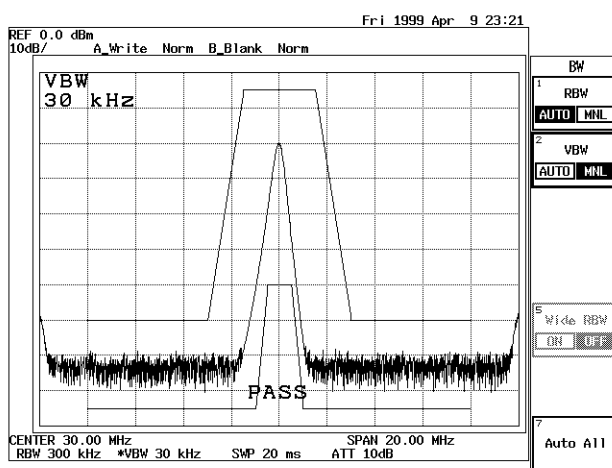

Figure 2-82 PASS/FAIL Result using Limit Lines 1 and 2 (PASS)

Setting an offset for the limit line

19. Press **PAS/FAIL**, and **Shift X/Y(X)**.  
Enter an arbitrary value used as the Limit Line frequency offset.

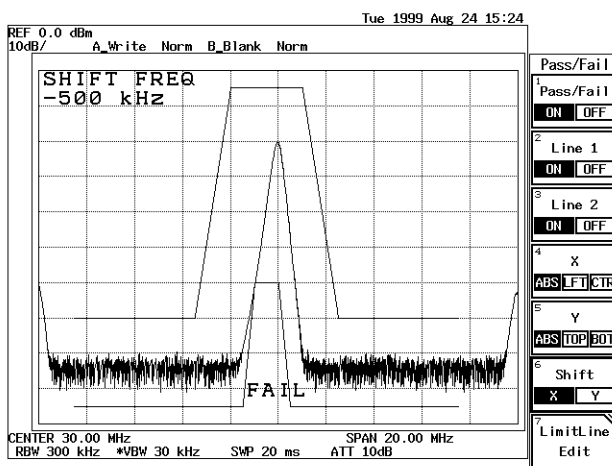

Figure 2-83 Judgment Result after the Offset Has Been Changed (FAIL)

20. Press **PAS/FAIL**, **Shift X/Y(Y)**.  
Enter an arbitrary value used as the Limit Line level offset.

2.3.6 Pass/Fail Judgments Using the Limit line Function

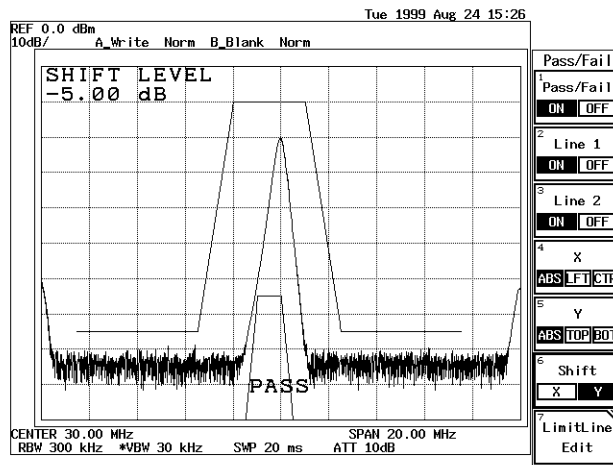

Figure 2-84 Judgment Result after the Offset Has Been Changed (PASS)

### 2.3.7 Measurements Using TG (OPT74)

Band-pass filter characteristics with a passband of approximately 270 MHz, are measured (both the insertion loss and bandwidth are measured).

---

**CAUTION:** *UNCAL messages, displayed when measuring frequency characteristics using this function, do not affect measurement results.*

---

#### Setup

1. Connect the unit under test as shown in Figure 2-85.

R3132 Series Spectrum analyzer

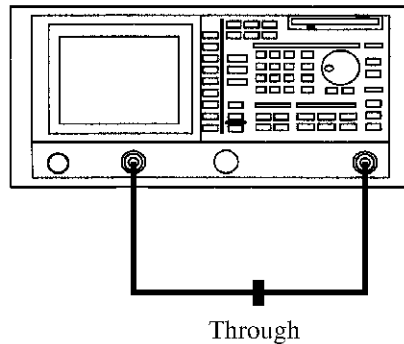

Figure 2-85 Setup for TG Measurements

#### Power on

2. Turn the power on.

#### Initialization

This resets the current settings to the factory defaults.

3. Press **SHIFT** and **CONFIG(PRESET)**.  
The default settings have now been reset.

#### Setting the measurement conditions

This changes the analyzer settings so that the input signal is displayed more clearly.

4. Press **FREQ, 2, 7, 0** and **MHz**.  
A center frequency of 270 MHz is set.
5. Press **SPAN, 1, 0, 0** and **MHz**.  
A frequency span of 100 MHz is set.
6. Press **LEVEL, 0** and **GHz(+dBm)**.  
The reference level is set to 0 dBm.

2.3.7 Measurements Using TG (OPT74)

7. Press **LEVEL**, *dB/div* and **2dB/div**.  
The amplitude scale (vertical axis) graduation is set to 2dB/div.
8. Press **TG**, **TG Level**, **5** and **MHz(-dBm)**.  
The output level of the tracking generator is set to -5 dBm.
9. Press **TG** and **Execute Normalize**.  
The normalization calibration is performed.

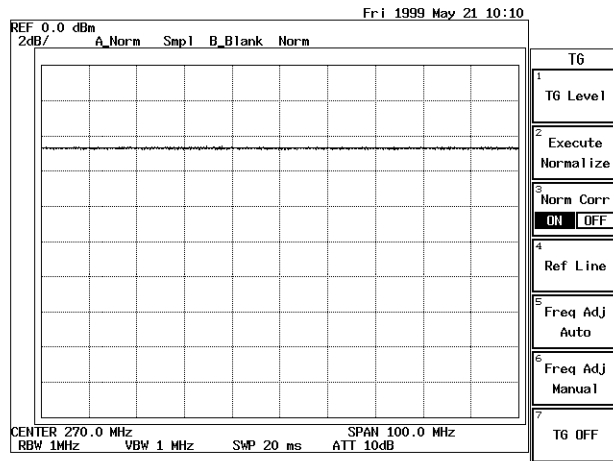

**Figure 2-86 Measurement Screen after a Normalization Calibration**

---

**NOTE:** *When you change center frequency, frequency span, reference level, level indication scale and so on after executing a normalization calibration, subsequent normalization results will be incorrect. Be sure to re-execute the normalization operation if you change any of these settings.*

---



## Connecting the unit under test

10. Connect the unit under test between TG OUTPUT and RF INPUT1 as shown in Figure 2-87.

R3132 Series Spectrum analyzer

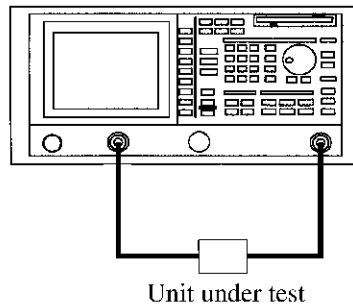
**Figure 2-87 Connecting the Unit under Test**

## Setting the sweep time

Set a sweep time long enough to not affect the trace.  
In this step, set it to 50 ms.

11. Press **SWEEP**, *SWP Time AUTO/MNL*, **5, 0** and **kHz(msec)**.

---

**CAUTION:** *If the input signal level changes abruptly, the IF filter in this instrument will not respond to this change. If this occurs, make the sweep slow enough or the span narrow enough until the characteristics and displayed trace are stabilized.*

---

## Measuring the insertion loss

12. Press **PK SRCH**.  
The current marker level is the insertion loss of the filter.

---

**CAUTION:** *When the loss of the unit under test is high, you can take measurement by use of an amplifier to keep the dynamic range at a moderate level.*

---

2.3.7 Measurements Using TG (OPT74)

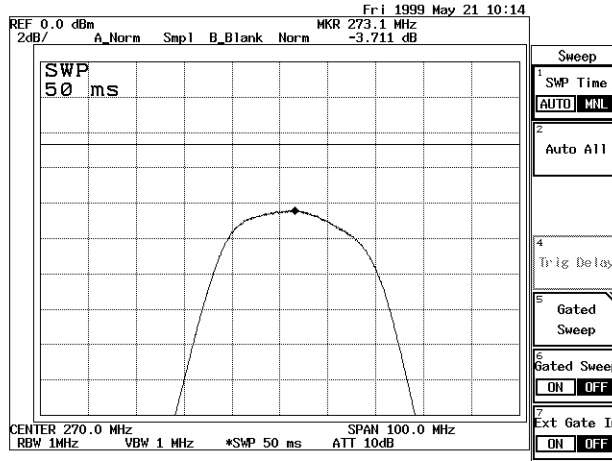

Figure 2-88 Insertion Loss Measurement Screen

Measuring a Bandwidth of 3 dB

This measurement is taken under the same conditions as the insertion loss..

13. Press **MEAS**, **XdB Down**, **3**, **GHz(+dBm)** and **XdB Down**.  
 Two markers are displayed on both sides 3 dB down from peak.  
 The filter bandwidth of 3 dB is displayed in the level field of the marker frequency

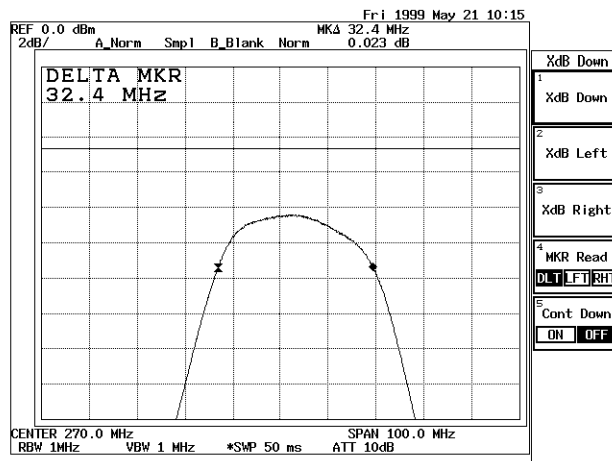

Figure 2-89 3-dB Bandwidth Measurement Screen

### 2.3.8 Spectrum Mask Measurement

The ACP is measured using the ratio of the adjacent leakage power to the total power on the full screen, while the spectrum mask is measured using the ratio of the adjacent channel power to the power within the BS (specified bandwidth) on the full screen. In addition, the near band spurious spectrum can be measured because the power relative to the power at the marker point can be measured by setting an adjacent channel's BS to 0 Hz. It is possible to make Pass/fail judgments for the near band spurious spectrum when the power is adjusted to the maximum power using a limit line.

In this section, the method used to measure modulating signals used for IS-95 (cdmaOne) is described.

Measurement conditions: The signal to be measured is a signal used for cdmaOne, and has a frequency of 825 MHz and a level of 0 dBm. Use appropriate parameter values to make the measurements shown below.

#### Setup

1. Connect the instrument as shown in Figure 2-90.

R3132 Series Spectrum analyzer

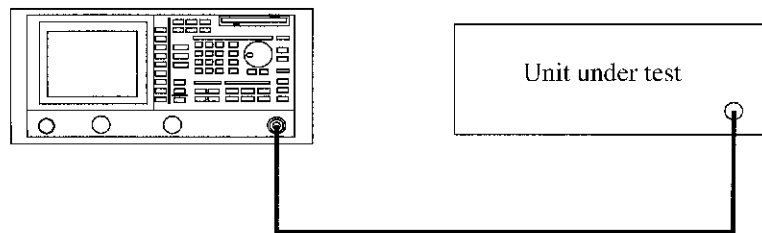

Figure 2-90 Setup for Measuring the Spectrum Mask

#### Power on

2. Turn the analyzer and the unit under test power on.

#### Setting the unit under test

3. Activate the signal output for the unit under test.

#### Initialization

This resets the current settings to the factory defaults or user-defined presets.

4. Press **SHIFT** and **CONFIG(PRESET)**.  
This sets the analyzer to its presets values.

#### Setting the Limit Line

In this example, the template compatible with IS-95 is used to set the limit line. The frequencies are relative to the center frequency on the horizontal axis, and the levels are relative to the reference position located at the highest level on the vertical axis.

2.3.8 Spectrum Mask Measurement

**Table 2-6 Setting Limit Line1**

	Frequency	Level
1	-2.5MHz	-54dB
2	-1.98MHz	-54dB
3	-1.98MHz	-42dB
4	-900kHz	-42dB
5	-900kHz	0dB
6	900kHz	0dB
7	900kHz	-42dB
8	1.98MHz	-42dB
9	1.98MHz	-54dB
10	2.5MHz	-54dB

5. Press **PAS/FAIL** and *Limit Line Edit*.  
The Edit menu is displayed.  
Limit Line 1 is selected and the Limit Line 1 editor is displayed.
6. Press **-, 2, ., 5** and **MHz**.  
A frequency of -2.5 MHz is set for the 1st frequency, and the cursor is moved to the first level box.
7. Press **5, 4** and **MHz(-dBm)**.  
A level of -54 dB is set for the 1st level, and cursor is moved to the 2nd frequency box.
8. Repeat Steps 6. and 7. to enter the remaining data in Table 2-6.
9. Press **RETURN**.  
The Limit Line 1 editor is removed and the Pass/Fail menu is displayed.
10. Press **X ABS/LFT/CTR(LFT)** and **X ABS/LFT/CTR(CTR)**.  
The frequencies entered are set relative to the center frequency on the horizontal axis.
11. Press **Y ABS/TOP/BOT(TOP)**.  
The levels, which are relative to the reference position located at the highest level on the vertical axis, are set.

Setting the measurement conditions

This changes the analyzer settings so that the input signal is displayed more clearly.

12. Press **FREQ, 8, 2, 5** and **MHz**.  
A center frequency of 825 MHz is set.
13. Press **SPAN, 5** and **MHz**.  
A frequency span of 5 MHz is set.
14. Press **BW, RBW AUTO/MNL(MNL), 3, 0** and **kHz**.  
An RBW of 30 kHz is set.
15. Press **VBW AUTO/MNL(MNL), 1** and **MHz**.  
A VBW of 1 MHz is set.
16. Press **TRACE, Detector** and **Posi** (or **Sample**).  
The trace detector is set to the positive peak detector mode.

**Posi :** The Ref. Power of the measurement result is 6 dB higher than the channel power, but the measurement value of the adjacent channel leakage ratio is the same as the one obtained using Sample. This mode is used when the near band spurious spectrum is measured.

**Sample :** The Ref. Power of the measurement result is the same as the channel power. This mode is used when power measurements.

17. Press **LEVEL** and adjust the data knob so that the trace peak is positioned approximately 2 graduations below the reference level.
18. Press **SWEEP, SWP Time AUTO/MNL(MNL), 2, 0, 0** and **kHz(msec)**.  
A sweep time of 200 ms is set.

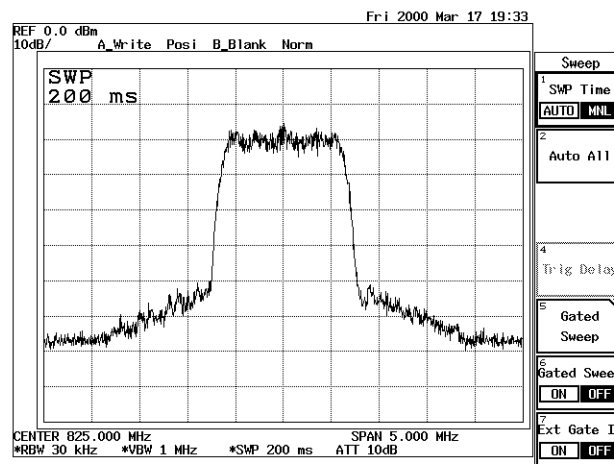

**Figure 2-91 A Trace Used with IS-95**

#### Setting the channel spacing and specified bandwidth

The channel spacing and specified bandwidth, which are compatible with IS-95, are set.

2.3.8 Spectrum Mask Measurement

19. Press **POWER MEASURE**, *1/2\_more* and *Spectrum Mask*.  
Limit Line 1 is displayed and the frequency span is optimized using the previously set channel spacing and specified bandwidth.
20. Press **SPAN**, **5** and **MHz**.  
A frequency span of 5 MHz is set again.
21. Press **POWER MEASURE** and *CS/BS Setup*.  
The dialog box used to set the channel spacing and specified bandwidth is displayed.
22. Press **1**, **,**, **2**, **3** and **MHz**.  
A carrier bandwidth of 1.23 MHz is set. The cursor is moved to the 1st channel's Channel Space.
23. Press **9**, **0**, **0** and **kHz**.  
The 1st channel's channel spacing is set to 900 kHz. The cursor is moved to the 1st channel's Band Width.
24. Press **0** and **Hz**.  
The 1st channel's specified bandwidth is set to 0 Hz. The cursor is moved to the 2nd channel's Channel Space.
25. Press **1**, **,**, **9**, **8** and **MHz**.  
The 2nd channel's channel spacing is set to 1.98 MHz. The cursor is moved to the 2nd channel's Band Width.
26. Press **0** and **Hz**.  
The 2nd channel's specified bandwidth is set to 0 Hz.

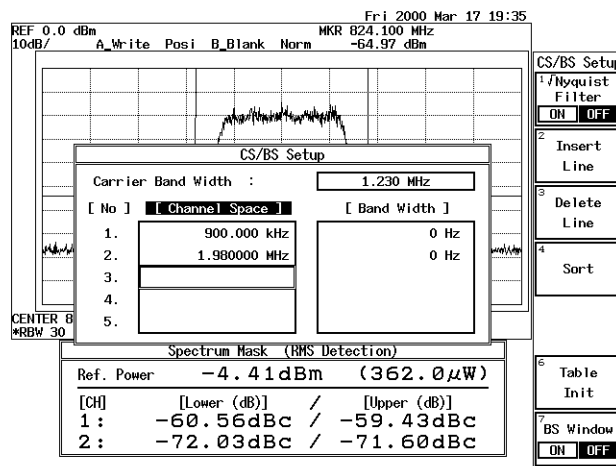

Figure 2-92 CS/BS Setup Dialog Box

27. Press **RETURN**.  
The CS/BS Setup dialog box is closed.

## Measurements Using the Spectrum Mask Function

28. Two markers are displayed at both of the adjacent channel positions for each sweep, and a ratio of the channel leakage power to the channel power within the carrier bandwidth is displayed for the corresponding adjacent channel.

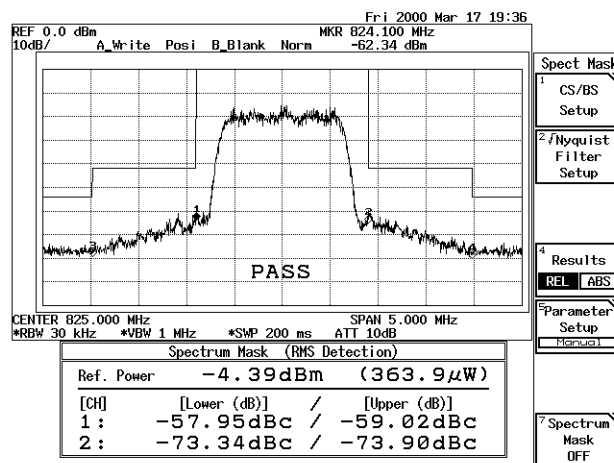

Figure 2-93 Spectrum Mask Measurement Screen

2.3.9 Measuring Output Levels Using the Software Image Suppression function (OPT16 thru OPT19)

**2.3.9 Measuring Output Levels Using the Software Image Suppression function (OPT16 thru OPT19)**

Frequencies and output levels of a VCO unit are measured after unnecessary image signals have been eliminated using the Software Image Suppression function.

Measurement conditions: The measurement target is a VCO unit with a frequency of 92 GHz and an output level of -15 dBm. OPT19 (Frequency range: 75 to 110 GHz) is used as the external mixer.

Setup

1. Set up the instruments as shown in Figure 2-94.

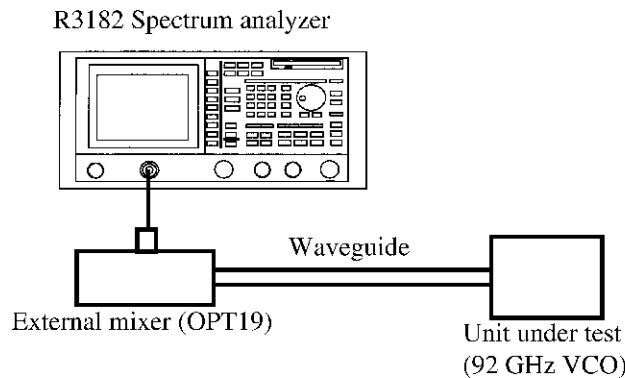

**Figure 2-94 Setup for measuring VCO Output Levels**

Power on

2. Turn the instrument power on.

Initializing the set conditions

This resets the current settings to the factory defaults.

3. Press **SHIFT** and **CONFIG(PRESET)**.  
The factory defaults are loaded.

Setting the measurement conditions

Load the frequency correction data using the same procedure described in Section 2.2.15, "External Mixer (OPT16 thru OPT19)." After data has been loaded from the floppy disk, the mixer is automatically set to External Mixer Mode, and the settings corresponding to the external mixer being used are also set automatically. In this example, the file name WHMB10 is loaded. External Mixer Mode is turned on, and a frequency range of 75 to 110 GHz is displayed on the screen because a frequency band of 9 has been set.



## 2.3.9 Measuring Output Levels Using the Software Image Suppression function (OPT16 thru OPT19)

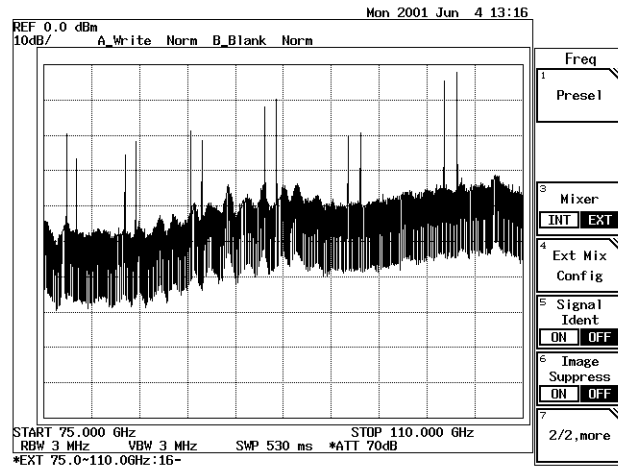

Figure 2-95 Measurement Signal with an Image Signal

4. Press **RETURN** and **Image Suppress ON/OFF(ON)**.  
Image Suppression function is turned on, and the output signal from the unit under test is displayed after the image signal has been eliminated.

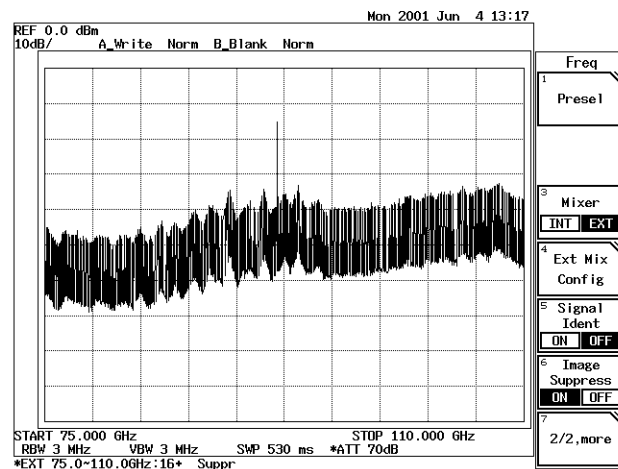

Figure 2-96 Measurement Signal with the Image Signal Eliminated

Examining signals using the ZOOM function

5. Press **DISPLAY, Multi Screen** and **Zoom**.  
A waveform with the image signal eliminated is displayed on the A screen (upper), and a waveform without the image signal eliminated is displayed on the B screen (lower).  
The Zoom window is displayed on the A screen, and the Zoom Position is ready to be entered.
6. Press **9, 2** and **GHz**.  
The window position is set to 92 GHz.

2.3.9 Measuring Output Levels Using the Software Image Suppression function (OPT16 thru OPT19)

7. Press **Zoom Width, 3, ., 5** and **GHz**.  
The window width is set to 3.5 GHz.
  
8. Press **Screen A/B(B)** and **PK SRCH**.  
The peak search function displays a marker on the peak of the output signal from the unit under test.  
The level and frequency of the output signal is displayed in the marker area.

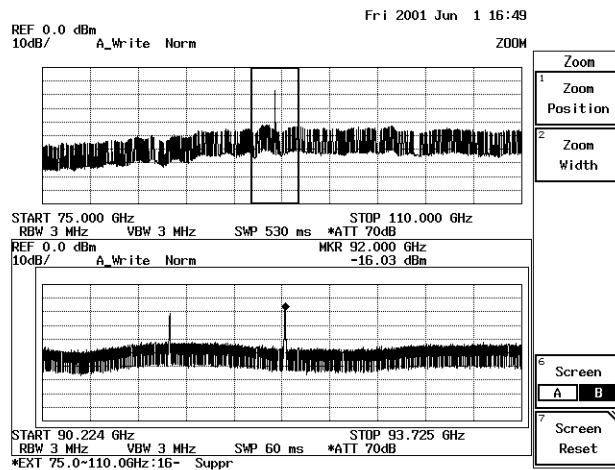

Figure 2-97 Software Image Suppression Function in Split Screen Mode

### 2.3.10 FM Demodulation Function (OPT73)

This section explains how to measure FM modulation signal characteristics (FM deviation, sensitivity and linearity measurements).

Measurement conditions: The signal to be measured is a triangle modulation signal (of an FM frequency of 10 Hz, and an FM deviation of 2.6 kHz) with a center frequency of 200.003 MHz, a level of 0 dBm.

Use appropriate parameter values to make the measurements shown below.

#### Setup

1. Connect the analyzer and the unit under test as shown in Figure 2-98.

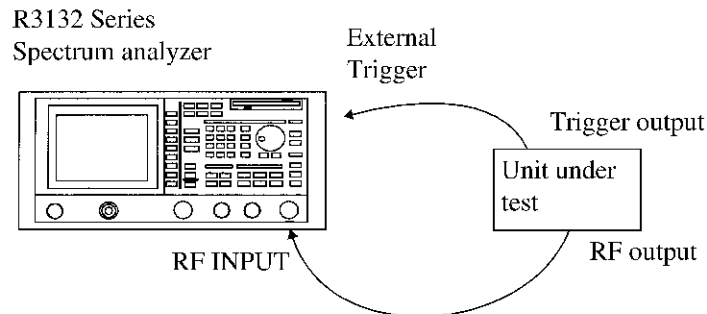

Figure 2-98 Setup for Measurements Using the FM Demodulation Function

#### Power on

2. Turn the analyzer power and the unit under test power on.

#### Initializing the set conditions

This resets the current settings to the factory defaults.

3. Press **SHIFT** and **CONFIG(PRESET)**.  
The factory defaults are loaded.

#### Setting the measurement conditions

This changes the analyzer settings so that the input signal is displayed more clearly.

4. Press **FREQ, 2, 0, 0, ,, 0, 0, 3** and **MHz**.  
A center frequency of 200.003 MHz is set.
5. Press **UTILITY** and **FM Demod**.  
The FM demodulation function is turned on.
6. Press **Demod Cal** and **All**.  
The calibration prior to an FM demodulation measurement is performed.

2.3.10 FM Demodulation Function (OPT73)

---

**CAUTION:** *To make accurate measurements including calibrations, let the instrument warm up for at least 30 minutes after the power has been turned on.*

---

7. Press **Return, Range, 1** and **kHz**.  
The frequency scale (vertical axis) is set to 1 kHz/.

---

**NOTE:** *A frequency range of 500 kHz/ or more can be used if an external mixer is used. In addition, the value of RBW varies according to the frequency range used. The settable value of RBW for each frequency range is as shown in Table 2-7.*

---

**Table 2-7 Relationship Between Frequency Range and the Value of RBW**

Frequency range	RBW (The value in bold script is set when the frequency range is switched)
50 MHz/ to 500 kHz/	Cannot be set (displayed as ***)
250 kHz/ to 25 kHz/	<b>10 MHz</b> and 3 MHz
10 kHz/ to 1 kHz/	<b>1 MHz</b> , 300 kHz, 100 kHz, 30 kHz and 10 kHz

8. Press **SWEEP, SWP Time AUTO/MNL(MNL), 2, 0, 0** and **kHz(msec)**.  
The time scale (horizontal axis) is set to 200 msec.
9. Press **TRIG** and *Ext Trig*.  
The trigger source is switched to the external trigger.
10. Press **BW, VBW AUTO/MNL(MNL), 1** and **kHz**.  
The VBW is set to 1 kHz.

FM deviation measurement

11. Press **UTILITY** and *Deviation*.  
FM deviation, positive peak deviation, negative peak deviation, and repetition frequency are displayed in the lower part of the screen. In addition, the display line is displayed in the center of an FM deviation.

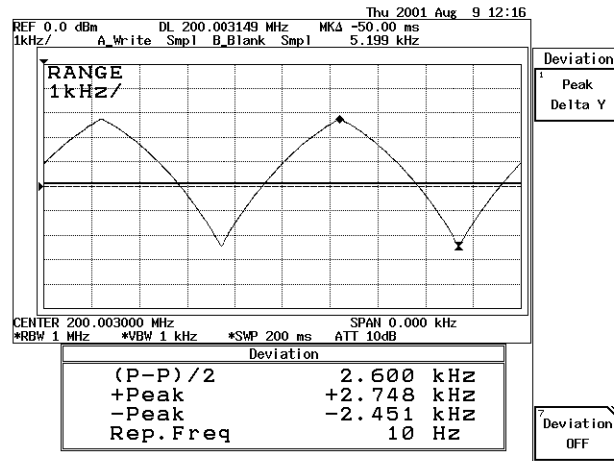

Figure 2-99 FM Deviation Measurement

- Press **Deviation OFF**.  
The FM deviation measurement function is turned off.

Sensitivity Measurement

The sensitivity measurement calculates the  $\Delta F/\Delta T$  of trace data, and displays it.  $\Delta T$  is determined by Aperture as shown in the formula below:

$$\Delta T = \text{Sweep time} \times \text{Aperture} [\%]$$

The unit of the vertical axis is [Hz/ms/] for a frequency range of 1 MHz/ or more, and is [Hz/s/] for a frequency range of 500 kHz/ or less. The value of the vertical axis (sensitivity range) is optimized according to the frequency range and sweep time used.

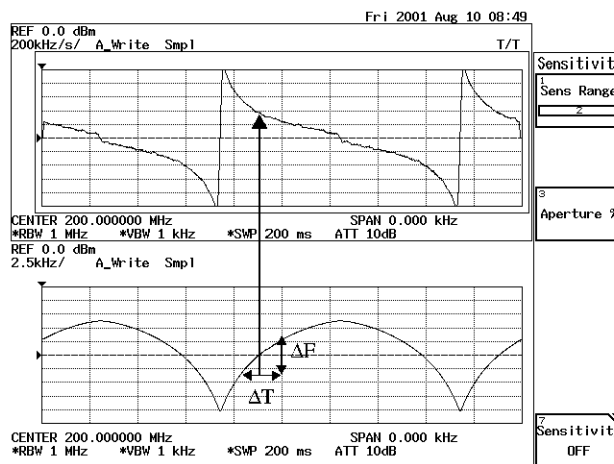

Figure 2-100 How to Calculate the Sensitivity

2.3.10 FM Demodulation Function (OPT73)

13. Press *Sensitivity* and *Sens Range*.  
The trace is switched to a waveform obtained by differentiating an FM demodulated waveform.
14. Press ▼ and ▼ .  
The vertical axis is magnified in two positions.
15. Press *Aperture %*, **3** and **Hz**.  
The differential section along the horizontal axis is set to 3%.

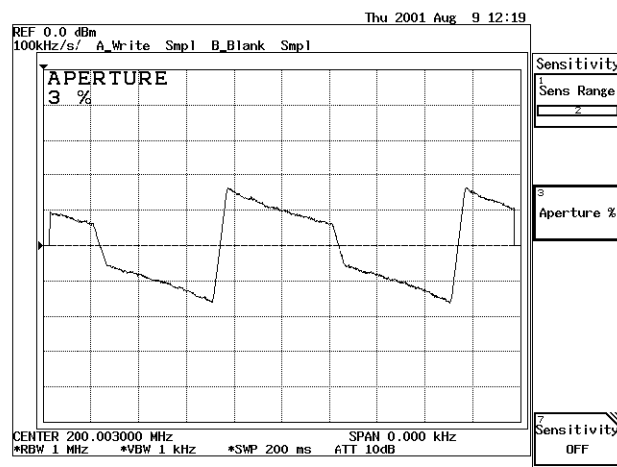

Figure 2-101 Sensitivity Measurement Screen

16. Press **DISPLAY**, *Multi Screen* and *T/T*.  
The screen display is switched to Separate Screen Mode. The sensitivity is displayed in the upper part of the screen and a normal demodulation is displayed in the lower part of the screen.

**NOTE:** Always set the same frequency for the upper and lower screens when the sensitivity is displayed in T/T Mode.

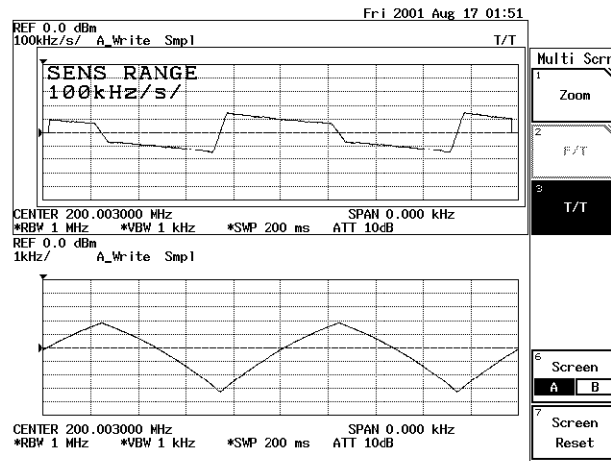

Figure 2-102 Simultaneously Displaying Sensitivity and Demodulation

17. Press **Screen Reset**.  
The screen display is switched to Full Screen Mode.
18. Press **UTILITY** and **Sensitivity OFF**.  
The sensitivity display function is turned off.

Linearity Measurement

The linearity measurement displays the difference between the trace and the reference line. The reference line can be set in two ways: one is to manually set with Offset and Slope, and the other is to automatically set with the Auto Adj function. In addition, if the measuring window is used, Offset and Slope are automatically adjusted to the values specified in the measuring window.

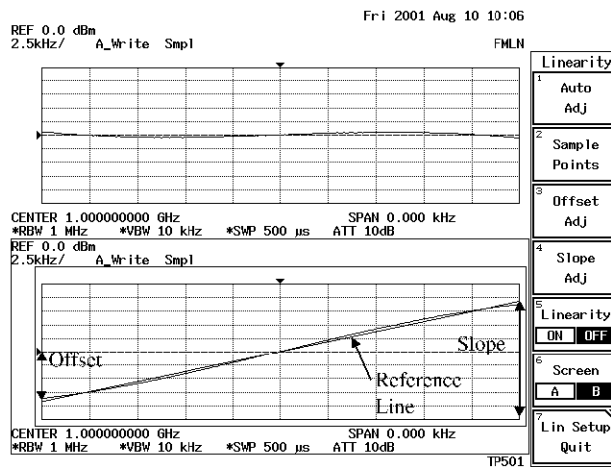

Figure 2-103 Setting Offset and Slope Used for Linearity Measurements

2.3.10 FM Demodulation Function (OPT73)

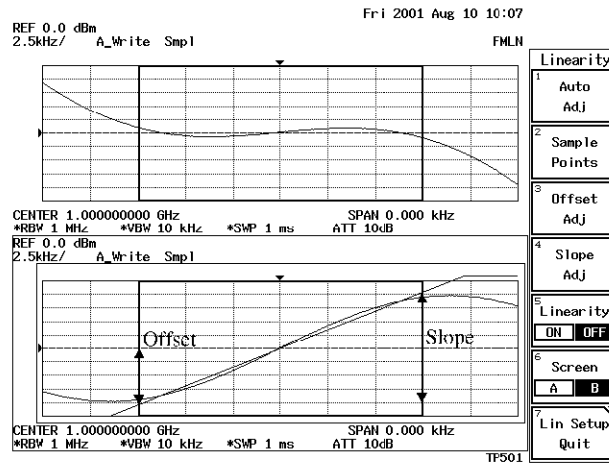

Figure 2-104 Setting Offset and Slope when Using the Measuring Window

19. Press **DISPLAY**, *Measuring Window* and *Marker Couple ON/OFF*(ON).  
The measuring window is displayed, and the range used to measure the linearity is set.
20. Press **UTILITY**, *Linearity* and *Auto Adj*.  
The reference line is calculated from a trace in the measuring window using the least-square method.
21. Press *Linearity ON/OFF*(ON).  
The difference between the trace and the reference line is displayed on the screen, and the minimum and maximum differences are displayed in the lower part of the screen.

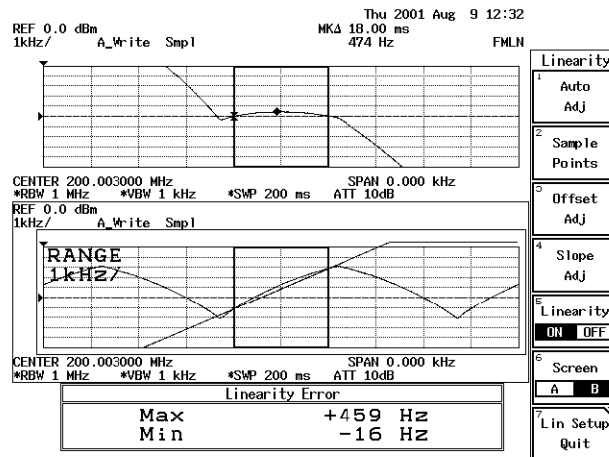

Figure 2-105 Linearity Measurement

22. Press *Lin Setup Quit*.  
The screen display is switched from Separate Screen Mode to Full Screen Mode.



23. Press *Linearity ON/OFF*(OFF).  
The linearity function is turned off.

## 2.4 Other Functions

### 2.4 Other Functions

#### 2.4.1 Using Floppy Disks

The spectrum analyzer is equipped with a 3.5-inch floppy disk drive. You can save text data (settings, trace data and correction data) and BMP data (bitmap files) to floppy disks using this drive. The data on floppy disks can be accessed from personal computers.

The following floppy disk formats can be used: 3.5-inch DD 720KB, HD 1.2 MB and 1.44MB (MS-DOS format compatible).

##### (1) Write-protecting the Floppy Disk

This prevents you from accidentally initializing or overwriting a floppy containing previously saved data.

The write protect tab is located in the lower right hand corner of the floppy disk. To write-protect a disk, slide the tab downwards to the other end (a hole appears). To disable write protection, slide the tab upwards to the original position until the hole is no longer visible.

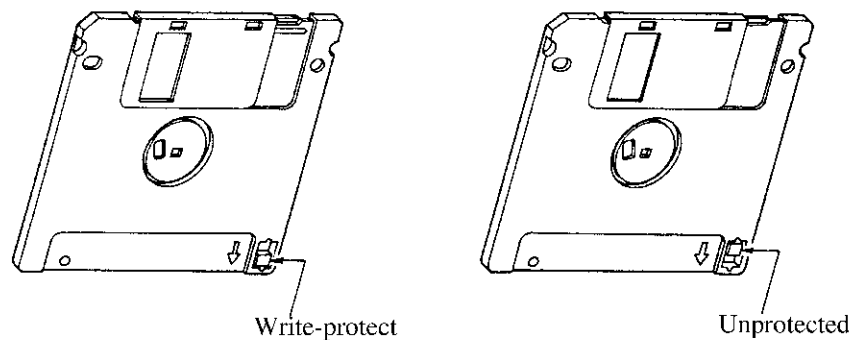

**Figure 2-106 Floppy Disk Write Protection**

##### (2) Inserting Floppy Disks

1. Insert a floppy disk into the floppy disk drive with the label surface up.

## (3) Removing Floppy Disks

1. Verify that the lamp on the drive is not lit and then remove the disk.

---

**CAUTION:** *Do not remove the floppy disk while the drive lamp is lit, since this indicates that floppy disk is being accessed. If you remove the disk while the disk is being accessed, you may damage the data contained on the disk.*

---

2. Press the eject button.  
The floppy disk is ejected from the drive.
3. Remove the disk from the drive.

## (4) Initializing Floppy Disks

To prepare a floppy disk for use with the spectrum analyzer, use the following procedure.

---

**CAUTION:** *Only HD floppy disks can be formatted on this spectrum analyzer. Do not try to initialize DD floppy disks.*

---

1. Make sure the floppy disk is not write protected.

---

**CAUTION:** *When you format a floppy disk, all data on the floppy is erased. If you wish to save any data currently on the disk, backup the data first.*

---

2. Insert the floppy disk into the floppy disk drive.
3. Press **CONFIG**, **1/2\_more**, and **Format FD**.  
The F.Disk dialog box appears.  
Confirm or Cancel can be selected using the step keys or data knob.

2.4.1 Using Floppy Disks

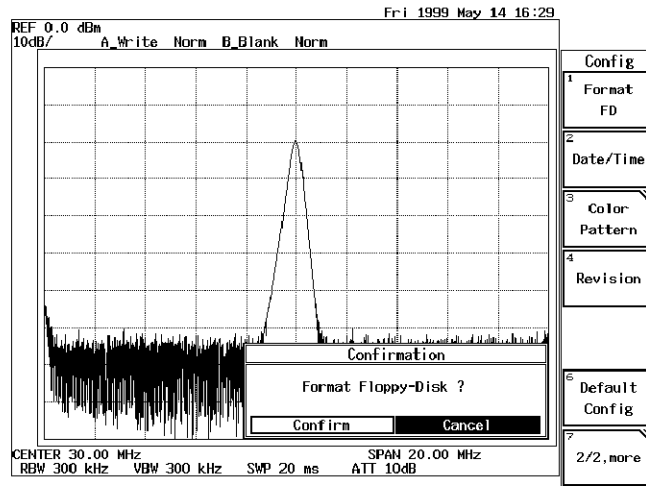

Figure 2-107 Screen for the F.Disk Menu

4. Select Confirm and then press the **ENTER(Hz)** key.  
The floppy disk is formatted with the MS-DOS 1.44MB format.  
While the floppy disk is being formatted, the access lamp turns on. This procedure takes approximately one minute.
5. When the spectrum analyzer does not need to be initialized, select Cancel and then press the **ENTER(Hz)** key.

## 2.4.2 Saving or Recalling Data

### (1) Saving Data

Data which can be saved to internal memory or to a floppy disk includes the following:

- measurement conditions
- Trace data

---

**NOTE:** *Only the trace data on the screen is saved. For example, if traces A and B are displayed, both of them are saved.*

---

- Antenna correction data
- Normalize data
- Limit line data
- The level values for trace data
- Channel table data
- Spurious measurement table data
- Loss:Freq table data

To save data, use the following procedure:

1. Press **SHIFT** and **RECALL(SAVE)**.  
The Save menu and the file list are displayed. The file list can be scrolled up or down one page at a time using the step keys.
2. Press **Device RAM/FD**.  
This selects either RAM (internal memory) or FD (floppy disk) as the file destination.

---

**NOTE:** *FD cannot be selected if a floppy disk is not present in the floppy disk drive.*

---

2.4.2 Saving or Recalling Data

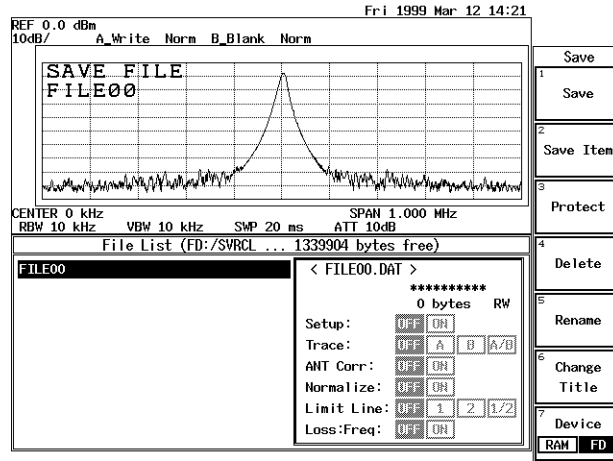

Figure 2-108 Screen Display Showing Floppy Disk as the Destination

Selecting the data to be saved

3. Press *Save Item*.  
The Save Item dialog box is displayed.
4. Select the data you want to save from the Save dialog box.
  - Setup ON/OFF* : current settings
  - Trace ON/OFF* : Trace data being displayed
  - Ant Corr ON/OFF* : Corrected antenna data
  - Norm Corr ON/OFF* : Normalization calibration data (available only when equipped with OPT74).
  - Limit Line 1/ 2/ 1/2/ OFF*:Limit Line data
  - Loss:Freq ON/OFF* : Loss:Freq table data (Enabled only when the OPT 16, 17, 18 or 19 is installed.)
  - Trace Level ON/OFF* : level values for the trace data (available when trace data is being saved)
  - Channel ON/OFF* : Channel table data
  - Spurious ON/OFF* : Spurious measurement table data

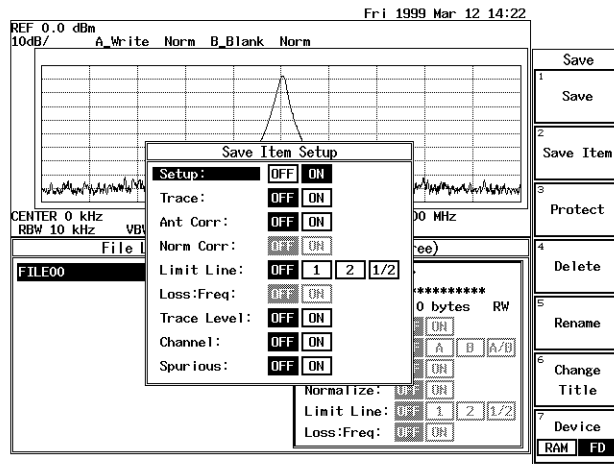

Figure 2-109 Display for Selecting the Data to be Saved

5. Press *Save Item*.  
The Save menu is closed.

Choosing the file name

6. Select the file name you want to save your data under using the data knob.  
When the file is being saved to RAM, the file names appear as REG00 or above.  
For floppy disks, the file names start from FILE00 and continue with 01, 02 etc.

---

**NOTE:** *In the above example a file number is used instead of a file name, but you can use an arbitrary file name if desired. For information on how to set file names, refer to Section 2.4.5.*

---

Saving data

7. Press *Save*.  
The data has now been saved.

2.4.2 Saving or Recalling Data

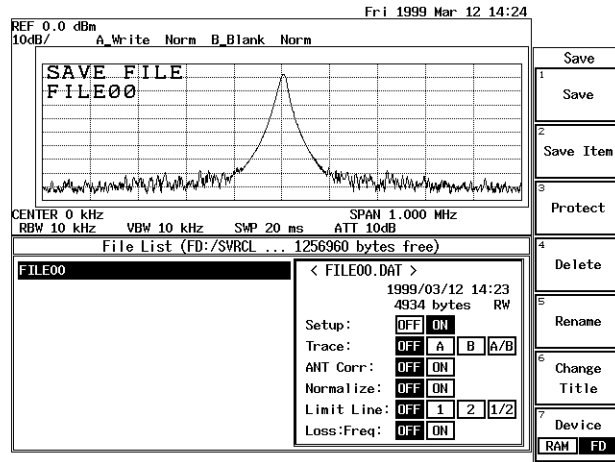

Figure 2-110 Display after Data has been Saved to a File

(2) Protecting Data

To prevent someone from accidentally initializing or overwriting data, you can use the file protection feature.

To protect files using this feature, use the following procedure:

Selecting the file source

1. Press **SHIFT** and **RECALL(SAVE)**.  
The Save menu and file list are displayed.
2. Press **Device RAM/FD**.  
Select either RAM (internal memory) or FD (floppy disk).

Choosing the file

3. Select the file from the file list using the data knob.

Protecting the file

4. Press **Protect**.  
The selected file changes from RW (read or write) to RO (read only), indicating that data protection has been enabled.  
Pressing **Protect** again disables protection, and the setting changes back to RW.



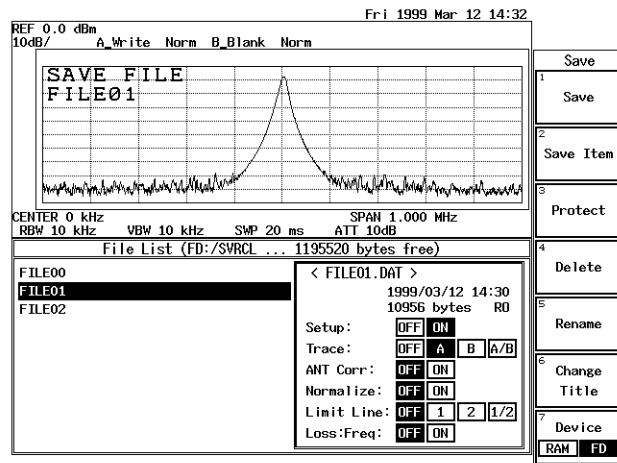

Figure 2-111 Screen Display Showing File Protection Enabled

### (3) Loading Data

The saved conditions and trace data can be used for measurements. Use the following procedure to access this data.

#### Selecting the file source

1. Press **RECALL**.  
The Recall menu and file list are displayed.
2. Press **Device RAM/FD**.  
Select either RAM (internal memory) or FD (floppy disk). For this example, FD is selected.

#### Selecting the file

3. Select the file from the file list using the data knob.

2.4.2 Saving or Recalling Data

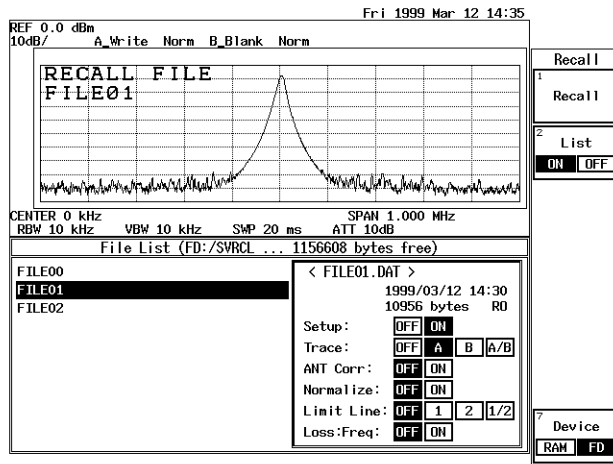

Figure 2-112 Screen Display Showing the Selected File

Recalling the data

4. Press **Recall**.  
The data from the selected file is loaded into the spectrum analyzer.

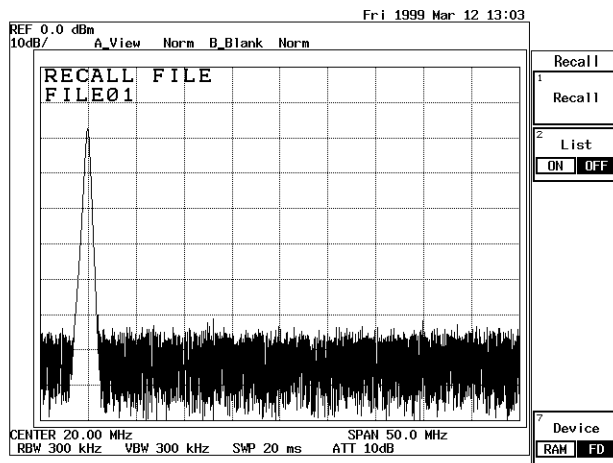

Figure 2-113 Screen Display showing Recalled Data

**NOTE:** When the trace data is read onto the screen, the trace mode is automatically set to the View mode.

## (4) Deleting the Data

Data which has been saved to internal memory or to a floppy disk can be deleted. To delete data files, use the following procedure.

## Selecting the file source

1. Press **SHIFT** and **RECALL(SAVE)**.  
The Save menu and file list are displayed.
2. Press **Device RAM/FD**.  
Select either RAM (internal memory) or FD (floppy disk). For this example, select FD.

## Choosing the file

3. Select the file from the file list using the data knob.

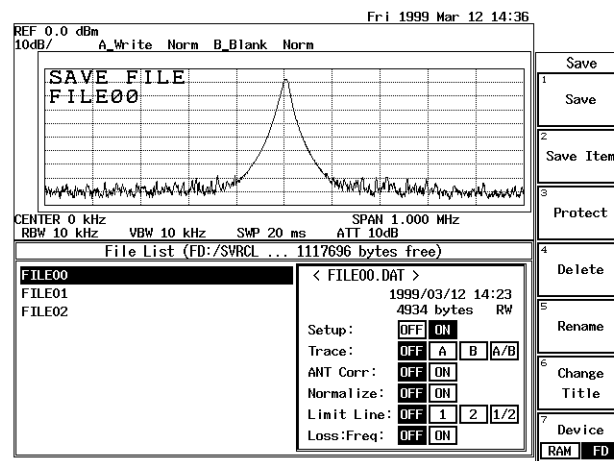

Figure 2-114 Screen as Shown when Deleting a File

## Deleting the data

4. Press **Delete**.  
The data in the selected file is deleted.

2.4.2 Saving or Recalling Data

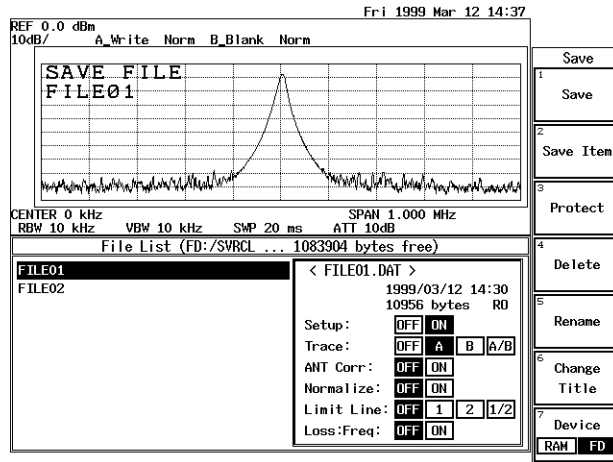

Figure 2-115 Screen as Shown after Deleting File Data

### 2.4.3 Outputting Screen Data

You can save screen data to a floppy disk, or print it out when needed. When outputting screen data, you can use any key except the **COPY** key. You can resume using this key after the data has been output.

#### (1) Saving to a Floppy Disk

Screen data is saved in BMP (bitmap file) format.

Inserting a floppy disk

1. Insert a floppy disk into the floppy drive.

Selecting the destination

2. Press **CONFIG**, *Copy Config* and *Copy Device PRT/FD*(FD).  
The FD is selected as the destination of the screen data.

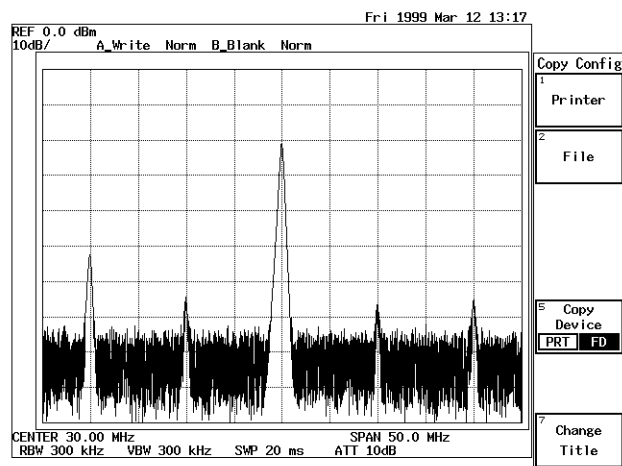

**Figure 2-116 Screen Display Showing Floppy Disk as the Specified Destination**

3. Press **COPY** after displaying the screen data to be saved. The access lamp remains lit while the screen data is being saved to disk, and goes out when the file has been saved.

---

**CAUTION:** *Do not remove the floppy disk while the access lamp is lit, since the floppy disk is being accessed. If you remove the disk while the disk is being accessed, you may damage the data on the disk.*

---

2.4.3 Outputting Screen Data

(2) Printing screen data

You can send data to a Centronix compatible printer attached to the parallel interface.

---

**NOTE:** *The output resolution of the spectrum analyzer is 180 dpi. A printer that uses a resolution which is not a multiple of 180 dpi may print with streaks.*

---

Compatible printers use ESC/P, ESC/P-Raster or HP PCL. Compatible printers use ESC/P, ESC/P-R or HP PCL (there may be a certain restrictions depending on the printers used).

ESC/P: Epson Standard Cord for Printer

ESC/P-R: Epson Standard Cord for Printer Raster mode

HP PCL: Hewlett Packard Printer Command Language

Suggested printers are listed in Table 2-8.

**Table 2-8 Recommended Compatible Printers**

Manufacturer	Model
Epson	PM-750C *1, PM-2000C, PM-770C *1, PM-800C *1, EM-900C *1, PM-780C *1, PM-880C *1, PM-900C *1
Hewlett Packard	DeskJet 694C *2, DeskJet 880C *2
Cannon	BJC-410J, BJC-420J, BJC-430J, BJ M70

---

**NOTE:** *Only ESC/P-R and HP PCL are available for color printing.  
\*1 indicates that ESC/P-R is used for color printing.  
\*2 indicates that HP PCL is used for color printing.*

---

Connecting the printer

1. Connect the printer to the PRINTER connector on the rear panel using the IBM-PC compatible cable provided.

---

**CAUTION:** *Only connect the cable after turning off both the spectrum analyzer and printer power or you may damage the analyzer.*

---

Selecting a destination for the screen data

2. Press **CONFIG**, *Copy Config* and *Copy Device PRT/FD(PRT)*.  
Screen data is sent to the printer (PRT).

Control codes and print mode setup

3. Press **CONFIG**, *Copy Config* and *Printer*.  
The Printer dialog box used to set the control codes and print mode appears.

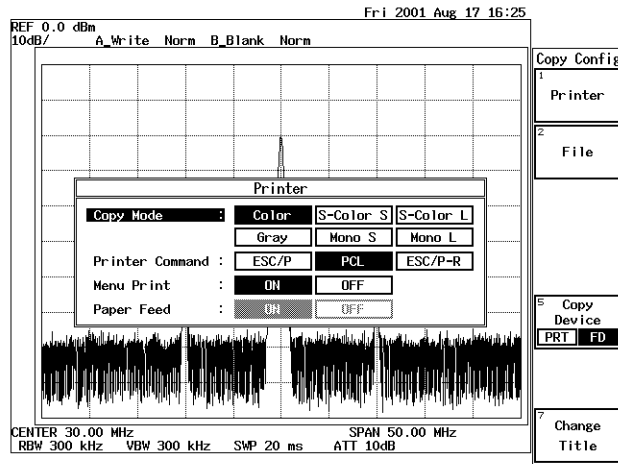

Figure 2-117 Printer Setup Screen

## Printing

4. Display the screen you wish to print out, and then press **COPY**. The screen data is sent to the printer. The time required for the data to print out depends on the mode and printer used.

---

**NOTE:** Press **SHIFT**, **COPY** and **Abort** to abort printing after **Copy** has been pressed.

---

2.4.4 Setting Date and Time

2.4.4 Setting Date and Time

This section explains how to set the date and time for the spectrum analyzer. In the following example, a time and date of 1:35 pm Mar 18 1999 is set.

Setting the date and time

1. Press **CONFIG**, *1/2\_more* and **Time/Date**.  
The Time/Date dialog box appears.

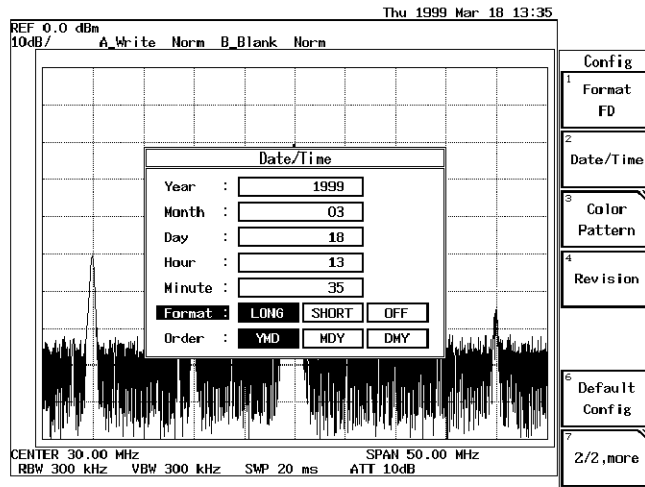

Figure 2-118 Time/Date Menu

2. Select **Year**, and press **1, 9, 9, 9** and **Hz(ENTER)**.  
The year is set to 1999.
3. Select **Month**, and press **0, 3** and **Hz(ENTER)**.  
The month is set to March.
4. Select **Day**, and press **1, 8** and **Hz(ENTER)**.  
The date is set to the 18th.

Setting the time

5. Select **Hour**, and press **1, 3** and **Hz(ENTER)**.  
The time is set to 1pm.
6. Select **Minute**, and press **3, 5** and **Hz(ENTER)**.  
The time is set to 1:35pm.



## Setting the date display format

7. Select **Format**, and set this function to **LONG**.  
The format used to set the date is selected.
8. Select **Order** and set this function to **YMD**.  
A date display mode is set.
9. Press **Date/Time**.  
The Date/Time dialog box is closed.

## 2.4.5 Setting the Screen Title

This section describes how to enter your remarks for the screen data. A maximum of 30 characters, which consist of alphanumeric and a few special characters, can be entered.

## Setting titles

1. Press **CONFIG**, **Copy Config** and **Change Title**.  
The Title Entry dialog box, which is used to enter alphanumeric characters and special characters, is displayed. This dialog box consists of the two areas: one is the area in which characters entered are displayed, and the other is the area in which the alphanumeric characters to be entered are displayed as buttons. (See Figure 2-119).

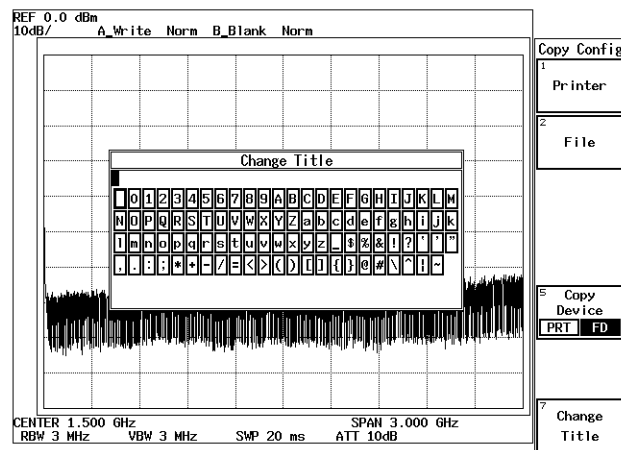

**Figure 2-119 Dialog Box Used to Enter Titles**

2. Select the characters you wish to enter using the data knob and step keys.  
The data knob is used to move the cursor horizontally in the button area; the step keys are used to move the cursor vertically between the rows in the button area. In this example, enter ADVANTEST1 using upper case alphabetic characters.
3. Move the cursor to character A, which is found on the first line, and press the ENTER key.  
Character A will be displayed in the input area within the dialog box. Note that the cursor in this area has been shifted one place to the right.

2.4.5 Setting the Screen Title

4. Select character B and press **Hz(ENTER)**. Then press **-(BK SP)**. Character B appears temporarily in the upper part and disappears when it is corrected by pressing **-(BK SP)**. Note that the cursor is next to character A on the right hand side.
5. Then enter the rest of the characters: D, V, A, N, T, E, S and T.
6. Press the numeric key **1**. Check to see if numeric character 1 has been entered after the characters ADVANTEST (the final display is ADVANTEST1). Only numeric characters can be entered directly from the numeric keys.
7. Press **Change Title**.  
This closes the Title Entry dialog box, and the characters you entered are displayed in the upper left-hand corner of the screen.

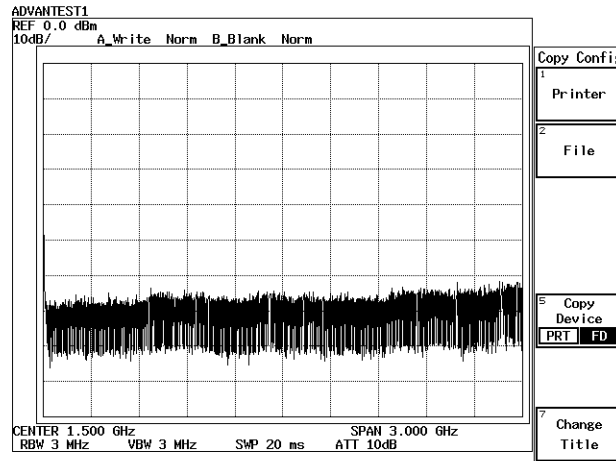

Figure 2-120 Displaying the Screen Title

**CAUTION:**

1. The dialog box closes, leaving the data you entered on the screen when you press any key other than the numeric keys, the **-(BS)** key or the unit keys.
2. A new title always overwrites the old one and is displayed in the specified area.

Deleting a title previously set

8. Use a null line (the entire line consists of spaces) as the title. A previously set title is deleted from the screen.

### 3 REFERENCE

This chapter describes the functions of all panel and soft keys.

- Menu index: Use this index as a key index to Chapter 3.
- Menu map: Shows a list of hierarchical menus on a panel key basis.
- Functional descriptions: Explains the functions of the panel and soft keys.

The panel keys are arranged in alphabetical order.

#### 3.1 Menu Index

This menu index is used to easily find the keys described in Chapter 3.

Operation Key	Pages	Operation Key	Pages
$\Delta$ MKR $\rightarrow$ CF .....	3-12, 3-53	Auto Increment .....	3-20, 3-74
$\Delta$ MKR $\rightarrow$ CF Step .....	3-12, 3-53	AUTO TUNE .....	3-8, 3-25
$\Delta$ MKR $\rightarrow$ MKR Step .....	3-12, 3-53	Auto Tune .....	3-7, 3-19
$\Delta$ MKR $\rightarrow$ Span .....	3-12, 3-53	Average CONT/SGL .....	3-10, 3-38
$\sqrt{\text{Nyquist}}$ Filter .....	3-59, 3-61	Average CONT/SGL .....	3-17, 3-78,
$\sqrt{\text{Nyquist}}$ Filter ON/OFF .....	3-14, 3-59,		3-79
	3-61	Average Loss ON/OFF .....	3-10, 3-39
$\sqrt{\text{Nyquist}}$ Filter Setup .....	3-14, 3-59,	Average Power .....	3-14, 3-58
	3-61	Average PSE/CONT .....	3-17, 3-77,
% AM Meas ON/OFF .....	3-11, 3-46		3-78
% AM Video ON/OFF .....	3-11, 3-46	Average Times .....	3-14, 3-57
10dB/div .....	3-10, 3-42	Average Times ON/OFF .....	3-11, 3-48,
10M Ref INT/EXT .....	3-8, 3-26		3-49
1dB/div .....	3-10, 3-42	AVG A(B) .....	3-17, 3-77
2dB/div .....	3-10, 3-42	AVG A(B) ON/OFF .....	3-17, 3-77
3rd Order .....	3-11, 3-49	B&W .....	3-8, 3-28
3rd Order Meas .....	3-11, 3-46	B-A $\rightarrow$ A .....	3-17, 3-79
5dB/div .....	3-10, 3-42	Band Lock ON/OFF .....	3-10, 3-39
5th Order .....	3-11, 3-49	Band Select .....	3-10, 3-38
7th Order .....	3-11, 3-49	Baud Rate .....	3-8, 3-23
9th Order .....	3-11, 3-49	BBA9106 .....	3-9, 3-34
A-B $\rightarrow$ A .....	3-17, 3-79	Blank A(B) .....	3-17, 3-77
Abort .....	3-7, 3-29	BS Window ON/OFF .....	3-14, 3-59,
ACP .....	3-14, 3-58		3-61
ACP OFF .....	3-14, 3-60	BW .....	3-7, 3-20
Active Marker .....	3-12, 3-14,	C/N Meas .....	3-11, 3-47
	3-52, 3-60	C/N Meas OFF .....	3-11, 3-48
A-DL $\rightarrow$ A .....	3-17, 3-79	CAL .....	3-7
All .....	3-18, 3-84	Cal 10MHz Ref .....	3-21
AMPTD OFS .....	3-7, 3-21	Cal All .....	3-7, 3-21
Annotation ON/OFF .....	3-8, 3-26	Cal Corr ON/OFF .....	3-7, 3-21
Ant Corr .....	3-16, 3-69	Cal Sig Level .....	3-7, 3-21
Aperture % .....	3-18, 3-83	Carrier .....	3-37
ATT AUTO/MNL .....	3-10, 3-42	Center .....	3-10, 3-36
Auto Adj .....	3-18, 3-83	CF Step AUTO/MNL .....	3-10, 3-36
Auto All .....	3-7, 3-16,	CH Power OFF .....	3-14, 3-57

3.1 Menu Index

CH Type 1 Edit.....	3-10, 3-37	Delete Line.....	3-9, 3-10, 3-13, 3-14, 3-34, 3-38, 3-39, 3-55, 3-59, 3-61
CH Type 2 Edit.....	3-10, 3-37	Delta.....	3-12, 3-50
Change Title.....	3-8, 3-16, 3-26, 3-70	Demod Cal.....	3-18, 3-84
Channel.....	3-16, 3-37, 3-70	Detector.....	3-17, 3-77
Channel Power.....	3-14, 3-57	Detector Mode.....	3-9, 3-33
Channel Setting.....	3-10, 3-36	Deviation.....	3-18, 3-83
Coarse.....	3-21	Deviation OFF.....	3-18, 3-83
Color 1.....	3-8, 3-27	Device RAM/FD.....	3-15, 3-16, 3-67, 3-70
Color 2.....	3-8, 3-27	Disp Line ON/OFF.....	3-9, 3-17, 3-31, 3-79
Color Pattern.....	3-8, 3-27	DISPLAY.....	3-9, 3-31
Compression.....	3-8, 3-25	Each Item.....	3-7, 3-21
CONFIG.....	3-8, 3-23	Edit Table.....	3-11, 3-14, 3-47, 3-62, 3-64
Cont Down ON/OFF.....	3-11, 3-45	EMC.....	3-9
Cont Peak ON/OFF.....	3-12, 3-50	EMCO3142.....	3-9, 3-34
COPY.....	3-8, 3-29	Execute Normalize.....	3-17, 3-76
Copy Config.....	3-8, 3-23	Execute Self Test.....	3-16, 3-71
Copy Device PRT/FD.....	3-8, 3-26	Exit.....	3-16, 3-71
Copy Mode.....	3-8, 3-24, 3-25	Ext.....	3-16, 3-74
Copy Table 1 to 2.....	3-13, 3-55	Ext Gate In ON/OFF.....	3-16, 3-75
Copy Table 2 to 1.....	3-13, 3-55	Ext Mixer Config.....	3-10, 3-38
Corr Mode ANT/LVL.....	3-9, 3-34	Ext Trig.....	3-17, 3-81
Corr OFF.....	3-9, 3-34	F/T.....	3-9, 3-32
COUNTER.....	3-9, 3-30	Field.....	3-9, 3-33
Counter OFF.....	3-9, 3-30	File.....	3-8, 3-25
CS/BS Setup.....	3-14, 3-58, 3-61	File Format.....	3-8, 3-25
Data Length.....	3-8, 3-23	File No.....	3-8, 3-25
Date/Time.....	3-8, 3-27	Fine.....	3-22
Day.....	3-8, 3-27	Fixed MKR ON/OFF.....	3-12, 3-51
dB/div.....	3-10, 3-42	Flow Control.....	3-8, 3-23
dBc/Hz.....	3-11, 3-45	FM Demod.....	3-18, 3-83
dBm.....	3-10, 3-42	FM Demod OFF.....	3-18, 3-84
dBm/Hz.....	3-11, 3-45	FM Meas.....	3-11, 3-46
dBmV.....	3-10, 3-42	FM Meas OFF.....	3-11, 3-47
dB $\mu$ V.....	3-10, 3-42	Format.....	3-8, 3-27
dB $\mu$ V/ $\sqrt$ Hz.....	3-11, 3-45	Format FD.....	3-8, 3-26
Default.....	3-14, 3-22, 3-57, 3-58, 3-60, 3-62	Free Run.....	3-17, 3-81
Default Config.....	3-8, 3-28, 3-89	FREQ.....	3-10, 3-36
Define $\rightarrow$ Default.....	3-14, 3-57, 3-58, 3-60, 3-62	Freq Adj Auto.....	3-17, 3-76
Delete.....	3-11, 3-14, 3-15, 3-16, 3-47, 3-63, 3-64, 3-70	Freq Adj Manual.....	3-17, 3-76
		Freq Corr ON/OFF.....	3-7, 3-21
		Freq Offset ON/OFF.....	3-10, 3-36
		Frequency Input.....	3-10, 3-36
		Full Span.....	3-16, 3-73

Gate Position .....	3-16, 3-75	3-58, 3-60,
Gate Setup Quit .....	3-16, 3-75	3-62
Gate Source .....	3-16, 3-74	Manual Tune .....
Gate Width .....	3-16, 3-75	3-10, 3-38
Gated Sweep .....	3-16, 3-74	Marker Couple ON/OFF .....
Gated Sweep ON/OFF .....	3-16, 3-75	3-9, 3-31
GPIB .....	3-8, 3-23	Marker No. ....
GPIB Address .....	3-8	3-12, 3-14,
Graph .....	3-14, 3-60	3-51, 3-60
Graph OFF .....	3-14, 3-60	Marker OFF .....
Gray .....	3-8, 3-28	3-12, 3-14,
Hi Sens (IM Meas) ON/OFF .....	3-11, 3-49	3-51, 3-52,
Hi Sens ON/OFF .....	3-10, 3-42	3-60
HOLD .....	3-10	Marker ON .....
Hour .....	3-8, 3-27	3-12, 3-14,
IF Step Amp .....	3-7, 3-21	3-51, 3-60
IM Meas .....	3-11, 3-49	Marker Pause Time .....
IM Meas OFF .....	3-11, 3-49	3-9, 3-11,
Image Suppress ON/OFF .....	3-10, 3-39	3-34, 3-47
Input 50Ω/75Ω .....	3-10, 3-43	Math A .....
Input Type .....	3-10, 3-36	3-17, 3-79
Insert .....	3-11, 3-14,	Max Hold A(B) .....
	3-15, 3-47,	3-17, 3-77
	3-63, 3-64	MEAS .....
Insert Line .....	3-9, 3-10,	3-11, 3-45
	3-13, 3-14,	Measuring Window .....
	3-34, 3-37,	3-9, 3-31
	3-39, 3-55,	Menu Print .....
	3-59, 3-61	3-8, 3-24
Inverse .....	3-8, 3-28	Min Hold A(B) .....
Last Span .....	3-16, 3-73	3-17, 3-79
LEVEL .....	3-10, 3-42	Min Peak .....
Limit Line .....	3-16, 3-70	3-12, 3-50
Limit Line 1/2 .....	3-13, 3-55	Minute .....
Limit Line Edit .....	3-13, 3-55	3-8, 3-27
Limit Setup .....	3-11, 3-49	Mixer INT/EXT .....
Lin Setup Quit .....	3-18, 3-83	3-10, 3-38
Line .....	3-17, 3-81	MKR .....
Line1 ON/OFF .....	3-13, 3-54	3-12, 3-50
Line2 ON/OFF .....	3-13, 3-54	MKR List ON/OFF .....
Linear .....	3-10, 3-42	3-12, 3-52
Linearity .....	3-18, 3-83	MKR Read DLT/LFT/RHT .....
Linearity ON/OFF .....	3-18, 3-83,	3-11, 3-45
	3-84	MKR Step AUTO/MNL .....
List ON/OFF .....	3-15, 3-67	3-12, 3-51
LOCAL .....	3-10, 3-44	MKR Trace A/B .....
Log Linear .....	3-7, 3-21	3-12, 3-51
Loss:Freq .....	3-16, 3-70	MKR → .....
Loss:Freq Edit .....	3-10, 3-39	3-12, 3-53
Loss:Freq ON/OFF .....	3-10, 3-39	MKR → CF .....
Manual .....	3-14, 3-57,	3-12, 3-53
		MKR → CF Step .....
		3-12, 3-53
		MKR → MKR Step .....
		3-12, 3-53
		MKR → Ref .....
		3-12, 3-53
		Mod Freq → SWP T ON/OFF .....
		3-11, 3-46
		Month .....
		3-8, 3-27
		Multi Marker .....
		3-12, 3-51
		Multi MKR OFF .....
		3-12, 3-52
		Multi MKR Setup .....
		3-12, 3-51
		Multi Screen .....
		3-9, 3-31
		Nega .....
		3-17, 3-77
		Next Peak .....
		3-12, 3-50
		Next Peak Left .....
		3-12, 3-50
		Next Peak Max-Min .....
		3-12, 3-50
		Next Peak Right .....
		3-12, 3-50
		Next Result .....
		3-14, 3-15,
		3-63, 3-64
		Noise/Hz .....
		3-11, 3-45
		Noise/Hz OFF .....
		3-11, 3-45
		Norm Corr .....
		3-16, 3-69
		Norm Corr ON/OFF .....
		3-17, 3-76
		Normal .....
		3-9, 3-12,
		3-17, 3-33,

3.1 Menu Index

OBW .....	3-14, 3-58	RBW 9kHz.....	3-9, 3-33
OBW OFF.....	3-14, 3-58	RBW Auto .....	3-9, 3-33
OBW%.....	3-14, 3-58	RBW AUTO/MNL .....	3-7, 3-20
Offset Adj .....	3-18, 3-83	RBW Switch .....	3-7, 3-21
Order .....	3-8, 3-11, 3-27, 3-49	RECALL.....	3-15, 3-67
Paper Feed.....	3-8, 3-25	Recall .....	3-15, 3-67
Parameter Setup .....	3-14, 3-57, 3-58, 3-60, 3-62	Ref Level.....	3-10, 3-42
Parity Bit.....	3-8, 3-23	Ref Line .....	3-17, 3-76
PAS/FAIL.....	3-13, 3-54	Ref Line ON/OFF .....	3-9, 3-31
PASS Judge UP/LOW .....	3-14, 3-63, 3-65	Ref Offset ON/OFF .....	3-10, 3-43
Pass/Fail Judgement ON/OFF .....	3-49	Rename .....	3-16, 3-70
Pass/Fail ON/OFF.....	3-13, 3-54	REPEAT .....	3-15, 3-68
PBW.....	3-7, 3-21	Res 100Hz.....	3-9, 3-30
Peak.....	3-9, 3-33	Res 10Hz.....	3-9, 3-30
Peak Delta Y .....	3-11, 3-12, 3-18, 3-47, 3-50, 3-83	Res 1Hz.....	3-9, 3-30
Peak List Freq .....	3-12, 3-52	Res 1kHz.....	3-9, 3-30
Peak List Level .....	3-12, 3-52	Reset Marker.....	3-12, 3-14, 3-52, 3-60
Peak Menu .....	3-12, 3-50	Results REL/ABS .....	3-14, 3-61
Peak Zoom .....	3-16, 3-73	Revision .....	3-8, 3-28
Peak → CF.....	3-12, 3-53	Rolloff Factor.....	3-14, 3-59, 3-61
Peak → Ref.....	3-12, 3-53	RS232.....	3-8, 3-23
Phase Jitter .....	3-11, 3-48	Sample .....	3-17, 3-77
Phase Jitter OFF.....	3-11, 3-48	Sample Points .....	3-18, 3-83
Phase Noise.....	3-11, 3-47	SAVE.....	3-16
PK SRCH.....	3-13, 3-56	Save.....	3-16, 3-69
Points 1001/501 .....	3-8, 3-26	Save Item .....	3-16, 3-69
Posi.....	3-17, 3-77	Screen A/B.....	3-9, 3-16, 3-18, 3-32, 3-75, 3-83
Power AVG A(B) .....	3-17, 3-78	Screen FULL/SEPA/CARRIER .....	3-14, 3-59
Power AVG A(B) ON/OFF .....	3-17, 3-78	Screen Reset.....	3-9, 3-32
Power Meas OFF .....	3-14, 3-58	Search ALL/UP/LOW .....	3-12, 3-50
POWER MEASURE .....	3-14, 3-57	Self Test.....	3-16
Presel.....	3-10, 3-38	Sens Range.....	3-18, 3-83
PRESET .....	3-15	Sensitivity .....	3-18, 3-83
Prev Result.....	3-14, 3-15, 3-63, 3-64	Sensitivity OFF.....	3-18, 3-83
Printer.....	3-8, 3-23	Setup .....	3-16, 3-69
Printer Command.....	3-8, 3-24	SHIFT .....	3-10, 3-41
Protect .....	3-16, 3-70	Shift X/Y .....	3-13, 3-55
QP .....	3-9, 3-33	SHIFT, 0(Self Test) .....	3-16, 3-71
Range .....	3-18, 3-83	SHIFT, 1(EMC).....	3-9, 3-33
Range Only .....	3-18, 3-84	SHIFT, 7(CAL).....	3-7, 3-21
RBW 120kHz.....	3-9, 3-33	SHIFT, CONFIG(PRESET) .....	3-15, 3-66, 3-85
RBW 1MHz .....	3-9, 3-33	SHIFT, COPY, Abort .....	3-7, 3-29
RBW 200Hz.....	3-9, 3-33	SHIFT, RECALL(SAVE).....	3-16, 3-69
		Show Result .....	3-14, 3-63, 3-64
		Sig Track ON/OFF.....	3-11, 3-12,

	3-47, 3-48, 3-51		3-14, 3-15, 3-34, 3-38, 3-39, 3-47, 3-55, 3-59, 3-61, 3-63, 3-64
Signal Ident ON/OFF .....	3-10, 3-39		
SINGLE .....	3-16, 3-72		
Single Measure ON/OFF .....	3-14, 3-17, 3-65, 3-78, 3-79	Table No. 1/2/3 .....	3-14, 3-15, 3-62, 3-64
Slope (TV Polarity) +/- .....	3-16, 3-17, 3-74, 3-81	TG .....	3-17, 3-76
Slope +/- .....	3-17, 3-81	TG Level .....	3-17, 3-76
Slope Adj .....	3-18, 3-83	TG OFF .....	3-17, 3-76
Sort .....	3-9, 3-10, 3-13, 3-14, 3-34, 3-38, 3-39, 3-55, 3-59, 3-61	Total Gain .....	3-7, 3-21
Sound .....	3-9, 3-11, 3-34, 3-47	Total Power .....	3-14, 3-57
Sound AM/FM .....	3-9, 3-11, 3-34, 3-47	TR1722 .....	3-9, 3-33
Sound OFF .....	3-11, 3-35, 3-47	TRACE .....	3-17, 3-77
SPAN .....	3-16, 3-73	Trace .....	3-16, 3-69
Spectrum Mask .....	3-14, 3-60	Trace Level .....	3-16, 3-70
Spectrum Mask OFF .....	3-14, 3-62	Trc Menu A/B .....	3-17, 3-77, 3-80
Spurious .....	3-16, 3-70	TRIG .....	3-17, 3-81
Spurious Freq .....	3-14, 3-62	Trig Delay .....	3-16, 3-17, 3-74, 3-81
Spurious Freq OFF .....	3-14, 3-63	Trig Source .....	3-17, 3-81
Spurious Time .....	3-14, 3-64	TV Sys NTSC/PAL&SECAM .....	3-17, 3-82
Spurious Time OFF .....	3-14, 3-65	TV-H .....	3-16, 3-17, 3-74, 3-81
Squelch ON/OFF .....	3-9, 3-11, 3-34, 3-47	TV-V .....	3-16, 3-17, 3-74, 3-81
Start .....	3-10, 3-36	UHALP9107 .....	3-9, 3-33
Start CH Shift .....	3-10, 3-37	Units .....	3-10, 3-42
Start Offset .....	3-11, 3-48	User ANT Corr .....	3-9, 3-34
Stop .....	3-10, 3-36	VBW AUTO/MNL .....	3-7, 3-20
Stop Bit .....	3-8, 3-23	Video Trig .....	3-17, 3-81
Stop CH Shift .....	3-10, 3-37	View A(B) .....	3-17, 3-77
Stop Offset .....	3-11, 3-48	Volts .....	3-10, 3-42
Store .....	3-22	Volume .....	3-9, 3-11, 3-34, 3-47
Store A(B) to B(A) .....	3-17, 3-79	Watts .....	3-10, 3-42
SWEEP .....	3-16, 3-74	Wide RBW ON/OFF .....	3-7, 3-20
Sweep Count ON/OFF .....	3-14, 3-63, 3-64	Window ON/OFF .....	3-9, 3-31
SWP Time AUTO/MNL .....	3-16, 3-74	Window Position .....	3-9, 3-14, 3-31, 3-57
Symbol Rate 1/T .....	3-14, 3-59, 3-61	Window Sweep ON/OFF .....	3-9, 3-31
T/T .....	3-9, 3-32	Window Width .....	3-9, 3-14, 3-31, 3-57
Table 1 to 3 .....	3-37	Write A(B) .....	3-17, 3-77
Table Init .....	3-9, 3-10, 3-11, 3-13,	X ABS/LFT/CTR .....	3-13, 3-54
		XdB Down .....	3-11, 3-45
		XdB Left .....	3-11, 3-45
		XdB Right .....	3-11, 3-45
		Y ABS/CTR .....	3-13, 3-54

3.1 Menu Index

Y ABS/TOP/BOT .....	3-13, 3-54
Year.....	3-8, 3-27
Zero Span .....	3-16, 3-73
Zoom.....	3-9, 3-32
Zoom Position.....	3-9, 3-32
Zoom Width .....	3-9, 3-32



### 3.2 Menu Map

Abort (SHIFT, COPY)

Abort

AUTO  
TUNE

[ ]

BW

RBW AUTO/MNL  
VBW AUTO/MNL  
Wide RBW ON/OFF  
Auto All

CAL (SHIFT, CAL 7)

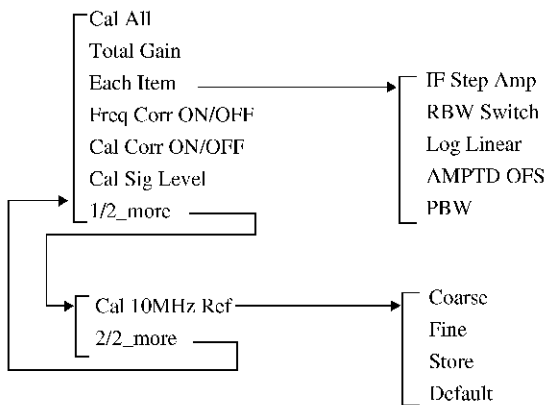

3.2 Menu Map

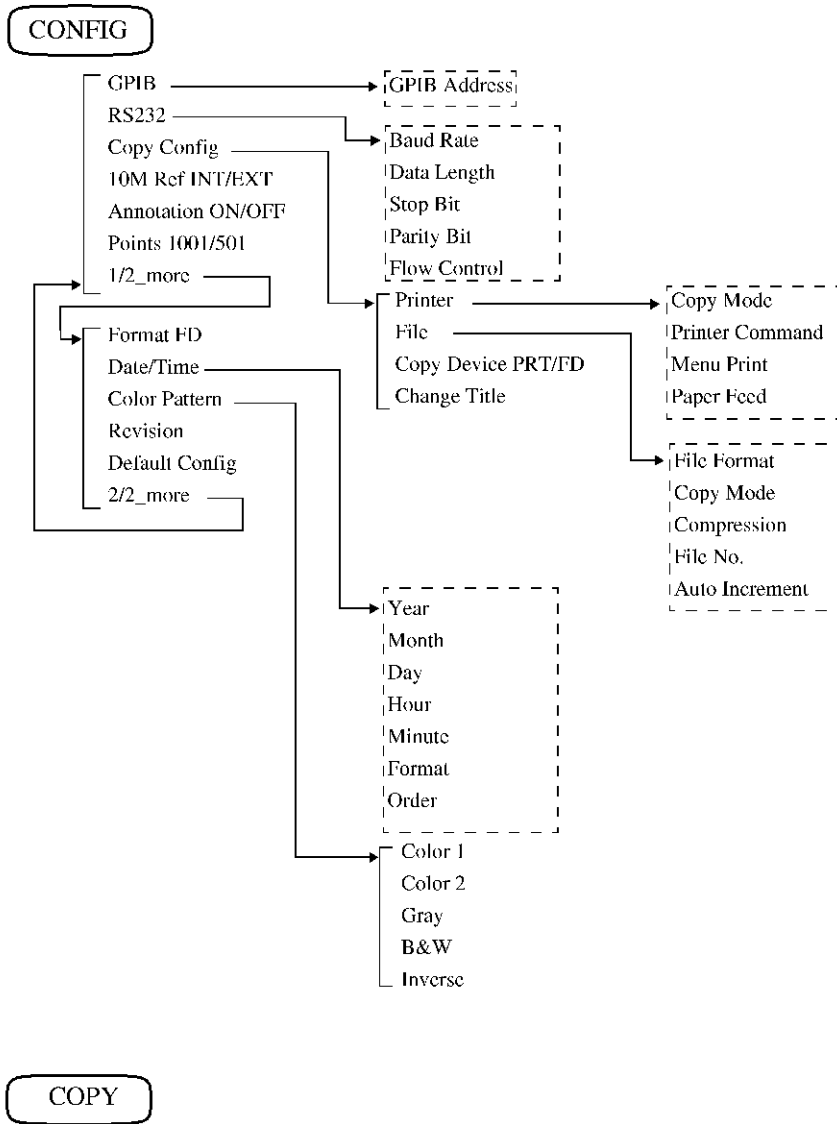

COUNTER

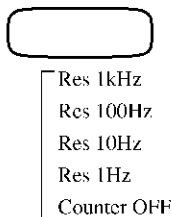

DISPLAY

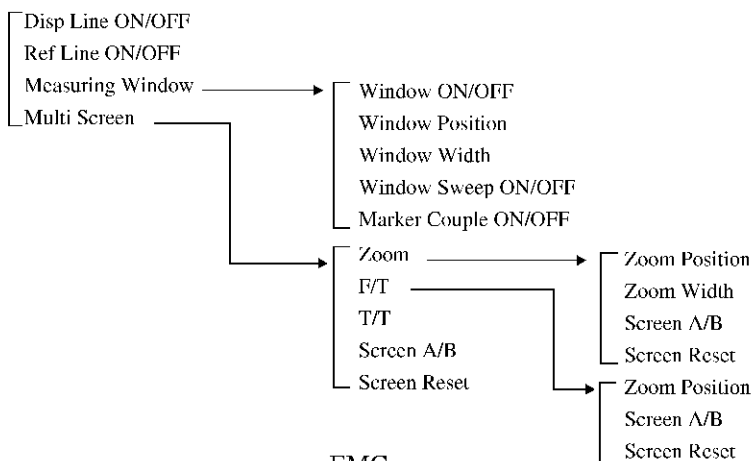

EMC ( SHIFT , 1 )

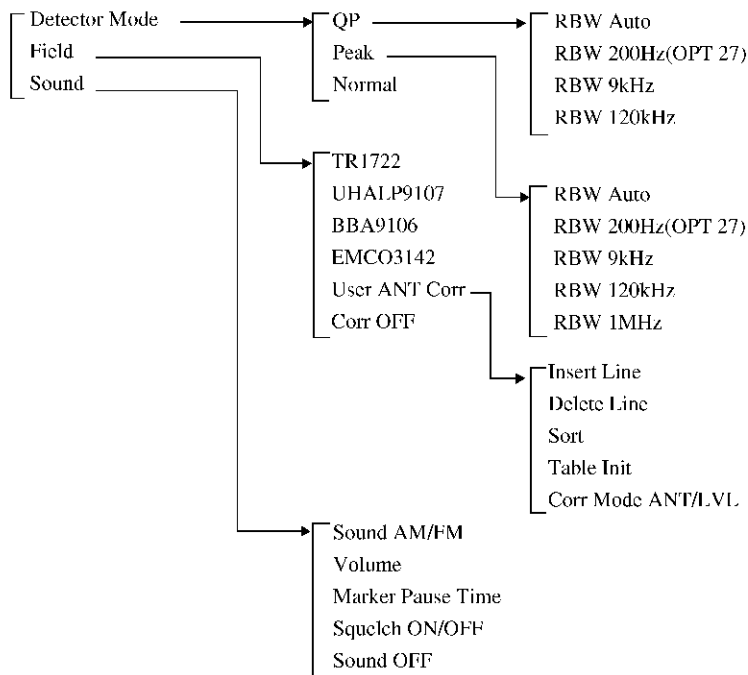

3.2 Menu Map

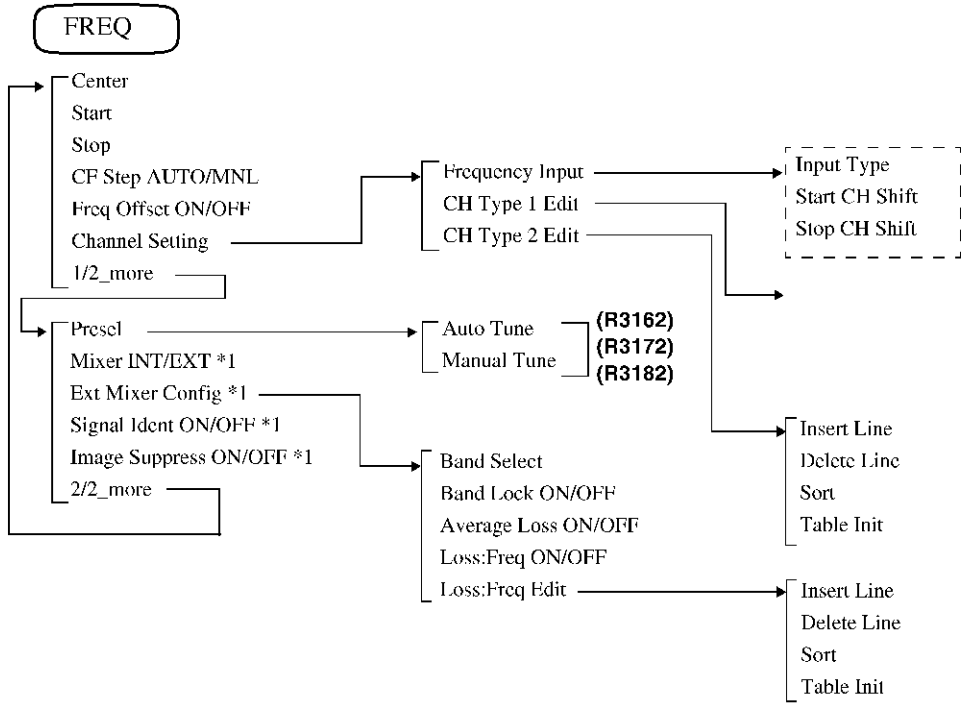

\*1: Compatible with OPT16 thru OPT19 only

HOLD ( SHIFT )

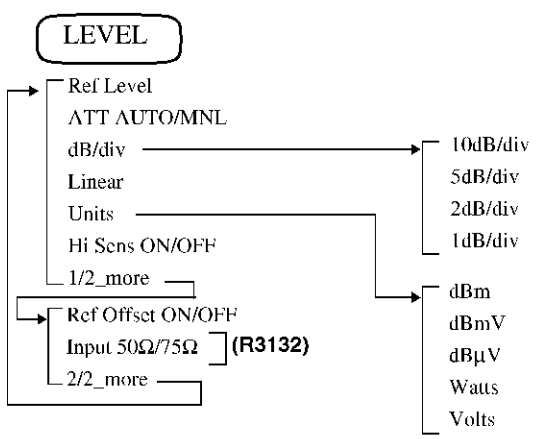

LOCAL

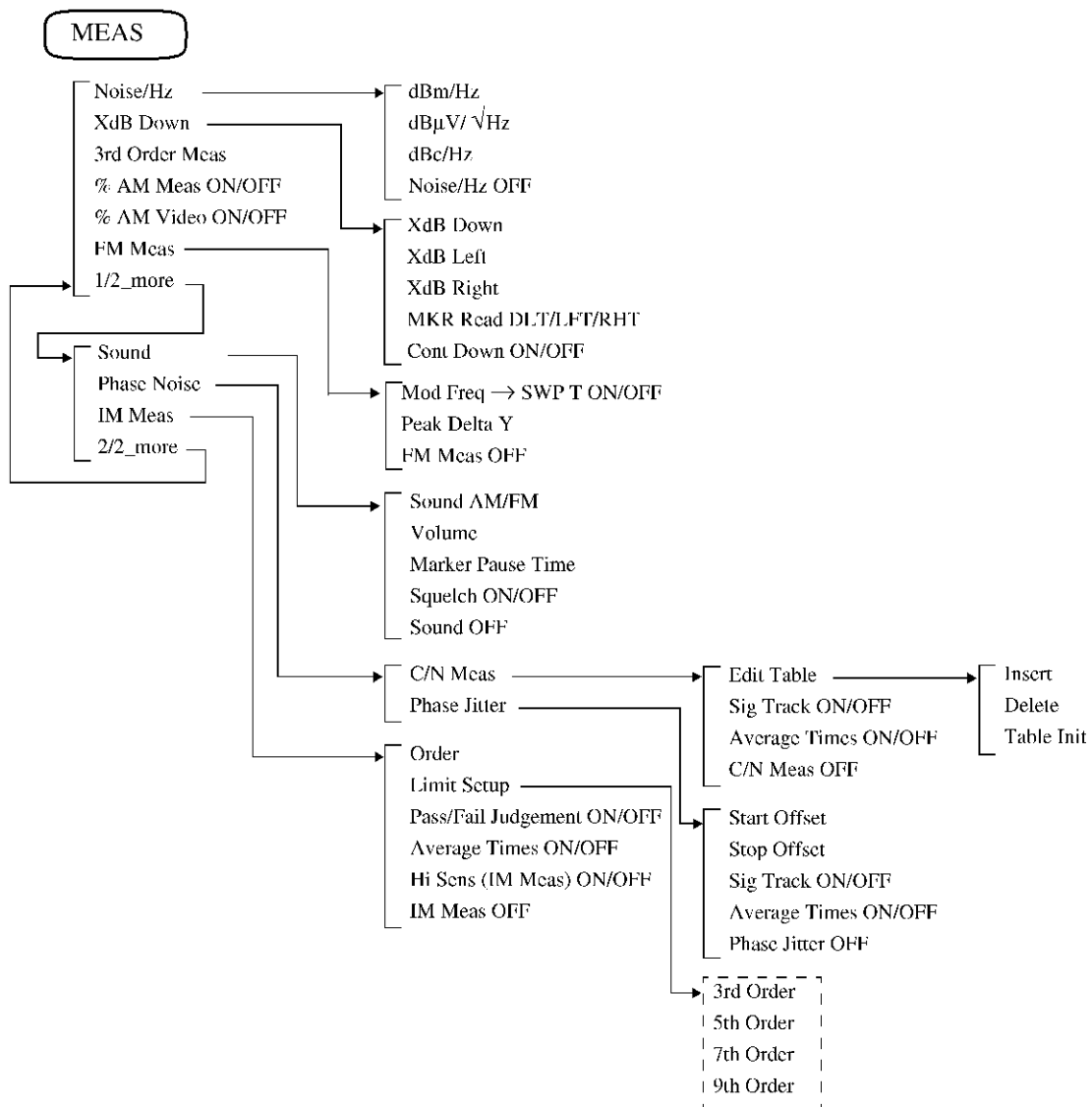

3.2 Menu Map

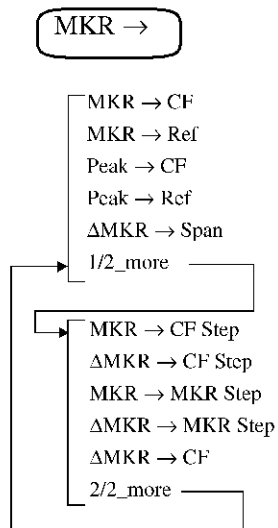
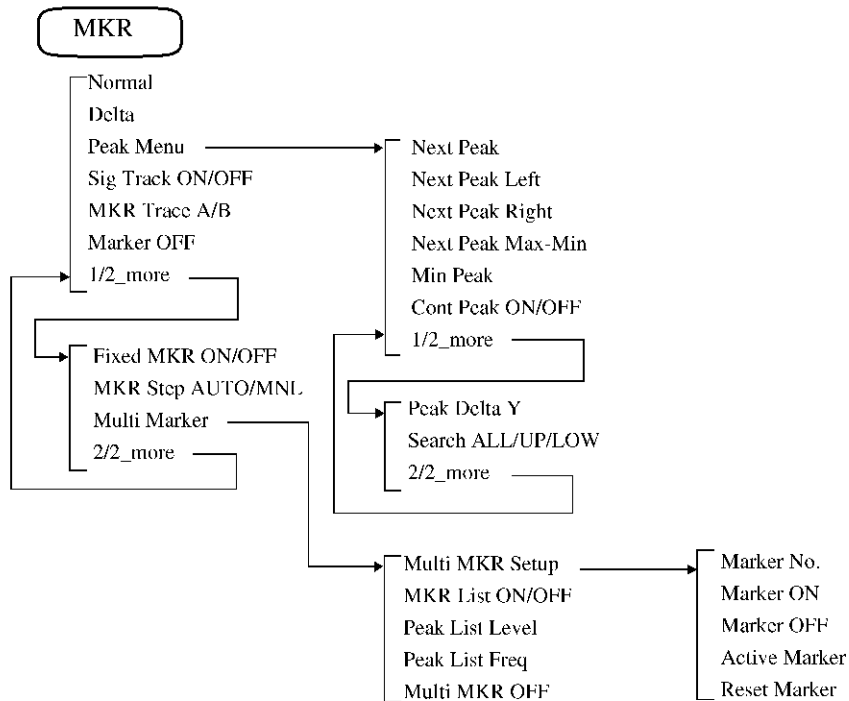

PAS/FAIL

- Pass/Fail ON/OFF
- Line1 ON/OFF
- Line2 ON/OFF
- X ABS/LFT/CTR
- Y ABS/TOP/BOT
- (Y ABS/CTR: When OPT73, FM Demodulation function, is turned on.)
- Shift X/Y
- Limit Line Edit

- Limit Line 1/2
- Insert Line
- Delete Line
- Sort
- Table Init
- Copy Table 1 to 2
- Copy Table 2 to 1

PK SRCH

3.2 Menu Map

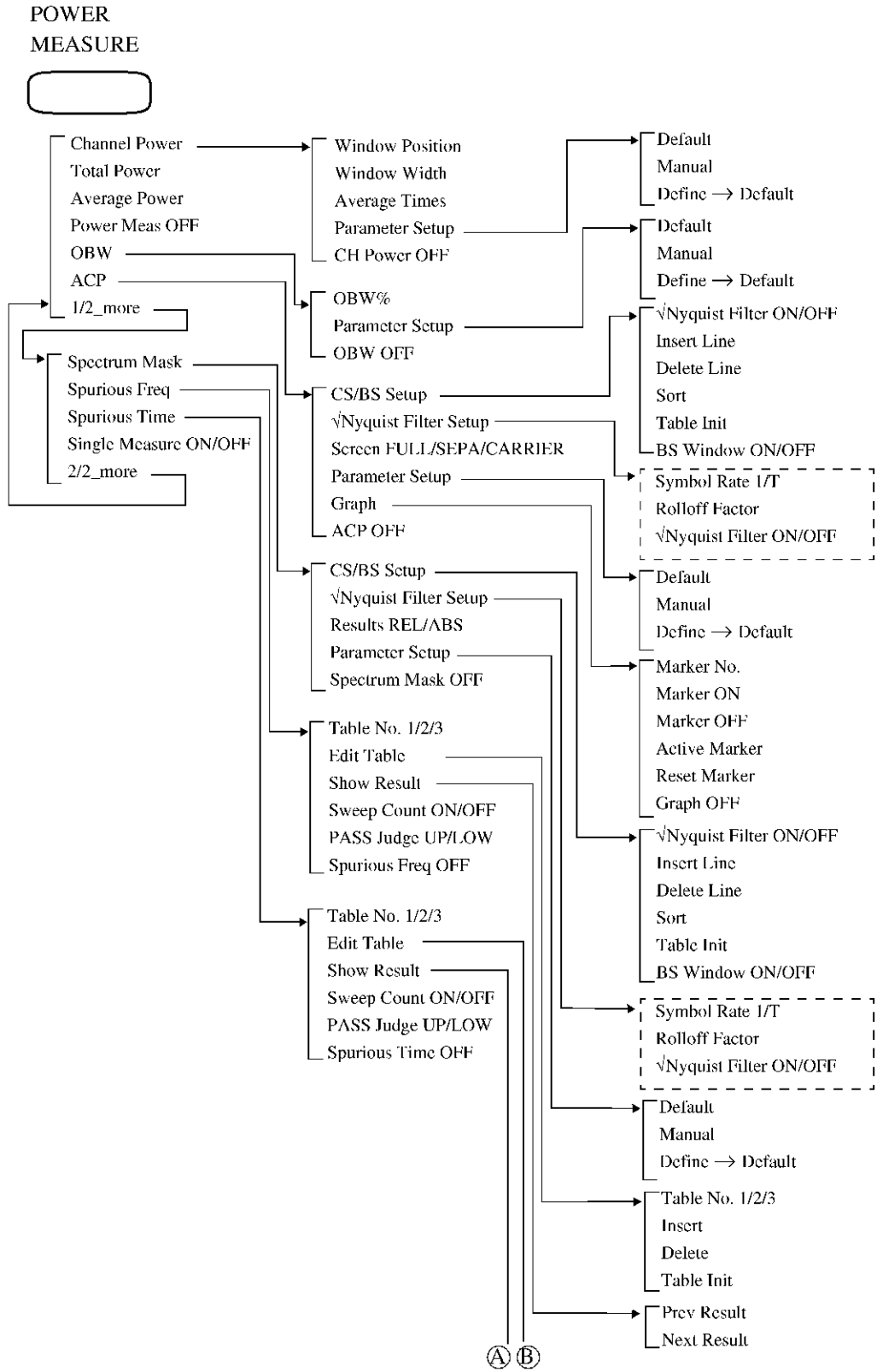



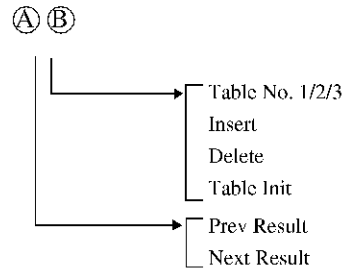

PRESET ( SHIFT , PRESET CONFIG )

RECALL

- Recall
- List ON/OFF
- Device RAM/FD

REPEAT

3.2 Menu Map

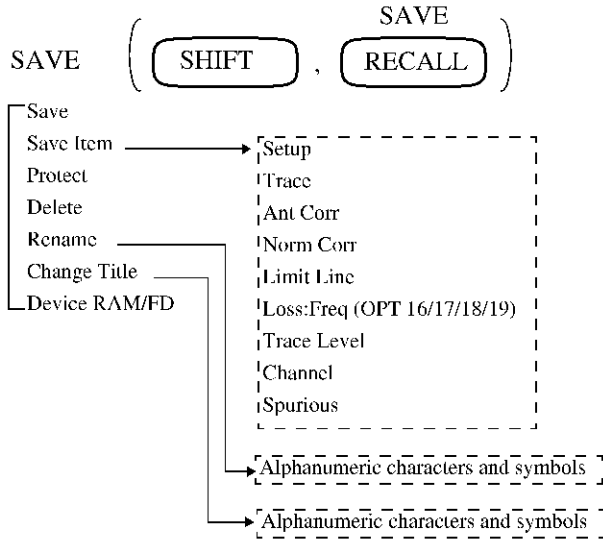

- Execute Self Test
- Exit

SINGLE

SPAN

- Full Span
- Zero Span
- Peak Zoom
- Last Span

SWEEP

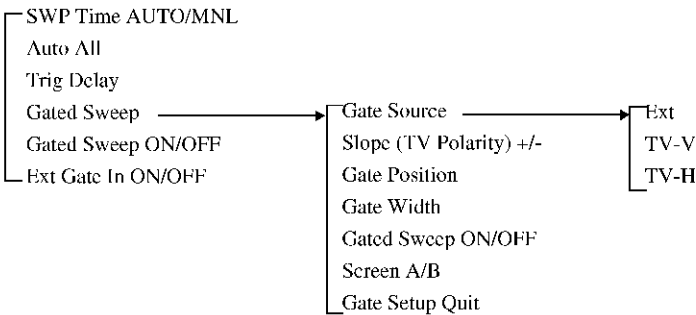

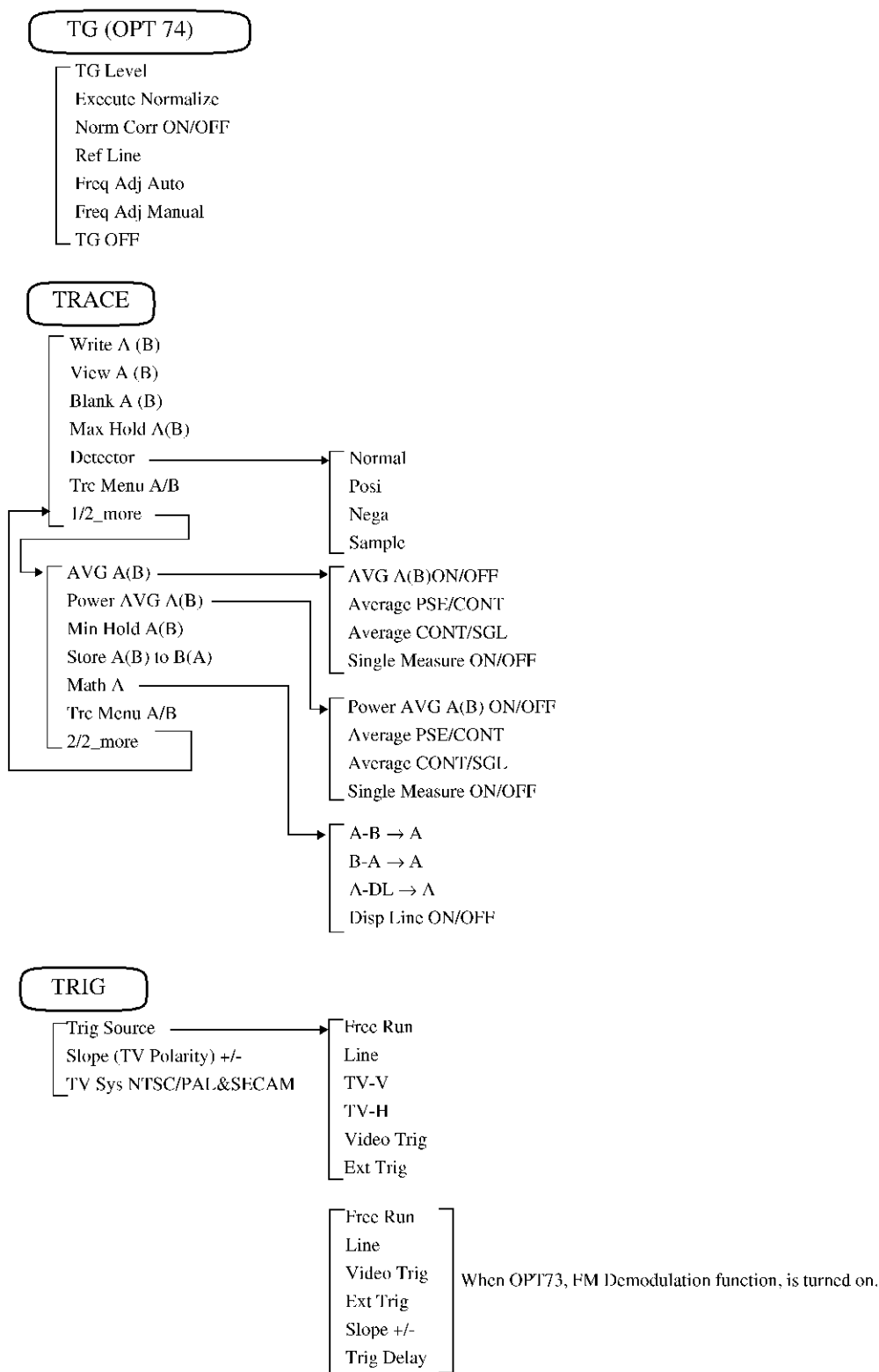

3.2 Menu Map

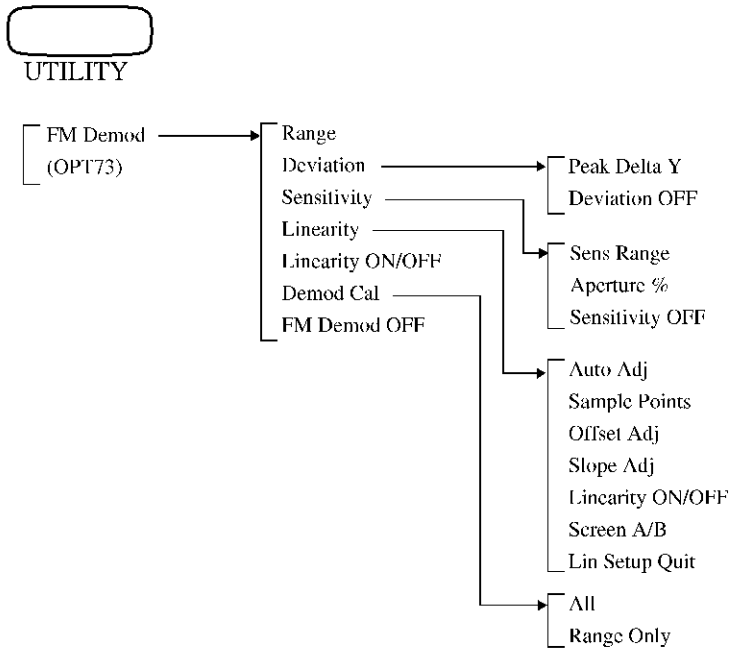

### 3.3 Menu Function Descriptions

This section describes all panel keys and any associated menus displayed when they are pressed.

#### 3.3.1 AUTO TUNE Key (Auto Tuning)

When pressing the **AUTO TUNE** key, the frequency span is automatically changed to the full span to detect the maximum signal level and changed back to the last span.

Then, the reference level is changed to the detected maximum level.

(Note there is no menu associated with this panel key.)

---

**NOTE:** *To terminate the tuning, press any keys other than the COPY, LOCAL, SINGLE and REPEAT keys.*

---

### 3.3.2 BW Key (Bandwidth)

#### 3.3.2 BW Key (Bandwidth)

Pressing the **BW** key displays the BW menu that allows you to select resolution bandwidth (RBW) and video bandwidth (VBW) parameters.

For example, when MNL is selected for the resolution bandwidth, the resolution bandwidth can be specified.

##### ***RBW AUTO/MNL***

Toggles the video bandwidth between AUTO and MNL.

**AUTO:** Automatically sets an optimum resolution bandwidth according to the span settings.

**MNL:** Allows you to set the resolution bandwidth manually.

##### ***VBW AUTO/MNL***

Toggles the video bandwidth between AUTO and MNL.

**AUTO:** Automatically sets an optimum video bandwidth according to the resolution bandwidth setting.

**MNL:** Allows you to set the video bandwidth manually.

##### ***Wide RBW ON/OFF***

Toggles the wide band RBW setting function on or off. The setting is effective only in the zero span mode.

**ON:** Sets RBW 10 MHz and VBW OFF.

**OFF:** Turns the wide band RBW setting function off to restore RBW and VBW to the original settings.

##### ***Auto All***

Automatically sets the resolution bandwidth, the video bandwidth and the sweep time according to the span settings.

### 3.3.3 CAL Key (Calibration)

This section describes the menu displayed when the **SHIFT** key and the **7 (CAL)** key are pressed.

<i>Cal All</i>	Executes all calibration routines.
<hr/> <p><b>CAUTION:</b> <i>Do not perform a PRESET operation (SHIFT, PRESET) while calibrating the spectrum analyzer because this will erase all calibration data.</i></p> <hr/>	
<i>Total Gain</i>	Measures the absolute error using a resolution bandwidth of 300 kHz, and the calibration signal output of both -15dBm and 1dB/DIV.
<i>Each Item</i>	Changes the display to the Each Item menu.
<i>IF Step Amp</i>	Measures the IF Step AMP switching error and calibrates it.
<i>RBW Switch</i>	Measures the switching error for the IF Filter resolution bandwidth and calibrates it.
<i>Log Linear</i>	Measures the linearity of the ordinate axis at a range of 10 dB/DIV to 1 dB/DIV on the LOG scale and calibrates it.
<i>AMPTD OFS</i>	Calibrates the level offset in the LOG scale.
<i>PBW</i>	Measures PBW (noise power bandwidth) at a resolution bandwidth range of 1 kHz to 3 MHz and calibrates it. (The resolution bandwidth is 30 Hz or more when the narrow-band RBW option is installed.)
<i>Freq Corr ON/OFF</i>	Toggles the frequency correction function on or off.  ON: Frequency characteristics are corrected. OFF: Turns the frequency correction function off.
<i>Cal Corr ON/OFF</i>	Toggles the calibration factor on or off.  ON: The calibration factor is used. OFF: The calibration factor is not used.
<i>Cal Sig Level</i>	Sets the output level of calibration signals.
<i>1/2_more</i>	Displays the Cal menu (2/2).
<i>Cal 10MHz Ref</i>	Displays the Cal Ref menu.
<i>Coarse</i>	Enters the compensation value for the 10 MHz reference coarse adjustment.

### 3.3.3 CAL Key (Calibration)

<i>Fine</i>	Enters the compensation value for the 10 MHz reference fine adjustment.
<i>Store</i>	Saves the frequency compensation data based on the 10 MHz reference.
<i>Default</i>	Restores the compensation values for the coarse and fine adjustments to the factory defaults.
<i>2/2_more</i>	Displays the Cal menu (1/2).



### 3.3.4 CONFIG Key (Configuration)

This section describes the Config menu(1/2) displayed when the **CONFIG** key is pressed.

Pressing this key allows you to set a GPIB interface.

**GPIB** Sets the GPIB address for the analyzer.

**RS232** Displays the RS232 dialog box.

RS232						
Baud Rate :	600	1200	2400	4800	9600	19200
Data Length :	7	8				
Stop Bit :	1	2				
Parity Bit :	NONE	ODD	EVEN			
Flow Control :	NONE	XON/XOFF				

**Baud Rate** Sets the transmission rate to 600, 1200, 2400, 4800, 9600 or 19200 bps.

**Data Length** Sets the data bit length to 7 or 8 bits.

**Stop Bit** Sets the stop bit to either 1 or 2.

**Parity Bit** Sets the parity bit type.

NONE: Does not perform parity checking.

ODD: Sets the parity bit type to odd.

EVEN: Sets the parity bit type to even.

**Flow Control** Turns the flow control function on.

NONE: No flow control is performed.

XON/XOFF:

Flow control is performed according to the XON or XOFF code sent.

**Copy Config** Displays the Copy Config menu used to set the destination of screen data output.

**Printer** Displays the Printer dialog box.

3.3.4 CONFIG Key (Configuration)

Printer			
Copy Mode :	Color	S-Color S	S-Color L
	Gray	Mono S	Mono L
Printer Command :	ESC/P	PCL	ESC/P-R
Menu Print :	ON	OFF	
Paper Feed :	ON	OFF	

**Copy Mode**

Sets the output mode.

**Color:** Prints the screen data in size L and the actual screen color.

**S-Color S:**  
Changes the screen data into a simple color image and prints it in size S.

**S-Color L:**  
Changes the screen data into a simple color image and prints it in size L.

**Gray:** Prints the screen data in size L and in a four-level gray scale.

**Mono S:** Sets the printer output mode to monochrome for S size.

**Mono L:** Sets the printer output mode to monochrome for L size. L size is approximately the width of the paper used for the analyzer in landscape orientation. S size is approximately the width of the paper used for the analyzer in portrait orientation.

**Printer Command** Selects the printer type.

**ESC/P:** Allows you to use an ESC/P printer.

**HP PCL:** Allows you to use a HP PCL printer.

**ESC/P-R:** Allows you to use an ESC/P Raster printer.

---

**NOTE:** *Color, S-Color S and S-Color L in the Copy Mode menu are available when HP PCL or ESC/P Raster is selected.*

---

**Menu Print**

Sets whether or not the menu labels are printed.

**ON:** The menu is included in the printout.

**OFF:** The menu is not included in the printout.

**Paper Feed** Sets whether or not a sheet of paper is fed after a hard copy is output. This function can be set when Copy Mode is set to S-Color S or Mono S.

ON: Feeds a sheet of paper after the hard copy is output.

OFF: Does not feed a sheet of paper after the hard copy is output. Multiple screen data can be printed on an A4-size sheet of paper.

### **File**

Displays the File dialog box.

File	
File Format :	<input checked="" type="checkbox"/> BMP
Copy Mode :	<input type="checkbox"/> Color <input checked="" type="checkbox"/> S-Color <input type="checkbox"/> Gray <input type="checkbox"/> Mono
Compression :	<input type="checkbox"/> OFF <input checked="" type="checkbox"/> ON
File No. :	<input type="text" value="001"/> Filename: \IMG\ADV001.BMP
Auto Increment :	<input type="checkbox"/> OFF <input checked="" type="checkbox"/> ON

**File Format** Sets the file in the BMP (bitmap) format.

**Copy Mode** Sets the color depth for the file.

Color: Files are saved in 256 colors.

S-Color: Files are saved in simple color.

Gray: Files are saved in gray scale (4 shades of gray).

Mono: Files are saved in monochrome (black and white).

**Compression** Toggles the image compression mode (compliant with RLE format under MS-Windows) on or off. This mode is enabled to be set when Copy mode is set to Color, S-Color or Gray.

ON: Compresses the image when saved.

OFF: Images are saved without image compression.

**File No.** Allows you to change the image file number used in the file name.

**Auto Increment** Toggles the Auto Increment for file number on or off.

ON: The file number is incremented every time an image data is saved.

OFF: The file number specified by the file number field is used.

3.3.4 CONFIG Key (Configuration)

<b><i>Copy Device PRT/FD</i></b>	Switches between PRT (printer) and FD (floppy disk) for the Copy Device.  PRT: Sets the destination to printer.  FD: Selects floppy disk.
<b><i>Change Title</i></b>	Changes the title previously entered.
<b><i>10M Ref INT/EXT</i></b>	Switches between internal signals (INT) and external signals (EXT) for 10 MHz reference frequency output.  INT: Internal signals are used. EXT: Use the 10 MHz REF IN terminal as the external input signal source.
<hr/> <b><i>CAUTION:</i></b> <ol style="list-style-type: none"><li><i>EXT is automatically displayed when the external signal is detected.</i></li><li><i>When the external signal is not detected, EXT is automatically changed to INT.</i></li></ol> <hr/>	
<b><i>Annotation ON/OFF</i></b>	Toggles the annotation (comment characters) display function on or off.  ON: Displays annotations.  OFF: Erases annotations.
<b><i>Points 1001/501</i></b>	Switches between 1001 and 501 for horizontal axis trace points. 1001: Sets trace points to 1001 points.  501: Sets trace points to 501 points.
<b><i>1/2_more</i></b>	Displays the Config menu (2/2).
<b><i>Format FD</i></b>	Formats a floppy disk.

***Date/Time***

Displays the Date/Time dialog box.

Date/Time		
<b>Year</b> :	<input type="text" value="2000"/>	
<b>Month</b> :	<input type="text" value="04"/>	
<b>Day</b> :	<input type="text" value="07"/>	
<b>Hour</b> :	<input type="text" value="16"/>	
<b>Minute</b> :	<input type="text" value="09"/>	
<b>Format</b> :	<input checked="" type="button" value="LONG"/>	<input type="button" value="SHORT"/>
	<input type="button" value="OFF"/>	
<b>Order</b> :	<input checked="" type="button" value="YMD"/>	<input type="button" value="MDY"/>
	<input type="button" value="DMY"/>	

***Year***

Allows you to set the year.

***Month***

Allows you to set the month.

***Day***

Allows you to set the day.

***Hour***

Allows you to set the hour.

***Minute***

Allows you to set the minutes.

***Format***

Selects the date indication mode.

LONG: Displays the date and time.

SHORT: Displays the date only.

OFF: Does not display the date and time.

***Order***

Selects the format of the date indication.

Year/Month/Day:

Displays in the order of a day of the week, year, month and day.

Month/Day/Year:

Displays in the order of a day of the week, month, day and year.

Day/Month/Year:

Displays in the order of a day of the week, day, month and year.

***Color Pattern***

Displays the Color menu used to set display condition.

***Color 1***

Sets the color display (256 colors) to pattern 1.

***Color 2***

Sets the color display (256 colors) to pattern 2.

3.3.4 CONFIG Key (Configuration)

<i>Gray</i>	Sets the screen display to gray scale (16 levels).
<i>B&amp;W</i>	Sets the screen display to monochrome display.
<i>Inverse</i>	Inverts the background colors of the screen display between black and white. This is effective for the Gray or B&W setting only.
<i>Revision</i>	Displays the software version number and all options installed in your spectrum analyzer.
<i>Default Config</i>	Resets all spectrum analyzer settings to the factory defaults (refer to Table 3-5).
<i>2/2_more</i>	Displays the Config menu (1/2).

### 3.3.5 COPY Key (Hard Copy)

Sends the screen data to the destination selected by the *Copy Config* item in the Config (1) menu. (Note there is no menu associated with this panel key.)

\*To abort printing:

Pressing **SHIFT**, **COPY** and *Abort* aborts the printing currently taking place.

### 3.3.6 COUNTER Key (Frequency Counter)

#### 3.3.6 COUNTER Key (Frequency Counter)

Activates the Frequency counter mode and displays the associated menu. The current measurement frequency is also displayed.

<i>Res 1kHz</i>	Sets the frequency counter resolution to 1kHz.
<i>Res 100Hz</i>	Sets the frequency counter resolution to 100 Hz.
<i>Res 10Hz</i>	Sets the frequency counter resolution to 10 Hz.
<i>Res 1Hz</i>	Sets the frequency counter resolution to 1 Hz.
<i>Counter OFF</i>	Turns the frequency counter mode off.



### 3.3.7 DISPLAY Key (Line and Window)

This section describes the menu displayed when the **DISPLAY** key is pressed.

<i>Disp Line ON/OFF</i>	Toggles the display line indication on or off. The display line is used as a base line when comparing trace levels.
ON:	Turns the display line on. The display line position can be adjusted under this setting.
OFF:	Turns the display line off.
<i>Ref Line ON/OFF</i>	Toggles the reference line indication on or off. The reference line is used as a base line to which the level value is relative.
ON:	Displays the reference line. The reference line position can be adjusted under this setting.
OFF:	Turns the reference line off.
<i>Measuring Window</i>	Displays the Window menu.
<i>Window ON/OFF</i>	Turns the measuring window display on or off.
ON:	Displays the measuring window.
OFF:	Erases the measuring window.
<i>Window Position</i>	Allows you to set the measuring window position.
<i>Window Width</i>	Allows you to set the measuring window width.
<i>Window Sweep ON/OFF</i>	Turns the window sweep function on or off.
ON:	Sweeps the range specified by the measuring window.
OFF:	Sweeps the range specified by the span.
<i>Marker Couple ON/OFF</i>	Turns the marker couple function on or off.
ON:	Marker search is limited to the inside of the measuring window.
OFF:	Turns the marker couple function off. The whole screen is searched.
<i>Multi Screen</i>	Displays the Multi Scrn menu.

3.3.7 DISPLAY Key (Line and Window)

<b>Zoom</b>	<p>Displays the Zoom menu and two windows. The window indicating the zoom position is displayed in the upper screen, while the zoom is displayed in the lower screen. The horizontal axis represents frequency (or time) in both the upper and lower screens.</p>
<i>Zoom Position</i>	Allows you to set the zoom position.
<i>Zoom Width</i>	Allows you to set the zoom width.
<i>Screen A/B</i>	Toggles the active screen between A (upper screen) and B (lower screen).
<i>Screen Reset</i>	Resets the screen display to one screen (upper screen) and returns to the Multi Scrn menu.
<b>F/T</b>	<p>Displays the Zoom menu and two windows. The window indicating the zoom position is displayed in the upper screen. The horizontal axis in the upper screen represents the frequency. The horizontal axis in the lower screen represents the time (zero span) in the zoom position.</p>
<i>Zoom Position</i>	Allows you to set the zoom position.
<i>Screen A/B</i>	Toggles the active screen between A (upper screen) and B (lower screen).
<i>Screen Reset</i>	Resets the screen display to one screen (upper screen) and returns to the Multi Scrn menu.
<b>T/T</b>	<p>Displays two windows, and the horizontal axis in both the upper and lower screens is displayed in the time domain (zero span at the center frequency). Different frequencies can be set for the upper and lower screens.</p>
<i>Screen A/B</i>	Toggles the active screen between A (upper screen) and B (lower screen).
<i>Screen Reset</i>	Resets the screen display to one screen (upper screen).

### 3.3.8 EMC Key (EMC Measurement)

This section describes the menu displayed when the **SHIFT** key and the **1(EMC)** key are pressed.

<i>Detector Mode</i>	Displays the Detector menu.
<i>QP</i>	Displays the QP menu and detects the quasi peak value.
<i>RBW Auto</i>	Automatically sets the resolution bandwidth. (NOTE)
<i>RBW 200Hz</i>	Sets the resolution bandwidth to 200 Hz (available for OPT27 only). (NOTE)
<i>RBW 9kHz</i>	Sets the resolution bandwidth to 9 kHz. (NOTE)
<i>RBW 120kHz</i>	Sets the resolution bandwidth to 120 kHz. (NOTE)
<hr/> <p><b>NOTE:</b>     Set the appropriate sweep time for the specified RBW and frequency span.</p> <p>                  Set the sweep time to 1 sec for 200 Hz of frequency span when the RBW is 200 Hz.</p> <p>                  Set the sweep time to 1 sec for 10 kHz of frequency span when the RBW is 9 kHz.</p> <p>                  Set the sweep time to 1 sec for 100 kHz of frequency span when the RBW is 120 kHz.</p> <hr/>	
<i>Peak</i>	Displays the Peak menu and detects the peak value.
<i>RBW Auto</i>	Automatically sets the resolution bandwidth.
<i>RBW 200Hz</i>	Sets the resolution bandwidth to 200 Hz (available for OPT27 only).
<i>RBW 9kHz</i>	Sets the resolution bandwidth to 9 kHz.
<i>RBW 120kHz</i>	Sets the resolution bandwidth to 120 kHz.
<i>RBW 1MHz</i>	Sets the resolution bandwidth to 1 MHz.
<i>Normal</i>	Switches to the current detector as set at <i>Detector</i> (the Trc Det menu) in the <b>TRACE</b> .
<i>Field</i>	Displays the Antenna menu. From here, select the antenna factor you wish to correct for (5D2W cable, 10 m including the cable loss).
<i>TR1722</i>	Corrects for half-wave dipole antennas (TR1722).
<i>UHALP9107</i>	Corrects for log-periodic antennas (UHALP9107).

3.3.8 EMC Key (EMC Measurement)

<i><b>BBA9106</b></i>	Corrects for biconical antennas (BBA9106).
<i><b>EMCO3142</b></i>	Corrects for bilog antennas (EMCO3142).
<i><b>User ANT Corr</b></i>	Opens the user-definable correction table, and displays the correction data list in the User Ant Corr menu.
<i><b>Insert Line</b></i>	Inserts a line in the cursor position.
<i><b>Delete Line</b></i>	Deletes the line at the cursor position.
<i><b>Sort</b></i>	Sorts the frequency data in the table in the ascending order.
<i><b>Table Init</b></i>	Deletes the data from the table.
<i><b>Corr Mode ANT/LVL</b></i>	<p>Toggles between the antenna factor (for the defined correction data) and the level correction data settings.</p> <p>ANT: Sets the antenna factor, and automatically sets the unit used for the vertical axis to dB<math>\mu</math>V/m.</p> <p>LVL: Sets the level correction data, and sets the unit for the vertical axis to the level you have previously chosen.</p> <p>Any other antenna factors than those chosen by the user are considered invalid, so the displayed unit will automatically be dB<math>\mu</math>V/m.</p>
<i><b>Corr OFF</b></i>	No longer uses the correction data.
<i><b>Sound</b></i>	Displays the Sound menu, and demodulates the sound at the marker.
<i><b>Sound AM/FM</b></i>	Toggles between AM and FM demodulation.
<i><b>Volume</b></i>	Allows you to set the demodulated sound volume. The volume can be set from a range of 1 to 12.
<i><b>Marker Pause Time</b></i>	Allows you to set the duration of the pause used during demodulation.
<i><b>Squelch ON/OFF</b></i>	<p>Toggles the squelch function on or off.</p> <p>ON: Displays the squelch marker which indicates that the sound carrier level below this level is not demodulated. The squelch level can also be changed.</p> <p>OFF: Removes the squelch marker, and turns off the squelch function.</p>

*Sound OFF*

Turns off the sound demodulation function and displays the EMC menu.

3.3.9 **FREQ Key (Frequency)**

**3.3.9 FREQ Key (Frequency)**

Pressing this key displays the FREQ menu and allows you to set the center frequency (or the start frequency when the start and stop frequencies are displayed). In addition, it displays both the current center frequency and frequency span (or both the start and stop frequencies) in the area below the bottom scale line.

**Center** Allows you to set the center frequency, and displays the center frequency and frequency span in the annotation area below the bottom scale line.

**Start** Allows you to set the start frequency (the frequency furthest to the left on the frequency axis), and displays the start and stop frequencies in the annotation area below the bottom scale line.

**Stop** Allows you to set the stop frequency (the frequency furthest to the right on the frequency axis), and displays the start and stop frequencies in the annotation area below the bottom scale line.

**CF Step AUTO/MNL** Toggles the step size function between AUTO and MNL. This function is used to change a center frequency using the step keys.

**AUTO:** Automatically sets the step size to 1/10 of the frequency span.

**MNL:** Allows you to set the step size manually.

**Freq Offset ON/OFF** Turns the frequency offset function on or off.

**ON:** Sets an offset value and changes only the frequency display by the offset value.  
(Displayed frequency value = Set value + Offset value)

**OFF:** Turns the offset function off.

**Channel Setting** Displays the CH Setting menu. Allows you to set the channel frequency from the channel table after the input mode has been changed. The types of data entered by the **Center**, **Start** and **Stop** keys vary depending on the input mode.

**Frequency Input** Displays the Frequency Input dialog box.

**Input Type** Input Type can be switched to the center frequency, starting frequency or stop frequency.

**Frequency:** Sets the input type to normal frequency mode.

**CH Type 1:** Sets the input type to CH Type 1 mode which allows you to set the center frequency using a channel number (with the **FREQ** key) or a frequency (with the **Center** key).

The **Start** and **Stop** keys are used to set frequencies.

To set sequential channels which all have the same channel bandwidth, use the channel numbers in the appropriate table created from the expression in the **CH Type 1 Edit** function.

#### CH Type 2:

Sets the input type to CH Type 2 mode which allows you to set the **FREQ**, **Center**, **Start** and **Stop** keys using a channel number.

To set sequential channels which have unique channel bandwidths, use the channel numbers in the appropriate table created from the frequency list in the **CH Type 2 Edit** function.

<b>Start CH Shift</b>	Used to enter the shift amount of the start channel's start frequency when <b>Input Type</b> is CH Type 2. Sets the start frequency of the top channel in the <b>CH Type 2 Edit</b> table so that the start frequency is increased by the shift amount.
<b>Stop CH Shift</b>	Used to enter the shift amount of the stop channel's stop frequency when <b>Input Type</b> is CH Type 2. Set the stop frequency of the last channel in the <b>CH Type 2 Edit</b> table so that the stop frequency is decreased by the shift amount.
<b>CH Type 1 Edit</b>	Displays the CH Type 1 Setting editor.
<b>Table 1 to 3</b>	Toggles the table mode (for Table 1 thru 3) between ENABLE and DISABLE.  ENABLE: Displays the corresponding table.  DISABLE: Does not display the corresponding table.
<b>Channel</b>	Allows you to edit the channel range. Enter the start and stop channel numbers so that they satisfy the following expression: $(\text{Start channel number}) \leq N \leq (\text{Stop channel number})$ .
<b>Carrier</b>	Allows you to edit the carrier frequency range. Enter the value calculated from the following formula: $(\text{Channel spacing}) \times (N + \text{Channel offset}) + (\text{Start frequency})$
<b>CH Type 2 Edit</b>	Displays the CH2 Edit menu and the CH Type 2 Setting editor. This item is used to enter the channel number, carrier frequency, channel start frequency and channel stop frequency. A total of 99 channels can be used.
<b>Insert Line</b>	Inserts a line in the cursor position.

3.3.9 FREQ Key (Frequency)

<i>Delete Line</i>	Deletes the line at the cursor position.
<i>Sort</i>	The carrier frequencies in the table are sorted in ascending order.
<i>Table Init</i>	Deletes data from the table.
<i>1/2_more</i>	Displays the Freq menu (2/2).
<i>Presel</i>	Displays the Presel menu (For the R3162/72/82).
<i>Auto Tune</i>	Automatically tunes the preselector according to the peak frequency.

---

**NOTE:**     *To terminate the tuning, press any keys other than the COPY, LOCAL, SINGLE and REPEAT keys.*

---

<i>Manual Tune</i>	Allows you to tune the preselector manually.
<i>Mixer INT/EXT</i>	Switches between the Internal and External mixers (Compatible with OPT16 thru OPT19 only).  INT:     Uses the internal mixer.  EXT:     Uses the external mixer.
<i>Ext Mixer Config</i>	Displays the Mix Config menu (Compatible with OPT16 thru OPT19 only).
<i>Band Select</i>	Used to select the frequency band of the external mixer. The relationships among frequency bands, frequency ranges and harmonic orders are as follows.

Frequency band	Frequency range [GHz]	Harmonic order [N]
1	17.0 to 26.5	4
2	22.0 to 33.0	5
3	26.5 to 40.0	6
4	33.0 to 50.0	8
5	40.0 to 60.0	8
6	50.0 to 75.0	10
7	70.0 to 80.0	12
8	60.0 to 90.0	12
9	75.0 to 110.0	16
10	90.0 to 140.0	20
11	110.0 to 170.0	24
12	140.0 to 220.0	30
13	170.0 to 260.0	36
14	220.0 to 325.0	44



<b><i>Band Lock ON/OFF</i></b>	Toggles the frequency band lock function on or off.
	ON: Locks the frequency band to the one selected for the external mixer.
	OFF: Automatically switches the frequency band according to the start and stop frequencies.
<b><i>Average Loss ON/OFF</i></b>	Toggles the correction function (used for the external mixer's intrinsic average conversion loss) on or off.
	ON: Corrects for the conversion loss using an average conversion loss value.
	OFF: Turns the correction function off.
<b><i>Loss:Freq ON/OFF</i></b>	Toggles the correction function on or off.
	ON: Corrects for conversion loss using the frequency vs. loss table.
	OFF: Turns the correction function off.
<b><i>Loss:Freq Edit</i></b>	Displays the Loss:Freq menu.
<b><i>Insert Line</i></b>	A line with the same values is inserted in the line where the cursor is located.
<b><i>Delete Line</i></b>	The line where the cursor is located is deleted.
<b><i>Sort</i></b>	The data previously entered is sorted by frequency.
<b><i>Table Init</i></b>	Deletes all data from the table.
<b><i>Signal Ident ON/OFF</i></b>	Toggles the Signal Identification function on or off (Compatible with OPT16 thru OPT19 only).
	ON: More than one spectrum is displayed for one input signal when an external mixer is used. From among these spectrums, the true signal is identified.
	OFF: Turns off the signal identification function.
<b><i>Image Suppress ON/OFF</i></b>	Toggles the Software Image Suppression function on or off (Compatible with OPT16 thru OPT19 only).
	ON: Used to identify actual signals as in the Signal Identification function. Eliminates unnecessary image signals using a software function so that an input signal can be easily observed.

3.3.9 FREQ Key (Frequency)

*2/2\_more*

OFF: Turns off the Software Image Suppression function.

Returns to the Frequency (1) menu.

### 3.3.10 Hold Mode

Pressing the **SHIFT** key for several seconds until the word “HOLD” appears on the screen activates the Hold mode. This mode disables all panel and soft key input.

Pressing the **SHIFT** until “HOLD” is removed from the screen deactivates Hold mode.

3.3.11 LEVEL Key (Frequency Level)

**3.3.11 LEVEL Key (Frequency Level)**

This section describes the menu (1/2) displayed when the LEVEL key is pressed.

<i>Ref Level</i>	Allows you to set the reference level.
<i>ATT AUTO/MNL</i>	Toggles the input attenuator between AUTO and MNL.
	AUTO: Automatically sets an optimum input attenuator in accordance with the reference level setting.
	MNL: Allows you to set an input attenuator within a range of 0 to 50 dB (in 5 dB step) for the R3132/N; within a range of 0 to 75 dB (in 5 dB step) for the R3162. Setting the attenuation to 0 dB is possible only by using the numeric keys.

---

**NOTE:**     When Hi Sens ON/OFF is turned on, the input signal range is between 0 and 30 dB.

---

<i>dB/div</i>	Displays the dB/div menu, which includes amplitude scales (for the vertical axis) and is used to display data in logarithmic scale.
<i>10dB/div</i>	Sets the amplitude scale (vertical axis) to 10 dB/div.
<i>5dB/div</i>	Sets the amplitude scale (vertical axis) to 5 dB/div.
<i>2dB/div</i>	Sets the amplitude scale (vertical axis) to 2 dB/div.
<i>1dB/div</i>	Sets the amplitude scale (vertical axis) to 1 dB/div.
<i>Linear</i>	Displays the reference level data between 0 V and the REF level on a linear scale (in volts).
<i>Units</i>	Displays the Units menu which sets the units used for the reference level, the display line and the marker level.
<i>dBm</i>	Sets the unit to dBm.
<i>dBmV</i>	Sets the unit to dBmV.
<i>dBµV</i>	Sets the unit to dBµV.
<i>Watts</i>	Sets the unit to W.
<i>Volts</i>	Sets the unit to V.
<i>Hi Sens ON/OFF</i>	Turns the high sensitivity input function on or off.

	ON:	Turns on the built-in pre-amplifier at the gain of 20 dB and over. Since the gain of the pre-amplifier at each frequency is corrected, no gain needs to be considered for level measurement.
	OFF:	Turns the built-in pre-amplifier off.
<i>1/2_more</i>		Displays the Level menu (2/2).
<i>Ref Offset ON/OFF</i>		Toggles the reference level offset function on or off.
	ON:	Allows you to set the offset level in a range of 0 to $\pm 100.0$ dB. The relationships between the displayed reference level, the set reference level and the offset are shown below: Reference level (displayed) = Reference level (set) + Offset.
	OFF:	Turns off the offset.
<i>Input 50<math>\Omega</math>/75<math>\Omega</math></i>		Sets the impedance input level for the display. The 75 $\Omega$ setting is used when a 75 $\Omega$ impedance converter (ZT-130NC) is connected to the RF input. The R3132 converts all levels for the 75 $\Omega$ system and displays them.
<i>2/2_more</i>		Displays the Level menu (1/2).

### 3.3.12 LOCAL Key (GPIB Remote Control)

#### **3.3.12 LOCAL Key (GPIB Remote Control)**

Turns off GPIB remote control. (Note there is no menu associated with this panel key.)

### 3.3.13 MEAS Key (Measurement)

This section describes the menu displayed when the **MEAS** key is pressed.

<i>Noise/Hz</i>	Displays the Noise/Hz menu, and allows you to set the frequency width for noise measurement.
<i>dBm/Hz</i>	Sets the vertical axis unit to dBm, and sets the marker readout signal level unit to dBm/Hz. In addition, the detector is automatically set to the sample detection mode.
<i>dB<math>\mu</math>V/<math>\sqrt</math>Hz</i>	Sets the vertical axis unit to dB $\mu$ V, and sets the marker readout signal level unit to dB $\mu$ V/ $\sqrt$ Hz. In addition, the detector is automatically set to the sample detection mode.
<i>dBc/Hz</i>	Sets the unit of delta marker signal level to dBc/Hz and turns the marker fixed function (delta marker) ON, then sets the detector to the sample detection mode.
<i>Noise/Hz OFF</i>	Turns off the noise measurement mode, and displays the Measure menu.
<i>XdB Down</i>	Displays the XdB Down menu.
<i>XdB Down</i>	Moves the normal marker to an intersection point on the trace x dB down from the present location according to the <b>MKR Read DLT/LFT/RHT</b> setting.
<i>XdB Left</i>	Moves the normal marker to the left to an intersection point on the trace x dB down from the present location.
<i>XdB Right</i>	Moves the normal marker to the right to an intersection point on the trace x dB down from the present location.
<i>MKR Read DLT/LFT/RHT</i>	Selects the marker display under the x dB down function to either DLT, LFT or RHT.  DLT: The delta marker is displayed on the left; and the normal marker, on the right.  LFT: The normal marker is displayed on the left.  RHT: The normal marker is displayed on the right.
<i>Cont Down ON/OFF</i>	Toggles the count down function on or off.  ON: Sets the x dB down function to repeat continuously. Establishes the trace peak point for each sweep which is used as the reference point of the marker down.  OFF: Turns off the count down function.

3.3.13 MEAS Key (Measurement)

**3rd Order Meas**

Displays the delta marker on the peak of the fundamental wave and the normal marker on the peak of the third order intermodulation distortion.  
Use the value displayed when Peak Delta Y is pressed as the peak search condition.

**% AM Meas ON/OFF**

Toggles the %AM Meas function on or off.

ON: Calculates an AM modulation factor using a peak search, and displays the result as a percentage (%).  
Use the value displayed when Peak Delta Y is pressed as the peak search condition.

OFF: Turns off the %AM Meas.

**% AM Video ON/OFF**

Toggles the %AM Video function on or off.

ON: Displays the AM modulation factor (as percentage) after video signal's AM modulation factor has been calculated using the peak search.

OFF: Turns the %AM Video function off.

**FM Meas**

Displays the FM Meas menu to measure FM signal frequency deviation. The value of the Peak Delta Y is used to perform the peak search.

If the mode "Mod Freq → SWP T ON/OFF" is set to ON, the sweep time is optimally set using the modulation frequency and the number of displayed trace points.

If the mode "Mod Freq → SWP T ON/OFF" is set to OFF, the sweep time must be set using the expression shown below.

$$SWP \geq PT \times 1/F_{mod}$$

SWP: Sweep time

PT: Number of displayed trace points

Fmod: Modulation frequency

(Posi mode is automatically set when the FM Meas function is selected. Refer to Posi.)

**Mod Freq → SWP T ON/OFF**

Toggles the sweep time calculation function (if given a modulation frequency) on or off.

ON: Sets the modulation frequency and then calculates the sweep time.

OFF: Turns the sweep time calculation function off.  
The value set by SWP Time AUTO/MNL is used as the sweep time when starting measurements.



<i>Peak Delta Y</i>	Allows you to set the amplitude used for the peak search.
<i>FM Meas OFF</i>	Turns the FM Meas function OFF.
<i>1/2_more</i>	Displays the Measure menu (2/2).
<i>Sound</i>	Displays the Sound menu, and demodulates the sound at the marker.
<i>Sound AM/FM</i>	Toggles between AM and FM demodulation.
<i>Volume</i>	Allows you to set the demodulated sound volume. You can set the sound volume from a range of 1 to 12.
<i>Marker Pause Time</i>	Allows you to set the duration of the pause used during demodulation.
<i>Squelch ON/OFF</i>	Toggles the squelch function on or off.  ON: Displays the squelch marker which indicates that the sound carrier level below this level is not demodulated. The squelch level can also be changed.  OFF: Removes the squelch marker, and turns off the squelch function.
<i>Sound OFF</i>	Turns off the sound demodulation function.
<i>Phase Noise</i>	Displays the Phase Noise menu. A menu used to measure phase noises and phase jitters is displayed.
<i>C/N Meas</i>	Displays the C/N Meas menu. A variety of settings for the phase noise measurement can be performed. For this measurement, a phase noise is calculated using an offset frequency which is deviated from the carrier frequency or the current center frequency. A maximum offset frequency of 10 points can be measured.
<i>Edit Table</i>	Displays the Edit Table menu, allowing you to set the desired offset frequency.
<i>Insert</i>	Enters the same data in the current cursor position.
<i>Delete</i>	Deletes the data at the current cursor position.
<i>Table Init</i>	Deletes all data from the table.
<i>Sig Track ON/OFF</i>	Toggles the signal track mode on or off.

3.3.13 MEAS Key (Measurement)

ON: The signal track mode is turned on, and measurements are taken by keeping track of the carrier frequency, which results in changes to the center frequency.

OFF: Turns the signal track mode off.

**Average Times ON/OFF**

Toggles the trace averaging function on or off.

ON: Sets the number of averaging times and traces and averages the phase noise waveform for each offset frequency.

OFF: Turns the trace average function off.

**C/N Meas OFF**

The phase noise measurement function is turned off, and the screen returns to the Phase Noise menu.

**Phase Jitter**

Displays the Phase Jitter menu. A variety of parameters used to measure phase jitter can be set. A jitter is calculated by specifying a phase noise integration range based on an offset frequency deviated from the carrier frequency that is the same as the current center frequency.

**Start Offset**

Sets the lower limit of the phase noise integration range.

**Stop Offset**

Sets the upper limit of the phase noise integration range.

**Sig Track ON/OFF**

Toggles the signal track mode on or off.

ON: The signal track mode is turned on, and measurements are taken by keeping track of the carrier frequency, which results in changes to the center frequency.

OFF: Turns the signal track mode off.

**Average Times ON/OFF**

Toggles the trace averaging function on or off.

ON: Sets the number of averaging times, traces and then averages the phase noise waveform for each offset frequency.

OFF: Turns the trace average function off.

**Phase Jitter OFF**

The phase noise measurement function is turned off, and the Phase Noise menu is displayed.

**IM Meas** Displays the IM Meas menu in two-screen mode. Traces are displayed on the upper screen, and odd-harmonic measurement data is displayed on the lower screen.

**Order** Sets the degrees used. The degrees available are 3, 5, 7 and 9.

**Limit Setup** Displays the Limit Setup dialog box.

Limit Setup	
3rd Order :	-40.00 dB
5th Order :	-50.00 dB
7th Order :	-55.00 dB
9th Order :	-60.00 dB

**3rd Order** Sets the limit value for a third-order harmonic signal.

**5th Order** Sets the limit value for a fifth-order harmonic signal.

**7th Order** Sets the limit value for a seventh-order harmonic signal.

**9th Order** Sets the limit value for a ninth-order harmonic signal.

**Pass/Fail Judgement ON/OFF** Toggles the Pass/Fail Judgement function on or off. This function compares a measured value with the value set in the Limit Setup dialog box.

ON: Performs a Pass/Fail judgement. The result is Fail if the measurement value is greater than the limit value.

OFF: Does not perform a Pass/Fail judgement.

**Average Times ON/OFF** Toggles the trace averaging function on or off.

ON: Sets the number of averaging times.

OFF: Turns the trace average function off.

**Hi Sens (IM Meas) ON/OFF** Toggles the Hi Sens measurement mode on or off. This function is used to increase measurement sensibility.

ON: Decreases the reference level by 20 dB before a harmonic signal is measured.

OFF: A harmonic signal is measured within a single screen.

**IM Meas OFF** Turns off the odd harmonic measurement function, and returns to the Measure menu (2/2) display.

**2/2\_more** Displays the Measure menu (1/2).

3.3.14 MKR Key (Marker)

**3.3.14 MKR Key (Marker)**

This key displays the Marker menu (1/2) and allows you to set a normal marker.

**Normal** Displays the normal marker so that you can use it. The frequency and the level at the marker are displayed in the marker area.

**Delta** Allows you to set the delta marker, and displays the delta marker in the same position as that of the normal marker. The frequency and the level values of this marker are relative to those of the normal marker.

**Peak Menu** Displays the Peak menu (1/2), and allows you to quickly move the normal marker to any point on the trace.

**Next Peak** Moves the present marker to the next highest peak within the search range.

**Next Peak Left** Moves the present marker to the next lower frequency peak on the left side of the current marker.

**Next Peak Right** Moves the present marker to the next higher frequency peak on the right side of the current marker.

**Next Peak Max-Min** Displays the normal marker on the maximum peak, and the delta marker on the minimum peak within the search range.

**Min Peak** Moves the delta marker to the minimum peak within the search range.

**Cont Peak ON/OFF** Toggles the continuous peak search function on or off.

ON: Displays the frequency and the level of the marker after moving the marker to the maximum peak in each sweep.

OFF: Turns off the continuous peak search function.

**1/2\_more** Displays the Peak menu (2/2).

**Peak Delta Y** Allows you to set the amplitude settings used for the next peak search. When the Signal Track, %AM Meas, 3rd Order Meas and FM Meas functions are enabled, they are used as amplitude conditions when searching for a signal peak.

**Search ALL/UP/LOW** Selects the next peak search range with respect to the threshold value of the display line.

All: Removes the display line after repeating the next peak search for all peaks.

	UP:	Performs the next peak search for all the peaks above the display line. The display line can be adjusted from this setting.
	LOW:	Performs the next peak search for all the peaks under the display line. The display line can be adjusted from this setting.
<i>2/2_more</i>		Returns to the Peak menu (1/2).
<i>Sig Track ON/OFF</i>		Toggles the signal track function on or off.
	ON:	Sets the marker frequency to the center frequency for each sweep, after performing the peak search for the same peak. Use the value displayed when Peak Delta Y is pressed as the peak search condition.
	OFF:	Turns off the signal track function.
<i>MKR Trace A/B</i>		Selects one of the two traces so that the marker is available when traces A and B are displayed simultaneously.
<i>Marker OFF</i>		Turns off all marker functions.
<i>1/2_more</i>		Displays the Marker menu (2/2).
<i>Fixed MKR ON/OFF</i>		Toggles the Fixed Marker function on or off.
	ON:	Stores the frequency and level of the displayed delta marker and fixes the marker at the current physical position on the screen.
	OFF:	Turns off the Fixed Marker function.
<i>MKR Step AUTO/MNL</i>		Toggles the step size function on or off. This function allows you to control the movement of the marker using the step key.
	AUTO:	Automatically sets the step size to 1/10 of the span.
	MNL:	Allows you to manually set the step size to any value.
<i>Multi Marker</i>		Displays the Multi MKR menu.
<i>Multi MKR Setup</i>		Displays the MKR Setup menu.
<i>Marker No.</i>		Allows you to set the multi-marker number and displays the value you entered.
<i>Marker ON</i>		Displays the multi-marker specified by the number. The frequency and level of the marker are displayed in the marker area.

3.3.14 MKR Key (Marker)

<i>Marker OFF</i>	Removes the multi-marker specified by the number.
<i>Active Marker</i>	Turns on or off the multi-marker displayed on the screen.
<i>Reset Marker</i>	Removes all multi-markers except multi-marker No.1.
<i>MKR List ON/OFF</i>	Toggles the multi-marker list display function on or off.  ON: Displays a list of the current multi-marker numbers, frequencies and levels in ascending order.  OFF: Removes the list of multi-markers.
<i>Peak List Level</i>	Lists the levels and frequencies in descending order of the peak levels.
<i>Peak List Freq</i>	Lists the levels and frequencies in descending order of the peak level frequencies.
<i>Multi MKR OFF</i>	Removes all multi-markers from the display.
<i>2/2_more</i>	Returns to the Marker menu (1/2).

### 3.3.15 MKR → Key (Marker →)

This section describes the menu displayed when the **MKR →** key is pressed. This menu allows you to use the active marker data (such as frequency and level) as the data for some other function. Item(s) in the MKR→ menu (1/2) may be different depending on the marker you use (either normal or delta marker).

<i>MKR → CF</i>	Sets the active marker frequency as the center frequency.
<i>MKR → Ref</i>	Sets the active marker level as the reference level.
<i>Peak → CF</i>	Moves the marker to the maximum peak within the search range, and sets the marker frequency as the center frequency.
<i>Peak → Ref</i>	Moves the marker to the maximum peak within the search range, and sets the marker level as the reference level.
<i>ΔMKR → Span</i>	Sets the frequency difference between the delta and normal marker as the frequency span.
<i>1/2_more</i>	Displays the Mkr → menu (2/2).
<i>MKR → CF Step</i>	Sets the marker frequency as the center frequency for the step size.
<i>ΔMKR → CF Step</i>	Sets the frequency difference between the delta and normal marker as the step size for the center frequency.
<i>MKR → MKR Step</i>	Sets the marker frequency as the step size of the marker.
<i>ΔMKR → MKR Step</i>	Sets the frequency difference between the delta and normal marker as the step size of the marker.
<i>ΔMKR → CF</i>	Sets the frequency difference between the delta and normal marker as the center frequency.
<i>2/2_more</i>	Returns to the Mkr → menu (1/2).

3.3.16 PAS/FAIL Key (Pass/Fail Judgment)

**3.3.16 PAS/FAIL Key (Pass/Fail Judgment)**

Pressing the **PAS/FAIL** key displays the Pass/Fail menu.

**Pass/Fail ON/OFF** Turns the Pass/Fail judgement function, according to the limit lines, on or off.

**ON:** A Pass/Fail judgement is made based on the set limit line.

**OFF:** Turns the Pass/Fail judgement function off.

**Line1 ON/OFF** Turns limit line 1 on or off.

**ON:** Displays limit line 1 and the judgement result (PASS or FAIL).

**OFF:** Erases limit line 1 and the judgement result.

**Line2 ON/OFF** Turns limit line 2 on or off.

**ON:** Displays limit line 2 and the judgement result (PASS or FAIL).

**OFF:** Displays limit line 2 and the judgement result.

**X ABS/LFT/CTR** Sets the attribute of horizontal axis (frequency or time) data of the limit line.

**ABS:** Sets the horizontal axis position using the limit line that is set under Limit Line Edit as an absolute value. The horizontal axis position of the limit line moves as the frequency span or the center frequency setting changes.

**LFT:** Sets the horizontal axis position using the limit line that is set under Limit Line Edit as a relative value. The horizontal axis position of the limit line is fixed at the position based on the left end without being influenced by changes in frequency span or center frequency.

**CTR:** Sets the horizontal axis position using the center of the horizontal axis as a relative value.

**Y ABS/TOP/BOT (Y ABS/CTR)** Sets the attribute of vertical axis (level) data of the limit line.

**ABS:** Sets the vertical axis position using the limit line that is set under Limit Line Edit as an absolute value. The vertical axis position of the limit line moves as the level setting changes.



**TOP:** Sets the vertical axis position using the limit line that is set under Limit Line Edit as a relative value. The vertical axis position of the limit line is fixed in the position based on the top without being influenced by changes in level setting.

**BOT:** Sets the horizontal axis position using the bottom of the vertical axis as a relative value.

Sets the limit line property (in frequencies) along the vertical axis (if OPT73, FM Demodulation function, is turned on).

**ABS:** The position along the vertical axis is determined from the absolute value of a limit line set by the Limit Line Edit.  
The vertical position of the limit line varies according to the change in the center frequency used.

**CTR:** The position along the vertical axis is determined relative to the limit line value set by the Limit Line Edit.  
The vertical position of the limit line is fixed at its center. Note that the center frequency does not affect the vertical position of the limit line.

***Shift X/Y***

Switches the offset direction for the limit line between X and Y.

**X:** Sets an offset value for the horizontal axis direction of the limit line.

**Y:** Sets an offset value for the vertical axis direction of the limit line.

***Limit Line Edit***

Displays the Edit Menu.

***Limit Line 1/2***

Selects the limit line to edit on the Edit screen.

***Insert Line***

Inserts a line in the cursor position.

***Delete Line***

Deletes the line at the cursor position.

***Sort***

Sorts the input data according to the frequencies.

***Table Init***

Deletes all the data in the limit line setting table.

***Copy Table 1 to 2***

Copies the data created on limit line 1 to limit line 2.

***Copy Table 2 to 1***

Copies the data created on limit line 2 to limit line 1.

### 3.3.17 PK SRCH Key (Peak Search)

#### **3.3.17 PK SRCH Key (Peak Search)**

Pressing this key displays the frequency and level of the marker after moving the marker to the maximum level of the trace within the search range. (Note there is no menu associated with this panel key.)

### 3.3.18 POWER MEASURE Key (Power Measurement)

This section describes the Power menu displayed when the **POWER MEASURE** key is pressed.

#### *Channel Power*

Activates the measuring window, and displays the CH Power menu.

The channel power is calculated using the formula shown below.

$$P_{CH} = 10 \log \left[ \sum_{n=X1}^{X2} \left( 10^{\frac{P(n)}{10}} \right) \times \frac{1}{RBW} \times \frac{SPAN}{(X2 - X1 + 1)} \right]$$

P<sub>CH</sub>: Channel power

P(n): Data (dBm) for each trace point

SPAN: Current span value

PBW: Noise power bandwidth

X1: Data position of start frequency on the x-axis.

X2: Data position of stop frequency on the x-axis.

#### *Window Position*

Allows you to set the center of the measuring window (channel bandwidth).

#### *Window Width*

Allows you to set the width of the measuring window (channel bandwidth).

#### *Average Times*

Allows you to set the number of times the sweep is averaged.

#### *Parameter Setup*

Displays the Prmr Setup menu.

#### *Default*

Sets the following settings to default values: the frequency span, resolution bandwidth, video bandwidth, sweep time, detector, trace mode, channel band position and channel bandwidth. When **Default** is enabled, the defaults are automatically set when the channel power is measured.

#### *Manual*

Disables the **Default** function. As a result, the above settings must be set manually. The currently set values are used when channel power is measured.

**Define → Default** The currently set values are the new defaults.

#### *CH Power OFF*

Removes the window and cancels channel power measurements.

#### *Total Power*

Measures the total power in the object range (the entire measurement span or window) and displays it.

The total power is calculated using the formula shown below.

The number of trace points on the horizontal axis is set to 1001.

$$P_T = 10 \log \left[ \sum_{n=X1}^{X2} \left( 10^{\frac{P(n)}{10}} \right) \times \frac{1}{PBW} \times \frac{SPAN}{1001} \right]$$

P<sub>T</sub>: Total power to be calculated.

P(n): Data (dBm) for each trace point.

SPAN: Current span value

3.3.18 POWER MEASURE Key (Power Measurement)

PBW: Noise power bandwidth  
 X1: 1  
 X2: 1001

**Average Power**

Measures the power averaged over the object range (the entire measurement span or window) and displays it.  
 Allows you to set the averaging count used to calculate the average power.  
 With average power measurements, the resolution bandwidth (RBW) is set to a bandwidth wider than the amplitude variation width (the resolution bandwidth must be at least three times wider than the occupied bandwidth). The average power is calculated using the formula shown below.  
 The number of trace points on the horizontal axis is set to 1001.

$$P_{AVG} = 10 \log \left[ \sum_{n=X1}^{X2} \left( 10^{\frac{P(n)}{10}} \right) \times \frac{1}{1001} \right]$$

P<sub>AVG</sub>: Denotes the average power to be calculated.  
 P (n): Denotes the data (dBm) for each trace point.  
 X1: 1  
 X2: 1001

**Power Meas OFF**

Turns off the power measurement function.

**OBW**

Displays the OBW menu.

**OBW%**

Sets the percentage of occupied power compared to the total power when measuring the occupied bandwidth.

**Parameter Setup**

Displays the Prmr Setup menu.

**Default**

Sets the following settings to default values: the frequency span, resolution bandwidth, video bandwidth, sweep time, detector, trace mode and the OBW%. When **Default** is enabled, the defaults are automatically set when the OBW is measured.

**Manual**

Disables the **Default** function. As a result, the above settings must be set manually. The currently set values are used when the OBW is measured.

**Define → Default**

The currently set values become the new defaults.

**OBW OFF**

Turns the OBW measuring function off.

**ACP**

Displays the ACP menu.

**CS/BS Setup**

Displays the CS/BS Setup menu, and the editor used to set the channel spacing and specified bandwidth together.

***√Nyquist Filter ON/OFF***Toggles the  $\sqrt{\text{Nyquist}}$  filter function on or off.

ON: Turns the Nyquist filter function on.

OFF: Turns the Nyquist filter function off.

***Insert Line***

Inserts a line in the cursor position.

***Delete Line***

Deletes the line at the cursor position.

***Sort***

Sort the CS/BS Setting table by CS.

***Table Init***

Deletes all data in the table.

***BS Window ON/OFF***

Toggles the ACP bandpass window display on or off.

ON: Displays the window within the bandpass which is targeted for calculating the ACP.

OFF: Removes the window.

***√Nyquist Filter Setup***Displays the  $\sqrt{\text{Nyquist}}$  Filter Setup dialog box.

$\sqrt{\text{Nyquist}}$ Filter Setup	
Symbol Rate 1/T:	21.0 kHz
Rolloff Factor:	0.50
$\sqrt{\text{Nyquist}}$ Filter:	<input type="checkbox"/> ON <input checked="" type="checkbox"/> OFF

***Symbol Rate 1/T*** Sets the symbol rate.***Rolloff Factor*** Sets the rolloff factor.***√Nyquist Filter*** Toggles the Nyquist filter function on or off.

ON: Turns the Nyquist filter function on.

OFF: Turns the Nyquist filter function off.

***Screen FULL/SEPA/CARRIER***

Toggles the screen display between the full and separate screen modes.

FULL: The entire screen is used.  
Calculates the ACP based on the total power along the entire band on the screen.

3.3.18 POWER MEASURE Key (Power Measurement)

SEPA: The screen mode is changed to SEPA when a sweep takes place.

CARRIER:  
The entire screen is used.  
Calculates the ACP based on the power along the band specified by Carrier Band Width.

*Parameter Setup*

Displays the Prmtr Setup menu.

*Default*

Sets the following settings to default values: the frequency span, resolution bandwidth, video bandwidth, sweep time, detector, trace mode, CS/BS Setup and  $\sqrt{2}$ Nyquist Filter Setup. When *Default* is enabled, the defaults are automatically set when the ACP is measured.

*Manual*

Disables the *Default* function. As a result, the above settings must be set manually. The currently set values are used when the ACP is measured.

*Define → Default*

The currently set values become the new defaults.

*Graph*

Displays the Multi MKR menu (used for ACP Graph).  
Turns the graphic display function on.  
Displays the leakage power graph as Trace B and puts Delta marker in the center of the screen.  
The B memory is used to display the ACP graph.

*Marker No.*

Enter the multi marker number here.

*Marker ON*

Displays the multi-marker specified at Marker No. in the center of the trace and the frequency and level of the marker in the marker area.

*Marker OFF*

Removes the multi-marker specified by the number.

*Active Marker*

Turns on or off the multi-marker displayed on the screen.

*Reset Marker*

Removes all multi-markers except for multi-marker 1.

*Graph OFF*

Turns the graphic display function off.

*ACP OFF*

Turns off the ACP measurement function, and returns to the power menu.

*1/2 more*

Displays the Power menu (2/2).

*Spectrum Mask*

Displays the Spect Mask menu.  
Displays the measurement and judgment results in combination with the pass/fail judgment result using the limit lines for the ACP measurement.

**CS/BS Setup** Displays the CS/BS Setup menu, and the editor used to set the channel space and channel bandwidth together.

**√Nyquist Filter ON/OFF**

Toggles the √Nyquist filter function on or off.

ON: Turns the Nyquist filter function on.

OFF: Turns the Nyquist filter function off.

**Insert Line** Inserts a line in the cursor position.

**Delete Line** Deletes the line at the cursor position.

**Sort** Sort the CS/BS Setting table by CS.

**Table Init** Deletes all data in the table.

**BS Window ON/OFF**

Toggles the ACP bandpass window display on or off.

ON: Displays the window within the bandpass which is targeted for calculating the ACP.

OFF: Removes the window.

**√Nyquist Filter Setup** Displays the √Nyquist Filter Setup dialog box.

√Nyquist Filter Setup	
Symbol Rate 1/T:	21.0 kHz
Rolloff Factor:	0.50
√Nyquist Filter:	<input type="checkbox"/> ON <input checked="" type="checkbox"/> OFF

**Symbol Rate 1/T** Sets the symbol rate.

**Rolloff Factor** Sets the rolloff factor.

**√Nyquist Filter** Toggles the Nyquist filter function on or off.

ON: Turns the Nyquist filter function on.

OFF: Turns the Nyquist filter function off.

**Results REL/ABS** Toggles the unit of the measurement result display.

REL: Displays a relative value (dBc) of the power within the carrier bandwidth (set by CS/BS editor and referred to as the Ref Power) to the ACP power.

3.3.18 POWER MEASURE Key (Power Measurement)

	ABS:	Displays an absolute value using the unit selected from the Units menu under the LEVEL key.
<b>Parameter Setup</b>		Displays the Prmtr Setup menu.
<b>Default</b>		Sets the following settings to default values: the frequency span, resolution bandwidth, video bandwidth, sweep time, detector, trace mode, CS/BS Setup, Nyquist Filter Setup and Limit Line ON/OFF. When <b>Default</b> is enabled, the defaults are automatically set when the spectrum mask is measured.
<b>Manual</b>		Disables the Default function. As a result, the above settings must be set manually. The currently set values are used when the spectrum mask is measured.
<b>Define → Default</b>		The currently set values become the new defaults.
<b>Spectrum Mask OFF</b>		Turns the spectrum mask function off.
<b>Spurious Freq</b>		The spurious table information is displayed after the Spuri Freq menu has been displayed. (The spurious measurement table is not displayed when there is no table data.) When making spurious measurements while in frequency mode, pass/fail judgment is repeated once for each frequency band after the setup conditions have been selected and a maximum of 10 signal peaks have been searched for each frequency band. When this function is used with Average Power measurement, pass/fail judgments for average powers are performed.
<b>Table No. 1/2/3</b>		Sets Table 1,2 or 3.  1: Sets Table 1.  2: Sets Table 2.  3: Sets Table 3.
<b>Edit Table</b>		Displays the Edit Table menu. The editor used for the selected table number is displayed. You can enter the start and stop frequencies, RBW, sweep time and limit level of the frequency band which is used for pass/fail judgment from this editor. A maximum of 15 frequency bands can be set.
<b>Table No. 1/2/3</b>		Sets Table 1,2 or 3.  1: Sets Table 1.  2: Sets Table 2.  3: Sets Table 3.



<i>Insert</i>	Inserts a column at the cursor position.
<i>Delete</i>	Deletes a column at the cursor position.
<i>Table Init</i>	All data is cleared from the table.
<i>Show Result</i>	Displays the Show Result menu and displays the measurement result in full screen mode. The setup conditions and detailed results are displayed for each frequency band.
<i>Prev Result</i>	Displays the previous frequency band result on the screen.
<i>Next Result</i>	Displays the next frequency band result on the screen.
<i>Sweep Count ON/OFF</i>	<p>Toggles the sweep count (used with the Max Hold mode, Min Hold mode, Average function, Power Average function or Average Power measurement) on or off.</p> <p>ON: Allows you to set the sweep count. A pass/fail judgment is performed when the number of sweeps matches the specified sweep count.</p> <hr/> <p><b>NOTE:</b> <i>If Trace mode is set to Write mode, it is automatically changed as shown below according to the Detector setting as shown below:</i></p> <p><i>The Trace mode stays in Write mode if Detector mode is set to Normal.</i></p> <p><i>The Trace mode is changed to Max Hold mode if Detector mode is set to Positive.</i></p> <p><i>The Trace mode is changed to Min Hold mode if Detector mode is set to Negative.</i></p> <p><i>The Trace mode is changed to AVG mode if Detector mode is set to Sample.</i></p> <hr/> <p>OFF: Turns the sweep count off. The Max Hold mode, Min Hold mode, Average function, Power Average function or Average Power measurement is turned off and a pass/fail judgment is performed for each sweep.</p>
<i>PASS Judge UP/LOW</i>	<p>Toggles the pass area between UP and LOW.</p> <p>UP: The area above the limit level is set to Pass.</p> <p>LOW: The area below the limit level is set to Pass.</p>
<i>Spurious Freq OFF</i>	Turns the spurious measurement (in frequency mode) off, and displays the Power menu.

3.3.18 POWER MEASURE Key (Power Measurement)

<i>Spurious Time</i>	<p>The Spuri Time menu and the spurious table information are displayed. (The spurious measurement table is not displayed when there is no table data.)</p> <p>When making spurious measurements while in zero span mode, pass/fail judgment is repeated once for each frequency after the setup conditions have been selected and a maximum of 10 signal peaks have been searched for each frequency. When this function is used with Average Power measurement, pass/fail judgments for average powers are performed.</p>
<i>Table No. 1/2/3</i>	<p>Sets Table 1,2 or 3</p> <p>1: Sets Table 1.</p> <p>2: Sets Table 2.</p> <p>3: Sets Table 3.</p>
<i>Edit Table</i>	<p>Displays the Edit Table menu.</p> <p>The editor of the selected table number is displayed. The frequencies, RBW, sweep time and limit level which are used for pass/fail judgments are entered. A maximum of 15 frequencies can be set.</p>
<i>Table No. 1/2/3</i>	<p>Sets Table 1,2 or 3.</p> <p>1: Sets Table 1.</p> <p>2: Sets Table 2.</p> <p>3: Sets Table 3.</p>
<i>Insert</i>	<p>Inserts the column at the cursor position.</p>
<i>Delete</i>	<p>Deletes the column at the cursor position.</p>
<i>Table Init</i>	<p>All data is cleared from the table.</p>
<i>Show Result</i>	<p>Displays the Show Result menu and displays the measurement result in full screen mode. The setup conditions and detailed results are displayed for each frequency.</p>
<i>Prev Result</i>	<p>Displays the previous frequency result on the screen.</p>
<i>Next Result</i>	<p>Displays the next frequency result on the screen.</p>
<i>Sweep Count ON/OFF</i>	<p>Toggles the sweep count (used with the Max Hold mode, Min Hold mode, Average function, Power Average function or Average Power measurement) on or off.</p>

## 3.3.18 POWER MEASURE Key (Power Measurement)

ON: Allows you to set the sweep count. A pass/fail judgment is performed when the number of sweeps matches the specified sweep count.

---

**NOTE:** *If Trace mode is set to Write mode, it is automatically changed as shown below according to the Detector setting as shown below:*  
*The Trace mode stays in Write mode if Detector mode is set to Normal.*  
*The Trace mode is changed to Max Hold mode if Detector mode is set to Positive.*  
*The Trace mode is changed to Min Hold mode if Detector mode is set to Negative.*  
*The Average Power measurement is started if Detector mode is set to Sample.*

---

OFF: Turns the sweep count off. The Max Hold mode, Min Hold mode, Average function, Power Average function or Average Power measurement is turned off and a pass/fail judgment is performed for each sweep.

***PASS Judge UP/LOW***

Toggles the pass area between UP and LOW.

UP: The area above the limit level is set to Pass.

LOW: The area below the limit level is set to Pass.

***Spurious Time OFF***

Turns the spurious measurement (zero span mode) off, and displays the Power menu.

***Single Measure ON/OFF***

Sets the sweep conditions used in Single Sweep Mode.

ON: Pressing the **SINGLE** key performs the sweep the specified number of measurement times when the channel power, total power, or average power is measured while the average or power average function is turned on. Note that the average and power average functions require the OBW, ACP (FULL, CARRIER), and spectrum mask measurement functions.

OFF: Pressing the **SINGLE** key performs the sweep only once.

***2/2\_more***

Displays the Power menu (1/2).

### 3.3.19 PRESET Key (Initialization)

#### **3.3.19 PRESET Key (Initialization)**

This key is used to reset the spectrum analyzer to its' default settings. This key is accessed by pressing the **SHIFT** key and then the **CONFIG** key. All previous settings are cleared when this is done. (Note there is no menu associated with this panel key.)

### 3.3.20 RECALL Key (Data Readout)

This section describes the menu displayed when the **RECALL** key is pressed.

*Recall* Reads out the data from a file selected from the file list.

*List ON/OFF* Toggles the file list display on or off.

ON: Displays the file list.

OFF: Turns off the file list display.

*Device RAM/FD* Selects a source for the data.

RAM: Reads out the data from internal memory.

FD: Reads out the data from a floppy disk.

### 3.3.21 REPEAT Key (Continuous Sweep)

#### **3.3.21 REPEAT Key (Continuous Sweep)**

Pressing this key activates the continuous sweep mode.

If this key is pressed during a sweep, the sweep is paused and the sweep lamp is turned off. Pressing the **REPEAT** key again causes the analyzer to wait for another sweep to start and then the sweep lamp turns back on. The sweep will start after a signal is received (which in turn depends on the current trigger mode setting). (Note there is no menu associated with this panel key.)

### 3.3.22 SAVE Key (Saving Data)

This section describes the menu displayed when the **SHIFT** key and the **RECALL(SAVE)** key are pressed.

**Save**

Saves the data selected by *Save Item* to the file selected in the file list.

**Save Item**

Displays the Save Item Setup dialog box.

Save Item Setup			
Setup:	OFF	ON	
Trace:	OFF	ON	
Ant Corr:	OFF	ON	
Norm Corr:	OFF	ON	
Limit Line:	OFF	1	2 1/2
Loss:Freq:	OFF	ON	
Trace Level:	OFF	ON	
Channel:	OFF	ON	
Spurious:	OFF	ON	

**Setup**

Sets whether or not this function is turned on.

ON: Saves the setup conditions.

OFF: Does not save the setup conditions.

**Trace**

Sets whether or not this function is turned on.

ON: Saves the trace data.

OFF: Does not save the trace data.

**Ant Corr**

Sets whether or not this function is turned on.

ON: Saves the correction data.

OFF: Does not save the correction data.

**Norm Corr**

Sets whether or not this function is turned on. (if OPT74 is included).

ON: Saves the normalized data.

OFF: Does not save the normalized data.

3.3.22 SAVE Key (Saving Data)

<i>Limit Line</i>	Used to control how Limit Line conditions are saved.
	OFF: Does not save the current values.
	1: Saves the current values for Limit Line 1.
	2: Saves the current values for Limit Line 2.
	1/2: Saves the current values for both Limit Line 1 and 2.
<i>Loss:Freq</i>	Selects whether or not the data in the external mixer frequency-loss table is saved (Only for OPT 16 thru OPT 19).
	ON: Saves the contents of the external mixer frequency-loss table.
	OFF: Does not save the contents of the external mixer frequency-loss table.
<i>Trace Level</i>	Sets whether or not this function is turned on.
	ON: Stores the trace data level (at the present level).
	OFF: Does not store the trace data level.
<i>Channel</i>	Sets whether or not this function is turned on.
	ON: Saves the set values used in Channel Type 1 and 2.
	OFF: Does not save the set values used in Channel Type 1 and 2.
<i>Spurious</i>	Sets whether or not this function is turned on.
	ON: Saves the table data (Freq/Time).
	OFF: Does not save the table data (Freq/Time).
<i>Protect</i>	Enables the write protect for the file selected in the file list.
<i>Delete</i>	Removes the selected file from the file list.
<i>Rename</i>	Changes the name of the file selected from the file list.
<i>Change Title</i>	Changes the title on the screen.
<i>Device RAM/FD</i>	Selects the location used to store the data.
	RAM: Stores the data in internal memory.
	FD: Stores the data on the floppy disk in the disk drive.



### 3.3.23 Self Test Key (Self Test)

Pressing **SHIFT** and **0(Self Test)** activates the self test mode, and displays the Self Test menu.

---

**NOTE:** *In Self Test mode, all soft menus and panel keys except for those displayed in the soft menu, and the SHIFT, PRESET and COPY keys are disabled.*

---

#### *Execute Self Test*

Five test items are displayed in SELF TEST RESULTS window, and are tested in order.

As each test is completed, PASS or FAIL and Completed are displayed on the screen. After all test items have been completed, The self test ends.

---

**CAUTION:** *If FAIL appears for any test item, Contact an ADVANTEST service representative for repair. The address and telephone are found at the end of this manual.*

---

#### *Exit*

Exits the self test mode.

### 3.3.24 SINGLE Key (Single Sweep)

#### **3.3.24 SINGLE Key (Single Sweep)**

If this key is pressed during a sweep, the sweep is paused and the sweep lamp is turned off. Pressing the **SINGLE** key again causes the analyzer to wait until a sweep starts again (which in turn depends on when it receives a signal). This is controlled by the trigger mode setting. When the channel power measurement, total power measurement, average power measurement, average function, or power average function is performed while "Single Measure ON" is set, the sweep is performed the specified number of times. (Note there is no menu associated with this panel key.)

### 3.3.25 SPAN Key (Frequency Span)

When pressed, this key displays the Span menu, and allows you to set a frequency span. In addition, the center frequency and frequency span are displayed in the annotation area below the bottom scale line.

*Full Span*

Sets the frequency span to the full span.

*Zero Span*

Set a zero span at the center frequency. In zero span mode, the frequency span is 0 Hz, and the spectrum analyzer operates as a tuned receiver. The horizontal axis is the time axis. The receiving bandwidth is determined according to the selected resolution bandwidth.

*Peak Zoom*

Moves the marker to the maximum peak within the search object range, and sets the marker frequency as the center frequency. In addition, the frequency span is changed to 1/10 of the current frequency span.

*Last Span*

Resets the frequency span to the previous value.

3.3.26 SWEEP Key (Sweep Time)

**3.3.26 SWEEP Key (Sweep Time)**

Pressing the **SWEEP** key displays the SWEEP menu.  
MNL allows you to specify a sweep time.

**SWP Time AUTO/MNL**

Toggles the sweep time between AUTO and MNL.

**AUTO:** Automatically sets the optimum sweep time according to the span, resolution bandwidth and video bandwidth.

**MNL:** Sets the sweep time manually.

---

**NOTE:** When the sweep time is equal to or less than 9 ms, the trace point is set to 501, and the detector is set to the sample detection mode (OPT29).

---

**Auto All**

Automatically sets the resolution bandwidth, video bandwidth and sweep time according to the span settings.

**Trig Delay**

Sets the delay time in reference to the trigger point or sets the pre-trigger time.  
This is available only when the zero span is selected.

**Gated Sweep**

Displays the Gated Sweep menu and two windows.  
The upper screen displays the result of gated sweep, while the lower screen displays a gate signal, the gate position and width.

**Gate Source**

Displays the Gated Source menu.  
The trigger conditions for a gate signal in the gated sweep mode can be set.

**Ext**

Sweep is synchronized with external trigger signals.

**TV-V**

Sweep is synchronized with vertical synchronous signals of TV signals.

**TV-H**

Sweep is synchronized with horizontal synchronous signals of TV signals.

**Slope (TV Polarity) +/-**

Switches polarities between + and - for the trigger slope or video modulation of TV signals.

**+:** Sweep is started at the rise of a trigger.  
In the TV trigger mode, sweep is started synchronously with a video modulation signal of + polarity.

**-:** Sweep is started at the fall of a trigger.  
In the TV trigger mode, sweep is started synchronously with a video modulation signal of - polarity.

---

<i>Gate Position</i>	Sets the position of a gate signal.
<i>Gate Width</i>	Sets the width of a gate signal.
<i>Gated Sweep ON/OFF</i>	Turns the gated sweep mode on or off.  ON: Sweep is executed according to the currently set gate conditions (gate position and width).  OFF: Turns the gated sweep mode off.
<i>Screen A/B</i>	Toggles the active screen between A and B.  A: The upper screen is set to the active state.  B: The lower screen is set to the active state.
<i>Gate Setup Quit</i>	The trigger condition setup screen of gate signals is released to return to the Sweep menu.
<i>Gated Sweep ON/OFF</i>	Turns the gated sweep mode on or off.  ON: Sweep is executed according to the currently set gate conditions (gate position and width).  OFF: Turns the gated sweep mode off.
<i>Ext Gate In ON/OFF</i>	Changes the input signal at the External Trigger connector.  ON: Performs a gated sweep using the External Trigger connector signal as the gate signal. Sweeps intermittently when the signal level is greater than approximately 2.5V, and stops sweeping when the signal level is approximately less than 2.5V.  OFF: Performs a normal sweep. Uses the input signal at the External Trigger connector as the trigger signal for the Ext Trig mode.

## 3.3.27 TG Key (Tracking Generator) (OPT74)

**3.3.27 TG Key (Tracking Generator) (OPT74)**

This section describes the TG menu which is displayed when the tracking generator is turned on.

---

**CAUTION**    *Do not apply voltages that exceed (10 V or power that exceeds + 15 dBm to the TG OUTPUT connector, or you may damage this instrument.*

---

***TG Level***                      Allows you to set tracking generator's output level.

***Execute Normalize***              Pressing this key causes the following to occur:

1.    Displays the reference line at the midpoint between the maximum and minimum level points which are currently displayed.  
       The reference line position cannot be changed if it was displayed by previous operation.
2.    The current trace is saved in the memory as correction data.
3.    The normalization calibration function is activated.  
       Only trace A is normalized.

---

**CAUTION:**    *Make sure TG OUTPUT is connected to RF INPUT1 before executing the above normalization calibration.*

---

***Norm Corr ON/OFF***              Toggles the normalization function on or off.

ON:        Executes a normalization using the correction data saved in the memory.

OFF:        Disables the normalization function.

***Ref Line***                         Allows you to change the position of the reference line.

***Freq Adj Auto***                    For each RBW, the compensation value for tracking generator's output frequency is obtained to prevent the tracking error (a kind of level error caused by the difference in displacement between tracking generator's output frequency and spectrum analyzer's tuning frequency).

---

**CAUTION:**    *Make sure TG OUTPUT is connected to RF INPUT1 before executing the above normalization calibration.*

---

***Freq Adj Manual***                 For the current RBW, the compensation value for tracking generator's output frequency is set.

***TG OFF***                             Turns the tracking generator off.

### 3.3.28 TRACE Key (Trace Data)

This section describes Trace A(B) menu (1/2) displayed when the **TRACE** key is pressed.

<i>Write A(B)</i>	Sets the Write mode which updates the data in the A(B) memory for each sweep.
<i>View A(B)</i>	Sets the View mode which holds the data in the A(B) memory.
<i>Blank A(B)</i>	Sets the Blank mode which erases the trace.
<i>Max Hold A(B)</i>	Executes the Max Hold mode which displays the maximum value for each trace sample (when you select the Max Hold mode, the positive mode is automatically selected. Refer to Posi.)
<i>Detector</i>	Displays the Trc Det A(B) menu from which you can set the detection mode used.
<i>Normal</i>	Sets the normal mode which automatically detects positive or negative peak points for each trace point.
<i>Posi</i>	Sets the positive peak mode (when you select the Max Hold mode, the positive mode is automatically selected. Refer to Max Hold A(B).)
<i>Nega</i>	Sets the negative peak mode (when you select the Min Hold mode, the negative mode is automatically selected. Refer to Min Hold A(B).)
<i>Sample</i>	Sets the sample mode.
<i>Trc Menu A/B</i>	Toggles between trace A and trace B.
<i>1/2_more</i>	Displays the Trace A(B) menu (2/2).
<i>AVG A(B)</i>	Displays the AVG A(B) menu.
<i>AVG A(B) ON/OFF</i>	Toggles the averaging function on or off.  ON: Turns averaging on.  OFF: Turns averaging off.
<i>Average PSE/CONT</i>	Toggles between PSE (pause) and CONT (continue) while the averaging function is being used.  PSE: Temporarily pauses averaging and displays the current averaging count.  CONT: Resumes averaging from the point at which the pause occurred.

3.3.28 TRACE Key (Trace Data)

*Average CONT/SGL*

Toggles between CONT (continuation) and SGL (single) modes.

CONT: Continues to average using the current data which is used until the set averaging count is reached.

SGL: Automatically switches to View mode as soon as the desired averaging count has been reached.  
When combining this function with OBW, ACP or Spectrum Mask measurement, perform the averaging process the number of times specified by this function before making the OBW or ACP measurement.

*Single Measure ON/OFF*

Sets the sweep conditions used in Single Sweep Mode.

ON: Pressing the **SINGLE** key performs the sweep the specified number of measurement times when the channel power, total power, or average power is measured while the average or power average function is turned on.  
Note that the average and power average functions require the OBW, ACP (FULL, CARRIER), and spectrum mask measurement functions.

OFF: Pressing the **SINGLE** key performs the sweep only once.

*Power AVG A(B)*

Displays the Power AVG A(B) menu.

*Power AVG A(B) ON/OFF*

Toggles the power averaging function on or off.  
The power averaging function is used to average the power in each frequency using the equation below and display the averaged power.

$$P_{AVG} = 10 \log \left[ \frac{1}{n} \times 10^{\left(\frac{P_{in}}{10}\right)} \right]$$

$P_{AVG}$ : Averaged power for each frequency

$P_{in}$ : Power in the nth sweep cycle  
(for each of up to 1001 frequency points)

$n$ : Number of sweep cycles

ON: Turns the power averaging function on.

OFF: Turns the power averaging function off.

*Average PSE/CONT*

Toggles between PSE (pause) and CONT (continue) while the power averaging function is being used.

PSE: Temporarily pauses averaging and displays the current averaging count.

CONT: Resumes averaging from the point at which the pause occurred.



<i>Average CONT/SGL</i>	<p>Toggles between CONT (continuation) and SGL (single) modes.</p> <p>CONT: Continues to average using the current data which is used until the set averaging count is reached.</p> <p>SGL: Automatically switches to View mode as soon as the desired averaging count has been reached. When combining this function with OBW, ACP or Spectrum Mask measurement, perform the averaging process the number of times specified by this function before making the OBW or ACP measurement.</p>
<i>Single Measure ON/OFF</i>	<p>Sets the sweep conditions used in Single Sweep Mode.</p> <p>ON: Pressing the <b>SINGLE</b> key performs the sweep the specified number of measurement times when the channel power, total power, or average power is measured while the average or power average function is turned on. Note that the average and power average functions require the OBW, ACP (FULL, CARRIER), and spectrum mask measurement functions.</p> <p>OFF: Pressing the <b>SINGLE</b> key performs the sweep only once.</p>
<i>Min Hold A(B)</i>	<p>Sets the Min Hold mode which is used to display the minimum value for each trace sample (when you select the Min Hold mode, the negative mode is automatically selected. Refer to Nega.)</p>
<i>Store A(B) to B(A)</i>	<p>Stores trace A(B) data as trace B(A).</p>
<i>Math A</i>	<p>Displays the Math A menu.</p>
<i>A-B → A</i>	<p>A: When trace A is in the Write mode, the contents of memory B are subtracted from the sweep result and, then, the result is saved in memory A. When the Display line is active, the Display line value is added to the value obtained previously and saved to A (<math>A - B + DL \rightarrow A</math>).</p>
<i>B-A → A</i>	<p>A: When trace A is in the Write mode, the sweep result is subtracted from the contents of memory B and, then, the result is saved in memory A. When the Display line is active, the Display line value is added to the value obtained previously and saved to A (<math>B - A + DL \rightarrow A</math>).</p>
<i>A-DL → A</i>	<p>A: When trace A is in the Write mode, the level of the display line is subtracted from the sweep result and, then, the result is saved in memory A.</p>
<i>Disp Line ON/OFF</i>	<p>Turns the display line, which is used as the reference line for comparing the trace level, on or off.</p>

3.3.28 TRACE Key (Trace Data)

ON: The display line is displayed. The display line position can be changed.

OFF: The display line is erased.

*Trc Menu A/B*

Toggles between trace A and trace B.

*2/2\_more*

Returns to the Trace A(B) menu (1/2).

### 3.3.29 TRIG Key (Trigger)

This section describes the menu displayed when the **TRIG** key is pressed.

<i>Trig Source</i>	Displays the Trig Source menu which is used to set trigger conditions.
<i>Free Run</i>	Sweep is repeated automatically.
<i>Line</i>	Sweep is executed synchronously with AC power supply.
<i>TV-V</i>	Sweep is executed synchronously with vertical synchronous signals of TV signals.
<i>TV-H</i>	Sweep is executed synchronously with horizontal synchronous signals of TV signals.
<i>Video Trig</i>	Sweep is executed synchronously with video signals.
<i>Ext Trig</i>	Sweep is executed synchronously with external trigger signals. Trigger level: 0 to + 5V
• When the OPT73, FM Demodulation function, is turned on, pressing the <b>TRIG</b> key displays the Trigger menu.	
<i>Free Run</i>	Sweep is repeated automatically.
<i>Line</i>	Sweep is executed synchronously with AC power supply.
<i>Video Trig</i>	Sweep is executed synchronously with video signals.
<i>Ext Trig</i>	Sweep is executed synchronously with external trigger signals. Trigger level: 0 to + 5V
<i>Slope +/-</i>	Switches between + and - of the polarity for the trigger slope.
<i>Trig Delay</i>	Sets the delay time in reference to the trigger point or sets the pre-trigger time. This is available only when the zero span is selected.
<i>Slope (TV Polarity) +/-</i>	Switches polarities between + and - for the trigger slope or video modulation of TV signals.
+	Sweep is started at the rise of a trigger. In the TV trigger mode, sweep is started synchronously with a video modulation signal of + polarity.
-	Sweep is started at the fall of a trigger. In the TV trigger mode, sweep is started synchronously with a video modulation signal of - polarity.

### 3.3.29 TRIG Key (Trigger)

***TV Sys NTSC/PAL&SECAM***

Switches the video modulation system between NTSC and PAL&SECAM.

NTSC: Selects the NTSC system for TV signals.

PAL&SECAM:

Selects the PAL&SECAM system for TV signals.

**3.3.30 UTILITY Key (Utility)**

<i>FM Demod</i>	Displays the FM Demod menu used in the FM demodulation mode.
<i>Range</i>	Used to switch the frequency range along the vertical axis.
<i>Deviation</i>	Displays the Deviation menu, deviation of an FM demodulated signal, positive peak deviation, negative peak deviation, and repetition frequency.
<i>Peak Delta Y</i>	Sets peak detection measurement conditions when a deviation is measured.
<i>Deviation OFF</i>	Turns the deviation measurement function off.
<i>Sensitivity</i>	Displays the Sensitivity menu, differentiates a demodulated FM signal with respect to time, and displays the differential value.
<i>Sens Range</i>	Magnifies the curve consisting of differential values in up to four positions, each of which must use any number(s) from 1, 2 and 5.
<i>Aperture %</i>	Sets the section (%) along the horizontal axis to calculate a differential value. The entire range is defined as 100%.
<i>Sensitivity OFF</i>	Turns the differential value display off.
<i>Linearity</i>	Displays the Linearity menu, and then switches to Separate Screen Mode. The reference line is displayed in the lower part of the screen.
<i>Auto Adj</i>	Automatically calculates the reference line of a demodulated FM signal using the least-square method.
<i>Sample Points</i>	Sets the number of points for the calculation using the least-square method.
<i>Offset Adj</i>	Sets the offset value of the reference line.
<i>Slope Adj</i>	Sets the inclination of the reference line.
<i>Linearity ON/OFF</i>	ON: Displays the maximum and minimum errors between a trace and the reference line. OFF: Turns off the error display between a trace and the reference line.
<i>Screen A/B</i>	Toggles the active screen between A and B.
<i>Lin Setup Quit</i>	Quits from the Linearity Setting screen.

3.3.30 UTILITY Key (Utility)

<i>Linearity ON/OFF</i>	ON:	Displays the maximum and minimum errors between a trace and the reference line.
	OFF:	Turns off the error display between a trace and the reference line.
<i>Demod Cal</i>		Displays the Demod Cal menu.
<i>All</i>		Performs calibrations for all of the frequency ranges.
<i>Range Only</i>		Performs the calibrations for the ranges currently set.
<i>FM Demod OFF</i>		Turns the FM demodulation display off.

### 3.4 List of Settings

#### 3.4.1 Factory Defaults

The table below lists the factory defaults (for both the analyzer parameters and settings). These values are used when the **SHIFT** and **CONFIG(PRESET)** keys are pressed.

**Table 3-1 Factory Defaults (R3132/N)**

Parameter	Factory defaults
Center frequency	1.5GHz
Frequency span	3GHz
Reference level	0dBm (R3132), 108.8dB $\mu$ V (R3132N)
Sweep time	AUTO      20ms
Resolution bandwidth (RBW)	AUTO      3MHz
Video bandwidth (VBW)	AUTO      3MHz
Input attenuator	AUTO      10dB
Trigger mode	Free Run
Trace mode	A Write      B Blank
Detector mode	A Normal      B Normal
Marker	OFF
Line	OFF
Window	OFF
Title function	OFF
Vertical graduation	10dB/div

3.4.1 Factory Defaults

**Table 3-2 Factory Defaults (R3162)**

Parameter	Factory defaults	
Center frequency	4GHz	
Frequency span	8GHz	
Reference level	0dBm	
Sweep time	AUTO	120ms
Resolution bandwidth (RBW)	AUTO	3MHz
Video bandwidth (VBW)	AUTO	3MHz
Input attenuator	AUTO	10dB
Trigger mode	Free Run	
Trace mode	A Write	B Blank
Detector mode	A Normal	B Normal
Marker	OFF	
Line	OFF	
Window	OFF	
Title function	OFF	
Vertical graduation	10dB/div	



**Table 3-3 Factory Defaults (R3172)**

Parameter	Factory defaults
Center frequency	13.25GHz
Frequency span	26.5GHz
Reference level	0dBm
Sweep time	AUTO      400ms
Resolution bandwidth (RBW)	AUTO      3MHz
Video bandwidth (VBW)	AUTO      3MHz
Input attenuator	AUTO      10dB
Trigger mode	Free Run
Trace mode	A Write      B Blank
Detector mode	A Normal      B Normal
Marker	OFF
Line	OFF
Window	OFF
Title function	OFF
Vertical graduation	10dB/div

3.4.1 Factory Defaults

**Table 3-4 Factory Defaults (R3182)**

Parameter	Factory defaults
Center frequency	20GHz
Frequency span	40GHz
Reference level	0dBm
Sweep time	AUTO      600ms
Resolution bandwidth (RBW)	AUTO      3MHz
Video bandwidth (VBW)	AUTO      3MHz
Input attenuator	AUTO      10dB
Trigger mode	Free Run
Trace mode	A Write      B Blank
Detector mode	A Normal      B Normal
Marker	OFF
Line	OFF
Window	OFF
Title function	OFF
Vertical graduation	10dB/div

### 3.4.2 Defaults Configuration Values

These are the default settings used when the *Default Config* softkey is pressed.

**Table 3-5 Values for Default Config**

Parameter	Default Setting
Copy destination setting	Printer
Printer type	PCL
Screen output mode	COLOR
Menu output	ON
Paper Feed	ON
Bitmap output mode	COLOR
Bitmap compression mode	OFF
Automatic file number increment	ON
Bitmap file number	0
GPIB address	8
Baud rate	9600bps
Data length	8
Stop bit length	1
Parity bit type	None
XON/XOFF signal output	ON
Date display mode	LONG
Date format	Year/month/date
Screen color	Color 1
Reverse video	OFF



## 4 REMOTE PROGRAMING

### 4.1 GPIB Command Index

This GPIB command index can be used as the index for Chapter 4.

GPIB Command	Pages	GPIB Command	Pages
-	4-48	ACPST USR	4-39
%	4-48	ADG [ON]	4-39
*CLS	4-45	ADG OFF	4-39
*ESE	4-45	ADLA	4-28
*ESR	4-45	AF	4-41
*IDN	4-46	AG	4-28
*RST	4-44	AGC	4-28
*SRE	4-45	AGCNT	4-28
*STB	4-45	AGL	4-24
*TST	4-45	AGL OFF	4-24
+	4-48	AGL ON	4-24
.	4-48	AGP	4-28
0	4-48	AGR	4-28
1	4-48	AGS	4-28
2	4-48	AGSGL	4-28
3	4-48	AL	4-25
4	4-48	AMAX OFF	4-28
5	4-48	AMAX ON	4-28
6	4-48	AMIN OFF	4-28
7	4-48	AMIN ON	4-28
8	4-48	AMMOD [ON]	4-35
9	4-48	AMMOD OFF	4-35
AA	4-25	AN0	4-41
AAVG OFF	4-28	AN1	4-41
AAVG ON	4-28	AN2	4-41
AB	4-28	AN3	4-41
ABA	4-28	AN4	4-41
ACP	4-39	ANNOT OFF	4-46
ACP [ON]	4-39	ANNOT ON	4-46
ACP OFF	4-39	ANORM OFF	4-47
ACPBSW OFF	4-39	ANORM ON	4-47
ACPBSW ON	4-39	ANT OFF	4-41
ACPEXE	4-39	ANT0	4-41
ACPREF	4-39	ANT1	4-41
ACPSCR CARR	4-39	ANT2	4-41
ACPSCR FULL	4-39	ANT3	4-41
ACPSCR SEPA	4-39	ANT4	4-41
ACPST DEF	4-39	APAVG OFF	4-28
ACPST MNL	4-39	APAVG ON	4-28

## 4.1 GPIB Command Index

AR.....	4-47	CHTBL1 ENBL.....	4-23
AS.....	4-26	CHTBL2 DSBL.....	4-23
ASTORE.....	4-29	CHTBL2 ENBL.....	4-23
AT.....	4-25	CHTBL3 DSBL.....	4-23
AUNITS DBM.....	4-25	CHTBL3 ENBL.....	4-23
AUNITS DBMV.....	4-25	CLALL.....	4-42
AUNITS DBUV.....	4-25	CLCREF.....	4-42
AUNITS V.....	4-25	CLDREF.....	4-42
AUNITS W.....	4-25	CLFREF.....	4-42
AV.....	4-28	CLGAIN.....	4-42
AW.....	4-28	CLLOG.....	4-42
BA.....	4-25	CLMAG.....	4-42
BAA.....	4-28	CLN.....	4-42
BAVG OFF.....	4-29	CLPBW.....	4-42
BAVG ON.....	4-29	CLRBW.....	4-42
BB.....	4-28	CLSREF.....	4-42
BG.....	4-29	CLSTEP.....	4-42
BGC.....	4-29	CN0.....	4-38
BGCNT.....	4-29	CN1.....	4-38
BGP.....	4-29	CN2.....	4-38
BGR.....	4-29	CN3.....	4-38
BGS.....	4-29	CNAVG.....	4-36
BGSGL.....	4-29	CNAVG [ON,].....	4-36
BMAX OFF.....	4-28	CNAVG OFF.....	4-36
BMAX ON.....	4-28	CNIS.....	4-36
BMIN OFF.....	4-29	CNIS OFF.....	4-36
BMIN ON.....	4-29	CNIS ON.....	4-36
BMP.....	4-44	CNOFSDEL.....	4-36
BND.....	4-23	CNOFSIN.....	4-36
BNDLC OFF.....	4-23	CNRES.....	4-38
BNDLC ON.....	4-23	CNSIG OFF.....	4-36
BPAVG OFF.....	4-29	CNSIG ON.....	4-36
BPAVG ON.....	4-29	CONTS.....	4-26
BSTORE.....	4-29	COUNT OFF.....	4-38
BV.....	4-28	COUNT ON.....	4-38
BW.....	4-28	CP OFF.....	4-32
CA.....	4-22	CP ON.....	4-32
CARRBS.....	4-39	CPLMK [ON].....	4-32
CC OFF.....	4-42	CPLMK OFF.....	4-32
CC ON.....	4-42	CR ANT.....	4-41
CDB OFF.....	4-35	CR LVL.....	4-41
CDB ON.....	4-35	CR OFF.....	4-41
CF.....	4-22	CR ON.....	4-41
CFCH.....	4-23	CRDEL.....	4-41
CH.....	4-23	CRIN.....	4-41
CHED1.....	4-23	CS.....	4-22
CHED2.....	4-23	CSBSDEL.....	4-39
CHED3.....	4-23	CSBSIN.....	4-39
CHEDDEL.....	4-23	DB.....	4-48
CHEDIN.....	4-23	DC0.....	4-35
CHTBL1 DSBL.....	4-23	DC1.....	4-35

DC2.....	4-35	FMLA.....	4-47
DD.....	4-25	FMLIN OFF.....	4-47
DEL.....	4-43	FMLIN ON.....	4-47
DELn.....	4-43	FMLMAX.....	4-47
DET.....	4-29	FMLMD OFF.....	4-47
DET NEG.....	4-29	FMLMD ON.....	4-47
DET NRM.....	4-29	FMLMIN.....	4-47
DET POS.....	4-29	FMLOFS.....	4-47
DET SMP.....	4-29	FMLSLP.....	4-47
DETB.....	4-29	FMLSMP.....	4-47
DETB NEG.....	4-29	FMMEAS.....	4-35
DETB NRM.....	4-29	FMMEAS [ON].....	4-35
DETB POS.....	4-29	FMMEAS OFF.....	4-35
DETB SMP.....	4-29	FMMODF.....	4-35
DL.....	4-31	FMMODFON.....	4-35
DL OFF.....	4-31	FMNPK.....	4-47
DL ON.....	4-31	FMONLY.....	4-47
DL0.....	4-45	FMPPK.....	4-47
DL1.....	4-45	FMRNG.....	4-46
DL2.....	4-45	FMRPF.....	4-47
DL3.....	4-45	FMSEN OFF.....	4-46
DL4.....	4-45	FMSEN ON.....	4-46
DS.....	4-34	FMSRNG.....	4-47
DY.....	4-33	FMSRNGS.....	4-47
E.....	4-48	FMSUN.....	4-46
EMCDET NRM.....	4-41	FO [ON,].....	4-22
EMCDET PEAK.....	4-41	FO OFF.....	4-22
EMCDET QP.....	4-41	FPL.....	4-30
ENT.....	4-48	FPU.....	4-30
ERRNO.....	4-46	FS.....	4-22
EX.....	4-27	FX.....	4-32
EXP.....	4-48	FX OFF.....	4-32
FA.....	4-22	FX ON.....	4-32
FACH.....	4-23	GEX OFF.....	4-26
FACHO.....	4-23	GEX ON.....	4-26
FB.....	4-22	GTEX.....	4-26
FBCH.....	4-23	GTPOS.....	4-26
FBCHO.....	4-23	GTSLP -.....	4-26
FC OFF.....	4-42	GTSLP +.....	4-26
FC ON.....	4-42	GTSLP FALL.....	4-26
FINPMD CH1.....	4-23	GTSLP RISE.....	4-26
FINPMD CH2.....	4-23	GTSRC.....	4-26
FINPMD FREQ.....	4-23	GTSRC EXT.....	4-26
FMALL.....	4-47	GTSRC TVH.....	4-26
FMAPR.....	4-47	GTSRC TVV.....	4-26
FMAVG.....	4-47	GTSWP OFF.....	4-26
FMDEM OFF.....	4-46	GTSWP ON.....	4-26
FMDEM ON.....	4-46	GTTVH.....	4-26
FMDEV.....	4-47	GTWID.....	4-26
FMDEV OFF.....	4-47	GZ.....	4-48
FMDEV ON.....	4-47	HCCMPRS OFF.....	4-44

## 4.1 GPIB Command Index

HCCMPRS ON .....	4-44	LMTB OFF .....	4-30
HCDEV FDD .....	4-44	LMTB ON .....	4-30
HCDEV PRT .....	4-44	LMTBDEL .....	4-30
HCFILE .....	4-44	LMTBIN .....	4-30
HCIMAG COL .....	4-44	LOF .....	4-44
HCIMAG GRY .....	4-44	LON .....	4-44
HCIMAG MON .....	4-44	LS .....	4-22
HCIMAG SCOL .....	4-44	LTSP .....	4-22
HCOPY .....	4-44	LVF OFF .....	4-24
HS OFF .....	4-25	LVF ON .....	4-24
HS[ON] .....	4-25	LVFDEL .....	4-24
HZ .....	4-48	LVFIN .....	4-24
IMAVG .....	4-37	M0 .....	4-34
IMAVG [ON,] .....	4-37	M1 .....	4-34
IMAVG OFF .....	4-37	M2 .....	4-34
IMGSP OFF .....	4-23	M3 .....	4-34
IMGSP ON .....	4-23	MA .....	4-48
IMHS OFF .....	4-37	MC .....	4-34
IMHS ON .....	4-37	MDF1 .....	4-32
IMLS3 .....	4-37	MDF2 .....	4-32
IMLS5 .....	4-37	MDL1 .....	4-32
IMLS7 .....	4-37	MDL2 .....	4-32
IMLS9 .....	4-37	MF .....	4-32
IMM OFF .....	4-37	MFL .....	4-32
IMM ON .....	4-37	MIS .....	4-32
IMMDF .....	4-37	MK .....	4-32, 4-33
IMMREF .....	4-37	MKBW .....	4-35
IMMRES .....	4-37	MKCF .....	4-34
IMODR .....	4-37	MKCS .....	4-34
IMPFC OFF .....	4-37	MKD .....	4-32
IMPFC ON .....	4-37	MKMKS .....	4-34
IP .....	4-44	MKN .....	4-32, 4-33
KZ .....	4-48	MKOFF .....	4-32
LIMAPOS ABS .....	4-30	MKRL .....	4-34
LIMAPOS BOTM .....	4-30	MKTRACE TRA .....	4-32
LIMAPOS CENT .....	4-30	MKTRACE TRB .....	4-32
LIMAPOS REL .....	4-30	ML .....	4-32
LIMAPOS TOP .....	4-30	MLF1 .....	4-33
LIMASFT .....	4-30	MLF10 .....	4-33
LIMPOS ABS .....	4-30	MLF2 .....	4-33
LIMPOS CENT .....	4-30	MLF3 .....	4-33
LIMPOS LFT .....	4-30	MLF4 .....	4-33
LIMPOS REL .....	4-30	MLF5 .....	4-33
LIMSFT .....	4-30	MLF6 .....	4-33
LIMTYP FREQ .....	4-30	MLF7 .....	4-33
LIMTYP TIME .....	4-30	MLF8 .....	4-33
LL1 .....	4-25	MLF9 .....	4-33
LMTA OFF .....	4-30	MLN1 .....	4-33
LMTA ON .....	4-30	MLN10 .....	4-33
LMTADEL .....	4-30	MLN2 .....	4-33
LMTAIN .....	4-30	MLN3 .....	4-33



MLN4.....	4-33	OHM50 .....	4-25
MLN5.....	4-33	OHM75 .....	4-25
MLN6.....	4-33	OBW .....	4-38
MLN7.....	4-33	SPM .....	4-39
MLN8.....	4-33	OPF .....	4-30
MLN9.....	4-33	OPR.....	4-45
MLT OFF.....	4-33	OPREVT.....	4-45
MLT ON .....	4-33	PER .....	4-48
MLTSCR FT.....	4-31	PFC OFF.....	4-30
MLTSCR OFF.....	4-31	PFC ON.....	4-30
MLTSCR TT.....	4-31	PFEED OFF.....	4-44
MLTSCR ZM.....	4-31	PFEED ON.....	4-44
MMS .....	4-32	PFJ .....	4-30
MN.....	4-32, 4-33	PJAVG [ON,].....	4-36
MO.....	4-32	PJAVG OFF.....	4-36
MPA.....	4-32	PJIT.....	4-36
MPM .....	4-32	PJIT OFF.....	4-36
MR .....	4-34	PJIT ON .....	4-36
MS.....	4-48	PJSIG OFF.....	4-36
MSEC.....	4-48	PJSIG ON .....	4-36
MTCF.....	4-34	PJSRTO .....	4-36
MTCS.....	4-34	PJSTPO .....	4-36
MTMKS.....	4-34	PKCF .....	4-34
MTSP.....	4-34	PKLST .....	4-33
MV .....	4-48	PKRL .....	4-34
MW .....	4-48	PKTHIRD.....	4-35
MXE.....	4-23	PKZOOM.....	4-22
MXI.....	4-23	PLS FREQ .....	4-33
MZ .....	4-48	PLS LEVEL.....	4-33
NT .....	4-35	PLS OFF .....	4-33
NIC.....	4-35	PPA .....	4-22
NIF.....	4-35	PPM .....	4-22
NIM.....	4-35	PRT COL .....	4-44
NIU .....	4-35	PRT GRY.....	4-44
NORM EX.....	4-47	PRT MOL.....	4-44
NORM OFF.....	4-47	PRT MOS .....	4-44
NORM ON.....	4-47	PRT SCOLL.....	4-44
NQST OFF.....	4-39	PRT SCOLS.....	4-44
NQST ON .....	4-39	PRTCMD ESC.....	4-44
NSEC .....	4-48	PRTCMD ESCR.....	4-44
NV.....	4-48	PRTCMD PCL.....	4-44
NXL .....	4-32	PS .....	4-32
NXP .....	4-32	PSL.....	4-33
NXR.....	4-32	PSN .....	4-33
OBW .....	4-38	PSU .....	4-33
OBW OFF.....	4-38	PU .....	4-35
OBWEXE .....	4-38	PWAVG.....	4-38
OBWPER.....	4-38	PWCH.....	4-38
OBWST DEF.....	4-39	PWCHST DEF.....	4-38
OBWST MNL.....	4-39	PWCHST MNL .....	4-38
OBWST USR.....	4-39	PWCHST USR .....	4-38

4.1 GPIB Command Index

PWM.....	4-38	SPMST DEF .....	4-39
PWTM .....	4-38	SPMST MNL.....	4-39
PWTOTAL .....	4-38	SPMST USR.....	4-39
QA.....	4-41	SPRCNT [ON,].....	4-40
QP0 .....	4-41	SPRCNT OFF.....	4-40
QP1 .....	4-41	SPRDEL.....	4-40
QP2 .....	4-41	SPRFIN.....	4-40
QP3 .....	4-41	SPRIN .....	4-40
QPAUTO .....	4-41	SPRJ LOW.....	4-40
RB .....	4-25	SPRJ UP.....	4-40
RC .....	4-43	SPRTBL.....	4-40
RCn .....	4-43	SPRTIN.....	4-40
RFACT.....	4-39	SPURI .....	4-40
RFE .....	4-44	SPURI FREQ.....	4-40
RFI .....	4-44	SPURI OFF.....	4-40
RL .....	4-25	SPURI TIME .....	4-40
RLN .....	4-31	SQE [ON,] .....	4-35
RLN OFF .....	4-31	SQE OFF.....	4-35
RLN ON.....	4-31	SR.....	4-26
RO [ON,] .....	4-25	ST.....	4-26
RO OFF.....	4-25	SV .....	4-43
RQS.....	4-45	SVANT OFF.....	4-43
S0 .....	4-45	SVANT ON .....	4-43
S1 .....	4-45	SVCH OFF .....	4-43
S2 .....	4-45	SVCH ON .....	4-43
SAM.....	4-35	SVLIM 1 .....	4-43
SC.....	4-48	SVLIM 2 .....	4-43
SCRSEL TRA .....	4-31	SVLIM 3 .....	4-43
SCRSEL TRB .....	4-31	SVLIM OFF.....	4-43
SD .....	4-35	SVLIM ON .....	4-43
SDV .....	4-35	SVLVL OFF .....	4-43
SETDATE DATE.....	4-46	SVLVL ON.....	4-43
SETTIME TIME.....	4-46	SVn .....	4-43
SFM .....	4-35	SVNRM OFF.....	4-43, 4-47
SG .....	4-32	SVNRM ON .....	4-43, 4-47
SG OFF.....	4-32	SVOLSS OFF.....	4-43
SG ON.....	4-32	SVOLSS ON.....	4-43
SI.....	4-26	SVSET OFF.....	4-43
SIGID OFF .....	4-23	SVSET ON .....	4-43
SIGID ON.....	4-23	SVSPR OFF.....	4-43
SIMS OFF.....	4-40	SVSPR ON .....	4-43
SIMS ON .....	4-40	SVTRC OFF .....	4-43
SN .....	4-26	SVTRC ON.....	4-43
SNGLS.....	4-26	SW .....	4-26
SOF .....	4-35	SWM.....	4-26
SON .....	4-35	SWPCNT .....	4-28, 4-29
SP .....	4-22	SYMRT.....	4-39
SPM .....	4-39	TA .....	4-28
SPM OFF.....	4-39	TAA .....	4-45
SPMMOD ABS .....	4-40	TAB .....	4-45
SPMMOD REL.....	4-40	TB .....	4-28

TBA .....	4-45
TBB.....	4-45
TG.....	4-47
TGA .....	4-47
TGF.....	4-47
TGL.....	4-47
TGM.....	4-47
TN .....	4-38
TPL .....	4-29, 4-44
TPS.....	4-29, 4-44
TRGDT .....	4-27
TRGSRC .....	4-27
TRGSRC EXT .....	4-27
TRGSRC FREE .....	4-27
TRGSRC LINE.....	4-27
TRGSRC TVH.....	4-27
TRGSRC TVV.....	4-27
TRGSRC VIDEO .....	4-27
TRIGSLP- .....	4-27
TRIGSLP FALL .....	4-27
TRIGSLP RISE.....	4-27
TRIGSLP+ .....	4-27
TS.....	4-26
TVH .....	4-27
TVHNT .....	4-27
TVHPS.....	4-27
US .....	4-48
USEC .....	4-48
UV.....	4-48
VA.....	4-25
VB.....	4-25
VI.....	4-27
VIDMOD .....	4-35
VIDMOD [ON].....	4-35
VIDMOD OFF.....	4-35
VOLT .....	4-48
WDO OFF.....	4-31
WDO ON .....	4-31
WDOSWP OFF .....	4-31
WDOSWP ON .....	4-31
WDX.....	4-31, 4-38
WLX .....	4-31, 4-38
WRBW OFF .....	4-25
WRBW ON .....	4-25
XDB .....	4-35
XDL .....	4-35
XDR.....	4-35
ZMPOS .....	4-31
ZMWID .....	4-31
ZS.....	4-22

## 4.2 GPIB Remote Programming

### 4.2 GPIB Remote Programming

The spectrum analyzer is equipped with a GPIB (General Purpose Interface Bus) that complies with IEEE Standard 488.1-1978. This bus allows you to attach and use an external device to remotely control the spectrum analyzer.

#### 4.2.1 GPIB

The GPIB is a high-performance interface bus used to connect measuring instruments to a computer. IEEE Standard 488.1-1978 defines the operations of the GPIB. Since the GPIB has a bus-configured interface, connected devices are designated by assigning them a specific address. You can connect up to 15 devices in parallel using a single bus. GPIB devices perform one or more of the following functions:

- **Talker** Sends data to the bus. Only one active talker can exist on the GPIB bus.
- **Listener** Receives data from the bus. Multiple active listeners can exist on the GPIB bus.
- **Controller** Specifies which devices are designated as “talkers” or “listeners”. Only one active controller can operate on the GPIB bus. Controllers used to control IFC and REN messages are referred to as system controllers.

When there are multiple controllers attached to the bus, the system controller becomes the active controller by default. Other devices that can act as controllers operate as addressable devices when the system is activated.

The TCT (Take Control) interface message is used to set a controller other than the system controller as the active controller. After this setting is made, the system controller becomes inactive.

The controller controls the entire system by sending interface messages or device messages to each measuring instrument. The functions of the messages are:

- **Interface message:** messages used to control the GPIB bus
- **Device message:** messages used to control specific devices

## 4.2.2 GPIB Setup

### (1) Connecting the GPIB

The following figure shows the standard GPIB connector and how it can be connected in parallel, or “stacked” with other connectors. Attach the GPIB connectors and secure them by tightening the screws to prevent them from coming apart during use.

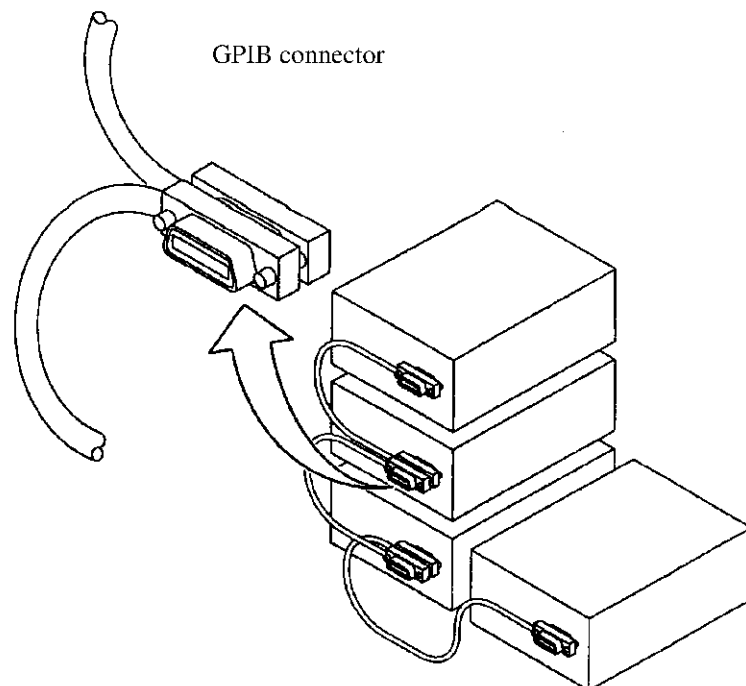

The following conditions should be observed when using a GPIB interface:

- The total GPIB cable length in a single bus system must not be more than 20 m (you can calculate the current cable length using the formula total length =  $n \times 2$  m, where,  $n$  is the number of devices to be connected, including the GPIB controller).
- No more than 15 devices can be connected to a single bus system.
- There are no restrictions concerning the method of connection between cables. However, no more than three GPIB connectors should be connected to a single device, since more than this may damage the connector mounting due to excessive strain.

(Example) The total cable length in a system with five devices should be 10m or less ( $2 \text{ m} \times 5 \text{ devices} = 10 \text{ m}$ ). There is no restriction on the length of the cables between the individual devices as long as the total length does not exceed 10 m. However, if you connect 10 devices or more, make sure that at least some of the cables attaching the devices are less than 2 m so that the total is less than 20 m.

4.2.3 GPIB Interface Functions

(2) Setting the GPIB Address

The GPIB Address dialog box is displayed.

1. Press **CONFIG** and **GPIB**.  
The GPIB Address dialog box is displayed.
2. Use the data knob, the step keys, or the numeric keys to set the GPIB address as required.
3. Press **ENTER (Hz)** to set the address.

(3) Turning the display off

If the screen display is turned off, the speed of measurements made using GPIB control increases.

1. Press **CONFIG** and **Annotation ON/OFF (OFF)**.  
OFF is selected, and all indications except for the trace are removed.

**4.2.3 GPIB Interface Functions**

Code	Description
SH1	Source handshake
AH1	Acceptor handshake
T6	Basic talker, serial polling, listener-specified talker cancel
TE0	Extended talker (not available)
L4	Basic listener function, talker-specified listener cancel
LE0	Extended listener (not available)
SR1	Service request function
RL1	Remote, local, local lockout
PP0	Parallel polling (not available)
DC1	Device clear
DT0	Device trigger (not available)
C0	System controller (not available)
E1	Using open-collector bus driver

#### 4.2.4 Responses to Interface Messages

The IEEE Standard 488.1-1978 defines how the spectrum analyzer responds to interface messages. The responses are described in this section.

For information on how to send interface messages to the spectrum analyzer, refer to the instruction manual of the controller you are using.

(1) Interface Clear (IFC)

The IFC message is transmitted directly to the spectrum analyzer through a signal line. The message allows the spectrum analyzer to stop the operation of the GPIB bus. Although all input/output operation is stopped, the input/output buffer is not cleared. Note that the DCL is used to clear the buffer.

(2) Remote Enable (REN)

The REN message is transmitted directly to the spectrum analyzer through a signal line. If the spectrum analyzer is specified as a listener when the message is true, the spectrum analyzer is in remote mode. The spectrum analyzer remains in remote mode until the GTL message is received, REN becomes false, or you press the **LOCAL** key.

When the spectrum analyzer is in local mode, it ignores all received data, and key inputs (except for LOCAL key input) and when the spectrum analyzer is in LOCAL LOCKOUT mode, it ignores all key input.

(3) Serial Polling Enable (SPE)

When the spectrum analyzer is receiving a message from an external device, it is in serial polling mode. If the spectrum analyzer is specified as a talker in this mode, it sends status bytes instead of normal messages. The spectrum analyzer remains in the serial polling mode until the SPD (Serial Polling Disable) message or the IFC message is received.

When the spectrum analyzer sends an SRQ (Service Request) message to the controller, bit 6 (RQS bit) of the response data is set to 1 (true). When the spectrum analyzer has finished sending this message, the RQS bit reverts to 0 (false). The SRQ message is sent directly through a signal line.

(4) Device Clear (DCL)

When the spectrum analyzer receives a DCL message, it performs the following actions:

- Clears the input and output buffers.
- Resets syntax analysis, execution control, and response data generation.
- Cancels all commands that prevent the remote command from being executed next.
- Cancels commands that are paused to wait for other parameters.

When the spectrum analyzer receives the DCL message, it does not do the following:

- Changes data set or stored in the spectrum analyzer.
- Interrupt front panel operation.
- Modify or interrupt any spectrum analyzer operations being executed.
- Change any status bytes other than MAV (MAV becomes 0 when the output buffer is cleared).

#### 4.2.5 Message Exchange Protocol

(5) Selected Device Clear (SDC)

The SDC message operates in the same manner as the DCL message. However, it is executed only when the spectrum analyzer is a listener. In other cases, the SDC message is ignored.

(6) Go to Local (GTL)

The GTL message puts the spectrum analyzer into local mode. In local mode, all the operations normally accessible from the front panel are available.

(7) Local Lockout (LLO)

The LLO message puts the spectrum analyzer in the local lockout mode. If the spectrum analyzer is set to the remote mode when this is done, all operations normally available from the front panel are disabled (note that in the normal remote mode, you can perform front panel operations using the **LOCAL** key).

You can use one of the following three methods to set the spectrum analyzer to local mode from the local lockout mode:

- Send a GTL message to the spectrum analyzer
- Set the REN message to false (the local lockout mode will be canceled)
- Turn the spectrum analyzer power off and on again

#### 4.2.5 Message Exchange Protocol

The spectrum analyzer receives program messages from controllers or other devices through the GPIB bus and generates response data. Program messages include commands, queries (commands used to query response data) and data. The procedure used to exchange these commands, queries and data is explained in this section.

(1) GPIB Buffers

The spectrum analyzer is equipped with the following two buffers:

(a) Input Buffer

The input buffer is used to store data temporarily for command analysis (it has a length of 1024 bytes so an input larger than this is ignored.)

Use either of the following two methods to clear this buffer:

- Turn the spectrum analyzer power on.
- Execute DCL or SDC.

(b) Output Buffer

The output buffer is used to store data which is going to be read from the controller (1024 bytes).

Use either of the following two methods to clear this buffer:

- Turn the spectrum analyzer power on.
- Execute DCL or SDC.



## (2) Message Exchange

GPIB control between a controller and a device consists of two main elements; command message analysis (by the parser) and response data generation. These are explained below.

## (a) Parser

The parser receives command messages in the order of reception from the input buffer, analyzes the syntax, and determines what the received command is.

## (b) Response Data Generation

When the parser determines what the query is, the spectrum analyzer generates data in the output buffer in response (that is, to output data a query must be sent immediately before the data).

### 4.2.6 Command Syntax

Command programs for the spectrum analyzer are defined using the following format:

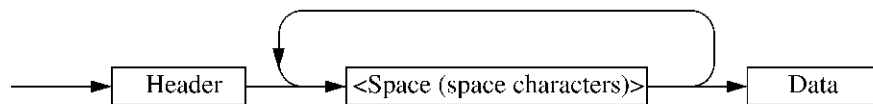

## (1) Header

Two types of header are available: the common command header and the simple header. The common command header has an asterisk (\*) at the beginning of the mnemonic.

The simple header is a functionally independent command that has no hierarchical structure.

You can form a query command by attaching a “?” in the rear of a header.

## (2) Space (Space Character)

You should separate the header from the data by one or more spaces, however spaces may be omitted.

## (3) Data

When the command requires multiple data, data is separated by commas. A space may be inserted before or after each comma. For more information on data types, see Section 4.2.7 “Data Formats.”

## (4) Writing Multiple Commands

You can write multiple commands by separating them with semicolons in one line.

4.2.7 Data Formats

**4.2.7 Data Formats**

The spectrum analyzer uses the following data formats for the input and output data.

(1) Numeric Data

There are three numeric data formats, any of which can be used for input. Some commands add units to the data when the data is input. The following shows the three numeric data formats.

- Integer type: NR1 format

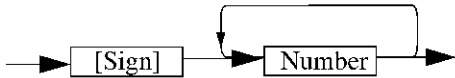

- Fixed-point type: NR2 format

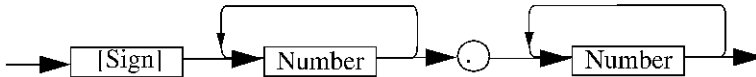

- Floating-point type: NR3 format

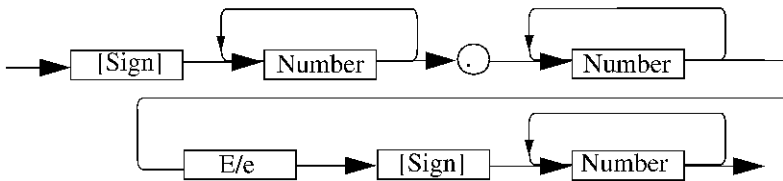

(2) Units

The table below lists the units that you can use.

Unit	Exponential	Description
GZ	10 <sup>9</sup>	Frequency
MZ	10 <sup>6</sup>	Frequency
KZ	10 <sup>3</sup>	Frequency
HZ	10 <sup>0</sup>	Frequency
VOLT	10 <sup>0</sup>	Voltage
MV	10 <sup>-3</sup>	Voltage
UV	10 <sup>-6</sup>	Voltage
NV	10 <sup>-9</sup>	Voltage
MW	10 <sup>-3</sup>	Power
DB	10 <sup>0</sup>	dB correspondence
MA	10 <sup>-3</sup>	Electric Current
SC	10 <sup>0</sup>	Second
MS	10 <sup>-3</sup>	Second
US	10 <sup>-6</sup>	Second
PER	10 <sup>0</sup>	Percentage
%	10 <sup>0</sup>	Percentage

## 4.2.8 Status Byte

The spectrum analyzer has a hierarchical status register structure which complies with IEEE Standard 488.2-1987. This is used to send information on the status of various aspects of a device to the controller. This section explains the status byte and event assignments operation models.

### (1) Status Register

The spectrum analyzer uses the status register model defined by IEEE Standard 488.2-1987. This consists of a condition register, an event register and an enable register.

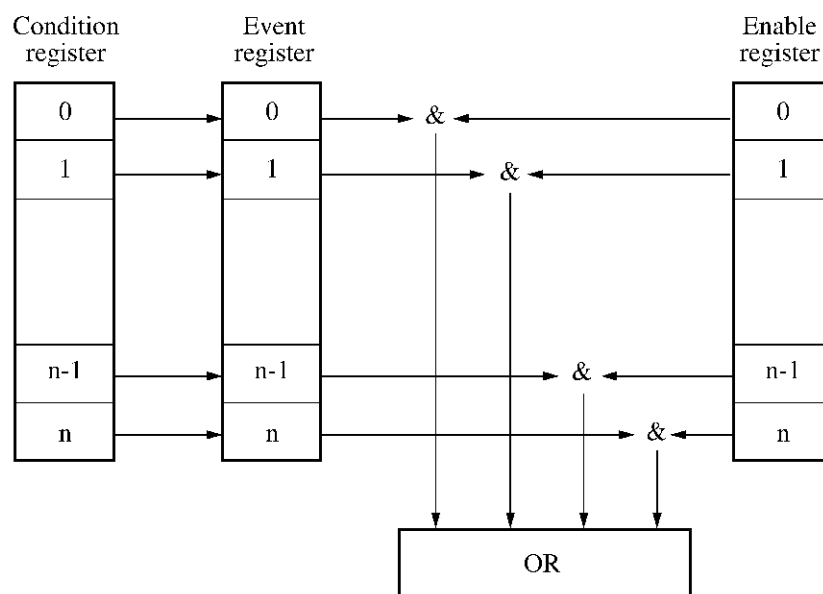

#### (a) Condition Register

The condition register continuously monitors the status of devices, showing their latest status. However, this register is used internally, so no data can be written into or read out from this register.

#### (b) Event Register

The event register latches and retains the status information from the condition register (in some cases, it retains status changes).

Once the register is set, the condition is maintained until a query command reads out the information or the register is reset by means of the \*CLS command.

No data can be written into the event register.

#### (c) Enable Register

The enable register specifies which bit in the event register is to be used as the valid status to generate a summary. The enable register is ANDed with the event register. The OR of the result of the AND operation is generated as a summary. The summary is written into the following status byte registers.

Any data can be written into the enable register.

The following three types of status registers are used in the spectrum analyzer:

#### 4.2.8 Status Byte

- Status byte register
- Standard event register
- Standard operation status register

The arrangement of the status registers of the spectrum analyzer are shown in Figure 4-1.

The status registers are shown in detail in Figure 4-2.

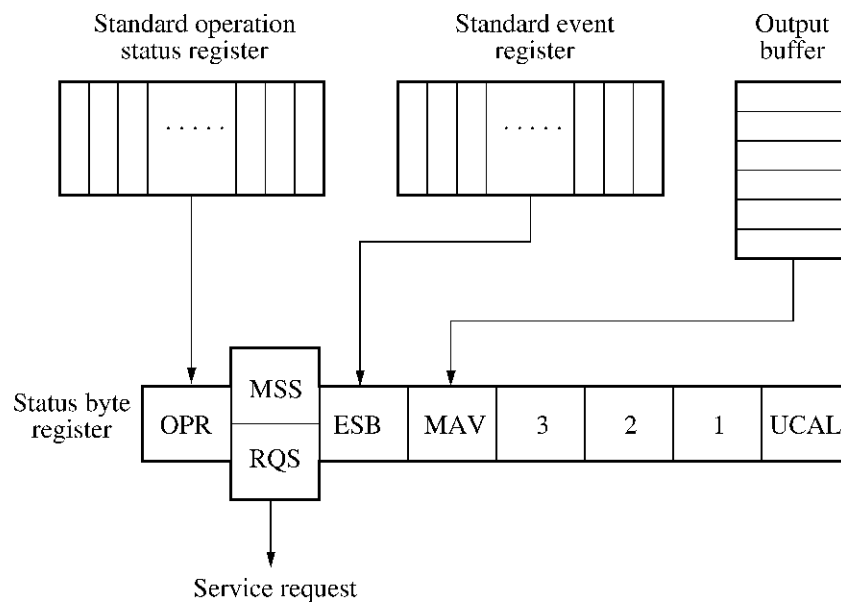

**Figure 4-1 Arrangement of the Three Status Registers**

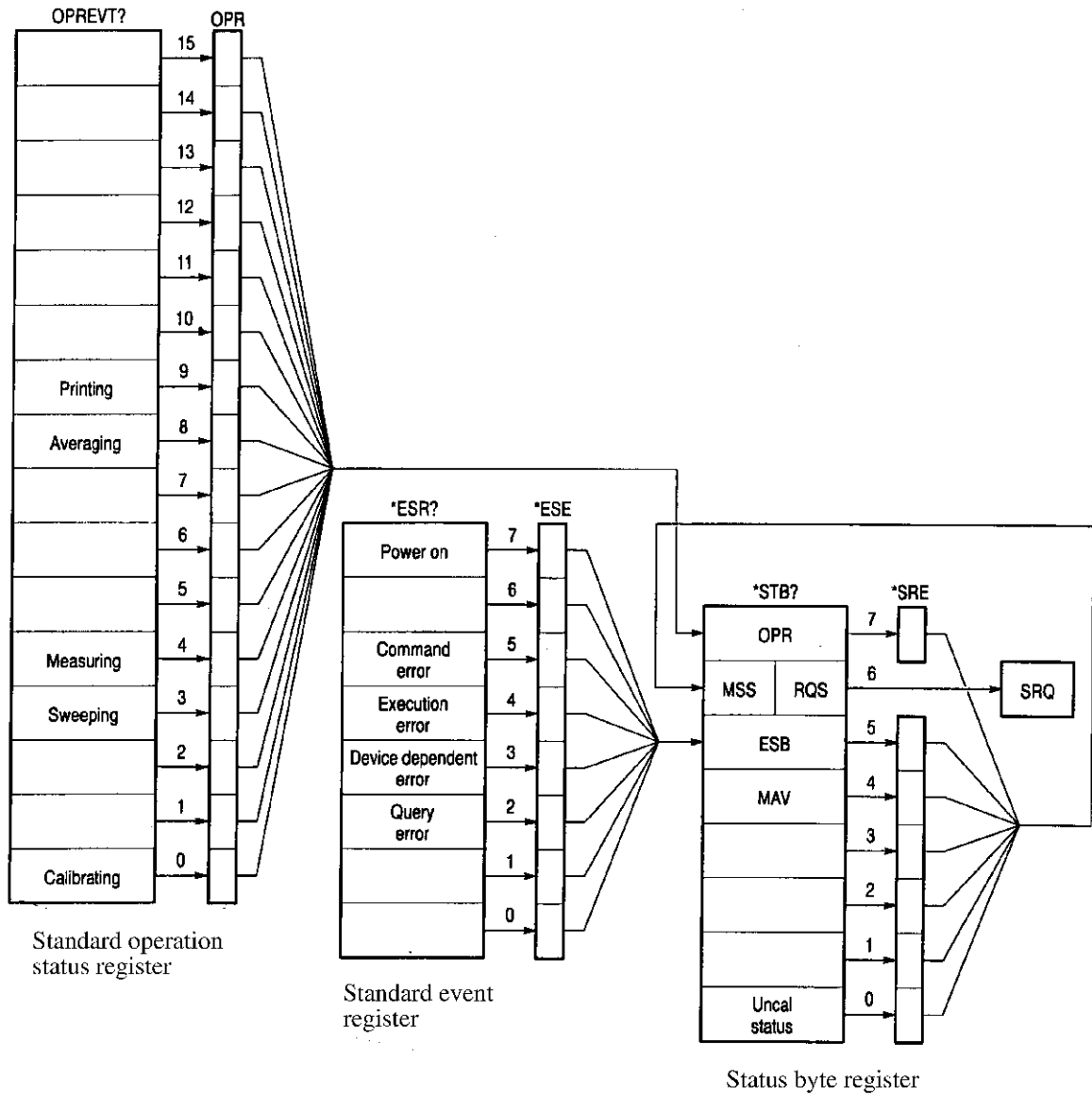

Figure 4-2 Details of the Three Status Registers

4.2.8 Status Byte

(2) Event Enable Register

Each event register has an enable register to determine which bit is available. The enable register sets the corresponding bit in decimal value.

- Set of Service Request Enable Register: \*SRE
- Set of Standard Even Status Enable Register: \*ESE
- Set of Operation Status Enable Register: OPR

Example: Only the Measuring bit in the operation status register is available.  
 The OPR bit of the status byte register is set to 1 when the Measuring bit of the operation status register is set to one.  
 PRINT @8;"OPR16" (An example of the program in N88BASIC)  
 OUTPUT 708;"\*OPR16" (An example of the program for the HP200 and 300 series)

Example: The OPR (the summary of Operation Status Register) bit and ESB (the summary of Event Status Register) bit of the status byte register are available.  
 The MSS bit of the status byte register is set to 1 when the OPR bit or the ESB bit is set to one.  
 PRINT @8;"SRE160" (An example of the program in N88BASIC)  
 OUTPUT 708;"\*SRE160" (An example of the program for the HP200 and 300 series)

(3) Standard Operation Status Register

Bit assignments for the event register (which represents the standard operation status) is listed below:

Bit	Functional definition	Description
15 to 10		This is always 0
9	Printing	This is set to 1 at the end of printing
8	Averaging	This is set to 1 when averaging is completed
7 to 5		This is always 0
4	Measuring	This is set to 1 at the end of sequence measurement
3	Sweeping	This is set to 1 when sweeping is completed
2 to 1		This is always 0
0	Calibrating	This is set to 1 when calibration data acquisition finishes

## (4) Status Byte Register

The status byte register summarizes the information from the status register. In addition, a summary of the status byte register is sent to the controller as a service request. As a result, this register operates slightly differently from the status register. This section explains the status byte register. The structure of the status byte register is shown in Figure 4-3.

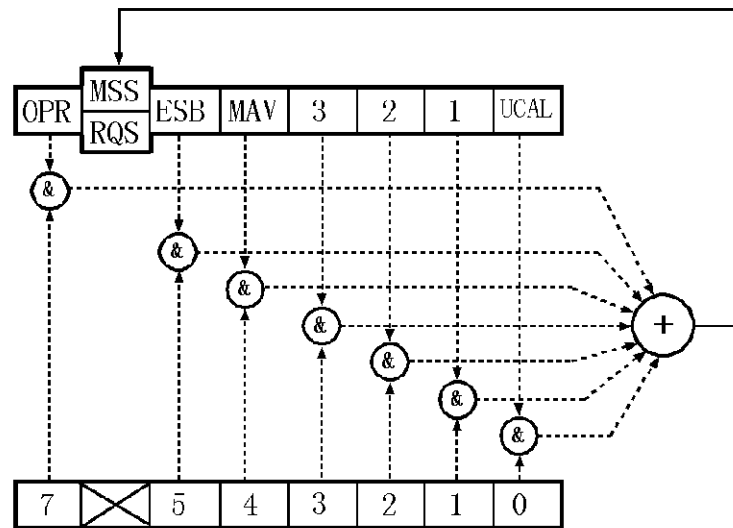

**Figure 4-3 Structure of the Status Byte Register**

This status byte register has the same functions as the status register, except for the following three points:

- The summary of the status byte register is written in bit 6 of the status byte register.
- Bit 6 of the enable register is always valid and cannot be changed.
- Bit 6 (MSS) of the status byte register writes the RQS of the service request.

The register responds to serial polling from the controller. On doing so, bits 0 to 5 and bit 7 of the status byte register and the RQS are read out, and then the RQS is reset to 0. Other bits are not cleared until each factor has been reset to 0.

When the \*CLS and S2 commands are executed, the status byte register, the RQS bit, and the MSS bit can be cleared. Consequently, the SRQ line is now false.

4.2.8 Status Byte

The table below explains the meanings of the bits in the status byte register.

Bit	Functional definition	Description
7	OPR	The OPR bit is a summary of the standard operation status register.
6	MSS	The RQS bit is true when the MSS bit of the status byte register is set to 1. The MSS bit is the summary bit for the entire status data structure. The serial poll cannot read out the MSS bit. (However, the MSS bit is understood to be 1 when the RQS bit is 1.) To read the MSS bit, use the common command *STB?. The *STB? command can read out bit 0 to 5 and bit 7 of the status byte register and the MSS bit. In this case, neither the status byte register nor the MSS bit can be cleared. The MSS bit cannot become 0 until all the unmasked factors in the status register structure have been cleared.
5	ESB	The ESB bit is a summary of the standard event register.
4	MAV	Summary bit for the output buffer. This instrument does not use this bit.
3 to 1		This is always 0.
0	UCAL	This is set to 1 when an signal level error occurs because the sweep is too fast.



## (5) Standard event register

The table below explains the meanings of the bits in the standard event register.

Bit	Functional definition	Description
7	Power on	This is set to 1 when the spectrum analyzer is switched on
6		This is always 0
5	Command Error	This is set to 1 when the parser finds a syntax error
4	Execution Error	This is set to 1 when the system fails to execute an instruction received as a GPIB command for some reason (such as out-of-range parameter)
3	Device Dependent Error	This is set to 1 when errors other than command errors, execution errors, or query errors occur
2	Query Error	This is set to 1 when no data exists or data has been deleted when the controller attempts to read out data from the spectrum analyzer
1	Request Control	Not supported in the spectrum analyzer
0	Operation Complete	Not supported in the spectrum analyzer

4.2.9 GPIB Command Codes

**4.2.9 GPIB Command Codes**

The following tables list the GPIB commands by function.

**Listener Code Column:** An asterisk (\*) in the Listener Code Column indicates that the function requires numeric data together with the function code.  
 The sign /\*\*\*/ in the Listener Code Column indicates that the function requires character string data together with the function code.  
 [ON], [ON,] and numeric data are omissible.  
 String data such as file name, label and so on can receive characters, which are found after the command and prior to the delimiter, as input values. However, when data begins with a “/”, the characters between “/” and “/” are received as input.

**Output Format Column:** A comma (,) in the Output Format column indicates that multiple items are output.  
 ON/OFF or AUTO/MANUAL in the Output Format column indicates that the code outputs 1 or 0, respectively.  
 All frequencies are in hertz (Hz), and all times are in seconds. Levels are output in the currently displayed unit.

**Table 4-1 Frequency (1 of 3)**

Function	Listener Code	Talker Request	
		Code	Output Format
Center frequency	CF *	CF?	Frequency
CF Step size	CS *	CS?	Frequency
CF Step AUTO	CA	CA?	0:Manual 1:Auto
Frequency offset	ON OFF	FO [ON,]* FO OFF	FO? FOON? Frequency 0:OFF 1:ON
Start frequency	FA *	FA?	Frequency
Stop frequency	FB *	FB?	Frequency
Frequency span	SP *	SP?	Frequency
Full span	FS	—	—
Zero span	ZS	—	—
Peak zoom	PKZOOM	—	—
Last span	LTSP LS	— —	— —
Preselector	Auto Manual	PPA PPM*	PPM? Integer (-127 to 127) (*1)

(\*1) Preselector is available for the R3162/72/82 only.

Table 4-1 Frequency (2 of 3)

Function	Listener Code	Talker Request	
		Code	Output Format
Frequency setting mode Frequency input mode Channel type 1 input mode Channel type 2 input mode	FINPMD FREQ FINPMD CH1 FINPMD CH2	FINPMD?	0:Frequency 1:CH Type 1 2:CH Type 2
Start channel offset	FACHO *	FACHO?	Frequency
Stop channel offset	FBCHO *	FBCHO?	Frequency
Carrier channel setting	CH *	CH?	Integer (channel number)
Center channel setting	CFCH *	CFCH?	Integer (channel number)
Start channel setting	FACH *	FACH?	Integer (channel number)
Stop channel setting	FBCH *	FBCH?	Integer (channel number)
Channel type 1 Table 1 input Table 2 input Table 3 input	(*1) CHED1 *,*,*,* CHED2 *,*,*,* CHED3 *,*,*,*	— — —	— — —
Table 1 for Channel type 1 Enable Disable	CHTBL1 ENBL CHTBL1 DSBL	CHTBL1?	0:Enable 1:Disable
Table 2 for Channel type 1 Enable Disable	CHTBL2 ENBL CHTBL2 DSBL	CHTBL2?	0:Enable 1:Disable
Table 3 for Channel type 1 Enable Disable	CHTBL3 ENBL CHTBL3 DSBL	CHTBL3?	0:Enable 1:Disable
Channel type 2 Input Deletion	(*2) CHEDIN *,*,* CHEDDEL	— —	— —
Internal mixer External mixer	MXI MXE	MXR?	0:INT (Internal) 1:EXT(External)
Signal Ident ON OFF	SIGID ON SIGID OFF	SIGID?	0:OFF 1:ON
Image Suppress ON OFF	IMGSP ON IMGSP OFF	IMGSP?	0:OFF 1:ON
Band selection	BND *	BND?	Integer
Band lock ON OFF	BNDLC ON BNDLC OFF	BNDLC?	0:OFF 1:ON

(\*1) Specify the asterisks in order of the start channel number, stop channel number, start frequency, channel spacing and channel offset.

(\*2) Specify the asterisks in order of the channel number, carrier frequency, start frequency and stop frequency.

4.2.9 GPIB Command Codes

**Table 4-1 Frequency (3 of 3)**

Function	Listener Code	Talker Request	
		Code	Output Format
Average loss ON OFF	AGL * AGL ON [*] AGL OFF	AGL? AGLON?	Level 0:OFF 1:ON
Loss vs Freq ON OFF	LVF ON LVF OFF	LVF?	0:OFF 1:ON
Loss vs Freq input Loss vs Freq deletion	LVFIN *,*,* (*3) LVFDEL	— —	— —

(\*3) Specify asterisks (\*) in the order of frequency, level (n-) and level (n+).

Table 4-2 Level

Function	Listener Code	Talker Request	
		Code	Output Format
Reference level	RL *	RL?	Level
ATT	AT*	AT?	Level
ATT auto	AA	AA?	0:Manual 1:Auto
XdB/Div	DD *	DD?	0: 10dB 1: 5dB 2: 2dB 3: 1dB
Linear × 1	LL1	—	—
Level offset	ON OFF	RO [ON,]* RO OFF	RO? ROON? Level 0:OFF 1:ON
Hi Sens	ON OFF	HS[ON] HS OFF	HS? 0: OFF 1: ON
Input	50 Ω 75 Ω	OHM50 OHM75	OHM? 0:50Ω 1:75Ω
Display unit	dBm dBmV dBμV Volts Watts	AUNITS DBM AUNITS DBMV AUNITS DBUV AUNITS V AUNITS W	AUNITS? 0:dBm 1:dBmV 2:dBμV 5:V 6:W

Table 4-3 BW

Function	Listener Code	Talker Request	
		Code	Output Format
RBW	RB*	RB?	Frequency (*3)
RBW auto	BA	BA?	0:Manual 1:Auto
VBW	VB*	VB?	Frequency (*2)
VBW auto	VA	VA?	0:Manual 1:Auto
Couple ALL auto	AL	AL?	0:Manual 1:Auto
Wide RBW	ON OFF	WRBW ON WRBW OFF	WRBW? 0:OFF 1:ON

(\*1) Only the R3132 can use both 50 Ω and 75 Ω as the input impedance.

(\*2) When the wide RBW is turned on, the VBW is set at 0 Hz.

(\*3) The RBW is set to 0 Hz when OPT73 (FM Demod) is turned on, and Range is set to 500 kHz/ or more.

4.2.9 GPIB Command Codes

**Table 4-4 Sweep**

Function	Listener Code	Talker Request	
		Code	Output Format
Sweep time	SW*	SW?	Sweep Time
	ST*	ST?	Sweep Time
SWP auto	AS	AS?	0:Manual 1:Auto
Sweep mode	—	SWM?	0:Normal & Full 1:Normal & Win 20:Single & Full 21:Single & Win
Sweep mode :Normal	CONTS SN	— —	— —
Sweep mode :Single	SI SNGLS	— —	— —
Take Sweep (Used to wait until the sweep is complete.)	TS	—	—
Sweep Reset & Start	SR	—	—
Gate Sweep    ON OFF	GTSWP ON GTSWP OFF	GTSWP?	0:OFF 1:ON
Gate position	GTPOS *	GTPOS?	Time
Gate width	GTWID *	GTWID?	Time
Gate Slope -  Gate Slope +	GTSLP - GTSLP FALL  GTSLP + GTSLP RISE	GTSLP?	0:+ 1:-
Gate Source	—	GTSRC?	3:TV-V 4:TV-H 5:EXT
Gate Source    EXT Trigger  TV-V TV-H	GTSRC EXT GTEX* GTSRC TVV GTSRC TVH GTTVH*	— GTEX? — — GTTVH?	— Level (Real number) — — No. (Integer)
External Gate IN    ON	GEX ON	GEX?	0:OFF 1:ON
	OFF	GEX OFF	GEXON? 0:OFF 1:ON

Table 4-5 Trigger

Function	Listener Code	Talker Request	
		Code	Output Format
Trigger Mode	—	TRGSRC?	0:Free RUN 1:Line 2:Video 3:TV-V 4:TV-H 5:Ext.
FREE RUN	TRGSRC FREE	—	—
LINE Trigger	TRGSRC LINE	—	—
VIDEO Trigger	TRGSRC VIDEO VI *	— VI?	— %(Integer)
External Trigger	TRGSRC EXT EX *	— EX?	— Level (Real number)
TV-V Trigger	TRGSRC TVV	—	—
TV-H Trigger	TRGSRC TVH TVH *	— TVH?	— No.(Integer)
Trigger Slope +	TRIGSLP+	TRIGSLP?	0: +
Trigger Slope -	TRIGSLP- TRIGSLP FALL		1: -
TV system NTSC PAL&SECAM	TVHNT TVHPS	TVSYS?	1: NTSC 0: PAL&SECAM
Trigger Delay	TRGDT *	TRGDT?	Time

4.2.9 GPIB Command Codes

Table 4-6 Trace (1 of 2)

Function	Listener Code	Talker Request	
		Code	Output Format
Trace A	—	TA?	HI      LOW 0:      0: Write 1:NORM 1: View 2:A-DL→A 2: Blank 3:A-B→A 3: Max Hold 4:B-A→A 4: Min Hold 5:      5: Averaging 6:      6: Power AVG
A write	AW	—	—
A view	AV	—	—
A blank	AB	—	—
A max hold A max hold OFF	AMAX ON AMAX OFF	AMAX?	0:OFF 1:ON
A min hold A min hold OFF	AMIN ON AMIN OFF	AMIN?	0:OFF 1:ON
A Averaging times	SWPCNT * AG *	SWPCNT? AG?	Average times Average times
Start	AAVG ON AGR	AAVG?	0:OFF 1:ON
Stop	AAVG OFF AGS		
Pause	AGP	AGP?	0:Continue
Continue	AGC		1:Pause
1 time	AGSGL	AGSGL?	0:Continuous
continuous	AGCNT		1:1 time
Power Average A ON	APAVG ON	APAVG?	0: OFF
OFF	APAVG OFF		1: ON
Pause	AGP	AGP?	0: Continue
Continue	AGC		1: Pause
1 time	AGSGL	AGSGL?	0: Continuous
continuous	AGCNT		1: 1 time
Math A	A-B→A B-A→A A-DL→A	ABA BAA ADLA	— — —
Trace B	—	TB?	0:Write 1:View 2:Blank 3:Max Hold 4:Min Hold 5:Averaging 6: Power AVG
B write	BW	—	—
B view	BV	—	—
B blank	BB	—	—
B max hold B max hold OFF	BMAX ON BMAX OFF	BMAX?	0:OFF 1:ON



Table 4-6 Trace (2 of 2)

Function	Listener Code	Talker Request	
		Code	Output Format
B min hold B min hold OFF	BMIN ON BMIN OFF	BMIN?	0:OFF 1:ON
B Averaging times	SWPCNT * BG *	SWPCNT? BG?	Average times Average times
	Start	BAVG ON BGR	0:OFF 1:ON
	Stop	BAVG OFF BGS	
	Pause Continue	BGP BGC	0:Continue 1:Pause
	1 time continuous	BGSGL BGCNT	0:Continuous 1:1 time
Power Average B ON OFF	BPAVG ON BPAVG OFF	BPAVG?	0: OFF 1: ON
	Pause Continue	BGP BGC	0: Continue 1:Pause
	1 time continuous	BGSGL BGCNT	0: Continuous 1: 1 time
Store A → B Store B → A	BSTORE ASTORE	— —	— —
Number of trace points 501 Number of trace points 1001	TPS TPL	TP?	0:501 1:1001
Director Mode A Normal Positive Negative Sample	DET NRM DET POS DET NEG DET SMP	DET?	0:Normal 1:Positive 2:Negative 3:Sample
Director Mode B Normal Positive Negative Sample	DETB NRM DETB POS DETB NEG DETB SMP	DETB?	0:Normal 1:Positive 2:Negative 3:Sample

4.2.9 GPIB Command Codes

**Table 4-7 Pass/Fail**

Function	Listener Code	Talker Request	
		Code	Output Format
Pass/Fail judgement ON OFF	PFC ON PFC OFF	PFC?	0:OFF 1:ON
Reading the judgment result	—	PFJ?	0:Pass 1:Fail
Reading the judgment result (in detail)	—	OPF?	0:Pass 1:Fail(Upper) 2:Fail(Lower) 3:Fail(Both) 4:Error
Upper Fail Point Lower Fail Point	— —	FPU? FPL?	n<DLM> f1,I1<DLM>... n<DLM> f1,I1<DLM>...(*1)
Frequency Domain input selection Time Domain input selection	LIMTYP FREQ LIMTYP TIME	LIMTYP?	0:Freq 1:Time (*2)
X-position mode: Absolute Relative (Left)  Relative(Center)	LIMPOS ABS LIMPOS REL LIMPOS LFT LIMPOS CENT	LIMPOS?	0:Absolute 1:Relative(Left) 2:Relative(Center)
Y-position mode: Absolute Relative(Top)  Relative(Bottom) Relative(Center)	LIMAPOS ABS LIMAPOS REL LIMAPOS TOP LIMAPOS BOTM LIMAPOS CENT(*3)	LIMAPOS?	0:Absolute 1:Relative(Top, Center) 2:Relative(Bottom)
X-offset	LIMSFT *	LIMSFT?	Frequency/Time
Y-offset	LIMASFT *	LIMASFT?	Level
Limit Line 1  ON OFF Data input Data erase	LMTA ON LMTA OFF LMTAIN *,* LMTADEL	LMTA?  — —	0:OFF 1:ON (*2)(*4) (*2)
Limit Line 2  ON OFF Data input Data erase	LMTB ON LMTB OFF LMTBIN *,* LMTBDEL	LMTB?  — —	0:OFF 1:ON (*2) (*2)

(\*1) n = Number of points fn, I<sub>n</sub> = Frequency (Time), Level <DLM> = Delimiter  
 (\*2) To use this function, first select Domain using the LIMTYP command.  
 (\*3) Enabled when OPT73 (FM Demod) is turned on. Relative (Top) and Relative (Bottom) cannot be used.  
 (\*4) To enter limit line data used with OPT73 (FM Demod), first turn FM Demod on.  
 To enter limit line data used with OPT73 sensitivity measurements, first turn sensitivity on.

Table 4-8 Display

Function	Listener Code	Talker Request	
		Code	Output Format
Display Line Level ON OFF	DL * DL ON [,*] DL OFF	DL? DLON?	Level 0:OFF 1:ON
Reference Line Level ON OFF	RLN RLN ON [,*] RLN OFF	RLN? RLNON?	Level 0:OFF 1:ON
Window ON OFF	WDO ON WDO OFF	WDO?	0:OFF 1:ON
Window center position	WLX *	WLX?	Frequency
Window width	WDX *	WDX?	Frequency
Window Sweep ON OFF	WDOSWP ON WDOSWP OFF	WDOSWP?	0:OFF 1:ON
Zoom F/T T/T ZOOM OFF(Screen Reset)	MLTSCR ZM MLTSCR FT MLTSCR TT MLTSCR OFF	MLTSCR?	0:OFF 1:ZOOM 2:F/T 3:T/T
Zoom position	ZMPOS *	ZMPOS?	Frequency/Time
Width	ZMWID *	ZMWID?	Frequency/Time
Activating the upper screen Activating the lower screen	SCRSEL TRA SCRSEL TRB	SCRSEL?	0:Upper 1:Lower

4.2.9 GPIB Command Codes

**Table 4-9 MKR (1 of 2)**

Function	Listener Code	Talker Request	
		Code	Output Format
Marker ON  OFF	MN * (*1)  MKOFF MO	MN?	0: OFF 1: Normal 2: Delta
Normal Marker (ΔMarker OFF)	MK * MKN *	—	—
ΔMarker ON	MKD *	—	—
Marker frequency	—	MF?	Frequency (Time)(*1)
Marker Level	—	ML?	Level(*1)
Frequency + Level	—	MFL?	Frequency (Time), Level(*1)
Normal marker absolute value Frequency Level	— —	MDF1? MDL1?	Normal MKR frequency Normal MKR level
ΔMarker absolute value Frequency Level	— —	MDF2? MDL2?	Delta MKR frequency Delta MKR level
FixedΔMarker  ON OFF	FX ON FX OFF	FX?	0:OFF 1:ON
MKR step Size	MPM *	MPM?	Frequency (Time)
MKR step auto	MPA	MPA?	0:Manual 1:Auto
Signal Track  ON OFF	SG ON SG OFF	SG?	0:OFF 1:ON
MKR Couple ON OFF	CPLMK [ON] CPLMK OFF	CPLMK?	0:OFF 1:ON
MKR move A Trace B Trace	MKTRACE TRA MKTRACE TRB	MKTRACE?	0:Blank 1:A Trace 2:B Trace
Peak Search	PS	—	—
Next Peak Next Peak Left Next Peak Right	NXP NXL NXR	— — —	— — —
Min Search	MIS	—	—
Max-Min Search	MMS	—	—
Continuous Peak?  ON OFF	CP ON CP OFF	CP?	0:OFF 1:ON

(\*1): When using the delta mode, the frequency or level difference is used.

Table 4-9MKR (2 of 2)

Function		Listener Code	Talker Request	
			Code	Output Format
Peak $\Delta Y$ div		DY *	DY?	$\Delta Y$ (real value)
Peak range Normal Upper side Lower side		PSN PSU PSL	PKRNG?	0:All 1:Upper 2:Lower
Multi Marker ON OFF		MLT ON MLT OFF	MLT?	0:OFF 1:ON
Moving the active marker		MK * MKN * MN *	— — —	— — —
Multi Marker No1 ON OFF		MLN1 * MLF1	— —	— —
Multi Marker No2 ON OFF		MLN2 * MLF2	— —	— —
Multi Marker No3 ON OFF		MLN3 * MLF3	— —	— —
Multi Marker No4 ON OFF		MLN4 * MLF4	— —	— —
Multi Marker No5 ON OFF		MLN5 * MLF5	— —	— —
Multi Marker No6 ON OFF		MLN6 * MLF6	— —	— —
Multi Marker No7 ON OFF		MLN7 * MLF7	— —	— —
Multi Marker No8 ON OFF		MLN8 * MLF8	— —	— —
Multi Marker No9 ON OFF		MLN9 * MLF9	— —	— —
Multi Marker No10 ON OFF		MLN10 * MLF10	— —	10 frequencies + $\Delta MKR$ 10 levels + $\Delta MKR$
Multi Marker Frequency		—	MLSF?	n<DLM> f1<DLM>... (*1)
Multi Marker Level		—	MLSL?	n<DLM> l1<DLM>... (*2)
Peak List Frequency Level OFF		PLS FREQ PLS LEVEL PLS OFF	— — —	— — —
Peak list query		—	PKLST?	n<DLM> f1,l1<DLM>... (*3)

(\*1) n = 11 (fixed) fn = 10 different frequencies +  $\Delta MKR$ , <DLM> = Delimiter

(\*2) n = 11 (fixed) ln = 10 different levels +  $\Delta MKR$ , <DLM> = Delimiter

(\*3) n = Number of Peaks fn, ln = Frequency (time), level <DLM> = Delimiter

4.2.9 GPIB Command Codes

**Table 4-10 MKR →**

Function	Listener Code	Talker Request	
		Code	Output Format
MKR → CF	MKCF MC	— —	— —
MKRA → CF	MTCF	—	—
MKR → REF	MKRL MR	— —	— —
PEAK → CF	PKCF	—	—
PEAK → REF	PKRL	—	—
MKRA → SPAN	MTSP DS	— —	— —
MKR → CF Step	MKCS M0	— —	— —
MKRA → CF Step	MTCS M1	— —	— —
MKR → MKR Step	MKMKS M2	— —	— —
MKRA → MKR Step	MTMKS M3	— —	— —

Table 4-11 Meas (1 of 3)

Function	Listener Code	Talker Request	
		Code	Output Format
Noise/Hz	NI *	NI?	Frequency
dBm/Hz ON	NIM	NION?	0:OFF
dB $\mu$ V/ $\sqrt$ Hz ON	NIU		1:dBm/Hz
dBc/Hz ON	NIC		2:dB $\mu$ V/ $\sqrt$ Hz
Noise/Hz OFF	NIF		3:dBc/Hz
Noise/Hz value	—	NIRES?	Level
XdB Down width	MKBW *	MKBW?	Level
XdB Down	XDB	—	—
left	XDL	—	—
right	XDR	—	—
XdB relative	DC0	DC?	0:Relative
XdB abs. left	DC1		1:Absolute (left side)
XdB abs. right	DC2		2:Absolute (right side)
Continuous dB down	CDB ON	CDB?	0:OFF
ON	CDB OFF		1:ON
OFF			
3rd Order meas	PKTHIRD	—	—
AM Modulation (%AM)	AMMOD [ON]	AMMODON?	0:OFF
AM Modulation OFF	AMMOD OFF		1:ON
AM modulation factor	—	AMMOD?	Value (%)
AM video modulation factor	VIDMOD [ON]	VIDMODON?	0:OFF
(%AM Video)	VIDMOD OFF		1:ON
AM video modulation factor			
OFF	—	VIDMOD?	Value (%)
AM video modulation factor			
value			
FM frequency deviation (FM Meas)	FMMEAS [ON]	FMMEASON?	0:OFF
FM frequency deviation OFF	FMMEAS OFF		1:ON
FM frequency deviation value	—	FMMEAS?	Frequency
Modulation frequency input	FMMODF [ON,]*	FMMODF?	Frequency
ON			
OFF	FMMODF OFF	FMMODFON?	0:OFF
			1:ON
Sound Mode			
ON (AM or FM)	SON	SD?	0:OFF
ON (AM)	SAM		1:ON(AM)
ON (FM)	SFM		2:ON(FM)
OFF	SOF		
Volume	SDV *	SDV?	Volume (Integer)
Pause time	PU *	PU?	Time
Squelch ON	SQE [ON,]*	SQE?	Level
Squelch OFF	SQE OFF	SQEON?	0:OFF
			1:ON

4.2.9 GPIB Command Codes

**Table 4-11 Meas (2 of 3)**

Function	Listener Code	Talker Request	
		Code	Output Format
<b>Phase noise measurement</b>	C/N measurement mode ON OFF	CNIS ON CNIS OFF	CNISON? 0: OFF 1: ON
	Offset frequency data readout	—	CNIS? n<DLM> f1, l1 <DLM>...(*1)
	Table input	CNOFSIN *	— Offset frequency
	Deleting the table	CNOFSDEL	—
	Signal track ON OFF	CNSIG ON CNSIG OFF	CNSIG? 0: OFF 1: ON
	Average number	CNAVG [ON,] * CNAVG OFF	CNAVG? CNAVGON? Integer (2 to 999) 0: OFF 1: ON
<b>Phase jitter measurement</b>	Phase jitter measurement mode ON OFF	PJIT ON PJIT OFF	PJITON? 0: OFF 1: ON
	Result value readout	—	PJIT? Carrier level, total SSB noise and phase jitter
	Start offset frequency	PJSRTO *	PJSRTO? Offset frequency
	Stop offset frequency	PJSTPO *	PJSTPO? Offset frequency
	Signal track ON OFF	PJSIG ON PJSIG OFF	PJSIG? 0: OFF 1: ON
	Average number	PJAVG [ON,] * PJAVG OFF	PJAVG? PJAVGON? Integer (2 to 999) 0: OFF 1: ON

(\*1) n=Set number  
fn=Offset frequency  
ln=Level  
<DLM>=Delimiter



Table 4-11 Meas (3 of 3)

Function	Listener Code	Talker Request	
		Code	Output Format
<b>IM measurement</b>	IM measurement mode ON OFF	IMM ON IMM OFF	IMMON? 0: OFF 1: ON
	Reference wave data read-out	—	IMMREF? Frequency, Level
	Delta frequency readout	—	IMMDF? Delta frequency
	Distortion signal data read-out	—	IMMRES? n<DLM>LL1, LJ1, UL1, UJ1<DLM>...(*1)
	Degree setting	IMODR *	IMODR? Degree (3, 5, 7, 9)
	Criteria input		
	3 rd order	IMLS3 *	IMLS3? Level
	5 th order	IMLS5 *	IMLS5? Level
	7 th order	IMLS7 *	IMLS7? Level
	9 th order	IMLS9 *	IMLS9? Level
	Pass/Fail judgment ON OFF	IMPFC ON IMPFC OFF	IMPFC? 0: OFF 1: ON
	Average number	IMAVG * IMAVG [ON,] * IMAVG OFF	IMAVG? IMAVGON? Integer (2 to 999) 0: OFF 1: ON
	Hi Sens (IM Meas) ON OFF	IMHS ON IMHS OFF	IMHS? 0: OFF 1: ON

(\*1) n: Result set number corresponding to the degree

LLn: Level difference in the lower frequency signal

LJn: Pass/Fail judgment result for the lower frequency signal

0: Pass

1: Fail

-1: Judgment off

ULn: Level difference for the upper frequency signal

UJn: Pass/Fail judgment result for the upper frequency signal

4.2.9 GPIB Command Codes

**Table 4-12 Auto Tune**

Function	Listener Code	Talker Request	
		Code	Output Format
Auto Tune	TN	—	—

**Table 4-13 Counter**

Function	Listener Code	Talker Request	
		Code	Output Format
Resolution : 1kHz : 100Hz : 10Hz : 1Hz	CN0 CN1 CN2 CN3	CN?	0:1kHz 1:100Hz 2:10Hz 3:1Hz
Counter ON OFF	COUNT ON COUNT OFF	COUNT?	0:OFF 1:ON
Counter value	—	CNRES?	Frequency

**Table 4-14 Power (1 of 3)**

Function	Listener Code	Talker Request	
		Code	Output Format
Channel Power	PWCH	PWCH? PWCHON?	Level 0:OFF 1:ON
Parameter setup Default Manual Define → Default	PWCHST USR PWCHST MNL PWCHST DEF	PWCHST?	0:(Unused) 1:Default 2:Manual
Total Power	PWTOTAL	PWTOTAL? PWTOTALON?	Level 0:OFF 1:ON
Average Power	PWAVG	PWAVG? PWAVGON?	Level 0:OFF 1:ON
Average time	PWTM *	PWTM?	Integer (1 to 999)
Window center position	WLX *	WLX?	Frequency
Window width	WDX *	WDX?	Frequency
Power OFF	PWM	—	—
OBW Execution OBW OFF	OBW [ON] OBW OFF	OBWON?	0:OFF 1:ON
OBW measurement value	—	OBW?	Center,OBW
OBW %	OBWPER *	OBWPER?	OBW%
OBW real-time execution	OBWEXE	—	—

Table 4-14 Power (2 of 3)

Function	Listener Code	Talker Request	
		Code	Output Format
Parameter setup Default Manual Define → Default	OBWST USR OBWST MNL OBWST DEF	OBWST?	0:(Unused) 1:Default 2:Manual
ACP Execution ACP OFF	ACP [ON] ACP OFF	ACPON?	0:OFF 1:ON
ACP measurement value	—	ACP?	n<DLM> f1L,11L, f1H,11H<DLM>...(*1)
Reference power value	—	ACPREF?	Level
BS Window      ON OFF	ACPBSW ON ACPBSW OFF	ACPBSW?	0:OFF 1:ON
ACP real-time execution	ACPEXE	—	—
Carrier Bandwidth	CARRBS *	CARRBS ?	Frequency
CS/BS table    input erase	CSBSIN *,* CSBSDEL	— —	— —
ACP screen     FULL SEPA CARRIER	ACPSCR FULL ACPSCR SEPA ACPSCR CARR	ACPSCR?	0:1 screen 1:Separate screen 2:1 screen (Carrier measurement)
Symbol Rate 1/T	SYMRT *	SYMRT?	Frequency
Roll Off Factor	RFACT *	RFACT?	Real number
√Nyquist filter   ON OFF	NQST ON NQST OFF	NQST?	0:OFF 1:ON
Graph           ON OFF	ADG [ON] ADG OFF	ADG?	0:OFF 1:ON
Parameter setup Default Manual Define → Default	ACPST USR ACPST MNL ACPST DEF	ACPST?	0:(Unused) 1:Default 2:Manual
Spectrum mask execution Spectrum mask OFF	SPM [ON] SPM OFF	SPMON?	0:OFF 1:ON
Parameter setup Default Manual Define → Default	SPMST USR SPMST MNL SPMST DEF	SPMST?	0:(Unused) 1:Default 2:Manual
Spectrum mask result	—	SPM?	ref<DLM>n<DLM>f1L,11L, f1H,11H<DLM>...(*2)

(\*1) n = Number of points  
fnL= nth frequency (time) Low  
lnL= nth level Low  
fnH= nth frequency (time) High  
lnH= nth level High  
<DLM> = Delimiter

(\*2) ref = Reference power value  
n = Number of points  
fnL= nth frequency (time) Low  
lnL= nth level Low  
fnH= nth frequency (time) High  
lnH= nth level High  
<DLM> = Delimiter

## 4.2.9 GPIB Command Codes

Table 4-14 Power (3 of 3)

Function	Listener Code	Talker Request	
		Code	Output Format
Result display mode REL ABS	SPMMOD REL SPMMOD ABS	SPMMOD?	0:REL 1:ABS
Spurious measurement execution Freq Time Spurious measurement OFF	SPURI FREQ SPURI TIME SPURI OFF	SPURION?	0:OFF 1:Freq 2:Time
Spurious measurement result	---	SPURI?	n<DLM>, m1<DLM>,f1,l1,j1<DLM>,..., fm1,lm1,jm1<DLM>, m2<DLM>,f1,l1,j1<DLM>,..., fm2,lm2,jm2<DLM>, : : : mn<DLM>,f1,l1,j1<DLM>,..., fmn,lmn,jmn<DLM>(*1)
Table selection	SPRTBL*	SPRTBL?	Integer(*2)
Table input Freq Time	SPRIN>(*3) SPRFIN(*3) SPRTIN(*4)	---	---
Table deletion	SPRDEL(*2)	---	---
Sweep count specification ON OFF	SPRCNT [ON,]* SPRCNT OFF	SPRCNT? SPRCNTON?	Integer 0:OFF 1:ON
Pass/fail judgment value LOW UP	SPRJ LOW SPRJ UP	SPRJ?	0:LOW 1:UP
Single Measure ON OFF	SIMS ON SIMS OFF	SIMS?	0: OFF 1: ON

(\*1) n=Number of measurement points (0 thru 15)  
m=Number of spurious signals (0 thru 10)  
f=Spurious frequency  
l=Spurious level  
j=Judgment result (0: Pass, 1: Fail)  
<DLM>=Delimiter

(\*2) (\*3) (\*4) Perform the corresponding operation when the spurious measurement mode is turned on.

(\*3) Specify the asterisk in order of the start frequency, stop frequency, RBW, sweep time and limit level.

(\*4) Specify the asterisk in order of the center frequency, RBW, sweep time and limit level.

Table 4-15 EMC

Function	Listener Code	Talker Request	
		Code	Output Format
EMC Trace Detection :QP :PEAK :Normal	EMCDET QP EMCDET PEAK EMCDET NRM	EMCDET?	0:Normal 1:QP 3:PEAK
QP BW 200Hz QP BW 9kHz QP BW 120kHz QP BW 1MHz QP BW auto	QP0 (*1) QP1 QP2 QP3 (*2) QPAUTO QA	QPAUTO? QA?	0:AUTO 1:200Hz 2:9kHz 3:120kHz 4:1MHz
Antenna Selection Dipole (TP1722) Log-periodic (UHALP9107) Biconical (BBA9106) Bilog (EMC03142) User correction Antenna OFF	ANT0 AN0 ANT1 AN1 ANT2 AN2 ANT3 AN3 ANT4 AN4 ANT OFF AF	ANT?	0:OFF 1:Dipole 2:Log-periodic 3:Biconical 4:Bilog 5:User correction
User correction ON OFF	CR ON CR OFF	— —	— —
Table input	CRIN *,* (*3)	—	—
Table erase	CRDEL	—	—
Antenna mode Level mode	CR ANT CR LVL	CR?	0:Antenna 1:level

(\*1) QP BW 200 Hz is available only when the Narrow Band RBW option is installed.

(\*2) Available when EMC Trace Detection is set to Peak.

(\*3) The asterisks "\*,\*" represent a frequency and its level. Specify them in order.

4.2.9 GPIB Command Codes

**Table 4-16 CAL**

Function	Listener Code	Talker Request	
		Code	Output Format
CAL ALL	CLALL	—	—
Total gain	CLGAIN	—	—
IF step AMP	CLSTEP	—	—
RBW switch	CLRBW	—	—
Log linearity	CLLOG	—	—
AMPTD OFS	CLMAG	—	—
PBW	CLPBW	—	—
CAL Signal Level	CLN *	CLN?	Level
CAL 10M Reference Coarse	CLCREF *	CLCREF?	Integer (0 to 255)
CAL 10M Reference Fine	CLFREF *	CLFREF?	Integer (0 to 255)
CAL 10M Reference Default	CLDREF	—	
CAL 10M Reference Store	CLSREF	—	
f-collection ON	FC ON	FC?	0:OFF
f-collection OFF	FC OFF		1:ON
CAL collection ON	CC ON	CC?	0:OFF
CAL collection OFF	CC OFF		1:ON

Table 4-17 Save Recall

Function		Listener Code	Talker Request	
			Code	Output Format
Save Reg.		SVn (*2)	—	—
Save File		SV File name (*1)	—	—
Delete Reg.		DELn (*2)	—	—
Delete File		DEL File name (*1)	—	—
Recall Reg.		RCn (*2)	—	—
Recall File		RC File name (*1)	—	—
Save Item	Setup ON	SVSET ON	SVSET?	0:OFF
	Setup OFF	SVSET OFF		1:ON
	Trace ON	SVTRC ON	SVTRC?	0:OFF
	Trace OFF	SVTRC OFF		1:ON
	Antenna ON	SVANT ON	SVANT?	0:OFF
	Antenna OFF	SVANT OFF		1:ON
	Normalize ON	SVNRM ON	SVNRM?	0:OFF
	Normalize OFF	SVNRM OFF		1:ON (*3)
	Limit Line 1 ON	SVLIM 1	SVLIM?	0:OFF
	2 ON	SVLIM 2		1: 1 ON
1/2 ON	SVLIM 3		2: 2 ON	
OFF	SVLIM ON		3: 1/2 ON	
SVLIM OFF	SVLIM OFF			
Loss:Freq ON	SVOLSS ON	SVOLSS?	0:OFF	
Loss:Freq OFF	SVOLSS OFF		1:ON (*4)	
Level ON	SVLVL ON	SVLVL?	0:OFF	
Level OFF	SVLVL OFF		1:ON	
Channel ON	SVCH ON	SVCH?	0:OFF	
Channel OFF	SVCH OFF		1:ON	
Spurious ON	SVSPR ON	SVSPR?	0:OFF	
Spurious OFF	SVSPR OFF		1:ON	

- (\*1) Add FD: or RAM: to the file name to explicitly indicate a drive name.  
(Example) Write a file name such as FD: FILE00.DAT and RAM: REG00.DAT. (.DAT can be omitted.)
- (\*2) n = Save/Del/Recall number  
A value of 0 to 99 can apply to n.
- (\*3) (Available when the TG option is installed.)
- (\*4) Enabled if the external mixer is installed.

4.2.9 GPIB Command Codes

**Table 4-18 Config**

Function	Listener Code	Talker Request	
		Code	Output Format
Title ON erase	LON /**/ LOF	LB? —	Label —
Printer Command Select ESC/P PCL ESC/P Raster	PRTCMD ESC PRTCMD PCL PRTCMD ESCR	PRTCMD?	0:ESC/P 1:PCL 2:ESC/P Raster
Gray level set Gray B/W Small B/W Large Color S-Color Small S-Color Large	PRT GRY PRT MOS PRT MOL PRT COL PRT SCOLS PRT SCOLL	PRT?	0:Gray 1:B/W Small 2:B/W Large 3:Color 4:S-Color Small 5:S-Color Large
Paper Feed ON OFF	PFEED ON PFEED OFF	PFEED?	0: OFF 1: ON
BMP output mode select Color S-Color Gray B/W	HCIMAG COL HCIMAG SCOL HCIMAG GRY HCIMAG MON	HCIMAG?	0:Color 1:Gray 2:B/W 3:S-Color
File compression ON OFF	HCCMPRS ON HCCMPRS OFF	HCCMPRS?	0:OFF 1:ON
File Number	HCFILE *	HCFILE?	Number
Reading Bitmap file	—	BMP?	Binary data<EOI>
Device Select Printer Floppy	HCDEV PRT HCDEV FDD	HCDEV?	0:Printer 1:Floppy
Print ON	HCOPY	—	—
10 MHz internal reference signal source 10 MHz external reference signal source	RFI RFE	FREF?	0:INT 1:EXT
Number of trace points 501 Number of trace points 1001	TPS TPL	TP?	0:501 1:1001

**Table 4-19 Preset**

Function	Listener Code	Talker Request	
		Code	Output Format
Preset	IP *RST	— —	— —



Table 4-20 Test

Function	Listener Code	Talker Request	
		Code	Output Format
Selftest	—	*TST?	Error No.

Table 4-21 GPIB

Function	Listener Code	Talker Request	
		Code	Output Format
A Trace input/output(ASCII)	TAA	TAA?	DDDDD<DLM> × TRP(*1)
A Trace input/output(BINARY)	TBA	TBA?	2Byte × TRP
B Trace input/output(ASCII)	TAB	TAB?	DDDDD<DLM> × TRP
B Trace input/output(BINARY)	TBB	TBB?	2Byte × TRP
Status byte clear	*CLS	—	—
STB read	—	*STB?	Integer (0 to 255)
SRE read/write	*SRE *	*SRE?	Integer (0 to 255)
ESR read	—	*ESR?	Integer (0 to 255)
ESE read/write	*ESE *	*ESE?	Integer (0 to 255)
OSR read	—	OPREVT?	Integer (0 to 65535)
OSER read	OPR	OPR?	Integer (0 to 65535)
SRQ interruptON	S0	—	—
SRQ interrupt OFF	S1	—	—
SRQ status clear	S2	—	—
Service request mask	RQS *	RQS?	Integer (0 to 255)
Delimiter CR LF <EOI>	DL0	—	—
LF	DL1	—	—
<EOI>	DL2	—	—
CR LF	DL3	—	—
LF <EOI>	DL4	—	—

(\*1) TRP = Number of trace points (501/1001)  
 <DLM> = Delimiter

4.2.9 GPIB Command Codes

**Table 4-22 Others**

Function	Listener Code	Talker Request	
		Code	Output Format
Display ON Display OFF	ANNOT ON ANNOT OFF	ANNOT?	0:OFF 1:ON
Device ID output	—	*IDN?	Maker name, Device type, Serial No., Revision(*1)
Error number output	—	ERRNO?	Integer
Date setting	SETDATE DATE	SETDATE?	DATE(*2)
Time setting	SETTIME TIME	SETTIME?	TIME(*3)

- (\*1) (Example) ADVANTEST,R3132,123456789,A00
- (\*2) DATE in YYMMDD format.
- (\*3) TIME in HHMMSS format.

**Table 4-23 FM Demodulation (OPT73) (1 of 2)**

Function	Listener Code	Talker Request	
		Code	Output Format
FM Demod      ON OFF	FMDEM ON FMDEM OFF	FMDEM?	0: OFF (*1) 1: ON
FM Demod Range Hz/div	FMRNG *	FMRNG?	0: 1 kHz/div 1: 2.5 kHz/div 2: 5 kHz/div 3: 10 kHz/div 4: 25 kHz/div 5: 50 kHz/div 6: 100 kHz/div 7: 250 kHz/div 8: 500 kHz/div 9: 1 MHz/div 10: 2.5 MHz/div 11: 5 MHz/div 12: 10 MHz/div 13: 25 MHz/div 14: 50 MHz/div
Sensitivity    ON OFF	FMSEN ON FMSEN OFF	FMSEN?	0: OFF (*1) 1: ON
Sensitivity    Unit	—	FMSUN?	0: Hz/s/ 1: Hz/ms/

- (\*1) When FM Demod (Sensitivity) is turned on, the units of the following function's output levels are in frequency (Sensitivity): Marker level, Upper (Lower) Fail Point, display line, and reference line.

Table 4-23 FM Demodulation (OPT73) (2 of 2)

Function	Listener Code	Talker Request	
		Code	Output Format
Sensitivity Range	— FMSRNG *	FMSRNGS? FMSRNG?	R1,R2,R3,R4 (Frequency) 0: Range 1 (Minimum) 1: Range 2 2: Range 3 3: Range 4 (Maximum)
Sensitivity Aperture	FMAPR *	FMAPR?	Real number (1% to 100%)
Deviation ON OFF	FMDEV ON FMDEV OFF	FMDEV?	0: OFF 1: ON
Deviation (P-P)/2 +Peak -Peak Repetition Freq.	— — — —	FMAVG? FMPPK? FMNPK? FMRPF?	Frequency Frequency Frequency Frequency
Linearity ON OFF	FMLIN ON FMLIN OFF	FMLIN?	0: OFF 1: ON
Linearity Setup mode ON OFF (Quit) Auto Adj Sample Points Offset Adj Slope Adj	FMLMD ON FMLMD OFF FMLA FMLSMP * FMLOFS * FMLSPL *	FMLMD? — FMLSMP? FMLOFS? FMLSPL?	0: OFF 1: ON — Integer (2 to 100) Frequency Frequency
Linearity Error Max Min	— —	FMLMAX? FMLMIN?	Frequency Frequency
Calibration All Range Only	FMALL FMONLY	— —	— —

Table 4-24 TG (OPT74)

Function	Listener Code	Talker Request	
		Code	Output Format
TG on TG off	TG TGF	TG?	0:OFF 1:ON
TG level	TGL *	TGL?	Level
Frequency Cal AUTO Manual	TGA TGM *	— TGM?	— Frequency
Normalize ON Normalize OFF	NORM ON ANORM ON NORM OFF ANORM OFF	NORM? ANORM?	0:OFF 1:ON 0:OFF 1:ON
Normalize Execute	NORM EX AR	— —	— —
Save Item Normalize ON Normalize OFF	SVNRM ON SVNRM OFF	SVNRM?	0:OFF 1:ON

4.2.9 GPIB Command Codes

Table 4-25 Entry

Function	Listener Code	Talker Request	
		Code	Output Format
Numeric value entry	0	---	---
	1	---	---
	2	---	---
	3	---	---
	4	---	---
	5	---	---
	6	---	---
	7	---	---
	8	---	---
	9	---	---
Decimal point	.	---	---
Negative sign	-	---	---
Positive sign	+	---	---
Exponent	EXP E	---	---
GHz	GZ	---	---
MHz	MZ	---	---
KHz	KZ	---	---
Hz	HZ	---	---
mW	MW	---	---
DB relationship	DB	---	---
mA	MA	---	---
Second	SC	---	---
Millisecond	MS	---	---
	MSEC	---	---
Microsecond	US	---	---
	USEC	---	---
Nanosecond	NSEC	---	---
Enter	ENT	---	---
Volt	VOLT	---	---
Millivolt	MV	---	---
Microvolt	UV	---	---
Nanovolt	NV	---	---
%	PER %	---	---

## 4.2.10 Example Programs

This section describes remote control examples used with GPIB port.

### 4.2.10.1 Sample Programs for Setting or Reading Measurement Conditions

---

**CAUTION** *Visual Basic 4.0 (referred to as VB henceforth) is used in the sample programs shown here. Also, National Instruments-made GPIB board (referred to as NI-made for brevity henceforth) is used for the GPIB control board; NI-made driver is used for the control driver.*

---

- Program examples using VB

**Example VB-1:** Setting the center frequency after performing an analyzer master reset

```
Call ibclr(spa)           ' Performs a Device Clear.

Call ibwrt(spa, "IP")     ' preset
Call ibwrt(spa, "CF 30MZ") ' Set the center frequency to 30 MHz.
```

**Example VB-2:** Setting the start frequency to 300 kHz, setting the stop frequency to 800 kHz and adding 50 kHz to the frequency offset.

```
Call ibclr(spa)           ' Performs a Device Clear.
Call ibwrt(spa, "FA 300KZ") ' Set the start frequency to 300 kHz.
Call ibwrt(spa, "FB 800KZ") ' Set the stop frequency to 800 kHz.
Call ibwrt(spa, "FO 50KZ")  ' Add 50 kHz to the frequency offset.
```

**Example VB-3:** Setting the reference level to 87 dB $\mu$ V (in 5 dB/div) and the RBW to 100 kHz

```
Call ibclr(spa)           ' Performs a Device Clear.

Call ibwrt(spa, "AUNITS DBUV") ' Set the level unit to dB $\mu$ V.
Call ibwrt(spa, "RL 87DB")     ' Set the reference level to 87 dB ( $\mu$ V).
Call ibwrt(spa, "DD 5DB")      ' Set the vertical gradation to 5 dB/div.
Call ibwrt(spa, "RB 100KZ")    ' Set the RBW to 100 kHz.
```

**Example VB-4:** Setting the instrument using variables

```
Dim A As String
Dim B As String
Dim C As String

A = "10"
B = "2"
C = "20"

Call ibclr(spa)           ' Performs a Device Clear.

Call ibwrt(spa, "CF " & A & "MZ") ' Set the start frequency to A MHz.
Call ibwrt(spa, "SP " & B & "MZ") ' Set the span frequency to B MHz.
Call ibwrt(spa, "AT " & C & "DB") ' Set the ATT to C dB.
```

## 4.2.10 Example Programs

**Example VB-5: Saving set values in Register 5 and recalling them from Register 5**

```

Dim LabelBuff As String          ' Character string buffer for the label

LabelBuff = "SPECTRUM Analyzer" ' Set the label.

Call ibclr(spa)                  ' Performs a Device Clear.

Call ibwrt(spa, "CF 30MZ")       ' Set the parameter.
Call ibwrt(spa, "SP 1MZ")
Call ibwrt(spa, "DEF POS")
Call ibwrt(spa, "LON " & LabelBuff) ' Set the label.

Call ibwrt(spa, "SV 5")         ' Save the data in Register 5.

Call ibwrt(spa, "CF 1GZ")       ' Change the set parameters.
Call ibwrt(spa, "SP 200MZ")

Call ibwrt(spa, "RC 5")         ' Recall the data from Register 5.

```

**Example VB-6: Enter Limit line1 in the table and turn Limit line 1 on**

```

Call ibclr(spa)                  ' Perform a device clear.

Call ibwrt(spa, "LMTADEL")      ' Clear the table used for Limit Line 1.
Call ibwrt(spa, "AUNITS DBUV") ' Set the unit of level to dBµV.

Call ibwrt(spa, "LMTAIN 25MZ, 49.5DB") ' Enter data use by Limit Line 1.
Call ibwrt(spa, "LMTAIN 35MZ, 49.5DB")
Call ibwrt(spa, "LMTAIN 35MZ, 51.5DB")
Call ibwrt(spa, "LMTAIN 55MZ, 51.5DB")
Call ibwrt(spa, "LMTAIN 55MZ, 54.3DB")
Call ibwrt(spa, "LMTAIN 65MZ, 54.3DB")
Call ibwrt(spa, "LMTAIN 65MZ, 57.0DB")
Call ibwrt(spa, "LMTAIN 68MZ, 57.0DB")
Call ibwrt(spa, "LMTAIN 68MZ, 60.0DB")
Call ibwrt(spa, "LMTAIN 75MZ, 60.0DB")
Call ibwrt(spa, "LMTAIN 75MZ, 62.5DB")
Call ibwrt(spa, "LMTAIN 82MZ, 62.5DB")
Call ibwrt(spa, "LMTAIN 82MZ, 64.7DB")

Call ibwrt(spa, "FA 0MZ")       ' Start frequency of 0 MHz
Call ibwrt(spa, "FB 100MZ")    ' Stop frequency of 100 MHz
Call ibwrt(spa, "LMTA ON")     ' Turn Limit line 1 on.

```

**Example VB-7: Sample Program of the Gated Sweep**

```

Call ibclr(spa)                  ' Perform a device clear.

Call ibwrt(spa, "GTSRC EXT")    ' Set the Gate signal source to EXT.
Call ibwrt(spa, "GTSLP +")     ' Set the Gate signal slope to plus (+).
Call ibwrt(spa, "GTWID 10MS")  ' Set the window width of the gated sweep to 10 msec.
Call ibwrt(spa, "GTPOS 10US")  ' Set the window position of the gated sweep to 10 µsec.
Call ibwrt(spa, "GTSWP ON")    ' Turn the gated sweep on.

```

### 4.2.10.2 Sample Programs for Reading Data

In order to output measurement data or settings, use the "xx?" command. This ensures that the data is read when the device is in the talker mode. Available output formats are listed in the table below. The delimiter positioned at the end of data can be specified from 5 types (refer to "Others" in the GPIB code list). Once set, "xx?" command continues to operate until it is changed.

Output Format	
Frequency	$\pm$ <u>D.DDDDDDDDDDD</u> <u>E ± DD</u> <u>CR LF</u> ↑            ↑            ↑            ↑ 1            2            3            4 • Data size (1 to 3) is a maximum of 19 bytes, and the unit is Hz. Example Specify "CF?" and output as center frequency.
Level	$\pm$ <u>D.DDDDDDD</u> <u>E ± DD</u> <u>CR LF</u> ↑    ↑            ↑            ↑ 1    2            3            4 • Data size (1 to 3) is a maximum of 19 bytes, and the unit corresponds to each UNIT setting. Example Specify "ML?" and output as marker level.
Time	$\pm$ <u>D.DDD</u> <u>E ± DD</u> <u>CR LF</u> ↑    ↑            ↑            ↑ 1    2            3            4 • Data size (1 to 3) is a maximum of 19 bytes, and the unit is sec. Example Specify "SW?" and output sweep time.
	<u>DDDD</u> <u>CR LF</u> ↑            ↑ 2            4 • The maximum byte of the data size corresponds to the maximum size of the output data. Example ON/OFF status or Averaging count is output.

- <Supplement>
- 1= Sign (a space for plus sign; "-" for minus sign)
  - 2= Mantissa of data
  - 3= Exponent of data
  - 4= Delimiter (CR/LF in initial setting can be changed with "DLn" code.)

4.2.10 Example Programs

**Example VB-8: Output the marker level**

```

Dim sep As Integer

Call ibclr(spa) ' Perform a device clear.

Call ibwrt(spa, "CF 30MZ") ' Set the parameter.
Call ibwrt(spa, "SP 1MZ")
Call ibwrt(spa, "MK 30MZ") ' The marker frequency is set to 30 MHz.
Call ibwrt(spa, "TS")

Call ibwrt(spa, "ML?") ' Query command for the marker level.

Rdbuf = Space(30) ' Allocate a total of 30 bytes to the buffer area.

Call ibrd(spa, Rdbuf) ' Read the data (30 bytes Max.).
sep = InStr(1, Rdbuf, vbCrLf, 0) ' Check the number of character to the delimiter.
RichTextBox1.Text = "MarkerLevel = " & Left(Rdbuf, sep - 1)
' Outputs the data on the screen.

An example display:
MarkerLevel = -8.818750000000E+01
    
```

**Example VB-9: Reading the center frequency and displaying it**

```

Dim sep As Integer

Call ibclr(spa) ' Performs a Device Clear.

Call ibwrt(spa, "CF?") ' Query command for the center frequency.

Rdbuf = Space(30) ' Allocate the buffer memory space to 30 bytes.
Call ibrd(spa, Rdbuf) ' Read the data (30 bytes Max.)
sep = InStr(1, Rdbuf, vbCrLf, 0) ' Check the number of characters prior to the delimiter.
RichTextBox1.Text = "CenterFreq = " & Left(Rdbuf, sep - 1)
' Display the data on the screen.

An example display:
CenterFreq = +3.000000000000E+07
    
```



**Example VB-10:** Reading the level and display unit and displaying them

```

Dim sep As Integer

Call ibclr(spa) ' Performs a Device Clear.

Call ibwrt(spa, "RL?") ' Query command for the reference level.

Rdbuf = Space(30) ' Allocate the buffer memory space to 30 bytes.
Call ibrd(spa, Rdbuf) ' Read the data (30 bytes Max.) from the spectrum analyzer.
sep = InStr(1, Rdbuf, vbCrLf, 0) ' Check the number of characters prior to the delimiter.
RichTextBox1.Text = "RefLevel = " & Left(Rdbuf, sep - 1) ' Display the data on the screen.

Call ibwrt(spa, "AUNITS?") ' Query command for the level unit

Rdbuf = Space(3)
Call ibrd(spa, Rdbuf)
sep = InStr(1, Rdbuf, vbCrLf, 0) ' Check the number of characters prior to the delimiter.
RichTextBox1.Text = RichTextBox1.Text & vbCrLf & "UNIT = " & Left(Rdbuf, sep - 1) ' Display the previous result, followed by a return mark and the
' most recent result.

An example display:
RefLevel = +0.000000000000E+00
UNIT = 0

```

**Example VB-11:** Executing the 6 dB-down operation, reading the frequency and level and displaying them

```

Dim sep As Integer

Call ibclr(spa) ' Performs a Device Clear.

Call ibwrt(spa, "CF 30MZ") ' Set the parameter.
Call ibwrt(spa, "SP 20MZ")

Call ibwrt(spa, "MKBW 6DB") ' Set a 6 dB down measurement.
Call ibwrt(spa, "PS") ' Peak search.
Call ibwrt(spa, "XDB") ' Perform the 6 dB down measurement.
Call ibwrt(spa, "MFL?") ' Query command for the marker level and frequency.

Rdbuf = Space(50) ' Allocate the buffer memory space to 50 bytes.
Call ibrd(spa, Rdbuf) ' Read the data (50 bytes Max.) from the spectrum analyzer.

sep = InStr(1, Rdbuf, vbCrLf, 0) ' Check the number of characters prior to the delimiter.

RichTextBox1.Text = "Marker Freq & Level = " & Left(Rdbuf, sep - 1) ' Display the data on the screen.

An example display:
Marker Freq & Level = +2.000000000000E+05, +1.023437500000E+00

```

4.2.10 Example Programs

**Example VB-12:** Measuring OBW and displaying it

```

Dim LENG1 As Integer, LENG2 As Integer
Dim OBW As String
Dim FC As String
Dim searchchar As String

Call ibclr(spa) ' Perform a device clear.

Call ibwrt(spa, "CF 30MZ") ' Send the command already set.
Call ibwrt(spa, "SP 1MZ")
Call ibwrt(spa, "MK 30MZ")
Call ibwrt(spa, "OBW ON")
Call ibwrt(spa, "TS")

Call ibwrt(spa, "OBW?") ' Send the query command.
Rdbuf = Space(60) ' Allocate the area to the read buffer.
Call ibrd(spa, Rdbuf) ' Read the read buffer (the maximum number of bytes to be output
' is determined by the buffer area size).

' Formatting output character string
LENG1 = InStr(1, Rdbuf, Chr(44), 0) ' Search for the first comma.
FC = Mid(Rdbuf, 1, LENG1 - 1) ' Read the character prior to the comma.

DoEvents

LENG2 = InStr((LENG1 + 1), Rdbuf, Chr(13), 0) 'Determine the last data by searching for the delimiter.
OBW = Mid(Rdbuf, (LENG1 + 1), (LENG2 - LENG1 - 1))
' Read the data between the second comma and the delimiter.

RichTextBox1.Text = "OBW = " & OBW & vbCrLf & "Fc = " & FC & vbCrLf
' Display the data on the screen.

An example display:
OBW = +9.810000000000E+05
FC = +3.000250000000E+07
    
```

**Example VB-13:** Reading and displaying the three largest peak levels

```

Dim pk1 As String, pk2 As String, pk3 As String

Call ibclr(spa) ' Perform a device clear.
Call ibwrt(spa, "CF 0MZ") ' Apply the settings.
Call ibwrt(spa, "SP 100MZ")

Call ibwrt(spa, "PS") ' Search for the peak.
Call ibwrt(spa, "ML?") ' Query command to search for the marker level
Rdbuff = Space(25) ' Reserve buffer memory space.
Call ibrd(spa, Rdbuff) ' Receives the output.
pk1 = LeftB(Rdbuff, (InStrB(1, Rdbuff, Chr(13), 1) - 1))
' Read the data between the starting point and the delimiter.

Call ibwrt(spa, "NXP") ' Search for the next peak.
Call ibwrt(spa, "ML?")
Rdbuff = Space(25)
Call ibrd(spa, Rdbuff)
pk2 = LeftB(Rdbuff, (InStrB(1, Rdbuff, Chr(13), 1) - 1))
' Read the data between the starting point and the delimiter.

Call ibwrt(spa, "NXP")
Call ibwrt(spa, "ML?")
Rdbuff = Space(25)
Call ibrd(spa, Rdbuff)
pk3 = LeftB(Rdbuff, (InStrB(1, Rdbuff, Chr(13), 1) - 1))
' Read the data between the starting point and the delimiter.

RichTextBox1.Text = "1st PK = " & pk1 & vbCrLf & "2nd PK = " & pk2 & vbCrLf & "3rd PK = " & pk3 & vbCrLf
' Display the data on the screen.

```

An example display:  
1st PK = -8.553906250000E+01  
2nd PK = -7.004687500000E+01  
3rd PK = -8.655468750000E+01

4.2.10 Example Programs

**4.2.10.3 Sample Programs for Inputting or Outputting Trace Data**

Trace data on the screen includes data for 501 or 1001 points on the frequency axis. For inputting and outputting data, it is necessary to transfer data for 501 or 1001 points from the left side (start frequency) in order. Each point level is expressed by an integer from 1792 to 14592 (however, if the trace exceeds the upper limit of the vertical scale, a value greater than 14592 is transferred).

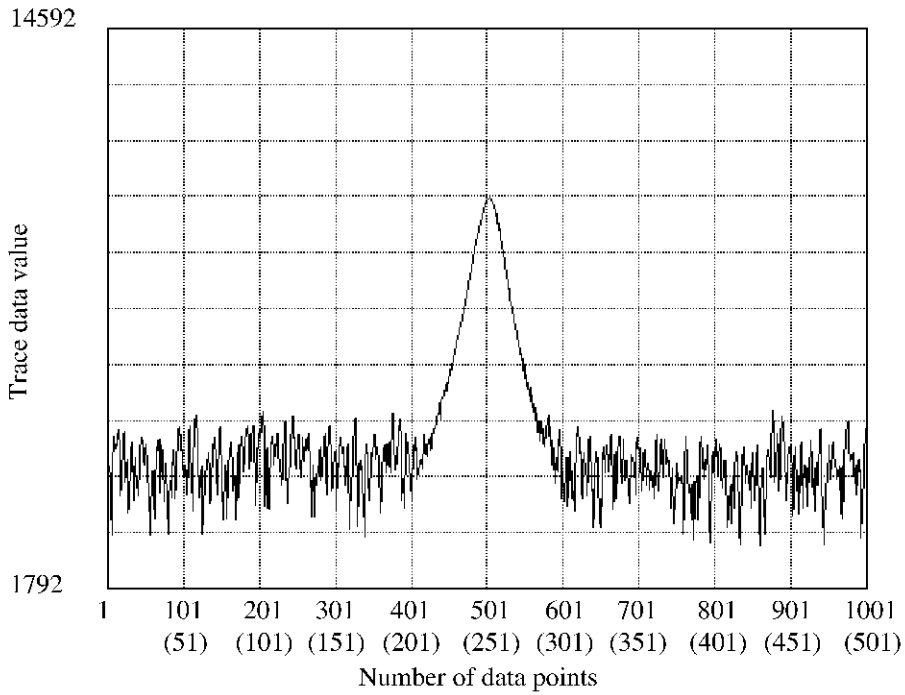

**Figure 4-4 Relationship between Screen Graticule and Trace Data**

Trace data can be input or output in either ASCII or binary format.

**Table 4-26 Trace Accuracy Specification Codes**

GPIB Code	Description
TPS	Sets the number of measurement points to 501.
TPL	Sets the number of measurement points to 1001.

Table 4-27 I/O format

I/O format	Description		
ASCII format	<p style="text-align: center;"> <u>DDDDD</u>    CR LF            ↑            ↑                      Delimiter            Data for one point            Five-byte data without header         </p>		
			Input GPIB code
	Memory A Memory B	TAA TAB	TAA? TAB?
Binary format	<p style="text-align: center;"> <u>DD</u>    <u>DD</u>    .....    <u>DD</u>    <u>DD</u> + EOI            ↑            ↑                            ↑            ↑            ↑            ↑                            ↑            ↑            Low-order byte                            Low-order byte            for 1st point                                for 1001/501st point            High-order byte                            High-order byte            for 1st point                                for 1001/501st point            Delimiter         </p> <p>Each point data is divided into two parts: high-and low-order bytes. EOI signal is attached at the end of the data for continuous 1001/501 points.</p>		
			Input GPIB code
	Memory A Memory B	TBA TBB	TBA? TBB?

## 4.2.10 Example Programs

**Example VB-14:** Read the trace data in ASCII format

```

Dim tr(1000) As String          ' Allocate an array in the buffer for 1001 points.
Dim i As Integer
Dim res As String

Call ibclr(spa)                ' Perform a device clear.

Call ibwrt(spa, "DL0")        ' CR LF EOI
Call ibwrt(spa, "DET NEG")    ' Set it to the negative detector.
Call ibwrt(spa, "TAA?")

For i = 0 To 1000 Step 1      ' Repeat the operation for 1001 points.
    tr(i) = Space(7)          ' Allocate a total of 7 bytes (5 bytes for the data, and 2 bytes for
                                ' delimiters).
    Call ibrd(spa, tr(i))      ' Read the data.
                                ' Output it to the screen.
    res = res & "tr(" & Str(i) & ") = " & Left(tr(i), 5) & vbCrLf
    DoEvents
Next i

RichTextBox1.Text = res

```

**Example VB-15:** Read the A memory data in binary format

```

Dim tr(1000) As Integer       ' Allocates an array in the buffer for 1001 points.
Dim i As Integer
Dim res As String

Call ibclr(spa)               ' Performs a device clear.
Call ibconfig(0, IbcEndBitsNormal, 0) ' Sets the GPIB-board software so that the End bit of the IbstA
                                ' variables is set to 1 only when EOI has been received.
Call ibconfig(spa, IbcReadAdjust, 1) ' Sets the spectrum analyzer so that the upper byte is swapped for
                                ' the lower byte during a read operation.

Call ibwrt(spa, "DL2")        ' Sets the delimiter to EOI only.
Call ibwrt(spa, "DET NEG")    ' Sets it to the negative detector.
Call ibwrt(spa, "TBA?")      ' Query for Trace A in binary data

Call ibrdi(spa, tr(), 1001 * 2) ' Reads binary data for 1001 points.

For i = 0 To 1000 Step 1      ' Repeats the operation for 1001 points.
    res = res & Str(tr(i)) & vbCrLf ' Outputs it to the screen.
    DoEvents
Next i

RichTextBox1.Text = res

Call ibwrt(spa, "DL0")        ' Sets the delimiter to the CR, LF and EOI.
Call ibconfig(0, IbcEndBitsNormal, 1) ' Resets the GPIB software to the standard settings.
Call ibconfig(spa, IbcReadAdjust, 0)

```

**Example VB-16:** Enter data into A memory in ASCII mode  
(When the 501 point mode is set, change 1001 and 1000 to 501 and 500, respectively.)

```
Dim trdata(1000) As Integer
Dim i As Integer

trdata(0) = 1792
For i = 1 To 1000 Step 1
    trdata(i) = Str(Val(trdata(i - 1)) + 12)
    DoEvents
Next i

Call ibclr(spa)
Call ibwrt(spa, "AB")
Call ibwrt(spa, "TAA")

For i = 0 To 1000 Step 1
    Call ibwrt(spa, CStr(trdata(i)))
    DoEvents
Next i

Call ibwrt(spa, "AV")
```

' Provide a temporary data used to test the input (\*).

' When there is the data, the steps between the place marked with  
' (\*) and this point are not required.

' Perform a device clear.

' Set Trace A to BLANK.

' Set Trace A in ASCII.

' Repeats the operation for 1001 points.

' Sends the value after it has been converted to the ASCII data.

' Set Trace A to VIEW.

## 4.2.10 Example Programs

## 4.2.10.4 Example program using the TS (Take Sweep) command

**Example VB-17:** An ACP measurement is taken and then the measurement result is read (using the TS command).

```

Dim state As Integer
Dim sep1 As Integer, sep2 As Integer
Dim i As Integer, j As Integer
Dim cnt As Integer
Dim LvIH As String, LvIL As String
Dim FrqH As String, FrqL As String

Call ibclr(spa) 'A device clear is carried out.

Call ibwrt(spa, "SI") 'Set the single mode.
Call ibwrt(spa, "CF 1500MZ") 'Set the center frequency to 1500 MHz.
Call ibwrt(spa, "SP 250KZ") 'Set the frequency span to 250 kHz.
Call ibwrt(spa, "RB 1KZ") 'Set RBW to 1 kHz.
Call ibwrt(spa, "VB 3KZ") 'Set VBW to 3 kHz.
Call ibwrt(spa, "ST 20SC") 'Set the sweep time to 20 sec.
Call ibwrt(spa, "CSBSDEL") 'Clear the channel space and bandwidth previously set.
Call ibwrt(spa, "CSBSIN 50KZ,21KZ") 'Set CS to 50 kHz, and BS to 21 kHz.
Call ibwrt(spa, "OPR 256") 'The Avercaging bit of the operation register is set
to ENABLE.

Call ibwrt(spa, "*CLS") 'Clear STATUS byte
Call ibwrt(spa, "S0") 'SRQ is enabled.
Call ibwrt(spa, "ACP ON") 'Start the ACP measurement.

For j = 1 To 10 Step 1
Call ibwrt(spa, "TS") 'Execute one sweep.
Call ibwrt(spa, "ACP?") 'The ACP measurement result has been requested.
Rdbuf = Space(3) 'Assign an area for 1 byte of integer and 2 bytes of delimiter prior
to reading the result.

Call ibrd(spa, Rdbuf) 'Read the data.
cnt = CInt(Rdbuf) 'Convert the contents of the buffer into integer type data.

For i = 1 To cnt Step 1
Rdbuf = Space(81) 'Assign an area of 81 bytes (Real number x 4 + ', ' x 3 + CRLF).
Call ibrd(spa, Rdbuf) 'Read the data.

sep1 = InStr(1, Rdbuf, ",", 0) 'Search for the first comma starting from the top of the buffer.
FrqL = Left(Rdbuf, sep1 - 1) 'Read the string between the top and the character string.
sep2 = InStr(sep1 + 1, Rdbuf, ",", 0) 'Search for the next comma.
LvIL = Mid(Rdbuf, sep1 + 1, sep2 - sep1 - 1) 'Read the string between the first and second separators (com-
mas).

sep1 = InStr(sep2 + 1, Rdbuf, ",", 0) 'Search for the third comma.
FrqH = Mid(Rdbuf, sep2 + 1, sep1 - sep2 - 1) 'Read the string between the second and third separators (com-
mas).

sep2 = InStr(sep1, Rdbuf, Chr(13), 0) 'Search for the terminator (CR).
LvIL = Mid(Rdbuf, sep1 + 1, sep2 - sep1 - 1) 'Read the string between the separators (third comma and CR).

'Displays the result on the screen.
RichTextBox1.Text = RichTextBox1.Text & FrqL & "Hz;" & LvIL & vbCrLf
RichTextBox1.Text = RichTextBox1.Text & FrqH & "Hz;" & LvIL & vbCrLf

Next i
DoEvents
Next j

```



### 4.2.10.5 Program Examples Using the Status Byte

**Example VB-18:** Execute single sweeping and wait until its finished (when not using SRQ)

```

Dim state As Integer

Call ibclr(spa) ' Performs a Device Clear.
Call ibwrt(spa, "SI") ' Turn the single sweep mode on.
Call ibwrt(spa, "OPR8") ' Enables Sweep-end bit of operation status register
Call ibwrt(spa, "*CLS") ' Clear the status byte.
Call ibwrt(spa, "SI") ' Begin sweeping.

Do

    Call ibwrt(spa, "*STB?") ' Query command to read the status byte.
    Rdbuf = Space(8) ' Reserve a maximum of 8 bytes including the delimiter.
    Call ibrd(spa, Rdbuf) ' Read the data.
    state = Val(Rdbuf) ' Convert the character string into numeric values.

    DoEvents ' Check the loop for other events currently taking place.
Loop Until (state And 128) ' Exit from the loop if the sweep-end bit is set to 1.

```

**Example VB-19:** Reading the peak frequency and level at the end of a single sweep (when using SRQ)

```

Dim boardID As Integer
Dim I As Integer
Dim res As Integer
Dim CFLEV As String

boardID = 0 ' Set the board ID.

Call ibclr(spa) ' Performs a Device Clear.

Call ibwrt(spa, "SI") ' Turn the single sweep mode on.

Call ibwrt(spa, "*CLS") ' Clear the status byte.
Call ibwrt(spa, "OPR 8") ' Enables the Sweep-end bit of the operation status register
Call ibwrt(spa, "*SRE 128") ' Enables the Operation status bit of the status byte.
Call ibwrt(spa, "S0") ' Specify Send mode for the SRQ signal.

For I = 1 To 10 Step 1 ' A loop of 10 times
    Call ibwrt(spa, "SI") ' Begin sweeping
    Call WaitSRQ(boardID, res) ' Wait until SRQ interruption occurs.
    Call ibrsp(spa, res) ' Execute serial polling.

    Call ibwrt(spa, "PS") ' Execute the peak search.
    Call ibwrt(spa, "MFL?") ' Query for marker frequency and level

    Rdbuf = Space(43) ' Reserve 43 bytes.
    Call ibrd(spa, Rdbuf) ' Read the data.

    CFLEV = Left(Rdbuf, InStr(1, Rdbuf, Chr(13), 0) - 1)
    RichTextBox1.Text = RichTextBox1.Text & "Freq ,Label = " & CFLEV & vbCrLf
    ' Display data on the screen and start a new line.

    DoEvents ' Execute other events in Windows if any.
Next I

```

## 4.2.10 Example Programs

### 4.2.10.6 Example Program Used to Read Screen Data

**Example VB-20:** Outputting the current screen data in bitmap format and saving it into the file (bitmap.bmp)

---

**NOTE:** *Depending on the copy image, compression of files and screen status, the amount of bitmap data varies. A data file of up to 300 KB can be output.*

---

Tmo%=14	' A timeout of 30 sec.
Call ibtmo(spa,tmo%)	' A timeout of 30 seconds is set.
Call ibwrt(spa,"DL2")	' Selects only EOI as a delimiter.
Call ibwrt(spa,"HCIMAG SCOL")	' Sets a simple color image to make a copy.
Call ibwrt(spa,"HCCMPRS OFF")	' Turns the compression mode off.
Call ibwrt(spa,"BMP?")	' Requests the bitmap data output.
Call ibrdl(spa,"bitmap.bmp")	' Saves the bitmap data into the file.
Call ibwrt(spa,"DL0")	' Changes the delimiter back to CR, LF and EOI.

### 4.3 RS-232 Remote Control Function

Most controllers (such as personal computers) do not have a GPIB interface, but the R3132 series can still be controlled using the RS-232 interface.

#### 4.3.1 GPIB and RS-232 Compatibility

The control codes and functions are the same as those used for serial control, except for those which especially refer to the GPIB interface.

#### 4.3.2 Features of RS-232 Remote Control

The following functions can be controlled by serial control.

- Measurement conditions setup: Measurement conditions each can be input in much the same as the key operation on the front panel.
- Output of the setup status: Both the setup status and data can be read out.
- Status: Status bytes which show the current status of the spectrum analyzer can be read out in the same way GPIB readouts.

#### 4.3.3 Parameter Setup Window

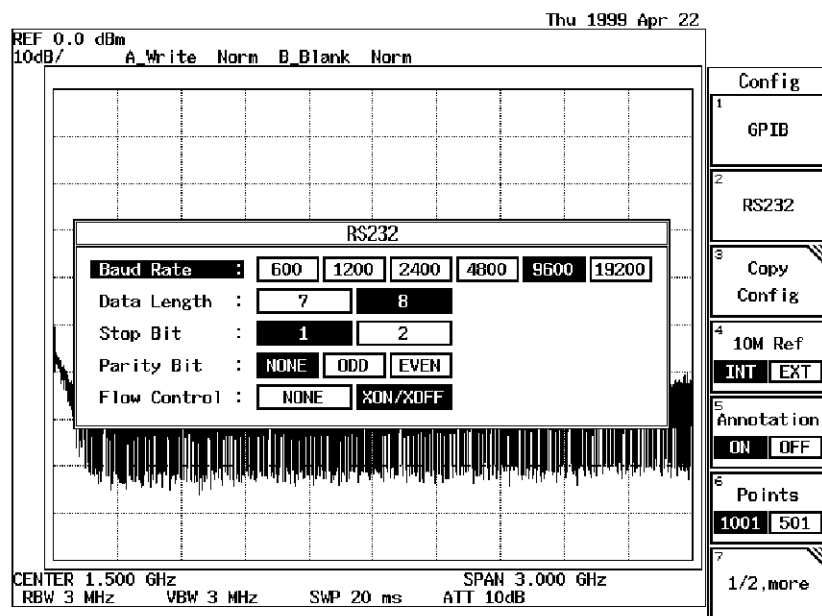
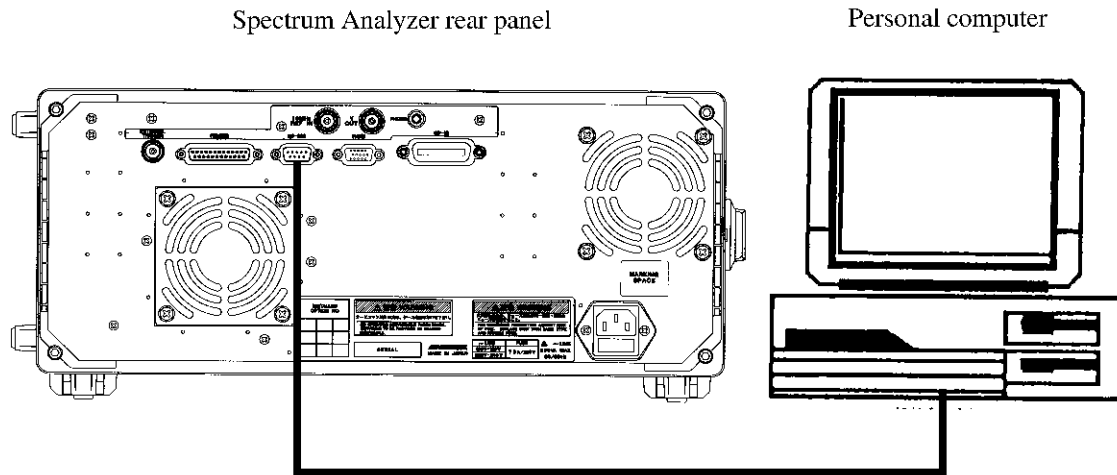

Figure 4-5 Parameter Setup

1. Baud Rate: Select from 600, 1200, 2400, 4800, 9600 or 19200.
2. Data length: Select seven bits or eight bits as the number of data bits.
3. Stop bit: Select one or two bits.
4. Parity check: Select from NONE, ODD or EVEN.
5. Flow control: Selects whether or not to use flow control XON/XOFF.

#### 4.3.4 Interface connection

#### 4.3.4 Interface connection



**Figure 4-6 Connection Between the Controller and the Spectrum Analyzer**

Although the spectrum analyzer uses only three pins, the controller side needs more connections for input and output.

---

**NOTE:**

1. When you send or receive data using the cable connections shown in Figure 4-6, set XON/XOFF to valid (ON).
  2. DCD, DTR and DSR are not used in the spectrum analyzer. When you use CTS and RTS, use a cable with cross-connection to connect the controller to the spectrum analyzer. Flow control is not performed using CTS or RTS. Set XON/XOFF to valid (ON) to perform flow control.
-

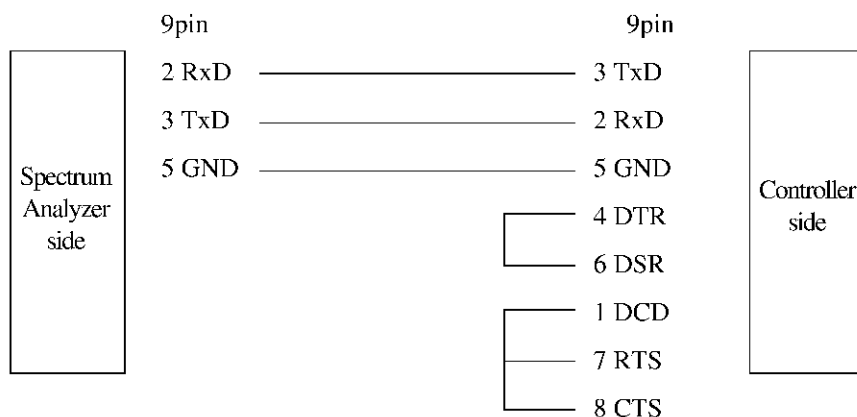

Pin No.(9pin)	Signal name	Contents
1	DCD:Data Carrier Detector	Receive carrier detection
2	RxD: Receive Data	Receive data
3	TxD: Transmit Data	Transmission data
4	DTR: Data Terminal Ready	Data terminal ready
5	GND: Ground	Signal ground
6	DSR: Data set Ready	Data set ready
7	RTS: Request To Send	Request signal for sending
8	CTS: Clear to Send	Clear signal for sending
9	CI:	N.C

Figure 4-7 Cable Wiring Diagram

### 4.3.5 Data Format

Transmission messages between the spectrum analyzer and the controller are in ASCII code character strings and followed by carriage returns (CR) and line feeds (LF).

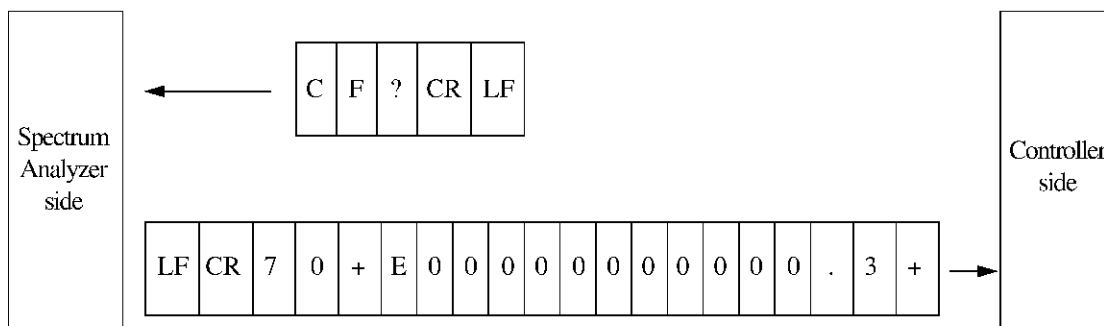

Figure 4-8 Data Format

#### 4.3.6 Differences Between RS-232 and GPIB

---

**NOTE:**

1. *Transmission data must be in ASCII code.*
  2. *Delimit the data from the controller with CR or CR and LF. Query data and the GPIB delimiters are the same. Therefore, send DL0 or DL3 after serial port was opened (refer to the example of RS-232 remote program).*
- 

Data transmission example: Personal computers can recognize both CF 30.0MZ CR and CF 30.0MZ CR LF.

The format for query data is +3.0000000000E+07 CR LF (send DL0 or DL3). The output data of this RS-232 and GPIB are the same number of characters except delimiters (CR and LF).

#### 4.3.6 Differences Between RS-232 and GPIB

- Command code  
Trace data can be input or output in the ASCII format only.
- 

**CAUTION** *The following commands are unavailable: TBA and TBB.*

---

#### 4.3.7 Panel Control

During remote control operation, spectrum analyzer panel control is affected as follows.

- The remote lamp does not light.
  - The key panel is not disabled.
- 

**CAUTION** *If any settings are changed during remote control, the operation of the spectrum analyzer may become unstable.*

---

### 4.3.8 Remote Control Usage Examples

The following examples show typical remote control commands, and are written in “Microsoft Quick Basic” (licensed by Microsoft Corporation).

The Open command statement OPEN” COM1: 9600, N, 8, 1, ASC” FOR RANDOM AS #1 shown below has the following characteristics: baud rate is 9600 bps, no parity, 8 bit data length, stop bit of 1, ASCII format and random access mode.

**Example:** This program is used to check the status byte register to see if the sweep has been completed.

```
OPEN "COM1:9600,N,8,1,ASC" FOR RANDOM AS #1
PRINT #1, "DL3"           ' CR and LF are set as the GPIB delimiter.
PRINT #1, "ST"           ' Single sweep is performed.
PRINT #1, "OPR8"        ' Sweep completion bit in the GPIB operation register is set.
PRINT #1, "CLS"         ' Clearing the status bytes.
PRINT #1, "SI"          ' Single sweep is performed.
MEAS.LOOP:
PRINT #1, "*STB?"       ' Read out the status bytes.
INPUT #1, STAT
IF (STAT AND 128) = 0 THEN GOTO MEAS.LOOP
PRINT #1, "PS"          ' Peak search.
PRINT #1, "ML?"        ' Read out the peak level.
INPUT #1, MLEVEL
PRINT MLEVEL
CLOSE #1
END
```





## 5 PERFORMANCE VERIFICATION

### 5.1 General

(1) Introduction

This chapter provides performance verification procedures item by item as listed in Table 5-1.

Performance verification items for Tracking Generator are listed in Table 5-2.

Table 5-3 lists the performance verification items used for the FM Demodulation.

**Table 5-1 Performance Verification Items**

No.	Items	Applicable Model				
		R3132	R3132N	R3162	R3172	R3182
1	Reference Oscillator Accuracy	○	○	○	○	○
2	CAL OUT Amplitude Accuracy	○	○	○	○	○
3	Displayed Average Noise	○	○	○	○	○
4	RBW Switching Error	○	○	○	○	○
5	RBW Accuracy	○	○	○	○	○
6	QP bandwidth	○	○	○	○	○
7	IF Gain Uncertainty	○	○	○	○	○
8	Attenuator Switching Accuracy	○	○	○	○	○
9	Scale Fidelity	○	○	○	○	○
10	Residual FM	○	○	○	○	○
11	Noise sideband	○	○	○	○	○
12	Image, Multiple, Out of Band Response	×	×	○	○	○
13	Frequency Read Out Accuracy	○	○	○	○	○
14	Second Harmonic Distortion	○	○	○	○	○
15	Frequency Response	○	○	○	○	○
16	Span Accuracy	○	○	○	○	○
17	Third Order Intermodulation Distortion	○	○	○	○	○
18	Gain Compression	○	○	○	○	○
19	Sweep Time Accuracy	○	○	○	○	○
20	Residual Response	○	○	○	○	○

○: Apply

×: Not Apply

5.1 General

**Table 5-2 Performance Verification Items for Tracking Generator**

No.	Items	Applicable Model				
		R3132	R3132N	R3162	R3172	R3182
1	Absolute Output Level Accuracy	○	○	○	○	×
2	Output Flatness	○	○	○	○	×
3	Output Level Changeover error	○	○	○	○	×
4	Harmonic Distortion	○	○	○	○	×
5	Non-harmonic Distortion	○	○	○	○	×
6	TG Leakage	○	○	○	○	×

○: Apply

×: Not Apply

**Table 5-3 Performance Verification Items for FM Demodulation**

No.	Items	Applicable Model				
		R3132	R3132N	R3162	R3172	R3182
1	Offset error (Internal mixer mode)	○	○	○	○	○
2	Linearity error (Internal mixer mode)	○	○	○	○	○
3	Offset error (External mixer mode)	×	×	×	○	○
4	Linearity error (External mixer mode)	×	×	×	○	○

○: Apply

×: Not Apply

(2) Test Equipment

The test equipment are listed in Table 5-4.

The equipment needed to perform all of the performance test.

Equipment lists for individual tests are provided in each performance verification.

Any equipment that meets the critical specifications given in the table can be substituted for the recommended models.

(3) Calibration Cycle

The performance verifications should be used to check the spectrum analyzer against its specifications every one year recommended.

(4) Performance Verification Record Sheets

The performance verification record sheets at the end of this chapter is provided the value measured in each performance verification.

The test record lists test specification and acceptable limits.

Recommend that make a copy of this table, record the complete test results on the copy, and keep the copy for calibration test record.

This record could prove invaluable in tracking gradual changes in test result over long periods of the time.

(5) Performance Verification Procedures

Typeface conventions used in this manual.

- Panel keys and soft keys are printed in a contrasting typestyle to make them stand out from the text as follows:

Panel keys: Boldface type            Example: **FREQ, CONFIG**

Soft keys: Boldface and Italic        Example: ***Center, Copy Config***

- When a series of key operations are described using a comma between two keys.
- There are various soft menus used to switch between two states such as ON/OFF and AUTO/MNL.

For example, when turning off the Disp Line ON/OFF function, the annotation

***“Disp Line ON/OFF(OFF)”*** is used.

When switching the RBW AUTO/MNL function to MNL, the annotation

***“RBW AUTO/MNL(MNL)”*** is used.

## 5.1 General

Table 5-4 Instrument Required (1 of 3)

No.	Instrument	Specification	Recommended Model	Qty.
1	Frequency Standard	Output Frequency: 10 MHz Stability: $5 \times 10^{-6}$ /day Output Impedance: $50 \Omega$ Output Level: 1 V <sub>pp</sub> or more	R3031 ADVANTEST	1
2	Frequency Counter	Resolution: 0.1 Hz	R5372 ADVANTEST	1
3	Signal Generator	Frequency Range: 10 MHz to 18 GHz Output Level: -15 dBm to +10 dBm Stability: $1 \times 10^{-6}$ /year	SMP02 (with B11 option) Rohde&Schwarz	1
4	Signal Generator	Frequency Range: 10 MHz to 40 GHz Output Level: -15 dBm to +10 dBm Stability: $1 \times 10^{-6}$ /year	SMP04 (with B11 option) Rohde&Schwarz	1
5	Signal Generator	Frequency Range: 300 MHz to 2.2 GHz Output Level: -20 dBm to +10 dBm Residual SSB Phase Noise at 20 kHz offset: less than -116 dBc/Hz	SMIQ02E Rohde&Schwarz	1
6	Signal Generator	Frequency Range: 5 kHz to 1.5 GHz Output Level: -20 dBm to +10 dBm Pulse period: 40 $\mu$ s to 45 s Pulse width: 20 $\mu$ s to 1 s	SMT02 (with B1, B3 and B4 option) Rohde&Schwarz	1
7	Spectrum Analyzer	Frequency Range: 100 Hz to 8 GHz	R3267 ADVANTEST	1
8	Power Meter	Compatible with NRV series power sensors dB relative mode Resolution 0.01 dB Reference Accuracy 0.9%	NRVS Rohde&Schwarz	1

Table 5-3 Instrument Required (2 of 3)

No.	Instrument	Specification	Recommended Model	Qty.
9	RF Power Sensor	Frequency Range: DC to 18 GHz Input Level: 1 $\mu$ W to 100 mW Maximum SWR: 1.2 (18 GHz)	NRV-Z51 Rohde&Schwarz	1
10	Microwave Power Sensor	Frequency Range: 50 MHz to 40 GHz Input Level: 1 $\mu$ W to 100 mW Maximum SWR: 1.3 (40 GHz)	NRV-Z55 Rohde&Schwarz	1
11	Power Sensor (75 $\Omega$ )	Frequency Range: 1 MHz to 2.5 GHz Input Level: 100 pW to 13 mW Maximum SWR: 1.2 (2.5 GHz)	NRV-Z3 Rohde&Schwarz	1
12	1 dB Step Attenuator	Attenuation Range: 0 dB to 12 dB Frequency Range: DC to 18 GHz	HP8494H Agilent Technologies	1
13	10 dB Step Attenuator	Attenuation Range: 0 dB to 70 dB Frequency Range: DC to 18 GHz	HP8495H Agilent Technologies	1
14	Attenuator Driver		11713A Agilent Technologies	1
15	Terminator	Impedance: 50 $\Omega$	RNA Rohde&Schwarz	1
16	Terminator (75 $\Omega$ )	Impedance: 75 $\Omega$	RNA Rohde&Schwarz	1
17	3 dB Attenuator	Impedance: 50 $\Omega$ Attenuation: 3 dB SMA(m)-SMA(f)	DEE-000685-1 ADVANTEST	1
18	20 dB Attenuator	Impedance: 50 $\Omega$ Attenuation: 20 dB SMA(m)-SMA(f)	DEE-000480-1 ADVANTEST	1
19	50 to 75 $\Omega$ Minimum Loss Pad	Frequency Range: DC to 2.2 GHz Insertion Loss: 5.7 dB (nominal)	HP11852B Agilent Technologies	1
20	Power Splitter	Frequency Range: 10 MHz to 40 GHz Insertion Loss: 6 dB (nominal)	K241C Anritsu	1
21	Power Splitter	Frequency Range: 10 MHz to 26.5 GHz Insertion Loss: 6 dB (nominal)	1579 Weinschel	1

## 5.1 General

Table 5-3 Instrument Required (3 of 3)

No.	Instrument	Specification	Recommended Model	Qty.
22	Power Divider	Frequency Range: 20 MHz to 1.5 GHz Isolation: greater than 18 dB	DDUL-20A-10G Merrimac	1
23	Power Divider	Frequency Range: 2 GHz to 18 GHz Isolation: greater than 18 dB	DDUL-24M-10G Merrimac	1
24	Low-pass Filter	Cutoff Frequency: 2.2 GHz Rejection (3 GHz): greater than 40 dB Rejection (3.8 GHz): greater than 80 dB	DEE-001172-1 ADVANTEST	1
25	RF Cable	Impedance: 50 $\Omega$ BNC(m)-BNC(m) Length: Approx. 1.5 m	MI-09 ADVANTEST	2
26	RF Cable	Impedance: 50 $\Omega$ SMA(m)-SMA(m) Frequency Range: DC to 26.5 GHz Maximum SWR: 1.45 at 26.5 GHz Length: Approx. 0.7 m	A01002 ADVANTEST	3
27	RF Cable	Impedance: 50 $\Omega$ K(m)-K(m) Frequency Range: DC to 40 GHz Maximum SWR: 1.45 at 40 GHz Length: Approx. 0.7 m	SF102 SUHNUR	3
28	RF Cable	Impedance: 50 $\Omega$ BNC(m)-BNC(m) Length: Approx. 1.5 m	DCB-FF4894X01-1 ADVANTEST	1
29	RF Cable	Impedance: 75 $\Omega$ BNC(m)-BNC(m) Length: Approx. 1.5 m	DCB-FFA701X01-1 ADVANTEST	1
30	Adapter	N(m)-SMA(f)	Generic	2
31	Adapter	SMA(f)-SMA(f)	Generic	1
32	Adapter	N(f)-BNC(m)	Generic	1
33	Adapter	N(f)-BNC(m) 75 $\Omega$	Generic	1
34	Adapter	N(m)-BNC(f)	Generic	4
35	Adapter	N(m)-BNC(f) 75 $\Omega$	Generic	2
36	Adapter	K(f)-K(f)	Generic	1

## 5.2 Procedures of Performance Verification

### 5.2.1 Frequency Reference Source Output Accuracy

The 10 MHz reference signal is measured for frequency accuracy by measuring the frequency of CAL OUT signal.

---

**CAUTION** *If the frequency reference of the R3132 series is set to EXT, perform 10 minutes warm-up operation after instrument preset.*

---

Specification:

30 MHz  $\pm$  60 Hz  
30 MHz  $\pm$  3 Hz (OPT20)

Instruments Required:

Instruments	Qty.	Recommended Model
Frequency Standard	1	R3031
Frequency Counter	1	R5372
RF Cable BNC(m)-BNC(m)	2	MI-09
Adapter N(m)-BNC(f)	1 (2 <sup>*</sup> )	
Minimum Loss Pad	1 <sup>*</sup>	HP11852B
Adapter BNC(m)-N(f) 75 $\Omega$	1 <sup>*</sup>	

\* R3132N Only

Procedures:

Setup

1. Connect the frequency counter and the frequency standard as shown in Figure 5-1.

5.2.1 Frequency Reference Source Output Accuracy

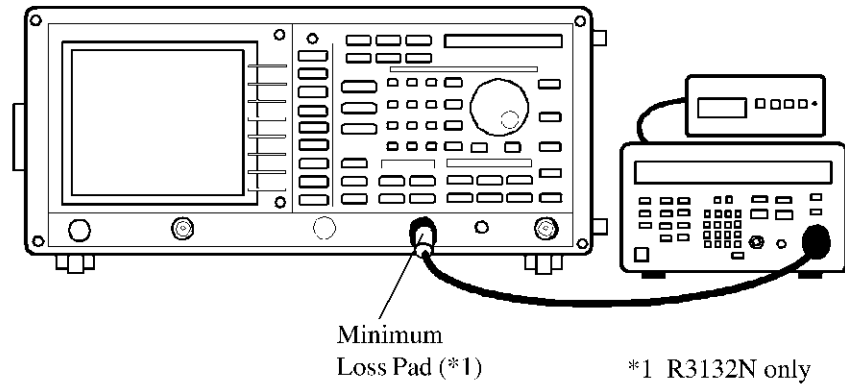

**Figure 5-1 Setup of Frequency Reference Source Accuracy Test**

---

**CAUTION:** Use only 75  $\Omega$  cables, connectors, or adapters on R3132N, or damage to the input connector will occur.

---

Setting the frequency counter

2. Set the R5372 controls as follows.  
Input:                      A  
Resolution:                0.1 Hz  
10 MHz Reference:        External

Initialization

3. Press **SHIFT, CONFIG(PRESET)**.

Measurement the frequency reference accuracy

4. Wait for the frequency counter reading on the performance verification check sheet.



## 5.2.2 Calibrator Amplitude Accuracy

The amplitude accuracy of the analyzer's CAL OUT signal is checked for  $-20 \text{ dBm} \pm 0.3 \text{ dB}$ .

Specification:

$-20 \text{ dBm} \pm 0.3 \text{ dB}$

Instruments Required:

Instruments	Qty.	Recommended Model
Power Meter	1	NRVS
Power Sensor	1	NRV-Z51
Power Sensor 75 $\Omega$	1*	NRV-Z3
Adapter BNC(m)-N(f)	1	
Adapter BNC(m)-N(f) 75 $\Omega$	1*	

\* R3132N Only

Procedures:

Setup

1. On the power meter, perform the zeroing and calibration with power sensor.
2. On the power meter, set the unit into dBm mode, after calibration has done.
3. On the power meter, set the correction frequency to 30 MHz.
4. Press **SHIFT, CONFIG(PRESET)**.

Measuring the CAL OUT level

5. Connect the power sensor as shown Figure 5-2.

5.2.2 Calibrator Amplitude Accuracy

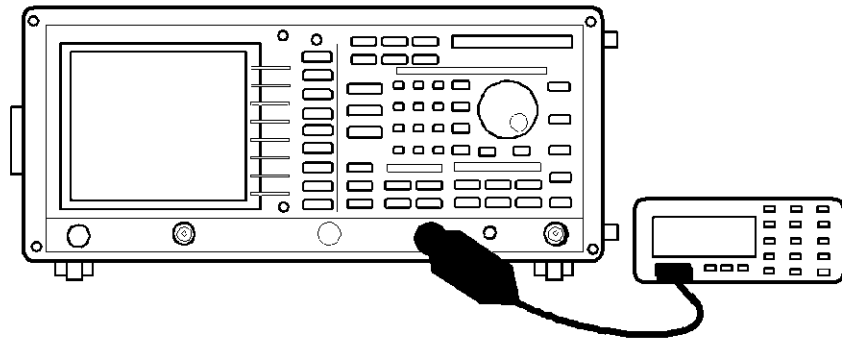

**Figure 5-2 Setup of CAL OUT Level Accuracy Test**

---

**CAUTION:** Use only 75  $\Omega$  cables, connectors, or adapters on R3132N, or damage to the input connector will occur.

---

6. Record the level of the power meter reading on the performance verification check sheet.

### 5.2.3 Displayed Average Noise Level

This test measures the displayed average noise level in all frequency.

The spectrum analyzer's input is terminated.

The test measures the average noise at several discrete frequencies in a zero span.

Specification:

RBW 1 kHz, VBW 10 Hz, Input attenuator 0 dB settings

Apply for R3132

Average Noise Level (20°C to 30°C)	Frequency	Frequency Band
$\leq -117 \text{ dBm} + 2f \text{ (GHz) dB}$ (Preamplifier OFF)	10 MHz to 3 GHz	0
$\leq -132 \text{ dBm} + 3f \text{ (GHz) dB}$ (Preamplifier ON)	1 MHz to 3 GHz	0

Apply for R3132N

Average Noise Level (20°C to 30°C)	Frequency	Frequency Band
$\leq -6 \text{ dB}\mu\text{V} + 2f \text{ (GHz) dB}$ (Preamplifier OFF)	10 MHz to 2.2 GHz	0
$\leq -21 \text{ dB}\mu\text{V} + 3f \text{ (GHz) dB}$ (Preamplifier ON)	1 MHz to 2.2 GHz	0

Apply for R3162

Average Noise Level (20°C to 30°C)	Frequency	Frequency Band
$\leq -117 \text{ dBm} + 2f \text{ (GHz) dB}$ (Preamplifier OFF)	10 MHz to 3.3 GHz	0
$\leq -115 \text{ dBm} + 0.5f \text{ (GHz) dB}$ (Preamplifier OFF)	3.2 GHz to 6.6 GHz	1
$\leq -115 \text{ dBm} + 0.5f \text{ (GHz) dB}$ (Preamplifier OFF)	6.5 GHz to 8 GHz	1
$\leq -132 \text{ dBm} + 3f \text{ (GHz) dB}$ (Preamplifier ON)	1 MHz to 3.3 GHz	0

Apply for R3172

Average Noise Level (20°C to 30°C)	Frequency	Frequency Band
$\leq -117 \text{ dBm} + 2f \text{ (GHz) dB}$ (Preamplifier OFF)	10 MHz to 3.3 GHz	0
$\leq -112 \text{ dBm}$ (Preamplifier OFF)	3.2 GHz to 7.1 GHz	1
$\leq -111 \text{ dBm}$ (Preamplifier OFF)	7 GHz to 14.7 GHz	2
$\leq -107 \text{ dBm}$ (Preamplifier OFF)	14.5 GHz to 22 GHz	3
$\leq -104 \text{ dBm}$ (Preamplifier OFF)	22 GHz to 26.5 GHz	3
$\leq -132 \text{ dBm} + 3f \text{ (GHz) dB}$ (Preamplifier ON)	1 MHz to 3.3 GHz	0

5.2.3 Displayed Average Noise Level

Apply for R3182

Average Noise Level (20°C to 30°C)	Frequency	Frequency Band
$\leq -117 \text{ dBm} + 2f \text{ (GHz) dB}$ (Preamplifier OFF)	10 MHz to 3.3 GHz	0
$\leq -114 \text{ dBm}$ (Preamplifier OFF)	3.2 GHz to 7.1 GHz	1
$\leq -112 \text{ dBm}$ (Preamplifier OFF)	7 GHz to 14.7 GHz	2
$\leq -110 \text{ dBm}$ (Preamplifier OFF)	14.5 GHz to 27 GHz	3
$\leq -107 \text{ dBm}$ (Preamplifier OFF)	26.5 GHz to 30 GHz	4
$\leq -106 \text{ dBm}$ (Preamplifier OFF)	29.5 GHz to 40 GHz	5
$\leq -132 \text{ dBm} + 3f \text{ (GHz) dB}$ (Preamplifier ON)	1 MHz to 3.3 GHz	0

Instruments Required:

Instruments	Qty.	Recommended Model
Terminator 50 $\Omega$ (for R3132/62)	1	RNA
Terminator 50 $\Omega$ (for R3172)	1	
Terminator 50 $\Omega$ (for R3182)	1	
Terminator 75 $\Omega$ (for R3132N)	1	

Procedures:

Setting the measurement conditions

1. Connect the terminator to Input of R3132 series as shown Figure 5-3.

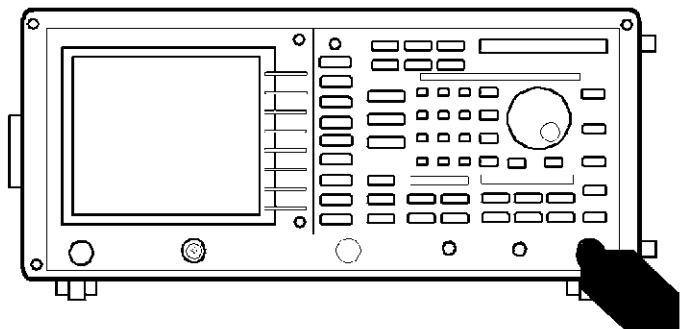

Figure 5-3 Setup of Displayed Average Noise Level Test

**CAUTION:** Use only 75  $\Omega$  cables, connectors, or adapters on R3132N, or damage to the input connector will occur.

2. On the R3132 series, after preset, set controls as follows:

Center Frequency: 10.1 MHz  
 Frequency Span: Zero  
 Input Attenuator: 0 dB  
 Reference Level: -60 dBm  
 RBW: 1 kHz  
 VBW: 10 Hz  
 Sweep Time: 1 sec

#### Measuring the Displayed Average Noise Level

3. On the R3132 series, press as follows to set average mode and average time to 10 times.

**TRACE, 1/2\_more, AVG A, 1, 0, Hz(ENTER)**

4. On the R3132 series, after average has completed, press **PK SRCH** to capture the highest noise signal.
5. Record the level of peak search marker on the performance verification record sheet.
6. Repeat step 3 through 5 for each center frequency and preamplifier setting listed in Table 5-4.

**Table 5-4 Center Frequency Setting for Display Average Noise Level**

Preamplifier	Center Frequency	Note
OFF	10.1 MHz 101 MHz 501 MHz 1001 MHz 1501 MHz 2001 MHz 2999 MHz	
ON	1 MHz 10.1 MHz 101 MHz 501 MHz 1001 MHz 1501 MHz 2001 MHz 2501 MHz 2999 MHz	
OFF	4000 MHz 5000 MHz 6000 MHz 7000 MHz 8000 MHz	For R3162 For R3162 For R3162 For R3162 For R3162

### 5.2.3 Displayed Average Noise Level

Following steps are applied for R3172/82

Measuring the Displayed Average Noise Level (Frequency is more than 3.2 GHz)

7. On the R3172/82, after preset, set controls as follows:

Start Frequency:	3.201 GHz
Stop Frequency:	7 GHz
Input Attenuator:	0 dB
Reference Level:	-40 dBm
RBW:	3 MHz
VBW:	100 kHz
  
8. On the R3172/82, press as follows to set average mode and average time to 10 times.

**TRACE, 1/2\_more, AVG A, 1, 0, Hz(ENTER)**
  
9. On the R3172/82, after average has completed, press **PK SRCH** to capture the highest noise signal.
  
10. On the R3172/82, press as follow to set signal peak to center frequency.

**MKR→, MKR→CF**
  
11. On the R3172/82, set controls as follows:

Frequency Span:	Zero
Reference Level:	-60 dBm
RBW:	1 kHz
VBW:	10 Hz
Sweep Time:	1 sec
  
12. On the R3172/82, after average has completed, press **PK SRCH** to capture signal peak.
  
13. Record the level of peak search marker on the performance verification record sheet.
  
14. Repeat steps 7 through 13 for each frequency setting listed in Table 5-5.

**Table 5-5 Start and Stop Frequencies Setting**

Frequency Range	Start Frequency	Stop Frequency	Note
7 GHz to 14.7 GHz	7.001 GHz	14.7 GHz	For R3172
14.5 GHz to 22 GHz	14.501 GHz	22 GHz	
22 GHz to 26.5 GHz	22.001 GHz	26.5 GHz	
7 GHz to 14.7 GHz	7.001 GHz	14.7 GHz	For R3182
14.5 GHz to 27 GHz	14.501 GHz	27 GHz	
26.5 GHz to 30 GHz	26.501 GHz	30 GHz	
29.5 GHz to 40 GHz	29.501 GHz	40 GHz	

5.2.4 Resolution Bandwidth Switching Uncertainty

**5.2.4 Resolution Bandwidth Switching Uncertainty**

This set utilizes the Cal. Signal for measuring the switching uncertainty between resolution bandwidth. At each resolution bandwidth setting, the displayed amplitude variation of the signal is measured using delta marker mode.

Specification:

Reference to 300 kHz RBW after auto calibration

±0.5 dB 1 kHz to 3 MHz

Instruments Required:

Instruments	Qty.	Recommended Model
RF Cable BNC(m)-BNC(m)	1	A01261-30
RF Cable BNC(m)-BNC(m) 75 Ω	1*1	A01045
Adapter N(m)-BNC(f)	1	
Adapter N(m)-BNC(f) 75 Ω	1*1	
Adapter SMA(f)-SMA(f)	1*2	
Adapter SMA(m)-BNC(f)	1*2	

\*1 R3132N Only

\*2 R3182 Only

Procedures:

Connecting the calibration signal

1. On the R3132 series, connect the BNC cable from CAL OUT connector to the INPUT connector as shown in Figure 5-4.

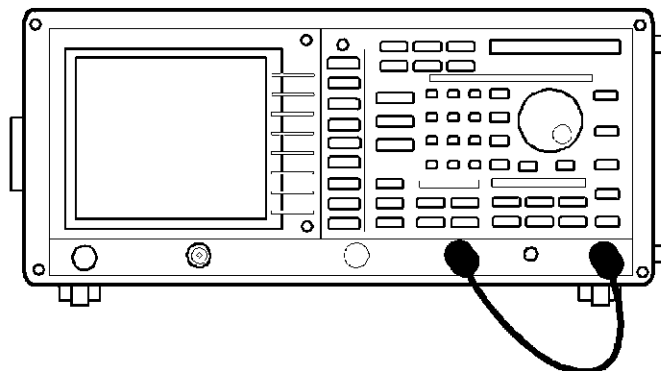

**Figure 5-4 Setup of Resolution Bandwidth Switching Uncertainty**



---

**CAUTION:** Use only 75  $\Omega$  cables, connectors, or adapters on R3132N, or damage to the input connector will occur.

---

#### Calibration Resolution Bandwidth Switching Uncertainty

2. On the R3132 series, after preset, press as follows to perform auto calibration function.

**SHIFT, 7(CAL), Each Item, RBW Switch**

#### Measuring the Resolution Bandwidth Switching Uncertainty

3. On the R3132 series, after RBW Switch auto calibration has completed, set controls as follows:

Center Frequency: 30 MHz  
Frequency Span: 500 kHz  
Reference Level: -15 dBm  
dB/div: 1 dB/div  
RBW: 300 kHz

4. On the R3132 series, press **SINGLE** for single sweep.
5. On the R3132 series, after single sweep has completed, press **PK SRCH** to capture signal peak.
6. On the R3132 series, press as follows to set fixed marker mode to on.

**MKR, 1/2\_more, Fixed MKR ON/OFF(ON).**

7. On the R3132 series, set controls as follows:  
RBW: 3 MHz  
Frequency Span: 5 MHz
8. On the R3132 series, press **SINGLE** for single sweep.
9. On the R3132 series, after single sweep has completed, press **PK SRCH** to capture signal peak.
10. Record the level of the delta marker on the performance verification record sheet.
11. Repeat steps 7 through 10 for each RBW and span setting listed in Table 5-6.

5.2.4 Resolution Bandwidth Switching Uncertainty

**Table 5-6 RBW Switching Uncertainty Test Setting**

RBW	Frequency Span
1 MHz	2 MHz
100 kHz	200 kHz
30 kHz	50 kHz
10 kHz	20 kHz
3 kHz	5 kHz
1 kHz	2 kHz

### 5.2.5 Resolution Bandwidth Accuracy and Selectivity

This test measures the 3 dB down of RBW accuracy and selectivity.

Selectivity is specified the 3 dB and the 60 dB down bandwidth of RBW.

RBW 30 Hz to 300 Hz are the option, if the unit is installed OPT27, perform verification.

Specification:

RBW Range 1 kHz to 3 MHz (1,3,10 sequence), 30 Hz to 300 Hz (OPT27)

Accuracy:  $\pm 25\%$  (RBW 3 MHz)  
 $\pm 20\%$  (RBW 1 kHz to 1 MHz)  
 $\pm 20\%$  (RBW 30 Hz to 300 Hz OPT27)

Selectivity:  $< 15:1$  (RBW 1 kHz to 3 MHz)

Instruments Required:

Instruments	Qty.	Recommended Model
Signal Generator	1	SMIQ02E
RF Cable BNC(m)-BNC(m)	1	MI-09
RF Cable SMA(m)-SMA(m)	1	A01002
Minimum Loss Pad	1 <sup>*1</sup>	HP11852B
Adapter N(m)-SMA(f)	2	
Adapter SMA(f)-SMA(f)	1 <sup>*2</sup>	

\*1 R3132N Only

\*2 R3182 Only

Procedures:

Setting the measurement conditions

1. Connect the signal generator as shown Figure 5-5.

5.2.5 Resolution Bandwidth Accuracy and Selectivity

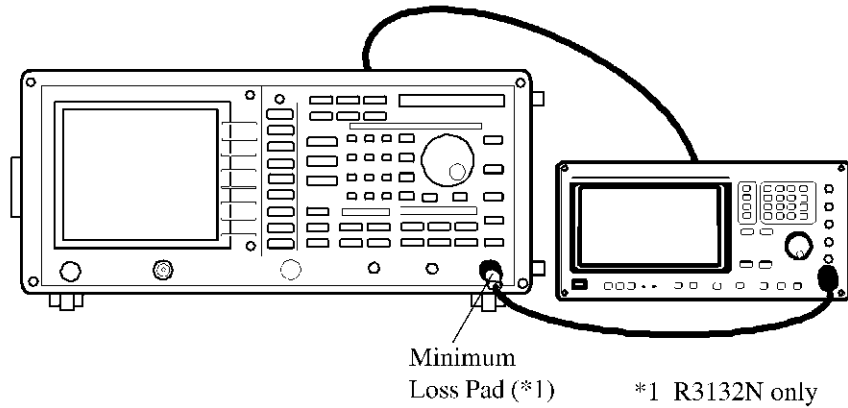

Figure 5-5 Setup of Resolution Bandwidth Accuracy and Selectivity Test

---

**CAUTION:** Use only 75  $\Omega$  cables, connectors, or adapters on R3132N, or damage to the input connector will occur.

---

2. On the signal generator, set controls as follows:

Frequency: 30 MHz  
Output Level: -5 dBm

Measuring the Resolution Bandwidth Accuracy

3. On the R3132 series, after preset, set controls as follows:

Center Frequency: 30 MHz  
Frequency Span: 10 MHz  
Reference Level: 0 dBm  
dB/div: 1 dB/div  
Trace Detector: Sample  
(Press **TRACE**, *Detector*, *Sample*)

4. On the R3132 series, press as follows to set continuous 3 dB down marker mode.

**MEAS**, *XdB Down*, **3**, **GHz(dB)**, *Cont Down ON/OFF*(ON)

5. On the R3132 series, set controls as follows:

RBW: 3 MHz  
Frequency Span: 5 MHz

6. On the R3132 series, press **SINGLE** for single sweep.

7. Record the frequency of the X dB down marker reading on the performance verification record sheet.

8. Repeat steps 5 through 7 for each RBW and frequency span setting listed in Table 5-7.

**Table 5-7 RBW and Span for 3 dB Down Width Measurement Setting**

RBW	Frequency Span
1 MHz	2 MHz
300 kHz	500 kHz
100 kHz	200 kHz
30 kHz	50 kHz
10 kHz	20 kHz
3 kHz	5 kHz
1 kHz	2 kHz
300 Hz (OPT27)	1 kHz
100 Hz (OPT27)	1 kHz
30 Hz (OPT27)	1 kHz

#### Measuring the 60 dB Down Width

9. On the R3132 series, after preset, set controls as follows:
- Center Frequency: 30 MHz  
 Frequency Span: 50 MHz  
 Reference Level: 0 dBm  
 VBW: 10 kHz  
 dB/div: 10 dB/div  
 Trace Detector: Sample  
 (Press **TRACE, Detector, Sample**)
10. On the R3132 series, press as follows to set continuous 60 dB down marker mode.
- MEAS, XdB Down, 6, 0, GHz(dB), Cont Down ON/OFF(ON)**
11. On the R3132 series, set controls as follows:
- RBW: 3 MHz  
 Frequency Span: 25 MHz
12. On the R3132 series, press **SINGLE** for single sweep.
13. Record the frequency of the X dB down marker reading on the performance verification record sheet.
14. Repeat steps 11 through 13 for each RBW and frequency span setting listed in Table 5-8.

5.2.5 Resolution Bandwidth Accuracy and Selectivity

**Table 5-8 RBW Selectivity Test Setting**

RBW	Frequency Span
1 MHz	20 MHz
300 kHz	5 MHz
100 kHz	2 MHz
30 kHz	500 kHz
10 kHz	200 kHz
3 kHz	50 kHz
1 kHz	20 kHz

Calculate selectivity

15. Calculate selectivity for each RBW using the following formula, then record its result on the performance verification record sheet.

$$\text{Selectivity} = (60 \text{ dB down width data}) / (3 \text{ dB down width data})$$

### 5.2.6 QP Bandwidth Accuracy

This test measured the 6 dB Down RBW accuracy under EMC measurement function. RBW 200 Hz is OPT27, if the unit installed it, perform verification.

Specification:

RBW Range: 1 MHz, 120 kHz, 9 kHz, 200 Hz (OPT27)

Accuracy:  $\pm 20\%$

Instruments Required:

Instruments	Qty.	Recommended Model
RF Cable BNC(m)-BNC(m)	1	A01261-30
RF Cable BNC(m)-BNC(m) 75 $\Omega$	1*1	A01045
Adapter N(m)-BNC(f)	1	
Adapter N(m)-BNC(f) 75 $\Omega$	1*1	
Adapter SMA(f)-SMA(f)	1*2	
Adapter SMA(m)-BNC(f)	1*2	

\*1 R3132N Only

\*2 R3182 Only

Procedures:

Connecting the calibration signal

1. On the R3132 series, connect the BNC cable from CAL OUT connector to the INPUT connector as shown in Figure 5-6.

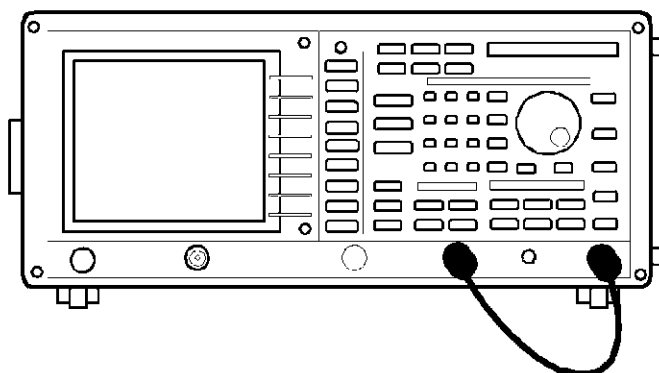

Figure 5-6 Setup of QP Bandwidth Accuracy Test

5.2.6 QP Bandwidth Accuracy

---

**CAUTION:** Use only 75  $\Omega$  cables, connectors, or adapters on R3132N, or damage to the input connector will occur.

---

Measuring the QP Resolution Bandwidth Accuracy

2. On the R3132 series, after preset, set controls as follows:  
 Center Frequency: 30 MHz  
 Reference Level: -15 dBm  
 dB/div: 2 dB/div  
 Trace Detector: Sample
3. On the R3132 series, press as follows to set continuous 6 dB down marker mode.  
**MEAS, XdB Down, 6, GHz(dB), XdB Down, Cont Down ON/OFF(ON)**
4. On the R3132 series, set controls as follow:  
 Frequency Span: 2 MHz
5. On the R3132 series, press as follows to set QP mode.  
**SHIFT, 1(EMC), Detector Mode, Peak, RBW 1 MHz**
6. On the R3132 series, press **SINGLE** for single sweep.
7. Record the frequency of the X dB down marker reading on the performance verification record sheet.
8. Repeat steps 4 though 7 for each RBW and frequency span setting listed in Table 5-9.

**Table 5-9 RBW and Span for 6 dB Down Width Measurement Setting**

RBW	Frequency Span
120 kHz	200 kHz
9 kHz	20 kHz
200 Hz (Option 27)	1 kHz



### 5.2.7 IF Gain Uncertainty

This test measures IF Gain error in resolution bandwidth 3 MHz, 300 kHz and 1 kHz.

The input signal level is decreased by external attenuator as the R3132 series reference level is decreased (IF Gain increased).

Since the signal level is decreased in precise steps, any error between the reference level and the signal level is caused by analyzer's IF Gain.

To measure IF Gain error, use Fixed marker mode.

Specification:

$\pm 0.5$  dB

Instruments Required:

Instruments	Qty.	Recommended Model
Signal Generator	1	SMP02
1 dB Step Attenuator	1	HP8494H
10 dB Step Attenuator	1	HP8495H
Attenuator Driver	1	HP11713
Minimum Loss Pad	1 <sup>*1</sup>	HP11852B
RF Cable BNC(m)-BNC(m)	3	MI-09
RF Cable BNC(m)-BNC(m)	1	DCB-FF4894X01
RF Cable BNC(m)-BNC(m) 75 $\Omega$	1 <sup>*1</sup>	DCB-FFA701X01
Adapter N(m)-BNC(f)	4	
Adapter N(m)-BNC(f) 75 $\Omega$	1 <sup>*1</sup>	
Adapter SMA(f)-SMA(f)	1 <sup>*2</sup>	
Adapter SMA(m)-BNC(f)	1 <sup>*2</sup>	

\*1 R3132N Only

\*2 R3182 Only

Procedures:

Auto calibration

1. Connect the CAL OUT signal to Input using adapter and cable.
2. On the R3132 series, press as follows to perform AUTO CAL function.

**SHIFT, 7(CAL), Cal All**

5.2.7 IF Gain Uncertainty

Setting the measurement conditions

3. On the R3132 series, after AUTO CAL function has completed, connect equipment as shown in Figure 5-7.

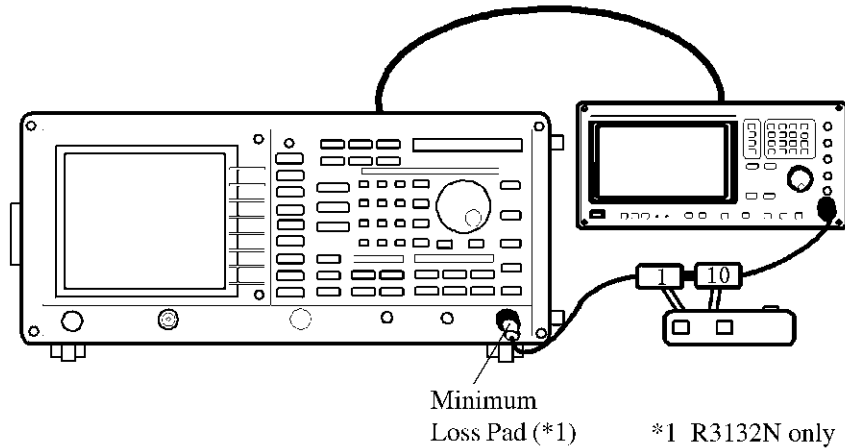

Figure 5-7 Setup of IF Gain Uncertainty Test

**CAUTION:** Use only 75 Ω cables, connectors, or adapters on R3132N, or damage to the input connector will occur.

4. On the signal generator, set controls as follows:  
Frequency: 11 MHz  
Output Level: -5 dBm
5. On the 1 dB step attenuator and 10 dB step attenuator, set value 0 dB.
6. On the R3132 series, after preset, set controls as follows:  
Center Frequency: 11 MHz  
Frequency Span: 2 kHz  
Reference Level: 0 dBm  
dB/div: 1 dB/div  
RBW: 3 MHz  
VBW: 10 Hz  
Trace Detector: Sample
7. On the signal generator, adjust output level to place the signal 5 dB below the R3132 series reference level.
8. On the R3132 series, press **SINGLE** for single sweep.
9. On the R3132 series, after single sweep has completed, press **PK SRCH** to capture signal peak and record the marker reading as reference value on the performance verification record sheet.

10. On the R3132 series, set controls as follow:

**TRACE**, *1/2\_more*, *Store A to B*, **MKR**, *MKR Trace A/B(B)*, *Delta*,  
*MKR Trace A/B(A)*

#### Measuring the IF Gain Uncertainty

11. On the R3132 series, set controls as follow:

RBW:                    3 MHz

12. On the 1 dB step attenuator, increase attenuation to 1 dB and decrease R3132 series reference level to -1 dBm.
13. On the R3132 series, press **SINGLE** for single sweep.
14. On the R3132 series, after single sweep has completed, press **PK SRCH** to capture signal peak.
15. Record the level of delta marker reading on the performance verification record sheet.
16. Repeat steps 12 through 15 for each attenuation level setting listed in Table 5-10.
17. For RBW 300 kHz and 1 kHz, change the setting in step 11 then repeat steps 5 through 16.

5.2.7 IF Gain Uncertainty

**Table 5-10 IF Gain Uncertainty Measurement Setting**

1 dB Step Attenuator	10 dB Step Attenuator	Reference Level
1 dB	0 dB	-1 dBm
2 dB	0 dB	-2 dBm
3 dB	0 dB	-3 dBm
4 dB	0 dB	-4 dBm
5 dB	0 dB	-5 dBm
6 dB	0 dB	-6 dBm
7 dB	0 dB	-7 dBm
8 dB	0 dB	-8 dBm
9 dB	0 dB	-9 dBm
0 dB	10 dB	-10 dBm
0 dB	20 dB	-20 dBm
0 dB	30 dB	-30 dBm
0 dB	40 dB	-40 dBm
0 dB	50 dB	-50 dBm

### 5.2.8 Input Attenuator Switching Accuracy (R3132/32N/62)

This test measures the input attenuator's switching accuracy for R3132/32N/62. The input attenuator switching accuracy is referenced to 10 dB attenuator setting at 30 MHz.

Specification:

With reference to 10 dB input attenuation, at 30 MHz apply for R3132/32N/62  
 $\pm 0.3$  dB (0 to 50 dB)

Instruments Required:

Instruments	Qty.	Recommended Model
Signal Generator	1	SMP02
1 dB Step Attenuator	1	HP8494H
10 dB Step Attenuator	1	HP8495H
Attenuator Driver	1	HP11713
Minimum Loss Pad	1*	HP11852B
RF Cable BNC(m)-BNC(m)	3	MI-09
Adapter N(m)-BNC(f)	4	

\* R3132N Only

Procedures:

Setting the measurement conditions

1. Connect the step attenuators as shown in Figure 5-8.

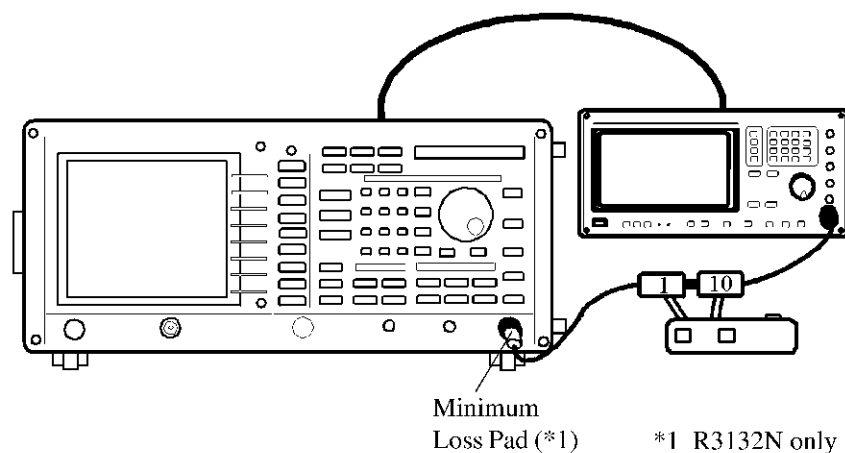

Figure 5-8 Setup of Input Attenuator Switching Accuracy Test (R3132/32N/62)

5.2.8 Input Attenuator Switching Accuracy (R3132/32N/62)

---

**CAUTION:** Use only 75  $\Omega$  cables, connectors, or adapters on R3132N, or damage to the input connector will occur.

---

2. On the signal generator, set controls as follows:  
Frequency: 30 MHz  
Output Level: +5 dBm
3. On the external attenuator, set attenuation 50 dB.
4. On the R3132 series, after preset, set controls as follows:  
Center Frequency: 30 MHz  
Frequency Span: 10 kHz  
Reference Level: -40 dBm  
Input Attenuator: 0 dB  
dB/div: 1 dB/div  
RBW: 3 kHz  
VBW: 10 Hz  
Sweep Time: 3 sec
5. On the signal generator, adjust the power level to place the peak of the signal five division below the R3132/32N/62 reference level.

Measuring the Input Attenuator Switching Accuracy: R3132/32N/62

6. On the R3132/32N/62, press **SINGLE** for single sweep.
7. On the R3132/32N/62, after single sweep has completed, press **PK SRCH** to capture the signal peak.  
Read the level of marker reading and record the value on the performance verification record sheet.
8. On the R3132/32N, repeat steps 6 through 7 for each setting listed in Table 5-11.  
On the R3162, repeat steps 6 through 7 for each setting listed in Table 5-12.

Calculate the Actual Error

9. Calculate the actual error by following formula and record the result on the performance verification record sheet as Actual (dB).

$$\text{Actual (dB)} = (\text{Measured Value in step 8}) - (\text{Measured Value at Input Attenuator 10 dB}) - (\text{Value of Input Attenuator Setting}) + 10$$

**Table 5-11 Input Attenuator Switching Accuracy Test Setting for R3132/32N**

R3132/32N		External Attenuator
Input Attenuator	Reference Level	
0 dB	-40 dBm	50 dB
10 dB	-30 dBm	40 dB
20 dB	-20 dBm	30 dB
30 dB	-10 dBm	20 dB
40 dB	0 dBm	10 dB
50 dB	+10 dBm	0 dB

**Table 5-12 Input Attenuator Switching Accuracy Test Setting for R3162**

R3162		External Attenuator
Input Attenuator	Reference Level	
0 dB	-40 dBm	50 dB
5 dB	-35 dBm	45 dB
10 dB	-30 dBm	40 dB
15 dB	-25 dBm	35 dB
20 dB	-20 dBm	30 dB
25 dB	-15 dBm	25 dB
30 dB	-10 dBm	20 dB
35 dB	-5 dBm	15 dB
40 dB	0 dBm	10 dB
45 dB	+5 dBm	5 dB
50 dB	+10 dBm	0 dB

5.2.9 Input Attenuator Switching Accuracy (R3172/82)

**5.2.9 Input Attenuator Switching Accuracy (R3172/82)**

This test measures input attenuator's switching accuracy over the full 70 dB. The number of frequency measured points is three points at 4 GHz, 15 GHz and 18 GHz. IF Gain uncertainty is measured when the resolution bandwidth is set to 1 kHz and result is filled in on the IF Gain uncertainty of the performance verification record sheet.

Specification:

Reference to 10 dB input attenuation.

Apply for R3172

±1.1 dB/10 dB step	Maximum deviation ±2 dB	9 kHz to 12 GHz
±1.3 dB/10 dB step	Maximum deviation ±2.5 dB	12 GHz to 18 GHz
±1.8 dB/10 dB step	Maximum deviation ±3.5 dB	18 GHz to 26.5 GHz

Apply for R3182

±1.1 dB/10 dB step	Maximum deviation ±2 dB	9 kHz to 12 GHz
±1.3 dB/10 dB step	Maximum deviation ±2.5 dB	12 GHz to 18 GHz
±1.8 dB/10 dB step	Maximum deviation ±3.5 dB	18 GHz to 26.5 GHz
±2.2 dB/10 dB step	Maximum deviation ±4 dB	26.5 GHz to 40 GHz

Instruments Required:

Instruments	Qty.	Recommended Model
Signal Generator	1	SMIQ02E
1 dB Step Attenuator	1	HP8494H
10 dB Step Attenuator	1	HP8495H
Attenuator Driver	1	HP11713
RF Cable SMA(m)-SMA(m)	3	A01002
RF Cable BNC(m)-BNC(m)	1	MI-09
Adapter N(m)-SMA(f)	4	
Adapter SMA(f)-SMA(f)	1*	

\* R3182 Only

Procedures:

Setting the measurement conditions

1. Connect the step attenuators as shown in Figure 5-9.



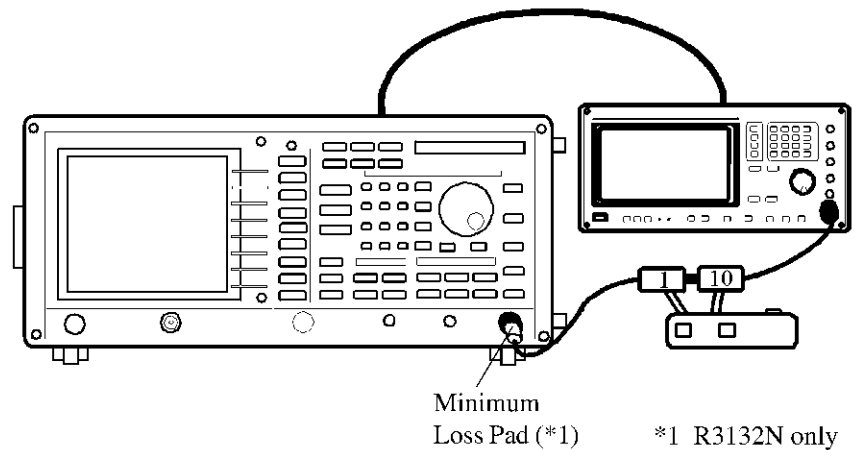

**Figure 5-9 Setup of Input Attenuator Switching Accuracy Test (R3172/82)**

2. On the signal generator, set controls as follows:
 

Frequency:	4 GHz
Output Level:	-5 dBm
3. On the external attenuator, set attenuation 10 dB.
4. On the R3172/82, after preset, set controls as follows:
 

Center Frequency:	4 GHz
Frequency Span:	3 kHz
5. In step 4 the center frequency is more than 3.3 GHz, press as follows to tune pre-selector.

**PK SRCH, FREQ, 1/2\_more, Presel, Auto Tune**

Wait till auto tuning has completed.

6. On the external attenuator, set attenuation 60 dB.
7. On the R3172/82, after preset, set controls as follows:
 

Reference Level:	-50 dBm
Input Attenuator:	10 dB
dB/div:	2 dB/div
RBW:	1 MHz
VBW:	10 Hz
Sweep Time:	3 sec
8. On the signal generator, adjust the power level to place the peak of the signal three division below the R3172/82 reference level.

5.2.9 Input Attenuator Switching Accuracy (R3172/82)

9. On the R3172/82, set controls as follow:

**TRACE, 1/2\_more, Store A to B, MKR, MKR Trace A/B(B), Delta, MKR Trace A/B(A)**

Measuring the Input Attenuator Switching Accuracy: R3172/82

10. On the R3172/82, press **SINGLE** for single sweep.
11. On the R3172/82, after single sweep has completed, press **PK SRCH** to capture the signal peak.
12. Record the level of marker reading at the actual value on the performance verification record sheet.
13. On the R3172/82, repeat steps 9 through 11 for each setting listed in Table 5-13.
14. For the 20 dB attenuator setting, switching accuracy becomes Step-By-Step accuracy.
15. For the 30, 40, 50, 60 and 70 dB attenuator setting, subtracts the 10 dB down attenuator switching accuracy from the current attenuator switching accuracy.
16. Repeat steps 2 through 14 for each frequency 15 GHz and 18 GHz setting.

**Table 5-13 Input Attenuator Switching Accuracy Test Setting for R3172/82**

R3172/82		External Attenuator
Input Attenuator	Reference Level	
10 dB	-50 dBm	60 dB
20 dB	-40 dBm	50 dB
30 dB	-30 dBm	40 dB
40 dB	-20 dBm	30 dB
50 dB	-10 dBm	20 dB
60 dB	0 dBm	10 dB
70 dB	+10 dBm	0 dB

### 5.2.10 Scale Fidelity

The 10 dB/div, 1 dB/div and linear scales are tested for fidelity. The 1 dB/div scale is tested in RBW setting of 1 MHz. The 10 dB/div scale and the Linear scale are tested in RBW setting 3 kHz. A signal is set to the reference level for each scale. As the signal amplitude is decreased using 1 dB step attenuator and 10 dB step attenuator, the displayed signal amplitude is compared to the reference level.

Specification:

Log Scale Fidelity:  $\pm 0.2$  dB/1 dB  
 $\pm 1.0$  dB/10 dB  
 $\pm 1.5$  dB/90 dB

Linear Scale Fidelity:  $\pm 5\%$  of reference level

Instruments Required:

Instruments	Qty.	Recommended Model
Signal Generator	1	SMIQ02E
1 dB Step Attenuator	1	HP8494H
10 dB Step Attenuator	1	HP8495H
Attenuator Driver	1	HP11713
Minimum Loss Pad	1*1	HP11852B
RF Cable BNC(m)-BNC(m)	3	MI-09
Adapter N(m)-BNC(f)	4	
Adapter SMA(f)-SMA(f)	1*2	
Adapter SMA(m)-BNC(f)	1*2	

\*1 R3132N Only

\*2 R3182 Only

Procedures:

Setting the measurement conditions

1. Connect the step attenuators as shown in Figure 5-10.

5.2.10 Scale Fidelity

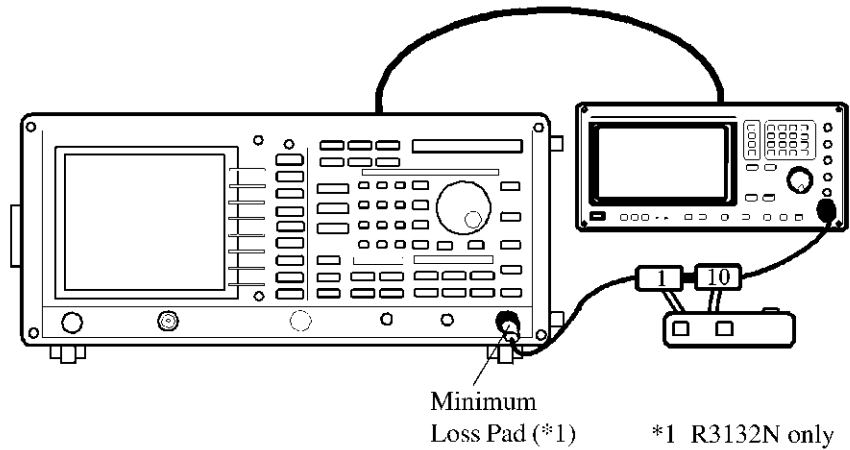

Figure 5-10 Setup of Scale Fidelity Test

**CAUTION:** Use only 75 Ω cables, connectors, or adapters on R3132N, or damage to the input connector will occur.

2. On the signal generator, set controls as follows:  
Frequency:            11 MHz  
Output Level:        0 dBm
3. On the R3132 series, after preset, set controls as follows:  
Center Frequency:   11 MHz  
Frequency Span:     2 kHz  
Reference Level:     0 dBm  
RBW:                  1 MHz  
VBW:                  10 Hz  
dB/div:                1 dB/div  
Trace Detector:      Sample
4. On the 1 dB step attenuator and the 10 dB step attenuator, set the value 0 dB.
5. On the R3132 series, press **PK SRCH** to capture the signal peak.
6. On the signal generator, adjust the output level so that the marker reading is 0.0 dBm ± 0.01 dBm
7. On the R3132 series, press **SINGLE** for single sweep.
8. On the R3132 series, press as follows to set fixed marker to on.

**MKR, 1/2\_more, Fixed MKR ON/OFF(ON)**

## Measuring the 1 dB/div Scale Fidelity

9. On the 1 dB step attenuator, increase attenuation to 1 dB.
10. On the R3132 series, press **SINGLE** for single sweep.
11. Record the level of delta marker reading in the Measured Data column in the performance verification record sheet.  
Calculate the incremental error by following formula and record the result in the Incremental Error in the column in the performance verification record sheet.  
  
Incremental Error (dB) = (current delta marker level) - (previous delta marker level) + 1 dB
12. Repeat steps 9 through 11 each value of the 1 dB step attenuator is listed in the Table 5-14.

**Table 5-14 1 dB/div Scale Fidelity Test Setting**

dB from Reference Level	1 dB Step Attenuator
0 dB	0 dB
-1 dB	1 dB
-2 dB	2 dB
-3 dB	3 dB
-4 dB	4 dB
-5 dB	5 dB
-6 dB	6 dB
-7 dB	7 dB
-8 dB	8 dB
-9 dB	9 dB
-10 dB	10 dB

## Measuring the 10 dB/div Scale Fidelity

13. On the R3132 series, after preset, set controls as follows:
 

Center Frequency:	11 MHz
Frequency Span:	2 kHz
Reference Level:	0 dBm
RBW:	3 kHz
VBW:	10 Hz
dB/div:	10 dB/div
Trace Detector:	Sample

5.2.10 Scale Fidelity

14. On the 1 dB step attenuator and the 10 dB step attenuator, set the value 0 dB.
15. On the R3132 series, press **PK SRCH** to capture the signal peak.
16. On the signal generator, adjust the output level so that the marker reading is 0.0 dBm ± 0.1 dB.
17. On the R3132 series, press **SINGLE** for single sweep.
18. On the R3132 series, press as follows to set fixed marker mode to on.

**MKR, 1/2\_more, Fixed MKR ON/OFF(ON)**

19. On the 10 dB step attenuator, increase attenuation to 10 dB.
20. On the R3132 series, press **SINGLE** for single sweep.
21. Record the level of fixed marker level in the Measured Data column in the performance verification record sheet. Calculate the incremental error by following formula and record the result in the Incremental Error in the column in the performance verification record sheet.

$$\text{Incremental Error (dB)} = (\text{current delta marker level}) - (\text{previous delta marker level}) + 10 \text{ dB}$$

22. Repeat steps 19 through 21 for each value of the 10 dB step external step attenuator is listed in the Table 5-15.

**Table 5-15 10 dB/div Scale Fidelity Test Setting**

dB from Reference Level	10 dB Step Attenuator
0 dB	0 dB
-10 dB	10 dB
-20 dB	20 dB
-30 dB	30 dB
-40 dB	40 dB
-50 dB	50 dB
-60 dB	60 dB
-70 dB	70 dB
-80 dB	80 dB
-90 dB	90 dB

## Measuring the Linear Scale Fidelity

23. On the signal generator, set controls as follows:  
Frequency: 11 MHz  
Output Level: 0 dBm
24. On the external attenuators, set attenuation 0 dB.
25. On the R3132 series, after preset, set controls as follows:  
Center Frequency: 11 MHz  
Frequency Span: 10 kHz  
Reference Level: 0 dBm  
RBW: 3 kHz  
VBW: 1 kHz  
Input Attenuator: 20 dB
26. On the R3132 series, press as follows to set vertical display mode to linear.  
**LEVEL, Linear**
27. On the R3132 series, press as follows to set continuous peak search mode.  
**MKR, Peak Menu, Cont Peak ON/OFF(ON)**
28. On the signal generator, precisely set output level to the R3132 series reference level while reading the marker level on the screen.
29. On the R3132 series, press **SINGLE** for single sweep.
30. Read the level value displayed on the signal generator and set the value as the reference value (Ref.).
31. Then set level of signal generator level to the 0.92 dB lower than the reference value.
32. On the R3132 series, press **SINGLE** for single sweep.
33. Read the marker level and record it in the performance verification record sheet.
34. Repeat steps 28 through 34 for each value listed in Table 5-16.

5.2.10 Scale Fidelity

**Table 5-16 Linear Scale Fidelity Test Setting**

div. from Reference Level	Signal Level (nominal)
0	0 dB
1	-0.92 dB
2	-1.94 dB
3	-3.10 dB
4	-4.44 dB
5	-6.02 dB
6	-7.96 dB
7	-10.46 dB
8	-13.98 dB
9	-20.00 dB



### 5.2.11 Residual FM

This test measures the inherent short term instability of the spectrum analyzer. A stable signal is applied to the spectrum analyzer input. The analyzer is set to zero span and the signal is slope detected on the skirt of the RBW. Any instability in the spectrum analyzer's Local Oscillator system is transferred to the IF in the mixing process.

#### Specification:

Apply for R3132/32N/62

Residual FM:  $\leq 60 \text{ Hzp-p}/0.1 \text{ sec.}$

Apply for R3172/82

Residual FM:  $\leq 60 \text{ Hzp-p} \times N/0.1 \text{ sec.}$

#### Instruments Required:

Instruments	Qty.	Recommended Model
Signal Generator	1	SMP02
RF Cable SMA(m)-SMA(m)	1	A01002
Minimum Loss Pad	1*1	HP11852B
Adapter N(m)-SMA(f)	1	
Adapter SMA(f)-SMA(f)	1*2	

\*1 R3132N Only

\*2 R3182 Only

#### Procedures:

##### Determining the IF filter slope

1. Connect the signal generator as shown in Figure 5-11.

5.2.11 Residual FM

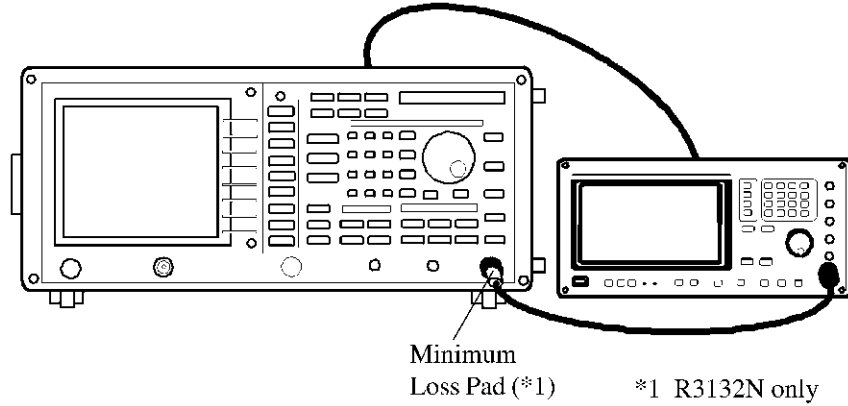

**Figure 5-11 Setup of Residual FM Test**

---

**CAUTION:** Use only 75  $\Omega$  cables, connectors, or adapters on R3132N, or damage to the input connector will occur.

---

2. On the signal generator, set controls as follows:  
Frequency:            2.5 GHz  
Output Level:        -10 dBm
3. On the R3132 series, after preset, set controls as follows:  
Center Frequency:    2.5 GHz  
Frequency Span:      2 kHz
4. On the R3132 series, press **PK SRCH** to capture the signal peak.
5. On the R3132 series, press as follows to set signal track mode to on.  
**MKR, Sig Track ON/OFF(ON)**
6. On the R3132 series, set controls as follows:  
Frequency Span:      1 kHz  
RBW:                    1 kHz
7. On the R3132 series, press as follows to set signal track mode to off.  
**MKR, Sig Track ON/OFF(OFF)**
8. On the R3132 series, set controls as follows:  
Reference Level:      -5 dBm  
dB/div:                1 dB/div  
Frequency Span:      2.5 kHz

9. On the R3132 series, press **PK SRCH** to capture the signal peak.
10. On the R3132 series, press as follows to set signal peak to reference level.  
**MKR→, MKR→Ref**
11. On the R3132 series, press **SINGLE** for single sweep.
12. On the R3132 series, press as follows to set delta marker mode to on.  
**MKR, Delta**
13. On the R3132 series, rotate data knob clockwise until the marker reads -3 dBm ± 0.1 dB.
14. On the R3132 series, press as follows to set delta marker mode to on.  
**MKR, Delta**
15. On the R3132 series, rotate data knob clockwise until the marker reads -6 dBm ± 0.1 dB.
16. Record the frequency and the level of the delta marker reading on the performance verification record sheet.
17. Calculate the slope using the following formula on the performance verification record sheet.  
  
Slope = (the frequency of the delta marker reading)/(the level of the delta marker reading)

#### Measuring the Residual FM

18. On the R3132 series, press **REPEAT** for continuous sweep.
19. On the R3132 series, set controls as follows:  
Frequency Span:     Zero  
Sweep Time:         100 msec
20. On the R3132 series, press **FREQ** and rotate data knob clockwise to place trace-displayed peak about six division below reference level.
21. On the R3132 series, press **SINGLE** to set single sweep mode.
22. On the R3132 series, press as follows to set peak search and delta marker mode.  
**PK SRCH, MKR, Delta**

#### 5.2.11 Residual FM

23. On the R3132 series, press as follows to capture minimum peak signal.

**MKR, Peak Menu, Min Peak**

24. Record the level of delta marker reading as Delta Level on the performance verification record sheet.

#### Calculation Residual FM

25. Calculate the Residual FM using the following formula.

$\text{Residual FM [Hz]} = \text{Slope [Hz/dB]} \times \text{Delta level [dB]}$

Record the result on the performance verification record sheet.

### 5.2.12 Noise Sidebands

The noise sidebands of a 1.0 GHz, 0 dBm signal is measured at offset of 20 kHz from the carrier. The noise marker (dBc/Hz) and averaging functions are used to average the noise sidebands.

Specification:

Apply for R3132/32N/62

Frequency Range  $\leq$  2.6 GHz  
 $\leq$  -105 dBc/Hz at 20 kHz Offset  
 $\leq$  -100 dBc/Hz at 10 kHz Offset (RBW300 Hz OPT27)

Frequency Range  $>$  2.6 GHz  
 $\leq$  -103 dBc/Hz at 20 kHz Offset  
 $\leq$  -98 dBc/Hz at 10 kHz Offset (RBW300 Hz OPT27)

Apply for R3172/82

Frequency Range  $\leq$  2.6 GHz  
 $\leq$  -105 dBc/Hz at 20 kHz Offset  
 $\leq$  -100 dBc/Hz at 10 kHz Offset (RBW300 Hz OPT27)

Frequency Range  $>$  2.6 GHz  
 $\leq$  (-103+20 logN) dBc/Hz at 20 kHz Offset  
 $\leq$  (-98+20 logN) dBc/Hz at 10 kHz Offset (RBW300 Hz OPT27)

Instruments Required:

Instruments	Qty.	Recommended Model
Signal Generator	1	SMIQ02E
RF Cable BNC(m)-BNC(m)	1	MI-09
RF Cable SMA(m)-SMA(m)	1	A01002
Minimum Loss Pad	1*1	HP11852B
Adapter N(m)-SMA(f)	2	
Adapter SMA(f)-SMA(f)	1*2	

\*1 R3132N Only

\*2 R3182 Only

Procedures:

Setting the measurement conditions

1. Connect the signal generator as shown in Figure 5-12.

5.2.12 Noise Sidebands

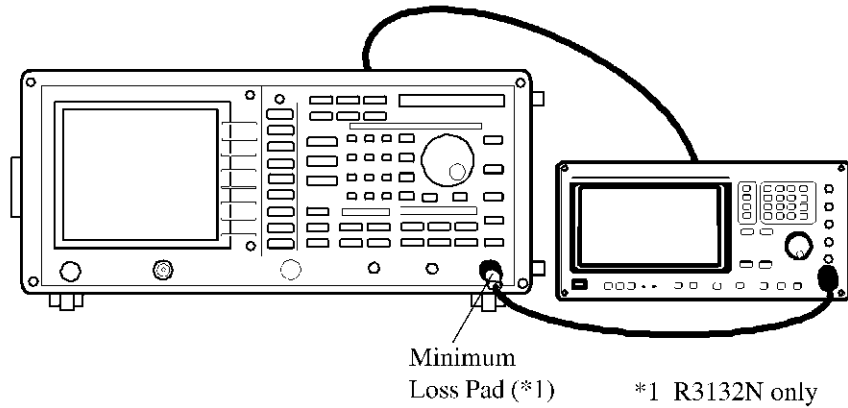

Figure 5-12 Setup of Noise Sidebands Test

**CAUTION:** Use only 75  $\Omega$  cables, connectors, or adapters on R3132N, or damage to the input connector will occur.

Measuring the Noise Sidebands

2. On the signal generator, set controls as follows:  
Frequency: 1 GHz  
Output Level: -5 dBm
3. On the R3132 series, after preset, set controls as follows:  
Center Frequency: 1 GHz  
Frequency Span: 50 kHz
4. On the signal generator, press as follows to set noise marker mode to on.  
**PK SRCH, MKR→, MKR→Ref, PK SRCH, MEAS, Noise/Hz, dBc/Hz**
5. On the R3132 series, put the noise marker at 20 kHz offset using data knob or press **2, 0** and **kHz**.
6. On the R3132 series, set the reference level by 20 dB and press as follows to perform averaging for 20 samples.  
**TRACE, 1/2\_more, AVG A, 2, 0, Hz(ENTER)**
7. Record the level of marker reading on the performance verification record sheet.

### 5.2.13 Image, Multiple and Out-of-Band Responses

This performance verification applies for R3162/72/82.

Image, multiple, and out-of-band responses are tested in all frequency bands. A signal is applied to the signal analyzer's INPUT connector, then a reference amplitude measurement is made.

The signal source is then tuned to a frequency which causes either an image, multiple, or out-of-band response.

The amplitude displayed on the spectrum analyzer is measured and recorded.

Specification:

Apply for R3162

≤ -70 dBc/Hz Frequency Range up to 8 GHz

Apply for R3172

≤ -70 dBc/Hz Frequency Range 10 MHz to 18 GHz

≤ -60 dBc/Hz Frequency Range 18 GHz to 23 GHz

≤ -50 dBc/Hz Frequency Range 23 GHz to 26.5 GHz

Apply for R3182

≤ -70 dBc/Hz Frequency Range 10 MHz to 18 GHz

≤ -65 dBc/Hz Frequency Range 18 GHz to 26.5 GHz

≤ -60 dBc/Hz Frequency Range 26.5 GHz to 34 GHz

≤ -50 dBc/Hz Frequency Range 34 GHz to 40 GHz

Instruments Required:

Instruments	Qty.	Recommended Model
Signal Generator	1	SMP04
Power Meter	1	NRVS
Power Sensor	1	NRV-Z55
Power Splitter	1	K241C
RF Cable BNC(m)-BNC(m)	1	MI-09
RF Cable SMA(m)-SMA(m)	3	A01002
RF Cable K(m)-K(m)	1 <sup>*2</sup>	
Minimum Loss Pad	1 <sup>*1</sup>	HP11852B
Adapter N(m)-SMA(f)	1	
Adapter K(f)-K(f)	1 <sup>*2</sup>	

\*1 R3132N Only

\*2 R3182 Only

5.2.13 Image, Multiple and Out-of-Band Responses

Procedures:

Setting the measurement conditions

1. On the power meter, perform the zeroing and calibration with power sensor.
2. On the power meter, set the unit into dBm mode, after calibration has done.
3. On the power meter, set the correction frequency to 2 GHz.
4. Connect the power meter and signal generator as shown Figure 5-13.

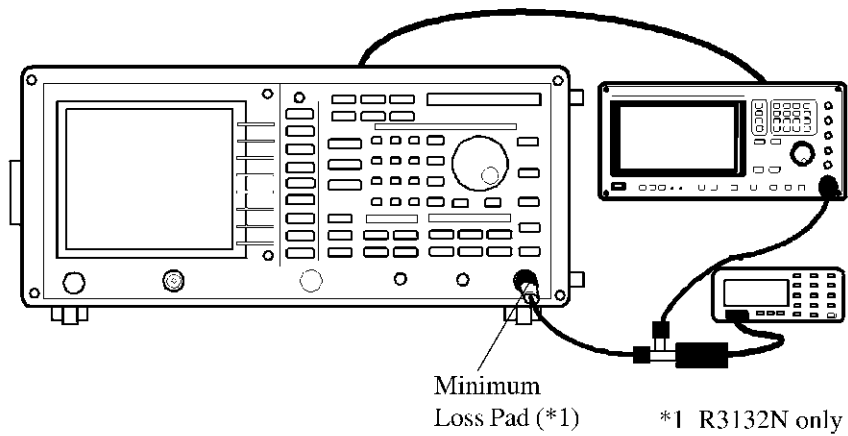

Figure 5-13 Setup of Image, Multiple and Out-of-Band Responses Test

---

**CAUTION:** Use only 75  $\Omega$  cables, connectors, or adapters on R3132N, or damage to the input connector will occur.

---

5. On the signal generator, set controls as follow:  
Output Level: 0 dBm
6. On the R3162/72/82, after preset, set controls as follows:  
Frequency Span: 5 MHz  
RBW: 100 kHz  
VBW: 300 kHz

Measuring the Image, Multiple and Out-Of-Band Response

7. On the signal generator, set controls as follow:  
Frequency: 2 GHz
8. On the R3162/72/82, set controls as follow:  
Center Frequency: 2 GHz



9. On the signal generator, adjust output level so that power meter reading is 0 dBm  $\pm$  0.1 dB.
10. On the R3162/72/82, press **SINGLE** for single sweep.
11. On the R3162/72/82, after single sweep has completed, press **PK SRCH** to capture signal peak.
12. On the R3162/72/82, press as follows to set fixed marker to on.  
**MKR, 1/2\_more, Fixed MKR ON/OFF(ON)**
13. On the R3162/72/82, press **REPEAT** for continuous sweep.
14. On the signal generator, set control as follow:  
Frequency: 1957.2 MHz
15. On the power meter, set the correction frequency to 1.95 GHz.
16. On the signal generator, adjust output level so that power meter reading is 0 dBm  $\pm$  0.1 dB.
17. On the R3162/72/82, press **SINGLE** for single sweep.
18. On the R3162/72/82, after single sweep has completed, press **PK SRCH** to capture signal peak.
19. Record the delta marker reading on the performance verification record sheet.
20. Repeat steps 7 through 19 for each frequency listed in Table 5-17.

---

**NOTE:** *In step 8, if the center frequency is more than 3.3 GHz, press as follows to tune preselector after center frequency setting.*  
**REPEAT, PK SRCH, FREQ, 1/2\_more, Presel, Auto Tune**  
*Wait till auto tuning has completed.*

---

5.2.13 Image, Multiple and Out-of-Band Responses

**Table 5-17 Image, Multiple, Out-of-Band Response Test Setting**

Center Frequency	Signal Generator	Correction Frequency for Power Meter	Note
2 GHz	1.9572 GHz	1.96 GHz	
2 GHz	1.1572 GHz	1.16 GHz	
2 GHz	10.5228 GHz	10.52 GHz	
2 GHz	8.2614 GHz	8.26 GHz	
5.5 GHz	6.3428 GHz	6.34 GHz	For R3162
8 GHz	7.1572 GHz	7.16 GHz	For R3162
8 GHz	3.7893 GHz	3.79 GHz	For R3162
5.5 GHz	6.3428 GHz	6.34 GHz	For R3172/82
5.5 GHz	11.4214 GHz	11.42 GHz	For R3172/82
5.5 GHz	17.3428 GHz	17.34 GHz	For R3172/82
5.5 GHz	23.2642 GHz	23.26 GHz	For R3172/82
12 GHz	12.8428 GHz	12.84 GHz	For R3172/82
12 GHz	5.7893 GHz	5.79 GHz	For R3172/82
12 GHz	18.2107 GHz	18.21 GHz	For R3172/82
12 GHz	24.4214 GHz	24.42 GHz	For R3172/82
21 GHz	21.8428 GHz	21.84 GHz	For R3172/82
21 GHz	6.71907 GHz	6.72 GHz	For R3172/82
21 GHz	13.8595 GHz	13.86 GHz	For R3172/82
24.4 GHz	25.2428 GHz	25.24 GHz	For R3172/82
24.4 GHz	5.78395 GHz	5.78 GHz	For R3172/82
24.4 GHz	11.9893 GHz	11.99 GHz	For R3172/82
24.4 GHz	18.19465 GHz	18.19 GHz	For R3172/82
28 GHz	28.8428 GHz	28.84 GHz	For R3182
28 GHz	6.89465 GHz	6.89 GHz	For R3182
28 GHz	13.7893 GHz	13.79 GHz	For R3182
28 GHz	20.89465 GHz	20.89 GHz	For R3182
35 GHz	35.8428 GHz	35.84 GHz	For R3182
35 GHz	6.91572 GHz	6.92 GHz	For R3182
35 GHz	11.5262 GHz	11.53 GHz	For R3182
35 GHz	23.19287 GHz	23.19 GHz	For R3182

### 5.2.14 Accuracy of Frequency Readout and Count Frequency Marker

The accuracy of the spectrum analyzer frequency readout and count frequency marker is tested with an input signal of known frequency.

For the points of frequencies above 5 GHz are required to tune preselector peak.

Specification:

Accuracy of Frequency Readout

$$\pm(\text{Center Frequency} \times \text{Frequency Reference Accuracy} + \text{Frequency span} \times \text{Frequency Span Accuracy} + 0.15 \times \text{Resolution band width} + 60 \text{ Hz})$$

Span Accuracy

$$\pm 1\% \text{ of Span}$$

Accuracy of Frequency Counter Marker (Span < 200 MHz, S/N > 25 dB)

$$\pm(\text{Marker Frequency} \times \text{Frequency Reference Accuracy} + 1 \text{ LSD})$$

Instruments Required:

Instruments	Qty.	Recommended Model
Signal Generator	1	SMP04
Frequency Standard	1	R3031
Minimum Loss Pad	1 <sup>*1</sup>	HP11852B
RF Cable BNC(m)-BNC(m)	1	MI-09
RF Cable SMA(m)-SMA(m)	3	A01002
RF Cable K(m)-K(m)	1 <sup>*2</sup>	
Adapter N(m)-SMA(f)	2	
Adapter K(f)-K(f)	1 <sup>*2</sup>	

\*1 R3132N Only

\*2 R3182 Only

Procedures:

Setting the measurement conditions

1. Connect the signal generator and the frequency standard as shown Figure 5-14.

5.2.14 Accuracy of Frequency Readout and Count Frequency Marker

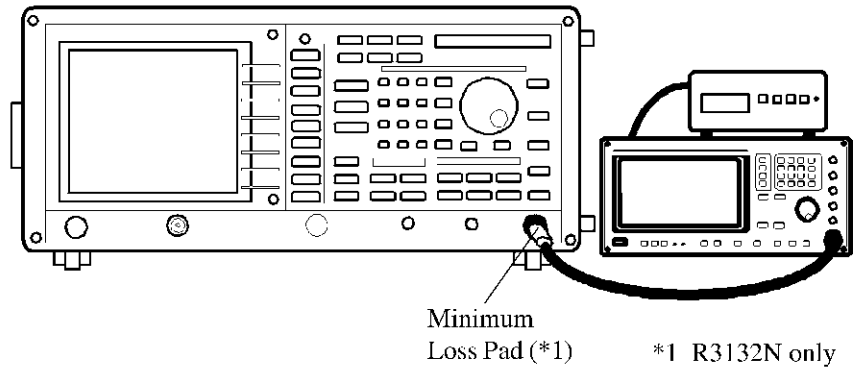

Figure 5-14 Setup of Accuracy of Frequency Readout and Frequency Counter Test

---

**CAUTION:** Use only 75  $\Omega$  cables, connectors, or adapters on R3132N, or damage to the input connector will occur.

---

2. On the signal generator, set controls as follow:  
Output Level: 0 dBm

Measuring the Accuracy of Frequency Readout

3. On the signal generator, set controls as follow:  
Frequency: 2 GHz
4. On the R3132 series, after preset, set controls as follows:  
Center Frequency: 2 GHz  
Frequency Span: 1 MHz
5. On the R3132 series, press **SINGLE** for single sweep.
6. On the R3132 series, after single sweep has completed, press **PK SRCH** to capture signal peak.
7. Record the frequency of marker reading on the performance verification record sheet.
8. Repeat steps 3 through 7 for each frequency setting listed in Table 5-18.  
In step 4., the center frequency is more than 3.3 GHz on the R3162/72/82, press as follows to tune preselector peak after the center frequency and the frequency span setting.  
**REPEAT, PK SRCH, FREQ, 1/2\_more, Presel, Auto Tune**  
Wait till auto tuning has completed.

## Measuring the Count Frequency Marker Accuracy

9. On the signal generator, set controls as follow:  
Output Level: 0 dBm
10. On the signal generator, set controls as follow:  
Frequency: 2 GHz
11. On the R3132 series, after preset, set controls as follows:  
Center Frequency: 2 GHz  
Frequency Span: 1 MHz
12. On the R3132 series, press **PK SRCH** to capture the signal peak.
13. On the R3132 series, press as follows to set frequency counter mode to on.  
**COUNTER, Res IIIz**
14. On the R3132 series, press **SINGLE** for single sweep.
15. Record the frequency counter reading on the performance verification record sheet.
16. Repeat steps 10 through 15 for each frequency setting listed in Table 5-19.  
In step 11., the center frequency is more than 3.3 GHz on the R3162/72/82, press as follows to tune preselector peak after the center frequency and the frequency span setting.  
**REPEAT, PK SRCH, FREQ, 1/2\_more, Presel, Auto Tune**  
Wait till auto tuning has completed.

5.2.14 Accuracy of Frequency Readout and Count Frequency Marker

**Table 5-18 Frequency Readout Accuracy Test Setting**

Signal Generator	Center Frequency	Frequency Span	Note
2 GHz	2 GHz	1 MHz	
2 GHz	2 GHz	10 MHz	
2 GHz	2 GHz	20 MHz	
2 GHz	2 GHz	100 MHz	
2 GHz	2 GHz	1000 MHz	
5 GHz	5 GHz	1 MHz	For R3162/72/82
5 GHz	5 GHz	10 MHz	For R3162/72/82
5 GHz	5 GHz	100 MHz	For R3162/72/82
5 GHz	5 GHz	1000 MHz	For R3162/72/82
11 GHz	11 GHz	1 MHz	For R3172/82
11 GHz	11 GHz	10 MHz	For R3172/82
11 GHz	11 GHz	20 MHz	For R3172/82
11 GHz	11 GHz	100 MHz	For R3172/82
11 GHz	11 GHz	1000 MHz	For R3172/82
18 GHz	18 GHz	1 MHz	For R3172/82
18 GHz	18 GHz	10 MHz	For R3172/82
18 GHz	18 GHz	20 MHz	For R3172/82
18 GHz	18 GHz	100 MHz	For R3172/82
18 GHz	18 GHz	1000 MHz	For R3172/82
35 GHz	35 GHz	1 MHz	For R3182
35 GHz	35 GHz	10 MHz	For R3182
35 GHz	35 GHz	20 MHz	For R3182
35 GHz	35 GHz	100 MHz	For R3182
35 GHz	35 GHz	1000 MHz	For R3182

**Table 5-19 Count Frequency Marker Accuracy Test Setting**

Signal Generator	Center Frequency	Note
2 GHz	2 GHz	
5 GHz	5 GHz	For R3162/72/82
11 GHz	11 GHz	For R3172/82
18 GHz	18 GHz	For R3172/82
35 GHz	35 GHz	For R3182

### 5.2.15 Second Harmonic Distortion

A synthesized signal generator and low pass filter provide the signal for measuring second harmonic distortion. The low pass filter eliminates any harmonic distortion originating at the signal source. The R3132 series frequency response is calibrated.

The signal generator is phase-locked to the spectrum analyzer's 10 MHz reference.

Test will be done the points of 1.5 GHz and 1.9 GHz as fundamental signal.

To measure second harmonic distortion, use Fixed Marker in Delta Marker function.

Specification:

Apply for R3132

≤ -70 dBc Frequency Range 100 MHz to 800 MHz Mixer input level -30 dBm

≤ -80 dBc Frequency Range ≥ 800 MHz Mixer input level -30 dBm

Apply for R3132N

≤ -70 dBc Frequency Range 100 MHz to 800 MHz Mixer input level +77 dBμV

≤ -80 dBc Frequency Range ≥ 800 MHz Mixer input level +77 dBμV

Apply for R3162/72

≤ -70 dBc Frequency Range 100 MHz to 800 MHz Mixer input level -30 dBm

≤ -80 dBc Frequency Range ≥ 800 MHz Mixer input level -30 dBm

≤ -100 dBc Frequency Range ≥ 3.3 GHz Mixer input level -10 dBm

Apply for R3182

≤ -70 dBc Frequency Range 100 MHz to 800 MHz Mixer input level -30 dBm

≤ -80 dBc Frequency Range ≥ 800 MHz Mixer input level -30 dBm

≤ -95 dBc Frequency Range ≥ 3.3 GHz Mixer input level -10 dBm

Instruments Required:

Instruments	Qty.	Recommended Model
Signal Generator	1	SMP04
Power Meter	1	NRVS
Power Sensor	1	NRV-Z55
Power Splitter	1	K241C
2 GHz Low-pass Filter	1	DEE-001172-1
Minimum Loss Pad	1 <sup>*1</sup>	HP11852B
RF Cable BNC(m)-BNC(m)	1	MI-09
RF Cable SMA(m)-SMA(m)	3	A01002
RF Cable K(m)-K(m)	1 <sup>*2</sup>	
Adapter N(m)-SMA(f)	2	
Adapter K(f)-K(f)	1 <sup>*2</sup>	

\*1 R3132N Only

\*2 R3182 Only

5.2.15 Second Harmonic Distortion

Procedures:

Setting the measurement conditions

1. On the power meter, perform the zeroing and calibration with power sensor.
2. On the power meter, set the unit into dBm mode, after calibration has done.
3. On the power meter, set the correction frequency to 1.5 GHz.
4. Connect the power meter, the signal generator, the power splitter and the low pass filter as shown Figure 5-15.

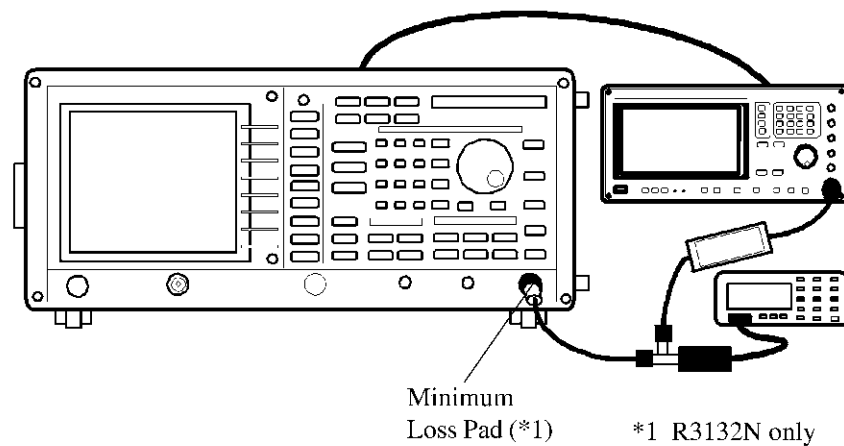

Figure 5-15 Setup of Second Harmonic Distortion Test

**CAUTION:** Use only 75 Ω cables, connectors, or adapters on R3132N, or damage to the input connector will occur.

Measuring the Second Harmonic Distortion

5. On the signal generator, set controls as follows:  
Frequency: 1.5 GHz  
Output Level: 0 dBm
6. On the R3132 series, after preset, set controls as follows:  
Center Frequency: 1.5 GHz  
Frequency Span: 10 kHz  
Input Attenuator: 20 dB  
Reference Level: -10 dBm  
VBW: 30 Hz
7. On the signal generator, adjust output level so that the power meter reading is -10 dBm ± 0.09 dB.



8. On the R3132 series, press **SINGLE** for single sweep.
9. On the R3132 series, after single sweep has completed, press **PK SRCH** to capture signal peak.
10. On the R3132 series, press as follows to set fixed marker to on.  
**MKR, 1/2\_more, Fixed MKR ON/OFF(ON)**
11. On the R3132 series, set center frequency to 3 GHz.
12. On the R3132 series, press **SINGLE** for single sweep.
13. On the R3132 series, press **PK SRCH** to capture signal peak.
14. Record the level of the delta marker reading on the performance verification record sheet.

Following procedure is applied for R3162/72/82  
Measurement for 3.3 GHz or higher

15. Remove the low pass filter and connect the RF cable between signal generator and the R3162/72/82.
16. On the signal generator, set controls as follows:  
Frequency: 3.8 GHz  
Output Level: -10 dBm
17. On the R3162/72/82, after preset, set controls as follows:  
Center Frequency: 3.8 GHz  
Frequency Span: 500 kHz
18. On the R3162/72/82, press as follows to tune preselector peak.  
**PK SRCH, FREQ, 1/2\_more, Presel, Auto Tune**
19. On the R3162/72/82, after auto tuning has completed, set the signal generator controls as follows:  
Frequency: 1.9 GHz  
Output Level: 0 dBm
20. Connect the low pass filter as shown Figure 5-15.
21. On the power meter, set the correction frequency to 1.9 GHz
22. On the signal generator, adjust output level so that power meter is -10 dBm  $\pm 0.09$  dB.

5.2.15 Second Harmonic Distortion

23. On the R3162/72/82, set controls as follows:  
Center Frequency: 1.9 GHz  
Frequency Span: 1 kHz
24. On the R3162/72/82, press as follows to set fixed marker mode to on.  
  
**MKR, 1/2\_more, Fixed MKR ON/OFF(ON)**
25. On the R3162/72/82, set controls as follows:  
Center Frequency: 3.8 GHz  
Reference Level: -40 dBm
26. On the R3162/72/82, press as follows to set average mode for 20 samples.  
  
**TRACE, 1/2\_more, AVG A, 2, 0, Hz(ENTER)**
27. On the R3162/72/82, after average has completed, press **PK SRCH** to capture signal peak.
28. Record the level of the delta marker reading on the performance verification record sheet.

### 5.2.16 Frequency Response

The output of the signal generator is fed through a power splitter to a power sensor, then to the spectrum analyzer. The signal generator's power level is adjusted at 30 MHz to place the displayed signal at the center horizontal graticule line of the spectrum analyzer. The power meter is placed in relative mode. At each new signal generator frequency and spectrum analyzer center frequency, the signal generator's power level is adjusted to place the signal at the center horizontal graticule line. The power meter displays the inverse of the frequency response relative to the signal of CAL OUT.

The R3132 series is phase locked to the signal generator's 10 MHz reference.

Specification:

Apply for R3132

Preamplifier OFF, Attenuator 10 dB

±0.5 dB Frequency Range 100 kHz to 3 GHz (20°C to 30°C)

±2.0 dB Frequency Range 9 kHz to 3 GHz

Preamplifier ON, Attenuator 10 dB

±1.0 dB Frequency Range 100 kHz to 2.7 GHz

±2.0 dB Frequency Range 9 kHz to 3 GHz

Apply for R3132N

Preamplifier OFF, Attenuator 10 dB

±0.5 dB Frequency Range 100 kHz to 2.2 GHz (20°C to 30°C)

±2.0 dB Frequency Range 9 kHz to 2.2 GHz

Preamplifier ON, Attenuator 10 dB

±1.0 dB Frequency Range 100 kHz to 2.2 GHz

±2.0 dB Frequency Range 9 kHz to 2.2 GHz

Apply for R3162

Preamplifier OFF, Attenuator 10 dB

±0.5 dB Frequency Range 100 kHz to 3 GHz (20°C to 30°C)

±2.0 dB Frequency Range 9 kHz to 3.3 GHz

±2.0 dB Frequency Range 3.2 GHz to 8 GHz

Preamplifier ON, Attenuator 10 dB

±1.0 dB Frequency Range 100 kHz to 2.7 GHz

±2.0 dB Frequency Range 9 kHz to 3.3 GHz

5.2.16 Frequency Response

Apply for R3172

Preamplifier OFF, Attenuator 10 dB

±0.6 dB Frequency Range 100 kHz to 3 GHz (20°C to 30°C)

±1.5 dB Frequency Range 9 kHz to 3.3 GHz

±1.8 dB Frequency Range 3.3 GHz to 7.1 GHz

±2.0 dB Frequency Range 7.1 GHz to 14.7 GHz

±3.0 dB Frequency Range 14.7 GHz to 26.5 GHz

Preamplifier ON, Attenuator 10 dB

±1.0 dB Frequency Range 100 kHz to 2.7 GHz

±2.0 dB Frequency Range 9 kHz to 3.3 GHz

Apply for R3182

Preamplifier OFF, Attenuator 10 dB

±0.6 dB Frequency Range 100 kHz to 3 GHz (20°C to 30 °C)

±1.5 dB Frequency Range 9 kHz to 3.3 GHz

±1.8 dB Frequency Range 3.3 GHz to 7.1 GHz

±2.0 dB Frequency Range 7.1 GHz to 14.7 GHz

±3.0 dB Frequency Range 14.7 GHz to 27 GHz

±3.5 dB Frequency Range 27 GHz to 30 GHz

±4.0 dB Frequency Range 30 GHz to 40 GHz

Preamplifier ON, Attenuator 10 dB

±1.0 dB Frequency Range 100 kHz to 2.7 GHz

±2.0 dB Frequency Range 9 kHz to 3.3 GHz

## Instruments Required:

Instruments	Qty.	Recommended Model
Signal Generator	1	SMP04
Power Meter	1	NRVS
Power Sensor	1	NRV-Z55
Power Splitter	1	K241C
Minimum Loss Pad	1 * <sup>1</sup>	HP11852B
RF Cable BNC(m)-BNC(m)	1	MI-09
RF Cable SMA(m)-SMA(m)	3	A01002
RF Cable K(m)-K(m)	1 * <sup>2</sup>	
Adapter N(m)-SMA(f)	2	
Adapter K(f)-K(f)	1 * <sup>2</sup>	

\*1 R3132N Only

\*2 R3182 Only

## Procedures:

## Setting the measurement conditions

1. On the power meter, perform the zeroing and calibration with power sensor.
2. On the power meter, set the unit into dBm mode, after calibration has done.
3. On the power meter, set the correction frequency to 30 MHz.
4. Connect the power meter, the signal generator and the power splitter as shown Figure 5-16.

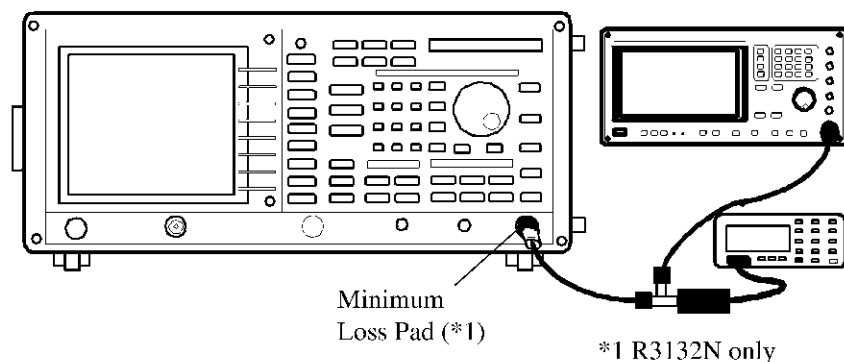

Figure 5-16 Setup of Frequency Response Test

5.2.16 Frequency Response

---

**CAUTION:** Use only 75  $\Omega$  cables, connectors, or adapters on R3132N, or damage to the input connector will occur.

---

5. On the signal generator, set controls as follows:

Frequency:	30 MHz
Frequency Step:	100 MHz
Output Level:	-4 dBm
  
6. On the R3132 series, after preset set controls as follows:

Center Frequency:	30 MHz
CF Step:	100 MHz
Frequency Span:	40 MHz
Reference Level:	-5 dBm
Input Attenuator:	10 dB
dB/div:	1 dB/div
RBW:	3 MHz
VBW:	1 kHz
  
7. Press **MKR**, **Peak Menu** and **Cont Peak ON/OFF**(ON) to set continuous peak search mode.
  
8. On the signal generator, adjust output level so that reading of peak search marker is -10 dBm  $\pm$ 0.09 dB.
  
9. On the power meter, set relative measurement mode.

Measuring frequency response in the frequency range: 9 kHz to 3.3 GHz for R3162/72/82

Measuring frequency response in the frequency range: 9 kHz to 3 GHz for R3132

Measuring frequency response in the frequency range: 9 kHz to 2.2 GHz for R3132N

Under preamplifier off condition

10. On the signal generator, set the frequency to 100 MHz.
  
11. On the R3132 series, set center frequency to 100 MHz.
  
12. On the power meter, set the correction frequency to 100 MHz.
  
13. Adjust output level of signal generator of peak search marker is -10 dBm  $\pm$ 0.09 dB.
  
14. Record the display of power meter reading with reverse sign in the performance verification record sheet.
  
15. On the R3132 series, press **FREQ** and  $\Delta$  to increase center frequency by 100 MHz step.

16. On the signal generator, increase the frequency of output by 100 MHz.
17. On the power meter, increase the correction frequency by 100 MHz.
18. Repeat steps 12 through 17 for every center frequency by 100 MHz step up the center frequency to 3.2 GHz (for R3132, up to 3 GHz, for R3132N, up to 2.2 GHz) listed in the performance verification record sheet.

Under preamplifier on condition

19. On the power meter, Set power meter into dBm mode.
20. On the power meter, set the correction frequency to 30 MHz.
21. On the signal generator, set controls as follows:

Frequency:	30 MHz
Frequency Step:	100 MHz
Output Level:	-14 dBm
22. On the R3132 series, after preset set controls as follows:

Center Frequency:	30 MHz
CF Step:	100 MHz
Frequency Span:	40 MHz
Hi Sense:	ON
Input Attenuator:	10 dB
Reference Level:	-15 dBm
dB/div:	1 dB/div
RBW:	3 MHz
VBW:	1 kHz
23. Press **MKR**, **Peak Menu** and **Cont Peak ON/OFF**(ON) to set continuous peak search mode.
24. On the signal generator, adjust output level so that the reading of peak search marker is -20 dBm  $\pm$ 0.09 dB.
25. On the power meter, set relative measurement mode.
26. On the signal generator, set frequency to 100 MHz.
27. On the power meter, set the correction frequency for 100 MHz.
28. On the signal generator, adjust output level so that reading of peak search marker is -20 dBm  $\pm$ 0.09 dB.
29. Record the display of power meter reading with reverse sign in the performance verification record sheet.

### 5.2.16 Frequency Response

30. On the R3132 series, press **FREQ** and  $\Delta$  to increase center frequency by 100 MHz.
31. On the signal generator, increase the frequency of output by 100 MHz.
32. On the power meter, increase correction frequency by 100 MHz.
33. Repeat step 28 through 32 for every center frequency by 100 MHz step up the center frequency to 3.2 GHz (for R3132 up to 3 GHz, For R3132N up to 2.2 GHz) listed in the performance verification record sheet.

Measuring frequency response in the frequency range: 3.2 GHz to 8 GHz for R3162

Measuring frequency response in the frequency range: 3.3 GHz to 7.1 GHz for R3172/82

(Note: For testing this frequency range, preselector tune is required)

34. For setting the measurement conditions, perform step 1 through 9.
35. Press **MKR, Peak Menu** and *Cont Peak ON/OFF*(ON) to set continuous peak search mode.
36. On the R3162/72/82, set center frequency to 3.3 GHz.
37. On the signal generator, set the frequency to 3.3 GHz.
38. On the power meter, set the correction frequency to 3.3 GHz.
39. On the R3162/72/82, press as follows to tune the preselector.

#### **FREQ, 1/2\_more, Presel, Auto Tune**

40. After the auto tuning has completed, adjust signal generator output level so that the marker reading is  $-10 \text{ dBm} \pm 0.09 \text{ dB}$ .
41. Record the display of power meter reading with reverse sign in the performance verification record sheet.
42. On the R3162/72/82, press **FREQ** and  $\Delta$  to increase center frequency by 100 MHz.
43. On the signal generator, increase the frequency of output by 100 MHz.
44. On the power meter, increase the correction frequency by 100 MHz.
45. Repeat steps 39 through 44 for every center frequency by 100 MHz step up the center frequency to 8 GHz (for R3162) or 7 GHz (for R3172/82) listed in the performance verification record sheet.



Measuring frequency response in the frequency range: 7.1 GHz to 14.7 GHz for R3172/82

(Note: For testing this frequency range, preselector tune is required)

46. On the R3172/82, set controls as follow:

CF Step:                   200 MHz

47. On the R3172/82, set center frequency to 7.2 GHz.

48. On the signal generator, set the frequency to 7.2 GHz.

49. On the power meter, set the correction frequency for 7.2 GHz.

50. On the R3172/82, press as follows to tune the preselector.

**FREQ, 1/2\_more, Presel, Auto Tune**

51. After the auto tuning has completed, adjust signal generator output level so that the marker reading is -10 dBm  $\pm$ 0.09 dB.

52. Record the display of power meter reading with reverse sign in the performance verification record sheet.

53. On the R3172/3182, press **FREQ** and  $\Delta$  to increase center frequency by 200 MHz.

54. On the signal generator, increase the frequency of output by 200 MHz.

55. On the power meter, increase the correction frequency by 200 MHz.

56. Repeat steps 50 through 55 for every center frequency by 200 MHz step up the center frequency to 14.6 GHz listed in the performance verification record sheet.

Measuring frequency response in the frequency range: 14.7 GHz to 26.5 GHz for R3172

Measuring frequency response in the frequency range: 14.7 GHz to 27 GHz for R3182

(Note: For testing this frequency range, preselector tune is required)

57. On the R3172/82, set center frequency to 14.8 GHz.

58. On the signal generator, set the frequency to 14.8 GHz.

59. On the power meter, set the correction frequency to 14.8 GHz.

60. On the R3172/82, press as follows to tune the preselector.

**FREQ, 1/2\_more, Presel, Auto Tune**

5.2.16 Frequency Response

61. After the auto tuning has completed, adjust signal generator output level so that the marker reading is  $-10 \text{ dBm} \pm 0.09 \text{ dB}$ .
62. Record the display of power meter reading with reverse sign in the performance verification record sheet.
63. On the R3172/82, press **FREQ** and  $\Delta$  to increase center frequency by 200 MHz.
64. On the signal generator, increase the frequency of output by 200 MHz.
65. On the power meter, increase the correction frequency by 200 MHz.
66. Repeat steps 60 through 65 for every center frequency by 200 MHz step up the center frequency to 26.4 GHz (for R3172) or 26.8 GHz (for R3182) listed in the performance verification record sheet.

Measuring frequency response in the frequency range: 27 GHz to 30 GHz for R3182  
(Note: For testing this frequency range, preselector tune is required)

67. On the R3182, set center frequency to 27 GHz.
68. On the signal generator, set the frequency to 27 GHz.
69. On the power meter, set the correction frequency to 27 GHz.
70. On the R3182, press as follows to tune the preselector.

**FREQ, 1/2\_more, Presel, Auto Tune**

71. After the auto tuning has completed, adjust signal generator output level so that the marker reading is  $-10 \text{ dBm} \pm 0.09 \text{ dB}$ .
72. Record the display of power meter reading with reverse sign in the performance verification record sheet.
73. On the R3182, press **FREQ** and  $\Delta$  to increase center frequency by 200 MHz.
74. On the signal generator, increase the frequency of output by 200 MHz.
75. On the power meter, increase the correction frequency by 200 MHz.
76. Repeat steps 70 through 75 for every center frequency by 200 MHz step up the center frequency to 29.8 GHz listed in the performance verification record sheet.

Measuring frequency response in the frequency range: 30 GHz to 40 GHz for R3182  
(Note: For testing this frequency range, preselector tune is required)

77. On the R3182, set center frequency to 30 GHz.
78. On the signal generator, set the frequency to 30 GHz.

79. On the power meter, set the correction frequency to 30 GHz.
80. On the R3182, press as follows to tune the preselector.

**FREQ, 1/2\_more, Presel, Auto Tune**

81. After the auto tuning has completed, adjust signal generator output level so that the marker reading is  $-10 \text{ dBm} \pm 0.09 \text{ dB}$ .
82. Record the display of power meter reading with reverse sign in the performance verification record sheet.
83. On the R3182, press **FREQ** and  $\Delta$  to increase center frequency by 200 MHz.
84. On the signal generator, increase the frequency of output by 200 MHz.
85. On the power meter, increase the correction frequency by 200 MHz.
86. Repeat steps 80 through 85 for every center frequency by 200 MHz step up the center frequency to 40 GHz listed in the performance verification record sheet.

5.2.17 Frequency Span Accuracy

**5.2.17 Frequency Span Accuracy**

Set the signal frequency twice with the signal generator and measure the difference between signal frequencies with the analyzer.

Check the span accuracy using the signal frequency difference measured with the delta marker function. The R3132 series is phase-locked to the signal generator's 10 MHz reference.

Specification:

±1% of the frequency span setting.

Instruments Required:

Instruments	Qty.	Recommended Model
Signal Generator	1	SMP04
Minimum Loss Pad	1 *1	HP11852B
RF Cable BNC(m)-BNC(m)	1	MI-09
RF Cable SMA(m)-SMA(m)	1	A01002
RF Cable K(m)-K(m)	1 *2	
Adapter N(m)-SMA(f)	2	
Adapter K(f)-K(f)	1 *2	

\*1 R3132N Only

\*2 R3182 Only

Procedures:

Setting the measurement conditions

1. Connect the signal generator as shown Figure 5-17.

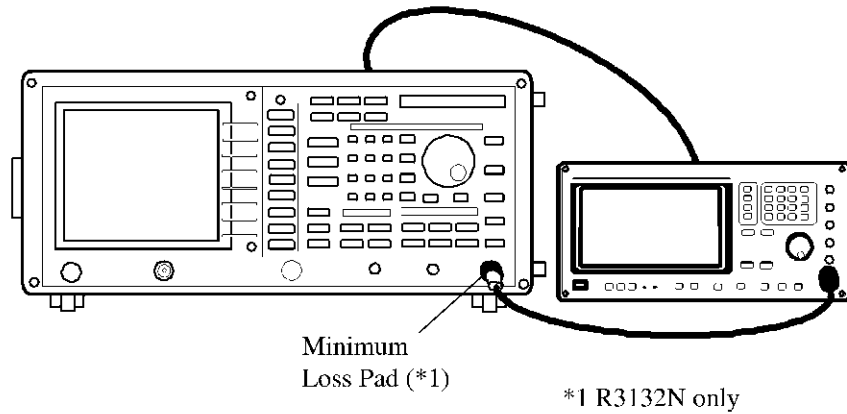

**Figure 5-17 Setup of Frequency Span Accuracy Test**

---

**CAUTION:** Use only 75  $\Omega$  cables, connectors, or adapters on R3132N, or damage to the input connector will occur.

---

2. On the signal generator, set controls as follow:  
Output Level: -5 dBm

#### Measuring the Frequency Span Accuracy

3. On the R3132 series, after preset, set controls as follows:  
Center Frequency: 1.5 GHz  
Frequency Span: 100 kHz
4. On the signal generator, set output frequency as follow for first frequency:  
Frequency: 1.49996 GHz
5. On the R3132 series, press **SINGLE** for single sweep.
6. On the R3132 series, after sweep has completed, press **PK SRCH** to capture signal peak.
7. On the R3132 series, press as follows to set delta marker to on.

#### **MKR, Delta**

8. On the signal generator, set output frequency as follow for second frequency:  
Frequency: 1.50004 GHz
9. On the R3132 series, press **SINGLE** for single sweep.
10. On the R3132 series, after seep has completed, press **PK SRCH** to capture signal peak.
11. Record the frequency of delta marker on the performance verification record sheet.
12. Repeat step 3 through 11 for each frequency setting listed in Table 5-20.

5.2.17 Frequency Span Accuracy

**Table 5-20 Center and Span Frequencies for the R3132 series**

Center Frequency	Frequency Span	SMP04 1st Frequency	SMP04 2nd Frequency
1.5 GHz	1 MHz	1.4996 GHz	1.5004 GHz
1.5 GHz	10 MHz	1.496 GHz	1.504 GHz
1.5 GHz	100 MHz	1.46 GHz	1.54 GHz
1.5 GHz	1 GHz	1.1 GHz	1.9 GHz
1.5 GHz	3 GHz	0.1 GHz	2.9 GHz

Following steps are applied for R3162/72/82  
 Measurement for a center frequency of 4 GHz

13. Repeat steps 3 through 11 for each frequency setting listed in Table 5-21.

**Table 5-21 Center and Span Frequencies for the R3162/72/82**

Center Frequency	Frequency Span	SMP04 1st Frequency	SMP04 2nd Frequency
4 GHz	10 MHz	3.996 GHz	4.004 GHz
4 GHz	100 MHz	3.96 GHz	4.04 GHz
4 GHz	1 GHz	3.6 GHz	4.4 GHz
4 GHz	8 GHz	0.2 GHz	7.2 GHz
7.5 GHz	10 MHz	7.496 GHz	7.504 GHz
7.5 GHz	100 MHz	7.46 GHz	7.54 GHz

Following steps are applied for R3172/82  
 Measurement for a center frequency of 10 GHz and 17 GHz

14. Repeat steps 3 through 11 for each frequency setting listed in Table 5-22.

**Table 5-22 Center and Span Frequencies for the R3172/82**

Center Frequency	Frequency Span	SMP04 1st Frequency	SMP04 2nd Frequency
10 GHz	10 MHz	9.996 GHz	10.004 GHz
10 GHz	100 MHz	9.96 GHz	10.04 GHz
10 GHz	1 GHz	9.6 GHz	10.4 GHz
10 GHz	10 GHz	6 GHz	14 GHz
10 GHz	20 GHz	1 GHz	19 GHz
17 GHz	10 MHz	16.996 GHz	17.004 GHz
17 GHz	100 MHz	16.96 GHz	17.04 GHz
17 GHz	1 GHz	16.6 GHz	17.4 GHz

Following steps are applied for R3182

Measurement for a center frequency of 20 GHz, 28 GHz and 35 GHz.

15. Repeat steps 3 through 11 for each frequency setting listed in Table 5-23.

**Table 5-23 Center and Span Frequencies for the R3182**

Center Frequency	Frequency Span	SMP04 1st Frequency	SMP04 2nd Frequency
28 GHz	10 MHz	27.996 GHz	28.004 GHz
28 GHz	100 MHz	27.96 GHz	28.04 GHz
28 GHz	1 GHz	27.6 GHz	28.4 GHz
35 GHz	10 MHz	34.996 GHz	35.004 GHz
35 GHz	100 MHz	34.96 GHz	35.04 GHz
35 GHz	1 GHz	34.6 GHz	35.4 GHz
20 GHz	30 GHz	8 GHz	32 GHz

### 5.2.18 Third Order Intermodulation Distortion

Two Signal generators provide the signals required for measuring third order intermodulation.

It is difficult when the input level is low because of being buried to the noise, to measure the spectrum generated by the distortion. Third ordered intermodulation is raised by 20 dB if the input level is raised by 10 dB. Then examine with mixer input level set in -20 dBm after the specification is converted into a value, which is 20 dB larger. Here provides procedure at -20 dBm for a total mixer input level. The test points of center frequencies are 200 MHz, 1500 MHz, 2500 MHz, 3600 MHz and 7500 MHz.

The points of 3600 MHz and 7500 MHz are applied for R3162/72/82.

Specification:

Total mixer input level: -30 dBm, (+77 dB $\mu$ V: R3132N), two signal difference 50 kHz

Apply for R3132/32N

$\leq -80$  dBc ( $\leq -60$  dBc \*)      Frequency Range 200 MHz to 3 GHz

Apply for R3162

$\leq -80$  dBc ( $\leq -60$  dBc \*)      Frequency Range 200 MHz to 8 GHz

Apply for R3172

$\leq -80$  dBc ( $\leq -60$  dBc \*)      Frequency Range 200 MHz to 3.3 GHz

$\leq -70$  dBc ( $\leq -50$  dBc \*)      Frequency Range 3.2 GHz to 26.5 GHz

Apply for R3182

$\leq -80$  dBc ( $\leq -60$  dBc \*)      Frequency Range 200 MHz to 3.3 GHz

$\leq -75$  dBc ( $\leq -55$  dBc \*)      Frequency Range 3.2 GHz to 30 GHz

$\leq -70$  dBc ( $\leq -50$  dBc \*)      Frequency Range 29.5 GHz to 40 GHz

\* : Converted specification for a total mixer input level of -20 dBm



## Instruments Required:

Instruments	Qty.	Recommended Model
Signal Generator	1	SMP02
Signal Generator	1	SMP04
Power Meter	1	NRVS
Power Sensor	1	NRV-Z55
Power Divider	1	DDUL-20A-1000
Power Divider	1	DDUL-20A-10G
Minimum Loss Pad	1 *1	HP11852B
RF Cable SMA(m)-SMA(m)	3	A01002
Adapter N(m)-SMA(f)	2	
Adapter SMA(f)-SMA(f)	1 *2	

\*1 R3132N Only

\*2 R3182 Only

## Procedures:

## Initializing the power meter and the sensor

1. On the power meter, perform the zeroing and calibration with power sensor.
2. On the power meter, set the unit into dBm mode, after calibration has done.
3. On the power meter, set the correction frequency to 200 MHz.

## Setting the measurement conditions (Frequency 200 MHz)

4. Connect the power sensor to power divider output.

5.2.18 Third Order Intermodulation Distortion

5. Connect the signal generators and power divider as shown Figure 5-18.

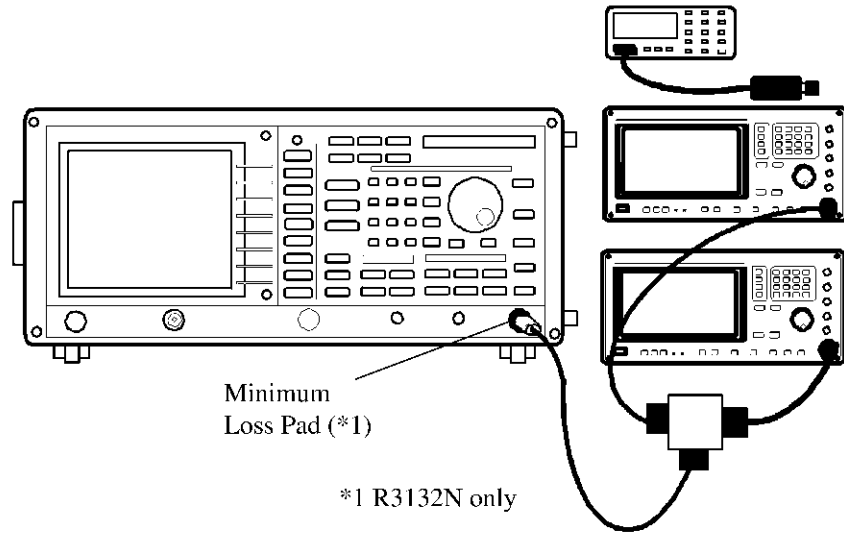

Figure 5-18 Setup of Third Order Intermodulation Distortion Test

---

**CAUTION:** Use only 75  $\Omega$  cables, connectors, or adapters on R3132N, or damage to the input connector will occur.

---

6. On the both of signal generators, set controls as follows:  
Signal Generator (SMP02)  
Frequency: 200 MHz  
Output Level: -10 dBm  
RF Output: Off  
Signal Generator (SMP04)  
Frequency: 200.05 MHz  
Output Level: -10 dBm  
RF Output: Off
7. On the signal generator (SMP02), turn output level on.
8. On the signal generator (SMP02), adjust the output level so that power meter reading is -10.0 dBm  $\pm$ 0.1 dB.
9. On the signal generator (SMP02), turn output level off.
10. On the signal generator (SMP04), turn output level on.
11. On the signal generator (SMP04), adjust the output level so that power meter reading is -10.0 dBm  $\pm$ 0.1 dB.
12. On the signal generator (SMP04), turn output level off.

## Measuring the Third Order Intermodulation Distortion (Frequency 200 MHz)

13. On the R3132 series, after preset, set controls as follows:

Center Frequency    200 MHz  
 Span:                    500 kHz  
 Input Attenuator:    10 dB  
 Reference Level:     -10 dBm  
 RBW:                    3 kHz  
 VBW:                    300 Hz

14. Turn RF output on for both of signal generator.
15. On the R3162/72/82, this procedures are required for the frequency above 3.3 GHz.

Press as follows to turn preselector peak.

**PK SRCH, FREQ, 1/2\_more, Presel, Auto Tune**

Wait till auto tuning has completed.

16. On the R3132 series, press as follows to set signal peak to reference level.

**PK SRCH, MKR→, MKR→Ref**

17. On the R3132 series, press as follows to set third order measure mode.

**MEAS, 3rd Order Meas**

18. Record the level of delta marker reading in dBc on the performance verification record sheet.

## Setting the measurement conditions (Other Frequency)

19. Repeat step 3 through 18 for each frequency setting listed in Table 5-24.

**Table 5-24 Third Order Intermodulation Distortion Test Setting**

R3132 series Center Frequency	SMP02 Frequency	SMP04 Frequency	NRVS Frequency
1500 MHz	1500 MHz	1500.05 MHz	1500 MHz
2500 MHz	2500 MHz	2500.05 MHz	2500 MHz

5.2.18 Third Order Intermodulation Distortion

Following step is applied for R3162/72/82

20. Repeat step 3 through 18 for each frequency setting listed in Table 5-25.

**Table 5-25 Third Order Intermodulation Distortion Test Setting for the R3162/72/82**

R3132 series Center Frequency	SMP02 Frequency	SMP04 Frequency	NRVS Frequency
3600 MHz	3600.05 MHz	3600 MHz	3600 MHz
7500 MHz	7500.05 MHz	7500 MHz	7500 MHz

### 5.2.19 Gain Compression

This test measures the analyzer's gain compression using two signals that are 1 MHz apart. First the test places a -30 dBm signal at the input of the R3132 series (the R3132 series reference level is also set to -30 dBm).

Then the specified signal level is input to the R3132 series, overdriving its input. The decrease in the first signal's amplitude (gain compression) caused by the second signal is the measured gain compression.

Specification:

Apply for R3132

> -0 dBm (mixer input level)	Preamplifier OFF, Frequency Range 200 MHz to 3 GHz
> -25 dBm (RF input level)	Preamplifier ON, Frequency Range 200 MHz to 3 GHz

Apply for R3132N

> +107 dB $\mu$ V (mixer input level)	Preamplifier OFF, Frequency Range 200 MHz to 2.2 GHz
> +82 dB $\mu$ V (RF input level)	Preamplifier ON, Frequency Range 200 MHz to 2.2 GHz

Apply for R3162

> -0 dBm (mixer input level)	Preamplifier OFF, Frequency Range 200 MHz to 8 GHz
> -25 dBm (RF input level)	Preamplifier ON, Frequency Range 200 MHz to 3.3 GHz

Apply for R3172

> -0 dBm (mixer input level)	Preamplifier OFF, Frequency Range 200 MHz to 3.3 GHz
> -5 dBm (mixer input level)	Preamplifier OFF, Frequency Range 3.2 MHz to 26.5 GHz
> -25 dBm (RF input level)	Preamplifier ON, Frequency Range 200 MHz to 3.3 GHz

Apply for R3182

> -0 dBm (mixer input level)	Preamplifier OFF, Frequency Range 200 MHz to 3.3 GHz
> -5 dBm (mixer input level)	Preamplifier OFF, Frequency Range 3.2 MHz to 40 GHz
> -25 dBm (RF input level)	Preamplifier ON, Frequency Range 200 MHz to 3.3 GHz

5.2.19 Gain Compression

Instruments Required:

Instruments	Qty.	Recommended Model
Signal Generator	1	SMP02
Signal Generator	1	SMP04
Power Meter	1	NRVS
Power Sensor	1	NRV-Z55
Power Splitter	1	DDUL-20A-1000
3 dB Attenuator	1	DEE-000685-1
20 dB Attenuator	1	DEE-000480-1
RF Cable SMA(m)-SMA(m)	3	A01002
Minimum Loss Pad	1 *1	HP11852B
Adapter N(m)-SMA(f)	2	
Adapter SMA(f)-SMA(f)	1 *2	

\*1 R3132N Only

\*2 R3182 Only

Procedures:

Initializing the power meter and the sensor

1. On the power meter, perform the zeroing and calibration with power sensor.
2. On the power meter, set the unit into dBm mode, after calibration has done.

Under preamplifier off condition

Setting the measurement conditions (Frequency 200 MHz)

3. Connect the signal generators as shown Figure 5-19.

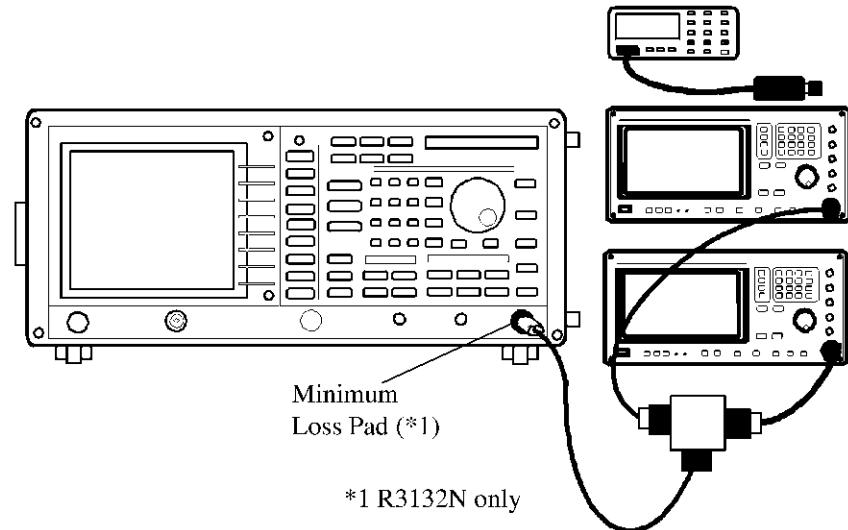

**Figure 5-19 Setup of Gain Compression Test**

**CAUTION:** Use only 75  $\Omega$  cables, connectors, or adapters on R3132N, or damage to the input connector will occur.

4. On the both of signal generators, Set controls as follows:
 

Signal Generator (SMP02)	
Frequency:	201 MHz
Output Level:	-2 dBm
Signal Generator (SMP04)	
Frequency:	200 MHz
Output Level:	-4 dBm
5. On the R3132 series, after preset, set controls as follows:
 

Center Frequency:	200.5 MHz
Span:	2 MHz
Reference Level:	-30 dBm
Input Attenuator:	0 dB
dB/div:	1 dB/div

Measuring the gain compression (Frequency 200 MHz)

6. On the signal generator (SMP02), turn output level off.
7. On the signal generator (SMP04), adjust the output level for a displayed signal of -30 dBm  $\pm$ 0.1 dB on the R3132 series screen

### 5.2.19 Gain Compression

8. On the signal generator (SMP02), turn output level on.
9. On the signal generator (SMP02), adjust output level until the signal level at 2.5 division in the left hand part on the R3132 series screen is decreased by 1 dB from -30 dBm.
10. Remove the RF cable from the input terminal of R3132 series, connect power sensor there.
11. On the power meter, set the correction frequency to 200 MHz.
12. Record the level of the power meter reading on the performance verification record sheet.

Under preamplifier on condition

Setting the measurement conditions (Frequency 200 MHz)

13. Connect the signal generators as shown Figure 5-19.
14. On the both of signal generators, Set controls as follows:  
Signal Generator (SMP02)  
Frequency: 201 MHz  
Output Level: -50 dBm  
Signal Generator (SMP04)  
Frequency: 200 MHz  
Output Level: -50 dBm
15. On the R3132 series, after preset, set controls as follows:  
Center Frequency: 200.5 MHz  
Span: 2 MHz  
Reference Level: -50 dBm  
Hi Sense: ON  
Input Attenuator: 0 dB  
dB/div: 1 dB/div

Measuring the gain compression (Frequency 200 MHz)

16. On the signal generator (SMP02), turn output level off.
17. On the signal generator (SMP04), adjust the output level for a displayed signal of -50 dBm  $\pm$ 0.1 dB on the R3132 series screen
18. On the signal generator (SMP02), turn output level on.
19. On the signal generator (SMP02), adjust output level until the signal level at 2.5 division in the left hand part on the R3132 series screen is decreased by 1 dB from -50 dBm.



20. Remove the RF cable from the input terminal of R3132 series, connect power sensor there.
21. On the power meter, set the correction frequency to 200 MHz.
22. Record the level of the power meter reading on the performance verification record sheet.

Following steps are applied for R3162/72/82

Setting the measurement conditions (Frequency 3.6 GHz)

23. Connect the signal generators as shown Figure 5-19.
24. Set both of signal generators controls as follows:  
Signal Generator (SMP02)  
Frequency: 3601 MHz  
Output Level: -12 dBm  
Signal Generator (SMP04)  
Frequency: 3600 MHz  
Output Level: -14 dBm
25. On the R3162/72/82, after preset, set controls as follows:  
Center Frequency: 3600.5 MHz  
Span: 2 MHz  
Input Attenuator 0 dB  
Reference Level: -10 dBm  
dB/div: 10 dB/div
26. On the R3162/72/82, press as follows to tune preselector peak.  
**PK SRCH, FREQ, 1/2\_more, Presel, Auto Tune**
27. On the R3162/72/82, set controls as follows:  
Reference Level: -30 dBm  
dB/div: 1 dB/div

Measuring the gain compression (Frequency 3.6 GHz)

28. On the signal generator (SMP02), turn output level off.
29. On the signal generator (SMP04), adjust the output level for a displayed signal of -30 dBm  $\pm$ 0.1 dB on the R3162/72/82 screen
30. On the signal generator (SMP02), turn output level on.

#### 5.2.19 Gain Compression

31. On the signal generator (SMP02), adjust output level until the signal level at 2.5 division in the left hand part on the R3162/72/82 screen is decreased by 1 dB from -30 dBm.
32. Remove the RF cable from the input terminal of R3162/72/82, connect power sensor there.
33. On the power meter, set the correction frequency to 3600 MHz.
34. Record the level of the power meter reading on the performance verification record sheet.

### 5.2.20 Sweep Time Accuracy

A Square Wave is displayed on the R3132 series in ZERO span mode, and measure the frequency of the displayed signal using video trigger.

Specification:

$\pm 2\%$  of sweep time setting

Instruments Required:

Instruments	Qty.	Recommended Model
Signal Generator	1	SMT02
RF Cable BNC(m)-BNC(m)	1	MI-09
Minimum Loss Pad	1 *1	HP11852B
Adapter N(m)-BNC(f)	2	
Adapter SMA(f)-SMA(f)	1 *2	
Adapter SMA(m)-BNC(f)	1 *2	

\*1 R3132N Only

\*2 R3182 Only

Procedures:

Setting the measurement conditions

1. Connect the signal generator as shown in Figure 5-20.

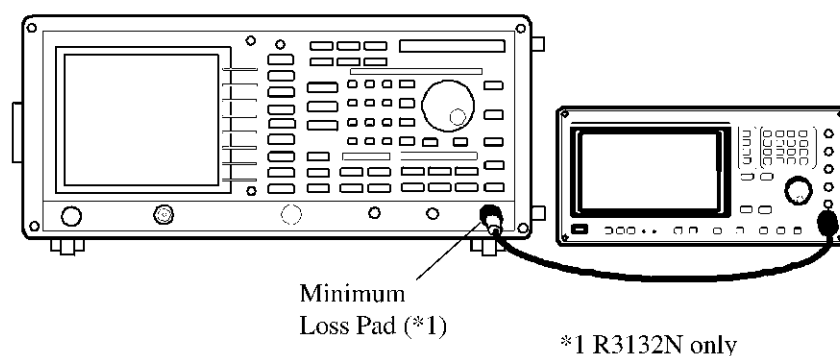

Figure 5-20 Setup of Sweep Time Accuracy Test

**CAUTION:** Use only 75  $\Omega$  cables, connectors, or adapters on R3132N, or damage to the input connector will occur.

### 5.2.20 Sweep Time Accuracy

2. On the signal generator, set controls as follows:

Frequency:	30 MHz
Output Level:	-10 dBm
Pulse:	ON
Pulse Period:	45 sec
Pulse Width:	1 sec
  
3. On the R3132 series, after preset, set controls as follows:

Center Frequency:	30 MHz
Span:	Zero
Reference Level:	0 dBm
RBW:	3 MHz
VBW:	3 MHz
Sweep Time:	50 sec
  
4. On the R3132 series, press as follows to set trigger mode to video.

**TRIG, Trig Source, Video Trig**
  
5. On the R3132 series, adjust the trigger level for sweep using data knob.
  
6. On the R3132 series, press **SWEEP** and *Trig Delay*.
  
7. On the R3132 series, turn the data knob clockwise until two leading edges appear on the screen.

#### Measuring the Sweep Time Accuracy

8. On the R3132 series, press **SINGLE** for single sweep.
  
9. On the R3132 series, after sweep has completed, press **MKR** then move it to first leading edge on the waveform.
  
10. On the R3132 series, press **MKR** and *Delta*.
  
11. On the R3132 series, press **MKR** then move it to second leading edge on the waveform.
  
12. Record the time of the delta marker reading on the performance verification record sheet.
  
13. Repeat step 2 through 12 for each sweep time setting listed in Table 5-26.

**Table 5-26 Sweep Time Accuracy Test Setting**

For R3132 series	For signal generator	
Sweep Time	Pulse Period	Pulse Width
50 sec	45 sec	1 sec
5 sec	4.5 sec	1 sec
500 msec	450 msec	200 msec
50 msec	45 msec	20 msec
5 msec (OPT29)	4.5 msec	2 msec
500 µsec (OPT29)	450 µsec	200 µsec
50 µsec (OPT29)	45 µsec	20 µsec

5.2.21 Residual Response

**5.2.21 Residual Response**

This test checks for residual responses under preamplifier on and off cases.

Any response located above the display line is measured in a narrow frequency span and RBW.

The RF INPUT is terminated.

Specification:

Apply for R3132

≤ -100 dBm Preamplifier OFF, Frequency Range 1 MHz to 3 GHz

≤ -105 dBm Preamplifier ON, Frequency Range 1 MHz to 3 GHz

Apply for R3132N

≤ +11 dBμV Preamplifier OFF, Frequency Range 1 MHz to 2.2 GHz

≤ +6 dBμV Preamplifier ON, Frequency Range 1 MHz to 2.2 GHz

Apply for R3162

≤ -100 dBm Preamplifier OFF, Frequency Range 1 MHz to 3.3 GHz

≤ -90 dBm Preamplifier OFF, Frequency Range 3.2 GHz to 8 GHz

≤ -105 dBm Preamplifier ON, Frequency Range 1 MHz to 3.3 GHz

Apply for R3172

≤ -100 dBm Preamplifier OFF, Frequency Range 1 MHz to 3.3 GHz

≤ -90 dBm Preamplifier OFF, Frequency Range 3.2 GHz to 26.5 GHz

≤ -105 dBm Preamplifier ON, Frequency Range 1 MHz to 3.3 GHz

Apply for R3182

≤ -100 dBm Preamplifier OFF, Frequency Range 1 MHz to 3.3 GHz

≤ -90 dBm Preamplifier OFF, Frequency Range 3.2 GHz to 40 GHz

≤ -105 dBm Preamplifier ON, Frequency Range 1 MHz to 3.3 GHz

Instruments Required:

Instruments	Qty.	Recommended Model
Terminator 50 Ω (for R3132/3162)	1	RNA
Terminator 50 Ω (for R3172)	1	
Terminator 50 Ω (for R3182)	1	
Terminator 75 Ω (for R3132N)	1	

## Procedures:

## Checking the CAL OUT signal level

1. Connect the between the CAL OUT and RF INPUT by cable.
2. On the R3132 series, after preset, set controls as follows:
 

Center Frequency:	30 MHz
Span:	10 kHz
Reference Level:	-20 dBm
RBW:	300 kHz
Input Attenuator:	0 dB
Hi Sense:	OFF
3. On the R3132 series, press **PK SRCH** to capture signal peak.
4. Check that the marker amplitude is within  $-20.0 \text{ dBm} \pm 0.3 \text{ dB}$ .  
If it is out of range, press as follows to perform CAL ALL:  
**SHIFT, 7(CAL), Cal All**  
After Cal All has completed, check that the marker amplitude is within  $-20.0 \text{ dBm} \pm 0.3 \text{ dB}$ .

## Setting the measurement conditions

5. Remove the cable and adapter from the INPUT.
6. Connect the terminator on the INPUT as shown Figure 5-21.

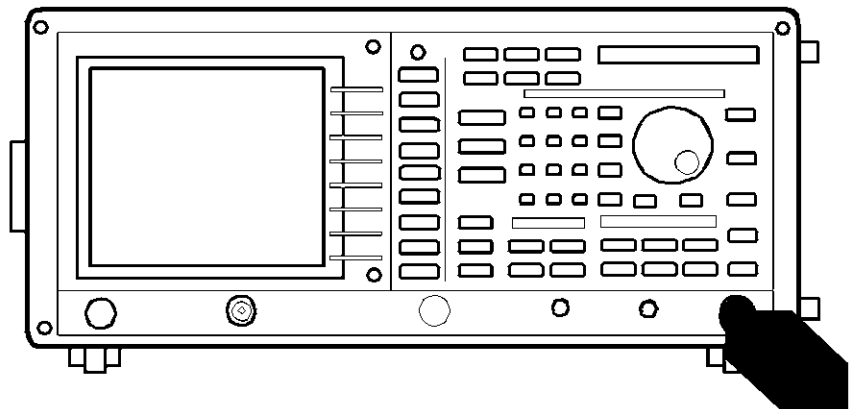

Figure 5-21 Setup of Residual Response Test

---

**CAUTION:** Use only 75  $\Omega$  cables, connectors, or adapters on R3132N, or damage to the input connector will occur.

---

### 5.2.21 Residual Response

7. On the R3132 series, after preset, set controls as follows:

Center Frequency:	2 MHz
Span:	2 MHz
CF Step Size:	1.9 MHz
Reference Level:	-50 dBm
Input Attenuator:	0 dB
RBW:	10 kHz
VBW:	300 Hz

Measurement the residual response on the 1 MHz to 3 GHz for R3132/32N

Measurement the residual response on the 1 MHz to 3.3 GHz for R3162/72/82

Under preamplifier off condition

8. Press **DISPLAY**, *Disp Line ON/OFF*(ON), **1, 0, 0** and **MHz(-dBm)** to place display line at 100 dBm position.
9. Press **SINGLE**, for single sweep.  
The noise level should be at least 3 dB below the display line. If it is not, it will be necessary to reduce the Span and RBW to reduce the noise level. If the span is reduced, reduce the CF Step to no more than 95% of the Span.
10. If a residual is suspected, press the **SINGLE** again.  
A residual response will persist, but a noise peak will not. Record the frequency and amplitude of any responses above the display line.
11. If a response is marginal, verify the response amplitude as follows:

Press **SHIFT**, **RECALL(SAVE)**, **1**, and **Hz(ENTER)** to save the setting condition.

Press **REPEAT** to set continuous sweep mode

Place the marker on the peak of the response in the question.

Press **MKR→**, **MKR→CF** to set marker frequency to center.

Press **BW** and **RBW AUTO/NMN(AUTO)** to set RBW auto mode.

Continue to reduce the span until a RBW of 1 kHz is reached.

Press **MKR→**, **Peak→CF** to set peak to center.

Record the frequency and amplitude of any residual response above the display line.

Press **RECALL** and *Recall* to recall the setting condition.

12. Check for residuals up to center frequency 3.29 GHz (for R3132/32N up to 2.99 GHz) using the procedure of step 6 through 9.  
To change the center frequency, then press the **FREQ** and  $\Delta$  keys.



Under preamplifier on condition

13. On the R3132 series, press **LEVEL** and **Hi Sens ON/OFF(ON)** to set preamplifier to on.
14. On the R3132 series, press **DISPLAY, Disp Line ON/OFF(ON), 1, 0, 5** and **MHz(-dBm)** to place display line at -105 dBm position.
15. Repeat step 5 through 12.

Following steps are applied for R3162/72/82

Under preamplifier on condition

Measurement the residual response on the 3.2 GHz to 8 GHz for R3162

Measurement the residual response on the 3.2 GHz to 7.1 GHz for R3172/82

16. On the R3162/72/82, set controls as follows:

Center Frequency:	3.325 GHz
Span:	50 MHz
CF Step Size:	47.5 MHz
RBW:	100 kHz
VBW:	300 Hz
17. On the R3162/72/82, press **DISPLAY, Disp Line ON/OFF(ON), 9, 0** and **MHz (-dBm)** to place display line at -90 dBm position.
18. Repeat step 5 through 12 until the center frequency of 7.975 GHz (R3162) or 7.075 GHz (R3172/82).

5.3 Tracking Generator Performance Verification Procedure

**5.3 Tracking Generator Performance Verification Procedure**

**5.3.1 Absolute Output Level Accuracy**

A calibrated power sensor is connected to the tracking generator output to measure the power level at 30 MHz and output level -10 dBm.

Specification:

R3132/62/72

-10 dBm  $\pm$ 0.5 dB at Center 30 MHz, output level -10 dBm.

R3132N

95 dB $\mu$ V  $\pm$ 0.5 dB at Center 30 MHz, output level 95 dB $\mu$ V.

Instruments Required:

Instruments	Qty.	Recommended Model
Power Meter	1	NRVS
Power Sensor	1	NRVS
Power Sensor 75 $\Omega$	1*	NRV-Z3

\* R3132N Only

Procedures:

Setting the measurement conditions

1. On the power meter, perform the zeroing and calibration with power sensor.
2. On the power meter, set the unit into dBm mode, after calibration has done.
3. Connect the equipment as shown Figure 5-22.

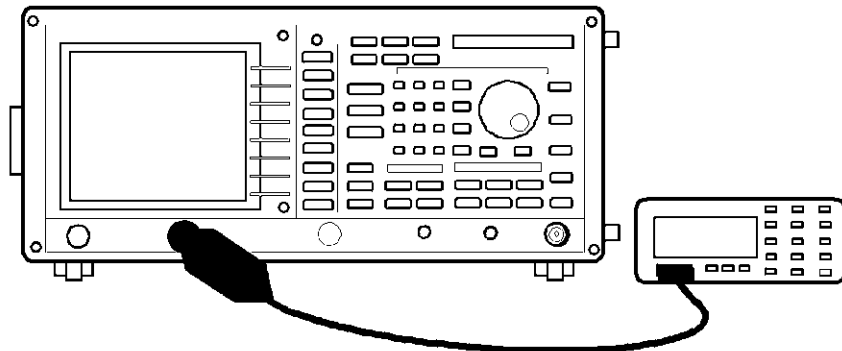

Figure 5-22 Setup of Absolute Output Level Accuracy Test

---

**CAUTION:** Use only 75  $\Omega$  cables, connectors, or adapters on R3132N, or damage to the input connector will occur.

---

#### Measuring the Tracking Generator Output Level

4. On the R3132 series, after preset, set controls as follows:  
Center Frequency: 30 MHz  
Span Zero: Span  
TG Output Level: -10 dBm  
TG: ON
5. On the power meter, set correction frequency to 30 MHz.
6. Record the measurement value of the power meter on the performance verification record sheet.

5.3.2 Output Level Flatness

**5.3.2 Output Level Flatness**

Output level flatness is measured by RF power meter relative mode referenced to center frequency at 30 MHz, output level -10 dBm.

Specification:

- ±1.0 dB                      Frequency Range 100 kHz to 1 GHz
- ±1.5 dB                      Frequency Range 100 kHz to 3 GHz

Instruments Required:

Instruments	Qty.	Recommended Model
Power Meter	1	NRVS
Power Sensor	1	NRV-Z51
Power Sensor 75 Ω	1*	NRV-Z3

\* R3132N Only

Procedures:

Setting the measurement conditions

1. On the power meter, perform the zeroing and calibration with power sensor.
2. On the power meter, set the unit into dBm mode, after calibration has done.
3. Connect the power sensor as shown Figure 5-23.

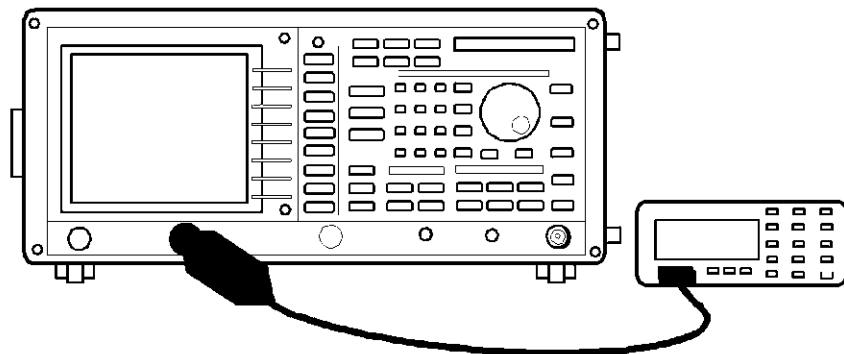

**Figure 5-23 Setup of Output Level Flatness Test**

**CAUTION:** Use only 75 Ω cables, connectors, or adapters on R3132N, or damage to the input connector will occur.

4. On the R3132 series, set controls as follows.  
Center Frequency: 30 MHz  
Span Zero: Span  
TG Output Level: -10 dBm  
TG: ON
5. On the power meter, set the correction frequency to 30 MHz.
6. On the power meter, set relative measurement mode.

#### Measuring the Tracking Generator Output Level Flatness

7. On the R3132 series, set center frequency to 100 kHz.
8. On the power meter, set the correction frequency to 100 kHz.
9. Record power meter reading on the performance verification record sheet.
10. Repeat steps 7 through 9 for each center frequency listed in Table 5-27.

5.3.2 Output Level Flatness

**Table 5-27 Output Flatness Test Setting**

Center Frequency
30 MHz
100 kHz
300 kHz
1 MHz
3 MHz
10 MHz
100 MHz
200 MHz
400 MHz
600 MHz
800 MHz
1 GHz
1.2 GHz
1.4 GHz
1.6 GHz
1.8 GHz
2 GHz
2.2 GHz
2.2 GHz
2.4 GHz
2.6 GHz
2.8 GHz
3 GHz

### 5.3.3 Output Level Switching Accuracy

Measure the switching accuracy of TG output attenuator, after CAL ALL performed.

Measure level of several frequency against output level -10.0 dBm as reference.

The measurement of deviation from -10 dBm point using normalize function.

When change TG output level, reference level setting also change for trace data to stay center of vertical on the screen.

Specification:

±1.0 dB	Frequency Range 100 kHz to 1 GHz, TG level ≥-30 dBm
±2.0 dB	Frequency Range 100 kHz to 2.6 GHz
±3.0 dB	Frequency Range 100 kHz to 3 GHz

Instruments Required:

Instruments	Qty.	Recommended Model
RF Cable BNC(m)-BNC(m)	3	MI-09
RF Cable BNC(m)-BNC(m) 75 Ω	1*	DCB-FFA701X01
Adapter N(m)-BNC(f)	1	
Adapter N(m)-BNC(f) 75 Ω	1*	

\* R3132N Only

Procedures:

Calibration

1. On the R3132 series, after preset, press as follows to perform auto calibration.  
**SHIFT, 7(CAL)** and *Cal All*.

Initialization

2. Press **SHIFT** and **CONFIG(PRESET)**.

Setting the measurement conditions

3. Connect the SMA cable from TG OUT connector to the INPUT connector as shown Figure 5-24.

5.3.3 Output Level Switching Accuracy

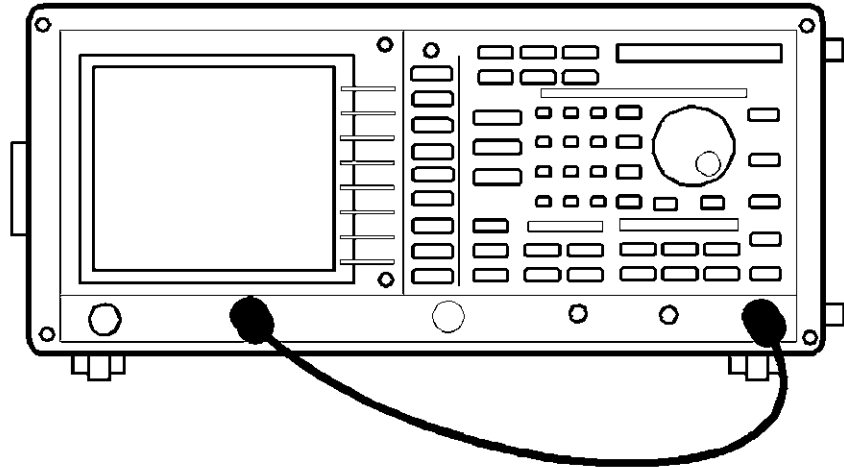

Figure 5-24 Setup of Output Switching Accuracy Test

---

**CAUTION:** Use only 75  $\Omega$  cables, connectors, or adapters on R3132N, or damage to the input connector will occur.

---

4. On the R3132 series, set controls as follows:  
Center Frequency: 30 MHz  
Span: Zero  
Reference level: -5 dB  
dB/div: 1 dB/div  
RBW: 30 kHz  
VBW: 10 Hz  
TG Output Level: -10 dBm  
TG: ON
5. On the R3132 series, press as follows to set normalized mode to on.  
**TG** and **Execute Normalize**.

Measuring the Tracking Generator Output Level

6. On the R3132 series, set TG output level to 0 dBm and reference level to 5 dBm.
7. On the R3132 series, press **MKR** to activate marker.
8. On the R3132 series, press **SINGLE** for single sweep.
9. Record the level of marker on the performance verification record sheet.
10. Repeat 6 through 9 each TG output level and reference level listed in Table 5-28.



**Table 5-28 TG Output Level Switching Accuracy Test Setting (1)**

Center Frequency	Output Level (dBm)	Reference Level (dBm)
30 MHz	-10.0	-5.0
	0.0	5.0
	-14.9	-9.9
	-15.0	-10.0
	-19.9	-14.9
	-20.0	-15.0
	-30.0	-25.0
	-40.0	-35.0
	-50.0	-45.0

11. Repeat 2 through 9 for each center frequency listed in Table 5-29.

**Table 5-29 TG Output Level Switching Accuracy Test Setting (2) (1 of 5)**

Center Frequency	Output Level (dBm)	Reference Level (dBm)
100 kHz	-10.0	-5.0
	0.0	5.0
	-14.9	-9.9
	-15.0	-10.0
	-19.9	-14.9
	-20.0	-15.0
	-30.0	-25.0
	-40.0	-35.0
	-50.0	-45.0

5.3.3 Output Level Switching Accuracy

**Table 5-29 TG Output Level Switching Accuracy Test Setting (2) (2 of 5)**

Center Frequency	Output Level (dBm)	Reference Level (dBm)
1 MHz	-10.0	-5.0
	0.0	5.0
	-14.9	-9.9
	-15.0	-10.0
	-19.9	-14.9
	-20.0	-15.0
	-30.0	-25.0
	-40.0	-35.0
	-50.0	-45.0
10 MHz	-10.0	-5.0
	0.0	5.0
	-14.9	-9.9
	-15.0	-10.0
	-19.9	-14.9
	-20.0	-15.0
	-30.0	-25.0
	-40.0	-35.0
	-50.0	-45.0
200 MHz	-10.0	-5.0
	0.0	5.0
	-14.9	-9.9
	-15.0	-10.0
	-19.9	-14.9
	-20.0	-15.0
	-30.0	-25.0
	-40.0	-35.0
	-50.0	-45.0

Table 5-29 TG Output Level Switching Accuracy Test Setting (2) (3 of 5)

Center Frequency	Output Level (dBm)	Reference Level (dBm)
400 MHz	-10.0	-5.0
	0.0	5.0
	-14.9	-9.9
	-15.0	-10.0
	-19.9	-14.9
	-20.0	-15.0
	-30.0	-25.0
	-40.0	-35.0
	-50.0	-45.0
600 MHz	-10.0	-5.0
	0.0	5.0
	-14.9	-9.9
	-15.0	-10.0
	-19.9	-14.9
	-20.0	-15.0
	-30.0	-25.0
	-40.0	-35.0
	-50.0	-45.0
800 MHz	-10.0	-5.0
	0.0	5.0
	-14.9	-9.9
	-15.0	-10.0
	-19.9	-14.9
	-20.0	-15.0
	-30.0	-25.0
	-40.0	-35.0
	-50.0	-45.0

5.3.3 Output Level Switching Accuracy

**Table 5-29 TG Output Level Switching Accuracy Test Setting (2) (4 of 5)**

Center Frequency	Output Level (dBm)	Reference Level (dBm)
1 GHz	-10.0	-5.0
	0.0	5.0
	-14.9	-9.9
	-15.0	-10.0
	-19.9	-14.9
	-20.0	-15.0
	-30.0	-25.0
	-40.0	-35.0
	-50.0	-45.0
1.5 GHz	-10.0	-5.0
	0.0	5.0
	-14.9	-9.9
	-15.0	-10.0
	-19.9	-14.9
	-20.0	-15.0
	-30.0	-25.0
	-40.0	-35.0
	-50.0	-45.0
2 GHz	-10.0	-5.0
	0.0	5.0
	-14.9	-9.9
	-15.0	-10.0
	-19.9	-14.9
	-20.0	-15.0
	-30.0	-25.0
	-40.0	-35.0
	-50.0	-45.0

**Table 5-29 TG Output Level Switching Accuracy Test Setting (2) (5 of 5)**

Center Frequency	Output Level (dBm)	Reference Level (dBm)
2.5 GHz	-10.0	-5.0
	0.0	5.0
	-14.9	-9.9
	-15.0	-10.0
	-19.9	-14.9
	-20.0	-15.0
	-30.0	-25.0
	-40.0	-35.0
	-50.0	-45.0
3.0 GHz	-10.0	-5.0
	0.0	5.0
	-14.9	-9.9
	-15.0	-10.0
	-19.9	-14.9
	-20.0	-15.0
	-30.0	-25.0
	-40.0	-35.0
	-50.0	-45.0

5.3.4 Harmonic Distortion

**5.3.4 Harmonic Distortion**

The measurement for tracking generator harmonic spurious outputs.

The tracking generator output is connected to the input of a spectrum analyzer, then set to several different frequencies as the amplitude of the second harmonics relative to the fundamental is measured at each frequency.

Specification:

≤-20 dBc (output level -10 dBm)

Instruments Required:

Instruments	Qty.	Recommended Model
Spectrum Analyzer	1	R3267
RF Cable SMA(m)-SMA(m)	1	A01002
Minimum Loss Pad	1*	HP11852B
Adapter N(m)-SMA(f)	2	

\* R3132N Only

Procedures:

Setting the measurement conditions

1. Connect the R3132 series and spectrum analyzer as shown in Figure 5-25.

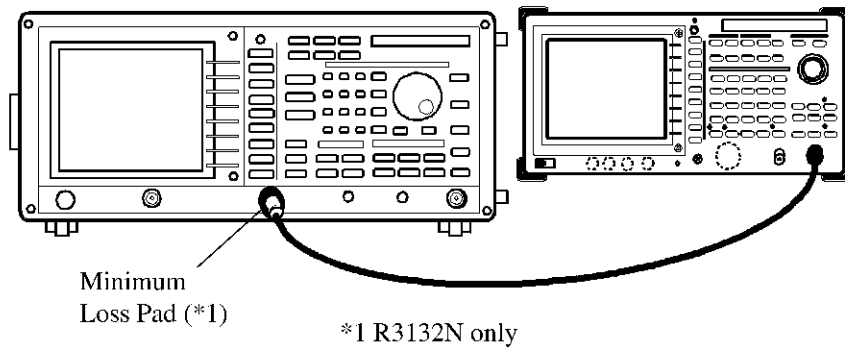

**Figure 5-25 Setup of Harmonic Distortion Test**

**CAUTION:** Use only 75 Ω cables, connectors, or adapters on R3132N, or damage to the input connector will occur.

## Measuring the Harmonic Distortion

2. On the R3132 series, after preset, set controls as follows:  
Center Frequency: 100 kHz  
Span: Zero  
RBW: 1 kHz  
TG: ON  
TG Output Level: -10 dBm
3. On the spectrum analyzer, after preset, set controls as follows:  
Center Frequency: 350 kHz  
Span: 600 kHz  
Reference level: 0 dBm
4. On the spectrum analyzer, press **SINGLE** for single sweep.
5. Measure the level difference of signal between fundamental and second harmonic signal.
6. Record measured level difference on the performance verification record sheet.
7. Repeat step 2 through 6 for each setting listed in Table 5-30.
8. Record maximum data on the performance verification record sheet as result.

5.3.4 Harmonic Distortion

**Table 5-30 Harmonic Distortion Test Setting**

For R3132 series	For spectrum analyzer	
Center Frequency	Center Frequency	Span
100 kHz	350 kHz	600 kHz
200 kHz	350 kHz	600 kHz
500 kHz	750 kHz	600 kHz
1 MHz	3.5 MHz	6 MHz
2 MHz	3.5 MHz	6 MHz
5 MHz	7.5 MHz	6 MHz
10 MHz	35 MHz	60 MHz
20 MHz	35 MHz	60 MHz
50 MHz	75 MHz	60 MHz
100 MHz	350 MHz	600 MHz
200 MHz	350 MHz	600 MHz
500 MHz	750 MHz	600 MHz
1 GHz	3.5 GHz	6 GHz
1.5 GHz	3.5 GHz	6 GHz
2 GHz	3.5 GHz	6 GHz
2.5 GHz	3.5 GHz	6 GHz
3 GHz	3.5 GHz	6 GHz



### 5.3.5 Non Harmonic Distortion

Measure the level difference between fundamental signal and distortion signal except for second harmonic using spectrum analyzer.

Specification:

$\leq -30$  dBc (output level -10 dBm)

Instruments Required:

Instruments	Qty.	Recommended Model
Spectrum Analyze	1	R3267
RF Cable SMA(m)-SMA(m)x	1	A01002
Minimum Loss Pad	1*	HP11852B
Adapter N(m)-SMA(f)	2	

\* R3132N Only

Procedures:

Setting the measurement conditions

1. Connect the R3132 series and spectrum analyzer as shown in Figure 5-26.

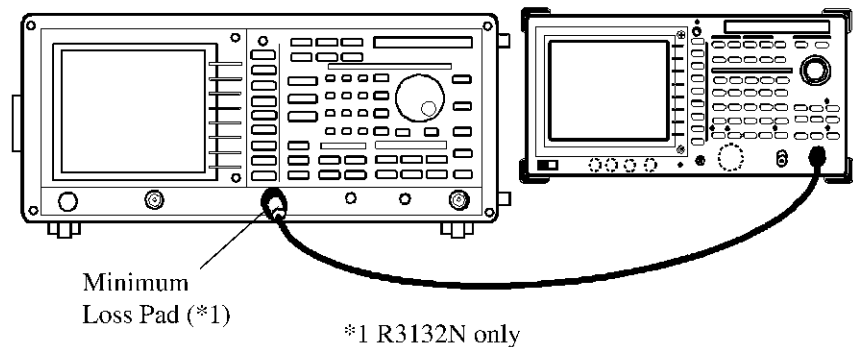

Figure 5-26 Setup of Non Harmonic Distortion Test

**CAUTION:** Use only 75  $\Omega$  cables, connectors, or adapters on R3132N, or damage to the input connector will occur.

### 5.3.5 Non Harmonic Distortion

2. On the R3132 series, after preset, set controls as follows:  
Center Frequency: 0 Hz  
Span: Zero  
RBW: 10 MHz  
TG: ON  
TG Output Level: -10 dBm
3. On the spectrum analyzer, after preset, set controls as follow:  
Stop Frequency: 6 GHz

#### Measuring the Non Harmonic Distortion

4. On the R3132 series, press  $\Delta$  key, to set center frequency by 10 MHz step up to 3 GHz.
5. Capture the biggest distortion signal except second harmonic signal.
6. Record the level difference between fundamental signal and biggest distortion signal on the performance verification record sheet.

### 5.3.6 TG Leakage

Measure the leakage of TG signal by measuring R3132 series noise level.

TG output and RF input are terminated.

Specification:

R3132/62/72

$\leq -100$  dBm (Input attenuator 0 dB)

R3132N

$\leq 7$  dB $\mu$ V (Input attenuator 0 dB)

Instruments Required:

Instruments	Qty.	Recommended Model
Terminator 50 $\Omega$ (for R3132, R3162)	1	RNA
Terminator 75 $\Omega$ (for R3132N)	1	

Procedures:

Setting the measurement conditions

1. Connect the terminators as shown in Figure 5-27.

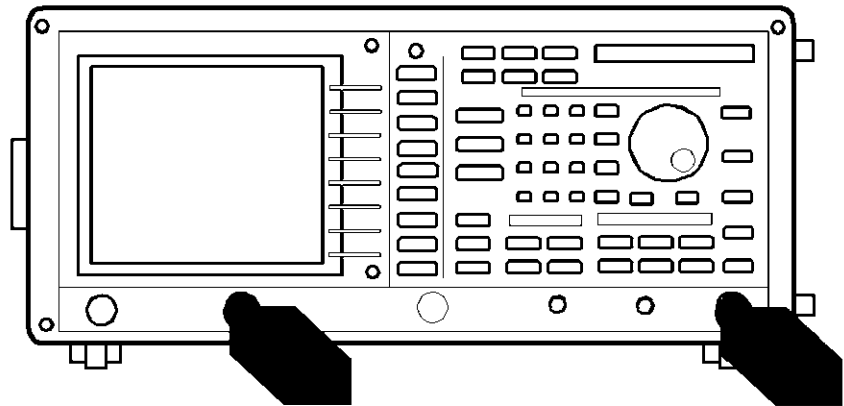

Figure 5-27 Setup of TG Leakage Test

**CAUTION:** Use only 75  $\Omega$  cables, connectors, or adapters on R3132N, or damage to the input connector will occur.

### 5.3.6 TG Leakage

2. On the R3132 series, after preset, set controls as follows:  
Start Frequency: 30 MHz  
Stop Frequency: 3.0 GHz  
Sweep Time: 20 sec  
RBW: 1 kHz  
VBW: 10 Hz  
Reference Level: -60 dBm  
TG: ON  
TG Output Level: 0 dBm  
(Ignore UNCAL message under above setting condition)

#### Measuring the TG Leakage

3. On the R3132 series, press **SINGLE** for single sweep.
4. On the R3132 series, after single sweep has completed, press **PK SRCH** for capture the peak signal.
5. Record the measurement data on the performance verification record sheet.

## 5.4 Performance Verification for OPT73 (FM Demodulation)

### 5.4.1 Offset Error (Internal Mixer Mode)

This section describes how to measure the difference between the frequency output from the frequency generator and the frequency reading on FM Demod.

In the R3132 series, the frequency is phase locked on the signal generator's 10 MHz reference signal.

Specification:

$$\leq (4\% \text{ of the screen display range} + K + \text{Frequency reading} \times \text{Frequency reference accuracy})$$

K: 8 kHz (Screen display range: 2.5 MHz to 250 kHz)

2 kHz (Screen display range: 100 kHz to 10 kHz)

Instruments Required

Instruments	Qty.	Recommended Model
Signal Generator	1	SMT02
Minimum Loss Pad	1*1	HP11852B
RF Cable BNC(m)-BNC(m)	1	MI-09
RF Cable SMA(m)-SMA(m)	1	A01002
Adapter N(m)-SMA(f)	2	
Adapter SMA(f)-SMA(f)	1*2	

\*1 R3132N Only

\*2 R3182 Only

Procedures:

Setting the measurement conditions

1. Connect the instruments as shown in Figure 5-28.

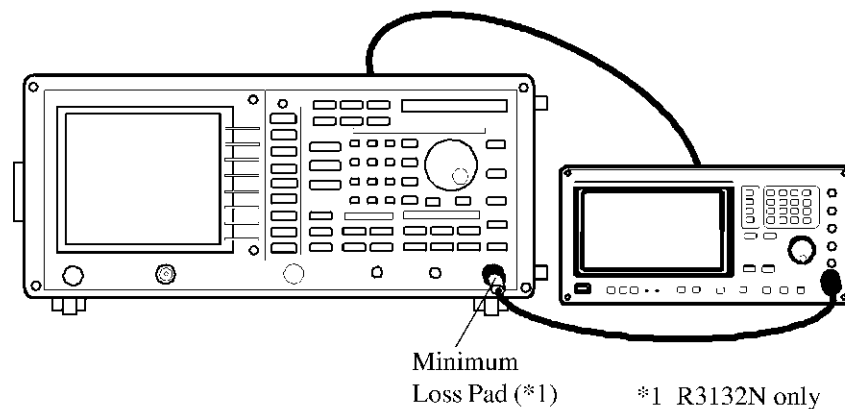

Figure 5-28 Setup for Checking the Offset Error (Internal Mixer Mode)

5.4.1 Offset Error (Internal Mixer Mode)

2. Set the signal generator as follows:  
Frequency: 30 MHz  
Output level: 0 dBm
3. Set the R3132 series as shown below after the preset:  
Center frequency: 30 MHz  
Frequency offset: -30 MHz
4. Perform an FM Demod calibration for the R3132 series as shown below:  
**UTILITY, FM Demod, Demod Cal and All.**
5. Press the **RETURN** key after the calibration finishes.
6. Set VBW used for the R3132 series to 10 Hz.
7. Press the **MKR** key to display the marker.
8. Set the frequency range as shown below.  
**UTILITY and Range.**
9. Sets the frequency range listed in the performance verification sheet.
10. Press the **SINGLE** key to read the marker frequency in absolute value, and record it on the verification sheet.
11. Repeat steps 9 through 10 for each frequency range.

### 5.4.2 Linearity Error (Internal Mixer Mode)

This section describes how to measure the linearity error: set a total of two different signal frequencies, and take the difference between the signal generator and the frequency obtained from the FM Demod function for each frequency. The linearity error is measured using the delta marker function.

In the R3132 series, the frequency is phase locked on the signal generator's 10 MHz reference signal.

Specification:

$$\leq (2\% \text{ of the screen display range})$$

Instruments Required

Instruments	Qty.	Recommended Model
Signal Generator	1	SMT02
Minimum Loss Pad	1*1	HP11852B
RF Cable BNC(m)-BNC(m)	1	MI-09
RF Cable SMA(m)-SMA(m)	1	A01002
Adapter N(m)-SMA(f)	2	
Adapter SMA(f)-SMA(f)	1*2	

\*1 R3132N Only

\*2 R3182 Only

Procedures:

1. Connect the instruments as shown in Figure 5-29.

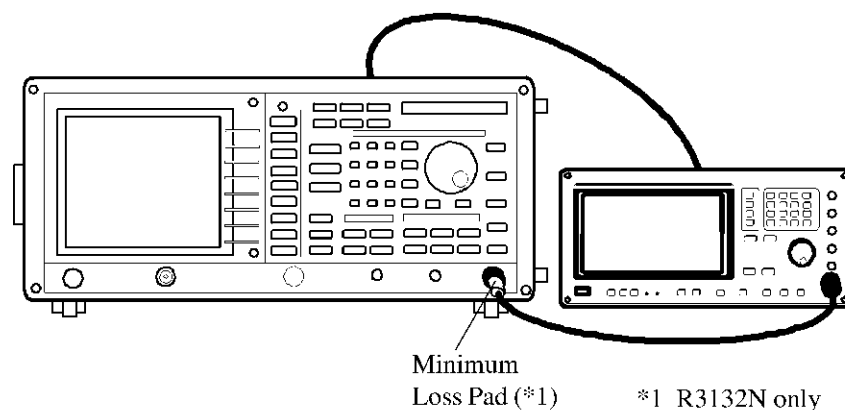

Figure 5-29 Setup for Checking the Linearity Error (Internal Mixer Mode)

2. Set the signal generator as follows:  
Output level: 0 dBm

5.4.2 Linearity Error (Internal Mixer Mode)

3. Set the R3132 series as shown below after the preset:  
Center frequency: 30 MHz
4. Perform an FM Demod calibration for the R3132 series as shown below:  
**UTILITY, FM Demod, Demod Cal** and **All**.
5. Press the **RETURN** key after the calibration finishes.
6. Set VBW used for the R3132 series to 10 Hz.
7. Set Trace B to Write as shown below.  
**TRACE, Trc Menu A/B(B)** and **Write B**.
8. Press **Trc Menu A/B(A)** to return the trace menu to A.
9. Execute the delta marker function as shown below.  
**MKR, Delta** and **MKR Trace A/B(B)**.
10. Set the frequency range as shown below.  
**UTILITY** and **Range**.
11. Sets the frequency range listed in the performance verification sheet.
12. Set the first frequency setting value of the signal generator that corresponds to the frequency range listed in Table 5-31 and set in step 11 to the signal generator.
13. Press the **TRACE** and **Write A** keys to set the trace A to Write.
14. Press the **SINGLE** key to perform the sweep only once.
15. Press the **TRACE** and **View A** keys to set the trace A to the preset mode.
16. Set the second frequency setting value of the signal generator that corresponds to the frequency range listed in Table 5-31 and set in step 11 to the signal generator.
17. Press the **SINGLE** key to perform the sweep only once, and then record the marker frequency reading on the performance verification sheet.
18. Repeat steps 10 through 17 for each frequency range.



**Table 5-31 Relationship Between the Frequency Range and Signal Generator Frequency Setting  
(Used on the R3132 Series)**

Range	Signal generator 1st Frequency	Signal generator 2nd Frequency
1 kHz/	29.996 MHz	30.004 MHz
2.5 kHz/	29.99 MHz	30.01 MHz
5 kHz/	29.98 MHz	30.02 MHz
10 kHz/	29.96 MHz	30.04 MHz
25 kHz/	29.9 MHz	30.1 MHz
50 kHz/	29.8 MHz	30.2 MHz
100 kHz/	29.6 MHz	30.4 MHz
250 kHz/	29 MHz	31 MHz

5.4.3 Offset Error (External Mixer Mode)

**5.4.3 Offset Error (External Mixer Mode)**

This section describes how to measure an offset error: measure the difference between the center frequency and the FM Demod frequency reading after the signal generator frequency has been set to the external mixer's IF frequency.

In the R3132 series, the frequency is phase locked on the signal generator's 10 MHz reference signal.

Specification:

$$\leq (4\% \text{ of the screen display range} + K + \text{Frequency reading} \times \text{Frequency reference accuracy})$$

- K: 128 kHz (Screen display range: 500 MHz to 5 MHz)
- 8 kHz (Screen display range: 2.5 MHz to 250 kHz)
- 2 kHz (Screen display range: 100 kHz to 10 kHz)

Instruments Required

Instruments	Qty.	Recommended Model
Signal Generator	1	SMT02
RF Cable BNC(m)-BNC(m)	1	MI-09
RF Cable SMA(m)-SMA(m)	1	A01002
Adapter N(m)-SMA(f)	1	

Procedures:

Setting the measurement conditions

1. Connect the instruments as shown in Figure 5-30.

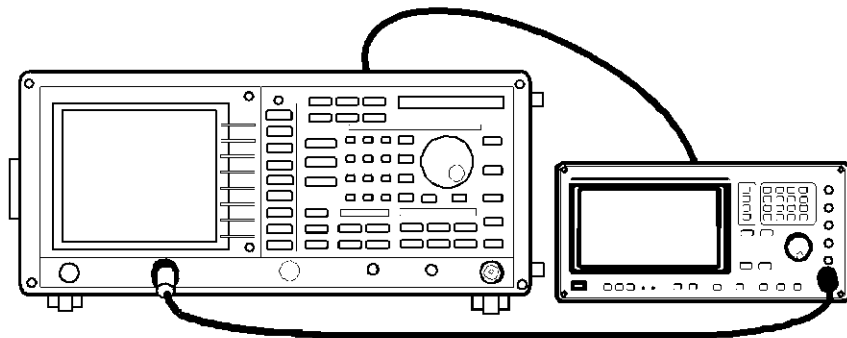

**Figure 5-30 Setup for Checking the Offset Error (External Mixer Mode)**

2. Set the signal generator as follows:
  - Frequency: 421.4 MHz
  - Output level: -50 dBm

3. Set the external mixer mode as shown below after the R3132 series has been pre-set:

**FREQ**, *1/2\_more* and *Mixer INT/EXT* (EXT).

4. Set the R3132 series as shown below:

Center frequency: 21.75 GHz

Frequency offset:- -21.75 GHz

5. Perform an FM Demod calibration for the R3132 series as shown below:

**UTILITY**, *FM Demod*, *Demod Cal* and *All*.

6. Press the **RETURN** key after the calibration finishes.

7. Set VBW used for the R3132 series to 10 Hz.

8. Press the **MKR** key to display the marker.

9. Set the frequency range as shown below.

**UTILITY** and *Range*.

10. Sets the frequency range listed in the performance verification sheet.

11. Press the **SINGLE** key to read the marker frequency in absolute value, and record it on the verification sheet.

12. Repeat steps 10 through 11 for each frequency range.

5.4.4 Linearity Error (External Mixer Mode)

**5.4.4 Linearity Error (External Mixer Mode)**

This section describes how to measure the linearity error: set a total of two different signal frequencies, and take the difference between the signal generator and the frequency obtained from the FM Demod function for each frequency. The linearity error is measured using the delta marker function.

In the R3132 series, the frequency is phase locked on the signal generator's 10 MHz reference signal.

Specification:

$$\leq (2\% \text{ of the screen display range})$$

Instruments Required

Instruments	Qty.	Recommended Model
Signal Generator	1	SMT02
RF Cable BNC(m)-BNC(m)	1	MI-09
RF Cable SMA(m)-SMA(m)	1	A01002
Adapter N(m)-SMA(f)	1	

Procedures:

1. Connect the instruments as shown in Figure 5-31.

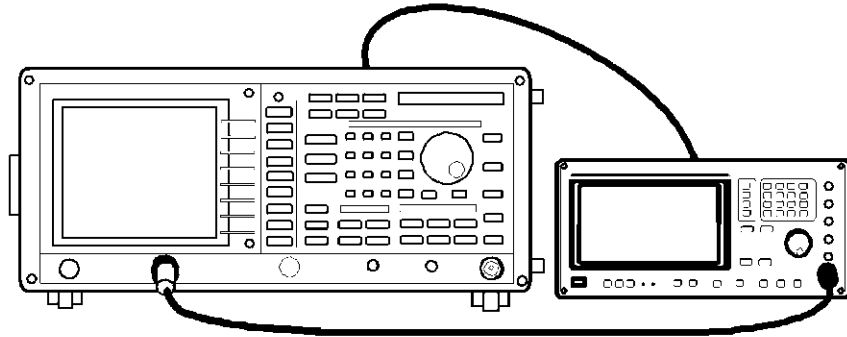

**Figure 5-31 Setup for Checking the Linearity Error (External Mixer Mode)**

2. Set the signal generator as follows:  
Output level: 50 dBm
3. Set the external mixer mode as shown below after the R3132 series has been pre-set:  
**FREQ, 1/2\_more** and **Mixer Int/Ext (Ext)**.
4. Set the R3132 series as shown below:  
Center frequency: 21.75 GHz

5. Perform an FM Demod calibration for the R3132 series as shown below:

**UTILITY, *FM Demod, Demod Cal* and *All*.**

6. Press the **RETURN** key after the calibration finishes.

7. Set VBW used for the R3132 series to 10 Hz.

8. Set Trace B to Write as shown below.

**TRACE, *Trc Menu A/B(B)* and *Write B*.**

9. Press ***Trc Menu A/B(A)*** to return the trace menu to A.

10. Execute the delta marker function as shown below.

**MKR, *Delta* and *MKR Trace A/B(B)*.**

11. Set the frequency range as shown below.

**UTILITY and *Range*.**

12. Sets the frequency range listed in the performance verification sheet.

13. Set the first frequency setting value of the signal generator that corresponds to the frequency range listed in Table 5-32 and set in step 12 to the signal generator.

14. Press the **TRACE** and ***Write A*** keys to set the trace A to Write.

15. Press the **SINGLE** key to perform the sweep only once.

16. Press the **TRACE** and ***View A*** keys to set the trace A to the preset mode.

17. Set the second frequency setting value of the signal generator that corresponds to the frequency range listed in Table 5-32 and set in step 12 to the signal generator.

18. Press the **SINGLE** key to perform the sweep only once, and then record the marker frequency reading on the performance verification sheet.

19. Repeat steps 11 through 18 for each frequency range.

**Table 5-32 Relationship Between the Frequency Range and Signal Generator Frequency Setting  
(Used on the R3132 Series)**

Range	Signal generator 1st Frequency	Signal generator 2nd Frequency
1 kHz/	421.396 MHz	421.404 MHz
2.5 kHz/	421.39 MHz	421.41 MHz
5 kHz/	421.38 MHz	421.42 MHz
10 kHz/	421.36 MHz	421.44 MHz
25 kHz/	421.3 MHz	421.5 MHz
50 kHz/	421.2 MHz	421.6 MHz
100 kHz/	421 MHz	421.8 MHz
250 kHz/	420.4 MHz	422.4 MHz
500 kHz/	423.4 MHz	419.4 MHz
1 MHz/	425.4 MHz	417.4 MHz
2.5 MHz/	431.4 MHz	411.4 MHz
5 MHz/	441.4 MHz	401.4 MHz
10 MHz/	461.4 MHz	381.4 MHz
25 MHz/	521.4 MHz	321.4 MHz
50 MHz/	621.4 MHz	221.4 MHz

**5.5 Performance Verification Record Sheet**

***Performance Verification Record Sheet***

Report Number:			
Customer Name:	_____		
Address:	_____ _____ _____		
Description:	_____ _____		
Model Number:	_____		
Serial Number:	_____		
Asset Number:	_____		
Testing Environment:	±	°C/	% ± % RH
Verification Date:	_____		
Due Date:	_____		
<b>Equipment Used:</b>			
Model No.	Description	Trace No.	Cal Due Date
Test Officer		Head of Laboratory	
Date:		Date:	

5.5 Performance Verification Record Sheet

(1) Frequency Reference Output Accuracy

Test Data	Specification			Result
	Min. (Hz)	Measured Value	Max. (Hz)	Pass/Fail
30 MHz	29.99994		30.00006	
30 MHz (OPT20)	29.999997		30.000003	

(2) Calibration Signal Amplitude Accuracy

Test Data	Specification			Result
	Min. (Hz)	Measured Value	Max. (Hz)	Pass/Fail
-20 dBm	-20.3		-19.7	

(3) Displayed Average Noise Level

Test Data	Center Frequency (MHz)	Specification			Result
		Min. (dBm)	Measured Value (dBm)	Max. (dBm)	Pass/Fail
OFF	10.1	N/A		-117.0	
	101	N/A		-116.8	
	501	N/A		-116.0	
	1001	N/A		-115.0	
	1501	N/A		-114.0	
	2001	N/A		-113.0	
	2999	N/A		-111.0	
ON	1	N/A		-132.0	
	10.1	N/A		-132.0	
	101	N/A		-131.7	
	501	N/A		-130.5	
	1001	N/A		-129.0	
	1501	N/A		-127.5	
	2001	N/A		-126.0	
2999	N/A		-123.0		



- For the R3132N

Test Data	Center Frequency (MHz)	Specification			Result
Preamplifier		Min. (dB $\mu$ V)	Measured Value (dB $\mu$ V)	Max. (dB $\mu$ V)	Pass/Fail
OFF	10.1	N/A		-6.0	
	101	N/A		-5.8	
	501	N/A		-5.0	
	1001	N/A		-4.0	
	1501	N/A		-3.0	
	2001	N/A		-2.0	
	2999	N/A		-1.0	
ON	1	N/A		-21.0	
	10.1	N/A		-21.0	
	101	N/A		-20.7	
	501	N/A		-19.5	
	1001	N/A		-18.0	
	1501	N/A		-16.5	
	2001	N/A		-15.0	
	2999	N/A		-12.0	

- For the R3162 only

Test Data	Center Frequency (MHz)	Specification			Result
Preamplifier		Min. (dBm)	Measured Value (dBm)	Max. (dBm)	Pass/Fail
OFF	4000	N/A		-113.0	
	5000	N/A		-112.5	
	6000	N/A		-112.0	
	7000	N/A		-111.5	
	8000	N/A		-111.0	

5.5 Performance Verification Record Sheet

- For the R3172 only

Test Data		Specification			Result
Preamplifier	Frequency Band	Min. (dBm)	Measured Value (dBm)	Max. (dBm)	Pass/Fail
OFF	3.2 GHz to 7.1 GHz	N/A		-112.0	
	7 GHz to 14.7 GHz	N/A		-111.0	
	14.5 GHz to 22 GHz	N/A		-107.0	
	22 GHz to 26.5 GHz	N/A		-104.0	

- For the R3182 only

Test Data		Specification			Result
Preamplifier	Frequency Band	Min. (dBm)	Measured Value (dBm)	Max. (dBm)	Pass/Fail
OFF	3.2 GHz to 7.1 GHz	N/A		-114.0	
	7 GHz to 14.7 GHz	N/A		-112.0	
	14.5 GHz to 27 GHz	N/A		-110.0	
	26.5 GHz to 30 GHz	N/A		-107.0	
	29.5 GHz to 40 GHz	N/A		-106.0	

(4) Resolution Bandwidth Switching Uncertainty

Test Data		Specification			Result
RBW (Hz)	Span Setting (Hz)	Min. (dB)	Measured Value (dBm)	Max. (dB)	Pass/Fail
300 k	1 M	Ref.	0 (Ref.)	Ref.	
3 M	5 M	-0.5		+0.5	
1 M	2 M	-0.5		+0.5	
100 k	200 k	-0.5		+0.5	
30 k	50 k	-0.5		+0.5	
10 k	20 k	-0.5		+0.5	
3 k	5 k	-0.5		+0.5	
1 k	2 k	-0.5		+0.5	

## (5) Resolution Bandwidth Accuracy and Selectivity

## • Resolution Bandwidth Accuracy

Test Data		Specification			Result
RBW (Hz)	Span Setting (Hz)	Min. (Hz)	Measured Value (Hz)	Max. (Hz)	Pass/Fail
3 M	5 M	2.25 M		3.75 M	
1 M	2 M	0.8 M		1.2 M	
300 k	500 k	240 k		360 k	
100 k	200 k	80 k		120 k	
30 k	50 k	24 k		36 k	
10 k	20 k	8 k		12 k	
3 k	5 k	2.4 k		3.6 k	
1 k	2 k	0.8 k		1.2 k	
300 (OPT27)	1 k	240		360	
100 (OPT27)	1 k	80		120	
30 (OPT27)	1 k	24		36	

## • Resolution Bandwidth Selectivity

Test Data		Measured Value (Hz)		Specification			Result
RBW (Hz)	Span Setting (Hz)	60 dB	3 dB	Min.	Actual	Max.	Pass/Fail
3 M	25 M			N/A		15	
1 M	20 M			N/A		15	
300 k	5 M			N/A		15	
100 k	2 M			N/A		15	
30 k	500 k			N/A		15	
10 k	200 k			N/A		15	
3 k	50 k			N/A		15	
1 k	20 k			N/A		15	

5.5 Performance Verification Record Sheet

(6) QP Bandwidth Accuracy

Test Data		Specification			Result
RBW (Hz)	Span Setting (Hz)	Min. (Hz)	Measured Value (Hz)	Max. (Hz)	Pass/Fail
1 M	2 M	0.8 M		1.2 M	
120 k	200 k	96 k		144 k	
9 k	20 k	8.2 k		10.8 k	
200 (OPT27)	1 k	160		240	

(7) IF Gain Uncertainty

- RBW = 3 MHz

Setting	Test Data	Specification			Result
RBW (Hz)	Reference Level (dBm)	Min (dB)	Measured Value (dB)	Max. (dB)	Pass/Fail
3 M	-1.0	-0.5		+0.5	
	-2.0	-0.5		+0.5	
	-3.0	-0.5		+0.5	
	-4.0	-0.5		+0.5	
	-5.0	-0.5		+0.5	
	-6.0	-0.5		+0.5	
	-7.0	-0.5		+0.5	
	-8.0	-0.5		+0.5	
	-9.0	-0.5		+0.5	
	-10.0	-0.5		+0.5	
	-20.0	-0.5		+0.5	
	-30.0	-0.5		+0.5	
	-40.0	-0.5		+0.5	
-50.0	-0.5		+0.5		

- RBW = 300 kHz

Setting	Test Data	Specification			Result
RBW (Hz)	Reference Level (dBm)	Min (dB)	Measured Value (dB)	Max. (dB)	Pass/Fail
300 k	-1.0	-0.5		+0.5	
	-2.0	-0.5		+0.5	
	-3.0	-0.5		+0.5	
	-4.0	-0.5		+0.5	
	-5.0	-0.5		+0.5	
	-6.0	-0.5		+0.5	
	-7.0	-0.5		+0.5	
	-8.0	-0.5		+0.5	
	-9.0	-0.5		+0.5	
	-10.0	-0.5		+0.5	
	-20.0	-0.5		+0.5	
	-30.0	-0.5		+0.5	
	-40.0	-0.5		+0.5	
-50.0	-0.5		+0.5		

- RBW = 1 kHz

Setting	Test Data	Specification			Result
RBW (Hz)	Reference Level (dBm)	Min (dB)	Measured Value (dB)	Max. (dB)	Pass/Fail
1 k	-1.0	-0.5		+0.5	
	-2.0	-0.5		+0.5	
	-3.0	-0.5		+0.5	
	-4.0	-0.5		+0.5	
	-5.0	-0.5		+0.5	
	-6.0	-0.5		+0.5	
	-7.0	-0.5		+0.5	
	-8.0	-0.5		+0.5	
	-9.0	-0.5		+0.5	
	-10.0	-0.5		+0.5	
	-20.0	-0.5		+0.5	
	-30.0	-0.5		+0.5	
	-40.0	-0.5		+0.5	
-50.0	-0.5		+0.5		

5.5 Performance Verification Record Sheet

(8) Input Attenuator Switching Accuracy

- For the R3132

R3132 Setting		Specification				Result
Attenuator (dB)	Reference Level (dBm)	Measured Value (dBm)	Min (dB)	Actual Value (dB)	Max (dB)	Pass/Fail
0	-40		-0.3		+0.3	
10	-30		-	0 (Ref)	-	
20	-20		-0.3		+0.3	
30	-10		-0.3		+0.3	
40	0		-0.3		+0.3	
50	+10		-0.3		+0.3	

- For the R3132N

R3132N Setting		Specification				Result
Attenuator (dB)	Reference Level (dBm)	Measured Value (dBm)	Min (dB)	Actual Value (dB)	Max (dB)	Pass/Fail
0	-40		-0.3		+0.3	
10	-30		-	0 (Ref)	-	
20	-20		-0.3		+0.3	
30	-10		-0.3		+0.3	
40	0		-0.3		+0.3	
50	+10		-0.3		+0.3	

- For the R3162

R3162 Setting		Specification				Result
Attenuator (dB)	Reference Level (dBm)	Measured Value (dBm)	Min. (dB)	Actual Value (dB)	Max. (dB)	Pass/Fail
0	-40		-0.3		+0.3	
5	-35		-0.3		+0.3	
10	-30		-	0 (Ref)	-	
15	-25		-0.3		+0.3	
20	-20		-0.3		+0.3	
25	-15		-0.3		+0.3	
30	-10		-0.3		+0.3	
35	-5		-0.3		+0.3	
40	0		-0.3		+0.3	
45	+5		-0.3		+0.3	
50	+10		-0.3		+0.3	

- For the R3172/82  
Measurement a center frequency of 4 GHz

R3172/82 Setting		Specification				Result
		Switching Accuracy		Step to Step Accuracy		
Attenuator (dB)	Reference Level (dBm)	Spec. (dB)	Actual Value (dB)	Spec. (dB)	Actual Value (dB)	Pass/Fail
10	-50	0 (Ref)		0 (Ref)	0	
20	-40	±2		±1.1		
30	-30	±2		±1.1		
40	-20	±2		±1.1		
50	-10	±2		±1.1		
60	0	±2		±1.1		
70	+10	±2		±1.1		

5.5 Performance Verification Record Sheet

- For the R3172/82  
Measurement a center frequency of 15 GHz

R3172/82 Setting		Specification				Result
		Switching Accuracy		Step to Step Accuracy		
Attenuator (dB)	Reference Level (dBm)	Spec. (dB)	Actual Value (dB)	Spec. (dB)	Actual Value (dB)	Pass/Fail
10	-50	0 (Ref)		0 (Ref)	0	
20	-40	±2.5		±1.3		
30	-30	±2.5		±1.3		
40	-20	±2.5		±1.3		
50	-10	±2.5		±1.3		
60	0	±2.5		±1.3		
70	+10	±2.5		±1.3		

- For the R3172/82  
Measurement a center frequency of 18 GHz

R3172/82 Setting		Specification				Result
		Switching Accuracy		Step to Step Accuracy		
Attenuator (dB)	Reference Level (dBm)	Spec. (dB)	Actual Value (dB)	Spec. (dB)	Actual Value (dB)	Pass/Fail
10	-50	0 (Ref)		0 (Ref)	0	
20	-40	±3.5		±1.8		
30	-30	±3.5		±1.8		
40	-20	±3.5		±1.8		
50	-10	±3.5		±1.8		
60	0	±3.5		±1.8		
70	+10	±3.5		±1.8		



## (9) Scale Fidelity

- 1 dB/div Scale Fidelity

Setting	Specification			Incremental Error			Result
				Specification			
dB from Reference level (dB)	Min. (dB)	Measured Value (dB)	Max. (dB)	Min. (dB)	Measured Value (dB)	Max. (dB)	Pass/Fail
0	-	0 (Ref)	-	-	0 (Ref)	-	
-1	-1.2		-0.8	-0.2		+0.2	
-2	-2.4		-1.6	-0.2		+0.2	
-3	-3.6		-2.4	-0.2		+0.2	
-4	-4.8		-3.2	-0.2		+0.2	
-5	-6.0		-4.0	-0.2		+0.2	
-6	-7.0		-5.0	-0.2		+0.2	
-7	-8.0		-6.0	-0.2		+0.2	
-8	-9.0		-7.0	-0.2		+0.2	
-9	-10.0		-8.0	-0.2		+0.2	
-10	-11.0		-9.0	-0.2		+0.2	

- 10 dB/div Scale Fidelity

Setting	Specification			Incremental Error			Result
				Specification			
dB from Reference level (dB)	Min. (dB)	Measured Value (dB)	Max. (dB)	Min. (dB)	Measured Value (dB)	Max. (dB)	Pass/Fail
0	-	0 (Ref)	-	-	0 (Ref)	-	
-10	-11.0		-9.0	-1.0		+1.0	
-20	-21.5		-18.5	-1.0		+1.0	
-30	-31.5		-28.5	-1.0		+1.0	
-40	-41.5		-38.5	-1.0		+1.0	
-50	-51.5		-48.5	-1.0		+1.0	
-60	-61.5		-58.5	-1.0		+1.0	
-70	-71.5		-68.5	-1.0		+1.0	
-80	-81.5		-78.5	-1.0		+1.0	
-90	-91.5		-88.5	-1.0		+1.0	

5.5 Performance Verification Record Sheet

- Linear Scale Fidelity

Signal Level (Nominal)		Specification			Result
div. from Reference Level	(dB)	Min. (mV)	Measured Value (mV)	Max. (mV)	Pass/Fail
0	0	-		-	
1	-0.92	190.06		212.42	
2	-1.94	167.70		190.06	
3	-3.10	145.34		167.70	
4	-4.44	122.98		145.34	
5	-6.02	100.62		122.98	
6	-7.96	78.26		100.62	
7	-10.46	55.90		78.26	
8	-13.98	33.54		55.90	
9	-20.00	11.18		33.54	

(10) Residual FM

Measured Value			Specification			Result
Marker Reading	3 dB Slope	FM Deviation	Min (Hz)	Calculated Value (Hz)	Max (Hz)	Pass/Fail
$\Delta f$	$\Delta$ level		N/A		60	

(11) Noise Sideband

Center Frequency (Hz)	Span (Hz)	Offset Frequency (Hz)	Specification			Result
			Min (dBc/Hz)	Measured Value (dBc/Hz)	Max (dBc/Hz)	Pass/Fail
1.0 G	50 k	20 k	N/A		-105	

## (12) Image, Multiple, and Out of Band Response

Center Frequency (GHz)	Frequency of Signal Generator (GHz)	Specification			Result
		Min. (dB)	Measured Value (dB)	Max. (dB)	Pass/Fail
2	1.9572	N/A		-70	
2	1.1572	N/A		-70	
2	10.5228	N/A		-70	
2	8.2614	N/A		-70	
Apply for R3162					
5.5	6.3428	N/A		-70	
8	7.1572	N/A		-70	
8	3.7893	N/A		-70	
Apply for R3172					
5.5	6.3428	N/A		-70	
5.5	11.4214	N/A		-70	
5.5	17.3428	N/A		-70	
5.5	23.2642	N/A		-50	
12	12.8428	N/A		-70	
12	5.7893	N/A		-70	
12	18.2107	N/A		-60	
12	24.4214	N/A		-50	
21	21.8428	N/A		-60	
21	6.71907	N/A		-70	
21	13.8595	N/A		-70	
24.4	25.2428	N/A		-50	
24.4	5.78395	N/A		-70	
24.4	11.9893	N/A		-70	
24.4	18.19465	N/A		-60	
Apply for R3182					
5.5	6.3428	N/A		-70	
5.5	11.4214	N/A		-70	
5.5	17.3428	N/A		-70	
5.5	23.2642	N/A		-65	
12	12.8428	N/A		-70	
12	5.7893	N/A		-70	
12	18.2107	N/A		-65	
12	24.4214	N/A		-65	
21	21.8428	N/A		-65	

5.5 Performance Verification Record Sheet

Center Frequency (GHz)	Frequency of Signal Generator (GHz)	Specification			Result
		Min. (dB)	Measured Value (dB)	Max. (dB)	Pass/Fail
21	6.71907	N/A		-70	
21	13.8595	N/A		-70	
24.4	25.2428	N/A		-65	
24.4	5.78395	N/A		-70	
24.4	11.9893	N/A		-70	
24.4	18.19465	N/A		-65	
28	28.8428	N/A		-60	
28	6.89465	N/A		-70	
28	13.7893	N/A		-70	
28	20.89465	N/A		-65	
35	35.8428	N/A		-50	
35	6.91572	N/A		-70	
35	11.5262	N/A		-70	
35	23.19287	N/A		-65	

## (13) Frequency Readout Accuracy and Frequency Counter Accuracy

## • Frequency Readout Accuracy

Center Frequency (GHz)	Frequency Span (MHz)	Specification			Result
		Min. (GHz)	Measured Value (GHz)	Max. (GHz)	Pass/Fail
2	1	1.999985		2.000015	
2	10	1.99989		2.00011	
2	20	1.99976		2.00024	
2	100	1.9989		2.0011	
2	1000	1.990		2.010	
Apply for R3162/72/82					
5	1	4.999979		5.000021	
5	10	4.99988		5.00012	
5	20	4.99975		5.00025	
5	100	4.9989		5.0011	
5	1000	4.990		5.010	
Apply for R3172/82					
11	1	10.999977		11.000033	
11	10	10.99987		11.00013	
11	20	10.99974		11.00026	
11	100	10.9989		11.0011	
11	1000	10.990		11.010	
18	1	17.999953		18.000047	
18	10	17.99985		18.00015	
18	20	17.99972		18.00028	
18	100	17.9989		18.0011	
18	1000	17.990		18.010	
Apply for R3182					
35	1	34.999919		35.000081	
35	10	34.99982		35.00018	
35	20	34.99969		35.0003	
35	100	34.9988		35.0012	
35	1000	34.990		35.010	

5.5 Performance Verification Record Sheet

- Frequency Counter Accuracy

Center Frequency (GHz)	Frequency Span (MHz)	Specification			Result
		Min. (GHz)	Measured Value (GHz)	Max. (GHz)	Pass/Fail
2	1	1.999995999		2.000004001	
Apply for R3162/72/82					
5	1	4.999989999		5.000010001	
Apply for R3172/82					
11	1	10.999977999		11.000022001	
18	1	17.999963999		18.000036001	
Apply for R3182					
35	1	34.999929999		35.000070001	

(14) Second Harmonic Distortion

Test Data		Specification			Result
Fundamental Frequency (GHz)	Second Harmonic Frequency (GHz)	Min. (dBc)	Measured Value (dBc)	Max. (dBc)	Pass/Fail
1.5	3.0	N/A		-80	
1.9	3.8	N/A		-80	

## (15) Frequency Response

- Frequency Range 9 kHz to 3.3 GHz

Preamplifier	Test Data (MHz)	Specification *1			Result
		Min. (dB)	Measured Value (dB)	Max. (dB)	Pass/Fail
OFF	100	-0.5		+0.5	
	200	-0.5		+0.5	
	300	-0.5		+0.5	
	400	-0.5		+0.5	
	500	-0.5		+0.5	
	600	-0.5		+0.5	
	700	-0.5		+0.5	
	800	-0.5		+0.5	
	900	-0.5		+0.5	
	1000	-0.5		+0.5	
	1100	-0.5		+0.5	
	1200	-0.5		+0.5	
	1300	-0.5		+0.5	
	1400	-0.5		+0.5	
	1500	-0.5		+0.5	
	1600	-0.5		+0.5	
	1700	-0.5		+0.5	
	1800	-0.5		+0.5	
	1900	-0.5		+0.5	
	2000	-0.5		+0.5	
	2100	-0.5		+0.5	
	2200	-0.5		+0.5	
	2300	-0.5		+0.5	
	2400	-0.5		+0.5	
	2500	-0.5		+0.5	
	2600	-0.5		+0.5	
	2700	-0.5		+0.5	
	2800	-0.5		+0.5	
	2900	-0.5		+0.5	
	3000	-0.5		+0.5	
	3100	-2.0		+2.0	
	3200	-2.0		+2.0	

\*1 On the R3172/82, specification is  $\pm 0.6$  dB (100 kHz - 3.0 GHz) or  $\pm 1.5$  dB (9 kHz - 3.3 GHz).

5.5 Performance Verification Record Sheet

- Frequency Range 9 kHz to 3.3 GHz (Hi-sense)

Preamplifier	Test Data (MHz)	Specification			Result
		Min. (dB)	Measured Value (dB)	Max. (dB)	Pass/Fail
ON	100	-1.0		+1.0	
	200	-1.0		+1.0	
	300	-1.0		+1.0	
	400	-1.0		+1.0	
	500	-1.0		+1.0	
	600	-1.0		+1.0	
	700	-1.0		+1.0	
	800	-1.0		+1.0	
	900	-1.0		+1.0	
	1000	-1.0		+1.0	
	1100	-1.0		+1.0	
	1200	-1.0		+1.0	
	1300	-1.0		+1.0	
	1400	-1.0		+1.0	
	1500	-1.0		+1.0	
	1600	-1.0		+1.0	
	1700	-1.0		+1.0	
	1800	-1.0		+1.0	
	1900	-1.0		+1.0	
	2000	-1.0		+1.0	
	2100	-1.0		+1.0	
	2200	-1.0		+1.0	
	2300	-1.0		+1.0	
	2400	-1.0		+1.0	
	2500	-1.0		+1.0	
	2600	-1.0		+1.0	
	2700	-1.0		+1.0	
	2800	-2.0		+2.0	
	2900	-2.0		+2.0	
	3000	-2.0		+2.0	
	3100	-2.0		+2.0	
	3200	-2.0		+2.0	



- Frequency Range 3.2 GHz to 8 GHz for R3162

Preamplifier	Test Data (MHz)	Specification			Result
		Min. (dB)	Measured Value (dB)	Max. (dB)	Pass/Fail
OFF	3400	-2.0		+2.0	
	3500	-2.0		+2.0	
	3600	-2.0		+2.0	
	3700	-2.0		+2.0	
	3800	-2.0		+2.0	
	3900	-2.0		+2.0	
	4000	-2.0		+2.0	
	4100	-2.0		+2.0	
	4200	-2.0		+2.0	
	4300	-2.0		+2.0	
	4400	-2.0		+2.0	
	4500	-2.0		+2.0	
	4600	-2.0		+2.0	
	4700	-2.0		+2.0	
	4800	-2.0		+2.0	
	4900	-2.0		+2.0	
	5000	-2.0		+2.0	
	5100	-2.0		+2.0	
	5200	-2.0		+2.0	
	5300	-2.0		+2.0	
	5400	-2.0		+2.0	
	5500	-2.0		+2.0	
	5600	-2.0		+2.0	
	5700	-2.0		+2.0	
	5800	-2.0		+2.0	
	5900	-2.0		+2.0	
	6000	-2.0		+2.0	
	6100	-2.0		+2.0	
	6200	-2.0		+2.0	
	6300	-2.0		+2.0	
6400	-2.0		+2.0		
6500	-2.0		+2.0		
6600	-2.0		+2.0		
6700	-2.0		+2.0		

5.5 Performance Verification Record Sheet

Preamplifier	Test Data (MHz)	Specification			Result
		Min. (dB)	Measured Value (dB)	Max. (dB)	Pass/Fail
OFF	6800	-2.0		+2.0	
	6900	-2.0		+2.0	
	7000	-2.0		+2.0	
	7100	-2.0		+2.0	
	7200	-2.0		+2.0	
	7300	-2.0		+2.0	
	7400	-2.0		+2.0	
	7500	-2.0		+2.0	
	7600	-2.0		+2.0	
	7700	-2.0		+2.0	
	7800	-2.0		+2.0	
	7900	-2.0		+2.0	
	8000	-2.0		+2.0	

- Frequency Range 3.3 GHz to 7.1 GHz for R3172/82

Preamplifier	Test Data (MHz)	Specification			Result
		Min. (dB)	Measured Value (dB)	Max. (dB)	Pass/Fail
OFF	3400	-1.8		+1.8	
	3500	-1.8		+1.8	
	3600	-1.8		+1.8	
	3700	-1.8		+1.8	
	3800	-1.8		+1.8	
	3900	-1.8		+1.8	
	4000	-1.8		+1.8	
	4100	-1.8		+1.8	
	4200	-1.8		+1.8	
	4300	-1.8		+1.8	
	4400	-1.8		+1.8	
	4500	-1.8		+1.8	
	4600	-1.8		+1.8	
	4700	-1.8		+1.8	
	4800	-1.8		+1.8	
	4900	-1.8		+1.8	
	5000	-1.8		+1.8	

Preamplifier	Test Data (MHz)	Specification			Result
		Min. (dB)	Measured Value (dB)	Max. (dB)	Pass/Fail
OFF	5100	-1.8		+1.8	
	5200	-1.8		+1.8	
	5300	-1.8		+1.8	
	5400	-1.8		+1.8	
	5500	-1.8		+1.8	
	5600	-1.8		+1.8	
	5700	-1.8		+1.8	
	5800	-1.8		+1.8	
	5900	-1.8		+1.8	
	6000	-1.8		+1.8	
	6100	-1.8		+1.8	
	6200	-1.8		+1.8	
	6300	-1.8		+1.8	
	6400	-1.8		+1.8	
	6500	-1.8		+1.8	
	6600	-1.8		+1.8	
	6700	-1.8		+1.8	
	6800	-1.8		+1.8	
6900	-1.8		+1.8		
7000	-1.8		+1.8		

5.5 Performance Verification Record Sheet

- Frequency Range 7.1 GHz to 14.7 GHz for R3172/82

Preamplifier	Test Data (MHz)	Specification			Result
		Min. (dB)	Measured Value (dB)	Max. (dB)	Pass/Fail
OFF	7200	-2.0		+2.0	
	7400	-2.0		+2.0	
	7600	-2.0		+2.0	
	7800	-2.0		+2.0	
	8000	-2.0		+2.0	
	8200	-2.0		+2.0	
	8400	-2.0		+2.0	
	8600	-2.0		+2.0	
	8800	-2.0		+2.0	
	9000	-2.0		+2.0	
	9200	-2.0		+2.0	
	9400	-2.0		+2.0	
	9600	-2.0		+2.0	
	9800	-2.0		+2.0	
	10000	-2.0		+2.0	
	10200	-2.0		+2.0	
	10400	-2.0		+2.0	
	10600	-2.0		+2.0	
	10800	-2.0		+2.0	
	11000	-2.0		+2.0	
	11200	-2.0		+2.0	
	11400	-2.0		+2.0	
	11600	-2.0		+2.0	
	11800	-2.0		+2.0	
	12000	-2.0		+2.0	
	12200	-2.0		+2.0	
	12400	-2.0		+2.0	
	12600	-2.0		+2.0	
12800	-2.0		+2.0		
13000	-2.0		+2.0		
13200	-2.0		+2.0		
13400	-2.0		+2.0		
13600	-2.0		+2.0		
13800	-2.0		+2.0		

Preamplifier	Test Data (MHz)	Specification			Result
		Min. (dB)	Measured Value (dB)	Max. (dB)	Pass/Fail
OFF	14000	-2.0		+2.0	
	14200	-2.0		+2.0	
	14400	-2.0		+2.0	
	14600	-2.0		+2.0	

- Frequency Range 14.7 GHz to 26.5 GHz for R3172

Preamplifier	Test Data (MHz)	Specification			Result
		Min. (dB)	Measured Value (dB)	Max. (dB)	Pass/Fail
OFF	14800	-3.0		+3.0	
	15000	-3.0		+3.0	
	15200	-3.0		+3.0	
	15400	-3.0		+3.0	
	15600	-3.0		+3.0	
	15800	-3.0		+3.0	
	16000	-3.0		+3.0	
	16200	-3.0		+3.0	
	16400	-3.0		+3.0	
	16600	-3.0		+3.0	
	16800	-3.0		+3.0	
	17000	-3.0		+3.0	
	17200	-3.0		+3.0	
	17400	-3.0		+3.0	
	17600	-3.0		+3.0	
	17800	-3.0		+3.0	
	18000	-3.0		+3.0	
	18200	-3.0		+3.0	
	18400	-3.0		+3.0	
	18600	-3.0		+3.0	
18800	-3.0		+3.0		
19000	-3.0		+3.0		
19200	-3.0		+3.0		
19400	-3.0		+3.0		
19600	-3.0		+3.0		
19800	-3.0		+3.0		

5.5 Performance Verification Record Sheet

Preamplifier	Test Data (MHz)	Specification			Result
		Min. (dB)	Measured Value (dB)	Max. (dB)	Pass/Fail
OFF	20000	-3.0		+3.0	
	20200	-3.0		+3.0	
	20400	-3.0		+3.0	
	20600	-3.0		+3.0	
	20800	-3.0		+3.0	
	21000	-3.0		+3.0	
	21200	-3.0		+3.0	
	21400	-3.0		+3.0	
	21600	-3.0		+3.0	
	21800	-3.0		+3.0	
	22000	-3.0		+3.0	
	22200	-3.0		+3.0	
	22400	-3.0		+3.0	
	22600	-3.0		+3.0	
	22800	-3.0		+3.0	
	23000	-3.0		+3.0	
	23200	-3.0		+3.0	
	23400	-3.0		+3.0	
	23600	-3.0		+3.0	
	23800	-3.0		+3.0	
	24000	-3.0		+3.0	
	24200	-3.0		+3.0	
	24400	-3.0		+3.0	
	24600	-3.0		+3.0	
	24800	-3.0		+3.0	
	25000	-3.0		+3.0	
	25200	-3.0		+3.0	
	25400	-3.0		+3.0	
25600	-3.0		+3.0		
25800	-3.0		+3.0		
26000	-3.0		+3.0		
26200	-3.0		+3.0		
26400	-3.0		+3.0		

- Frequency Range 14.7 GHz to 27 GHz for R3182

Preamplifier	Test Data (MHz)	Specification			Result
		Min. (dB)	Measured Value (dB)	Max. (dB)	Pass/Fail
OFF	14800	-3.0		+3.0	
	15000	-3.0		+3.0	
	15200	-3.0		+3.0	
	15400	-3.0		+3.0	
	15600	-3.0		+3.0	
	15800	-3.0		+3.0	
	16000	-3.0		+3.0	
	16200	-3.0		+3.0	
	16400	-3.0		+3.0	
	16600	-3.0		+3.0	
	16800	-3.0		+3.0	
	17000	-3.0		+3.0	
	17200	-3.0		+3.0	
	17400	-3.0		+3.0	
	17600	-3.0		+3.0	
	17800	-3.0		+3.0	
	18000	-3.0		+3.0	
	18200	-3.0		+3.0	
	18400	-3.0		+3.0	
	18600	-3.0		+3.0	
	18800	-3.0		+3.0	
	19000	-3.0		+3.0	
	19200	-3.0		+3.0	
	19400	-3.0		+3.0	
	19600	-3.0		+3.0	
	19800	-3.0		+3.0	
	20000	-3.0		+3.0	
	20200	-3.0		+3.0	
20400	-3.0		+3.0		
20600	-3.0		+3.0		
20800	-3.0		+3.0		
21000	-3.0		+3.0		
21200	-3.0		+3.0		
21400	-3.0		+3.0		

5.5 Performance Verification Record Sheet

Preamplifier	Test Data (MHz)	Specification			Result
		Min. (dB)	Measured Value (dB)	Max. (dB)	Pass/Fail
OFF	21600	-3.0		+3.0	
	21800	-3.0		+3.0	
	22000	-3.0		+3.0	
	22200	-3.0		+3.0	
	22400	-3.0		+3.0	
	22600	-3.0		+3.0	
	22800	-3.0		+3.0	
	23000	-3.0		+3.0	
	23200	-3.0		+3.0	
	23400	-3.0		+3.0	
	23600	-3.0		+3.0	
	23800	-3.0		+3.0	
	24000	-3.0		+3.0	
	24200	-3.0		+3.0	
	24400	-3.0		+3.0	
	24600	-3.0		+3.0	
	24800	-3.0		+3.0	
	25000	-3.0		+3.0	
	25200	-3.0		+3.0	
	25400	-3.0		+3.0	
25600	-3.0		+3.0		
25800	-3.0		+3.0		
26000	-3.0		+3.0		
26200	-3.0		+3.0		
26400	-3.0		+3.0		
26600	-3.0		+3.0		
26800	-3.0		+3.0		



- Frequency Range 27 GHz to 30 GHz for R3182

Preamplifier	Test Data (MHz)	Specification			Result
		Min. (dB)	Measured Value (dB)	Max. (dB)	Pass/Fail
OFF	27000	-3.5		+3.5	
	27200	-3.5		+3.5	
	27400	-3.5		+3.5	
	27600	-3.5		+3.5	
	27800	-3.5		+3.5	
	28000	-3.5		+3.5	
	28200	-3.5		+3.5	
	28400	-3.5		+3.5	
	28600	-3.5		+3.5	
	28800	-3.5		+3.5	
	29000	-3.5		+3.5	
	29200	-3.5		+3.5	
	29400	-3.5		+3.5	
	29600	-3.5		+3.5	
29800	-3.5		+3.5		

5.5 Performance Verification Record Sheet

- Frequency Range 30 GHz to 40 GHz for R3182

Preamplifier	Test Data (MHz)	Specification			Result
		Min. (dB)	Measured Value (dB)	Max. (dB)	Pass/Fail
OFF	30000	-4.0		+4.0	
	30200	-4.0		+4.0	
	30400	-4.0		+4.0	
	30600	-4.0		+4.0	
	30800	-4.0		+4.0	
	31000	-4.0		+4.0	
	31200	-4.0		+4.0	
	31400	-4.0		+4.0	
	31600	-4.0		+4.0	
	31800	-4.0		+4.0	
	32000	-4.0		+4.0	
	32200	-4.0		+4.0	
	32400	-4.0		+4.0	
	32600	-4.0		+4.0	
	32800	-4.0		+4.0	
	33000	-4.0		+4.0	
	33200	-4.0		+4.0	
	33400	-4.0		+4.0	
	33600	-4.0		+4.0	
	33800	-4.0		+4.0	
	34000	-4.0		+4.0	
	34200	-4.0		+4.0	
	34400	-4.0		+4.0	
	34600	-4.0		+4.0	
	34800	-4.0		+4.0	
	35000	-4.0		+4.0	
	35200	-4.0		+4.0	
	35400	-4.0		+4.0	
35600	-4.0		+4.0		
35800	-4.0		+4.0		
36000	-4.0		+4.0		

Preamplifier	Test Data (MHz)	Specification			Result
		Min. (dB)	Measured Value (dB)	Max. (dB)	Pass/Fail
OFF	36200	-4.0		+4.0	
	36400	-4.0		+4.0	
	36600	-4.0		+4.0	
	36800	-4.0		+4.0	
	37000	-4.0		+4.0	
	37200	-4.0		+4.0	
	37400	-4.0		+4.0	
	37600	-4.0		+4.0	
	37800	-4.0		+4.0	
	38000	-4.0		+4.0	
	38200	-4.0		+4.0	
	38400	-4.0		+4.0	
	38600	-4.0		+4.0	
	38800	-4.0		+4.0	
	39000	-4.0		+4.0	
	39200	-4.0		+4.0	
	39400	-4.0		+4.0	
	39600	-4.0		+4.0	
39800	-4.0		+4.0		
40000	-4.0		+4.0		

5.5 Performance Verification Record Sheet

(16) Span Accuracy

Frequency Span (Hz)	Center Frequency (Hz)	Specification			Result
		Min. (Hz)	Measured Value (Hz)	Max. (Hz)	Pass/Fail
100 k	1.5 G	79.2 k		80.8 k	
1 M	1.5 G	792 k		808 k	
10 M	1.5 G	7.92 M		8.08 M	
100 M	1.5 G	79.2 M		80.08 M	
1 G	1.5 G	792 M		808 M	
3 G	1.5 G	2.376 G		2.424 G	
Apply for R3162/72/82					
10 M	4 G	7.92 G		8.08 M	
100 M	4 G	79.2 G		80.8 M	
1 G	4 G	792 M		808 M	
8 G	4 G	6.336 G		6.464 G	
10 M	7.5 G	7.92 M		8.08 M	
100 M	7.5 G	79.2 M		80.8 M	
Apply for R3172/82					
10 M	10 G	7.92 M		8.08 M	
100 M	10 G	79.2 M		80.8 M	
1 G	10 G	792 M		808 M	
10 G	10 G	7.92 G		8.08 G	
20 G	10 G	15.84 G		16.16 G	
10 M	17 G	7.92 M		8.08 M	
100 M	17 G	79.2 M		80.8 M	
1 G	17 G	792 M		808 M	
Apply for R3182					
10 M	28 G	7.92 M		8.08 M	
100 M	28 G	79.2 M		80.8 M	
1 G	28 G	792 M		808 M	
10 M	35 G	7.92 M		8.08 M	
100 M	35 G	79.2 M		80.8 M	
1 G	35 G	792 M		808 M	
30 G	20 G	23.76 G		24.24 G	

## (17) Third Order Intermodulation Distortion

Center Frequency (MHz)	Specification			Result
	Min. (dB)	Measured Value (dB)	Max. (dB)	Pass/Fail
200	N/A		-60	
1500	N/A		-60	
2500	N/A		-60	
Apply for R3162				
3600	N/A		-60	
7500	N/A		-60	
Apply for R3172				
3600	N/A		-50	
7500	N/A		-50	
Apply for R3182				
3600	N/A		-55	
7500	N/A		-55	

## (18) Gain Compression

Preamplifier	Center Frequency (MHz)	Specification			Result
		Min. (dBm)	Measured Value (dBm)	Max. (dBm)	Pass/Fail
Apply for R3132/62/72/82					
OFF	200.5	0			
ON	200.5	-25			
Apply for R3162					
OFF	3600.5	0			
Apply for R3172/82					
OFF	3600.5	-5			

Preamplifier	Center Frequency (MHz)	Specification			Result
		Min. (dB $\mu$ V)	Measured Value (dB $\mu$ V)	Max. (dB $\mu$ V)	Pass/Fail
Apply for R3132N					
OFF	200.5	107			
ON	200.5	82			

5.5 Performance Verification Record Sheet

(19) Sweep Time Accuracy

Sweep Time Setting (s)	Test Data (s)	Specification			Result
		Min. (s)	Measured Value (s)	Max. (s)	Pass/Fail
50	45	44.1		45.9	
5	4.5	4.41		4.59	
500 m	450 m	441 m		459	
50 m	45 m	44.1 m		45.9 m	
5 m (Option)	4.5 m	4.41 m		4.59 m	
500 μ (Option)	450 μ	441 μ		459 μ	
50 μ (Option)	45 μ	44.1 μ		45.9 μ	

(20) Residual Response

- For the R3132

Preamplifier	Frequency Range	Specification			Result
		Min. (dBm)	Measured Value	Max. (dBm)	Pass/Fail
OFF	1 MHz to 3 GHz	N/A		-100	
ON	1 MHz to 3 GHz	N/A		-105	

- For the R3132N

Preamplifier	Frequency Range	Specification			Result
		Min (dBμV)	Measured Value	Max. (dBμV)	Pass/Fail
OFF	1 MHz to 2.2 GHz	N/A		11	
ON	1 MHz to 2.2 GHz	N/A		6	

- For the R3162/72/82

Preamplifier	Frequency Range	Specification			Result
		Min. (dBm)	Measured Value	Max. (dBm)	Pass/Fail
OFF	1 MHz to 3.3 GHz	N/A		-100	
ON	1 MHz to 3.3 GHz	N/A		-105	
OFF	3.2 MHz to 8 GHz	N/A		-90	

## (21) Tracking Generator

- Absolute Output Level Accuracy

Test Data	Specification			Result
	Min. (dB)	Measured Value (dB)	Max. (dB)	Pass/Fail
-10 dBm	-0.5		+0.5	

- Output Level Flatness

Test Data	Specification			Result
	Min. (dB)	Measured Value (dB)	Max. (dB)	Pass/Fail
Center Frequency (Hz)				
30 M	-	0 (Ref.)	-	
100 k	-1.0		+1.0	
300 k	-1.0		+1.0	
1 M	-1.0		+1.0	
3 M	-1.0		+1.0	
10 M	-1.0		+1.0	
100 M	-1.0		+1.0	
200 M	-1.0		+1.0	
400 M	-1.0		+1.0	
600 M	-1.0		+1.0	
800 M	-1.0		+1.0	
1 G	-1.0		+1.0	
1.2 G	-1.5		+1.5	
1.4 G	-1.5		+1.5	
1.6 G	-1.5		+1.5	
1.8 G	-1.5		+1.5	
2 G	-1.5		+1.5	
2.2 G	-1.5		+1.5	
2.4 G	-1.5		+1.5	
2.6 G	-1.5		+1.5	
2.8 G	-1.5		+1.5	
3.0 G	-1.5		+1.5	

5.5 Performance Verification Record Sheet

- Output Level Switching Accuracy

Setting of R3132/3162			Specification			Result
Center Frequency (Hz)	Output Level (dBm)	Reference Level (dBm)	Min. (dB)		Max. (dB)	Pass/Fail
100 k	-10.0	-5.0	N/A	Reference	N/A	
	0	5.0	-1.0		+1.0	
	-14.9	-9.9	-1.0		+1.0	
	-15.0	-10.0	-1.0		+1.0	
	-19.9	-14.9	-1.0		+1.0	
	-20.0	-15.0	-1.0		+1.0	
	-30.0	-25.0	-1.0		+1.0	
	-40.0	-35.0	-2.0		+2.0	
1 M	-50.0	-45.0	-2.0		+2.0	
	-10.0	-5.0	N/A	Reference	N/A	
	0	5.0	-1.0		+1.0	
	-14.9	-9.9	-1.0		+1.0	
	-15.0	-10.0	-1.0		+1.0	
	-19.9	-14.9	-1.0		+1.0	
	-20.0	-15.0	-1.0		+1.0	
	-30.0	-25.0	-1.0		+1.0	
10 M	-40.0	-35.0	-2.0		+2.0	
	-50.0	-45.0	-2.0		+2.0	
	-10.0	-5.0	N/A	Reference	N/A	
	0	5.0	-1.0		+1.0	
	-14.9	-9.9	-1.0		+1.0	
	-15.0	-10.0	-1.0		+1.0	
	-19.9	-14.9	-1.0		+1.0	
	-20.0	-15.0	-1.0		+1.0	
-30.0	-25.0	-1.0		+1.0		
-40.0	-35.0	-2.0		+2.0		
-50.0	-45.0	-2.0		+2.0		



Setting of R3132/3162			Specification			Result
Center Frequency (Hz)	Output Level (dBm)	Reference Level (dBm)	Min. (dB)		Max. (dB)	Pass/Fail
200 M	-10.0	-5.0	N/A	Reference	N/A	
	0	5.0	-1.0		+1.0	
	-14.9	-9.9	-1.0		+1.0	
	-15.0	-10.0	-1.0		+1.0	
	-19.9	-14.9	-1.0		+1.0	
	-20.0	-15.0	-1.0		+1.0	
	-30.0	-25.0	-1.0		+1.0	
	-40.0	-35.0	-2.0		+2.0	
400 M	-50.0	-45.0	-2.0		+2.0	
	-10.0	-5.0	N/A	Reference	N/A	
	0	5.0	-1.0		+1.0	
	-14.9	-9.9	-1.0		+1.0	
	-15.0	-10.0	-1.0		+1.0	
	-19.9	-14.9	-1.0		+1.0	
	-20.0	-15.0	-1.0		+1.0	
	-30.0	-25.0	-1.0		+1.0	
600 M	-40.0	-35.0	-2.0		+2.0	
	-50.0	-45.0	-2.0		+2.0	
	-10.0	-5.0	N/A	Reference	N/A	
	0	5.0	-1.0		+1.0	
	-14.9	-9.9	-1.0		+1.0	
	-15.0	-10.0	-1.0		+1.0	
	-19.9	-14.9	-1.0		+1.0	
	-20.0	-15.0	-1.0		+1.0	
-30.0	-25.0	-1.0		+1.0		
-40.0	-35.0	-2.0		+2.0		
-50.0	-45.0	-2.0		+2.0		

5.5 Performance Verification Record Sheet

Setting of R3132/3162			Specification			Result
Center Frequency (Hz)	Output Level (dBm)	Reference Level (dBm)	Min. (dB)		Max. (dB)	Pass/Fail
800 M	-10.0	-5.0	N/A	Reference	N/A	
	0	5.0	-1.0		+1.0	
	-14.9	-9.9	-1.0		+1.0	
	-15.0	-10.0	-1.0		+1.0	
	-19.9	-14.9	-1.0		+1.0	
	-20.0	-15.0	-1.0		+1.0	
	-30.0	-25.0	-1.0		+1.0	
	-40.0	-35.0	-2.0		+2.0	
1 G	-50.0	-45.0	-2.0		+2.0	
	-10.0	-5.0	N/A	Reference	N/A	
	0	5.0	-1.0		+1.0	
	-14.9	-9.9	-1.0		+1.0	
	-15.0	-10.0	-1.0		+1.0	
	-19.9	-14.9	-1.0		+1.0	
	-20.0	-15.0	-1.0		+1.0	
	-30.0	-25.0	-1.0		+1.0	
1.5 G	-40.0	-35.0	-2.0		+2.0	
	-50.0	-45.0	-2.0		+2.0	
	-10.0	-5.0	N/A	Reference	N/A	
	0	5.0	-2.0		+2.0	
	-14.9	-9.9	-2.0		+2.0	
	-15.0	-10.0	-2.0		+2.0	
	-19.9	-14.9	-2.0		+2.0	
	-20.0	-15.0	-2.0		+2.0	
-30.0	-25.0	-2.0		+2.0		
-40.0	-35.0	-2.0		+2.0		
-50.0	-45.0	-2.0		+2.0		

Setting of R3132/3162			Specification			Result
Center Frequency (Hz)	Output Level (dBm)	Reference Level (dBm)	Min. (dB)		Max. (dB)	Pass/Fail
2.0 G	-10.0	-5.0	N/A	Reference	N/A	
	0	5.0	-2.0		+2.0	
	-14.9	-9.9	-2.0		+2.0	
	-15.0	-10.0	-2.0		+2.0	
	-19.9	-14.9	-2.0		+2.0	
	-20.0	-15.0	-2.0		+2.0	
	-30.0	-25.0	-2.0		+2.0	
	-40.0	-35.0	-2.0		+2.0	
2.5 G	-10.0	-5.0	N/A	Reference	N/A	
	0	5.0	-2.0		+2.0	
	-14.9	-9.9	-2.0		+2.0	
	-15.0	-10.0	-2.0		+2.0	
	-19.9	-14.9	-2.0		+2.0	
	-20.0	-15.0	-2.0		+2.0	
	-30.0	-25.0	-2.0		+2.0	
	-40.0	-35.0	-2.0		+2.0	
3.0 G	-10.0	-5.0	N/A	Reference	N/A	
	0	5.0	-3.0		+3.0	
	-14.9	-9.9	-3.0		+3.0	
	-15.0	-10.0	-3.0		+3.0	
	-19.9	-14.9	-3.0		+3.0	
	-20.0	-15.0	-3.0		+3.0	
	-30.0	-25.0	-3.0		+3.0	
	-40.0	-35.0	-3.0		+3.0	
	-50.0	-45.0	-3.0		+3.0	

5.5 Performance Verification Record Sheet

- Harmonic Distortion

Test Data	Specification			Result
Frequency Range	Min. (dB)	Measured Value (dB)	Max. (dB)	Pass/Fail
100 kHz to 3 GHz	N/A		-2.0	

- Non harmonic Distortion

Test Data	Specification			Result
Frequency Range	Min. (dB)	Measured Value (dB)	Max. (dB)	Pass/Fail
100 kHz to 3 GHz	N/A		-3.0	

- TG Leakage  
R3132/62/72

Test Data	Specification			Result
Frequency Range	Min. (dBm)	Measured Value (dBm)	Max. (dBm)	Pass/Fail
100 kHz to 3 GHz	N/A		-100	

R3132N

Test Data	Specification			Result
Frequency Range	Min. (dB $\mu$ V)	Measured Value (dB $\mu$ V)	Max. (dB $\mu$ V)	Pass/Fail
100 kHz to 2.2 GHz	N/A		7	

## (22) FM demodulation

- Offset Error (Internal Mixer Mode)

Range	Specification			Result
	Min. (Hz)	Measured Value (Hz)	Max. (Hz)	Pass/Fail
1 kHz/	0		2.4 k	
2.5 kHz/	0		3 k	
5 kHz/	0		4 k	
10 kHz/	0		6 k	
25 kHz/	0		18 k	
50 kHz/	0		28 k	
100 kHz/	0		48 k	
250 kHz/	0		108 k	

- Linearity Error (Internal Mixer Mode)

Range	Specification			Result
	Min. (Hz)	Measured Value (Hz)	Max. (Hz)	Pass/Fail
1 kHz/	7.8 k		8.2 k	
2.5 kHz/	19.5 k		20.5 k	
5 kHz/	39 k		41 k	
10 kHz/	78 k		82 k	
25 kHz/	195 k		205 k	
50 kHz/	390 k		410 k	
100 kHz/	780 k		820 k	
250 kHz/	1.95 M		2.05 M	

5.5 Performance Verification Record Sheet

- Offset Error (External Mixer Mode)

Range	Specification			Result
	Min. (Hz)	Measured Value (Hz)	Max. (Hz)	Pass/Fail
1 kHz/	0		2.4 k	
2.5 kHz/	0		3 k	
5 kHz/	0		4 k	
10 kHz/	0		6 k	
25 kHz/	0		18 k	
50 kHz/	0		28 k	
100 kHz/	0		48 k	
250 kHz/	0		108 k	
500 kHz/	0		328 k	
1 MHz/	0		528 k	
2.5 MHz/	0		1.128 M	
5 MHz/	0		2.128 M	
10 MHz/	0		4.128 M	
25 MHz/	0		10.128 M	
50 MHz/	0		20.128 M	

- Linearity Error (External Mixer Mode)

Range	Specification			Result
	Min. (Hz)	Measured Value (Hz)	Max. (Hz)	Pass/Fail
1 kHz/	7.8 k		8.2 k	
2.5 kHz/	19.5 k		20.5 k	
5 kHz/	39 k		41 k	
10 kHz/	78 k		82 k	
25 kHz/	195 k		205 k	
50 kHz/	390 k		410 k	
100 kHz/	780 k		820 k	
250 kHz/	1.95 M		2.05 M	
500 kHz/	3.9 M		4.1 M	
1 MHz/	7.8 M		8.2 M	
2.5 MHz/	19.5 M		20.5 M	
5 MHz/	39 M		41 M	
10 MHz/	78 M		82 M	
25 MHz/	195 M		205 M	
50 MHz/	390 M		410 M	

## 6 PERFORMANCE VERIFICATION (External Mixer)

### 6.1 External Mixer OPT16

#### (1) Introduction

This chapter provides OPT3172/3182+16 external mixer performance verification test procedures, item by item as listed on Table 6-1.

Performance verification will be carried out under following condition.

Temperature range: 20 °C to 30 °C

Relative Humidity: 85 % or less

**Table 6-1 List of Performance Verification Test Items**

No.	Test Description	Applicable Models
1	Noise Level	OPT3172/3182+16
2	Frequency Response	OPT3172/3182+16

#### (2) Test Equipment

Table 6-2 lists equipment for the performance verification test.

The equipment needed to perform all of the performance test.

Equipment lists for individual tests are provided in each performance verification test procedure.

**Table 6-2 Equipment List for Performance Verification Test**

No.	Description	Critical Specifications for substitute Model	Model Recommended	Manufacturer	Notes
1	Sweeper	No substitute model recommended	83640	Agilent Technologies	SG
2	Source Module	No substitute model recommended	83554A	Agilent Technologies	-
3	10 dB Fixed Attenuator	No substitute model recommended	521A	MPI	-
4	RF Power Sensor	No substitute model recommended	R8486A	Agilent Technologies	-
5	RF Cable	Type: SMA(m)-SMA(m)	DCP-FF00092X02	Advantest	-
6	Spectrum Analyzer	No substitute model recommended	R3172/R3182	Advantest	-

6.1 External Mixer OPT16

---

**NOTE:**

1. *The R3172/R3182 to be tested should be warmed up for at least 30 minutes before starting tests. Any additional equipment used for this performance verification tests should be warmed up as appropriate.*
  2. *Make sure that the test equipment used meets its own published specifications and that all connectors are clean, before starting test.*
  3. *Any equipment that meets critical specifications given in the Table can be substituted for recommended models.*
- 

(3) Calibration Cycle

The performance verifications should be used to check the external mixer against its specifications every once a year recommended.

(4) Performance Verification Test Record Sheets

The performance verification test record sheets at the end of this chapter are provided the value measured in each performance verification.

The test record lists test specification and acceptable limits.

Performance verification test record sheets for each option is provided at end of this manual.

Recommend that make a copy of these sheets, record the complete test results on the copy, and keep the copy for calibration test record.

This record could prove invaluable in tracking gradual changes in test result over long periods of the time.

(5) Conventions Used in this Manual

The following conventions are used in this manual.

- Panel keys and soft keys are printed in a contrasting typeface to make them stand out from the text as follows:

Panel keys: Boldface type                      Example: **FREQ, FORMAT**

Soft keys: Boldface and italic type Example: ***Center, Trace Detector***

- When a series of key operations are described using a comma between two keys.
- There are various soft menus used to switch between two states such as ON/OFF and AUTO/MNL.

For example, when turning off the ***Display ON/OFF*** function, the annotation "***Display ON/OFF(OFF)***" is used.

When switching the ***RBW AUTO/MNL*** function to MNL, the annotation "***RBW AUTO/MNL(MNL)***" is used.



## 6.1.1 External Mixer Performance Verification Test Procedures

This section describes the performance verification test procedure listed on Table 6-1.

### 6.1.1.1 Noise Level

Description:

Verify the external mixer's noise level.

Firstly load the correction data on the backed up floppy disk to R3172/R3182 internal memory. Set the sweeper output to off.

Measure the noise level in the entire frequency range of each external mixer by 500 MHz step.

Specification:

Frequency Range	Noise Level
26.5 - 40 GHz	$\leq -99$ dBm

Equipment required:

Sweeper:	83640 (SG)
Source Module:	83554A
10 dB Fixed Attenuator:	521A
RF Cable:	DCP-FF00092X02
Spectrum Analyzer:	R3172/R3182

Setup

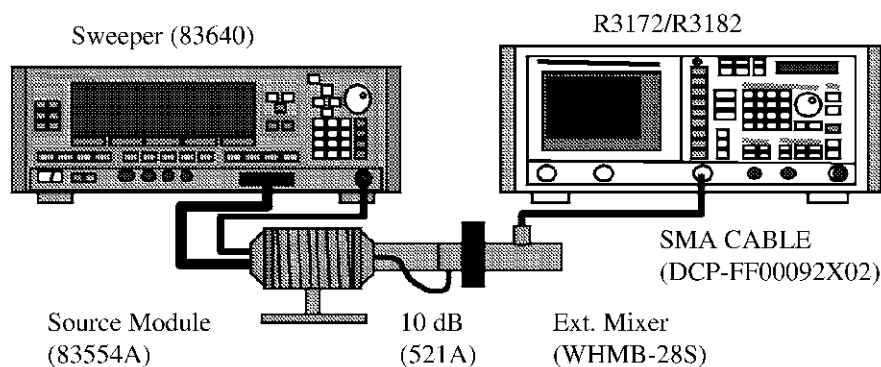

Figure 6-1 Setup of Noise Level Test

Procedure

1. Connect equipment as shown in Figure 6-1.
2. On the SG set output level to off.
3. On the R3172/R3182, press keys as follows to preset.

6.1.1 External Mixer Performance Verification Test Procedures

**SHIFT, CONFIG (PRESET)**

4. Insert the correction data floppy disk.
5. On the R3172/R3182, press keys as follows to set FD reading.

**RECALL, Device, RAM/FD (FD)**

6. Select the "WHMB28" file by rotating the data knob.
7. On the R3172/R3182, press **RECALL** key to load the correction data.
8. On the R3172/R3182, set controls as follows;  
Frequency Span: Zero  
Reference Level: -40 dBm  
dB/div: 10 dB/div  
RBW: 1 kHz  
VBW: 10 Hz  
Detector: Sample
9. On the R3172/R3182, set control as follow;  
Center Frequency: 26.5 GHz
10. On the R3172/R3182, press keys as follows to set number of average to 3 times.

**TRACE, 1/2\_more, AVG A, 3, Hz (ENTER)**

Wait until the average process has completed

11. On the R3172/R3182, press **PKSRCH** to capture the highest noise signal.
12. Record the level of marker on the performance verification test record sheets.
13. On the R3172/R3182, set control as follow;  
Center Frequency: 27.0 GHz  
Wait until the average process has completed
14. On the R3172/R3182, press **PKSRCH** key to capture the highest noise signal.
15. Record the level of marker on the performance verification test record sheets.
16. Repeat steps 13 through 15 for incrementing the center frequency of 500 MHz step up to 40 GHz.

### 6.1.1.2 Frequency Response

#### Description:

Verify the external mixer frequency response against specification.

Firstly measure the source module out power with RF power meter and RF power sensor in the entire frequency range by 100 MHz step, and record it as calibrated value.

Secondary connect external mixer to the source module, and then measure the frequency response on the R3172/R3182 screen in the entire frequency range by 100 MHz step, and record it as measured value.

Calculate between the calibrated value and measured value for the frequency response.

#### Specification:

Frequency Range: 26.5 to 40.0 GHz,  $\pm 5$  dB

#### Equipment required:

Sweeper:	83640 (SG)
Source Module:	83554A
10 dB Fixed Attenuator:	521A
RF Cable:	DCP-FF00092X02
RF Power Meter:	437B
RF Power Sensor:	R8486A
Spectrum Analyzer:	R3172/R3182

#### Setup

##### Source Module Calibration

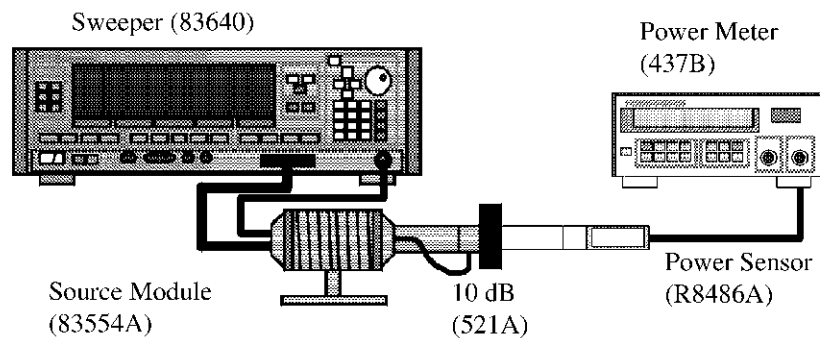

**Figure 6-2 Setup of Source Module Calibration**

6.1.1 External Mixer Performance Verification Test Procedures

Frequency Response

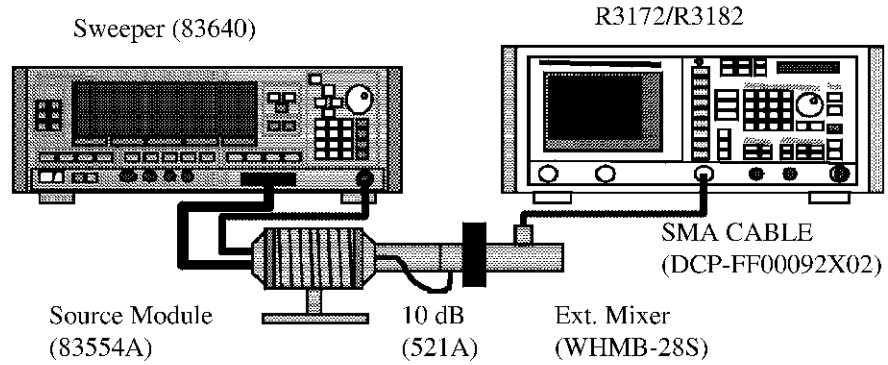

Figure 6-3 Setup of Frequency Response Test

Procedure

Part 1 Source Module Calibration

1. On the RF power meter, perform ZERO and calibration with the RF power sensor.
2. Connect equipment as shown in Figure 6-2.
3. On the SG, set controls as follows;  
Output Frequency: 26.5 GHz  
Output Level: 0 dBm
4. On the RF power meter set correction data for 26.5 GHz.
5. Measure the source module output level, and then record it in reference column on the performance verification test record sheets.
6. On the SG, set control as follow;  
Output Frequency: 26.5 GHz
7. On the RF power meter set correction data for 26.6 GHz.
8. Measure the source module output level, and then record it in calibrated value column on the performance verification test record sheets.
9. Repeat steps 6 through 8 for the SG output frequency and RF power meter correction data up to 40 GHz by 100 MHz steps.

Part 2 Frequency Response Test

10. Connect equipment as shown in Figure 6-3.

11. On the R3172/R3182, press keys as follows to preset.

**SHIFT, CONFIG (PRESET)**

12. On the R3172/R3182, set controls as follows;

Center Frequency: 26.5 GHz  
Span: 40MHz  
Reference Level: 0dBm  
dB/div: 10dB/div  
RBW: 300kHz  
VBW: 3kHz  
Detector: Sample

13. On the SG, set controls as follows;

Output Frequency: 26.5 GHz  
Output Level: 0 dBm

14. On the R3172/3182, press **SINGLE** key for a sweep.

15. On the R3172/R3182, press **PKSRCH** key to capture the signal peak.

16. Record the level of peak marker in the measured value column on the performance verification test data sheets.

17. Calculate actual value using following equation.

$$\text{Actual Value} = \text{Abs (Calibrated value)} - \text{Abs (Measured value)}$$

18. Record the result in the actual value column on the performance verification test data sheets.

19. On the R3172/R3182, set control as follow;

Center Frequency: 26.6 GHz

20. On the SG, set control as follow;

Output Frequency: 26.6 GHz

21. On the R3172/3182, press **SINGLE** key for a sweep.

22. On the R3172/R3182, press **PKSRCH** key to capture the signal peak.

23. Record the level of peak marker in the measured value column on the performance verification test data sheets.

24. Calculate actual value using following equation.

$$\text{Actual Value} = \text{Abs (Calibrated value)} - \text{Abs (Measured value)}$$

6.1.1 External Mixer Performance Verification Test Procedures

25. Record the result in the actual value column on the performance verification test data sheets.
26. Repeat steps 19 through 25 for the frequency setting both of R3172/R3182 center frequency and SG output frequency up-to 40 GHz step by 100 MHz.

**6.1.2 Performance Verification Test Record Sheets*****Performance Verification Test Record Sheets***

Model: OPT3172/3182+16

Date:

Serial Number:

## 1. Noise Level

Test Data Frequency (GHz)	Specification			Result
	Min. (dBm)	Measured value (dBm)	Max. (dBm)	Pass/Fail
26.5	NA		-99	
27.0	NA		-99	
27.5	NA		-99	
28.0	NA		-99	
28.5	NA		-99	
29.0	NA		-99	
29.5	NA		-99	
30.0	NA		-99	
30.5	NA		-99	
31.0	NA		-99	
31.5	NA		-99	
32.0	NA		-99	
32.5	NA		-99	
33.0	NA		-99	
33.5	NA		-99	
34.0	NA		-99	
34.5	NA		-99	
35.0	NA		-99	
35.5	NA		-99	
36.0	NA		-99	
36.5	NA		-99	
37.0	NA		-99	
37.5	NA		-99	
38.0	NA		-99	
38.5	NA		-99	
39.0	NA		-99	
39.5	NA		-99	
40.0	NA		-99	

6.1.2 Performance Verification Test Record Sheets

2. Frequency Response

Test Data			Specification			Result
Frequency (GHz)	Calibrated value (dBm)	Measured value (dBm)	Min. (dB)	Actual value (dB)	Max. (dB)	Pass/Fail
26.5			-5		+5	
26.6			-5		+5	
26.7			-5		+5	
26.8			-5		+5	
26.9			-5		+5	
27.0			-5		+5	
27.1			-5		+5	
27.2			-5		+5	
27.3			-5		+5	
27.4			-5		+5	
27.5			-5		+5	
27.6			-5		+5	
27.7			-5		+5	
27.8			-5		+5	
27.9			-5		+5	
28.0			-5		+5	
28.1			-5		+5	
28.2			-5		+5	
28.3			-5		+5	
28.4			-5		+5	
28.5			-5		+5	
28.6			-5		+5	
28.7			-5		+5	
28.8			-5		+5	
28.9			-5		+5	
29.0			-5		+5	
29.1			-5		+5	
29.2			-5		+5	
29.3			-5		+5	
29.4			-5		+5	
29.5			-5		+5	
29.6			-5		+5	
29.7			-5		+5	
29.8			-5		+5	
29.9			-5		+5	
30.0			-5		+5	



## 6.1.2 Performance Verification Test Record Sheets

Test Data			Specification			Result
Frequency (GHz)	Calibrated value (dBm)	Measured value (dBm)	Min. (dB)	Actual value (dB)	Max. (dB)	Pass/Fail
30.1			-5		+5	
30.2			-5		+5	
30.3			-5		+5	
30.4			-5		+5	
30.5			-5		+5	
30.6			-5		+5	
30.7			-5		+5	
30.8			-5		+5	
30.9			-5		+5	
31.0			-5		+5	
31.1			-5		+5	
31.2			-5		+5	
31.3			-5		+5	
31.4			-5		+5	
31.5			-5		+5	
31.6			-5		+5	
31.7			-5		+5	
31.8			-5		+5	
31.9			-5		+5	
32.0			-5		+5	
32.1			-5		+5	
32.2			-5		+5	
32.3			-5		+5	
32.4			-5		+5	
32.5			-5		+5	
32.6			-5		+5	
32.7			-5		+5	
32.8			-5		+5	
32.9			-5		+5	
33.0			-5		+5	
33.1			-5		+5	
33.2			-5		+5	
33.3			-5		+5	
33.4			-5		+5	
33.5			-5		+5	
33.6			-5		+5	
33.7			-5		+5	

6.1.2 Performance Verification Test Record Sheets

Test Data			Specification			Result
Frequency (GHz)	Calibrated value (dBm)	Measured value (dBm)	Min. (dB)	Actual value (dB)	Max. (dB)	Pass/Fail
33.8			-5		+5	
33.9			-5		+5	
34.0			-5		+5	
34.1			-5		+5	
34.2			-5		+5	
34.3			-5		+5	
34.4			-5		+5	
34.5			-5		+5	
34.6			-5		+5	
34.7			-5		+5	
34.8			-5		+5	
34.9			-5		+5	
35.0			-5		+5	
35.1			-5		+5	
35.2			-5		+5	
35.3			-5		+5	
35.4			-5		+5	
35.5			-5		+5	
35.6			-5		+5	
35.7			-5		+5	
35.8			-5		+5	
35.9			-5		+5	
36.0			-5		+5	
36.1			-5		+5	
36.2			-5		+5	
36.3			-5		+5	
36.4			-5		+5	
36.5			-5		+5	
36.6			-5		+5	
36.7			-5		+5	
36.8			-5		+5	
36.9			-5		+5	
37.0			-5		+5	
37.1			-5		+5	
37.2			-5		+5	
37.3			-5		+5	
37.4			-5		+5	

Test Data			Specification			Result
Frequency (GHz)	Calibrated value (dBm)	Measured value (dBm)	Min. (dB)	Actual value (dB)	Max. (dB)	Pass/Fail
37.5			-5		+5	
37.6			-5		+5	
37.7			-5		+5	
37.8			-5		+5	
37.9			-5		+5	
38.0			-5		+5	
38.1			-5		+5	
38.2			-5		+5	
38.3			-5		+5	
38.4			-5		+5	
38.5			-5		+5	
38.6			-5		+5	
38.7			-5		+5	
38.8			-5		+5	
38.9			-5		+5	
39.0			-5		+5	
39.1			-5		+5	
39.2			-5		+5	
39.3			-5		+5	
39.4			-5		+5	
39.5			-5		+5	
39.6			-5		+5	
39.7			-5		+5	
39.8			-5		+5	
39.9			-5		+5	
40.0			-5		+5	

## 6.2 External Mixer OPT17

### (1) Introduction

This chapter provides OPT3172/3182+17 external mixer performance verification test procedures, item by item as listed on Table 6-3.

Performance verification will be carried out under following condition.

Temperature range: 20 °C to 30 °C

Relative Humidity: 85 % or less

**Table 6-3 List of Performance Verification Test Items**

No.	Test Description	Applicable Models
1	Noise Level	OPT3172/3182+17
2	Frequency Response	OPT3172/3182+17

### (2) Test Equipment

Table 6-4 lists equipment for the performance verification test.

The equipment needed to perform all of the performance test.

Equipment lists for individual tests are provided in each performance verification test procedure.

**Table 6-4 Equipment List for Performance Verification Test**

No.	Description	Critical Specifications for substitute Model	Model Recommended	Manufacturer	Notes
1	Sweeper	No substitute model recommended	83640	Agilent Technologies	SG
2	Source Module	No substitute model recommended	83556A	Agilent Technologies	-
3	10 dB Fixed Attenuator	No substitute model recommended	521U	MPI	-
4	RF Power Sensor	No substitute model recommended	Q8486A	Agilent Technologies	-
5	RF Power Sensor	No substitute model recommended	V8486A	Agilent Technologies	-
6	RF Power Meter	No substitute model recommended	437B	Agilent Technologies	-
7	RF Cable	Type: SMA(m)-SMA(m)	DCP-FF00092X02	Advantest	-
8	Spectrum Analyzer	No substitute model recommended	R3172/R3182	Advantest	-

---

**NOTE:**

1. *The R3172/R3182 to be tested should be warmed up for at least 30 minutes before starting tests. Any additional equipment used for this performance verification tests should be warmed up as appropriate.*
  2. *Make sure that the test equipment used meets its own published specifications and that all connectors are clean, before starting test.*
  3. *Any equipment that meets critical specifications given in the Table can be substituted for recommended models.*
- 

## (3) Calibration Cycle

The performance verifications should be used to check the external mixer against its specifications every once a year recommended.

## (4) Performance Verification Test Record Sheets

The performance verification test record sheets at the end of this chapter are provided the value measured in each performance verification.

The test record lists test specification and acceptable limits.

Performance verification test record sheets for each option is provided at end of this manual.

Recommend that make a copy of these sheets, record the complete test results on the copy, and keep the copy for calibration test record.

This record could prove invaluable in tracking gradual changes in test result over long periods of the time.

## (5) Conventions Used in this Manual

The following conventions are used in this manual.

- Panel keys and soft keys are printed in a contrasting typeface to make them stand out from the text as follows:  
Panel keys: Boldface type            Example: **FREQ, FORMAT**  
Soft keys: Boldface and italic type Example: *Center, Trace Detector*
- When a series of key operations are described using a comma between two keys.
- There are various soft menus used to switch between two states such as ON/OFF and AUTO/MNL.  
For example, when turning off the *Display ON/OFF* function, the annotation "*Display ON/OFF(OFF)*" is used.  
When switching the *RBW AUTO/MNL* function to MNL, the annotation "*RBW AUTO/MNL(MNL)*" is used.

6.2.1 External Mixer Performance Verification Test Procedures

**6.2.1 External Mixer Performance Verification Test Procedures**

This section describes the performance verification test procedure listed on Table 6-1.

**6.2.1.1 Noise Level**

Description:

Verify the external mixer's noise level.

Firstly load the correction data on the backed up floppy disk to R3172/R3182 internal memory. Set the sweeper output to off.

Measure the noise level in ht entire frequency range of each external mixer by 500 MHz step.

Specification:

Frequency Range	Noise Level
40 - 60 GHz	≤ -93 dBm

Equipment required:

- Sweeper: 83640 (SG)
- Source Module: 83556A
- 10 dB Fixed Attenuator: 521U
- RF Cable: DCP-FF00092X02
- Spectrum Analyzer: R3172/R3182

Setup

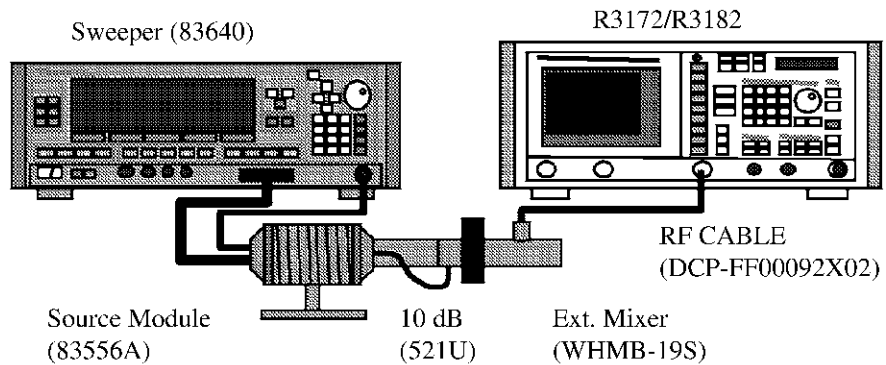

**Figure 6-4 Setup of Noise Level Test**

Procedure

1. Connect equipment as shown in Figure 6-4.
2. On the SG set output level to off.
3. On the R3172/R3182, press keys as follows to preset.

**SHIFT, CONFIG (PRESET)**

4. Insert the correction data floppy disk.
5. On the R3172/R3182, press keys as follows to set FD reading.

**RECALL, Device, RAM/FD (FD)**

6. Select the "WHMB19" file by rotating the data knob.
7. On the R3172/R3182, press **RECALL** key to load the correction data.
8. On the R3172/R3182, set controls as follows;

Frequency Span:	Zero
Reference Level:	-40 dBm
dB/div:	10 dB/div
RBW:	1 kHz
VBW:	10 Hz
Detector:	Sample

9. On the R3172/R3182, set control as follow;  
Center Frequency: 40 GHz
10. On the R3172/R3182, press keys as follows to set number of average to 3 times.

**TRACE, 1/2\_more, AVG A, 3, Hz (ENTER)**

Wait until the average process has completed

11. On the R3172/R3182, press **PKSRCH** to capture the highest noise signal.
12. Record the level of marker on the performance verification test record sheets.
13. On the R3172/R3182, set control as follow;  
Center Frequency: 40.5 GHz  
Wait until the average process has completed
14. On the R3172/R3182, press **PKSRCH** key to capture the highest noise signal.
15. Record the level of marker on the performance verification test record sheets.
16. Repeat steps 13 through 15 for incrementing the center frequency of 500 MHz step up to 60 GHz.

6.2.1 External Mixer Performance Verification Test Procedures

**6.2.1.2 Frequency Response**

Description:

Verify the external mixer frequency response against specification.

Firstly measure the source module out power with RF power meter and RF power sensor in the entire frequency range by 100 MHz step, and record it as calibrated value.

Use two type power sensor depending frequency range, one is Q8486A for 40 GHz to 50 GHz. The other is V8486A for 50 GHz to 60 GHz.

Secondary connect external mixer to the source module, and then measure the frequency response on the R3172/R3182 screen in the entire frequency range by 100 MHz step, and record it as measured value.

Calculate between the calibrated value and measured value for the frequency response.

Specification:

Frequency Range: 40.0 to 60.0 GHz,  $\pm 5$  dB

Equipment required:

- Sweeper: 83640 (SG)
- Source Module: 83556A
- 10 dB Fixed Attenuator: 521U
- RF Cable: DCP-FF00092X02
- RF Power Meter: 437B
- RF Power Sensor: Q8486A (40 GHz to 50 GHz)  
V8486A (50 GHz to 60 GHz)
- Spectrum Analyzer: R3172/R3182

Setup

Source Module Calibration

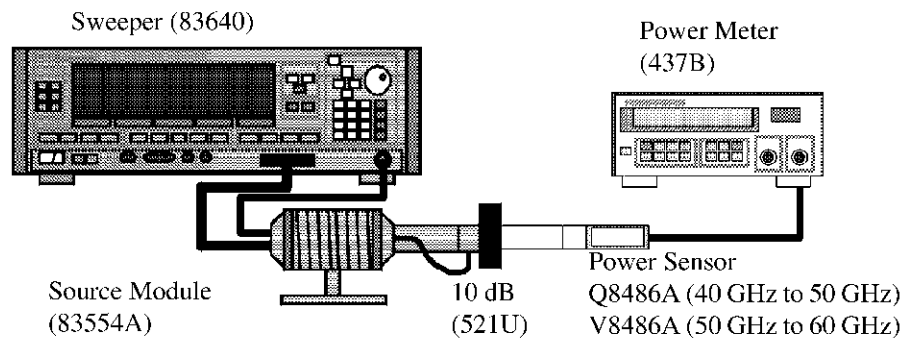

**Figure 6-5 Setup of Source Module Calibration**



## Frequency Response

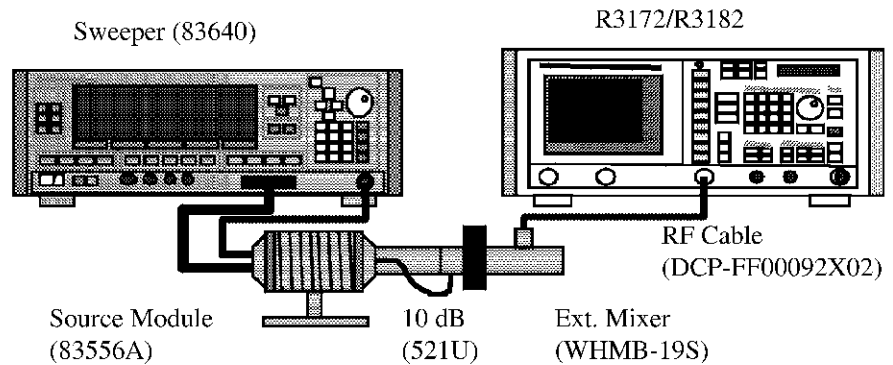

**Figure 6-6 Setup of Frequency Response Test**

## Procedure

## Part 1 Source Module Calibration

1. On the RF power meter, perform ZERO and calibration with the RF power sensor.
2. Connect equipment as shown in Figure 6-5. (Use the RF power sensor Q8486A)
3. On the SG, set controls as follows;
  - Output Frequency: 40.0 GHz
  - Output Level: 0 dBm
4. On the RF power meter set correction data for 40.0 GHz.
5. Measure the source module output level, and then record it in reference column on the performance verification test record sheets.
6. On the SG, set control as follow;
  - Output Frequency: 40.1 GHz
7. On the RF power meter set correction data for 40.1 GHz.
8. Measure the source module output level, and then record it in reference column on the performance verification test record sheets.
9. Repeat steps 6 through 8 for the SG output frequency and RF power meter correction data up to 50 GHz by 100 MHz steps.
10. Change the RF power sensor to V8486A.
11. On the SG, set control as follow;
  - Output Frequency: 50.1 GHz

### 6.2.1 External Mixer Performance Verification Test Procedures

12. On the RF power meter set correction data for 50.1 GHz.
13. Measure the source module output level, and then record it in calibrated value column on the performance verification test record sheets.
14. Repeat steps 11 through 13 for the SG output frequency and RF power meter correction data up to 60 GHz by 100 MHz steps.

#### Part 2 Frequency Response Test

15. Connect equipment as shown in Figure 6-6.
16. On the R3172/R3182, press keys as follows to preset.

#### **SHIFT, CONFIG (PRESET)**

17. On the R3172/R3182, set controls as follows;

Center Frequency:	40.0 GHz
Span:	40 MHz
Reference Level:	0 dBm
dB/div:	10dB/div
RBW:	300kHz
VBW:	3kHz
Detector:	Sample

18. On the SG, set controls as follows;

Output Frequency:	40.0 GHz
Output Level:	0 dBm

19. On the R3172/3182, press **SINGLE** key for a sweep.
20. On the R3172/R3182, press **PKSRCH** key to capture the signal peak.
21. Record the level of peak marker in the measured value column on the performance verification test data sheets.
22. Calculate actual value using following equation.

$$\text{Actual Value} = \text{Abs (Calibrated value)} - \text{Abs (Measured value)}$$

23. Record the result in the actual value column on the performance verification test data sheets.
24. On the R3172/R3182, set control as follow;

Center Frequency:	40.1 GHz
-------------------	----------
25. On the SG, set control as follow;

Output Frequency:	40.1 GHz
-------------------	----------

6.2.1 External Mixer Performance Verification Test Procedures

26. On the R3132/3182, press **SINGLE** key for a sweep.
27. On the R3172/R3182, press **PKSRCH** key to capture the signal peak.
28. Record the level of peak marker in the measured value column on the performance verification test data sheets.
29. Calculate actual value using following equation.  
$$\text{Actual Value} = \text{Abs (Calibrated value)} - \text{Abs (Measured value)}$$
30. Record the result in the actual value column on the performance verification test data sheets.
31. Repeat steps 24 through 30 for the frequency setting both of R3172/R3182 center frequency and SG output frequency up-to 60 GHz step by 100 MHz.

6.2.2 Performance Verification Test Record Sheets

6.2.2 Performance Verification Test Record Sheets

***Performance Verification Test Record Sheets***

Model: OPT3172/3182+17

Date:

Serial Number:

1. Noise Level

Test Data		Specification		Result
Frequency (GHz)	Min. (dBm)	Measured value (dBm)	Max. (dBm)	Pass/Fail
40.5	NA		-93	
50.0	NA		-93	
50.5	NA		-93	
51.0	NA		-93	
51.5	NA		-93	
52.0	NA		-93	
52.5	NA		-93	
53.0	NA		-93	
53.5	NA		-93	
54.0	NA		-93	
54.5	NA		-93	
55.0	NA		-93	
60.0	NA		-93	

2. Frequency Response

Test Data			Specification			Result
Frequency (GHz)	Calibrated value (dBm)	Measured value (dBm)	Min. (dB)	Actual value (dB)	Max. (dB)	Pass/Fail
40.0			-5		+5	
40.1			-5		+5	
40.2			-5		+5	
40.3			-5		+5	
40.4			-5		+5	
40.5			-5		+5	
40.6			-5		+5	
40.7			-5		+5	
40.8			-5		+5	
40.9			-5		+5	
41.0			-5		+5	
41.1			-5		+5	

Test Data			Specification			Result
Frequency (GHz)	Calibrated value (dBm)	Measured value (dBm)	Min. (dB)	Actual value (dB)	Max. (dB)	Pass/Fail
41.2			-5		+5	
41.3			-5		+5	
41.4			-5		+5	
41.5			-5		+5	
41.6			-5		+5	
41.7			-5		+5	
41.8			-5		+5	
41.9			-5		+5	
42.0			-5		+5	
42.1			-5		+5	
42.2			-5		+5	
42.3			-5		+5	
42.4			-5		+5	
42.5			-5		+5	
42.6			-5		+5	
42.7			-5		+5	
42.8			-5		+5	
42.9			-5		+5	
43.0			-5		+5	
43.1			-5		+5	
43.2			-5		+5	
43.3			-5		+5	
43.4			-5		+5	
43.5			-5		+5	
43.6			-5		+5	
43.7			-5		+5	
43.8			-5		+5	
43.9			-5		+5	
44.0			-5		+5	
44.1			-5		+5	
44.2			-5		+5	
44.3			-5		+5	
44.4			-5		+5	
44.5			-5		+5	
44.6			-5		+5	
44.7			-5		+5	
44.8			-5		+5	

6.2.2 Performance Verification Test Record Sheets

Test Data			Specification			Result
Frequency (GHz)	Calibrated value (dBm)	Measured value (dBm)	Min. (dB)	Actual value (dB)	Max. (dB)	Pass/Fail
44.9			-5		+5	
45.0			-5		+5	
45.1			-5		+5	
45.2			-5		+5	
45.3			-5		+5	
45.4			-5		+5	
45.5			-5		+5	
45.6			-5		+5	
45.7			-5		+5	
45.8			-5		+5	
45.9			-5		+5	
46.0			-5		+5	
46.1			-5		+5	
46.2			-5		+5	
46.3			-5		+5	
46.4			-5		+5	
46.5			-5		+5	
46.6			-5		+5	
46.7			-5		+5	
46.8			-5		+5	
46.9			-5		+5	
47.0			-5		+5	
47.1			-5		+5	
47.2			-5		+5	
47.3			-5		+5	
47.4			-5		+5	
47.5			-5		+5	
47.6			-5		+5	
47.7			-5		+5	
47.8			-5		+5	
47.9			-5		+5	
48.0			-5		+5	
48.1			-5		+5	
48.2			-5		+5	
48.3			-5		+5	
48.4			-5		+5	
48.5			-5		+5	

Test Data			Specification			Result
Frequency (GHz)	Calibrated value (dBm)	Measured value (dBm)	Min. (dB)	Actual value (dB)	Max. (dB)	Pass/Fail
48.6			-5		+5	
48.7			-5		+5	
48.8			-5		+5	
48.9			-5		+5	
49.0			-5		+5	
49.1			-5		+5	
49.2			-5		+5	
49.3			-5		+5	
49.4			-5		+5	
49.5			-5		+5	
49.6			-5		+5	
49.7			-5		+5	
49.8			-5		+5	
49.9			-5		+5	
50.0			-5		+5	
50.1			-5		+5	
50.2			-5		+5	
50.3			-5		+5	
50.4			-5		+5	
50.5			-5		+5	
50.6			-5		+5	
50.7			-5		+5	
50.8			-5		+5	
50.9			-5		+5	
51.0			-5		+5	
51.1			-5		+5	
51.2			-5		+5	
51.3			-5		+5	
51.4			-5		+5	
51.5			-5		+5	
51.6			-5		+5	
51.7			-5		+5	
51.8			-5		+5	
51.9			-5		+5	
52.0			-5		+5	
52.1			-5		+5	
52.2			-5		+5	

6.2.2 Performance Verification Test Record Sheets

Test Data			Specification			Result
Frequency (GHz)	Calibrated value (dBm)	Measured value (dBm)	Min. (dB)	Actual value (dB)	Max. (dB)	Pass/Fail
52.3			-5		+5	
52.4			-5		+5	
52.5			-5		+5	
52.6			-5		+5	
52.7			-5		+5	
52.8			-5		+5	
52.9			-5		+5	
53.0			-5		+5	
53.1			-5		+5	
53.2			-5		+5	
53.3			-5		+5	
53.4			-5		+5	
53.5			-5		+5	
53.6			-5		+5	
53.7			-5		+5	
53.8			-5		+5	
53.9			-5		+5	
54.0			-5		+5	
54.1			-5		+5	
54.2			-5		+5	
54.3			-5		+5	
54.4			-5		+5	
54.5			-5		+5	
54.6			-5		+5	
54.7			-5		+5	
54.8			-5		+5	
54.9			-5		+5	
55.0			-5		+5	
55.1			-5		+5	
55.2			-5		+5	
55.3			-5		+5	
55.4			-5		+5	
55.5			-5		+5	
55.6			-5		+5	
55.7			-5		+5	
55.8			-5		+5	
55.9			-5		+5	



Test Data			Specification			Result
Frequency (GHz)	Calibrated value (dBm)	Measured value (dBm)	Min. (dB)	Actual value (dB)	Max. (dB)	Pass/Fail
56.0			-5		+5	
56.1			-5		+5	
56.2			-5		+5	
56.3			-5		+5	
56.4			-5		+5	
56.5			-5		+5	
56.6			-5		+5	
56.7			-5		+5	
56.8			-5		+5	
56.9			-5		+5	
57.0			-5		+5	
57.1			-5		+5	
57.2			-5		+5	
57.3			-5		+5	
57.4			-5		+5	
57.5			-5		+5	
57.6			-5		+5	
57.7			-5		+5	
57.8			-5		+5	
57.9			-5		+5	
58.0			-5		+5	
58.1			-5		+5	
58.2			-5		+5	
58.3			-5		+5	
58.4			-5		+5	
58.5			-5		+5	
58.6			-5		+5	
58.7			-5		+5	
58.8			-5		+5	
58.9			-5		+5	
59.0			-5		+5	
59.1			-5		+5	
59.2			-5		+5	
59.3			-5		+5	
59.4			-5		+5	
59.5			-5		+5	
59.6			-5		+5	

6.2.2 Performance Verification Test Record Sheets

Test Data			Specification			Result
Frequency (GHz)	Calibrated value (dBm)	Measured value (dBm)	Min. (dB)	Actual value (dB)	Max. (dB)	Pass/Fail
59.7			-5		+5	
59.8			-5		+5	
59.9			-5		+5	
60.0			-5		+5	

### 6.3 External Mixer OPT18

#### (1) Introduction

This chapter provides OPT3172/3182+18 external mixer performance verification test procedures, item by item as listed on Table 6-5.

Performance verification will be carried out under following condition.

Temperature range: 20 °C to 30 °C

Relative Humidity: 85 % or less

**Table 6-5 List of Performance Verification Test Items**

No.	Test Description	Applicable Models
1	Noise Level	OPT3172/3182+18
2	Frequency Response	OPT3172/3182+18

#### (2) Test Equipment

Table 6-6 lists equipment for the performance verification test.

The equipment needed to perform all of the performance test.

Equipment lists for individual tests are provided in each performance verification test procedure.

**Table 6-6 Equipment List for Performance Verification Test**

No.	Description	Critical Specifications for substitute Model	Model Recommended	Manufacturer	Notes
1	Sweeper	No substitute model recommended	83640	Agilent Technologies	SG
2	Source Module	No substitute model recommended	83557A	Agilent Technologies	-
3	10 dB Fixed Attenuator	No substitute model recommended	521V	MPI	-
4	RF Power Sensor	No substitute model recommended	V8486A	Agilent Technologies	-
5	RF Power Meter	No substitute model recommended	437B	Agilent Technologies	-
6	RF Cable	Type: SMA(m)-SMA(m)	DCP-FF00092X02	Advantest	-
7	Spectrum Analyzer	No substitute model recommended	R3172/R3182	Advantest	-

---

**NOTE:**

1. *The R3172/R3182 to be tested should be warmed up for at least 30 minutes before starting tests. Any additional equipment used for this performance verification tests should be warmed up as appropriate.*
  2. *Make sure that the test equipment used meets its own published specifications and that all connectors are clean, before starting test.*
  3. *Any equipment that meets critical specifications given in the Table can be substituted for recommended models.*
- 

(3) Calibration Cycle

The performance verifications should be used to check the external mixer against its specifications every once a year recommended.

(4) Performance Verification Test Record Sheets

The performance verification test record sheets at the end of this chapter are provided the value measured in each performance verification.

The test record lists test specification and acceptable limits.

Performance verification test record sheets for each option is provided at end of this manual.

Recommend that make a copy of these sheets, record the complete test results on the copy, and keep the copy for calibration test record.

This record could prove invaluable in tracking gradual changes in test result over long periods of the time.

(5) Conventions Used in this Manual

The following conventions are used in this manual.

- Panel keys and soft keys are printed in a contrasting typeface to make them stand out from the text as follows:

Panel keys: Boldface type                      Example: **FREQ, FORMAT**

Soft keys: Boldface and italic type Example: ***Center, Trace Detector***

- When a series of key operations are described using a comma between two keys.
- There are various soft menus used to switch between two states such as ON/OFF and AUTO/MNL

For example, when turning off the ***Display ON/OFF*** function, the annotation "***Display ON/OFF(OFF)***" is used.

When switching the ***RBW AUTO/MNL*** function to MNL, the annotation "***RBW AUTO/MNL(MNL)***" is used.

### 6.3.1 External Mixer Performance Verification Test Procedures

This section describes the performance verification test procedure listed on Table 6-1.

#### 6.3.1.1 Noise Level

Description:

Verify the external mixer's noise level both frequency range of 50 GHz to 75 GHz and 70 GHz to 80 GHz.

Firstly load the correction data on the backed up floppy disk to R3172/R3182 internal memory. Set the sweeper output to off.

Measure the noise level in the entire frequency range of each external mixer by 500 MHz step.

Specification:

Frequency Range	Noise Level
50 - 75 GHz	$\leq -90$ dBm
70 - 80 GHz	$\leq -88$ dBm

Equipment required:

Sweeper:	83640 (SG)
Source Module:	83557A
10 dB Fixed Attenuator:	521V
RF Cable:	DCP-FF00092X02

Setup

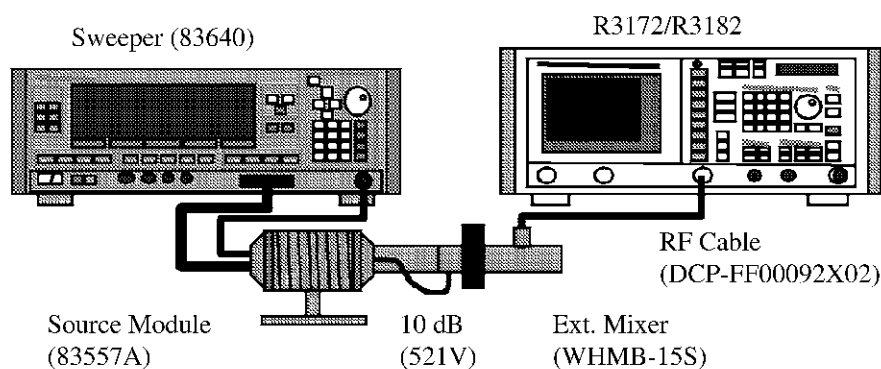

Figure 6-7 Setup of Noise Level Test

Procedure

Part 1 Frequency Range 50 GHz to 75 GHz

1. Connect equipment as shown in Figure 6-7.
2. On the SG set output level to off.

6.3.1 External Mixer Performance Verification Test Procedures

3. On the R3172/R3182, press keys as follows to preset.  
**SHIFT, CONFIG (PRESET)**
4. Insert the correction data floppy disk.
5. On the R3172/R3182, press keys as follows to set FD reading.  
**RECALL, Device, RAM/FD (FD)**
6. Select the "WHM15-1" file by rotating the data knob.
7. On the R3172/R3182, press **RECALL** key to load the correction data.
8. On the R3172/R3182, set controls as follows;  
Frequency Span: Zero  
Reference Level: -40 dBm  
dB/div: 10 dB/div  
RBW: 1 kHz  
VBW: 10 Hz  
Detector: Sample
9. On the R3172/R3182, set control as follow;  
Center Frequency: 50 GHz
10. On the R3172/R3182, press keys as follows to set number of average to 3 times.  
**TRACE, 1/2\_more, AVG A, 3, Hz (ENTER)**  
Wait until the average process has completed
11. On the R3172/R3182, press **PKSRCH** to capture the highest noise signal.
12. Record the level of marker on the performance verification test record sheets.
13. On the R3172/R3182, set control as follow;  
Center Frequency: 50.5 GHz  
Wait until the average process has completed
14. On the R3172/R3182, press **PKSRCH** key to capture the highest noise signal.
15. Record the level of marker on the performance verification test record sheets.
16. Repeat steps 13 through 15 for incrementing the center frequency of 500 MHz step up to 75 GHz.

## Part 2 Frequency Range 70 GHz to 80 GHz

17. On the R3172/R3182, press keys as follows to preset.

**SHIFT, CONFIG (PRESET)**

18. Insert the correction data floppy disk.

19. On the R3172/R3182, press keys as follows to set FD reading.

**RECALL, Device, RAM/FD (FD)**

20. Select the "WHM15-2" file by rotating the data knob.

21. On the R3172/R3182, press **RECALL** key to load the correction data.

22. On the R3172/R3182, set controls as follows;

Frequency Span:	Zero
Reference Level:	-40 dBm
dB/div:	10 dB/div
RBW:	1 kHz
VBW:	10 Hz
Detector:	Sample

23. On the R3172/R3182, set control as follow;

Center Frequency: 70 GHz

24. On the R3172/R3182, press keys as follows to set number of average to 3 times.

**TRACE, 1/2\_more, AVG A, 3, Hz (ENTER)**

Wait until the average process has completed

25. On the R3172/R3182, press **PKSRCH** to capture the highest noise signal.

26. Record the level of marker on the performance verification test record sheets.

27. On the R3172/R3182, set control as follow;

Center Frequency: 70.5 GHz

Wait until the average process has completed

28. On the R3172/R3182, press **PKSRCH** key to capture the highest noise signal.

29. Record the level of marker on the performance verification test record sheets.

30. Repeat steps 23 through 29 for incrementing the center frequency of 500 MHz step up to 80 GHz.

6.3.1 External Mixer Performance Verification Test Procedures

6.3.1.2 Frequency Response

Description:

Verify the external mixer frequency response against specification both frequency range of 50 GHz to 75 GHz and 70 GHz to 80 GHz.

Firstly measure the source module out power with RF power meter and RF power sensor in the entire frequency range by 100 MHz step, and record it as calibrated value.

Secondary connect external mixer to the source module, and then measure the frequency response on the R3172/R3182 screen in the entire frequency range by 100 MHz step, and record it as measured value.

Calculate between the calibrated value and measured value for the frequency response.

Specification:

Frequency Range: 50.0 to 75.0 GHz,  $\pm 5$  dB  
70.0 to 80.0 GHz,  $\pm 5$  dB

Equipment required:

- Sweeper: 83640
- Source Module: 83557A
- 10 dB Fixed Attenuator: 521V
- RF Cable: DCP-FF00092X02
- RF Power Meter: 437B
- RF Power Sensor: V8486A

Setup

Source Module Calibration

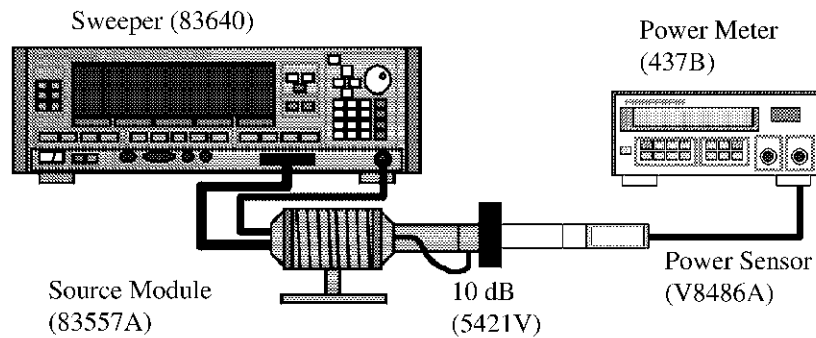

Figure 6-8 Setup of Source Module Calibration



## Frequency Response

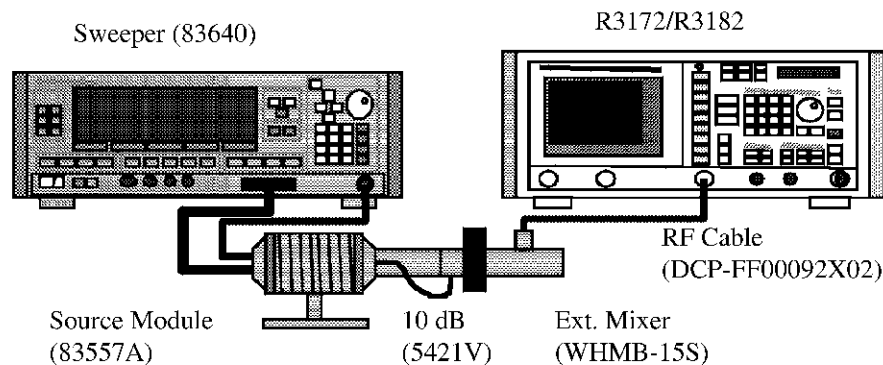

Figure 6-9 Setup of Frequency Response Test

## Procedure

## Part 1 Source Module Calibration

1. On the RF power meter, perform ZERO and calibration with the RF power sensor.
2. Connect equipment as shown in Figure 6-8.
3. On the SG, set controls as follows;
  - Output Frequency: 50.0 GHz
  - Output Level: 0 dBm
4. On the RF power meter set correction data for 50.0 GHz.
5. Measure the source module output level, and then record it in calibrated value column on the performance verification test record sheets.
6. On the SG, set control as follow;
  - Output Frequency: 50.1 GHz
7. On the RF power meter set correction data for 50.1 GHz.
8. Measure the source module output level, and then record it in calibrated value column on the performance verification test record sheets.
9. Repeat steps 6 through 8 for the SG output frequency and RF power meter correction data up to 80 GHz by 100 MHz steps.

## Part 2 Frequency Response Test (Frequency Range: 50 GHz to 75 GHz)

10. Connect equipment as shown in Figure 6-7.
11. Insert the correction data floppy disk.

6.3.1 External Mixer Performance Verification Test Procedures

12. On the R3172/R3182, press keys as follows to set FD reading.  
**RECALL, Device, RAM/FD (FD)**
13. Select the “WHM15-1” file by rotating the data knob.
14. On the R3172/R3182, press **RECALL** key to load the correction data.
15. On the R3172/R3182, set controls as follows;  
Center Frequency: 50.0 GHz  
Span: 40 MHz  
Reference Level: 0 dBm  
dB/div: 10dB/div  
RBW: 300kHz  
VBW: 3kHz  
Detector: Sample
16. On the SG, set controls as follows;  
Output Frequency: 50.0 GHz  
Output Level: 0 dBm
17. On the R3172/3182, press **SINGLE** key for a sweep.
18. On the R3172/R3182, press **PKSRCH** key to capture the signal peak.
19. Record the level of peak marker in the measured value column on the performance verification test data sheets.
20. Calculate actual value using following equation.  
$$\text{Actual Value} = \text{Abs (Calibrated value)} - \text{Abs (Measured value)}$$
21. Record the result in the actual value column on the performance verification test data sheets.
22. On the R3172/R3182, set control as follow;  
Center Frequency: 50.1 GHz
23. On the SG, set control as follow;  
Output Frequency: 50.1 GHz
24. On the R3172/3182, press **SINGLE** key for a sweep.
25. On the R3172/R3182, press **PKSRCH** key to capture the signal peak.
26. Record the level of peak marker in the measured value column on the performance verification test data sheets.

## 6.3.1 External Mixer Performance Verification Test Procedures

27. Calculate actual value using following equation.

$$\text{Actual Value} = \text{Abs (Calibrated value)} - \text{Abs (Measured value)}$$

28. Record the result in the actual value column on the performance verification test data sheets.
29. Repeat steps 22 through 28 for the frequency setting both of R3172/R3182 center frequency and SG output frequency up-to 75 GHz step by 100 MHz.

## Part 3 Frequency Response Test (Frequency Range: 70 GHz to 80 GHz)

30. Insert the correction data floppy disk.

31. On the R3172/R3182, press keys as follows to set FD reading.

**RECALL, Device, RAM/FD (FD)**

32. Select the "WHM15-2" file by rotating the data knob.

33. On the R3172/R3182, press **RECALL** key to load the correction data.

34. On the R3172/R3182, set controls as follows;

Center Frequency:	70.0 GHz
Span:	40 MHz
Reference Level:	0 dBm
dB/div:	10dB/div
RBW:	300kHz
VBW:	3kHz
Detector:	Sample

35. On the SG, set controls as follows;

Output Frequency:	70.0 GHz
Output Level:	0 dBm

36. On the R3172/3182, press **SINGLE** key for a sweep.

37. On the R3172/R3182, press **PKSRCH** key to capture the signal peak.

38. Record the level of peak marker in the measured value column on the performance verification test data sheets.

39. Calculate actual value using following equation.

$$\text{Actual Value} = \text{Abs (Calibrated value)} - \text{Abs (Measured value)}$$

40. Record the result in the actual value column on the performance verification test data sheets.

6.3.1 External Mixer Performance Verification Test Procedures

41. On the R3172/R3182, set control as follow;  
Center Frequency: 70.1 GHz
42. On the SG, set control as follow;  
Output Frequency: 70.1 GHz
43. On the R3172/3182, press **SINGLE** key for a sweep.
44. On the R3172/R3182, press **PKSRCH** key to capture the signal peak.
45. Record the level of peak marker in the measured value column on the performance verification test data sheets.
46. Calculate actual value using following equation.  
$$\text{Actual Value} = \text{Abs (Calibrated value)} - \text{Abs (Measured value)}$$
47. Record the result in the actual value column on the performance verification test data sheets.
48. Repeat steps 41 through 47 for the frequency setting both of R3172/R3182 center
49. frequency and SG output frequency up-to 80 GHz step by 100 MHz.

**6.3.2 Performance Verification Test Record Sheets*****Performance Verification Test Record Sheets***

Model: OPT3172/3182+18

Date:

Serial Number:

## (1) Noise Level

Frequency Range: 50 GHz to 75 GHz

Test Data Frequency (GHz)	Specification			Result Pass/Fail
	Min. (dBm)	Measured value (dBm)	Max. (dBm)	
50.0	NA		-90	
50.5	NA		-90	
51.0	NA		-90	
51.5	NA		-90	
52.0	NA		-90	
52.5	NA		-90	
53.0	NA		-90	
53.5	NA		-90	
54.0	NA		-90	
54.5	NA		-90	
55.0	NA		-90	
55.5	NA		-90	
56.0	NA		-90	
56.5	NA		-90	
57.0	NA		-90	
57.5	NA		-90	
58.0	NA		-90	
58.5	NA		-90	
59.0	NA		-90	
59.5	NA		-90	
60.0	NA		-90	
60.5	NA		-90	
61.0	NA		-90	
61.5	NA		-90	
62.0	NA		-90	
62.5	NA		-90	
63.0	NA		-90	
63.5	NA		-90	
64.0	NA		-90	

6.3.2 Performance Verification Test Record Sheets

Test Data	Specification			Result
Frequency (GHz)	Min. (dBm)	Measured value (dBm)	Max. (dBm)	Pass/Fail
64.5	NA		-90	
65.0	NA		-90	
65.5	NA		-90	
66.0	NA		-90	
66.5	NA		-90	
67.0	NA		-90	
67.5	NA		-90	
68.0	NA		-90	
68.5	NA		-90	
69.0	NA		-90	
69.5	NA		-90	
70.0	NA		-90	
70.5	NA		-90	
71.0	NA		-90	
71.5	NA		-90	
72.0	NA		-90	
72.5	NA		-90	
73.0	NA		-90	
73.5	NA		-90	
74.0	NA		-90	
74.5	NA		-90	
75.0	NA		-90	

Frequency Range: 70 GHz to 80 GHz

Test Data	Specification			Result
Frequency (GHz)	Min. (dBm)	Measured value (dBm)	Max. (dBm)	Pass/Fail
70.0	NA		-88	
70.5	NA		-88	
71.0	NA		-88	
71.5	NA		-88	
72.0	NA		-88	
72.5	NA		-88	
73.0	NA		-88	
73.5	NA		-88	
74.0	NA		-88	
74.5	NA		-88	
75.0	NA		-88	
75.5	NA		-88	
76.0	NA		-88	
76.5	NA		-88	
77.0	NA		-88	
77.5	NA		-88	
78.0	NA		-88	
78.5	NA		-88	
79.0	NA		-88	
79.5	NA		-88	
80.0	NA		-88	

6.3.2 Performance Verification Test Record Sheets

(2) Frequency Response

Frequency Range: 50 GHz to 75 GHz

Test Data			Specification			Result
Frequency (GHz)	Calibrated value (dBm)	Measured value (dBm)	Min. (dB)	Actual value (dB)	Max. (dB)	Pass/Fail
50.0			-5		+5	
50.1			-5		+5	
50.2			-5		+5	
50.3			-5		+5	
50.4			-5		+5	
50.5			-5		+5	
50.6			-5		+5	
50.7			-5		+5	
50.8			-5		+5	
50.9			-5		+5	
51.0			-5		+5	
51.1			-5		+5	
51.2			-5		+5	
51.3			-5		+5	
51.4			-5		+5	
51.5			-5		+5	
51.6			-5		+5	
51.7			-5		+5	
51.8			-5		+5	
51.9			-5		+5	
52.0			-5		+5	
52.1			-5		+5	
52.2			-5		+5	
52.3			-5		+5	
52.4			-5		+5	
52.5			-5		+5	
52.6			-5		+5	
52.7			-5		+5	
52.8			-5		+5	
52.9			-5		+5	
53.0			-5		+5	
53.1			-5		+5	
53.2			-5		+5	
53.3			-5		+5	
53.4			-5		+5	



Test Data			Specification			Result
Frequency (GHz)	Calibrated value (dBm)	Measured value (dBm)	Min. (dB)	Actual value (dB)	Max. (dB)	Pass/Fail
53.5			-5		+5	
53.6			-5		+5	
53.7			-5		+5	
53.8			-5		+5	
53.9			-5		+5	
54.0			-5		+5	
54.1			-5		+5	
54.2			-5		+5	
54.3			-5		+5	
54.4			-5		+5	
54.5			-5		+5	
54.6			-5		+5	
54.7			-5		+5	
54.8			-5		+5	
54.9			-5		+5	
55.0			-5		+5	
55.1			-5		+5	
55.2			-5		+5	
55.3			-5		+5	
55.4			-5		+5	
55.5			-5		+5	
55.6			-5		+5	
55.7			-5		+5	
55.8			-5		+5	
55.9			-5		+5	
56.0			-5		+5	
56.1			-5		+5	
56.2			-5		+5	
56.3			-5		+5	
56.4			-5		+5	
56.5			-5		+5	
56.6			-5		+5	
56.7			-5		+5	
56.8			-5		+5	
56.9			-5		+5	
57.0			-5		+5	
57.1			-5		+5	

6.3.2 Performance Verification Test Record Sheets

Test Data			Specification			Result
Frequency (GHz)	Calibrated value (dBm)	Measured value (dBm)	Min. (dB)	Actual value (dB)	Max. (dB)	Pass/Fail
57.2			-5		+5	
57.3			-5		+5	
57.4			-5		+5	
57.5			-5		+5	
57.6			-5		+5	
57.7			-5		+5	
57.8			-5		+5	
57.9			-5		+5	
58.0			-5		+5	
58.1			-5		+5	
58.2			-5		+5	
58.3			-5		+5	
58.4			-5		+5	
58.5			-5		+5	
58.6			-5		+5	
58.7			-5		+5	
58.8			-5		+5	
58.9			-5		+5	
59.0			-5		+5	
59.1			-5		+5	
59.2			-5		+5	
59.3			-5		+5	
59.4			-5		+5	
59.5			-5		+5	
59.6			-5		+5	
59.7			-5		+5	
59.8			-5		+5	
59.9			-5		+5	
60.0			-5		+5	
60.1			-5		+5	
60.2			-5		+5	
60.3			-5		+5	
60.4			-5		+5	
60.5			-5		+5	
60.6			-5		+5	
60.7			-5		+5	
60.8			-5		+5	

## 6.3.2 Performance Verification Test Record Sheets

Test Data			Specification			Result
Frequency (GHz)	Calibrated value (dBm)	Measured value (dBm)	Min. (dB)	Actual value (dB)	Max. (dB)	Pass/Fail
60.9			-5		+5	
61.0			-5		+5	
61.1			-5		+5	
61.2			-5		+5	
61.3			-5		+5	
61.4			-5		+5	
61.5			-5		+5	
61.6			-5		+5	
61.7			-5		+5	
61.8			-5		+5	
61.9			-5		+5	
62.0			-5		+5	
62.1			-5		+5	
62.2			-5		+5	
62.3			-5		+5	
62.4			-5		+5	
62.5			-5		+5	
62.6			-5		+5	
62.7			-5		+5	
62.8			-5		+5	
62.9			-5		+5	
63.0			-5		+5	
63.1			-5		+5	
63.2			-5		+5	
63.3			-5		+5	
63.4			-5		+5	
63.5			-5		+5	
63.6			-5		+5	
63.7			-5		+5	
63.8			-5		+5	
63.9			-5		+5	
64.0			-5		+5	
64.1			-5		+5	
64.2			-5		+5	
64.3			-5		+5	
64.4			-5		+5	
64.5			-5		+5	

6.3.2 Performance Verification Test Record Sheets

Test Data			Specification			Result
Frequency (GHz)	Calibrated value (dBm)	Measured value (dBm)	Min. (dB)	Actual value (dB)	Max. (dB)	Pass/Fail
64.6			-5		+5	
64.7			-5		+5	
64.8			-5		+5	
64.9			-5		+5	
65.0			-5		+5	
65.1			-5		+5	
65.2			-5		+5	
65.3			-5		+5	
65.4			-5		+5	
65.5			-5		+5	
65.6			-5		+5	
65.7			-5		+5	
65.8			-5		+5	
65.9			-5		+5	
66.0			-5		+5	
66.1			-5		+5	
66.2			-5		+5	
66.3			-5		+5	
66.4			-5		+5	
66.5			-5		+5	
66.6			-5		+5	
66.7			-5		+5	
66.8			-5		+5	
66.9			-5		+5	
67.0			-5		+5	
67.1			-5		+5	
67.2			-5		+5	
67.3			-5		+5	
67.4			-5		+5	
67.5			-5		+5	
67.6			-5		+5	
67.7			-5		+5	
67.8			-5		+5	
67.9			-5		+5	
68.0			-5		+5	
68.1			-5		+5	
68.2			-5		+5	

## 6.3.2 Performance Verification Test Record Sheets

Test Data			Specification			Result
Frequency (GHz)	Calibrated value (dBm)	Measured value (dBm)	Min. (dB)	Actual value (dB)	Max. (dB)	Pass/Fail
68.3			-5		+5	
68.4			-5		+5	
68.5			-5		+5	
68.6			-5		+5	
68.7			-5		+5	
68.8			-5		+5	
68.9			-5		+5	
69.0			-5		+5	
69.1			-5		+5	
69.2			-5		+5	
69.3			-5		+5	
69.4			-5		+5	
69.5			-5		+5	
69.6			-5		+5	
69.7			-5		+5	
69.8			-5		+5	
69.9			-5		+5	
70.0			-5		+5	
70.1			-5		+5	
70.2			-5		+5	
70.3			-5		+5	
70.4			-5		+5	
70.5			-5		+5	
70.6			-5		+5	
70.7			-5		+5	
70.8			-5		+5	
70.9			-5		+5	
71.0			-5		+5	
71.1			-5		+5	
71.2			-5		+5	
71.3			-5		+5	
71.4			-5		+5	
71.5			-5		+5	
71.6			-5		+5	
71.7			-5		+5	
71.8			-5		+5	
71.9			-5		+5	

6.3.2 Performance Verification Test Record Sheets

Test Data			Specification			Result
Frequency (GHz)	Calibrated value (dBm)	Measured value (dBm)	Min. (dB)	Actual value (dB)	Max. (dB)	Pass/Fail
72.0			-5		+5	
72.1			-5		+5	
72.2			-5		+5	
72.3			-5		+5	
72.4			-5		+5	
72.5			-5		+5	
72.6			-5		+5	
72.7			-5		+5	
72.8			-5		+5	
72.9			-5		+5	
73.0			-5		+5	
73.1			-5		+5	
73.2			-5		+5	
73.3			-5		+5	
73.4			-5		+5	
73.5			-5		+5	
73.6			-5		+5	
73.7			-5		+5	
73.8			-5		+5	
73.9			-5		+5	
74.0			-5		+5	
74.1			-5		+5	
74.2			-5		+5	
74.3			-5		+5	
74.4			-5		+5	
74.5			-5		+5	
74.6			-5		+5	
74.7			-5		+5	
74.8			-5		+5	
74.9			-5		+5	
75.0			-5		+5	

Frequency Range: 70 GHz to 80 GHz

Test Data			Specification			Result
Frequency (GHz)	Calibrated value (dBm)	Measured value (dBm)	Min. (dB)	Actual value (dB)	Max. (dB)	Pass/Fail
70.0			-5		+5	
70.1			-5		+5	
70.2			-5		+5	
70.3			-5		+5	
70.4			-5		+5	
70.5			-5		+5	
70.6			-5		+5	
70.7			-5		+5	
70.8			-5		+5	
70.9			-5		+5	
71.0			-5		+5	
71.1			-5		+5	
71.2			-5		+5	
71.3			-5		+5	
71.4			-5		+5	
71.5			-5		+5	
71.6			-5		+5	
71.7			-5		+5	
71.8			-5		+5	
71.9			-5		+5	
72.0			-5		+5	
72.1			-5		+5	
72.2			-5		+5	
72.3			-5		+5	
72.4			-5		+5	
72.5			-5		+5	
72.6			-5		+5	
72.7			-5		+5	
72.8			-5		+5	
72.9			-5		+5	
73.0			-5		+5	
73.1			-5		+5	
73.2			-5		+5	
73.3			-5		+5	
73.4			-5		+5	
73.5			-5		+5	

6.3.2 Performance Verification Test Record Sheets

Test Data			Specification			Result
Frequency (GHz)	Calibrated value (dBm)	Measured value (dBm)	Min. (dB)	Actual value (dB)	Max. (dB)	Pass/Fail
73.6			-5		+5	
73.7			-5		+5	
73.8			-5		+5	
73.9			-5		+5	
74.0			-5		+5	
74.1			-5		+5	
74.2			-5		+5	
74.3			-5		+5	
74.4			-5		+5	
74.5			-5		+5	
74.6			-5		+5	
74.7			-5		+5	
74.8			-5		+5	
74.9			-5		+5	
75.0			-5		+5	
75.1			-5		+5	
75.2			-5		+5	
75.3			-5		+5	
75.4			-5		+5	
75.5			-5		+5	
75.6			-5		+5	
75.7			-5		+5	
75.8			-5		+5	
75.9			-5		+5	
76.0			-5		+5	
76.1			-5		+5	
76.2			-5		+5	
76.3			-5		+5	
76.4			-5		+5	
76.5			-5		+5	
76.6			-5		+5	
76.7			-5		+5	
76.8			-5		+5	
76.9			-5		+5	
77.0			-5		+5	
77.1			-5		+5	
77.2			-5		+5	



Test Data			Specification			Result
Frequency (GHz)	Calibrated value (dBm)	Measured value (dBm)	Min. (dB)	Actual value (dB)	Max. (dB)	Pass/Fail
77.3			-5		+5	
77.4			-5		+5	
77.5			-5		+5	
77.6			-5		+5	
77.7			-5		+5	
77.8			-5		+5	
77.9			-5		+5	
78.0			-5		+5	
78.1			-5		+5	
78.2			-5		+5	
78.3			-5		+5	
78.4			-5		+5	
78.5			-5		+5	
78.6			-5		+5	
78.7			-5		+5	
78.8			-5		+5	
78.9			-5		+5	
79.0			-5		+5	
79.1			-5		+5	
79.2			-5		+5	
79.3			-5		+5	
79.4			-5		+5	
79.5			-5		+5	
79.6			-5		+5	
79.7			-5		+5	
79.8			-5		+5	
79.9			-5		+5	
80.0			-5		+5	

6.4 External Mixer OPT19

**6.4 External Mixer OPT19**

(1) Introduction

This chapter provides OPT3172/3182+19 external mixer performance verification test procedures, item by item as listed on Table 6-7.

Performance verification will be carried out under following condition.

Temperature range: 20 °C to 30 °C

Relative Humidity: 85 % or less

**Table 6-7 List of Performance Verification Test Items**

No.	Test Description	Applicable Models
1	Noise Level	OPT3172/3182+19
2	Frequency Response	OPT3172/3182+19

(2) Test Equipment

Table 6-8 lists equipment for the performance verification test.

The equipment needed to perform all of the performance test.

Equipment lists for individual tests are provided in each performance verification test procedure.

**Table 6-8 Equipment List for Performance Verification Test**

No.	Description	Critical Specifications for substitute Model	Model Recommended	Manufacturer	Notes
1	Sweeper	No substitute model recommended	83640	Agilent Technologies	SG
2	Source Module	No substitute model recommended	83558A	Agilent Technologies	-
3	10 dB Fixed Attenuator	No substitute model recommended	521W	MPI	-
4	RF Power Sensor	No substitute model recommended	W8486A	Agilent Technologies	-
5	RF Power Meter	No substitute model recommended	437B	Agilent Technologies	-
6	RF Cable	Type: SMA(m)-SMA(m)	DCP-FF00092X02	Advantest	-
7	Spectrum Analyzer	No substitute model recommended	R3172/R3182	Advantest	-

---

**NOTE:**

1. *The R3172/R3182 to be tested should be warmed up for at least 30 minutes before starting tests. Any additional equipment used for this performance verification tests should be warmed up as appropriate.*
  2. *Make sure that the test equipment used meets its own published specifications and that all connectors are clean, before starting test.*
  3. *Any equipment that meets critical specifications given in the Table can be substituted for recommended models.*
- 

## (3) Calibration Cycle

The performance verifications should be used to check the external mixer against its specifications every once a year recommended.

## (4) Performance Verification Test Record Sheets

The performance verification test record sheets at the end of this chapter are provided the value measured in each performance verification.

The test record lists test specification and acceptable limits.

Performance verification test record sheets for each option is provided at end of this manual.

Recommend that make a copy of these sheets, record the complete test results on the copy, and keep the copy for calibration test record.

This record could prove invaluable in tracking gradual changes in test result over long periods of the time.

## (5) Conventions Used in this Manual

The following conventions are used in this manual.

- Panel keys and soft keys are printed in a contrasting typeface to make them stand out from the text as follows:

Panel keys: Boldface type            Example: **FREQ, FORMAT**

Soft keys: Boldface and italic type Example: ***Center, Trace Detector***

- When a series of key operations are described using a comma between two keys.
- There are various soft menus used to switch between two states such as ON/OFF and AUTO/MNL.

For example, when turning off the *Display ON/OFF* function, the annotation "***Display ON/OFF***(OFF)" is used.

When switching the ***RBW AUTO/MNL*** function to MNL, the annotation "***RBW AUTO/MNL***(MNL)" is used.

6.4.1 External Mixer Performance Verification Test Procedures

**6.4.1 External Mixer Performance Verification Test Procedures**

This section describes the performance verification test procedure listed on Table 6-1.

**6.4.1.1 Noise Level**

Description:

Verify the external mixer's noise level.

Firstly load the correction data on the backed up floppy disk to R3172/R3182 internal memory.

Set the sweeper output to off.

Measure the noise level in ht entire frequency range of each external mixer by 500 MHz step.

Specification:

Frequency Range	Noise Level
75 - 85 GHz	≤ -85 dBm
85 - 110 GHz	≤ -80 dBm

Equipment required:

Sweeper: 83640 (SG)

Source Module: 83558A

10 dB Fixed Attenuator: 521W

RF Cable: DCP-FF00092X02

Spectrum Analyzer: R3172/R3182

Setup

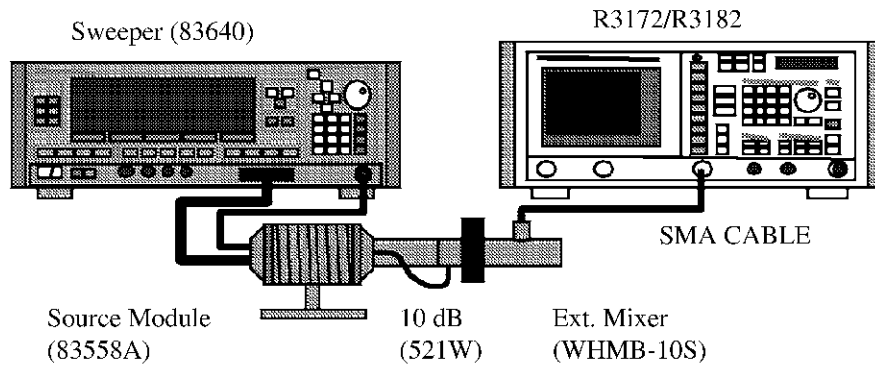

**Figure 6-10 Setup of Noise Level Test**

Procedure

1. Connect equipment as shown in Figure 6-10.
2. On the SG set output level to off.

## 6.4.1 External Mixer Performance Verification Test Procedures

3. On the R3172/R3182, press keys as follows to preset.

**SHIFT, CONFIG (PRESET)**

4. Insert the correction data floppy disk.

5. On the R3172/R3182, press keys as follows to set FD reading.

**RECALL, Device, RAM/FD (FD)**

6. Select the "WHMB10" file by rotating the data knob.

7. On the R3172/R3182, press **RECALL** key to load the correction data.

8. On the R3172/R3182, set controls as follows;

Frequency Span:	Zero
Reference Level:	-40 dBm
dB/div:	10 dB/div
RBW:	1 kHz
VBW:	10 Hz
Detector:	Sample

9. On the R3172/R3182, set control as follow;

Center Frequency: 75 GHz

10. On the R3172/R3182, press keys as follows to set number of average to 3 times.

**TRACE, 1/2\_more, AVG A, 3, Hz (ENTER)**

Wait until the average process has completed

11. On the R3172/R3182, press **PKSRCH** to capture the highest noise signal.

12. Record the level of marker on the performance verification test record sheets.

13. On the R3172/R3182, set control as follow;

Center Frequency: 75.5 GHz

Wait until the average process has completed

14. On the R3172/R3182, press **PKSRCH** key to capture the highest noise signal.

15. Record the level of marker on the performance verification test record sheets.

16. Repeat steps 13 through 15 for incrementing the center frequency of 500 MHz step up to 110 GHz.

6.4.1 External Mixer Performance Verification Test Procedures

6.4.1.2 Frequency Response

Description:

Verify the external mixer frequency response against specification.

Firstly measure the source module out power with RF power meter and RF power sensor in the entire frequency range by 100 MHz step, and record it as calibrated value.

Secondary connect external mixer to the source module, and then measure the frequency response on the R3172/R3182 screen in the entire frequency range by 100 MHz step, and record it as measured value.

Calculate between the calibrated value and measured value for the frequency response.

Specification:

Frequency Range: 75.0 to 110.0 GHz,  $\pm 5$  dB

Equipment required:

Sweeper: 83640 (SG)

Source Modtule: 83558A

10 dB Fixed Attenuator: 521W

RF Cable: DCP-FF00092X02

RF Power Meter: 437B

RF Power Sensor: W8486A

Spectrum Analyzer: R3172/R3182

Setup

Source Module Calibration

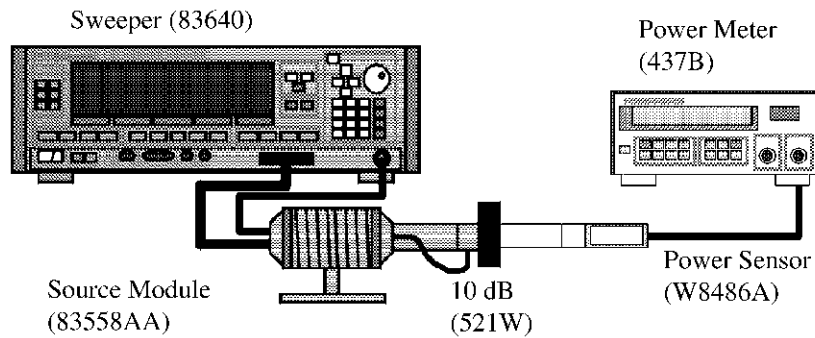

Figure 6-11 Setup of Source Module Calibration

## Frequency Response

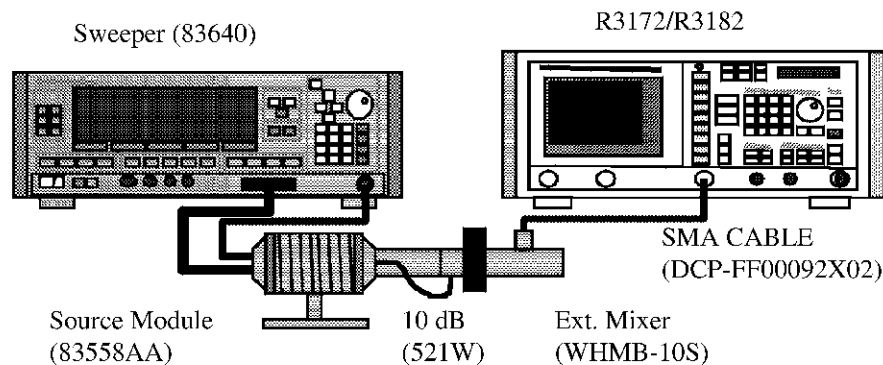

Figure 6-12 Setup of Frequency Response Test

## Procedure

## Part 1 Source Module Calibration

1. On the RF power meter, perform ZERO and calibration with the RF power sensor.
2. Connect equipment as shown in Figure 6-11.
3. On the SG, set controls as follows;
 

Output Frequency:	75.0 GHz
Output Level:	0 dBm
4. On the RF power meter set correction data for 75.0 GHz.
5. Measure the source module output level, and then record it in reference column on the performance verification test record sheets.
6. On the SG, set control as follow;
 

Output Frequency:	75.1 GHz
-------------------	----------
7. On the RF power meter set correction data for 75.1 GHz.
8. Measure the source module output level, and then record it in reference column on the performance verification test record sheets.
9. Repeat steps 6 through 8 for the SG output frequency and RF power meter correction data up to 110 GHz by 100 MHz steps.

## Part 2 Frequency Response Test

10. Connect equipment as shown in Figure 6-11.

6.4.1 External Mixer Performance Verification Test Procedures

11. On the R3172/R3182, press keys as follows to preset.

**SHIFT, CONFIG (PRESET)**

12. On the R3172/R3182, set controls as follows;

Center Frequency: 75.0 GHz  
Span: 40 MHz  
Reference Level: 0 dBm  
dB/div: 10dB/div  
RBW: 300kHz  
VBW: 3kHz  
Detector: Sample

13. On the SG, set controls as follows;

Output Frequency: 75.0 GHz  
Output Level: 0 dBm

14. On the R3172/3182, press **SINGLE** key for a sweep.

15. On the R3172/R3182, press **PKSRCH** key to capture the signal peak.

16. Record the level of peak marker in the measured value column on the performance verification test data sheets.

17. Calculate actual value using following equation.

$$\text{Actual Value} = \text{Abs (Calibrated value)} - \text{Abs (Measured value)}$$

18. Record the result in the actual value column on the performance verification test data sheets.

19. On the R3172/R3182, set control as follow;

Center Frequency: 75.1 GHz

20. On the SG, set control as follow;

Output Frequency: 75.1 GHz

21. On the R3172/3182, press **SINGLE** key for a sweep.

22. On the R3172/R3182, press **PKSRCH** key to capture the signal peak.

23. Record the level of peak marker in the measured value column on the performance verification test data sheets.

24. Calculate actual value using following equation.

$$\text{Actual Value} = \text{Abs (Calibrated value)} - \text{Abs (Measured value)}$$



6.4.1 External Mixer Performance Verification Test Procedures

25. Record the result in the actual value column on the performance verification test data sheets.
26. Repeat steps 19 through 25 for the frequency setting both of R3172/R3182 center frequency and SG output frequency up-to 110 GHz step by 100 MHz.

6.4.2 Performance Verification Test Record Sheets

6.4.2 Performance Verification Test Record Sheets

***Performance Verification Test Record Sheets***

Model: OPT3172/3182+19

Date:

Serial Number:

(1) Noise Level

Test Data	Specification			Result
Frequency (GHz)	Min. (dBm)	Measured value (dBm)	Max. (dBm)	Pass/Fail
75.0	NA		-85	
75.5	NA		-85	
76.0	NA		-85	
76.5	NA		-85	
77.0	NA		-85	
77.5	NA		-85	
78.0	NA		-85	
78.5	NA		-85	
79.0	NA		-85	
79.5	NA		-85	
80.0	NA		-85	
80.5	NA		-85	
81.0	NA		-85	
81.5	NA		-85	
82.0	NA		-85	
82.5	NA		-85	
83.0	NA		-85	
83.5	NA		-85	
84.0	NA		-85	
84.5	NA		-85	
85.0	NA		-80	
85.5	NA		-80	
86.0	NA		-80	
86.5	NA		-80	
87.0	NA		-80	
87.5	NA		-80	
88.0	NA		-80	
88.5	NA		-80	
89.0	NA		-80	
89.5	NA		-80	

Test Data	Specification			Result
Frequency (GHz)	Min. (dBm)	Measured value (dBm)	Max. (dBm)	Pass/Fail
90.0	NA		-80	
90.5	NA		-80	
91.0	NA		-80	
91.5	NA		-80	
92.0	NA		-80	
92.5	NA		-80	
93.0	NA		-80	
93.5	NA		-80	
94.0	NA		-80	
94.5	NA		-80	
95.0	NA		-80	
95.5	NA		-80	
96.0	NA		-80	
96.5	NA		-80	
97.0	NA		-80	
97.5	NA		-80	
98.0	NA		-80	
98.5	NA		-80	
99.0	NA		-80	
99.5	NA		-80	
100.0	NA		-80	
100.5	NA		-80	
101.0	NA		-80	
101.5	NA		-80	
102.0	NA		-80	
102.5	NA		-80	
103.0	NA		-80	
103.5	NA		-80	
104.0	NA		-80	
104.5	NA		-80	
105.0	NA		-80	
105.5	NA		-80	
106.0	NA		-80	
106.5	NA		-80	
107.0	NA		-80	
107.5	NA		-80	
108.0	NA		-80	

6.4.2 Performance Verification Test Record Sheets

Test Data	Specification			Result
Frequency (GHz)	Min. (dBm)	Measured value (dBm)	Max. (dBm)	Pass/Fail
108.5	NA		-80	
109.0	NA		-80	
109.5	NA		-80	
110.0	NA		-80	

(2) Frequency Response

Test Data			Specification			Result
Frequency (GHz)	Calibrated value (dBm)	Measured value (dBm)	Min. (dB)	Actual value (dB)	Max. (dB)	Pass/Fail
75.0			-5		+5	
75.1			-5		+5	
75.2			-5		+5	
75.3			-5		+5	
75.4			-5		+5	
75.5			-5		+5	
75.6			-5		+5	
75.7			-5		+5	
75.8			-5		+5	
75.9			-5		+5	
76.0			-5		+5	
76.1			-5		+5	
76.2			-5		+5	
76.3			-5		+5	
76.4			-5		+5	
76.5			-5		+5	
76.6			-5		+5	
76.7			-5		+5	
76.8			-5		+5	
76.9			-5		+5	
77.0			-5		+5	
77.1			-5		+5	
77.2			-5		+5	
77.3			-5		+5	
77.4			-5		+5	
77.5			-5		+5	
77.6			-5		+5	
77.7			-5		+5	

Test Data			Specification			Result
Frequency (GHz)	Calibrated value (dBm)	Measured value (dBm)	Min. (dB)	Actual value (dB)	Max. (dB)	Pass/Fail
77.8			-5		+5	
77.9			-5		+5	
78.0			-5		+5	
78.1			-5		+5	
78.2			-5		+5	
78.3			-5		+5	
78.4			-5		+5	
78.5			-5		+5	
78.6			-5		+5	
78.7			-5		+5	
78.8			-5		+5	
78.9			-5		+5	
79.0			-5		+5	
79.1			-5		+5	
79.2			-5		+5	
79.3			-5		+5	
79.4			-5		+5	
79.5			-5		+5	
79.6			-5		+5	
79.7			-5		+5	
79.8			-5		+5	
79.9			-5		+5	
80.0			-5		+5	
80.1			-5		+5	
80.2			-5		+5	
80.3			-5		+5	
80.4			-5		+5	
80.5			-5		+5	
80.6			-5		+5	
80.7			-5		+5	
80.8			-5		+5	
80.9			-5		+5	
81.0			-5		+5	
81.1			-5		+5	
81.2			-5		+5	
81.3			-5		+5	
81.4			-5		+5	

6.4.2 Performance Verification Test Record Sheets

Test Data			Specification			Result
Frequency (GHz)	Calibrated value (dBm)	Measured value (dBm)	Min. (dB)	Actual value (dB)	Max. (dB)	Pass/Fail
81.5			-5		+5	
81.6			-5		+5	
81.7			-5		+5	
81.8			-5		+5	
81.9			-5		+5	
82.0			-5		+5	
82.1			-5		+5	
82.2			-5		+5	
82.3			-5		+5	
82.4			-5		+5	
82.5			-5		+5	
82.6			-5		+5	
82.7			-5		+5	
82.8			-5		+5	
82.9			-5		+5	
83.0			-5		+5	
83.1			-5		+5	
83.2			-5		+5	
83.3			-5		+5	
83.4			-5		+5	
83.5			-5		+5	
83.6			-5		+5	
83.7			-5		+5	
83.8			-5		+5	
83.9			-5		+5	
84.0			-5		+5	
84.1			-5		+5	
84.2			-5		+5	
84.3			-5		+5	
84.4			-5		+5	
84.5			-5		+5	
84.6			-5		+5	
84.7			-5		+5	
84.8			-5		+5	
84.9			-5		+5	
85.0			-5		+5	
85.1			-5		+5	

Test Data			Specification			Result
Frequency (GHz)	Calibrated value (dBm)	Measured value (dBm)	Min. (dB)	Actual value (dB)	Max. (dB)	Pass/Fail
85.2			-5		+5	
85.3			-5		+5	
85.4			-5		+5	
85.5			-5		+5	
85.6			-5		+5	
85.7			-5		+5	
85.8			-5		+5	
85.9			-5		+5	
86.0			-5		+5	
86.1			-5		+5	
86.2			-5		+5	
86.3			-5		+5	
86.4			-5		+5	
86.5			-5		+5	
86.6			-5		+5	
86.7			-5		+5	
86.8			-5		+5	
86.9			-5		+5	
87.0			-5		+5	
87.1			-5		+5	
87.2			-5		+5	
87.3			-5		+5	
87.4			-5		+5	
87.5			-5		+5	
87.6			-5		+5	
87.7			-5		+5	
87.8			-5		+5	
87.9			-5		+5	
88.0			-5		+5	
88.1			-5		+5	
88.2			-5		+5	
88.3			-5		+5	
88.4			-5		+5	
88.5			-5		+5	
88.6			-5		+5	
88.7			-5		+5	
88.8			-5		+5	

6.4.2 Performance Verification Test Record Sheets

Test Data			Specification			Result
Frequency (GHz)	Calibrated value (dBm)	Measured value (dBm)	Min. (dB)	Actual value (dB)	Max. (dB)	Pass/Fail
88.9			-5		+5	
89.0			-5		+5	
89.1			-5		+5	
89.2			-5		+5	
89.3			-5		+5	
89.4			-5		+5	
89.5			-5		+5	
89.6			-5		+5	
89.7			-5		+5	
89.8			-5		+5	
89.9			-5		+5	
90.0			-5		+5	
90.1			-5		+5	
90.2			-5		+5	
90.3			-5		+5	
90.4			-5		+5	
90.5			-5		+5	
90.6			-5		+5	
90.7			-5		+5	
90.8			-5		+5	
90.9			-5		+5	
91.0			-5		+5	
91.1			-5		+5	
91.2			-5		+5	
91.3			-5		+5	
91.4			-5		+5	
91.5			-5		+5	
91.6			-5		+5	
91.7			-5		+5	
91.8			-5		+5	
91.9			-5		+5	
92.0			-5		+5	
92.1			-5		+5	
92.2			-5		+5	
92.3			-5		+5	
92.4			-5		+5	
92.5			-5		+5	



Test Data			Specification			Result
Frequency (GHz)	Calibrated value (dBm)	Measured value (dBm)	Min. (dB)	Actual value (dB)	Max. (dB)	Pass/Fail
92.6			-5		+5	
92.7			-5		+5	
92.8			-5		+5	
92.9			-5		+5	
93.0			-5		+5	
93.1			-5		+5	
93.2			-5		+5	
93.3			-5		+5	
93.4			-5		+5	
93.5			-5		+5	
93.6			-5		+5	
93.7			-5		+5	
93.8			-5		+5	
93.9			-5		+5	
94.0			-5		+5	
94.1			-5		+5	
94.2			-5		+5	
94.3			-5		+5	
94.4			-5		+5	
94.5			-5		+5	
94.6			-5		+5	
94.7			-5		+5	
94.8			-5		+5	
94.9			-5		+5	
95.0			-5		+5	
95.1			-5		+5	
95.2			-5		+5	
95.3			-5		+5	
95.4			-5		+5	
95.5			-5		+5	
95.6			-5		+5	
95.7			-5		+5	
95.8			-5		+5	
95.9			-5		+5	
96.0			-5		+5	
96.1			-5		+5	
96.2			-5		+5	

6.4.2 Performance Verification Test Record Sheets

Test Data			Specification			Result
Frequency (GHz)	Calibrated value (dBm)	Measured value (dBm)	Min. (dB)	Actual value (dB)	Max. (dB)	Pass/Fail
96.3			-5		+5	
96.4			-5		+5	
96.5			-5		+5	
96.6			-5		+5	
96.7			-5		+5	
96.8			-5		+5	
96.9			-5		+5	
97.0			-5		+5	
97.1			-5		+5	
97.2			-5		+5	
97.3			-5		+5	
97.4			-5		+5	
97.5			-5		+5	
97.6			-5		+5	
97.7			-5		+5	
97.8			-5		+5	
97.9			-5		+5	
98.0			-5		+5	
98.1			-5		+5	
98.2			-5		+5	
98.3			-5		+5	
98.4			-5		+5	
98.5			-5		+5	
98.6			-5		+5	
98.7			-5		+5	
98.8			-5		+5	
98.9			-5		+5	
99.0			-5		+5	
99.1			-5		+5	
99.2			-5		+5	
99.3			-5		+5	
99.4			-5		+5	
99.5			-5		+5	
99.6			-5		+5	
99.7			-5		+5	
99.8			-5		+5	
99.9			-5		+5	

Test Data			Specification			Result
Frequency (GHz)	Calibrated value (dBm)	Measured value (dBm)	Min. (dB)	Actual value (dB)	Max. (dB)	Pass/Fail
100.0			-5		+5	
100.1			-5		+5	
100.2			-5		+5	
100.3			-5		+5	
100.4			-5		+5	
100.5			-5		+5	
100.6			-5		+5	
100.7			-5		+5	
100.8			-5		+5	
100.9			-5		+5	
101.0			-5		+5	
101.1			-5		+5	
101.2			-5		+5	
101.3			-5		+5	
101.4			-5		+5	
101.5			-5		+5	
101.6			-5		+5	
101.7			-5		+5	
101.8			-5		+5	
101.9			-5		+5	
102.0			-5		+5	
102.1			-5		+5	
102.2			-5		+5	
102.3			-5		+5	
102.4			-5		+5	
102.5			-5		+5	
102.6			-5		+5	
102.7			-5		+5	
102.8			-5		+5	
102.9			-5		+5	
103.0			-5		+5	
103.1			-5		+5	
103.2			-5		+5	
103.3			-5		+5	
103.4			-5		+5	
103.5			-5		+5	
103.6			-5		+5	

6.4.2 Performance Verification Test Record Sheets

Test Data			Specification			Result
Frequency (GHz)	Calibrated value (dBm)	Measured value (dBm)	Min. (dB)	Actual value (dB)	Max. (dB)	Pass/Fail
103.7			-5		+5	
103.8			-5		+5	
103.9			-5		+5	
104.0			-5		+5	
104.1			-5		+5	
104.2			-5		+5	
104.3			-5		+5	
104.4			-5		+5	
104.5			-5		+5	
104.6			-5		+5	
104.7			-5		+5	
104.8			-5		+5	
104.9			-5		+5	
105.0			-5		+5	
105.1			-5		+5	
105.2			-5		+5	
105.3			-5		+5	
105.4			-5		+5	
105.5			-5		+5	
105.6			-5		+5	
105.7			-5		+5	
105.8			-5		+5	
105.9			-5		+5	
106.0			-5		+5	
106.1			-5		+5	
106.2			-5		+5	
106.3			-5		+5	
106.4			-5		+5	
106.5			-5		+5	
106.6			-5		+5	
106.7			-5		+5	
106.8			-5		+5	
106.9			-5		+5	
107.0			-5		+5	
107.1			-5		+5	
107.2			-5		+5	
107.3			-5		+5	

Test Data			Specification			Result
Frequency (GHz)	Calibrated value (dBm)	Measured value (dBm)	Min. (dB)	Actual value (dB)	Max. (dB)	Pass/Fail
107.4			-5		+5	
107.5			-5		+5	
107.6			-5		+5	
107.7			-5		+5	
107.8			-5		+5	
107.9			-5		+5	
108.0			-5		+5	
108.1			-5		+5	
108.2			-5		+5	
108.3			-5		+5	
108.4			-5		+5	
108.5			-5		+5	
108.6			-5		+5	
108.7			-5		+5	
108.8			-5		+5	
108.9			-5		+5	
109.0			-5		+5	
109.1			-5		+5	
109.2			-5		+5	
109.3			-5		+5	
109.4			-5		+5	
109.5			-5		+5	
109.6			-5		+5	
109.7			-5		+5	
109.8			-5		+5	
109.9			-5		+5	
110.0			-5		+5	



## 7 SPECIFICATIONS

### 7.1 R3132 Specifications

#### (1) Frequency

Characteristics	Specification
Frequency range	9 kHz to 3 GHz
Frequency readout accuracy (Start, Stop, CF, Marker)	$\pm$ (Frequency readout $\times$ freq. reference accuracy + SPAN $\times$ 1% + RBW $\times$ 15% + 60 Hz)
Count frequency marker Resolution Count Accuracy	1 Hz to 1 kHz $\pm$ (Marker frequency $\times$ freq. reference accuracy + 1LSD) (S/N $\geq$ 25dB, SPAN $\leq$ 200MHz)
Frequency reference Aging Temperature stability	$\pm 2 \times 10^{-6}$ /year $\pm 1 \times 10^{-5}$ (from 0°C to 50°C)
Frequency span Range Accuracy	1 kHz to 3 GHz and 0 Hz (zero span) $\pm 1\%$ of Span
Residual FM Zero Span	$\leq 60$ Hz p-p/100ms
Noise Sidebands	freq. $\leq 2.6$ GHz $\leq -100$ dBc/Hz at 10 kHz offset (RBW 300 Hz OPT27) $\leq -105$ dBc/Hz at 20 kHz offset freq. $> 2.6$ GHz $\leq -98$ dBc/Hz at 10 kHz offset (RBW 300 Hz OPT27) $\leq -103$ dBc/Hz at 20 kHz offset
Resolution Bandwidth At 3 dB: Range RBW Accuracy  Selectivity (60 dB : 3 dB) QP (at 6 dB) Range:	1 kHz to 3 MHz 1-3-10 sequence $\pm 20\%$ from 1 kHz to 1 MHz $\pm 25\%$ for 3 MHz $< 15 : 1$ 1 MHz, 120 kHz, 9 kHz
Video Bandwidth	10 Hz to 3 MHz (1-3-10 sequence)

## 7.1 R3132 Specifications

## (2) Amplitude Range

Characteristics	Specification
Measurement range	+30 dBm to displayed Average Noise Level
Maximum input level Preamplifier OFF	(Input attenuator $\geq 10$ dB) +30 dBm $\pm 50$ VDC max.
Preamplifier ON	+13 dBm $\pm 50$ VDC max.
Display range Log	$10 \times 10$ div 10, 5, 2, 1 dB/div
Linear	10% of reference level/div
Reference level range Preamplifier OFF	(Input attenuator 0 to 50 dB)
Log	-64 dBm to +40 dBm (0.1 dB step)
Linear	141.1 $\mu$ V to +22.36 V
Preamplifier ON	(Input attenuator 0 to 30 dB)
Log	-82 dBm to +10 dBm (0.1 dB step)
Linear	17.76 $\mu$ V to 707.1 mV
Input attenuator range	0 to 50 dB (5 dB step)

## (3) Sweep

Characteristics	Specification
Sweep time	20ms to 1000s
Sweep time Accuracy	$\pm 2\%$
Trigger mode	FREE RUN, LINE, VIDEO, EXT, TV
Sweep Mode	REPEAT, SINGLE



## (4) Dynamic Range

Characteristics	Specification
Displayed Average Noise Level Preamplifier OFF Preamplifier ON	with RBW 1 kHz, VBW 10 Hz and input attenuator 0 dB, $f \geq 10$ MHz -117 dBm + 2f (GHz)dB *1 -132 dBm + 3f (GHz)dB
Gain compression (1 dB) Preamplifier OFF Preamplifier ON	frequency $\geq 200$ MHz > 0 dBm (mixer input level) > -25 dBm (RF input level)
Spurious Response Second harmonic distortion  Third order intermodulation distortion	Preamplifier OFF, Mixer level -30 dBm $\leq -70$ dBc      freq = 100 MHz to 800 MHz $\leq -80$ dBc      freq $\geq 800$ MHz $\leq -80$ dBc      freq $\geq 200$ MHz, 2-signal difference > 50 kHz
Residual responses Preamplifier OFF Preamplifier ON	(input terminated 50 $\Omega$ , input attenuator 0 dB, freq $\geq 1$ MHz) $\leq -100$ dBm $\leq -105$ dBm

\*1 For a temperature range of 20°C to 30°C. Add 2 dB for a temperature range of 0°C to 50°C.

## (5) Amplitude Accuracy

Characteristics	Specification
Frequency Response Preamplifier OFF  Preamplifier ON	(after Calibration, Att = 10 dB) $\pm 0.5$ dB    (100 kHz to 3 GHz) *2 $\pm 2$ dB      (9 kHz to 3 GHz) $\pm 1$ dB      (100 kHz to 2.7 GHz) $\pm 2$ dB      (9 kHz to 3 GHz)
Calibration Signal Accuracy	-20 dBm $\pm 0.3$ dB
IF Gain Error	(after automatic calibration) $\pm 0.5$ dB
Scale Fidelity Log  Linear	(after automatic calibration) $\pm 1$ dB/10 dB $\pm 1.5$ dB/90 dB $\pm 0.2$ dB/1 dB $\pm 5\%$ of reference level
Input attenuator switching accuracy	$\pm 0.3$ dB (0 to 50dB settings) in reference to an attenuation of 10 dB at 30 MHz
Resolution bandwidth switching uncertainty	(after automatic calibration) $\pm 0.5$ dB
Overall level accuracy	$\pm 1.5$ dB (REF = -50 to 0 dBm, ATT = 10 dB, 2 dB/div, RBW = 300 kHz, $f > 100$ kHz, after automatic calibration)

\*2 For a temperature range of 20°C to 30°C. Add 0.5 dB for a temperature range of 0°C to 50°C.

7.1 R3132 Specifications

(6) Input and Output

Characteristics	Specification
RF input Connector Impedance VSWR / Preamp OFF  VSWR / Preamp ON	N type 50Ω (nominal) < 1.5 : 1 (100 kHz to 2 GHz) (characteristic value) with input attenuator 10 dB to 50 dB < 2 : 1 (9 kHz to 3 GHz) (characteristic value) with input attenuator 5 dB to 50 dB < 2.5 : 1 (9 kHz to 3 GHz) (characteristic value)
Probe power	±12 V (nominal), 4-pin connector
Calibration output signal	BNC female, 50Ω (nominal) 30 MHz, -20 dBm
10MHz reference input	BNC female, 500Ω (nominal) -10 dBm to +10 dBm
External trigger input	BNC female
Phone output	Small size monophonic female
GPIB interface	IEEE-488 bus connector
Serial interface	D-Sub 9pins
Printer interface	D-Sub 25pins, ESC/P, ESC/P-R, PCL
Video output	VGA (15 pins, female)
Floppy drive	3.5 inch, MS-DOS format

(7) General Specifications

Characteristics	Specification
Operating environment range	0°C to +50°C Relative humidity 85% or less (without condensation)
Storage environment range	-20°C to +60°C Relative humidity 85% or less
AC input power source	Automatic switching to 100 VAC or 200 VAC For 100 VAC: 100 to 120 VAC, 50 to 60 Hz For 200 VAC: 220 to 240 VAC, 50 to 60 Hz
Power consumption	< 200 VA
Mass	< 14kg
Dimensions	Approximately 424(W) × 177(H) × 300(D) mm (not including projections such as rubber feet and connectors)

## 7.2 R3132N Specifications

### (1) Frequency

Characteristics	Specification
Frequency range	9 kHz to 3.0 GHz
Frequency readout accuracy (Start, Stop, CF, Marker)	$\pm$ (Frequency readout $\times$ freq. reference accuracy + SPAN $\times$ 1% + RBW $\times$ 15% + 60 Hz)
Count frequency marker Resolution Count Accuracy	1 Hz to 1 kHz $\pm$ (Marker frequency $\times$ freq. reference accuracy + 1LSD) (S/N $\geq$ 25dB, SPAN $\leq$ 200MHz)
Frequency reference Aging Temperature stability	$\pm 2 \times 10^{-6}$ /year $\pm 1 \times 10^{-5}$ (from 0°C to 50°C)
Frequency span Range Accuracy	1 kHz to 3 GHz and 0 Hz (zero span) $\pm 1\%$ of Span
Residual FM Zero Span	$\leq 60$ Hz p-p/100ms
Noise Sidebands	freq. $\leq 2.6$ GHz $\leq -100$ dBc/Hz at 10 kHz offset (RBW 300 Hz OPT27) $\leq -105$ dBc/Hz at 20 kHz offset freq. $> 2.6$ GHz $\leq -98$ dBc/Hz at 10 kHz offset (RBW 300 Hz OPT27) $\leq -103$ dBc/Hz at 20 kHz offset
Resolution Bandwidth At 3 dB: Range RBW Accuracy  Selectivity (60 dB : 3 dB) QP (at 6 dB) Range:	1 kHz to 3 MHz 1-3-10 sequence $\pm 20\%$ from 1 kHz to 1 MHz $\pm 25\%$ for 3 MHz $< 15 : 1$ 1 MHz, 120 kHz, 9 kHz
Video Bandwidth	10 Hz to 3 MHz (1-3-10 sequence)

## 7.2 R3132N Specifications

## (2) Amplitude Range

Characteristics	Specification
Measurement range	+134 dB $\mu$ V to displayed Average Noise Level
Maximum input level Preamplifier OFF	(Input attenuator $\geq$ 10 dB) +134 dB $\mu$ V $\pm$ 50 VDC max.
Preamplifier ON	+120 dB $\mu$ V $\pm$ 50 VDC max.
Display range Log	10 $\times$ 10 div 10, 5, 2, 1 dB/div
Linear	10% of reference level/div
Reference level range Preamplifier OFF	(Input attenuator 0 to 50 dB)
Log	+44.8 dB $\mu$ V to +148.8 dB $\mu$ V (0.1 dB step)
Linear	172.8 $\mu$ V to +27.39 V
Preamplifier ON	(Input attenuator 0 to 30 dB)
Log	+26.8 dB $\mu$ V to +118.8 dB $\mu$ V (0.1 dB step)
Linear	21.75 $\mu$ V to 866 mV
Input attenuator range	0 to 50 dB (5 dB step)

## (3) Sweep

Characteristics	Specification
Sweep time	20ms to 1000s
Sweep time Accuracy	$\pm$ 2%
Trigger mode	FREE RUN, LINE, VIDEO, EXT, TV
Sweep Mode	REPEAT, SINGLE

## (4) Dynamic Range

Characteristics	Specification
Displayed Average Noise Level Preamplifier OFF Preamplifier ON	with RBW 1 kHz, VBW 10 Hz and input attenuator 0 dB, $f \geq 10$ MHz -6 dB $\mu$ V + 2f (GHz)dB *1 -21 dB $\mu$ V + 3f (GHz)dB
Gain compression (1 dB) Preamplifier OFF Preamplifier ON	frequency $\geq 200$ MHz > +107 dB $\mu$ V (mixer input level) > +82 dB $\mu$ V (RF input level)
Spurious Response Second harmonic distortion  Third order intermodulation distortion	Preamplifier OFF, Mixer level +77 dB $\mu$ V $\leq -70$ dBc      freq = 100 MHz to 800 MHz $\leq -80$ dBc      freq $\geq 800$ MHz $\leq -80$ dBc      freq $\geq 200$ MHz, 2-signal difference > 50 kHz
Residual responses Preamplifier OFF Preamplifier ON	(input terminated 75 $\Omega$ , input attenuator 0 dB) $\leq +11$ dB $\mu$ V $\leq +6$ dB $\mu$ V

\*1 For a temperature range of 20°C to 30°C. Add 2 dB for a temperature range of 0°C to 50°C.

## (5) Amplitude Accuracy

Characteristics	Specification
Frequency Response Preamplifier OFF  Preamplifier ON	(after Calibration, Att = 10 dB) $\pm 0.5$ dB    (100 kHz to 2.2 GHz) *2 $\pm 2$ dB      (9 kHz to 2.2 GHz) $\pm 1$ dB      (100 kHz to 2.2 GHz) $\pm 2$ dB      (9 kHz to 2.2 GHz)
Calibration Signal Accuracy	-20 dBm $\pm 0.3$ dB
IF Gain Error	(after automatic calibration) $\pm 0.5$ dB
Scale Fidelity Log  Linear	(after automatic calibration) $\pm 1$ dB/10 dB $\pm 1.5$ dB/90 dB $\pm 0.2$ dB/1 dB $\pm 5\%$ of reference level
Input attenuator switching accuracy	$\pm 0.3$ dB (0 to 50dB settings) in reference to an attenuation of 10 dB at 30 MHz
Resolution bandwidth switching uncertainty	(after automatic calibration) $\pm 0.5$ dB
Overall level accuracy	$\pm 1.5$ dB (REF = -50 to 0 dBm, ATT = 10 dB, 2 dB/div, RBW = 300 kHz, $f = 100$ kHz to 2.2 GHz, after automatic calibration)

\*2 For a temperature range of 20°C to 30°C. Add 0.5 dB for a temperature range of 0°C to 50°C.

7.2 R3132N Specifications

(6) Input and Output

Characteristics	Specification
RF input Connector Impedance VSWR / Preamp OFF  VSWR / Preamp ON	N type 75Ω (nominal) < 1.5 : 1 (100 kHz to 2.2 GHz) (characteristic value) with input attenuator. 10 dB to 50 dB < 2 : 1 (9 kHz to 2.2 GHz) (characteristic value) with input attenuator. 5 dB to 50 dB < 2.5 : 1 (9 kHz to 2.2 GHz) (characteristic value)
Probe power	±12 V (nominal), 4-pin connector
Calibration output signal	BNC female, 75Ω (nominal) 30 MHz, -20 dBm
10MHz reference input	BNC female, 500Ω (nominal) -10 dBm to +10 dBm
External trigger input	BNC female
Phone output	Small size monophonic female
GPIB interface	IEEE-488 bus connector
Serial interface	D-Sub 9pins
Printer interface	D-Sub 25pins, ESC/P, ESC/P-R, PCL
Video output	VGA (15 pins, female)
Floppy drive	3.5 inch, MS-DOS format

(7) General Specifications

Characteristics	Specification
Operating environment range	0°C to +50°C Relative humidity 85% or less (without condensation)
Storage environment range	-20°C to +60°C, Relative humidity 85% or less
AC input power source	Automatic switching to 100 VAC or 200 VAC For 100 VAC: 100 to 120 VAC, 50 to 60 Hz For 200 VAC: 220 to 240 VAC, 50 to 60 Hz
Power consumption	< 200 VA
Mass	< 14kg
Dimensions	Approximately 424(W) × 177(H) × 300(D) mm (not including projections such as rubber feet and connectors)



## 7.3 R3162 Specifications

## (2) Amplitude Range

Characteristics	Specification
Measurement range	+30 dBm to displayed Average Noise Level
Maximum input level Preamplifier OFF	(Input attenuator $\geq 10$ dB) +30 dBm 0 VDC max.
Preamplifier ON	+13 dBm 0 VDC max.
Display range Log	10 $\times$ 10 div 10, 5, 2, 1 dB/div
Linear	10% of reference level/div
Reference level range Preamplifier OFF	(Input attenuator 0 to 75 dB)
Log	-64 dBm to +65 dBm (0.1 dB step)
Linear	141.1 $\mu$ V to 397.63 V
Preamplifier ON	(Input attenuator 0 to 30 dB)
Log	-82 dBm to +10 dBm (0.1 dB step)
Linear	17.76 $\mu$ V to 707.1 mV
Input attenuator range	0 to 75 dB (5 dB step)

## (3) Sweep

Characteristics	Specification
Sweep time	20ms to 1000s
Sweep time Accuracy	$\pm 2\%$
Trigger mode	FREE RUN, LINE, VIDEO, EXT, TV
Sweep Mode	REPEAT, SINGLE



## (4) Dynamic Range

Characteristics	Specification												
Displayed Average Noise Level Preamplifier OFF  Preamplifier ON	with RBW 1 kHz, VBW 10 Hz and input attenuator 0 dB, $f \geq 10$ MHz band 0: $-117 \text{ dBm} + 2f \text{ (GHz)dB} *1$ band 1-: $-115 \text{ dBm} + 0.5f \text{ (GHz)dB} *1$ band 1+: $-115 \text{ dBm} + 0.5f \text{ (GHz)dB} *1$ $-132 \text{ dBm} + 3f \text{ (GHz)dB}$ Freq. Range 1 MHz to 3.3 GHz												
Gain compression (1 dB) Preamplifier OFF Preamplifier ON	frequency $\geq 200$ MHz > 0 dBm (mixer input level) > -25 dBm (RF input level)												
Spurious Response Second harmonic distortion  Third order intermodulation distortion  Image/Multiple/Out-of-band response	Preamplifier OFF <table border="1"> <thead> <tr> <th>Freq. range</th> <th>Mixer level</th> <th>Distortion level</th> </tr> </thead> <tbody> <tr> <td>100 MHz to 800 MHz</td> <td>-30 dBm</td> <td><math>\leq -70 \text{ dBc}</math></td> </tr> <tr> <td><math>\geq 800</math> MHz (band 0)</td> <td>-30 dBm</td> <td><math>\leq -80 \text{ dBc}</math></td> </tr> <tr> <td><math>\geq 3.3</math> GHz</td> <td>-10 dBm</td> <td><math>\leq -100 \text{ dBc}</math></td> </tr> </tbody> </table> $\leq -80 \text{ dBc}$ (Mixer input level -30 dBm, 2-signal difference > 50 kHz $f \geq 200$ MHz) $< -70 \text{ dBc}$ up to 8 GHz	Freq. range	Mixer level	Distortion level	100 MHz to 800 MHz	-30 dBm	$\leq -70 \text{ dBc}$	$\geq 800$ MHz (band 0)	-30 dBm	$\leq -80 \text{ dBc}$	$\geq 3.3$ GHz	-10 dBm	$\leq -100 \text{ dBc}$
Freq. range	Mixer level	Distortion level											
100 MHz to 800 MHz	-30 dBm	$\leq -70 \text{ dBc}$											
$\geq 800$ MHz (band 0)	-30 dBm	$\leq -80 \text{ dBc}$											
$\geq 3.3$ GHz	-10 dBm	$\leq -100 \text{ dBc}$											
Residual responses	(input terminated 50 $\Omega$ , input attenuator 0 dB) <table border="1"> <thead> <tr> <th></th> <th>band 0</th> <th>band 1-, 1+</th> </tr> </thead> <tbody> <tr> <td>Preamplifier OFF</td> <td><math>\leq -100 \text{ dBm}</math></td> <td><math>\leq -90 \text{ dBm}</math></td> </tr> <tr> <td>Preamplifier ON</td> <td><math>\leq -105 \text{ dBm}</math></td> <td>not applicable</td> </tr> </tbody> </table>		band 0	band 1-, 1+	Preamplifier OFF	$\leq -100 \text{ dBm}$	$\leq -90 \text{ dBm}$	Preamplifier ON	$\leq -105 \text{ dBm}$	not applicable			
	band 0	band 1-, 1+											
Preamplifier OFF	$\leq -100 \text{ dBm}$	$\leq -90 \text{ dBm}$											
Preamplifier ON	$\leq -105 \text{ dBm}$	not applicable											

\*1 For a temperature range of 20°C to 30°C. Add 2 dB for a temperature range of 0°C to 50°C.

7.3 R3162 Specifications

(5) Amplitude Accuracy

Characteristics	Specification
Frequency Response Preamplifier OFF	(after Calibration and Preselector peak, Att = 10 dB) ±0.5 dB (100 kHz to 3 GHz) *2 ±2 dB (9 kHz to 3.3 GHz)
Preamplifier ON	±2 dB (3.2 GHz to 8 GHz) ±1 dB (100 kHz to 2.7 GHz) ±2 dB (9 kHz to 3.3 GHz)
Calibration Signal Accuracy	-20 dBm ±0.3dB
IF Gain Error	(after automatic calibration) ±0.5 dB
Scale Fidelity Log	(after automatic calibration) ±1 dB/10 dB ±1.5 dB/90 dB ±0.2 dB/1 dB
Linear	± 5% of reference level
Input attenuator switching accuracy	±0.3 dB (0 to 50dB settings) in reference to an attenuation of 10 dB at 30 MHz
Resolution bandwidth switching uncertainty	(after automatic calibration) ±0.5 dB
Overall level accuracy	±1.5dB (REF = -50 to 0 dBm, ATT = 10 dB, 2 dB/div, RBW = 300 kHz, f = 100kHz to 3 GHz, after automatic calibration)

\*2 For a temperature range of 20°C to 30°C. Add 0.5 dB for a temperature range of 0°C to 50°C.

## (6) Input and Output

Characteristics	Specification
RF input Connector Impedance VSWR / Preamp OFF  VSWR / Preamp ON	N type 50 $\Omega$ (nominal) < 2 : 1 (9 kHz to 3.3 GHz) (characteristic value) < 2 : 1 (3.2 GHz to 8 GHz) (characteristic value) with input attenuator 10 dB to 75 dB < 2.5 : 1 (9 kHz to 3.3 GHz) (characteristic value)
Probe power	$\pm 12$ V (nominal), 4-pin connector
Calibration output signal	BNC female, 50 $\Omega$ (nominal) 30 MHz, -20 dBm
10MHz reference input	BNC female, 500 $\Omega$ (nominal) -10 dBm to +10 dBm
External trigger input	BNC female
Phone output	Small size monophonic female
GPIB interface	IEEE-488 bus connector
Serial interface	D-Sub 9pins
Printer interface	D-Sub 25pins, ESC/P, ESC/P-R, PCL
Video output	VGA (15 pins, female)
Floppy drive	3.5 inch, MS-DOS format

## (7) General Specifications

Characteristics	Specification
Operating environment range	0°C to +50°C Relative humidity 85% or less (without condensation)
Storage environment range	-20°C to +60°C, Relative humidity 85% or less
AC input power source	Automatic switching to 100 VAC or 200 VAC For 100 VAC: 100 to 120 VAC, 50 to 60 Hz For 200 VAC: 220 to 240 VAC, 50 to 60 Hz
Power consumption	< 200 VA
Mass	< 15kg
Dimensions	Approximately 424(W) $\times$ 177(H) $\times$ 300(D) mm (not including projections such as rubber feet and connectors)

**7.4 R3172 Specifications**

(1) Frequency

Characteristics	Specification
Frequency range Preamplifier OFF	9kHz to 26.5GHz Harmonic mode (N)
	band 0 : 9 kHz to 3.3 GHz 1
	band 1 : 3.2 GHz to 7.1 GHz 1
	band 2 : 7 GHz to 14.7 GHz 2
	band 3 : 14.5 GHz to 26.5 GHz 4
Preamplifier ON	band 0 : 9 kHz to 3.3 GHz 1
Frequency readout accuracy (Start, Stop, CF, Marker)	$\pm$ (Frequency readout $\times$ freq. reference accuracy + span $\times$ span accuracy + RBW $\times$ 0.15 + 60 Hz)
Count frequency marker Resolution Count Accuracy	1 Hz to 1 kHz $\pm$ (Marker frequency $\times$ freq. reference accuracy + Residual FM + 1LSD) (S/N $\geq$ 25dB, SPAN $\leq$ 200MHz)
Frequency reference Aging Temperature stability	$\pm 2 \times 10^{-6}$ /year $\pm 1 \times 10^{-5}$ (from 0°C to 50°C)
Frequency span Range Accuracy	1 kHz to 26.5 GHz and 0 Hz (zero span) $\pm 1\%$ of Span
Residual FM Zero Span	$\leq (60\text{Hzp-p} \times N)/100\text{ms}$
Noise Sidebands	freq. $\leq$ 2.6GHz $\leq -100$ dBc/Hz at 10 kHz offset (RBW 300 Hz OPT27) $\leq -105$ dBc/Hz at 20 kHz offset freq. $>$ 2.6GHz $\leq (-98 + 20\log N)$ dBc/Hz at 10 kHz offset (RBW 300 Hz OPT27) $\leq (-103 + 20\log N)$ dBc/Hz at 20 kHz offset
Resolution Bandwidth At 3 dB: Range RBW Accuracy Selectivity 60 dB : 3 dB QP (at 6 dB) Range:	1 kHz to 3 MHz 1-3-10 sequence $\pm 20\%$ from 1 kHz to 1 MHz $\pm 25\%$ for 3 MHz $<15 : 1$ 1 MHz, 120 kHz, 9 kHz
Video Bandwidth	10 Hz to 3 MHz (1-3-10 sequence)

## (2) Amplitude Range

Characteristics	Specification
Measurement range	+30 dBm to displayed Average Noise Level
Maximum input level Preamplifier OFF	(Input attenuator $\geq 10$ dB) +30 dBm 0 VDC max.
Preamplifier ON	+13 dBm 0 VDC max.
Display range Log	$10 \times 10$ div 10, 5, 2, 1 dB/div
Linear	10% of reference level/div
Reference level range Preamplifier OFF	(Input attenuator 0 to 70 dB)
Log	-64 dBm to +60 dBm (0.1 dB step)
Linear	141.1 $\mu$ V to +223.6 V
Preamplifier ON	(Input attenuator 0 to 30 dB)
Log	-82 dBm to +10 dBm (0.1 dB step)
Linear	+17.76 $\mu$ V to +707.1 mV
Input attenuator range	0 to 70 dB (10 dB step)

## (3) Sweep

Characteristics	Specification
Sweep time	10ms to 1000s (Sweep time under 20ms can be set up at span 100MHz or less.)
Sweep time Accuracy	$\pm 2\%$
Trigger mode	FREE RUN, LINE, VIDEO, EXT, TV
Sweep Mode	REPEAT, SINGLE

7.4 R3172 Specifications

(4) Dynamic Range

Characteristics	Specification												
Displayed Average Noise Level Preamplifier OFF	with RBW 1 kHz, VBW 10 Hz and input attenuator 0 dB, $f \geq 10$ MHz 10 MHz to 3.3 GHz (band0) : $-117 \text{ dBm} + 2f \text{ (GHz)dB}$ *1 3.2 GHz to 7.1 GHz (band1) : $-112 \text{ dBm}$ *1 7 GHz to 14.7 GHz (band2) : $-111 \text{ dBm}$ *1 14.5 GHz to 22 GHz (band3) : $-107 \text{ dBm}$ *1 22 GHz to 26.5GHz (band3) : $-104 \text{ dBm}$ *1												
Preamplifier ON	1 MHz to 3.3 GHz : $-132 \text{ dBm} + 3f \text{ (GHz)dB}$												
Gain compression (1 dB) Preamplifier OFF Preamplifier ON (Input attenuator 0 to 30dB)	200 MHz to 3.3 GHz (Band 0) : $> 0 \text{ dBm}$ (mixer input level) 3.2 GHz to 26.5 GHz (Band 1 to 3) : $> -5 \text{ dBm}$ (mixer input level) 200 MHz to 3.3 GHz (Band 0) : $> -25 \text{ dBm}$ (RF input level)												
Spurious Response Second harmonic distortion	Preamplifier OFF <table border="1" style="margin-left: 20px;"> <thead> <tr> <th>Freq. range</th> <th>Mixer level</th> <th>Distortion level</th> </tr> </thead> <tbody> <tr> <td>100 MHz to 800 MHz</td> <td>-30 dBm</td> <td><math>\leq -70 \text{ dBc}</math></td> </tr> <tr> <td><math>\geq 800 \text{ MHz}</math> (band 0)</td> <td>-30 dBm</td> <td><math>\leq -80 \text{ dBc}</math></td> </tr> <tr> <td><math>\geq 3.3 \text{ GHz}</math></td> <td>-10 dBm</td> <td><math>\leq -100 \text{ dBc}</math></td> </tr> </tbody> </table>	Freq. range	Mixer level	Distortion level	100 MHz to 800 MHz	-30 dBm	$\leq -70 \text{ dBc}$	$\geq 800 \text{ MHz}$ (band 0)	-30 dBm	$\leq -80 \text{ dBc}$	$\geq 3.3 \text{ GHz}$	-10 dBm	$\leq -100 \text{ dBc}$
Freq. range	Mixer level	Distortion level											
100 MHz to 800 MHz	-30 dBm	$\leq -70 \text{ dBc}$											
$\geq 800 \text{ MHz}$ (band 0)	-30 dBm	$\leq -80 \text{ dBc}$											
$\geq 3.3 \text{ GHz}$	-10 dBm	$\leq -100 \text{ dBc}$											
Third order intermodulation distortion	$\leq -80 \text{ dBc}$ (200MHz to 3.3GHz, band 0) $\leq -70 \text{ dBc}$ (3.2GHz to 26.5GHz, band 1 to 3) (Mixer input level -30dBm, two signal difference $> 50 \text{ kHz}$ )												
Image/Multiple/Out of band response	$\leq -70 \text{ dBc}$ ( $10 \text{ MHz} \leq f \leq 18 \text{ GHz}$ ) $\leq -60 \text{ dBc}$ ( $18 \text{ MHz} < f \leq 23 \text{ GHz}$ ) $\leq -50 \text{ dBc}$ ( $23 \text{ GHz} < f \leq 26.5 \text{ GHz}$ )												
Residual Responses Preamplifier OFF	(input terminated $50\Omega$ , input attenuator 0 dB, $f \geq 1 \text{ MHz}$ ) $\leq -100 \text{ dBm}$ (band 0) $\leq -90 \text{ dBm}$ (band 1 to 3)												
Preamplifier ON	$\leq -105 \text{ dBm}$ (band 0)												

\*1 For a temperature range of 20°C to 30°C. Add 2 dB for a temperature range of 0°C to 50°C.

## (5) Amplitude Accuracy

Characteristics	Specification																																		
Frequency Response Preamplifier OFF	(after Calibration and Preselector peak, Attenuator 10 dB) <table border="1"> <thead> <tr> <th rowspan="2">Frequency range</th> <th colspan="2">Relative</th> <th colspan="2">Absolute *2</th> </tr> <tr> <th>20 to 30°C</th> <th>0 to 50°C</th> <th>20 to 30°C</th> <th>0 to 50°C</th> </tr> </thead> <tbody> <tr> <td>100 kHz to 3 GHz</td> <td>±0.5 dB</td> <td>±1.0 dB</td> <td>±0.6 dB</td> <td>±1.0 dB</td> </tr> <tr> <td>9 kHz to 3.3 GHz</td> <td>±1.5 dB</td> <td>±2.0 dB</td> <td>±1.5 dB</td> <td>±2.0 dB</td> </tr> <tr> <td>3.3 GHz to 7.1 GHz</td> <td>±1.6 dB</td> <td>±1.8 dB</td> <td>±1.8 dB</td> <td>±2.5 dB</td> </tr> <tr> <td>7.1 GHz to 14.7 GHz</td> <td>±1.8 dB</td> <td>±2.0 dB</td> <td>±2.0 dB</td> <td>±3.0 dB</td> </tr> <tr> <td>14.7 GHz to 26.5 GHz</td> <td>±2.5 dB</td> <td>±3.0 dB</td> <td>±3.0 dB</td> <td>±4.0 dB</td> </tr> </tbody> </table>	Frequency range	Relative		Absolute *2		20 to 30°C	0 to 50°C	20 to 30°C	0 to 50°C	100 kHz to 3 GHz	±0.5 dB	±1.0 dB	±0.6 dB	±1.0 dB	9 kHz to 3.3 GHz	±1.5 dB	±2.0 dB	±1.5 dB	±2.0 dB	3.3 GHz to 7.1 GHz	±1.6 dB	±1.8 dB	±1.8 dB	±2.5 dB	7.1 GHz to 14.7 GHz	±1.8 dB	±2.0 dB	±2.0 dB	±3.0 dB	14.7 GHz to 26.5 GHz	±2.5 dB	±3.0 dB	±3.0 dB	±4.0 dB
Frequency range	Relative		Absolute *2																																
	20 to 30°C	0 to 50°C	20 to 30°C	0 to 50°C																															
100 kHz to 3 GHz	±0.5 dB	±1.0 dB	±0.6 dB	±1.0 dB																															
9 kHz to 3.3 GHz	±1.5 dB	±2.0 dB	±1.5 dB	±2.0 dB																															
3.3 GHz to 7.1 GHz	±1.6 dB	±1.8 dB	±1.8 dB	±2.5 dB																															
7.1 GHz to 14.7 GHz	±1.8 dB	±2.0 dB	±2.0 dB	±3.0 dB																															
14.7 GHz to 26.5 GHz	±2.5 dB	±3.0 dB	±3.0 dB	±4.0 dB																															
Preamplifier ON	<table border="1"> <thead> <tr> <th rowspan="2">Frequency range</th> <th colspan="2">Relative</th> <th colspan="2">Absolute *2</th> </tr> <tr> <th>20 to 30°C</th> <th>0 to 50°C</th> <th>20 to 30°C</th> <th>0 to 50°C</th> </tr> </thead> <tbody> <tr> <td>100 kHz to 2.7 GHz</td> <td>±1.0 dB</td> <td>±1.0 dB</td> <td>±1.0 dB</td> <td>±1.0 dB</td> </tr> <tr> <td>9 kHz to 3.3 GHz</td> <td>±2.0 dB</td> <td>±2.0 dB</td> <td>±2.0 dB</td> <td>±2.0 dB</td> </tr> </tbody> </table>	Frequency range	Relative		Absolute *2		20 to 30°C	0 to 50°C	20 to 30°C	0 to 50°C	100 kHz to 2.7 GHz	±1.0 dB	±1.0 dB	±1.0 dB	±1.0 dB	9 kHz to 3.3 GHz	±2.0 dB	±2.0 dB	±2.0 dB	±2.0 dB															
Frequency range	Relative		Absolute *2																																
	20 to 30°C	0 to 50°C	20 to 30°C	0 to 50°C																															
100 kHz to 2.7 GHz	±1.0 dB	±1.0 dB	±1.0 dB	±1.0 dB																															
9 kHz to 3.3 GHz	±2.0 dB	±2.0 dB	±2.0 dB	±2.0 dB																															
Calibration Signal Accuracy	-20 dBm ±0.3dB																																		
IF Gain Error	(after automatic calibration) ±0.5 dB																																		
Scale Fidelity Log  Linear	(after automatic calibration) ±1.5 dB/90 dB ±1.0 dB/10 dB ±0.2 dB/1 dB ±5% of reference level																																		
Input attenuator switching accuracy	≤±1.1 dB/10 dB, 2 dB max. (9 kHz to 12 GHz) ≤±1.3 dB/10 dB, 2.5 dB max. (12 GHz to 18 GHz) ≤±1.8 dB/10 dB, 3.5dB max. (18GHz to 26.5GHz) in reference to an attenuation of 10 dB																																		
Resolution bandwidth switching uncertainty	(after automatic calibration) ±0.5 dB																																		
Overall level accuracy	Preamplifier OFF ±1.5 dB (REF = -50 to 0 dBm, ATT = 10 dB, 2 dB/div, RBW = 300 kHz, f = 100 kHz to 3 GHz, after automatic calibration)																																		

\*2 In reference to 30MHz calibration signal.

## 7.4 R3172 Specifications

## (6) Input and Output

Characteristics	Specification
RF input Connector Impedance VSWR Preamplifier OFF  Preamplifier ON	N female (changeable to SMA female) 50 $\Omega$ (nominal) (at tuned frequency) < 1.5 : 1 (9 kHz to 3.3 GHz, band 0) (characteristic value) < 2 : 1 (3.2 GHz to 26.5 GHz, band 1-3) (characteristic value) with input attenuator 10 dB to 70 dB < 2.5 : 1 (9 kHz to 3.3 GHz, band 0) (characteristic value)
Probe power	$\pm 12$ V (nominal), 4-pin connector
Calibration output signal	BNC female, 50 $\Omega$ (nominal) 30 MHz, -20 dBm
10MHz reference input	BNC female, 500 $\Omega$ (nominal) -10 dBm to +10 dBm
External trigger input	BNC female
Y axis output	BNC female Approximately 2 V in full scale (10 dB/div)
Phone output	Small size monophonic female
GPIB interface	IEEE-488 bus connector
Serial interface	D-Sub 9pins
Printer interface	D-Sub 25pins, ESC/P, ESC/P-R, PCL
Video output	VGA (15 pins, female)
Floppy drive	3.5 inch, MS-DOS format

## (7) General Specifications

Characteristics	Specification
Operating environment range	0°C to +50°C Relative humidity 85% or less (without condensation)
Storage environment range	-20°C to +60°C Relative humidity 85% or less
AC input power source	Automatic switching to 100 VAC or 200 VAC For 100 VAC: 100 to 120 VAC, 50 to 60 Hz For 200 VAC: 220 to 240 VAC, 50 to 60 Hz
Power consumption	< 200 VA
Mass(without option)	< 16kg
Dimensions	Approximately 424(W) $\times$ 177(H) $\times$ 300(D) mm (not including projections such as rubber feet and connectors)



## 7.5 R3182 Specifications

### (1) Frequency

Characteristics	Specification
Frequency range Preamplifier OFF	9kHz to 40GHz Harmonic mode (N)
	band 0 : 9 kHz to 3.3 GHz 1
	band 1 : 3.2 GHz to 7.1 GHz 1
	band 2 : 7 GHz to 14.7 GHz 2
	band 3 : 14.5 GHz to 27 GHz 4
	band 4 : 26.5 GHz to 30 GHz 4
	band 5 : 29.5 GHz to 40 GHz 8
Preamplifier ON	band 0 : 9 kHz to 3.3 GHz 1
Frequency readout accuracy (Start, Stop, CF, Marker)	$\pm$ (Frequency readout $\times$ freq. reference accuracy + span $\times$ span accuracy + RBW $\times$ 0.15 + 60 Hz)
Count frequency marker Resolution Count Accuracy	1 Hz to 1 kHz $\pm$ (Marker frequency $\times$ freq. reference accuracy + Residual FM + 1LSD) (S/N $\geq$ 25dB, SPAN $\leq$ 200MHz)
Frequency reference Aging Temperature stability	$\pm 2 \times 10^{-6}$ /year $\pm 1 \times 10^{-5}$ (from 0°C to 50°C)
Frequency span Range Accuracy	1 kHz to 40 GHz and 0 Hz (zero span) $\pm 1\%$ of Span
Residual FM Zero Span	$\leq (60\text{Hzp-p} \times \text{N})/100\text{ms}$
Noise Sidebands	freq. $\leq$ 2.6GHz $\leq -100$ dBc/Hz at 10 kHz offset (RBW 300 Hz OPT27) $\leq -105$ dBc/Hz at 20 kHz offset freq. $>$ 2.6GHz $\leq (-98 + 20\log\text{N})$ dBc/Hz at 10 kHz offset (RBW 300 Hz OPT27) $\leq (-103 + 20\log\text{N})$ dBc/Hz at 20 kHz offset
Resolution Bandwidth At 3 dB: Range RBW Accuracy Selectivity 60 dB : 3 dB QP (at 6 dB) Range:	1 kHz to 3 MHz 1-3-10 sequence $\pm 20\%$ from 1 kHz to 1 MHz $\pm 25\%$ for 3 MHz $< 15 : 1$ 1 MHz, 120 kHz, 9 kHz
Video Bandwidth	10 Hz to 3 MHz (1-3-10 sequence)

## 7.5 R3182 Specifications

## (2) Amplitude Range

Characteristics	Specification
Measurement range	+30 dBm to displayed Average Noise Level
Maximum input level Preamplifier OFF	(Input attenuator $\geq 10$ dB) +30 dBm 0 VDC max.
Preamplifier ON	+13 dBm 0 VDC max.
Display range Log	$10 \times 10$ div 10, 5, 2, 1 dB/div
Linear	10% of reference level/div
Reference level range Preamplifier OFF	(Input attenuator 0 to 70 dB)
Log	-64 dBm to +60 dBm (0.1 dB step)
Linear	141.1 $\mu$ V to +223.6 V
Preamplifier ON	(Input attenuator 0 to 30 dB)
Log	-82 dBm to +10 dBm (0.1 dB step)
Linear	+17.76 $\mu$ V to +707.1 mV
Input attenuator range	0 to 70 dB (10 dB step)

## (3) Sweep

Characteristics	Specification
Sweep time	10ms to 1000s (Sweep time under 20ms can be set up at span 100MHz or less.)
Sweep time Accuracy	$\pm 2\%$
Trigger mode	FREE RUN, LINE, VIDEO, EXT, TV
Sweep Mode	REPEAT, SINGLE

## (4) Dynamic Range

Characteristics	Specification												
Displayed Average Noise Level Preamplifier OFF	with RBW 1 kHz, VBW 10 Hz and input attenuator 0 dB, $f \geq 10$ MHz 10 MHz to 3.3 GHz (band0) : $-117 \text{ dBm} + 2f \text{ (GHz)dB} \text{ *1}$ 3.2 GHz to 7.1 GHz (band1) : $-114 \text{ dBm} \text{ *1}$ 7 GHz to 14.7 GHz (band2) : $-112 \text{ dBm} \text{ *1}$ 14.5 GHz to 27 GHz (band3) : $-110 \text{ dBm} \text{ *1}$ 26.5 GHz to 30 GHz (band4) : $-107 \text{ dBm} \text{ *1}$ 29.5 GHz to 40 GHz (band5) : $-106 \text{ dBm} \text{ *1}$												
Preamplifier ON	1 MHz to 3.3 GHz : $-132 \text{ dBm} + 3f \text{ (GHz)dB}$												
Gain compression (1 dB) Preamplifier OFF	200 MHz to 3.3 GHz (Band 0) : $> 0 \text{ dBm}$ (mixer input level) 3.2 GHz to 40 GHz (Band 1 to 5) : $> -5 \text{ dBm}$ (mixer input level)												
Preamplifier ON (Input attenuator 0 to 30dB)	200 MHz to 3.3 GHz (Band 0) : $> -25 \text{ dBm}$ (RF input level)												
Spurious Response Second harmonic distortion	Preamplifier OFF <table border="1" style="margin-left: 20px;"> <thead> <tr> <th>Freq. range</th> <th>Mixer level</th> <th>Distortion level</th> </tr> </thead> <tbody> <tr> <td>100 MHz to 800 MHz</td> <td>-30 dBm</td> <td><math>\leq -70 \text{ dBc}</math></td> </tr> <tr> <td><math>\geq 800 \text{ MHz}</math> (band 0)</td> <td>-30 dBm</td> <td><math>\leq -80 \text{ dBc}</math></td> </tr> <tr> <td><math>\geq 3.3 \text{ GHz}</math></td> <td>-10 dBm</td> <td><math>\leq -95 \text{ dBc}</math></td> </tr> </tbody> </table>	Freq. range	Mixer level	Distortion level	100 MHz to 800 MHz	-30 dBm	$\leq -70 \text{ dBc}$	$\geq 800 \text{ MHz}$ (band 0)	-30 dBm	$\leq -80 \text{ dBc}$	$\geq 3.3 \text{ GHz}$	-10 dBm	$\leq -95 \text{ dBc}$
Freq. range	Mixer level	Distortion level											
100 MHz to 800 MHz	-30 dBm	$\leq -70 \text{ dBc}$											
$\geq 800 \text{ MHz}$ (band 0)	-30 dBm	$\leq -80 \text{ dBc}$											
$\geq 3.3 \text{ GHz}$	-10 dBm	$\leq -95 \text{ dBc}$											
Third order intermodulation distortion	$\leq -80 \text{ dBc}$ (200MHz to 3.3GHz, band 0) $\leq -75 \text{ dBc}$ (3.2GHz to 30GHz, band 1 to 4) $\leq -70 \text{ dBc}$ (29.5GHz to 40GHz, band 5) (Mixer input level -30dBm, two signal difference $> 50 \text{ kHz}$ )												
Image/Multiple/Out of band response	$\leq -70 \text{ dBc}$ ( $10 \text{ MHz} \leq f \leq 18 \text{ GHz}$ ) $\leq -65 \text{ dBc}$ ( $18 \text{ GHz} < f \leq 26.5 \text{ GHz}$ ) $\leq -60 \text{ dBc}$ ( $26.5 \text{ GHz} < f \leq 34 \text{ GHz}$ ) $\leq -50 \text{ dBc}$ ( $34 \text{ GHz} < f \leq 40 \text{ GHz}$ )												
Residual Responses Preamplifier OFF	(input terminated $50\Omega$ , input attenuator 0 dB, $f \geq 1 \text{ MHz}$ ) $\leq -100 \text{ dBm}$ (band 0) $\leq -90 \text{ dBm}$ (band 1 to 5)												
Preamplifier ON	$\leq -105 \text{ dBm}$ (band 0)												

\*1 For a temperature range of  $20^\circ\text{C}$  to  $30^\circ\text{C}$ . Add 2 dB for a temperature range of  $0^\circ\text{C}$  to  $50^\circ\text{C}$ .

7.5 R3182 Specifications

(5) Amplitude Accuracy

Characteristics	Specification																																												
Frequency Response Preamplifier OFF	(after Calibration and Preselector peak, Attenuator 10 dB) <table border="1"> <thead> <tr> <th rowspan="2">Frequency range</th> <th colspan="2">Relative</th> <th colspan="2">Absolute *2</th> </tr> <tr> <th>20 to 30°C</th> <th>0 to 50°C</th> <th>20 to 30°C</th> <th>0 to 50°C</th> </tr> </thead> <tbody> <tr> <td>100 kHz to 3 GHz</td> <td>±0.5 dB</td> <td>±1.0 dB</td> <td>±0.6 dB</td> <td>±1.0 dB</td> </tr> <tr> <td>9 kHz to 3.3 GHz</td> <td>±1.5 dB</td> <td>±2.0 dB</td> <td>±1.5 dB</td> <td>±2.0 dB</td> </tr> <tr> <td>3.3 GHz to 7.1 GHz</td> <td>±1.6 dB</td> <td>±1.8 dB</td> <td>±1.8 dB</td> <td>±2.5 dB</td> </tr> <tr> <td>7.1 GHz to 14.7 GHz</td> <td>±1.8 dB</td> <td>±2.0 dB</td> <td>±2.0 dB</td> <td>±3.0 dB</td> </tr> <tr> <td>14.7 GHz to 27 GHz</td> <td>±2.5 dB</td> <td>±3.0 dB</td> <td>±3.0 dB</td> <td>±4.0 dB</td> </tr> <tr> <td>27 GHz to 30 GHz</td> <td>±3.0 dB</td> <td>±3.5 dB</td> <td>±3.5 dB</td> <td>±4.5 dB</td> </tr> <tr> <td>30 GHz to 40 GHz</td> <td>±3.5 dB</td> <td>±4.0 dB</td> <td>±4.0 dB</td> <td>±5.0 dB</td> </tr> </tbody> </table>	Frequency range	Relative		Absolute *2		20 to 30°C	0 to 50°C	20 to 30°C	0 to 50°C	100 kHz to 3 GHz	±0.5 dB	±1.0 dB	±0.6 dB	±1.0 dB	9 kHz to 3.3 GHz	±1.5 dB	±2.0 dB	±1.5 dB	±2.0 dB	3.3 GHz to 7.1 GHz	±1.6 dB	±1.8 dB	±1.8 dB	±2.5 dB	7.1 GHz to 14.7 GHz	±1.8 dB	±2.0 dB	±2.0 dB	±3.0 dB	14.7 GHz to 27 GHz	±2.5 dB	±3.0 dB	±3.0 dB	±4.0 dB	27 GHz to 30 GHz	±3.0 dB	±3.5 dB	±3.5 dB	±4.5 dB	30 GHz to 40 GHz	±3.5 dB	±4.0 dB	±4.0 dB	±5.0 dB
Frequency range	Relative		Absolute *2																																										
	20 to 30°C	0 to 50°C	20 to 30°C	0 to 50°C																																									
100 kHz to 3 GHz	±0.5 dB	±1.0 dB	±0.6 dB	±1.0 dB																																									
9 kHz to 3.3 GHz	±1.5 dB	±2.0 dB	±1.5 dB	±2.0 dB																																									
3.3 GHz to 7.1 GHz	±1.6 dB	±1.8 dB	±1.8 dB	±2.5 dB																																									
7.1 GHz to 14.7 GHz	±1.8 dB	±2.0 dB	±2.0 dB	±3.0 dB																																									
14.7 GHz to 27 GHz	±2.5 dB	±3.0 dB	±3.0 dB	±4.0 dB																																									
27 GHz to 30 GHz	±3.0 dB	±3.5 dB	±3.5 dB	±4.5 dB																																									
30 GHz to 40 GHz	±3.5 dB	±4.0 dB	±4.0 dB	±5.0 dB																																									
Preamplifier ON	<table border="1"> <thead> <tr> <th rowspan="2">Frequency range</th> <th colspan="2">Relative</th> <th colspan="2">Absolute *2</th> </tr> <tr> <th>20 to 30°C</th> <th>0 to 50°C</th> <th>20 to 30°C</th> <th>0 to 50°C</th> </tr> </thead> <tbody> <tr> <td>100 kHz to 2.7 GHz</td> <td>±1.0 dB</td> <td>±1.0 dB</td> <td>±1.0 dB</td> <td>±1.0 dB</td> </tr> <tr> <td>9 kHz to 3.3 GHz</td> <td>±2.0 dB</td> <td>±2.0 dB</td> <td>±2.0 dB</td> <td>±2.0 dB</td> </tr> </tbody> </table>	Frequency range	Relative		Absolute *2		20 to 30°C	0 to 50°C	20 to 30°C	0 to 50°C	100 kHz to 2.7 GHz	±1.0 dB	±1.0 dB	±1.0 dB	±1.0 dB	9 kHz to 3.3 GHz	±2.0 dB	±2.0 dB	±2.0 dB	±2.0 dB																									
Frequency range	Relative		Absolute *2																																										
	20 to 30°C	0 to 50°C	20 to 30°C	0 to 50°C																																									
100 kHz to 2.7 GHz	±1.0 dB	±1.0 dB	±1.0 dB	±1.0 dB																																									
9 kHz to 3.3 GHz	±2.0 dB	±2.0 dB	±2.0 dB	±2.0 dB																																									
Calibration Signal Accuracy	-20 dBm ±0.3dB																																												
IF Gain Error	(after automatic calibration) ±0.5 dB																																												
Scale Fidelity Log  Linear	(after automatic calibration) ±1.5 dB/90 dB ±1.0 dB/10 dB ±0.2 dB/1 dB ±5% of reference level																																												
Input attenuator switching accuracy	≤±1.1 dB/10 dB, 2 dB max. (9 kHz to 12 GHz) ≤±1.3 dB/10 dB, 2.5 dB max. (12 GHz to 18 GHz) ≤±1.8 dB/10 dB, 3.5dB max. (18GHz to 26.5GHz) ≤±2.2 dB/10 dB, 4dB max. (26.5GHz to 40GHz) in reference to an attenuation of 10 dB																																												
Resolution bandwidth switching uncertainty	(after automatic calibration) ±0.5 dB																																												
Overall level accuracy	Preamplifier OFF ±1.5 dB (REF = -50 to 0 dBm, ATT = 10 dB, 2 dB/div, RBW = 300 kHz, f = 100 kHz to 3 GHz, after automatic calibration)																																												

\*2 In reference to 30MHz calibration signal.

## (6) Input and Output

Characteristics	Specification
RF input Connector Impedance VSWR Preamplifier OFF  Preamplifier ON	K male 50 $\Omega$ (nominal) (at tuned frequency) < 1.5 : 1 (9 kHz to 3.3 GHz, band 0) (characteristic value) < 2 : 1 (3.2 GHz to 27 GHz, band 1-3) (characteristic value) < 2.2 : 1 (26.5 GHz to 40 GHz, band 4-5) (characteristic value) with input attenuator 10 dB to 70 dB < 2.5 : 1 (9 kHz to 3.3 GHz, band 0) (characteristic value)
Probe power	$\pm 12$ V (nominal), 4-pin connector
Calibration output signal	BNC female, 50 $\Omega$ (nominal) 30 MHz, -20 dBm
Ext. Mixer local Out Connector Impedance Frequency range Output level	SMA female 50 $\Omega$ (nominal) 4.0 GHz to 7.6 GHz > +8dBm
10MHz reference input	BNC female, 500 $\Omega$ (nominal) -10 dBm to +10 dBm
External trigger input	BNC female
Y axis output	BNC female Approximately 2 V in full scale (10 dB/div)
Phone output	Small size monophonic female
GPIB interface	IEEE-488 bus connector
Serial interface	D-Sub 9pins
Printer interface	D-Sub 25pins, ESC/P, ESC/P-R, PCL
Video output	VGA (15 pins, female)
Floppy drive	3.5 inch, MS-DOS format

## 7.5 R3182 Specifications

## (7) General Specifications

Characteristics	Specification
Operating environment range	0°C to +50°C Relative humidity 85% or less (without condensation)
Storage environment range	-20°C to +60°C Relative humidity 85% or less
AC input power source	Automatic switching to 100 VAC or 200 VAC For 100 VAC: 100 to 120 VAC, 50 to 60 Hz For 200 VAC: 220 to 240 VAC, 50 to 60 Hz
Power consumption	< 200 VA
Mass	< 18kg
Dimensions	Approximately 424(W) × 177(H) × 300(D) mm (not including projections such as rubber feet and connectors)

## 7.6 Options

### (1) R3132/32N/62/72/82

- OPT20 Highly Stable Reference Frequency Crystal Oscillator

Characteristics	Specification
Reference frequency source accuracy	Aging $\pm 2 \times 10^{-8}/\text{day}$ , $\pm 1 \times 10^{-7}/\text{year}$ Warm-up drift (nominal) $\pm 5 \times 10^{-8}$ (+25°C, 10 minutes after turning the power on) Temperature drift $\pm 5 \times 10^{-8}$ (0 to +40°C, with reference to +25°C)

- OPT27 Narrow-band Resolution Bandwidth

Characteristics	Specification
3-dB resolution bandwidth	300Hz, 100Hz, 30Hz
Bandwidth accuracy	$\pm 20\%$
6-dB resolution bandwidth	200Hz

- OPT29 High-Speed Time-Domain Sweep

Characteristics	Specification
Sweep time	50 $\mu\text{s}$ to 10ms
Sweep time accuracy	$\pm 1\%$
Trace detector	Sample
Trace point	501

7.6 Options

OPT73 FM Demodulation

- Internal Mixer Mode

Characteristics	Specification
Amplitude range	> -50 dBm + Input attenuator value (-20 dB or more in reference to the reference level with a center frequency of 1 GHz and the RBW set to 10 MHz)
FM deviation Display range on the screen	2.5 MHz, 1 MHz, 500 kHz, 250 kHz, 100 kHz, 50 kHz, 25 kHz and 10 kHz
Linearity error *	≤ (2% of the screen display range)
Offset error*	≤ (4% of the screen display range + K + Frequency reading × Frequency reference accuracy) K: 8 kHz (Screen display range: 2.5 MHz to 250 kHz) 2 kHz (Screen display range: 100 kHz to 10 kHz)
Demodulation frequency bandwidth (3 dB)	≥ 300 kHz (Nominal)

\*: This value is obtained after a warm-up of at least 30 minutes is performed, and then a calibration called FM Demod All CAL is performed.

- External Mixer Mode (OPT16, OPT17, OPT18, or OPT19 is required)

Characteristics	Specification
FM deviation Display range on the screen	500 MHz, 250 MHz, 100 MHz, 50 MHz, 25 MHz, 10 MHz, 5 MHz, 2.5 MHz, 1 MHz, 500 kHz, 250 kHz, 100 kHz, 50 kHz, 25 kHz and 10 kHz
Linearity error *	≤ (2% of the screen display range)
Offset error*	≤ (4% of the screen display range + K + Frequency reading × Frequency reference accuracy) K: 128 kHz (Screen display range: 500 MHz to 5 MHz) 8 kHz (Screen display range: 2.5 MHz to 250 kHz) 2 kHz (Screen display range: 100 kHz to 10 kHz)
Demodulation frequency bandwidth (3 dB)	≥ 300 kHz (Nominal)

\*: This value is obtained after a warm-up of at least 30 minutes is performed, and then a calibration called FM Demod All CAL is performed.



## (2) R3132/62

## • OPT74 Tracking Generator

Characteristics	Specification
Frequency range	100kHz to 3.0GHz
Output level range	0 to -59.9dBm
Output level accuracy	$\pm 0.5$ dB (30 MHz, -10 dBm, 20°C to 30°C)
Output flatness	$\pm 1.0$ dB (100kHz to 1GHz) $\pm 1.5$ dB (100kHz to 3GHz) (The reference signal level and frequency are -10dBm and 30 MHz, respectively.)
Output level switching uncertainty	$\pm 1.0$ dB (100kHz to 1GHz) (Output level $\geq$ -30dBm) $\pm 2.0$ dB (100kHz to 2.6GHz) $\pm 3.0$ dB (100kHz to 3GHz) (The reference level is -10dBm.)
Spurious output Harmonics spurious signals Non-harmonics spurious signals	$\leq -20$ dBc (Output level = -10dBm) $\leq -30$ dBc (Output level = -10dBm)
TG leakage	$\leq -100$ dBm (Input ATT = 0dB)
Output Impedance VSWR	50 $\Omega$ (nominal) $\leq 2$ (For the output level of -10dBm or less) (characteristic value)
Maximum allowable input level	+15dBm $\pm 10$ V
Mass	1 kg or less

7.6 Options

(3) R3132N

- OPT74 Tracking Generator

Characteristics	Specification
Frequency range	100kHz to 3.0GHz
Output level range	105 to -45.1dB $\mu$ V
Output level accuracy	$\pm 0.5$ dB (30MHz, 95dB $\mu$ V, 20°C to 30°C)
Output flatness	$\pm 1.0$ dB (100kHz to 1GHz) $\pm 1.5$ dB (100kHz to 2.2GHz) (The reference signal level and frequency are 95dB $\mu$ V and 30MHz, respectively.)
Output level switching uncertainty	$\pm 1.0$ dB (100kHz to 1GHz) (Output level $\geq -75$ dB $\mu$ V) $\pm 2.0$ dB (100kHz to 2.2GHz) (The reference level is 95dB $\mu$ V.)
Spurious output Harmonics spurious signals Non-harmonics spurious signals	$\leq -20$ dBc (Output level = 95dB $\mu$ V) $\leq -30$ dBc (Output level = 95dB $\mu$ V)
TG leakage	$\leq 7$ dB $\mu$ V (Input ATT = 0dB)
Output Impedance VSWR	75 $\Omega$ (nominal) (for the output level of 95dB $\mu$ V or less) $\leq 2$ (100kHz to 2.2GHz) (characteristic value)
Maximum allowable input level	123dB $\mu$ V $\pm 10$ V
Mass	1 kg or less

(4) R3172

- OPT03 Ext. Mixer local Out

Characteristics	Specification
Frequency range	4.0 GHz to 7.6 GHz
Output level	$> +8$ dBm
Output impedance	50 $\Omega$ (nominal)
Connector	SMA female

## (5) R3172/82

Characteristics	Specification			
	OPT16	OPT17	OPT18	OPT19
Frequency range	26.5 to 40 GHz	40 to 60 GHz	50 to 75 GHz	75 to 85 GHz
			70 to 80 GHz	85 to 110 GHz
Waveguide	WR-28	WR-19	WR-15	WR-10
Harmonic order N	6-	8-	10-	16-
			12-	
Maximum input level [dBm]	20	20	20	20
Frequency response [dB]	±5	±5	±5	±5
One-dB gain compression [dBm]	-1	-1	-6	-6
Displayed average noise level [dBm] (RBW1 kHz, VBW10 Hz)	-99	-93	-90	-85
			-88	-80



## APPENDIX

### A.1 ERROR MESSAGE

Error No.	Error Message	Description
1	Span is set 0 Hz. Please change span.	Zero Span is selected. Please set the correct span.
2	Span is not set 0 Hz. Please change to zero span.	Zero Span is not selected. Please select Zero Span.
3	Scale is Linear mode. Please select dB/div scale. [Level → dB/div]	Vertical scale is set to Linear mode. Please select dB/div scale.
4	QP detector is active. Please change to Normal. [EMC → Detector mode]	QP detection mode is selected. Please change to Normal mode.
5	Antenna correction is ON. Please turn correction off. [EMC → Field]	Antenna correction is active. Please turn Antenna correction off.
6	Scale is not 10 dB/div. Please select 10 dB/div. [Level → dB/div]	The vertical scale is not set to 10 dB/div. Please select 10 dB/div scale.
7	$\Delta$ Marker is not active. Please activate $\Delta$ Marker. [MKR → Delta Marker]	The delta marker is not active. Please activate the delta marker.
8	Blank mode is selected. Please change to Write mode. [Trace → Write]	Cannot execute because the blank mode is selected. Please change to Write mode.
9	Calculated power is out of range.	The display line cannot be displayed because the measurement result is out of range.
10	No peak is detected.	No corresponding peak has been detected.
11	Normal detector is active. Please change to QP or Peak. [EMC → Detector mode]	Normal mode is selected. Please change to QP detection mode or PEAK detection mode.
12	Not available. ACP Graph is ON.	Cannot specify because the ACP Graph is active.
13	Marker Frequency is base-band.	Cannot tune the preselector because the Marker frequency is within the base-band range.
14	Not available in Fast sweep mode.	Cannot execute because the Fast sweep mode is selected.

## A.1 ERROR MESSAGE

Error No.	Error Message	Description
15	Not available. Please input External 10MHz Ref.	Cannot set to EXT because 10 MHz external reference signal is not input. Please input the external reference signal.
16	External 10MHz Ref. is not detected. 10MHz Ref. changed to Internal.	Since 10 MHz external reference signal has not been detected, the reference signal source is switched to INT. Please check the external reference signal.
17	Not available. Trigger source is Free Run or Line.	Trigger slope (TV modulation polarity) cannot be switched between + and - because the trigger source is set to Free Run or Line.
18	Gated sweep setup mode. Please select the same Gate source.	A trigger source can be selected only from the Gate sources.
19	Not available. RBW is 1MHz.	Cannot change to QP detection mode because an RBW of 1MHz is selected for the PEAK detection mode.
20	Not available. EMC Detector is QP.	RBW cannot be set to 1 MHz because QP detection mode is selected.
21	Scale is not Linear mode. Please select Linear scale. [Level → Linear]	Vertical scale is not in Linear mode. Please change it to Linear mode.
22	Not available. Channel tables are all disabled.	Channels cannot be set because all channel tables are disabled.
23	Not available. Channel table contains no data.	Channels cannot be set because all channel tables have no data.
24	Peak detector is active. Please change to Normal. [EMC→Detector mode]	Peak detector mode is turned on. Turn Normal mode on.
30	Parameter is out of range.	The value for the ACP CS/BS table is out of range. Please change the span which can be measured.
31	Incorrect data. Set span to $(1.0 + \alpha) * T_f$ or more.	The value for $\sqrt{N}$ Nyquist filter is out of range. Change the measurement condition to meet the following: Frequency span > $(1.0 + \text{Rolloff factor}) \times \text{Symbol rate}$
32	Frequency table contains no data.	Cannot execute the ACP function because the ACP CS/BC table has no data.
33	Editor is active. Please quit the editor first.	The editor mode is disabled while this operation is in process. Quit the editor mode first.
34	Spurious table contains no data.	Enter data into the spurious table because it has no data.

Error No.	Error Message	Description
35	Not available. Spurious is ON.	Cannot be executed because Spurious measurement mode is turned on.
36	Not available. C/N measurement is ON.	Cannot be executed because the phase noise measurement mode is turned on.
37	Not available. Phase Jitter is ON.	Cannot be executed because the phase jitter measurement mode is turned on.
38	Not available. IM measurement is ON.	Cannot be executed because the odd-order distortion measurement mode is turned on.
50	Not available in ACP Separate-screen mode.	Cannot execute because ACP SEPA mode is selected.
51	Not available in Single-screen mode.	Cannot execute because Single-screen mode is selected.
52	Not available in Zoom(F/F) mode.	Cannot execute because Zoom(F/F) mode is selected.
53	Not available in Zoom(T/T) mode.	Cannot execute because Zoom(T/T) mode is selected.
54	Not available in F/T mode.	Cannot execute because F/T mode is selected.
55	Not available in T/T mode.	Cannot execute because T/T mode is selected.
56	Not available in Gated sweep(F/T) mode.	Cannot execute because Gated sweep(F/T) mode is selected.
57	Not available in Multi-screen mode.	Cannot execute because Multi-screen mode is selected.
58	Please select Gated sweep setup mode.	Cannot execute because the Gated Sweep (F/T) mode must be selected. Please change to the Gated Sweep(F/T) mode.
59	Please select Zoom or F/T mode.	Cannot execute because the Zoom(F/F or T/T) or F/T mode must be selected. Please change to the Zoom(F/F or T/T) or F/T mode.
200	Illegal parameters.	The specified parameter is incorrect.
201	Illegal file or device name.	The file name or device name is incorrect.
202	File or register empty.	The recall command can not be executed successfully because the file or register is empty.
203	Read error.	The file can not be read out.
210	Device not ready.	The device is not communicable.
211	File not found.	No file has been found.
212	Invalid BPB. Please format a disk.	The BPB has been destroyed. Please format the disk.
213	Can't delete a file. (read-only file)	This is a read-only file and cannot be erased.

## A.1 ERROR MESSAGE

Error No.	Error Message	Description
214	I/O error.	An access error to disk has occurred.
215	Media changed.	This disk was replaced with another while it was being accessed.
216	No disk space.	There is no space on the disk.
217	Read-only file.	This is a read-only file.
218	Read-only media.	This is a read-only media.
219	Root directory full.	The root directory is full.
220	Invalid boot sector signature.	The boot sector signature cannot be recognized.
221	CRC error.	A CRC error occurred.
222	Invalid disk geometry.	An invalid disk geometry was found.
300	Printer is not ready. Please check a printer setting.	Cannot print. Please check the printer settings.
301	Printer cable problem. Please check a cable or connection.	There is a problem with the printer cable. Please check the cable connection.
302	Printer is not active.	The printer is not ready.
303	Printer/FDD is busy.	The printer is currently used in the BMP format. Please execute again after the printout has completed.
310	Color mode is selected. Please select Gray or B&W mode.	Color is selected for the screen display condition. Please change to Gray or B&W.
600	External Mixer is selected. Please set the mixer to Internal.	External Mixer is selected. Please set the mixer to Internal.
601	Internal Mixer is selected. Please set the mixer to External.	Internal Mixer is selected. Please set the mixer to External.
602	Band lock is OFF. Please turn band lock on.	Band lock is OFF. Please turn band lock on.
610	Not available. FM Demodulation is ON.	Cannot be executed because FM Demodulation is turned on.
611	Not available. FM Demodulation is OFF.	Cannot be executed because FM Demodulation is turned off.
612	Not available. Sensitivity is ON.	Cannot be executed because Sensitivity is turned on.
613	Not available. Linearity is ON.	Cannot be executed because Linearity is turned on.
614	Sensitivity is OFF. Please turn sensitivity on.	Cannot be executed because Sensitivity is turned off. Turn Sensitivity on.
615	Please select Linearity setup mode.	Cannot be executed because Linearity Setup Display Mode is turned off. Turn it on.



Error No.	Error Message	Description
616	Not available. Screen B is active.	This function cannot be executed for the B screen.
617	Not available. Many sample points in window.	The number of sample points in the window exceeds the specified value.
618	Auto adjust failure. Offset or Slope is out of range.	Failed to automatically adjust the reference line. The calculated offset or slope is outside of the setting range.
619	Not available. FM Demod range is more than 500 kHz/.	Cannot be executed because Range is 500 kHz/ or more.
620	Broken FM Demod data. Please report to qualified service person.	Adjustment data for FM Demodulation is corrupt. Contact ADVANTEST for repair.
621	FM Demod Calibration failure. Please report to qualified service person.	The calibration for FM Demodulation failed. Contact ADVANTEST for repair.
700	TG output signal is not detected.	TG output signal cannot be detected.
701	TG Freq Adjust failure. Please report to qualified service person.	Automatic TG Frequency adjustment cannot be performed. Please contact qualified service personnel for repair information.
800	IF STEP AMP: Calibration failure.	A calibration error occurred.
801	LOG LINEARITY: Calibration failure.	A calibration error occurred.
802	TOTAL GAIN: Calibration failure.	A calibration error occurred.
803	RBW SWITCHING: Calibration failure.	A calibration error occurred.
804	AMPTD OFS: Calibration failure.	A calibration error occurred.
805	PBW: Calibration failure.	A calibration error occurred.
806	Normal ADC: Calibration failure.	A calibration error occurred.
807	Calibration signal is not detected.	No CAL signal has been detected.
808	Cal data is not enough. Please execute Cal All.	No CAL data has been found. Please perform Cal All.
830	Broken Freq-Corr data. Please report to qualified service person.	Freq-Corr data has been destroyed. Please contact a qualified service representative.
850	Initial Test failure. Please report to qualified service person.	Initial test detected an error. Please contact a qualified service representative.
851	Initial Test failure. Please report to qualified service person.	Initial test detected an error. Please contact a qualified service representative.

## A.1 ERROR MESSAGE

Error No.	Error Message	Description
852	Initial Test failure. Please report to qualified service person.	Initial test detected an error. Please contact a qualified service representative.
853	Initial Test failure. Please report to qualified service person.	Initial test detected an error. Please contact a qualified service representative.
854	Initial Test failure. Please report to qualified service person.	Initial test detected an error. Please contact a qualified service representative.
855	Initial Test failure. Please report to qualified service person.	Initial test detected an error. Please contact a qualified service representative.
856	Initial Test failure. Please report to qualified service person.	Initial test detected an error. Please contact a qualified service representative.
857	Initial Test failure. Please report to qualified service person.	Initial test detected an error. Please contact a qualified service representative.
858	Initial Test failure. Please report to qualified service person.	Initial test detected an error. Please contact a qualified service representative.
859	Initial Test failure. Please report to qualified service person.	Initial test detected an error. Please contact a qualified service representative.
995	This model is not R3132	Cannot execute because this model is not R3132.
996	This model is R3132	Cannot execute because this model is R3132.
997	This model is R3132N	Cannot execute because this model is R3132N.
998	Option required.	Cannot execute because options are not installed.

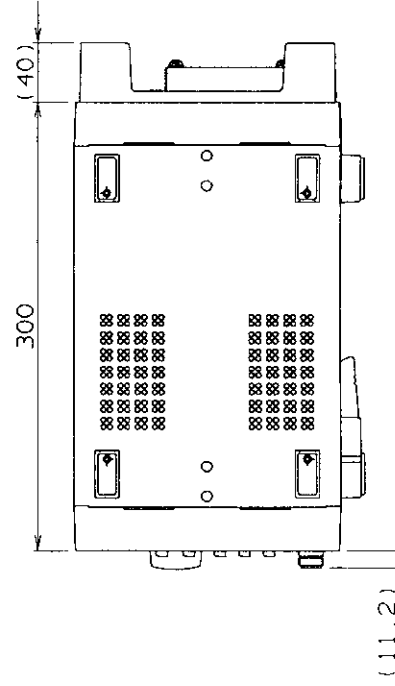
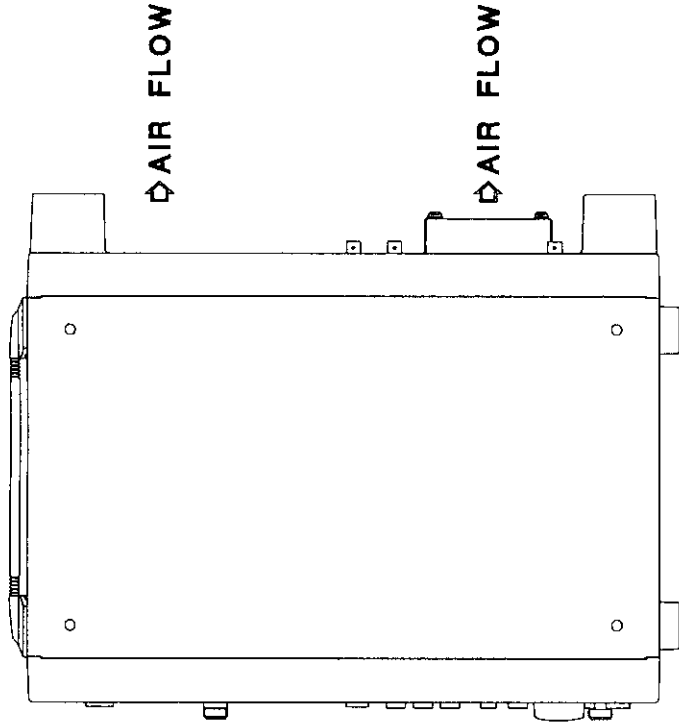
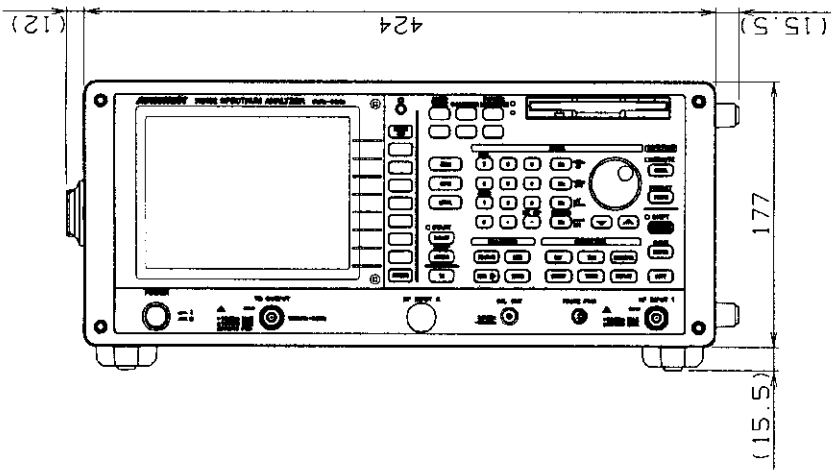

Unit : mm

**CAUTION**

This drawing shows external dimensions of this instrument.

The difference in products and options used can cause a change in the appearance of the instrument.

**R3132/32N/62 DIMENSIONAL OUTLINE DRAWING**

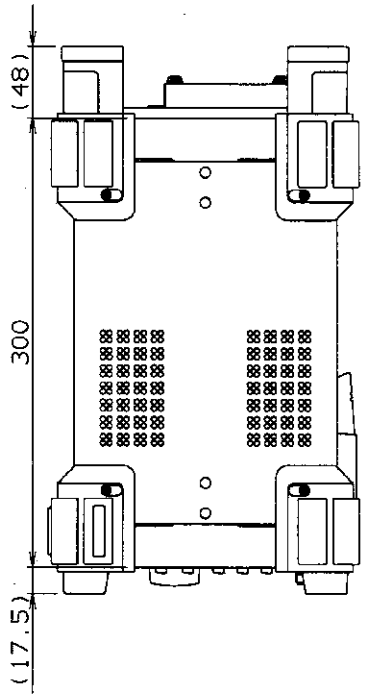
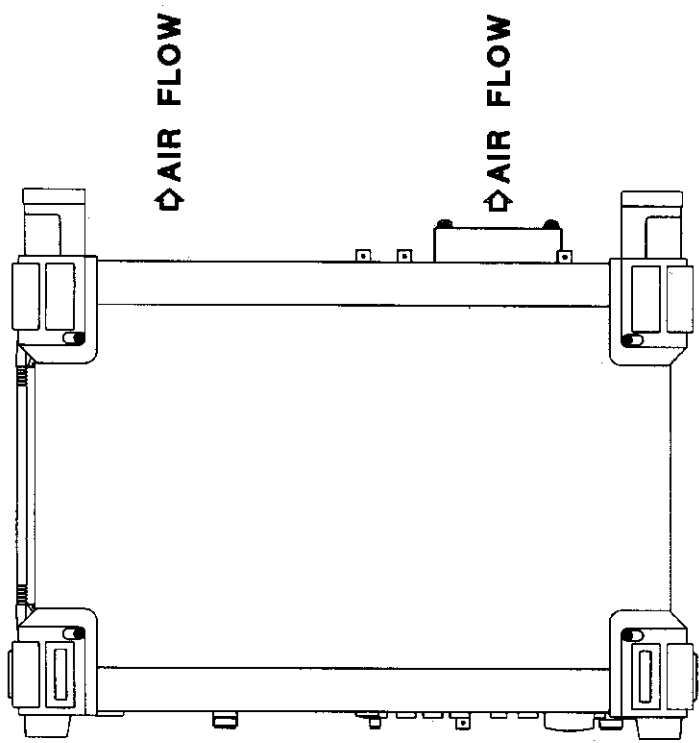
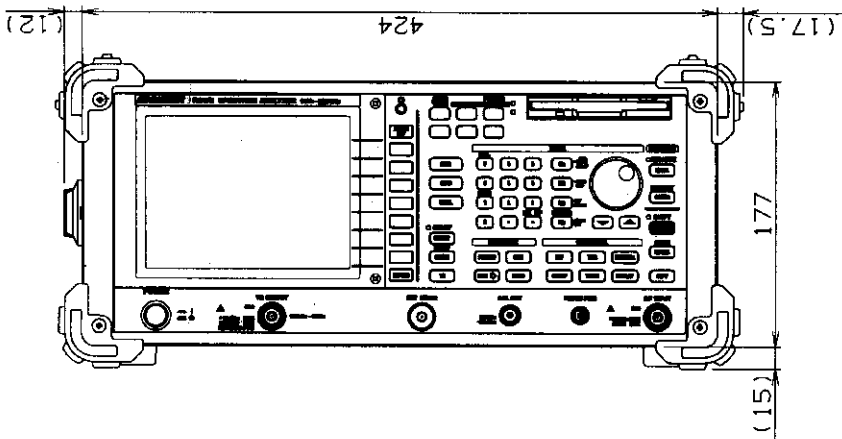

**R3172/82 DIMENSIONAL OUTLINE DRAWING**

Unit : mm

**CAUTION**

This drawing shows external dimensions of this instrument.  
The difference in products and options of the instrument.

## ALPHABETICAL INDEX

<b>[Symbol]</b>		
-(BK SP) .....	2-8	
√Nyquist Filter .....	3-59, 3-61	
√Nyquist Filter ON/OFF .....	3-14, 3-59, 3-61	
√Nyquist Filter Setup .....	3-14, 3-59, 3-61	
ΔMKR → CF .....	3-12, 3-53	
ΔMKR → CF Step .....	3-12, 3-53	
ΔMKR → MKR Step .....	3-12, 3-53	
ΔMKR → Span .....	3-12, 3-53	
% AM Meas ON/OFF .....	3-11, 3-46	
% AM Video ON/OFF .....	3-11, 3-46	
<b>[Numerics]</b>		
1/2_more and 2/2_more .....	2-18	
10 MHz REFERENCE INPUT terminal .....	2-14	
10dB/div .....	3-10, 3-42	
10M Ref INT/EXT .....	3-8, 3-26	
1dB/div .....	3-10, 3-42	
2dB/div .....	3-10, 3-42	
3rd Order .....	3-11, 3-49	
3rd Order Meas .....	3-11, 3-46	
5dB/div .....	3-10, 3-42	
5th Order .....	3-11, 3-49	
75Ω mode indicator .....	2-13	
7th Order .....	3-11, 3-49	
9th Order .....	3-11, 3-49	
<b>[A]</b>		
A-B → A .....	3-17, 3-79	
Abort .....	3-7, 3-29	
Absolute Output Level Accuracy .....	5-90	
AC power connector .....	2-15	
Access lamp .....	2-6	
Accessories .....	1-3	
ACP .....	2-61, 3-14, 3-58	
ACP OFF .....	3-14, 3-60	
Active area .....	2-3, 2-13	
Active Marker .....	3-12, 3-14, 3-52, 3-60	
ACTIVE OFF .....	2-3, 2-17	
additional function keys .....	2-8	
Adjacent Channel Leakage Power .....	2-61	
A-DL → A .....	3-17, 3-79	
All .....	3-18, 3-84	
Amplitude scale .....	2-12	
AMPTD OFS .....	3-7, 3-21	
Annotation ON/OFF .....	3-8, 3-26	
Ant Corr .....	3-16, 3-69	
Antenna Correction Data .....	2-49	
Aperture % .....	3-18, 3-83	
Arrangement of the three status registers .....	4-16	
ATT AUTO/MNL .....	3-10, 3-42	
Auto Adj .....	3-18, 3-83	
Auto All .....	3-7, 3-16, 3-20, 3-74	
Auto Increment .....	3-8, 3-25	
AUTO TUNE .....	2-11, 3-7, 3-19	
Auto Tune .....	3-10, 3-38	
Auto Tuning .....	2-29, 3-19	
Average CONT/SGL .....	3-17, 3-78, 3-79	
Average Loss ON/OFF .....	3-10, 3-39	
Average Power .....	3-14, 3-58	
Average PSE/CONT .....	3-17, 3-77, 3-78	
Average Times .....	3-14, 3-57	
Average Times ON/OFF .....	3-11, 3-48, 3-49	
AVG A(B) .....	3-17, 3-77	
AVG A(B) ON/OFF .....	3-17, 3-77	
<b>[B]</b>		
B&W .....	3-8, 3-28	
B-A → A .....	3-17, 3-79	
Band Lock ON/OFF .....	3-10, 3-39	
Band Select .....	3-10, 3-38	
Bandwidth .....	3-20	
Basic Operation .....	2-16	
Baud Rate .....	3-8, 3-23	
BBA9106 .....	3-9, 3-34	
Blank A(B) .....	3-17, 3-77	
BS Window ON/OFF .....	3-14, 3-59, 3-61	
Burst Signals .....	2-71, 2-75	
BW .....	2-9, 3-7, 3-20, 4-25	
<b>[C]</b>		
C/N Meas .....	3-11, 3-47	
C/N Meas OFF .....	3-11, 3-48	
Cable wiring diagram .....	4-65	
CAL .....	2-8, 3-7, 3-21, 4-42	
Cal 10MHz Ref .....	3-7, 3-21	
Cal All .....	3-7, 3-21	
Cal Corr ON/OFF .....	3-7, 3-21	

## Alphabetical Index

- CAL OUT connector ..... 2-4, 2-5,  
2-6
- Cal Sig Level ..... 3-7, 3-21
- Calibration ..... 1-15, 2-49,  
3-21
- Calibrator Amplitude Accuracy ..... 5-9
- Carrier ..... 3-37
- Center ..... 3-10, 3-36
- Center frequency ..... 2-12
- CF Step AUTO/MNL ..... 3-10, 3-36
- CH Power OFF ..... 3-14, 3-57
- CH Type 1 Edit ..... 3-10, 3-37
- CH Type 2 Edit ..... 3-10, 3-37
- Change Title ..... 3-8, 3-16,  
3-26, 3-70
- Channel ..... 3-16, 3-37,  
3-70
- Channel Power ..... 3-14, 3-57
- Channel Setting ..... 3-10, 3-36
- Cleaning ..... 1-13
- CNO ..... 4-38
- Coarse ..... 3-7, 3-21
- Color 1 ..... 3-8, 3-27
- Color 2 ..... 3-8, 3-27
- Color Pattern ..... 3-8, 3-27
- Command Syntax ..... 4-13
- Compression ..... 3-8, 3-25
- Condition Register ..... 4-15
- CONFIG ..... 2-10, 3-8,  
3-23
- Config ..... 4-44
- Configuration ..... 3-23
- Connecting the GPIB ..... 4-9
- Connection between the controller  
and the spectrum analyzer ..... 4-64
- Connector Section ..... 2-4
- Cont Down ON/OFF ..... 3-11, 3-45
- Cont Peak ON/OFF ..... 3-12, 3-50
- Continuous peak search ..... 2-32
- Continuous Sweep ..... 3-68
- CONTROL Section ..... 2-9
- COPY ..... 2-10, 3-8,  
3-29
- Copy Config ..... 3-8, 3-23
- Copy Device PRT/FD ..... 3-8, 3-26
- Copy Mode ..... 3-8, 3-24,  
3-25
- Copy Table 1 to 2 ..... 3-13, 3-55
- Copy Table 2 to 1 ..... 3-13, 3-55
- Corr Mode ANT/LVL ..... 3-9, 3-34
- Corr OFF ..... 3-9, 3-34
- COUNTER ..... 2-11, 3-9,  
3-30
- Counter ..... 4-38
- counter function ..... 2-27
- Counter OFF ..... 3-9, 3-30
- Creating a correction data table ..... 2-49
- CS/BS Setup ..... 3-14, 3-58,  
3-61
- [D]**
- Data format ..... 4-14, 4-65
- Data knob ..... 2-8
- Data Length ..... 3-8, 3-23
- Data Readout ..... 3-67
- DATA Section ..... 2-8
- Date ..... 2-12
- Date/Time ..... 3-8, 3-27
- Day ..... 3-8, 3-27
- dB/div ..... 3-10, 3-42
- dBc/Hz ..... 3-11, 3-45
- dBm ..... 3-10, 3-42
- dBm/Hz ..... 3-11, 3-45
- dBmV ..... 3-10, 3-42
- dB $\mu$ V ..... 3-10, 3-42
- dB $\mu$ V/ $\sqrt{\text{Hz}}$  ..... 3-11, 3-45
- DCL ..... 4-11
- Default ..... 3-7, 3-14,  
3-22, 3-57,  
3-58, 3-60,  
3-62
- Default Config ..... 3-8, 3-28,  
3-89
- Define  $\rightarrow$  Default ..... 3-14, 3-57,  
3-58, 3-60,  
3-62
- Delete ..... 3-11, 3-14,  
3-15, 3-16,  
3-47, 3-63,  
3-64, 3-70
- Delete Line ..... 3-9, 3-10,  
3-13, 3-14,  
3-34, 3-38,  
3-39, 3-55,  
3-59, 3-61
- Deleting the data ..... 2-113
- Delta ..... 3-12, 3-50
- Demod Cal ..... 3-18, 3-84
- Details of the three status registers ..... 4-17
- Detector ..... 3-17, 3-77
- Detector Mode ..... 3-9, 3-33
- Deviation ..... 3-18, 3-83
- Deviation OFF ..... 3-18, 3-83
- Device Clear ..... 4-11
- Device RAM/FD ..... 3-15, 3-16,  
3-67, 3-70

- Differences between RS-232 and GPIB . 4-66  
 Disp Line ON/OFF ..... 3-9, 3-17, 3-31, 3-79  
 DISPLAY ..... 2-9, 3-9, 3-31  
 Display ..... 4-31  
 display format of date ..... 2-119  
 Display Section ..... 2-3  
 Displayed Average Noise Level ..... 5-11  
 Displaying Off ..... 4-10  
 Displaying Spectrums and Operating the Markers ..... 2-19  
 Displaying submenu ..... 2-17
- [E]**
- Each Item ..... 3-7, 3-21  
 Edit Table ..... 3-11, 3-14, 3-47, 3-62, 3-64  
 Editing the correction data table ..... 2-50  
 Eject button ..... 2-6  
 EMC ..... 2-8, 3-9, 3-33, 4-41  
 EMC Measurement ..... 3-33  
 EMCO3142 ..... 3-9, 3-34  
 Enable Register ..... 4-15  
 Entering Data ..... 2-16  
 Entering Data Using the Data Knob ..... 2-17  
 Entering Data Using the Numeric Keys . 2-16  
 Entering Data Using the Step Keys ..... 2-16  
 Entry ..... 4-48  
 Environmental Conditions ..... 1-6  
 ERROR MESSAGE ..... A-1  
 Event Enable Register ..... 4-18  
 Event Register ..... 4-15  
 Example Program  
 Used to Read Screen Data ..... 4-62  
 Example Programs ..... 4-49  
 Execute Normalize ..... 3-17, 3-76  
 Execute Self Test ..... 3-16, 3-71  
 Exhaust vent ..... 2-15  
 Exit ..... 3-16, 3-71  
 Ext ..... 3-16, 3-74  
 Ext Gate In ON/OFF ..... 3-16, 3-75  
 Ext Mixer Config ..... 3-10, 3-38  
 EXT MIXER connector ..... 2-5, 2-6  
 Ext Trig ..... 3-17, 3-81  
 External Mixer OPT16 ..... 6-1  
 External Mixer OPT17 ..... 6-14  
 External Mixer OPT18 ..... 6-29  
 External Mixer OPT19 ..... 6-52  
 External Mixer Performance Verification Test Procedures ..... 6-3, 6-16, 6-31, 6-54
- EXTERNAL TRIGGER terminal ..... 2-14
- [F]**
- F/T ..... 3-9, 3-32  
 Factory Defaults ..... 3-85  
 Features of RS-232 Remote Control ..... 4-63  
 Field ..... 3-9, 3-33  
 File ..... 3-8, 3-25  
 File Format ..... 3-8, 3-25  
 File No. .... 3-8, 3-25  
 Fine ..... 3-7, 3-22  
 Fixed MKR ON/OFF ..... 3-12, 3-51  
 Floppy disk drive door ..... 2-6  
 Floppy Disk Drive Section ..... 2-6  
 Flow Control ..... 3-8, 3-23  
 FM Demod ..... 3-18, 3-83  
 FM Demod OFF ..... 3-18, 3-84  
 FM Meas ..... 3-11, 3-46  
 FM Meas OFF ..... 3-11, 3-47  
 Format ..... 3-8, 3-27  
 Format FD ..... 3-8, 3-26  
 Free Run ..... 3-17, 3-81  
 FREQ ..... 2-7, 3-10, 3-36  
 Freq Adj Auto ..... 3-17, 3-76  
 Freq Adj Manual ..... 3-17, 3-76  
 Freq Corr ON/OFF ..... 3-7, 3-21  
 Freq Offset ON/OFF ..... 3-10, 3-36  
 Frequency ..... 3-36, 4-22, 4-23, 4-24  
 Frequency Counter ..... 3-30  
 Frequency Input ..... 3-10, 3-36  
 Frequency Level ..... 3-42  
 Frequency Reference Source Accuracy .. 5-7  
 Frequency Response ..... 5-59, 6-5, 6-18, 6-34, 6-56  
 Frequency span ..... 2-13, 3-73  
 Frequency Span Accuracy ..... 5-68  
 Front Panel ..... 2-1  
 Full Screen Mode ..... 2-61  
 Full Span ..... 3-16, 3-73  
 Functional Description ..... 3-19  
 Fuse ..... 1-7  
 Fuse holder ..... 2-15  
 Fuse information ..... 2-15
- [G]**
- Gain Compression ..... 5-77  
 Gate Position ..... 3-16, 3-75  
 Gate Setup Quit ..... 3-16, 3-75

## Alphabetical Index

- Gate Source ..... 3-16, 3-74  
 Gate Width ..... 3-16, 3-75  
 Gated Sweep ..... 2-71, 3-16, 3-74  
 Gated Sweep ON/OFF ..... 3-16, 3-75  
 General ..... 5-1  
 GHz ..... 2-8  
 Go to Local ..... 4-12  
 GPIB ..... 3-8, 3-23, 4-8, 4-45  
 GPIB Address ..... 3-8  
 GPIB and RS-232 Compatibility ..... 4-63  
 GPIB Command Codes ..... 4-22  
 GPIB Command Index ..... 4-1  
 GPIB connector ..... 2-14  
 GPIB Interface Functions ..... 4-10  
 GPIB Remote Control ..... 3-44  
 GPIB Remote Programming ..... 4-8  
 GPIB Setup ..... 4-9  
 Graph ..... 3-14, 3-60  
 Graph OFF ..... 3-14, 3-60  
 Gray ..... 3-8, 3-28  
 GTL ..... 4-12
- [H]**
- Hard Copy ..... 3-29  
 Harmonic Distortion ..... 2-44, 5-102  
 Header ..... 4-13  
 Hi Sens (IM Meas) ON/OFF ..... 3-11, 3-49  
 Hi Sens ON/OFF ..... 3-10, 3-42  
 HOLD ..... 3-10, 3-41  
 Hour ..... 3-8, 3-27  
 Hz (ENTER) ..... 2-8
- [I]**
- IF Step Amp ..... 3-7, 3-21  
 IFC ..... 4-11  
 IM Meas ..... 3-11, 3-49  
 IM Meas OFF ..... 3-11, 3-49  
 Image Suppress ON/OFF ..... 3-10, 3-39  
 Importing the correction data table ..... 2-50  
 Initialization ..... 2-19, 3-66  
 Initializing the floppy disk ..... 2-105  
 Input 50Ω/75Ω ..... 3-10, 3-43  
 Input Buffer ..... 4-12  
 Input Saturation ..... 2-42  
 Input signal connection ..... 2-20  
 Input Type ..... 3-10, 3-36  
 Insert ..... 3-11, 3-14, 3-15, 3-47, 3-63, 3-64  
 Insert Line ..... 3-9, 3-10, 3-13, 3-14, 3-34, 3-37, 3-39, 3-55, 3-59, 3-61  
 Intensity ..... 2-3  
 Interface Clear ..... 4-11  
 Inverse ..... 3-8, 3-28
- [K]**
- kHz ..... 2-8
- [L]**
- Last Span ..... 3-16, 3-73  
 LEVEL ..... 2-7, 3-10, 3-42  
 Level ..... 3-42, 4-25  
 Limit Line ..... 3-16, 3-70  
 Limit Line 1/2 ..... 3-13, 3-55  
 Limit Line Edit ..... 3-13, 3-55  
 Limit line Function ..... 2-79  
 Limit Setup ..... 3-11, 3-49  
 Lin Setup Quit ..... 3-18, 3-83  
 Line ..... 3-17, 3-81  
 Line and Window ..... 3-31  
 Line setup display ..... 2-12  
 Line1 ON/OFF ..... 3-13, 3-54  
 Line2 ON/OFF ..... 3-13, 3-54  
 Linear ..... 3-10, 3-42  
 Linearity ..... 3-18, 3-83  
 Linearity Error (External Mixer Mode) .. 5-116  
 Linearity Error (Internal Mixer Mode) ... 5-111  
 Linearity ON/OFF ..... 3-18, 3-83, 3-84  
 Liquid crystal display ..... 2-3  
 List of Settings ..... 3-85  
 List ON/OFF ..... 3-15, 3-67  
 LLO ..... 4-12  
 LOCAL ..... 2-10, 3-10, 3-44  
 Local Lockout ..... 4-12  
 Log Linear ..... 3-7, 3-21  
 Loss:Freq ..... 3-16, 3-70  
 Loss:Freq Edit ..... 3-10, 3-39  
 Loss:Freq ON/OFF ..... 3-10, 3-39
- [M]**
- Manual ..... 3-14, 3-57, 3-58, 3-60, 3-62  
 Manual Tune ..... 3-10, 3-38  
 Marker ..... 3-50  
 Marker → ..... 3-53





## Alphabetical Index

- Parameter Setup ..... 3-14, 3-57, 3-58, 3-60, 3-62
- Parameter Setup Window ..... 4-63
- Parity Bit ..... 3-8, 3-23
- Parser ..... 4-13
- PAS/FAIL ..... 2-9, 3-13, 3-54
- PASS Judge UP/LOW ..... 3-14, 3-63, 3-65
- Pass/Fail ..... 4-30
- Pass/Fail Judgement ON/OFF ..... 3-49
- Pass/Fail judgment ..... 2-79, 3-54
- Pass/Fail ON/OFF ..... 3-13, 3-54
- PBW ..... 3-7, 3-21
- Peak ..... 3-9, 3-33
- Peak → CF ..... 3-12, 3-53
- Peak → Ref ..... 3-12, 3-53
- Peak Delta Y ..... 3-11, 3-12, 3-18, 3-47, 3-50, 3-83
- Peak List Freq ..... 3-12, 3-52
- Peak List Level ..... 3-12, 3-52
- Peak Menu ..... 3-12, 3-50
- Peak search ..... 3-56
- Peak Zoom ..... 3-16, 3-73
- PERFORMANCE VERIFICATION ..... 5-1
- PERFORMANCE VERIFICATION (External Mixer) ..... 6-1
- Performance Verification for OPT73 (FM Demodulation) ..... 5-109
- Performance Verification Record Sheet . . . 5-119
- Performance Verification Test Record Sheets ..... 6-9, 6-22, 6-39, 6-60
- Performing auto tuning ..... 2-30
- Performing the average function ..... 2-40
- Phase Jitter ..... 3-11, 3-48
- Phase Jitter OFF ..... 3-11, 3-48
- Phase Noise ..... 3-11, 3-47
- PHONE connector ..... 2-14
- PK SRCH ..... 2-9, 3-13, 3-56
- Points 1001/501 ..... 3-8, 3-26
- Posi ..... 3-17, 3-77
- Power ..... 4-38, 4-39, 4-40
- Power AVG A(B) ..... 3-17, 3-78
- Power AVG A(B) ON/OFF ..... 3-17, 3-78
- Power cable ..... 1-9
- Power cable options ..... 1-4
- Power Meas OFF ..... 3-14, 3-58
- POWER MEASURE ..... 2-11, 3-14, 3-57
- Power Measurement ..... 3-57
- Power ON ..... 2-19
- Power Requirements ..... 1-7
- POWER switch ..... 2-4, 2-5, 2-6
- Presel ..... 3-10, 3-38
- PRESET ..... 2-10, 3-15, 3-66
- Preset ..... 4-44
- Prev Result ..... 3-14, 3-15, 3-63, 3-64
- Printer ..... 3-8, 3-23
- Printer Command ..... 3-8, 3-24
- PRINTER connector ..... 2-14
- Printing screen data ..... 2-116
- PROBE PWR connector ..... 2-4, 2-5, 2-6
- Procedures of Performance Verification . . . 5-7
- Product Description ..... 1-1
- Protect ..... 3-16, 3-70
- Protecting the data ..... 2-110
- [Q]**
- QP ..... 3-9, 3-33
- [R]**
- R3132 Specifications ..... 7-1
- R3132N Specifications ..... 7-5
- R3162 Specifications ..... 7-9
- R3172 Specifications ..... 7-14
- R3182 Specifications ..... 7-19
- Range ..... 3-18, 3-83
- Range Only ..... 3-18, 3-84
- RBW ..... 2-13
- RBW 120kHz ..... 3-9, 3-33
- RBW 1MHz ..... 3-9, 3-33
- RBW 200Hz ..... 3-9, 3-33
- RBW 9kHz ..... 3-9, 3-33
- RBW Auto ..... 3-9, 3-33
- RBW AUTO/MNL ..... 3-7, 3-20
- RBW Switch ..... 3-7, 3-21
- Reading Data ..... 4-51
- Rear Panel ..... 2-14
- RECALL ..... 2-10, 3-15, 3-67
- Recall ..... 3-15, 3-67
- Ref Level ..... 3-10, 3-42
- Ref Line ..... 3-17, 3-76
- Ref Line ON/OFF ..... 3-9, 3-31
- Ref Offset ON/OFF ..... 3-10, 3-43
- REFERENCE ..... 3-1

- Reference level ..... 2-12
- Remote control usage examples ..... 4-67
- Remote Enable ..... 4-11
- REMOTE lamp ..... 2-10
- REMOTE PROGRAMING ..... 4-1
- Removing the window ..... 2-27
- REN ..... 4-11
- Rename ..... 3-16, 3-70
- REPEAT ..... 3-15, 3-68
- REPEAT (START/STOP) ..... 2-7
- Replacing Parts with Limited Life ..... 1-15
- Res 100Hz ..... 3-9, 3-30
- Res 10Hz ..... 3-9, 3-30
- Res 1Hz ..... 3-9, 3-30
- Res 1kHz ..... 3-9, 3-30
- Reset Marker ..... 3-12, 3-14, 3-52, 3-60
- Residual Response ..... 5-86
- Resolution bandwidth ..... 2-13
- Responses to Interface Messages ..... 4-11
- Results REL/ABS ..... 3-14, 3-61
- RETURN ..... 2-3, 2-18
- Revision ..... 3-8, 3-28
- RF attenuator ..... 2-13
- RF INPUT 1 connector ..... 2-4
- RF INPUT 2 connector ..... 2-4
- RF INPUT connector ..... 2-5, 2-6
- RGB connector ..... 2-14
- Rolloff Factor ..... 3-14, 3-59, 3-61
- RS232 ..... 3-8, 3-23
- RS-232 connector ..... 2-14
- RS-232 Remote Control Function ..... 4-63
- [S]**
- Sample ..... 3-17, 3-77
- Sample Points ..... 3-18, 3-83
- SAVE ..... 2-10, 3-16, 3-69
- Save ..... 3-16, 3-69
- Save Item ..... 3-16, 3-69
- Save Recall ..... 4-43
- Saving Data ..... 2-107, 3-69
- Saving or Recalling Data ..... 2-107
- Screen A/B ..... 3-9, 3-16, 3-18, 3-32, 3-75, 3-83
- Screen Annotation ..... 2-12
- Screen FULL/SEPA/CARRIER ..... 3-14, 3-59
- Screen Reset ..... 3-9, 3-32
- Screen Title ..... 2-119
- SDC ..... 4-12
- Search ALL/UP/LOW ..... 3-12, 3-50
- Selected Device Clear ..... 4-12
- Selecting Menu ..... 2-16
- Self Test ..... 3-16, 3-71
- Sens Range ..... 3-18, 3-83
- Sensitivity ..... 3-18, 3-83
- Sensitivity OFF ..... 3-18, 3-83
- SEPARATE Display ..... 2-67
- Separating Two Signals ..... 2-35
- Serial Polling Enable ..... 4-11
- Setting Date ..... 2-118
- Setting GPIB address ..... 4-10
- Setting Time ..... 2-118
- Setting up the measuring window ..... 2-26
- Setup ..... 3-16, 3-69
- SHIFT ..... 2-10, 3-10, 3-41
- Shift X/Y ..... 3-13, 3-55
- SHIFT, 0(Self Test) ..... 3-16, 3-71
- SHIFT, 1(EMC) ..... 3-9, 3-33
- SHIFT, 7(CAL) ..... 3-7, 3-21
- SHIFT, CONFIG(PRESET) ..... 2-10, 3-15, 3-66, 3-85
- SHIFT, COPY, Abort ..... 3-7, 3-29
- SHIFT, RECALL(SAVE) ..... 2-10, 3-16, 3-69
- Show Result ..... 3-14, 3-63, 3-64
- Sig Track ON/OFF ..... 3-11, 3-12, 3-47, 3-48, 3-51
- Signal Ident ON/OFF ..... 3-10, 3-39
- Signal tacking ..... 2-31
- SINGLE ..... 2-7, 3-16, 3-72
- Single Measure ON/OFF ..... 3-14, 3-17, 3-65, 3-78, 3-79
- Single Sweep ..... 3-72
- Slope (TV Polarity) +/- ..... 3-16, 3-17, 3-74, 3-81
- Slope +/- ..... 3-17, 3-81
- Slope Adj ..... 3-18, 3-83
- Soft key ..... 2-3
- Soft-menu ..... 2-12
- Soft-menu display ..... 2-3
- Sort ..... 3-9, 3-10, 3-13, 3-14, 3-34, 3-38, 3-39, 3-55, 3-59, 3-61
- Sound ..... 3-9, 3-11, 3-34, 3-47
- Sound AM/FM ..... 3-9, 3-11,



**[U]**

UHALP9107 .....	3-9, 3-33
UNCAL message .....	2-13, 2-33
Units .....	3-10, 3-42, 4-14
Units keys .....	2-8
User ANT Corr .....	3-9, 3-34
Using Floppy Disks .....	2-104
Using SHIFT .....	2-18
Using the delta marker .....	2-22
Using the Expansion Function .....	2-104
UTILITY .....	2-11, 3-83
Utility .....	3-83

Zoom Position .....	3-9, 3-32
Zoom Width .....	3-9, 3-32

**[V]**

VBW .....	2-13
VBW AUTO/MNL .....	3-7, 3-20
Video bandwidth .....	2-13
Video Trig .....	3-17, 3-81
View A(B) .....	3-17, 3-77
Volts .....	3-10, 3-42
Volume .....	3-9, 3-11, 3-34, 3-47

**[W]**

Watts .....	3-10, 3-42
Wide RBW ON/OFF .....	3-7, 3-20
Window ON/OFF .....	3-9, 3-31
Window Position .....	3-9, 3-14, 3-31, 3-57
Window Sweep ON/OFF .....	3-9, 3-31
Window Width .....	3-9, 3-14, 3-31, 3-57
Write A(B) .....	3-17, 3-77

**[X]**

X ABS/LFT/CTR .....	3-13, 3-54
XdB Down .....	3-11, 3-45
XdB Left .....	3-11, 3-45
XdB Right .....	3-11, 3-45

**[Y]**

Y ABS/CTR .....	3-13, 3-54
Y ABS/TOP/BOT .....	3-13, 3-54
Year .....	3-8, 3-27
Y-OUT terminal .....	2-14

**[Z]**

Zero Span .....	3-16, 3-73
Zoom .....	3-9, 3-32



## **IMPORTANT INFORMATION FOR ADVANTEST SOFTWARE**

PLEASE READ CAREFULLY: This is an important notice for the software defined herein. Computer programs including any additions, modifications and updates thereof, operation manuals, and related materials provided by Advantest (hereafter referred to as "SOFTWARE"), included in or used with hardware produced by Advantest (hereafter referred to as "PRODUCTS").

### **SOFTWARE License**

All rights in and to the SOFTWARE (including, but not limited to, copyright) shall be and remain vested in Advantest. Advantest hereby grants you a license to use the SOFTWARE only on or with Advantest PRODUCTS.

### **Restrictions**

- (1) You may not use the SOFTWARE for any purpose other than for the use of the PRODUCTS.
- (2) You may not copy, modify, or change, all or any part of, the SOFTWARE without permission from Advantest.
- (3) You may not reverse engineer, de-compile, or disassemble, all or any part of, the SOFTWARE.

### **Liability**

Advantest shall have no liability (1) for any PRODUCT failures, which may arise out of any misuse (misuse is deemed to be use of the SOFTWARE for purposes other than its intended use) of the SOFTWARE. (2) For any dispute between you and any third party for any reason whatsoever including, but not limited to, infringement of intellectual property rights.

## LIMITED WARRANTY

1. Unless otherwise specifically agreed by Seller and Purchaser in writing, Advantest will warrant to the Purchaser that during the Warranty Period this Product (other than consumables included in the Product) will be free from defects in material and workmanship and shall conform to the specifications set forth in this Operation Manual.
2. The warranty period for the Product (the "Warranty Period") will be a period of one year commencing on the delivery date of the Product.
3. If the Product is found to be defective during the Warranty Period, Advantest will, at its option and in its sole and absolute discretion, either (a) repair the defective Product or part or component thereof or (b) replace the defective Product or part or component thereof, in either case at Advantest's sole cost and expense.
4. This limited warranty will not apply to defects or damage to the Product or any part or component thereof resulting from any of the following:
  - (a) any modifications, maintenance or repairs other than modifications, maintenance or repairs (i) performed by Advantest or (ii) specifically recommended or authorized by Advantest and performed in accordance with Advantest's instructions;
  - (b) any improper or inadequate handling, carriage or storage of the Product by the Purchaser or any third party (other than Advantest or its agents);
  - (c) use of the Product under operating conditions or environments different than those specified in the Operation Manual or recommended by Advantest, including, without limitation, (i) instances where the Product has been subjected to physical stress or electrical voltage exceeding the permissible range and (ii) instances where the corrosion of electrical circuits or other deterioration was accelerated by exposure to corrosive gases or dusty environments;
  - (d) use of the Product in connection with software, interfaces, products or parts other than software, interfaces, products or parts supplied or recommended by Advantest;
  - (e) incorporation in the Product of any parts or components (i) provided by Purchaser or (ii) provided by a third party at the request or direction of Purchaser or due to specifications or designs supplied by Purchaser (including, without limitation, any degradation in performance of such parts or components);
  - (f) Advantest's incorporation or use of any specifications or designs supplied by Purchaser;
  - (g) the occurrence of an event of force majeure, including, without limitation, fire, explosion, geological change, storm, flood, earthquake, tidal wave, lightning or act of war; or
  - (h) any negligent act or omission of the Purchaser or any third party other than Advantest.
5. **EXCEPT TO THE EXTENT EXPRESSLY PROVIDED HEREIN, ADVANTEST HEREBY EXPRESSLY DISCLAIMS, AND THE PURCHASER HEREBY WAIVES, ALL WARRANTIES, WHETHER EXPRESS OR IMPLIED, STATUTORY OR OTHERWISE, INCLUDING, WITHOUT LIMITATION, (A) ANY WARRANTY OF MERCHANTABILITY OR FITNESS FOR A PARTICULAR PURPOSE AND (B) ANY WARRANTY OR REPRESENTATION AS TO THE VALIDITY, SCOPE, EFFECTIVENESS OR USEFULNESS OF ANY TECHNOLOGY OR ANY INVENTION.**
6. **THE REMEDY SET FORTH HEREIN SHALL BE THE SOLE AND EXCLUSIVE REMEDY OF THE PURCHASER FOR BREACH OF WARRANTY WITH RESPECT TO THE PRODUCT.**
7. **ADVANTEST WILL NOT HAVE ANY LIABILITY TO THE PURCHASER FOR ANY INDIRECT, INCIDENTAL, SPECIAL, CONSEQUENTIAL OR PUNITIVE DAMAGES, INCLUDING, WITHOUT LIMITATION, LOSS OF ANTICIPATED PROFITS OR REVENUES, IN ANY AND ALL CIRCUMSTANCES, EVEN IF ADVANTEST HAS BEEN ADVISED OF THE POSSIBILITY OF SUCH DAMAGES AND WHETHER ARISING OUT OF BREACH OF CONTRACT, WARRANTY, TORT (INCLUDING, WITHOUT LIMITATION, NEGLIGENCE), STRICT LIABILITY, INDEMNITY, CONTRIBUTION OR OTHERWISE. TORT (INCLUDING, WITHOUT LIMITATION, NEGLIGENCE), STRICT LIABILITY, INDEMNITY, CONTRIBUTION OR OTHERWISE.**
8. **OTHER THAN THE REMEDY FOR THE BREACH OF WARRANTY SET FORTH HEREIN, ADVANTEST SHALL NOT BE LIABLE FOR, AND HEREBY DISCLAIMS TO THE FULLEST EXTENT PERMITTED BY LAW ANY LIABILITY FOR, DAMAGES FOR PRODUCT FAILURE OR DEFECT, WHETHER ARISING OUT OF BREACH OF CONTRACT, TORT (INCLUDING, WITHOUT LIMITATION, NEGLIGENCE), STRICT LIABILITY, INDEMNITY, CONTRIBUTION OR OTHERWISE.**



## **CUSTOMER SERVICE DESCRIPTION**

In order to maintain safe and trouble-free operation of the Product and to prevent the incurrence of unnecessary costs and expenses, Advantest recommends a regular preventive maintenance program under its maintenance agreement.

Advantest's maintenance agreement provides the Purchaser on-site and off-site maintenance, parts, maintenance machinery, regular inspections, and telephone support and will last a maximum of ten years from the date the delivery of the Product. For specific details of the services provided under the maintenance agreement, please contact the nearest Advantest office listed at the end of this Operation Manual or Advantest's sales representatives.

Some of the components and parts of this Product have a limited operating life (such as, electrical and mechanical parts, fan motors, unit power supply, etc.). Accordingly, these components and parts will have to be replaced on a periodic basis. If the operating life of a component or part has expired and such component or part has not been replaced, there is a possibility that the Product will not perform properly. Additionally, if the operating life of a component or part has expired and continued use of such component or part damages the Product, the Product may not be repairable. Please contact the nearest Advantest office listed at the end of this Operation Manual or Advantest's sales representatives to determine the operating life of a specific component or part, as the operating life may vary depending on various factors such as operating condition and usage environment.

## SALES & SUPPORT OFFICES

Advantest Korea Co., Ltd.

22BF, Kyobo KangNam Tower,  
1303-22, Seocho-Dong, Seocho-Ku, Seoul #137-070, Korea  
Phone: +82-2-532-7071  
Fax: +82-2-532-7132

Advantest (Suzhou) Co., Ltd.

Shanghai Branch Office:  
Bldg. 6D, NO.1188 Gumei Road, Shanghai, China 201102 P.R.C.  
Phone: +86-21-6485-2725  
Fax: +86-21-6485-2726

Shanghai Branch Office:  
406/F, Ying Building, Quantum Plaza, No. 23 Zhi Chun Road,  
Hai Dian District, Beijing,  
China 100083  
Phone: +86-10-8235-3377  
Fax: +86-10-8235-6717

Advantest (Singapore) Pte. Ltd.

438A Alexandra Road, #08-03/06  
Alexandra Technopark Singapore 119967  
Phone: +65-6274-3100  
Fax: +65-6274-4055

Advantest America, Inc.

3201 Scott Boulevard, Suite, Santa Clara, CA 95054, U.S.A  
Phone: +1-408-988-7700  
Fax: +1-408-987-0691

ROHDE & SCHWARZ Europe GmbH

Mühlendorfstraße 15 D-81671 München, Germany  
(P.O.B. 80 14 60 D-81614 München, Germany)  
Phone: +49-89-4129-13711  
Fax: +49-89-4129-13723

**ADVANTEST**<sup>®</sup>

<http://www.advantest.co.jp>

---

ADVANTEST CORPORATION  
Shin-Marunouchi Center Building, 1-6-2 Marunouchi, Chiyoda-ku, Tokyo 100-0005, Japan  
Phone: +81-3-3214-7500