ADVANTEST[®]
ADVANTEST CORPORATION

Q8384

Optical Spectrum Analyzer

Operation Manual

MANUAL NUMBER FOE-8335041E00

Safety Summary

To ensure thorough understanding of all functions and to ensure efficient use of this instrument, please read the manual carefully before using. Note that Advantest bears absolutely no responsibility for the result of operations caused due to incorrect or inappropriate use of this instrument.

If the equipment is used in a manner not specified by Advantest, the protection provided by the equipment may be impaired.

- **Warning Labels**

Warning labels are applied to Advantest products in locations where specific dangers exist. Pay careful attention to these labels during handling. Do not remove or tear these labels. If you have any questions regarding warning labels, please ask your nearest Advantest dealer. Our address and phone number are listed at the end of this manual.

Symbols of those warning labels are shown below together with their meaning.

DANGER: Indicates an imminently hazardous situation which will result in death or serious personal injury.

WARNING: Indicates a potentially hazardous situation which will result in death or serious personal injury.

CAUTION: Indicates a potentially hazardous situation which will result in personal injury or a damage to property including the product.

- **Basic Precautions**

Please observe the following precautions to prevent fire, burn, electric shock, and personal injury.

- Use a power cable rated for the voltage in question. Be sure however to use a power cable conforming to safety standards of your nation when using a product overseas.
- When inserting the plug into the electrical outlet, first turn the power switch OFF and then insert the plug as far as it will go.
- When removing the plug from the electrical outlet, first turn the power switch OFF and then pull it out by gripping the plug. Do not pull on the power cable itself. Make sure your hands are dry at this time.
- Before turning on the power, be sure to check that the supply voltage matches the voltage requirements of the instrument.
- Connect the power cable to a power outlet that is connected to a protected ground terminal. Grounding will be defeated if you use an extension cord which does not include a protected ground terminal.
- Be sure to use fuses rated for the voltage in question.
- Do not use this instrument with the case open.
- Do not place anything on the product and do not apply excessive pressure to the product. Also, do not place flower pots or other containers containing liquid such as chemicals near this

product.

- When the product has ventilation outlets, do not stick or drop metal or easily flammable objects into the ventilation outlets.
- When using the product on a cart, fix it with belts to avoid its drop.
- When connecting the product to peripheral equipment, turn the power off.

- **Caution Symbols Used Within this Manual**

Symbols indicating items requiring caution which are used in this manual are shown below together with their meaning.

DANGER: Indicates an item where there is a danger of serious personal injury (death or serious injury).

WARNING: Indicates an item relating to personal safety or health.

CAUTION: Indicates an item relating to possible damage to the product or instrument or relating to a restriction on operation.

- **Safety Marks on the Product**

The following safety marks can be found on Advantest products.



: ATTENTION - Refer to manual.



: Protective ground (earth) terminal.



: DANGER - High voltage.



: CAUTION - Risk of electric shock.

- **Replacing Parts with Limited Life**

The following parts used in the instrument are main parts with limited life.

Replace the parts listed below before their expected lifespan has expired to maintain the performance and function of the instrument.

Note that the estimated lifespan for the parts listed below may be shortened by factors such as the environment where the instrument is stored or used, and how often the instrument is used.

The parts inside are not user-replaceable. For a part replacement, please contact the Advantest sales office for servicing.

Each product may use parts with limited life.

For more information, refer to the section in this document where the parts with limited life are described.

Main Parts with Limited Life

Part name	Life
Unit power supply	5 years
Fan motor	5 years
Electrolytic capacitor	5 years
LCD display	6 years
LCD backlight	2.5 years
Floppy disk drive	5 years
Memory backup battery	5 years

- **Hard Disk Mounted Products**

The operational warnings are listed below.

- Do not move, shock and vibrate the product while the power is turned on.
Reading or writing data in the hard disk unit is performed with the memory disk turning at a high speed. It is a very delicate process.
- Store and operate the products under the following environmental conditions.
An area with no sudden temperature changes.
An area away from shock or vibrations.
An area free from moisture, dirt, or dust.
An area away from magnets or an instrument which generates a magnetic field.
- Make back-ups of important data.
The data stored in the disk may become damaged if the product is mishandled. The hard disc has a limited life span which depends on the operational conditions. Note that there is no guarantee for any loss of data.

- **Precautions when Disposing of this Instrument**

When disposing of harmful substances, be sure dispose of them properly with abiding by the state-provided law.

Harmful substances: (1) PCB (polycarbon biphenyl)
(2) Mercury
(3) Ni-Cd (nickel cadmium)
(4) Other
Items possessing cyan, organic phosphorous and hexadic chromium and items which may leak cadmium or arsenic (excluding lead in solder).

Example: fluorescent tubes, batteries

Environmental Conditions

This instrument should be only be used in an area which satisfies the following conditions:

- An area free from corrosive gas
- An area away from direct sunlight
- A dust-free area
- An area free from vibrations
- Altitude of up to 2000 m

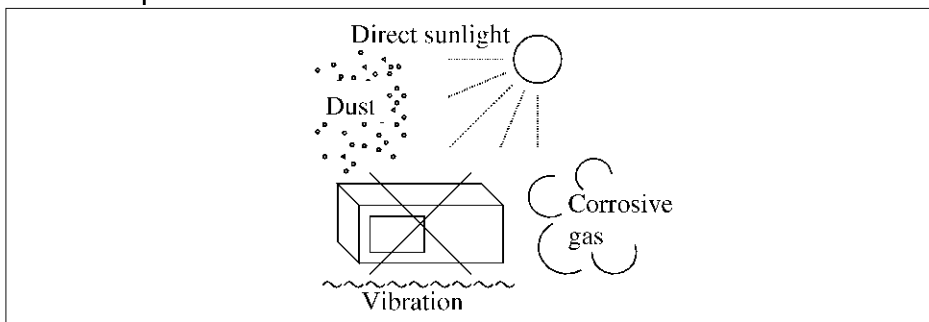

Figure-1 Environmental Conditions

- Operating position

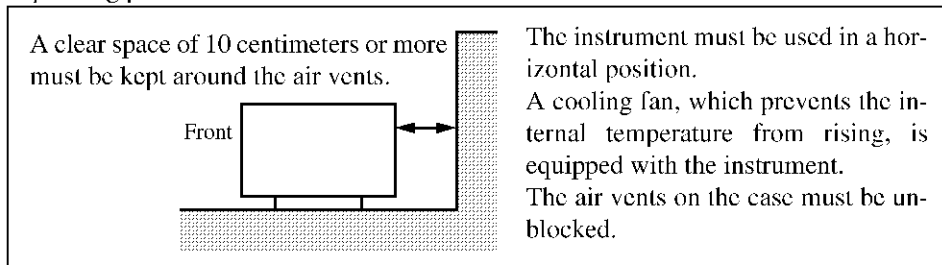

Figure-2 Operating Position

- Storage position

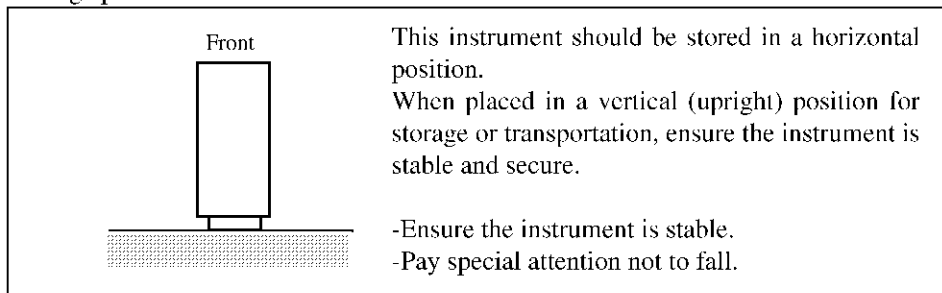

Figure-3 Storage Position

- The classification of the transient over-voltage, which exists typically in the main power supply, and the pollution degree is defined by IEC61010-1 and described below.

Impulse withstand voltage (over-voltage) category II defined by IEC60364-4-443

Pollution Degree 2

Types of Power Cable

Replace any references to the power cable type, according to the following table, with the appropriate power cable type for your country.

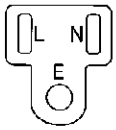
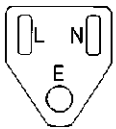
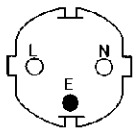
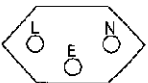
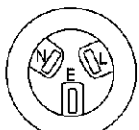
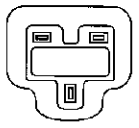
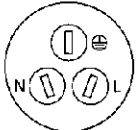
Plug configuration	Standards	Rating, color and length	Model number (Option number)
	PSE: Japan Electrical Appliance and Material Safety Law	125 V at 7 A Black 2 m (6 ft)	Straight: A01402 Angled: A01412
	UL: United States of America CSA: Canada	125 V at 7 A Black 2 m (6 ft)	Straight: A01403 (Option 95) Angled: A01413
	CEE: Europe DEMKO: Denmark NEMKO: Norway VDE: Germany KEMA: The Netherlands CEBEC: Belgium OVE: Austria FIMKO: Finland SEMKO: Sweden	250 V at 6 A Gray 2 m (6 ft)	Straight: A01404 (Option 96) Angled: A01414
	SEV: Switzerland	250 V at 6 A Gray 2 m (6 ft)	Straight: A01405 (Option 97) Angled: A01415
	SAA: Australia, New Zealand	250 V at 6 A Gray 2 m (6 ft)	Straight: A01406 (Option 98) Angled: -----
	BS: United Kingdom	250 V at 6 A Black 2 m (6 ft)	Straight: A01407 (Option 99) Angled: A01417
	CCC: China	250 V at 10 A Black 2 m (6 ft)	Straight: A114009 (Option 94) Angled: A114109

Certificate of Conformity



This is to certify, that

Optical Spectrum Analyzer

Q8384

instrument, type, designation

complies with the provisions of the EMC Directive 89/336/EEC in accordance with EN61326 and Low Voltage Directive 73/23/EEC in accordance with EN61010.

ADVANTEST Corp.

Tokyo, Japan

ROHDE&SCHWARZ

Engineering and Sales GmbH

Munich, Germany

8384.02

PREFACE

This manual provides the information necessary to check functionality, operate and program the Q8384 Optical Spectrum Analyzer Operation. Be sure to read this manual carefully in order to use the Optical Spectrum Analyzer safely.

- Organization of this manual
This manual consists of the following chapters:

Safety Summary	To use the analyzer safely, be sure to read this manual first.
1. Introduction <ul style="list-style-type: none"> • Product Description • Standard Accessories and Power Cable Options • Operating Environment • Operation Check • Setting the Print Paper • Cleaning, Storing and Transporting 	Includes a description of the Optical Spectrum Analyzer and its' parts along with information on its' operating environment and how to perform a system checkout.
2. Operation <ul style="list-style-type: none"> • Controls and Connectors on the Front and Rear Panels • Screen Annotation • Basic Operation • Measurement Examples • Expanded Functions 	Describes the names and the functions of each part on the panels. You can learn the basic operation of the Optical Spectrum Analyzer through the examples shown in this chapter.
3. Reference <ul style="list-style-type: none"> • Menu Index • Menu Map • Functional Description 	Shows a list of operation keys, and describes the function of each key.
4. Remote Control <ul style="list-style-type: none"> • GPIB 	Gives an outline of the GPIB interface, and how to connect and set them up. Also included are a list of commands necessary for programming and using the program examples.
5. Technical Notes <ul style="list-style-type: none"> • Technical Notes • Operation Principle • Block Diagram 	Describes the principle of operation necessary for taking measurements more accurately.
6. Specifications	Shows the specifications of the Optical Spectrum Analyzer.
Appendix <ul style="list-style-type: none"> • Glossary 	Terminology related to the Optical Spectrum Analyzer is explained in this section.

Preface

- Key notations in this manual
Typeface conventions used in this manual.

Panel keys: In bold type

Example: **MAG, SYSTEM**

Soft keys: In bold and italic type

Example: ***CENTER, PRESET***

TABLE OF CONTENTS

1	INTRODUCTION	1-1
1.1	Product Overview	1-1
1.2	Accessories, Option and Limited-life Part	1-2
1.2.1	Standard Accessories	1-2
1.2.2	Option and Accessories	1-2
1.2.3	Limited-life Part	1-2
1.3	Operating Environment	1-4
1.3.1	Environmental Conditions	1-4
1.3.2	Power Requirements	1-5
1.3.3	Power Fuse	1-6
1.3.4	Power Cable	1-7
1.4	System Checkout	1-8
1.5	Setting the Print Paper	1-9
1.6	Cleaning, Storing and Transporting the Q8384 Optical Spectrum Analyzer	1-10
1.6.1	Cleaning	1-10
1.6.2	Storing	1-10
1.6.3	Replacing and Cleaning the Optical-Connector Adapter of Q8384	1-11
1.6.4	Transporting	1-13
1.7	Warm-up time	1-13
1.8	About Calibration	1-13
2	OPERATION	2-1
2.1	Panel Description	2-1
2.1.1	Front Panel	2-1
2.1.1.1	LCD Display Section	2-2
2.1.1.2	FUNCTION Section	2-3
2.1.1.3	CURSOR Section	2-4
2.1.1.4	MEASURE Section	2-4
2.1.1.5	DATA Section	2-5
2.1.1.6	DISPLAY Section	2-6
2.1.1.7	DATA OUT Section	2-7
2.1.1.8	GP-IB Section	2-7
2.1.1.9	Connector Section	2-8
2.1.1.10	POWER Switch/Floppy Disk Drive Section	2-8
2.1.2	Screen Annotation	2-9
2.1.3	Rear Panel	2-11
2.2	Basic Operation	2-12
2.2.1	Operating Menus and Entering Data	2-12
2.2.2	Light Spectrum Measurement	2-14
2.2.3	Peak Power Monitor Measurement	2-21
2.2.4	Alignment	2-24

Table of Contents

2.2.5	Calibration	2-26
2.2.6	Measuring the Transmission-wavelength (or Loss-wavelength) Characteristics	2-29
2.2.7	ACPR (Adjacent Channel Leakage Power Ratio) Measurement	2-34
2.2.8	Light Amplifier Characteristic Analysis	2-37
2.2.9	WDM Light Signal Characteristic Analysis	2-41
2.2.10	WDM Optical Signal Measurements Using the Monitoring Function	2-45
2.2.11	Limit Line Function for Device Evaluation	2-52
2.2.12	Setting Measurement Conditions	2-55
2.3	Using Expanded Functions and Inputting/Outputting Data	2-61
2.3.1	Entering Label Data	2-61
2.3.2	Selecting Color Patterns on the Screen	2-62
2.3.3	Setting Date/Time	2-62
2.3.4	Saving or Reading Data	2-63
2.3.4.1	Floppy Disk	2-63
2.3.4.2	Backup Memory	2-64
2.3.4.3	Saving Data	2-64
2.3.4.4	Reading Data	2-65
2.3.5	Outputting Data (Hard Copy)	2-66
2.3.5.1	Internal printer	2-66
2.3.5.2	External printer	2-66
2.3.5.3	Floppy disk	2-67
3	REFERENCE	3-1
3.1	Menu Index	3-1
3.2	Menu Map	3-6
3.3	Functional Description	3-18
3.3.1	CENTER Key	3-18
3.3.2	SPAN Key	3-19
3.3.3	REF LEVEL Key	3-20
3.3.4	LEVEL SCALE Key	3-21
3.3.5	RESOLUTION Key	3-22
3.3.6	SWEEP MODE Key	3-23
3.3.7	AVG Key	3-25
3.3.8	AUTO Key	3-26
3.3.9	SINGLE Key	3-26
3.3.10	REPEAT Key	3-26
3.3.11	STOP Key	3-26
3.3.12	NORMALIZE LOSS/TRANS Key	3-27
3.3.13	APPLICATION Key	3-28
3.3.14	ADVANCE Key	3-41
3.3.15	ON/OFF Key	3-42
3.3.16	λ 1 Key	3-42

3.3.17	$\lambda 2$ Key	3-42
3.3.18	L1 Key	3-42
3.3.19	L2 Key	3-43
3.3.20	CONTROL Key	3-43
3.3.21	SAVE Key	3-45
3.3.22	RECALL Key	3-46
3.3.23	DEVICE Key	3-47
3.3.24	COPY Key	3-50
3.3.25	FEED Key	3-50
3.3.26	LOCAL Key	3-50
3.3.27	INSTR PRESET Key	3-50
3.3.28	CAL Key	3-51
3.3.29	LABEL Key	3-52
3.4	List of Settings	3-53
3.4.1	Defaults Configuration Values	3-53
4	REMOTE CONTROL	4-1
4.1	GPIB Command Index	4-1
4.2	Overview of GPIB	4-4
4.3	Interface Functions	4-5
4.4	Program Code	4-6
4.5	Talker Formats (Data Output Formats)	4-7
4.6	Device Triggering Function	4-33
4.7	Device Clear Function	4-33
4.8	State Changes According to the Commands	4-34
4.9	Status Byte	4-35
4.10	GPIB Command Codes	4-36
4.11	Example Programs	4-50
4.11.1	Sample Programs for Setting or Reading Measurement Conditions	4-50
5	TECHNICAL NOTES	5-1
5.1	Measurement Modes	5-1
5.2	Averaging Functions	5-2
5.3	Calculating the Spectral Width and the Notch Width	5-3
5.3.1	Calculating the Spectral Width	5-3
5.3.1.1	PEAK THRESHOLD	5-3
5.3.1.2	ENVELOPE	5-4
5.3.1.3	RMS	5-4
5.3.1.4	Peak RMS	5-5
5.3.1.5	Xnm Level	5-5
5.3.2	Notch Width	5-6
5.3.2.1	XdB WIDTH	5-6
5.3.2.2	Xnm Level	5-7

Table of Contents

5.4	GAIN&NF and SNR	5-8
5.4.1	GAIN	5-10
5.4.2	NF	5-10
5.4.3	SPE DIV	5-11
5.5	Optical BPF Analysis	5-12
5.5.1	Calculating Various Bands	5-12
5.5.2	Calculating Isolation	5-14
5.5.3	Output Data	5-16
5.6	Tilt Calculation Function	5-17
5.6.1	Filter Tilt	5-17
5.6.1.1	Output Data	5-17
5.7	LD Performance Analysis	5-18
5.7.1	DFB-LD	5-18
5.7.1.1	Output Data	5-18
5.7.2	FP-LD	5-18
5.7.2.1	Output Data	5-18
5.7.3	LED	5-20
5.7.3.1	Output Data	5-20
5.8	ACPR (Adjacent Channel Leakage Power Ratio)	5-21
5.8.1	Output Data	5-21
5.9	Auto-Panning and Auto-Zooming Functions	5-22
5.10	Cursor Modes and Explanation for Displayed Data	5-23
5.11	Setting Limit Line	5-24
5.11.1	Data Files	5-24
5.11.2	Limit Line Data	5-24
5.12	Operation Principle	5-28
5.13	Notes on Using the Optical Spectrum Analyzer	5-31
5.13.1	Optical Fibers Suitable for the Optical Spectrum Analyzer	5-31
5.13.2	Stray Light	5-31
5.13.3	Secondary Diffracted Light	5-31
6	SPECIFICATIONS	6-1
	APPENDIX	A-1
A.1	Error Messages	A-1
A.2	Other Messages	A-2
A.3	Example of a Spectrum Data File on a Floppy Disk	A-2
	DIMENSIONAL OUTLINE DRAWING	EXT-1
	ALPHABETICAL INDEX	I-1

LIST OF ILLUSTRATIONS

No.	Title	Page
1-1	Operating Environment	1-4
1-2	Replacing the Power Fuse	1-6
1-3	Power Cable	1-7
1-4	Setting the Print Paper	1-9
1-5	Light Input Part Structure	1-12
2-1	Front Panel	2-1
2-2	LCD Display Section	2-2
2-3	FUNCTION Section	2-3
2-4	CURSOR Section	2-4
2-5	MEASURE Section	2-4
2-6	DATA Section	2-5
2-7	DISPLAY Section	2-6
2-8	DATA OUT Section	2-7
2-9	GP-IB Section	2-7
2-10	Connector Section	2-8
2-11	POWER Switch and Floppy Disk Drive Section	2-8
2-12	Screen Annotation	2-9
2-13	Rear Panel	2-11
2-14	CENTER Menu	2-12
2-15	Self-test Screen	2-14
2-16	INSTR PRESET Menu	2-15
2-17	Light Spectrum Measurement	2-15
2-18	Input Window	2-16
2-19	Setting the Center Wavelength	2-16
2-20	Displaying the Spectrum	2-17
2-21	Peak Search	2-18
2-22	Changing the Center Wavelength	2-18
2-23	Displaying the Cursor	2-19
2-24	Setting the Analysis Span	2-19
2-25	Setting the Analysis Span-1	2-20
2-26	Setting the Analysis Span-2	2-20
2-27	Peak Power Monitor Measurement	2-21
2-28	Displaying the Spectrum	2-22
2-29	Displaying Input Light Changes in Time	2-23
2-30	Connecting the Calibration Signal	2-24
2-31	Alignment Execution Message	2-25
2-32	Connecting the Calibration Signal	2-26
2-33	Calibration Execution Message	2-27
2-34	Connecting the Calibration Signal	2-28
2-35	Calibration Execution Message	2-28
2-36	Connecting the White Light Source	2-29
2-37	Saving the Reference Spectrum	2-30
2-38	Connecting the White Light Source	2-30
2-39	Loss-wavelength Characteristics (Zooming function with LOSS/TRANS)	2-31
2-40	Transmission-wavelength Characteristics (Zooming function with LOSS/TRANS)	2-31

List of Illustrations

No.	Title	Page
2-41	O-BPF Analysis Mode Screen	2-32
2-42	O-BPF PARAMETER Dialog Box	2-32
2-43	The Screen after the Calculation Using the Changed Parameters	2-33
2-44	Connecting the Calibration Signal	2-34
2-45	Input Signal Measurement	2-35
2-46	ACPR Mode Screen	2-35
2-47	ACPR Parameter Dialog Box	2-36
2-48	ACPR Measurement	2-36
2-49	Measuring the Input Signal	2-38
2-50	Saving the Reference Data	2-38
2-51	Measuring the Output Signal	2-39
2-52	Optical AMP PARAMETER Dialog Box	2-39
2-53	Input Signal Connections	2-41
2-54	Measuring the Input Signal	2-42
2-55	Displaying Multiple Peaks	2-43
2-56	Displaying Relative Values	2-44
2-57	Displaying SNR	2-44
2-58	WDM Signal Connections	2-45
2-59	Measuring the Spectrum of a WDM Signal	2-46
2-60	WDM Monitor Screen	2-46
2-61	WDM Dialog Box Screen	2-47
2-62	WDM Monitor Measurement Screen	2-48
2-63	Displaying WDM Monitor SNR	2-49
2-64	Displaying WDM Monitor Level	2-49
2-65	Displaying WDM Monitor Relative Values (INITIAL)	2-50
2-66	Displaying WDM Monitor Relative Values (NOMINAL)	2-50
2-67	Displaying WDM Monitor Channels	2-51
2-68	Measuring the Reference Data Used for Filter Transmission Characteristics	2-52
2-69	Displaying the Limit Line	2-53
2-70	Connections Used for Device Evaluation	2-54
2-71	Transmission Characteristics of a Device to Be Evaluated (with the Limit Line Displayed)	2-54
2-72	Label Data	2-61
2-73	Selecting the Floppy Disk	2-68
5-1	Optical BPF (Calculating Various Bands)	5-13
5-2	Optical BPF (Calculating Isolation)	5-15
5-3	Filter Tilt	5-17
5-4	DFB-LD	5-19
5-5	FP-LD	5-19
5-6	LED	5-20
5-7	ACPR	5-21
5-8	Block Diagram	5-28

LIST OF TABLES

No.	Title	Page
1-1	Standard Accessories List	1-2
1-2	Option	1-2
1-3	Accessories (Sold Separately)	1-2
1-4	Limited-life Part	1-2
1-5	Power Cable Options	1-3
1-6	Power Supply Specifications	1-5
2-1	Status Display Contents	2-10
2-2	Recommended Printers	2-66
3-1	The Scale Change of the I.f Mode	3-33
3-2	Changing the Data Display and the Current Time or Channel	3-36
3-3	Default Settings (1 of 6)	3-53
4-1	Interface Functions	4-5
4-2	Initial State After Turning the Power On	4-33
4-3	State Changes According to the Commands	4-34
4-4	FUNCTION (1 of 2)	4-36
4-6	LABEL	4-38
4-7	MEASURE	4-38
4-5	CURSOR	4-38
4-8	DISPLAY (1 of 7)	4-39
4-9	DATA OUT	4-46
4-10	Codes Corresponding to Other Keys	4-47
4-11	Controlling Data Output and Others (1 of 3)	4-47
4-12	Error Codes Associated with the Self-diagnosis Function	4-49
5-1	Throughput, Sensitivity and Dynamic Range for Each Measurement Mode at a Wavelength of 1.55 μm (typical value)	5-2
5-2	Number of Signals and Interpolation Method.	5-9

1 INTRODUCTION

This chapter provides the following information:

- Product description
- A list of standard accessories and power cable options
- Operating environment
- How to verify that the spectrum analyzer is functioning properly
- How to set the print paper
- How to clean, store, and transport the spectrum analyzer

1.1 Product Overview

The Q8384 is an optical spectrum analyzer of the spread spectral method using the diffraction grating monochromator.

The features of the optical spectrum analyzer are as follows:

- (1) Performance compliant with optical communication devices such as EDFA, AWG and the fiber grating.
 - Wavelength resolution: 10 pm or higher
 - Wide dynamic range: 60 dB or more
 - High wavelength accuracy: ± 20 pm
 - Polarization dependency: ± 0.05 dB
- (2) WDM analysis function
Using the EDFA analysis function (with WDM) and the relationships between wavelengths and levels are easily observed by displaying a list of wavelengths.
- (3) Optical connectors that can be replaced by the user
Users can easily replace optical connector types FC, SC and ST.
- (4) Operability and a large-size color LCD
Measurements are taken easier than earlier models by use of operability-minded panel key arrangement and soft menus. In addition, the display is now of an 8.4-inch high-intensity TFT color LCD to offer you more visibility.
- (5) Printer output
A high-speed thermo-sensitive printer is equipped as standard to output the screen data. Furthermore, the optical spectrum analyzer is equipped with a port which is used for a printer format ESC/P, ESC/P-R or PCL.
- (6) 3.5-inch floppy disk drive
This drive is used to save measurement data and set conditions. The measurement data is saved in text format. This data, however, can be saved in bitmap format as screen image so that you can analyze it or make reports on an external computer.

1.2 Accessories, Option and Limited-life Part

1.2 Accessories, Option and Limited-life Part

The standard accessories shipped with the spectrum analyzer are listed in Table 1-1. The option, the accessories separately sold, and the parts with limited-life are listed in Tables 1-2, 1-3 and 1-4, respectively. If any of the accessories are damaged or missing or, to order additional accessories, contact a sales representative.

1.2.1 Standard Accessories

Table 1-1 Standard Accessories List

Accessory Name	Model Number	Quantity	Remarks
Power cable	A01402	1	*1
Power fuse	EAWK3.15A	1	3.15A (including the fuse holder)
Print paper	A09075 *2	1	Thermal paper with 114 mm wide, 1 roll
3.5-inch floppy disk	---	1	2HD
Operation Manual	EQ8384	1	English version

*1: The cable supplied with the optical spectrum analyzer depends on what type (specified by model number above) was ordered when the optical spectrum analyzer was purchased. There are 11 types of power cable available (see Table 1-5). To order another power cable, contact a sales representative. When ordering, refer to power cables by their option number or model number.

*2: You can order in boxes (each box contains five rolls) by specifying this code.

1.2.2 Option and Accessories

Table 1-2 Option

Accessory Name	Model Number	Remarks
Light source used for calibration	Option 25	Factory option

Table 1-3 Accessories (Sold Separately)

Accessory Name	Model Number	Remarks
SC connector	A08162	Optical connector
ST connector	A08163	Optical connector
FC connector	A08161	Optical connector

1.2.3 Limited-life Part

The fan filter should be replaced when it becomes clogged with dirt and cannot be cleaned well, or when it is broken. If you need a replacement filter, contact your sales representative or the nearest ADVANTEST sales office.

Table 1-4 Limited-life Part

Accessory Name	Model Number	Remarks
Fan filter	YEE-002124	Comes with the plastic guard.

Table 1-5 Power Cable Options

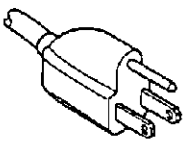
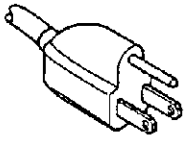
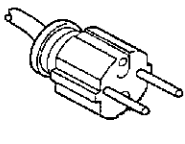
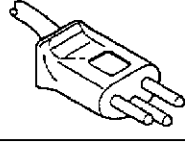
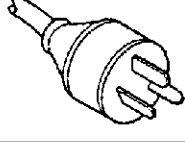
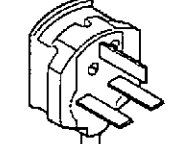
Plug configuration	Standards	Rating, color and length	Model number (Option number)
	JIS: Japan Law on Electrical Appliances	125 V at 7 A Black 2 m (6 ft)	Straight: A01402 Angled: A01412
	UL: United States of America CSA: Canada	125 V at 7 A Black 2 m (6 ft)	Straight: A01403 (Option 95) Angled: A01413
	CEE: Europe DEMKO: Denmark NEMKO: Norway VDE: Germany KEMA: The Netherlands CEBEC: Belgium OVE: Austria FIMKO: Finland SEMKO: Sweden	250 V at 6 A Gray 2 m (6 ft)	Straight: A01404 (Option 96) Angled: A01414
	SEV: Switzerland	250 V at 6 A Gray 2 m (6 ft)	Straight: A01405 (Option 97) Angled: A01415
	SAA: Australia, New Zealand	250 V at 6 A Gray 2 m (6 ft)	Straight: A01406 (Option 98) Angled: -----
	BS: United Kingdom	250 V at 6 A Black 2 m (6 ft)	Straight: A01407 (Option 99) Angled: A01417

1.3 Operating Environment

1.3 Operating Environment

This section describes the environmental conditions and power requirements necessary to use the optical spectrum analyzer.

1.3.1 Environmental Conditions

The Q8384 should be only be used in an area which satisfies the following conditions:

- Ambient temperature: 10 °C to +40 °C (operating temperature)
- Relative humidity: 85% or less (without condensation)
- An area free from corrosive gas
- An area away from direct sunlight
- A dust-free area
- An area free from vibrations
- A low noise area

Although the Q8384 has been designed to withstand a certain amount of noise riding on the AC power line, it should be used in an area of low noise. Use a noise cut filter when ambient noise is unavoidable.

- Installation position

The Q8384 has an exhaust cooling fan on the rear panel. Never block the area of this fan since the resulting internal temperature rise will affect measurement accuracy. In addition, use this instrument in a horizontal position at a maximum angle of 10 °, or the measurement may be inaccurate.

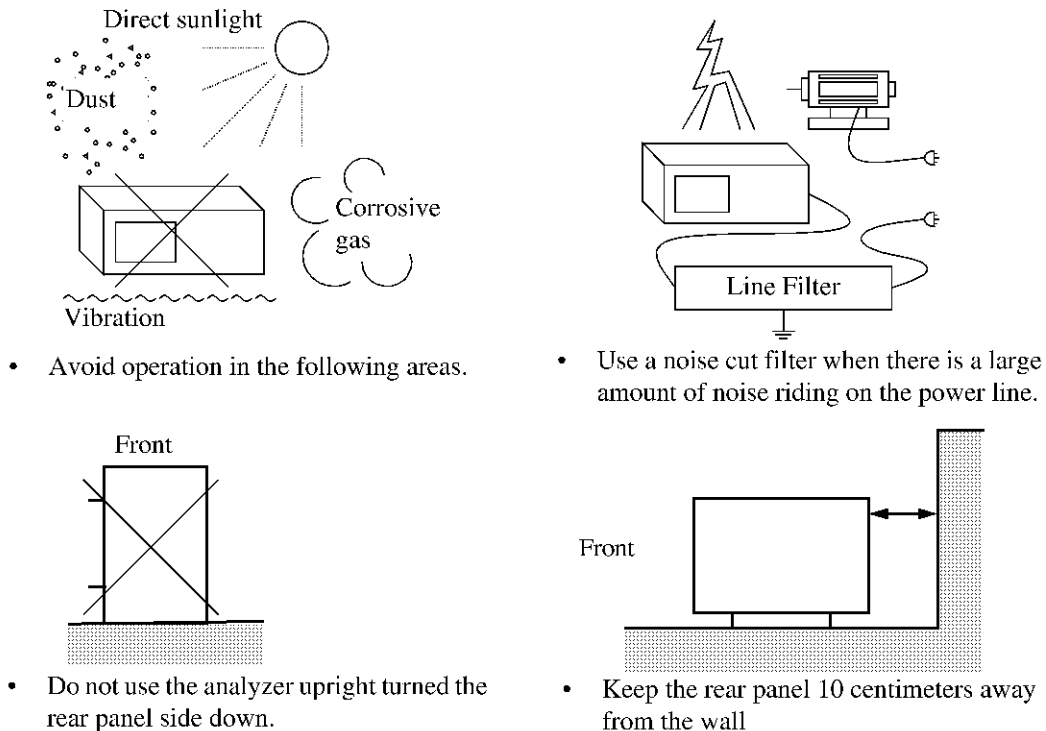

Figure 1-1 Operating Environment

The Q8384 can be used safely under the following conditions:

- Altitude: 2000 m maximum above the sea level
- Installation category II
- Pollution degree 2

1.3.2 Power Requirements

The power supply specifications of the optical spectrum analyzer are listed in Table 1-6.

Table 1-6 Power Supply Specifications

	100 VAC Operation	200 VAC Operation	Remarks
Input voltage range	90 V to 132 V	198 V to 250 V	Automatically switches between input levels of 100 VAC and 200 VAC.
Frequency range	48 Hz to 66 Hz		
Power consumption	220 VA or below		

CAUTION: *To prevent damage, operate the optical spectrum analyzer within the specified input voltage and frequency ranges.*

1.3.3 Power Fuse

1.3.3 Power Fuse

The power fuse is placed in the fuse holder which is mounted on the rear panel. A spare fuse is located in the fuse holder.

To check or replace the power fuse, use the following procedure:

1. Press the **POWER** switch to the OFF position.
2. Disconnect the power cable from the AC power supply.
3. Remove the fuse holder on the rear panel.
4. Check (and replace if necessary) the power fuse and put it back in the fuse holder.

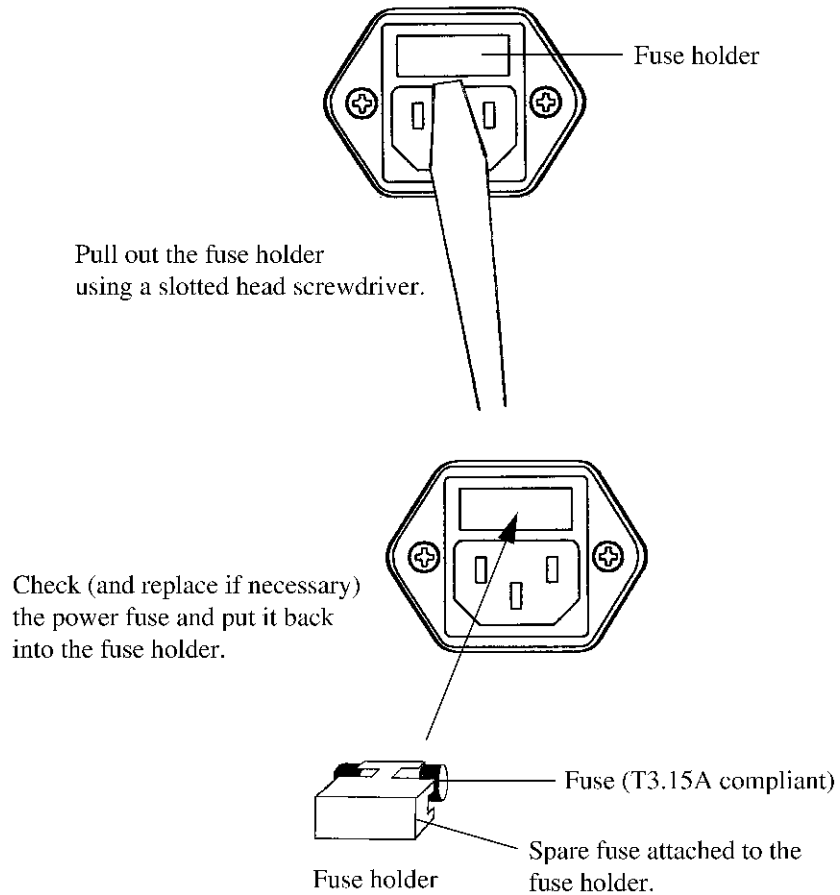

Figure 1-2 Replacing the Power Fuse

1.3.4 Power Cable

CAUTION:

1. Use a power cable rated for the voltage in question. Be sure however to use a power cable conforming to safety standards of your nation when using a product overseas (See Table 1-5).
 2. Be sure to plug the power cable into an electrical outlet which has a safety ground terminal. Grounding will be defeated if you use an extension cord which does not include a safety ground terminal.
 3. Turn the **POWER** switch (on the front panel) off prior to connecting the power cable.
-

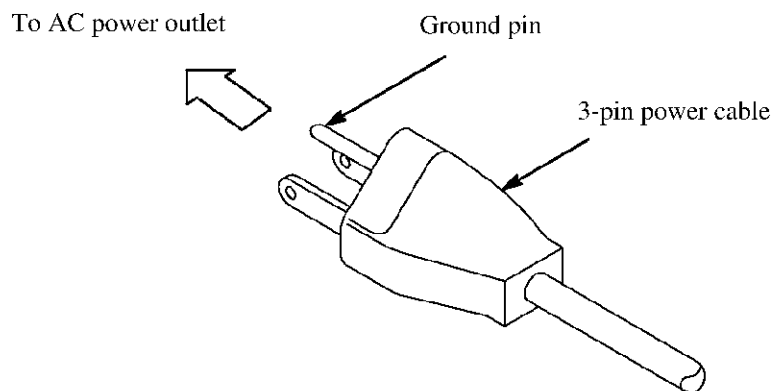

Figure 1-3 Power Cable

1.4 System Checkout

This section describes the Self Test which must be performed when operating the optical spectrum analyzer for the first time. Follow the procedure below:

1. Make sure that the **POWER** switch on the front panel is in the OFF position.
2. Connect the power cable provided to the AC power supply connector on the rear panel.

CAUTION: *To prevent damage, operate the optical spectrum analyzer within specified input voltage and frequency ranges.*

3. Connect the power cable to the outlet.
4. Press the **POWER** switch to the ON position.
The Q8384 performs the self-diagnostics for a few seconds. When the self-diagnostics is complete, the self-test is then automatically started and the results will be displayed in sequence.

CAUTION: *Contact ADVANTEST for repair when the self test fails. Refer to the addresses at the end of this manual.*

The initial checkout is now complete, and the measurement screen is displayed.

1.5 Setting the Print Paper

Mount the paper in the internal printer as illustrated on the rear of the printer cover.

Procedure

1. Set the head up lever to the open position.
2. Load the roll paper in the holder with the outside of the paper roll down.
3. Set up the paper as shown in the following figure.

NOTE: Be sure to insert the paper from the upper slit. The printer does not operate even if the paper is inserted into the lower slit.

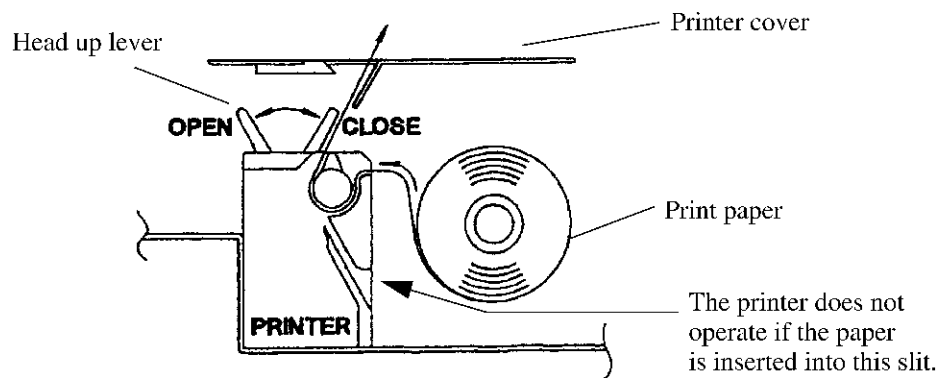

Figure 1-4 Setting the Print Paper

4. Set the head up lever to the close position.
5. Press the **FEED** key on the front panel and check whether the paper is correctly installed. Return to the step 1 if the paper is not correctly installed.

Printer paper: A09075 (Order No.)
5 rolls/box (Order unit: 1 box)
Thermosensitive paper length : 30 m
Paper width : 114 mm

CAUTION: Use only the specified paper.

1.6 Cleaning, Storing and Transporting the Q8384 Optical Spectrum Analyzer

1.6.1 Cleaning

Remove dust from the outside of the optical spectrum analyzer by wiping or brushing the surface with a soft cloth or small brush. Use a brush to remove dust from around the panel keys. Hardened dirt can be removed by using a cloth which has been dampened in water containing a mild detergent.

CAUTION:

1. *Do not allow water to get inside the optical spectrum analyzer.*
 2. *Do not use organic cleaning solvents, such as benzene, toluene, xylene, acetone or similar compounds, since these solvents may damage the plastic parts.*
 3. *Do not use abrasive cleaners.*
-

- **Cleaning the Display Filter**

Normally cleaning the display filter from the front should be sufficient. However, if necessary, the filter itself can be detached from the optical spectrum analyzer by removing the two screws on the front. Clean the backside of the filter with a soft cloth.

CAUTION: *Do not touch the LCD display with your finger when the filter has been removed.*

- **Cleaning the optical input connectors**

The optical input section of the Q8384 is easy to clean because of the replaceable adapter used. The optical input section is accessible when you remove the adapter. Clean the tip with alcohol.

NOTE: *Measurement may be inaccurate when the instrument is used with the input section dirty.*

- **Cleaning the fan filter**

The fan filter collects dirt particles from the air over time. When the filter gets dirty, remove the plastic guard and remove the dirt from the filter by hand.

1.6.2 Storing

Store the optical spectrum analyzer in an area which has a temperature from -10 °C to +50 °C. If you plan to store the optical spectrum analyzer for a long period (more than 90 days), put the optical spectrum analyzer in a vapor-barrier bag with a drying agent and store the optical spectrum analyzer in a dust-free location out of direct sunlight.

1.6.3 Replacing and Cleaning the Optical-Connector Adapter of Q8384

The light input part is a high precision part. It must be handled with extreme caution.

CAUTION:

1. *The fiber tip of the light input part requires frequent cleaning. Dirt or dust may damage the fiber of the light input part. For the operation and cleaning method of the part, refer to section (1).*
 2. *The optical connector adapter is fragile and has a limited life span. Under certain operational conditions, the split sleeve inside of the optical connector adapter can become damaged. To replace of the damaged sleeves, refer to section (2).*
-

(1) Operation and Cleaning Methods for the Light Input Part

Always make sure the light input part of the analyzer is clean and the optical fiber connector is plugged in correctly.

1. Remove the adapter ring by turning it counterclockwise (refer to Figure 1-5).
 2. Remove the optical connector adapter by pulling it out slowly (refer to Figure 1-5 "Light Input Part Structure").
 3. Clean the fiber tip of the light input part with alcohol. Clean the fiber tip used to input the light as well.
-

CAUTION:

1. *Operating the light input part when it's dirty or the fiber key slot of the input light is not completely in contact with the Q8384 light input part may cause an error in the measurement result.*
 2. *Operating with a dirty light input part harms the ferrule surface.*
 3. *The fiber in the light input part may be damaged if a large optical light power is released when the light input part is dirty or while the fiber key slot of the light input part is not aligned correctly with the adapter key slot. If it is damaged, replacement of the fiber part is required.*
-

1.6.3 Replacing and Cleaning the Optical-Connector Adapter of Q8384

(2) Operational Care and Replacement Methods for the Optical Connector Adapter

When inserting the light fiber connector into the light input part or taking it out, move slowly and carefully, making sure the connector is kept straight.

CAUTION: *The separating sleeve inside of the connector is made of zirconium (fine ceramics) and may be damaged if the light fiber connector is bent and is not straightened before insertion or if the connector is twisted while it is being taken out.*

The optical connector is a consumable part and has a limited life span. If it becomes damaged, purchase an accessory kit for the optical connector adapter and replace the part by removing the optical connector adapter in the same manner used when cleaning it.

To replace the optical connector adapter only, use the following procedures.

1. Remove the screws located on the upper left and lower right (opposite corners)
2. Replace with a new optical connector adapter (i.e. FC-FC, SC-FC, ST-FC). In order to conserve the performance of the adapter, using a optical connector adapter with the separating sleeve made of zirconium is recommended.

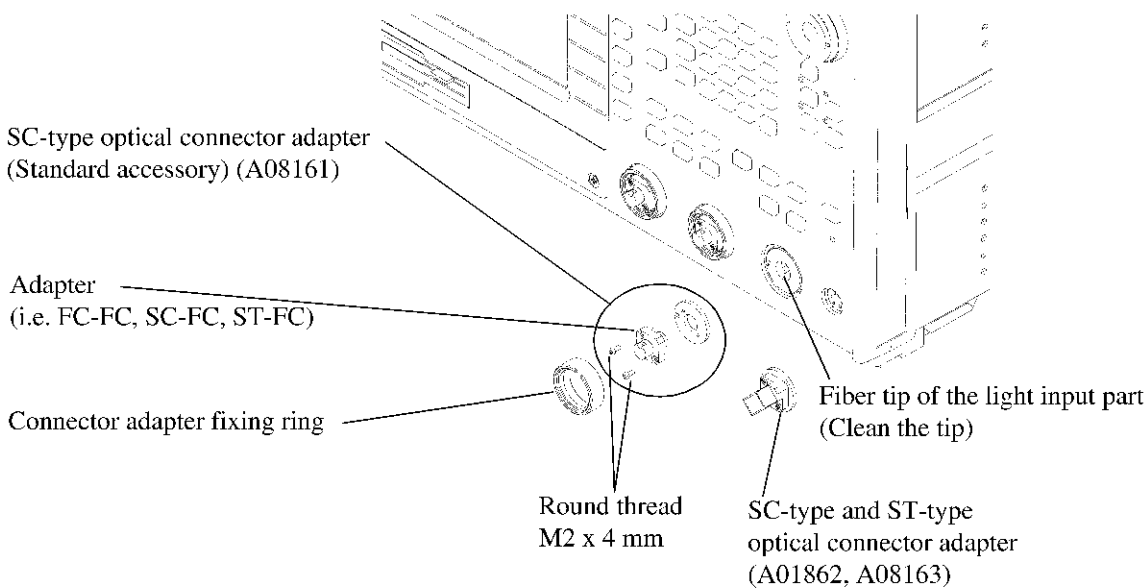

Figure 1-5 Light Input Part Structure

1.6.4 Transporting

When you ship the optical spectrum analyzer, use the original container and packing material. If the original packaging is not available, pack the optical spectrum analyzer using the following guidelines:

- To allow for cushioning, use a corrugated cardboard container with inner dimensions that are at least 15 centimeters more than those of the optical spectrum analyzer.
- Surround the optical spectrum analyzer with plastic sheeting to protect the finish.
- Cushion the optical spectrum analyzer on all sides with packing material or plastic foam.
- Seal the container with shipping tape or a heavy-duty, industrial stapler.
- Be careful when carrying the optical spectrum analyzer because it is a heavy instrument.

If you are shipping the optical spectrum analyzer to a service center for service or repair, attach a tag to the optical spectrum analyzer that shows the following information:

- Owner and address
- Name of a contact person at your location
- Serial number of the optical spectrum analyzer (located on the rear panel)
- Description of the service requested

1.7 Warm-up time

A warm-up time of 30 minutes is required to guarantee the specified accuracy.

1.8 About Calibration

When you want to calibrate the Q8384, please contact a sales representative.

Desirable Period	One year
------------------	----------

2 OPERATION

This chapter describes the following.

- Description on the front and rear panels
- Screen annotation
- Basic operation
- Measurement examples
- Expanded functions

2.1 Panel Description

This section describes the names, functions and screen annotations of the front and rear panels.

2.1.1 Front Panel

The panel keys and connectors are described below for each section of the front panel.

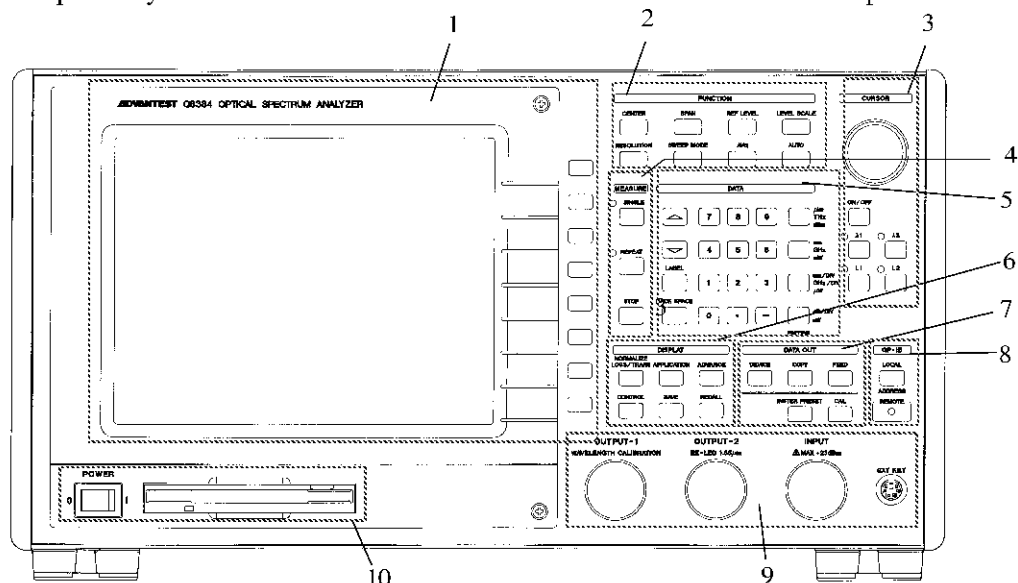

Figure 2-1 Front Panel

The front panel consists of 10 sections as shown below.

1. LCD Display Section
2. FUNCTION Section
3. CURSOR Section
4. MEASURE Section
5. DATA Section
6. DISPLAY Section
7. DATA OUT Section
8. GP-IB Section
9. Connector Section
10. POWER Switch/Floppy Disk Drive Section

2.1.1 Front Panel

2.1.1.1 LCD Display Section

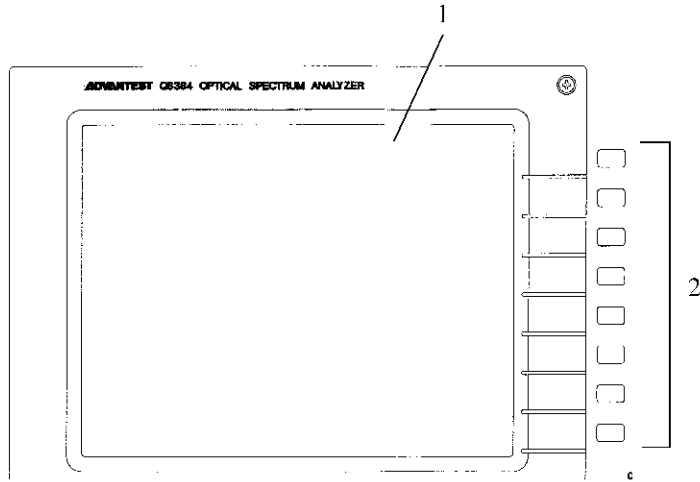

Figure 2-2 LCD Display Section

- | | |
|---------------------------------|---|
| 1. Liquid crystal display (LCD) | Displays trace and measured data. |
| 2. Soft keys | Eight keys corresponding to the soft-menu display on the left; pressing a soft key selects the corresponding menu item. |

2.1.1.2 FUNCTION Section

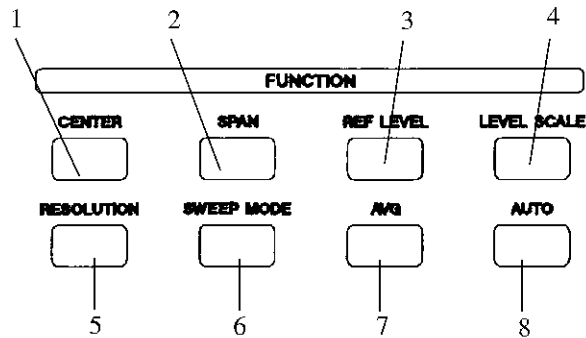

Figure 2-3 FUNCTION Section

- | | |
|---------------------------|--|
| 1. CENTER key | Specifies the center wavelength or center frequency to be analyzed. |
| 2. SPAN key | Specifies the wavelength span or frequency span to be analyzed, and the start and stop wavelengths or frequencies. |
| 3. REF LEVEL key | Specifies the reference level in display. |
| 4. LEVEL SCALE key | Selects the level axis (LIN/LOG) and specifies the scale. |
| 5. RESOLUTION key | Specifies the wavelength resolution. |
| 6. SWEEP MODE key | Specifies the sweep mode correspond to the input signal. |
| 7. AVG key | Specifies the number of times averaging or smoothing is performed. |
| 8. AUTO key | Executes the automatic setting functions for most suitable wavelength/level. |

2.1.1 Front Panel

2.1.1.3 CURSOR Section

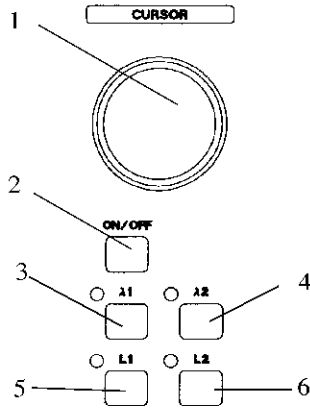

Figure 2-4 CURSOR Section

- | | |
|---|--|
| <ol style="list-style-type: none"> 1. Data knob 2. ON/OFF key 3. λ1 key 4. λ2 key 5. L1 key 6. L2 key | <p>Moves the cursor selected and continuously changes the data set.</p> <p>Controls ON/OFF of all cursors and the cursor display mode.</p> <p>Selects display and erases wavelength cursor 1.</p> <p>Selects display and erases wavelength cursor 2.</p> <p>Selects display and erases level cursor 1.</p> <p>Selects display and erases level cursor 2.</p> |
|---|--|

2.1.1.4 MEASURE Section

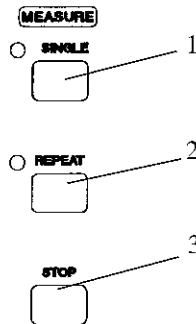

Figure 2-5 MEASURE Section

- | | |
|---|--|
| <ol style="list-style-type: none"> 1. SINGLE key 2. REPEAT key 3. STOP key | <p>Executes one time sweeping.</p> <p>Repeats sweeping.</p> <p>Stops sweeping.</p> |
|---|--|

2.1.1.5 DATA Section

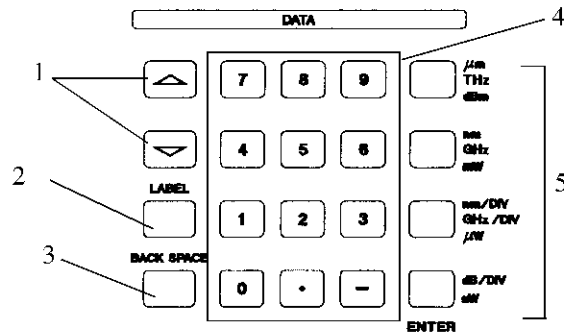

Figure 2-6 DATA Section

- | | | |
|----|-----------------------|---|
| 1. | Step keys | Used to move the cursor selected and change the data set, step by step. |
| 2. | LABEL key | Specifies the label data. |
| 3. | BACK SPACE key | Deletes a character from the input data. |
| 4. | Numeric keys | Used to enter numeric values.
There are ten number keys (0 through 9), a decimal point key (.) and a minus key (-). |
| 5. | Units keys | <p>μm, THz, dBm key
Sets μm, THz or dBm.</p> <p>nm, GHz, mW key
Sets nm, GHz or mW.</p> <p>nm/DIV, GHz/DIV, μW key
Sets nm/DIV, GHz/DIV or μW.</p> <p>dB/DIV, nW, ENTER key
Sets dB/DIV or nW.
It is also used as the ENTER key.</p> |

When you attempt to enter data containing other units, characters, or numeric values, the **ENTER** key can be used to confirm the data entry.

2.1.1 Front Panel

2.1.1.6 DISPLAY Section

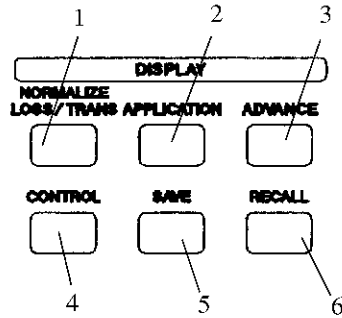

Figure 2-7 DISPLAY Section

- | | |
|------------------------------------|--|
| 1. NORMALIZE LOSS/TRANS key | Executes measurement data normalization and measurement of loss and transparency characteristics. |
| 2. APPLICATION key | Used for calculating the spectral width, notch width, and the gain and noise figure for the EDFA (Erbium-Doped Fiber Amplifier) as well as for setting the WDM Analysis. |
| 3. ADVANCE key | Executes a peak power monitor or limit line measurement. |
| 4. CONTROL key | Specifies the display mode (superimpose, dual-screens). |
| 5. SAVE key | Used to save measurement data. |
| 6. RECALL key | Used to recall set measurement data previously saved. |

2.1.1.7 DATA OUT Section

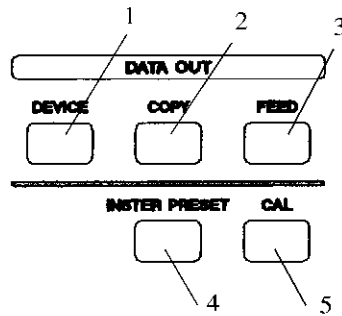

Figure 2-8 DATA OUT Section

- | | |
|----------------------------|---|
| 1. DEVICE key | Specifies a device (printer, floppy disk, clock or buzzer). |
| 2. COPY key | Executes data out processing. |
| 3. FEED key | Feeds paper to the printer. |
| 4. INSTR PRESET key | Initializes the setting modes. |
| 5. CAL key | Calibrates the wavelength and the level. |

2.1.1.8 GP-IB Section

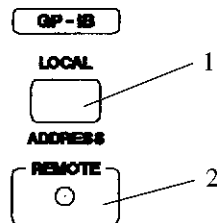

Figure 2-9 GP-IB Section

- | | |
|-----------------------|--|
| 1. LOCAL key | Specifies the local mode to make the panel keys valid (when the REMOTE lamp is lit). |
| ADDRESS key | Specifies the GP-IB address (when the REMOTE lamp is off). |
| 2. REMOTE lamp | Lit when in the remote state. |

2.1.1 Front Panel

2.1.1.9 Connector Section

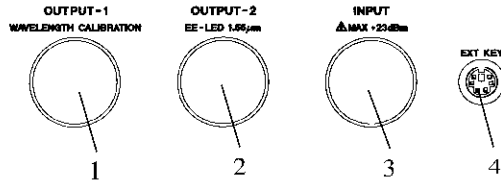

Figure 2-10 Connector Section

- | | |
|------------------------------|---|
| 1. OUTPUT-1 connector | Used to output the optical signal from a calibration light source (Option). To automatically measure the wavelength, connect the optical fiber from the OUTPUT-1 connector to the INPUT connector. |
| 2. OUTPUT-2 connector | Used to output the optical signal from a EE-LED light source (Option). |
| 3. INPUT connector | Used to input the light source to be measured. |
| 4. EXT KEY connector | Used to connect a PS/2 type (MiniDIN6 pins) keyboard. The external keyboard is used to enter label names and file names. Be sure to use a keyboard with a connector which includes a built-in ferrite core. We recommend the following keyboards:
Japanese layout, 109 key: Fujitsu FKB-8724-501
US layout, 104 key: Fujitsu FKB-8725-401 |

CAUTION: To prevent damage, never attempt to apply an input whose total power is +23 dBm or more to the INPUT terminal on the optical spectrum analyzer. In addition, never attempt to apply an external optical output to the OUTPUT-1 and OUTPUT-2 terminals on the optical spectrum analyzer.

2.1.1.10 POWER Switch/Floppy Disk Drive Section

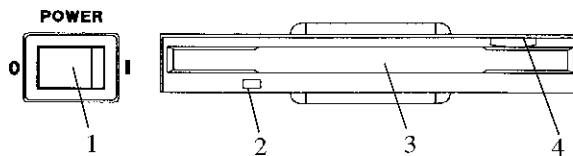

Figure 2-11 POWER Switch and Floppy Disk Drive Section

- | | |
|---------------------------|---|
| 1. POWER switch | Turns power ON/OFF. |
| 2. Eject button | Used to eject floppy disks from the drive. |
| 3. Floppy disk drive door | Insert floppy disks here. |
| 4. Access lamp | Turns on when the floppy disk in the drive is being accessed. |

2.1.2 Screen Annotation

This section describes typical screen annotations using the power monitor as an example.

(1) Screen Annotation

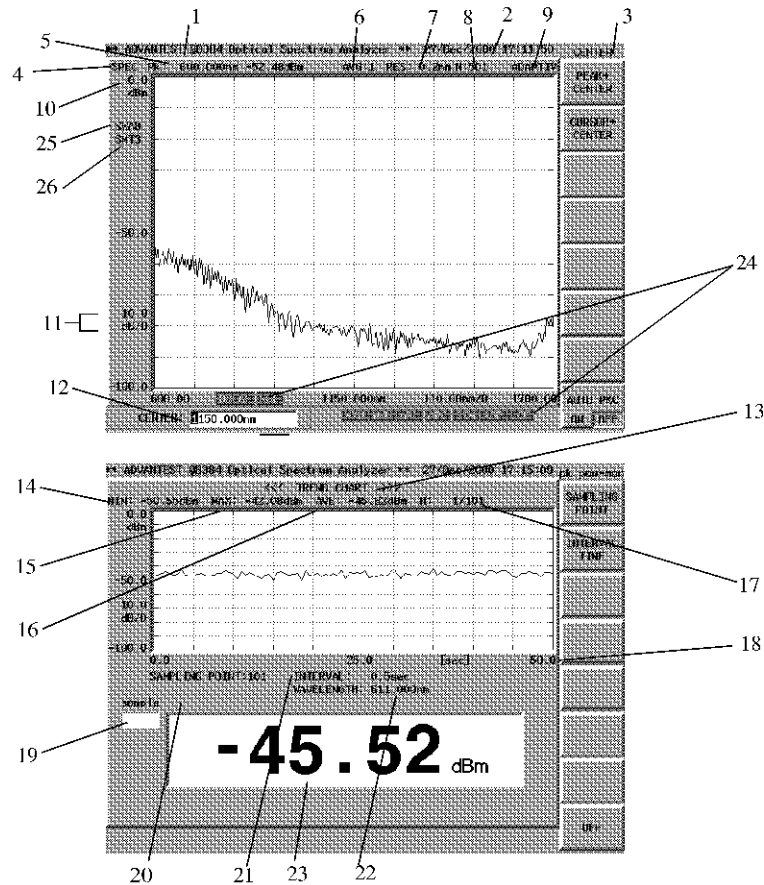

Figure 2-12 Screen Annotation

- | | | | |
|-----|--------------------------|-----|--|
| 1. | Label display | 14. | Measured minimum value |
| 2. | Date | 15. | Measured maximum value |
| 3. | Soft key type | 16. | Measured average value |
| 4. | Analysis data type | 17. | Measured points |
| 5. | Peak search data display | 18. | Measurement time |
| 6. | Number of point averages | 19. | Sampling indicator |
| 7. | Resolution | 20. | Measurement count setting value |
| 8. | Sampling points | 21. | Measurement time interval setting value |
| 9. | Sweep mode | 22. | Wavelength at the current peak |
| 10. | REF level display | 23. | Power display |
| 11. | 1 scale of vertical | 24. | Status display |
| 12. | Input window | 25. | Number of sweep averages, or a trace number when set to multi-trace. |
| 13. | Analysis data type | 26. | Number of smoothing points |

2.1.2 Screen Annotation

Table 2-1 Status Display Contents

Display	Description
UNCAL	This warning is displayed when the sweep width along the wavelength is smaller than the wavelength specified by the wavelength resolution at a measurement point. When measuring a line spectrum under the following condition, the level displayed is lower than the actual level because the peak level cannot be detected correctly: Wavelength resolution [nm] × (Number of sampling points - 1) < Span [nm]
RCL	Indicates that the waveform was loaded from memory or from a floppy disk.
MXH	The MAX HOLD function is turned on.
MNH	The MIN HOLD function is turned on.
ARL	The auto-reference level function is turned on.
APC	The auto-peak center function is turned on.
SIM	The superimposing function is turned on.
λOF	The wavelength offset function is turned on while an offset other than 0 is being input.
LOF	The level offset function is turned on while an offset other than 0 is being input.

2.1.3 Rear Panel

This subsection shows the rear panel and describes its terminals and connectors.

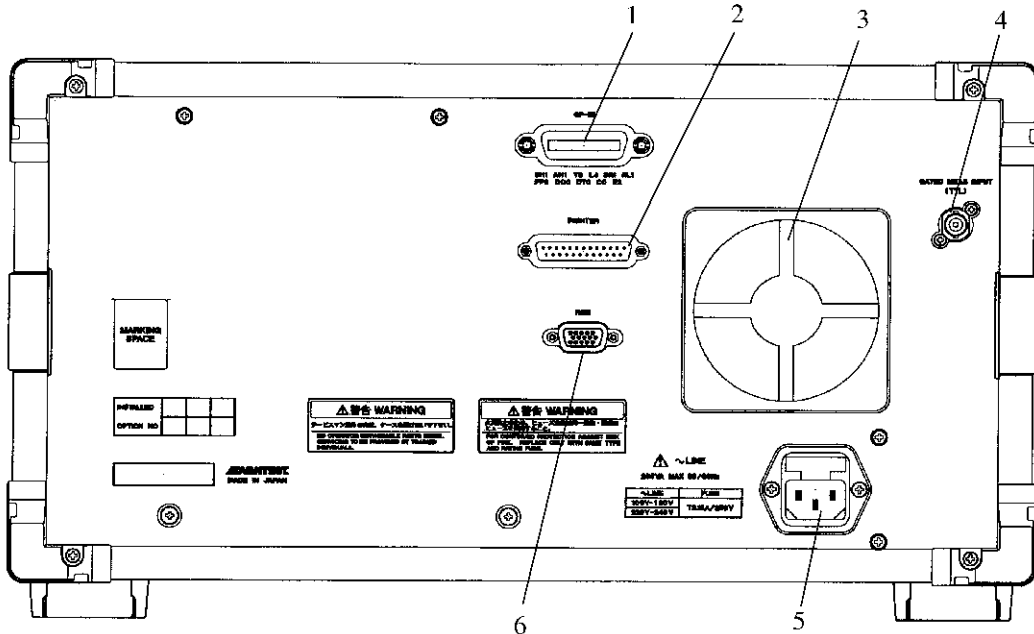

Figure 2-13 Rear Panel

- | | |
|--------------------------------------|--|
| 1. GP-IB connector | Connector for an external controller used when set to remote control through GPIB interface. |
| 2. PRINTER connector | Connector for a printer |
| 3. Fan | Cooling fan |
| <hr/> | |
| 4. GATED MEAS INPUT connector | Connector to input a signal used for the gated measurement in sync with the TTL-level positive pulse signal. |
| 5. AC power connector | Connect the input power cable from the analyzer to the outlet of the AC power source. |
| 6. RGB connector | Connector for an external monitor compatible with VGA specifications. |

CAUTION: Do not block the air vents.

2.2 Basic Operation

2.2 Basic Operation

This section describes the method of how to go through the menus and use the measurement functions.

2.2.1 Operating Menus and Entering Data

This section explains how the panel keys and soft keys are used.

(1) Selecting the menu

If you press a panel key, the soft menu associated with that key is displayed in the soft menu area on the screen.

To set measurement conditions, press a panel key to select the soft menu you wish.

To make a soft menu selection, press the soft key next to the menu item.

Once the soft menu is displayed, the titles of the set items and their current settings are displayed in the area outside the trace display section.

In addition, if there is an associated menus are also displayed (Refer to (3) Soft menu configuration).

For the items which require alphanumeric characters, the input window is displayed.

For example, the following screen will be displayed when you press **CENTER**.

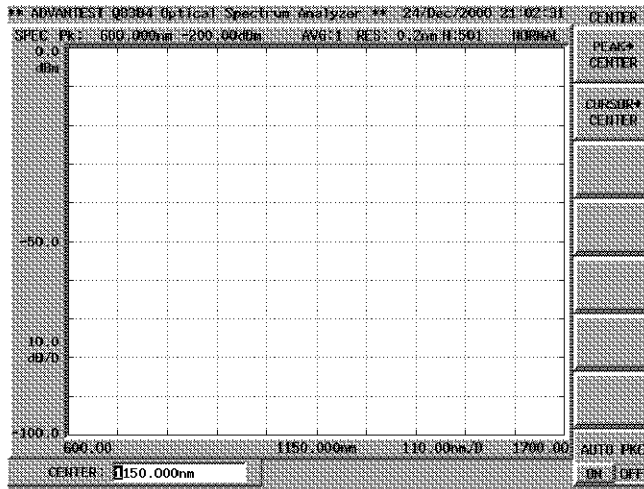

Figure 2-14 CENTER Menu

(2) Entering data

The data in the input window can be changed using the numeric keys, step keys or data knob while the window is displayed.

- Entering data using the numeric keys

You use the following keys to enter data: the numeric keys or the **BACK SPACE**. If you make a mistake when using the numeric keys, you can use the **BACK SPACE** key to delete the last digit entered. After entering the data, pressing one of the other unit keys completes the operation.

CAUTION: *Data entered with the numeric keys that is not terminated with a units terminator is aborted when you press any panel key.*

Example 1: The following example sets the reference level to -20 dBm using the numeric keys:
Press **REF LEVEL**, **-**, **2**, **0** and **dBm**.

- Entering data using the step keys
The step keys are used to enter data in a predefined step size. Press the ∇ step key to decrease the value and the Δ step key to increase the value. You can enter data while looking at the input window and the trace on the screen using the step keys. The step sizes vary depending on the items to be set.

Example 2: The following example sets the reference level to 0 dBm using the step keys:
Press the Δ step key following Example 1. This sets the reference level to -15 dBm. This is available when the level scale is set to 10 dB/div.
Pressing the Δ step key three times sets the reference level to 0.0 dBm.

- Entering data using the data knob
The data knob is used to set data in increments smaller than the step size. This is convenient when making fine adjustments to data already entered.

Example 3: The following example sets the reference level to 10 dBm using the data knob.
Turning the data knob clockwise increases the reference level in increments of 5 dB. Continue to turn it until the active area shows a setting of 10 dBm. This is available when the level scale is set to 10 dB/div.
Turning the data knob counter clockwise decreases the reference level by 5 dB.

- Removing the input window
To remove the input window, press the appropriate panel key again.

Example: Press the **CENTER** key. (The input window is displayed.)
Press the **CENTER** key again. (The input window is removed.)

(3) Soft menu configuration

- Switching between settings on a toggle button
Press the soft key under the soft menu with switching capability to toggle between settings for ON/OFF, LIN/LOG and similar switches each time you press the soft key.
- Main menu and sub menu
Menus consist of the main menu and associated submenus. When **PREVIOUS MENU** is selected in the submenu, the screen display returns to the main menu.
If **OFF** is selected in the submenu, the current function is disabled and the screen display returns to the main menu.
In addition, there are some soft keys with which you can switch the setting each time you press them.
- Submenu
When a submenu item is displayed in lower-case characters, this indicates that there is another submenu: pressing this key again displays next level.

2.2.2 Light Spectrum Measurement

2.2.2 Light Spectrum Measurement

This section explains how to take a light source measurement for a 1.55µm multi mode laser diode as an example of a typical measurement.

Power on

NOTE: *To take accurate measurements, use the analyzer within the specified temperature range, and wait at least 30 minutes after turning on the power before performing the Calibrations. In this exercise example, the warm-up and calibration are omitted.*

1. Check to see if the **POWER** switch (on the front panel) is turned off.
2. Connect the power cable provided to the AC power supply connector on the rear panel.

CAUTION: *To avoid damage to the analyzer, operate the analyzer within the specified input voltage and frequency ranges.*

3. Connect the power cable to the outlet.
4. Turn on the **POWER** switch (on the front panel).
When the self-diagnostics has completed, the self-test is started.

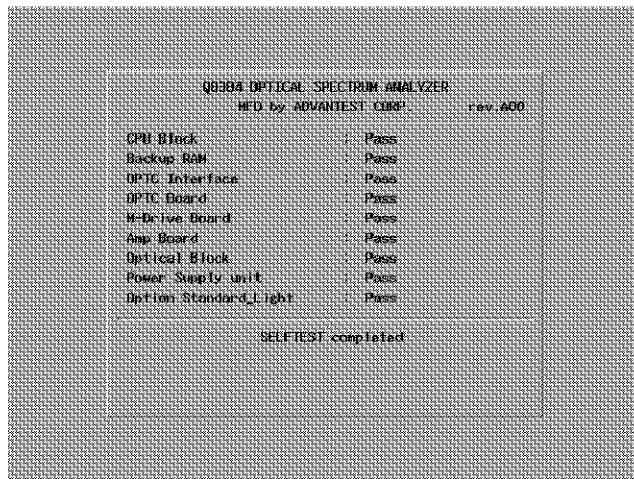

Figure 2-15 Self-test Screen

When the self-test has completed, the measurement screen is displayed

NOTE: *The screen displayed after the power is turned on may differ from the one shown here depending on the current settings.*

Initialization

This resets the current settings to the initial settings.

1. Press **INSTR PRESET**.
The INSTR PRESET menu is displayed.

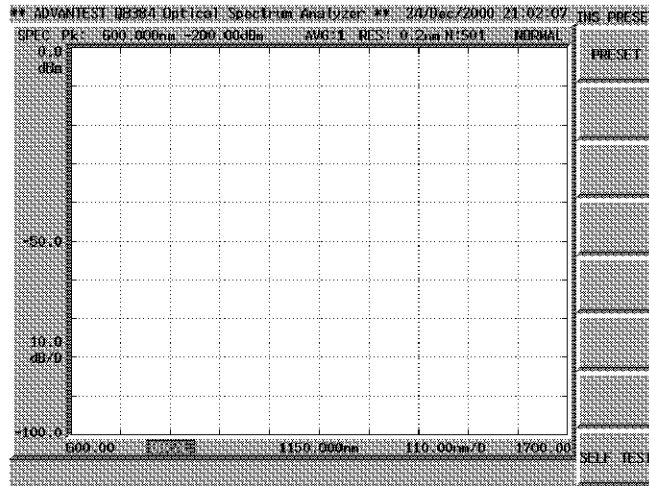

Figure 2-16 INSTR PRESET Menu

2. Press **PRESET**.
The initial settings are displayed.

Setup

Connect the light signal to the optical spectrum analyzer.

3. Connect the optical fiber cable from the output connector of light source to the optical spectrum analyzer **INPUT** connector.

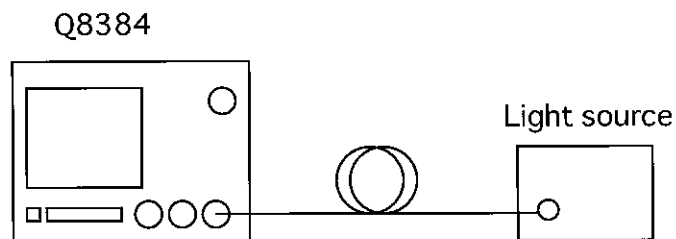

Figure 2-17 Light Spectrum Measurement

2.2.2 Light Spectrum Measurement

Setting the measurement conditions

This changes the analyzer settings so that the input signal is displayed more clearly.

4. Press **CENTER**.
An input window is displayed.

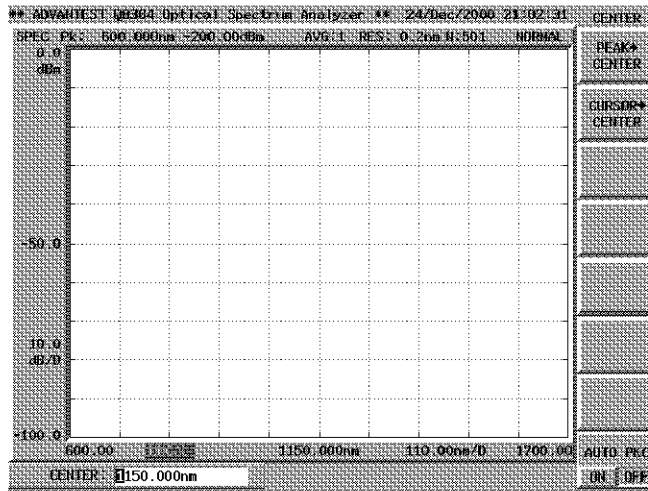

Figure 2-18 Input Window

5. Press **1**, **.**, **5** and **μm**.
A center wavelength of 1.55 μm is set.

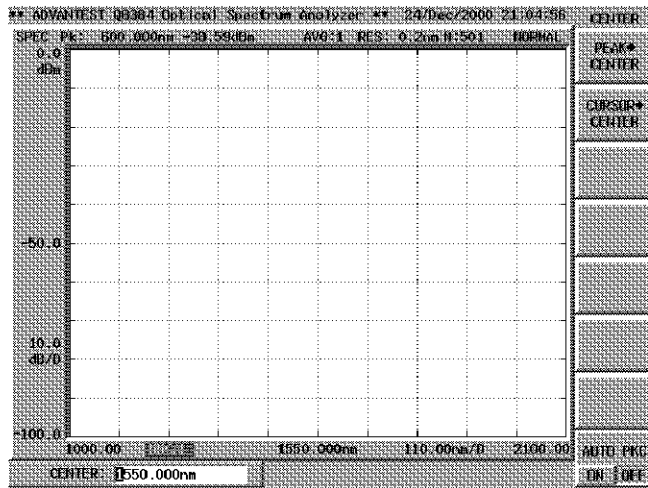

Figure 2-19 Setting the Center Wavelength

6. Press **SPAN**, **2**, **0** and **nm**.
An analysis span of 20 nm is set.
7. Press **REF LEVEL**, **-**, **1**, **0** and **dBm**.
The reference level is set to -10 dBm.

NOTE: *The reference level is to specify the displaying level and does not affect measurement data. An optimum view is obtained by changing the reference level after a measurement has been taken.*

8. Press **RESOLUTION** and **0.1 nm**.
A resolution of 0.1 nm is set.

CAUTION: *If a line spectrum is measured when the following condition applies, the level displayed is lower than the actual level because the peak level cannot be detected correctly:*
Resolution \times (Number of sampling points - 1) < Span
The status of uncal is displayed on the screen when the above condition is satisfied.

Performing the measurement

9. Press **SINGLE**.
A measurement is performed and the spectrum is displayed.

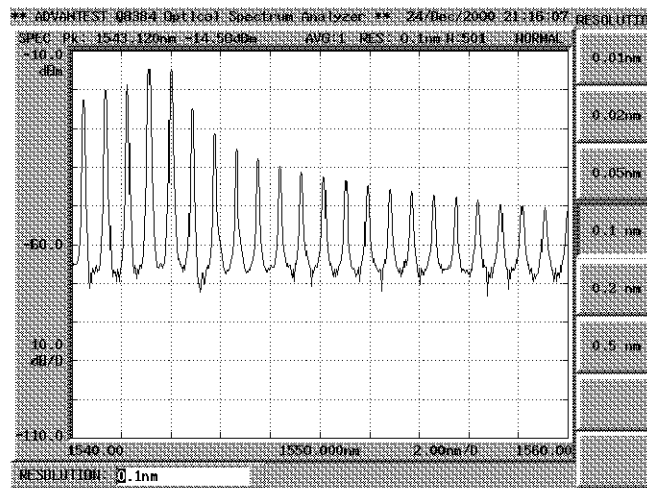

Figure 2-20 Displaying the Spectrum

Displaying the cursor

Data is read using the cursor.

10. Press **ON/OFF(ON)**.
The cursor is displayed at the maximum peak and the wavelength of 1543.12 nm and the level of -14.58 dBm at the cursor position are displayed in the cursor area.

2.2.2 Light Spectrum Measurement

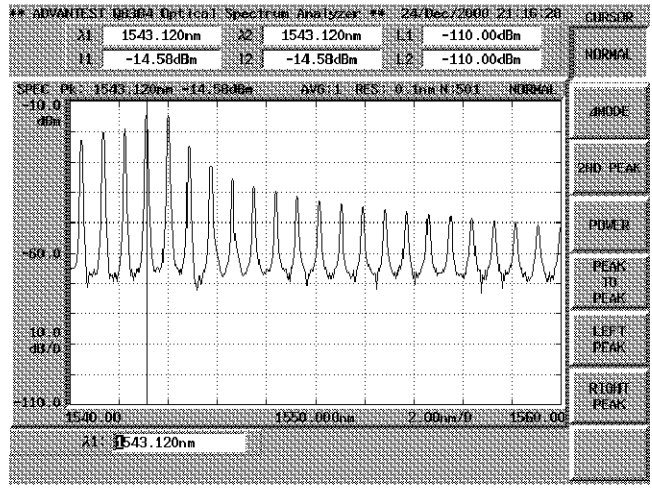

Figure 2-21 Peak Search

Changing the center wavelength

The highest peak can be displayed in the center of the screen using the following procedure.

11. **CENTER** and **PEAK→CENTER**.

The peak wavelength becomes the center wavelength.
(The cursor position stays unchanged.)

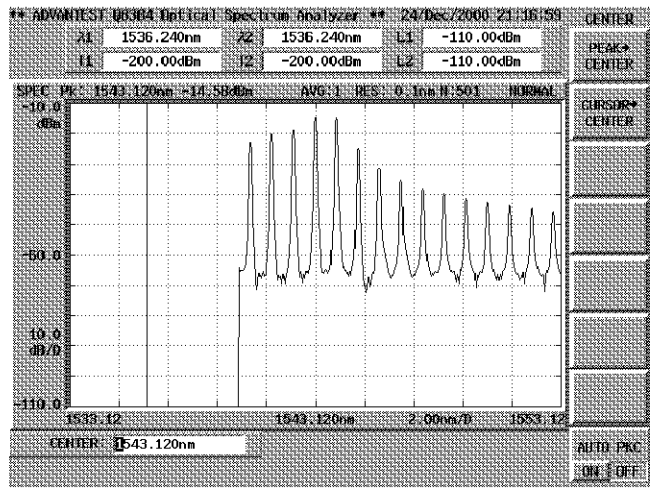

Figure 2-22 Changing the Center Wavelength

Setting the analysis span

A special span in the spectrum is specified as the analysis span.

12. Press **ON/OFF(ON)** three times.
 First time: The soft key menu changes to the **CURSOR** menu.
 Second time: The cursor disappears.
 Third time: A cursor is set to the peak.

X1 Cursor has been made active.

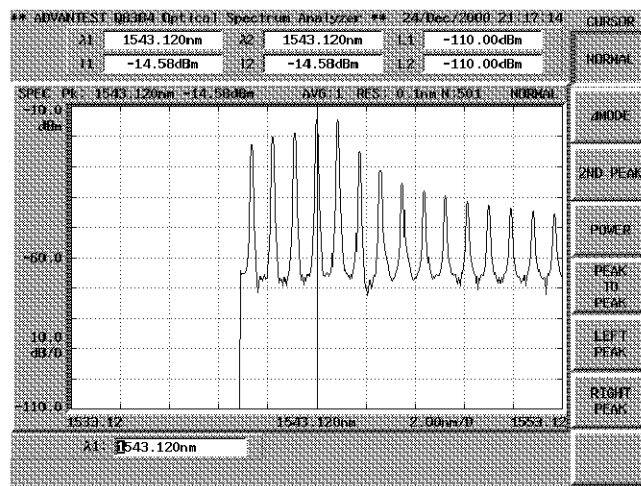

Figure 2-23 Displaying the Cursor

13. Turn the data knob to move the X1 cursor to the left end of the span you wish to analyze.
14. Press **λ2** and turn the data knob to move the X2 cursor to the right end of the span you wish to analyze.

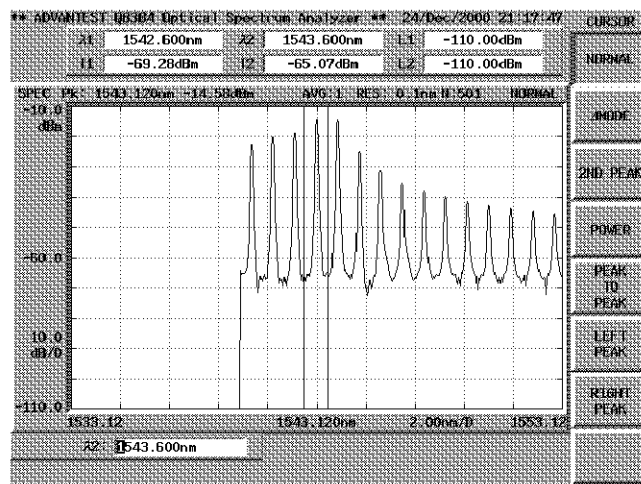

Figure 2-24 Setting the Analysis Span

2.2.2 Light Spectrum Measurement

15. Press **SPAN** and **CURSOR SPAN**.
The span between the two X cursors becomes the analysis span.

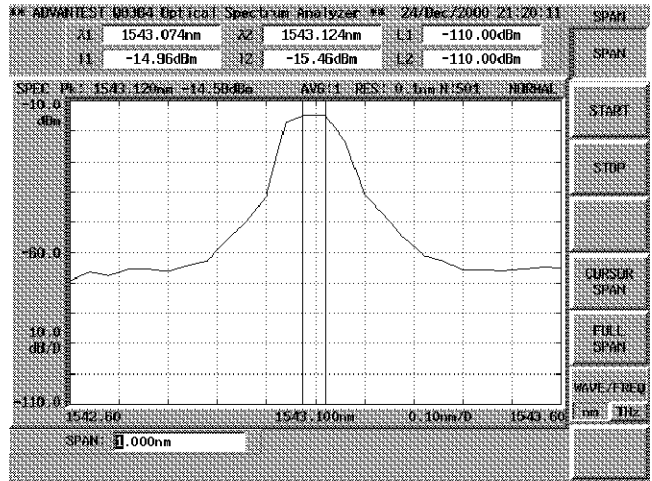

Figure 2-25 Setting the Analysis Span-1

Because only part of the span is selected, only a few measurements are used for analysis. However, the auto-panning and auto-zooming functions are used to interpolate the measurements to change the number of measurements to the number of specified sampling points and display the interpolated measurements.

16. Press **RESOLUTION** and **0.01 nm**.
The resolution is set to 0.01 nm.
17. Press **SINGLE**.
A sweep is carried out and the spectrum is displayed.

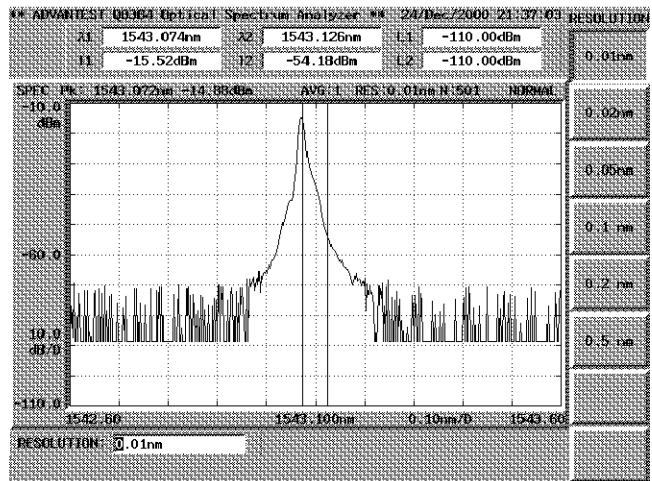

Figure 2-26 Setting the Analysis Span-2

To acquire data which is equivalent to the number of sample points specified, measurement is performed within the range specified by the X cursors. For more information on how to set the measurement conditions, refer to Section 2.2.12.

2.2.3 Peak Power Monitor Measurement

This section describes the peak power monitor function of the optical spectrum analyzer using a light source measurement of 1.55 μm multi mode laser diode as an example.

Power on

1. Turn the **POWER** switch (on the front panel) on.
The startup screen is displayed after the self-test has been completed.

Initialization

This resets the current settings to the initial settings.

2. Press **INSTR PRESET** and **PRESET**.
The initial settings are displayed.

Setup

Connect the light signal to the optical spectrum analyzer.

3. Connect the optical fiber cable from the light source output connector to the optical spectrum analyzer INPUT connector.

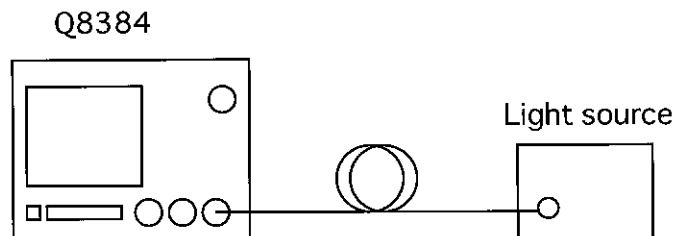

Figure 2-27 Peak Power Monitor Measurement

Setting the measurement conditions

This changes the analyzer settings so that the input signal is displayed more clearly.

4. Press **CENTER**, **1**, **.**, **5**, **5** and **μm** .
A center wavelength of 1.55 μm is set.
5. Press **SPAN**, **2**, **0** and **nm**.
An analysis span of 20 nm is set.
6. Press **REF LEVEL**, **-**, **1**, **0** and **dBm**.
The reference level is set to -10 dBm.
7. Press **RESOLUTION** and **0.1 nm**.
A resolution of 0.1 nm is set.

2.2.3 Peak Power Monitor Measurement

- 8. Press **SINGLE**.
A sweep is performed and the resulting spectrum is displayed.

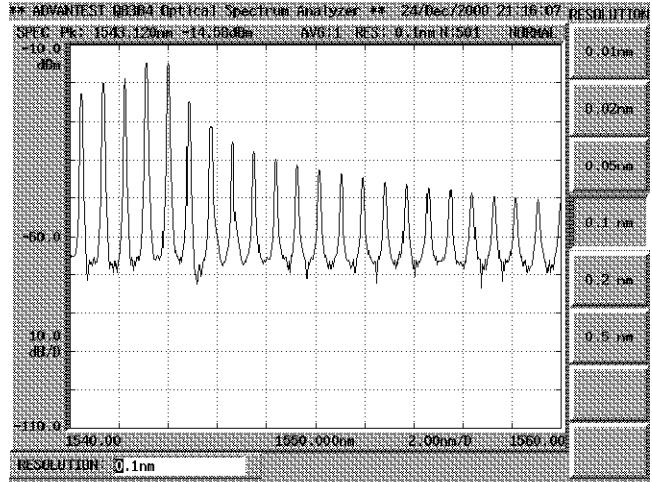

Figure 2-28 Displaying the Spectrum

Starting the peak power monitor

The targeted peak is displayed in the center of the screen.

- 1. **CENTER** and **PEAK→CENTER**.
The peak wavelength becomes the center wavelength.
The peak power monitor uses the previous conditions made before toggling the peak power monitor to ON.
- 2. Press **ADVANCE** and **peak power-mon**.
The screen display is changed to the peak power monitor.
- 3. Press **INTERVAL TIME, 1** and **ENTER**.
Time-varying characteristic is measured in increments of 1 seconds.
- 4. Press **SAMPLING POINT, 5, 1** and **ENTER**.
Sets the optical spectrum analyzer to perform the measurement 51 times.
- 5. Press **SINGLE**.
Starts the peak power monitor measurement.

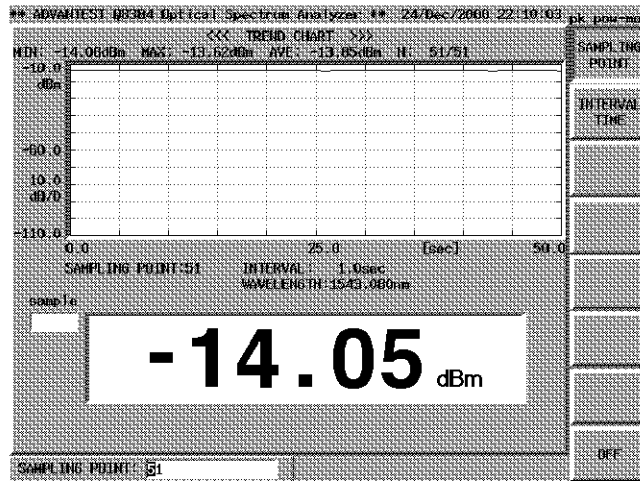

Figure 2-29 Displaying Input Light Changes in Time

CAUTION: *The peak power monitor function measures the spectrum internally and displays the peak level. The span, the resolution and the number of sampling points that were used immediately before the peak power monitor was started are used as the measurement conditions. As a result, to make the interval time shorter, set the values used immediately before the peak power monitor was started to smaller values.*

CAUTION: *When the span is set to 20 nm or more (when the number of sample points is 501) and peak powers are monitored, the measurement time may exceed the set time interval. If this occurs, an error message "INTERVAL TIME IS TOO SHORT" is displayed and measurements displayed do not match the time scale. Make the time interval longer.*

2.2.4 Alignment

2.2.4 Alignment

This function adjusts the optical axis of the monochromator used with the optical spectrum analyzer.

CAUTION: *Prior to operating this instrument immediately after having transported it with fierce vibrations, or operating this instrument in a place having abrupt temperature changes, be sure to warm up the instrument and then perform the AUTO ALIGNMENT function in advance.*

Power on

1. Turn the **POWER** switch (on the front panel) on.
The startup screen is displayed after the self-test has been completed.

NOTE: *A minimum warm-up time of 30 minutes is required prior to making measurements.*

Setup

Use the light source from either the OUTPUT-2 connector (EE-LED output available as an option of this instrument) or an LD light source having a wavelength range of 1.2 to 1.65 μm .

2. Connect the SM fiber cable from the light source to the optical input connector.

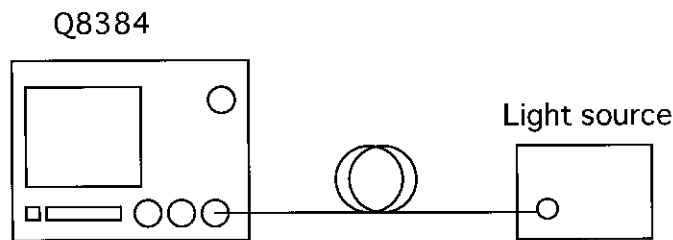

Figure 2-30 Connecting the Calibration Signal

3. Press **CAL** and **AUTO ALIGNMENT**.
The optical axis alignment starts automatically, and is completed in approximately 30 seconds with a message indicating that the alignment has been completed is then displayed.

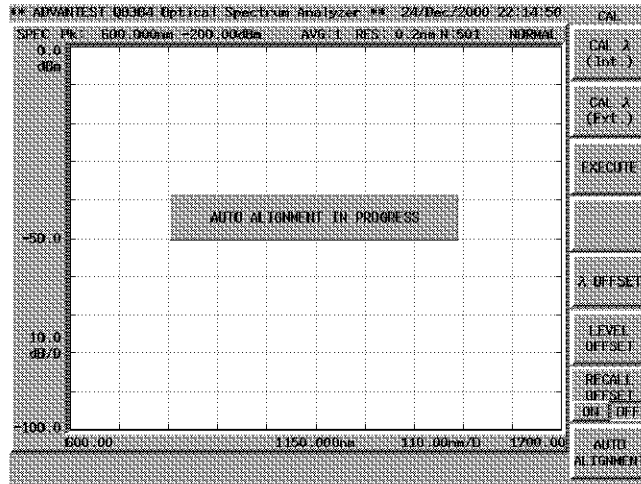

Figure 2-31 Alignment Execution Message

2.2.5 Calibration

2.2.5 Calibration

This section describes how to calibrate the instrument to keep the wavelength accuracy.

To make measurements accurately, use the optical spectrum analyzer at temperatures within the specified range.

Allow at least 30 minutes for the analyzer to warm up before performing a calibration.

There are two types of calibration for the optical spectrum analyzer.

- (a) Calibration using the built-in light source (Option)
- (b) Calibration using an external light source

(a) Calibration using the built-in light source (Option)

Power on

1. Turn the **POWER** switch (on the front panel) on.
The startup screen is displayed after the self-test has been completed.

Initialization

This resets the current settings to the initial settings.

2. Press **INSTR PRESET** and **PRESET**.
The initial settings are read.
Allow at least 30 minutes for the analyzer to warm up before performing a calibration.

Setup

Connect the calibration signal to the optical spectrum analyzer.

3. Connect the optical fiber cable from the **OUTPUT-1** connector to the **INPUT** connector.

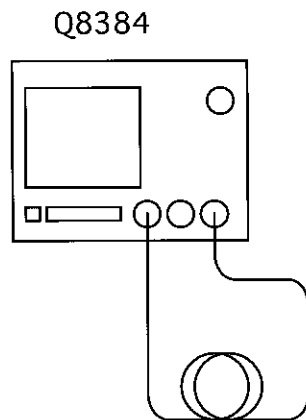

Figure 2-32 Connecting the Calibration Signal

Executing the calibration operation

4. Press **CAL**, **CAL λ (Int.)** and **EXECUTE**.

A message is displayed and shows that calibration is in progress as shown below. About 90 seconds later, another message indicating that calibration is finished is displayed.

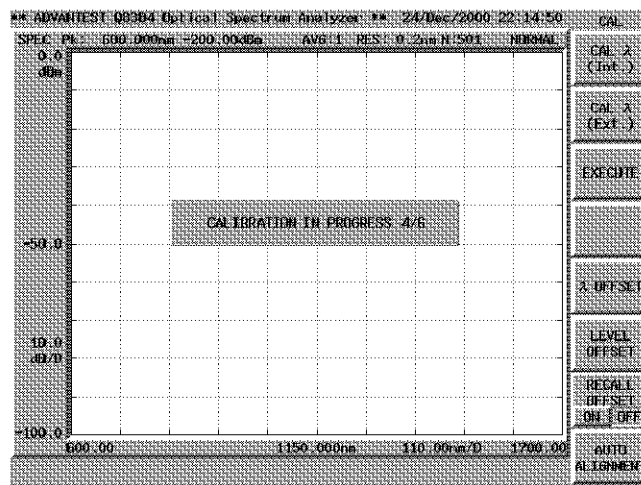

Figure 2-33 Calibration Execution Message

(b) Calibration using an external light source

Power on

1. Turn the **POWER** switch (on the front panel) on.
The startup screen is displayed after the self-test has been completed.

Initialization

This resets the current settings to the initial settings.

2. Press **INSTR PRESET** and **PRESET**.
The initial settings are read.
Allow at least 30 minutes for the analyzer to warm up before performing a calibration.

Connecting the calibration signal

3. Connect the single mode optical fiber cable from the external calibration light source to the optical spectrum analyzer **INPUT** connector.
Use a laser caused by single wavelength oscillation as the light source.

2.2.5 Calibration

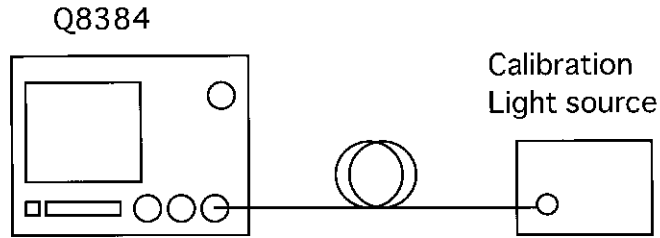

Figure 2-34 Connecting the Calibration Signal

4. Change the settings so that an external calibration light source spectrum can be displayed, and then measure the spectrum.

Executing the calibration operation

5. Press **CAL** and **CAL λ (Ext.)**.
The input window is displayed.
6. Enter the wavelength of the calibration light source.

Perform a calibration so that the light source peak wavelength matches the wavelength entered from the input window.

7. Press **CAL** and **EXECUTE**.
A message is displayed and shows that calibration is in progress as shown below. About 20 seconds later, another message indicating that calibration is finished is displayed.

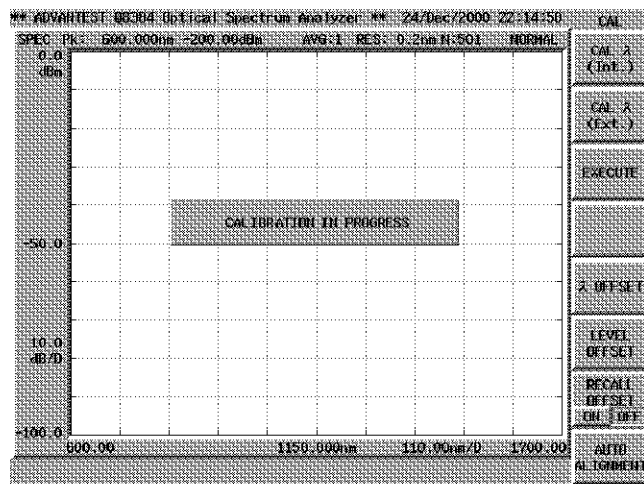

Figure 2-35 Calibration Execution Message

2.2.6 Measuring the Transmission-wavelength (or Loss-wavelength) Characteristics

The NORMALIZE (LOSS/TRANS) function is used to display measurement data after it has been normalized with the data in reference memory or the spectrum maximum value.

This function is useful for measuring transmission-wavelength and loss-wavelength characteristics of parts such as optical fibers and optical filters after the output from OUTPUT-2 (on the optical spectrum analyzer) or a white light source has been connected to the input terminal (on the optical spectrum analyzer).

This section describes how to measure the transmission-wavelength (or loss-wavelength) characteristics of DUTs.

Power on

1. Turn the **POWER** switch (on the front panel) on.
The startup screen is displayed after the self-test has been completed.

Initialization

This resets the current settings to the initial settings.

2. Press **INSTR PRESET** and **PRESET**.
The initial settings are displayed.

Saving the normalization data

3. Connect the SM optical fiber from the white light source **OUTPUT** connector to the optical spectrum analyzer **INPUT** connector.

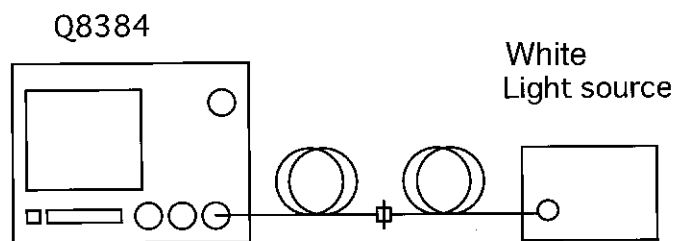

Figure 2-36 Connecting the White Light Source

This changes the analyzer settings so that the characteristics of a DUT may be displayed more clearly.

4. Press **CENTER**, **1**, **,**, **5**, **5** and **μm**.
A center wavelength of 1.55 μm is set.
5. Press **SPAN**, **5** and **nm**.
An analysis span of 5 nm is set.
6. Press **SWEEP MODE** and **ADAPIVE**.
The sweep mode is set to the adaptive mode.

2.2.6 Measuring the Transmission-wavelength (or Loss-wavelength) Characteristics

7. Press **RESOLUTION** and *0.05 nm*.
A resolution of 0.05 nm is set.
8. Press **SINGLE**.
A sweep is performed.
9. Press **NORMALIZE LOSS/TRANS** and *SAVE REF DATA*.
The spectrum data used as the reference data is saved to the memory.

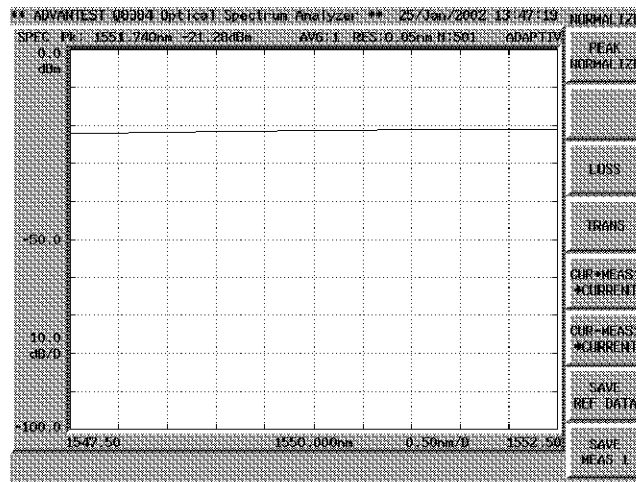

Figure 2-37 Saving the Reference Spectrum

Connecting a DUT

10. Replace the adapter currently connected with a DUT.

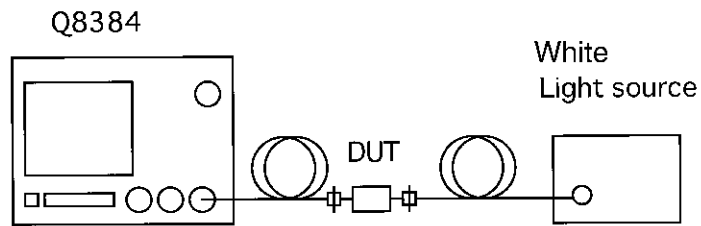

Figure 2-38 Connecting the White Light Source

2.2.6 Measuring the Transmission-wavelength (or Loss-wavelength) Characteristics

Measuring the loss-wavelength characteristics

11. Press **SINGLE**.
A sweep is performed.
12. Press **NORMALIZE LOSS/TRANS** and **LOSS**.
A waveform showing loss-wavelength characteristics (Ref. spectrum divided by Current spectrum) is displayed.

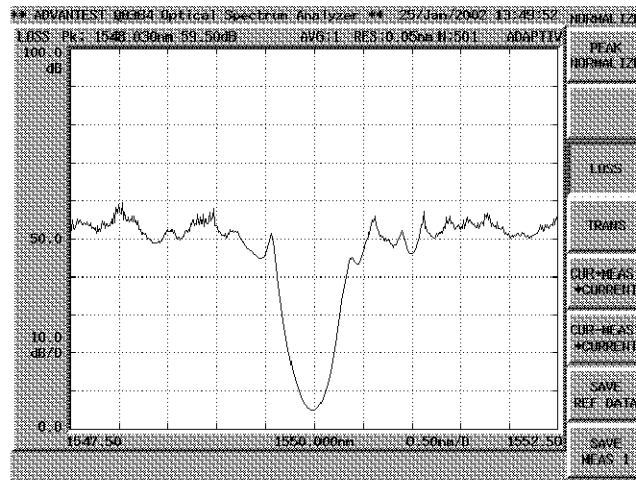

Figure 2-39 Loss-wavelength Characteristics (Zooming function with LOSS/TRANS)

Measuring the transmission-wavelength characteristics

13. Press **NORMALIZE LOSS/TRANS** and **TRANS**.
A waveform showing transmission-wavelength characteristics (Current spectrum divided by Ref. spectrum) is displayed.

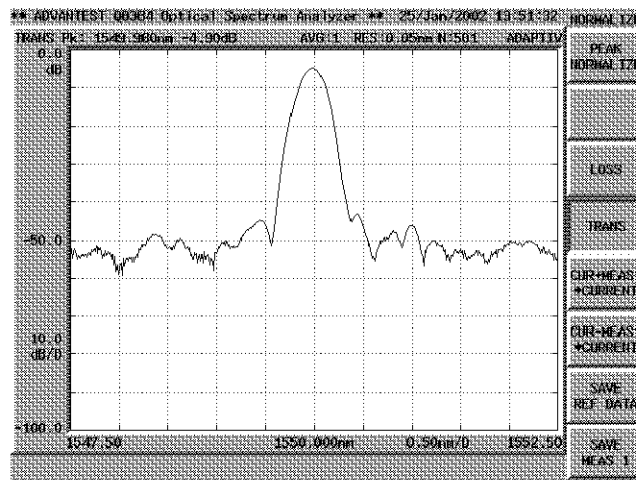

Figure 2-40 Transmission-wavelength Characteristics (Zooming function with LOSS/TRANS)

2.2.6 Measuring the Transmission-wavelength (or Loss-wavelength) Characteristics

Setting the LEVEL SCALE on the display

Adjust the level scale on the screen to easily view signals.

14. Press **LEVEL SCALE**, **6**, and **ENTER**.
The level scale on the screen is set to 6 dB/Div.

Optical BPF Characteristic Analysis

15. Press **APPLICATION**, *device*, and *o-bpf*.
Select the O-BPF mode in the Application menu.

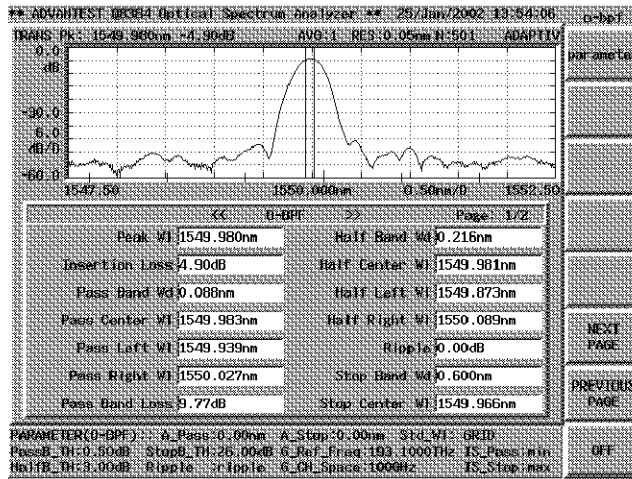

Figure 2-41 O-BPF Analysis Mode Screen

Analysis Condition Settings

16. Press *parameter*.
The O-BPF PARAMETER dialog box is displayed.

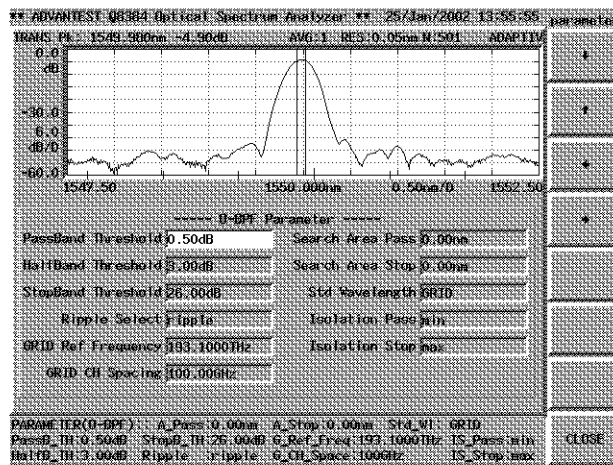

Figure 2-42 O-BPF PARAMETER Dialog Box

2.2.6 Measuring the Transmission-wavelength (or Loss-wavelength) Characteristics

To change parameters in the dialog box, move the cursor using the arrow key menu. Select a parameter and specify a value using the arrow keys, data knob, or numerical keypad.

17. Select **Pass Band Threshold**, and set to 1.00 dB.
18. Select **GRID CH Spacing**, and set to 50 GHz.
19. Select **Search Area Pass**, and set to 0.1 nm.
20. Select **Search Area Stop**, and set to 0.1 nm.
21. Press **CLOSE**.

The O-BPF PARAMETER dialog box is closed. O-BPF is calculated using the changed parameters. The spectrum is displayed on the upper screen and parameters indicating the filter characteristics are displayed on the lower screen. Pressing NEXT PAGE key displays the rest of the characteristic parameters. Pressing PREVIOUS MENU key returns to the previous menu.

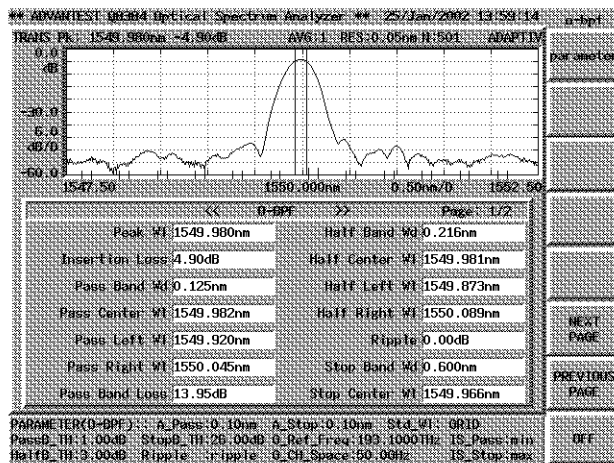

Figure 2-43 The Screen after the Calculation Using the Changed Parameters

- The LOSS/TRANS function allows the same wavelengths to be used, each of which were measured from two different measurement condition groups for CENTER and SPAN, for an operation if the wavelength range set for reference memory is wider than the wavelength range of the current signal spectrum.

As a result, we recommend that a wide wavelength range of a spectrum be specified in reference memory to avoid erasing the data in reference memory every time you change measurement conditions (refer to Section 5.9, "Auto-Panning and Auto-Zooming Functions")

2.2.7 ACPR (Adjacent Channel Leakage Power Ratio) Measurement

2.2.7 ACPR (Adjacent Channel Leakage Power Ratio) Measurement

Power on

1. Turn the **POWER** switch (on the front panel) on.
The startup screen is displayed after the self-test has been completed.

Initialization

This resets the current settings to the initial settings.

2. Press **INSTR PRESET** and **PRESET**.
The initial settings are displayed.

Setup

3. Connect the optical fiber cable from the light source output connector to the optical spectrum analyzer INPUT connector.

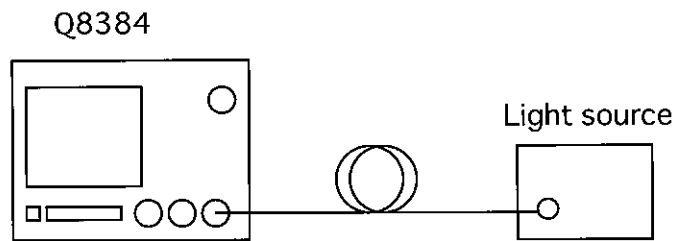

Figure 2-44 Connecting the Calibration Signal

Setting the measurement conditions

This changes the analyzer settings so that the input signal is displayed more clearly.

4. Press **CENTER**, **1**, **5**, **5**, **8** and **nm**.
A center wavelength of 1558 nm is set.
5. Press **SPAN**, **5** and **nm**.
An analysis span of 5 nm is set.
6. Press **RESOLUTION** and **0.05 nm**.
A resolution of 0.05 nm is set.
7. Press **SWEEP MODE** and **ADAPTIVE**.
ADAPTIVE is selected in the sweep mode.

Performing the measurement

8. Press **SINGLE**.
A sweep is performed and the resulting spectrum is displayed.

2.2.7 ACPR (Adjacent Channel Leakage Power Ratio) Measurement

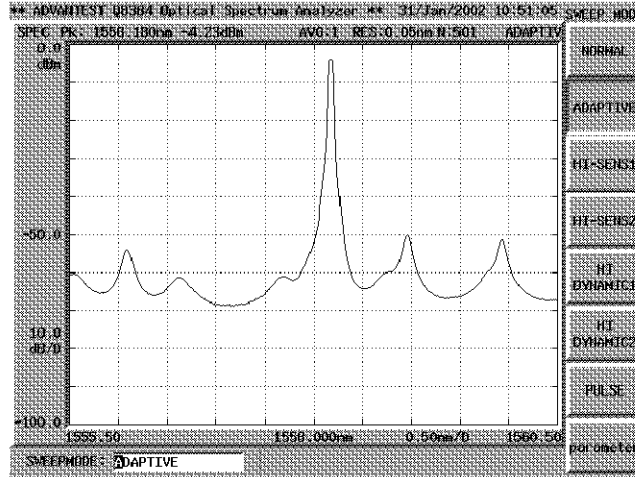

Figure 2-45 Input Signal Measurement

ACPR Measurement

9. Press **APPLICATION** and *acpr*.
The signal power in the signal band, the leaked power from the signal band, and the ACPR which indicates the ratio of leaked power to signal power are displayed on the lower part of the screen.

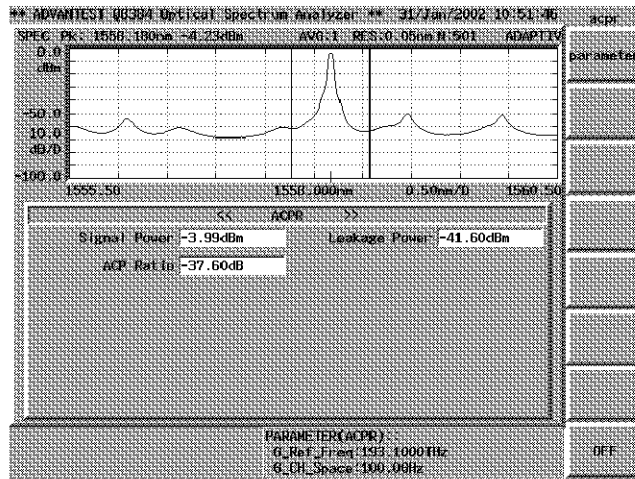

Figure 2-46 ACPR Mode Screen

2.2.7 ACPR (Adjacent Channel Leakage Power Ratio) Measurement

Analysis Condition Settings

10. Press **parameter**.

The ACPR parameter dialog box is displayed.

To change parameters in the dialog box, move the cursor using the arrow key menu. Select a parameter and specify a value using the arrow keys, data knob, or numerical keypad.

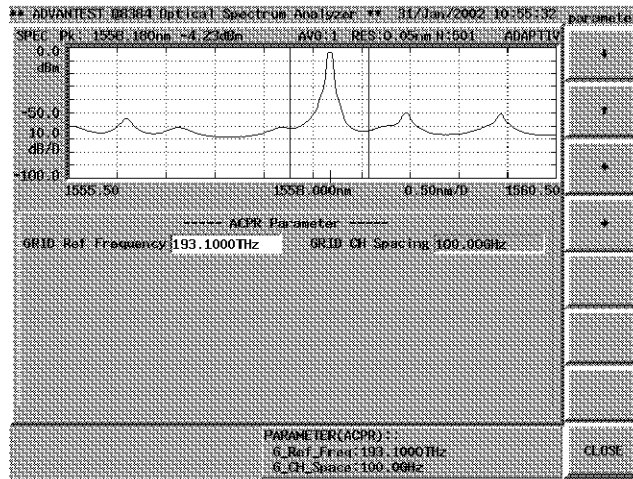

Figure 2-47 ACPR Parameter Dialog Box

11. Select **GRID CH Spacing**, and set to 50 GHz.

Set 50 GHz for the channel spacing of GRID, which is a reference signal bandwidth when ACPR is calculated.

12. Press **CLOSE**.

The ACPR parameter dialog box is closed. ACPR is calculated using the changed parameters. The spectrum and the parameters are displayed on the upper and lower parts of the screen, respectively.

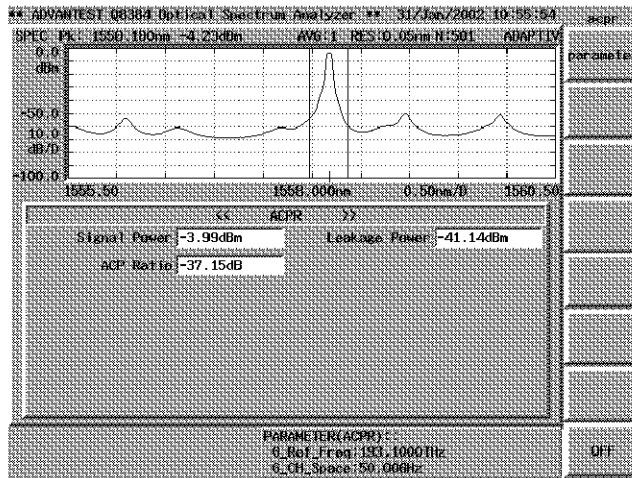

Figure 2-48 ACPR Measurement

2.2.8 Light Amplifier Characteristic Analysis

This section describes how to measure the gain and SNR of light amplifiers used for WDM (wavelength division multiplex) communications.

Measurement conditions: The target of the measurement is a light amplifier used for 1.55 μm WDM (wavelength division multiplex) communications.

Use appropriate parameter values when making the measurements in the example shown below.

Power on

1. Turn the **POWER** switch (on the front panel) on.
The startup screen is displayed after the self-test has been completed.

Initialization

This resets the current settings to the initial settings.

2. Press **INSTR PRESET** and **PRESET**.
The initial settings are read.

Setting the measurement conditions

This changes the analyzer settings so that the input signal is displayed more clearly.

3. Press **CENTER**, **1**, **.**, **5**, **5** and **μm** .
A center wavelength of 1.55 μm is set.
4. Press **SPAN**, **8** and **nm**.
An analysis span of 8 nm is set.
5. Press **REF LEVEL**, **1**, **0** and **dBm**.
The reference level is set to 10 dBm.
6. Press **RESOLUTION** and **0.1 nm**.
A resolution of 0.1 nm is set.

Measuring the input signal to the light amplifier

7. Connect the optical fiber cable from the light source output connector to the optical spectrum analyzer **INPUT** connector.
8. Press **SINGLE**.
A sweep is performed and the spectrum is displayed.

2.2.8 Light Amplifier Characteristic Analysis

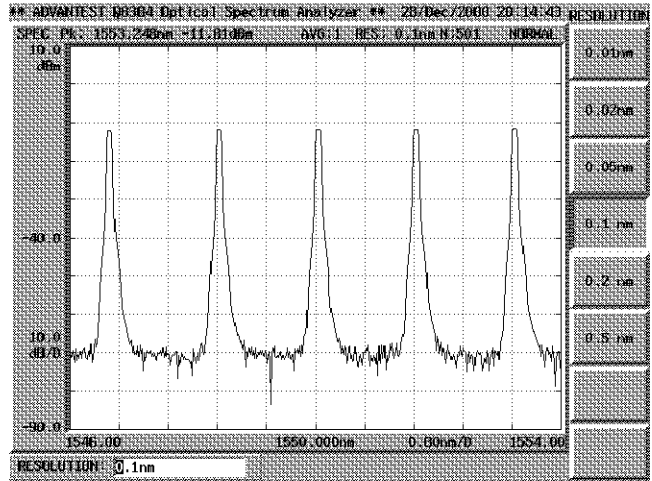

Figure 2-49 Measuring the Input Signal

Saving the reference data

9. Press **APPLICATION**, *opt.amp* and **MODE SNG/WDM** (WDM).
Because this procedure uses different wavelength signals, WDM is selected.
10. Press **SAVE Pin→REF DATA**.
The data associated with the input to the light amplifier is saved as reference data.

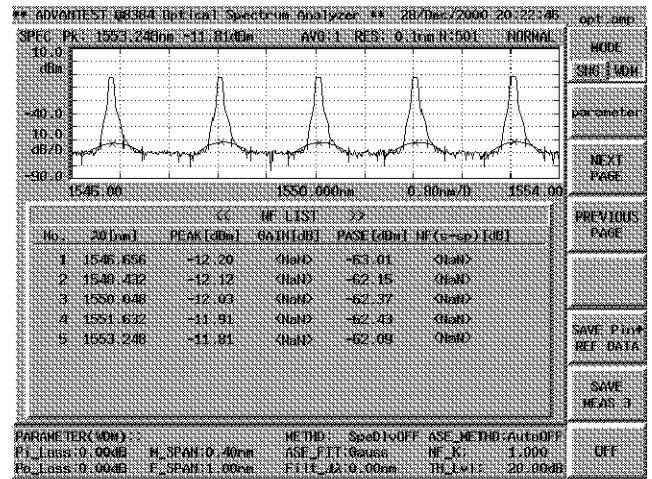

Figure 2-50 Saving the Reference Data

Measuring the output signal of the light amplifier

11. Connect the optical fiber cable from the light source output connector to the light amplifier **INPUT** connector.
12. Connect the optical fiber cable from the light amplifier output connector to the optical spectrum analyzer **INPUT** connector.

13. Press **SINGLE**.

A sweep is performed. The gain and NF are calculated and the resulting spectrum is displayed.

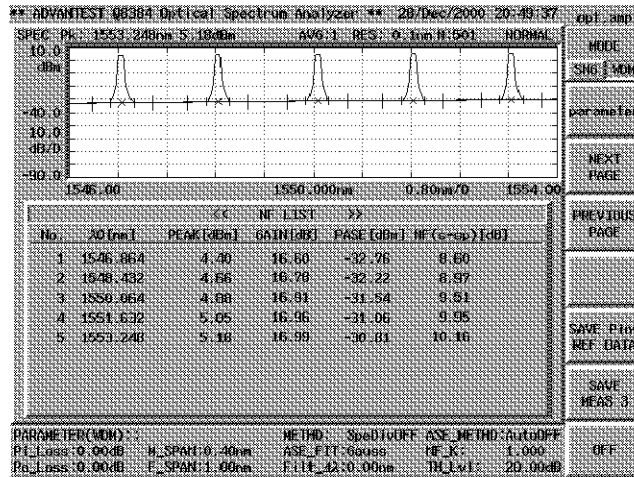

Figure 2-51 Measuring the Output Signal

Setting the analysis conditions

14. Press **parameter**.

The Optical AMP PARAMETER dialog box is displayed.

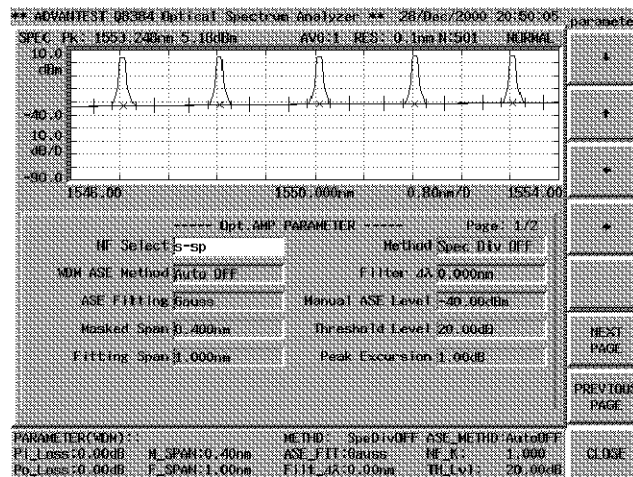

Figure 2-52 Optical AMP PARAMETER Dialog Box

To change parameters in the dialog box, move the cursor using the arrow key menu. Select a parameter and specify a value using the arrow keys, data knob, or numerical keypad.

2.2.8 Light Amplifier Characteristic Analysis

15. Select **ASE Fitting** and set it to **Gauss**.
The approximate expression used to calculate the ASE point becomes a Gaussian function.
16. Select **Masked Span** and set it to 1 nm.
17. Select **Fitting Span** and set it to 2 nm.
18. Select **Filter $\Delta\lambda$** (optical receiver's light-intercepting band when NF Select is set to total), and set it to 3 nm.
19. Press **NEXT PAGE**.
The next page of the dialog box is displayed.
20. Select **Pin Loss** (correction value for optical amplifier input loss in the measurement system), and set it to 0 dB.
21. Select **Pout Loss** (correction value for optical amplifier output loss in the measurement system), and set it to 0 dB.

For further information about step 15. to 21. above, refer to "5.4 GAIN&NF and SNR."

2.2.9 WDM Light Signal Characteristic Analysis

This section describes how to analyze main parameters of WDM light signals.

Measurement conditions: The target of the measurement is a WDM light signal source which has five channels and can generate light signals with a wavelength of $1.55\ \mu\text{m}$ and an output level of $+10\ \text{dBm}$.

Use appropriate parameter values when making the measurements in the example shown below.

Power on

1. Turn the **POWER** switch (on the front panel) on.
The startup screen is displayed after the self-test has been completed.

Initialization

This resets the current settings to the initial settings.

2. Press **INSTR PRESET** and **PRESET**.
The initial settings are read.

Connecting the input signal

3. Connect the optical fiber cable from the light source output connector to the optical spectrum analyzer **INPUT** connector.

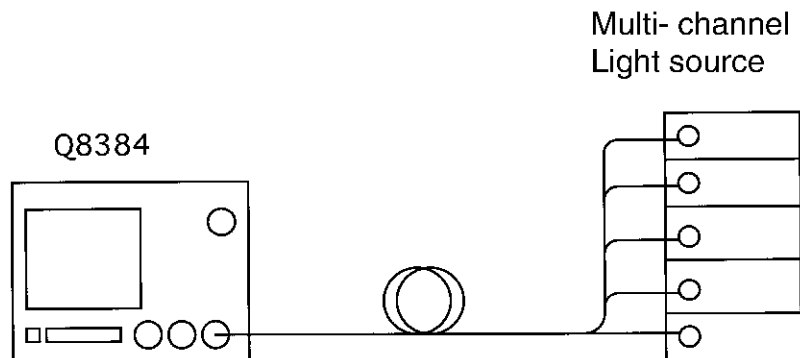

Figure 2-53 Input Signal Connections

Setting the measurement conditions

This changes the analyzer settings so that the input signal is displayed more clearly.

4. Press **CENTER**, **1**, **,**, **5**, **5** and **μm** .
A center wavelength of $1.55\ \mu\text{m}$ is set.

2.2.9 WDM Light Signal Characteristic Analysis

5. Press **SPAN**, **5** and **nm**.
An analysis span of 5 nm is set.
Set up the optical spectrum analyzer so that all channels in a WDM signal to be analyzed are displayed.
6. Press **REF LEVEL**, **+**, **20** and **dBm**.
The reference level is set to +20 dBm.
7. Press **RESOLUTION** and **0.05 nm**.
A resolution of 0.05 nm is set.

Performing the measurement

8. Press **SINGLE**.
A sweep is performed and the spectrum is displayed.

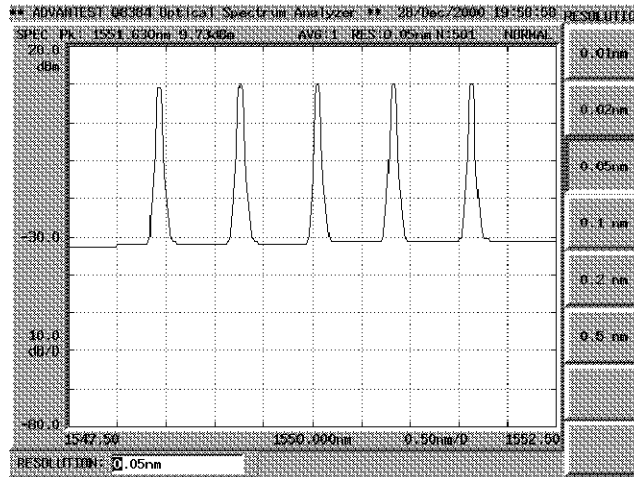

Figure 2-54 Measuring the Input Signal

Analyzing the wavelengths and levels of a WDM signal.

9. Press **APPLICATION**, *wdm* and **MULTI PEAK**.
The wavelength, frequency, and level of each spectrum peak are displayed on the lower part of the screen. The maximum and minimum peak levels and their CH Nos. from the displayed spectrum peaks are displayed as the max CH Power and min CH Power, respectively.
Channel numbers are given starting from 1 in ascending order of wavelength or frequency.
Up to eight sets of signal data can be displayed simultaneously. If there are more than eight sets of signal data, they can be displayed using NEXT PAGE or PREVIOUS PAGE.
In addition, pressing LIST ALL displays a list over the entire screen that can contain up to 24 sets of signal data.

CAUTION: When the command *SAVE* is executed in *LIST ALL* mode, data is saved to a floppy disk as list data (extension: *.WDM*) in *ASCII* format so that it can be loaded into an external PC. Note that this data cannot be reloaded into this analyzer.

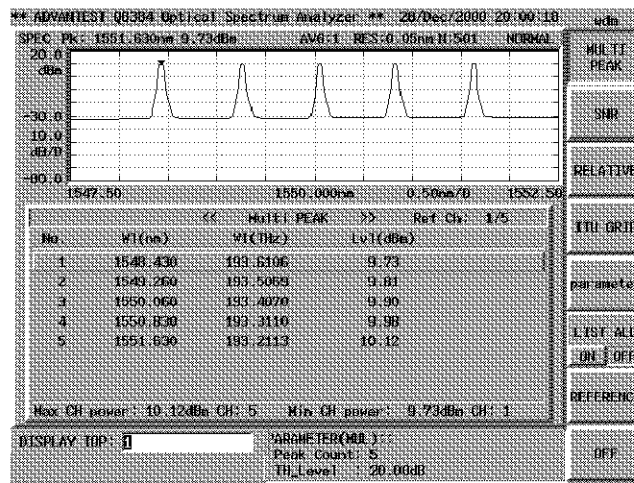

Figure 2-55 Displaying Multiple Peaks

Analyzing the wavelength differences and level differences of the spectral peaks.

10. Press **RELATIVE**.

The wavelength, wavelength intervals with adjacent peaks, difference in wavelength with the reference peak, as well as the level and difference with the reference level of each peak in the spectrum are displayed. Spectrum of No.01 is set as the default of the reference peak.

Furthermore, a linear approximation is conducted for the displayed peak. The level difference between the approximated line ends and the slope of the approximated line are displayed in Span Tilt dB and Span Tilt dB/nm, respectively.

11. Press **REFERENCE**, then either step key (Δ or ∇).
The reference peak wavelength selection is changed accordingly.

2.2.9 WDM Light Signal Characteristic Analysis

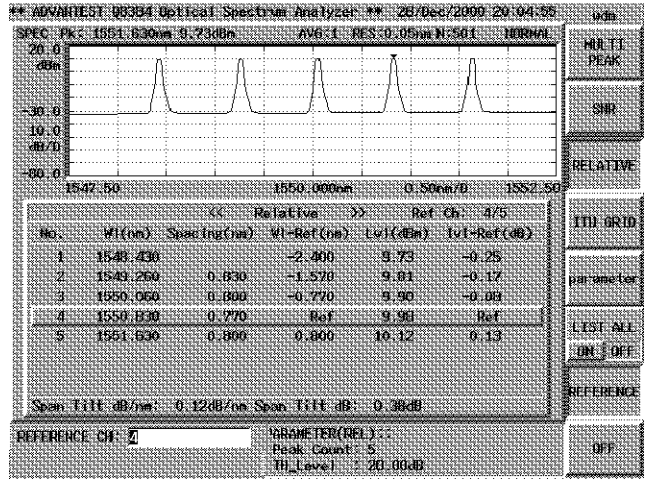

Figure 2-56 Displaying Relative Values

Analyzing the SNR

12. Press **SNR**.

The Pass and SNR of each spectrum peak are displayed. The maximum and minimum peak SNRs, and their CH Nos. from all of the displayed spectrum peaks are displayed as the max CH SNR and min CH SNR, respectively.

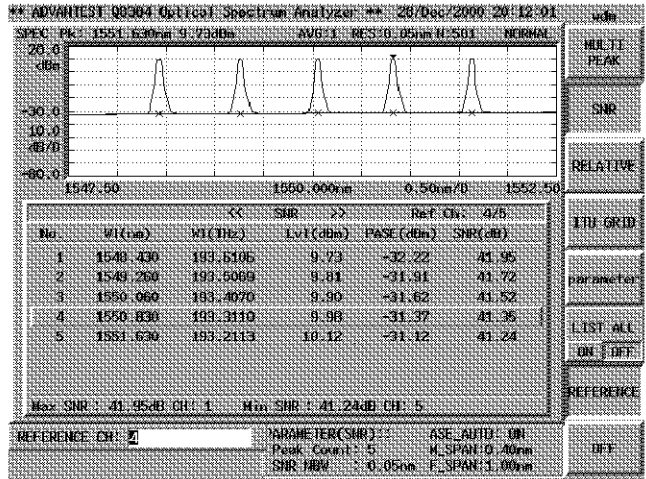

Figure 2-57 Displaying SNR

In this analyzer, setting the arithmetic parameter Signal Power Mode to Σ power displays the SNR which is calculated from the total power within the width set by the Masked Span (refer to Section 5.4, "GAIN&NF and SNR"). This mode is useful in measuring the modulated spectrum SNR (per signal).

2.2.10 WDM Optical Signal Measurements Using the Monitoring Function

This section describes the monitoring function that is used to automatically measure a WDM signal the specified number of times at constant intervals.

Measurement conditions: The measurement signal used in this example is a WDM optical signal with: a wavelength of 1.55 μm band, and 12 channels.

Power on

1. Turn the **POWER** switch (on the front panel) on.
The startup screen is displayed when the self test is completed.

Initialization

This resets the current settings to the initial settings.

2. Press **INSTR PRESET** and **PRESET**.
The initial settings are read.

Connecting the input signal

3. Connect the optical fiber cable from the light source output connector to the optical spectrum analyzer **INPUT** connector.

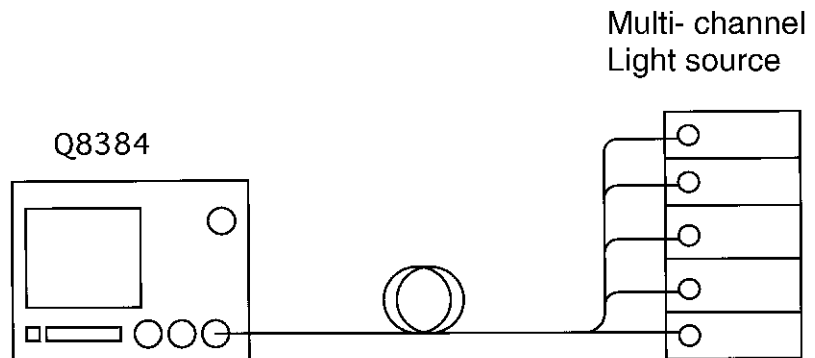

Figure 2-58 WDM Signal Connections

Setting the measurement conditions

This changes the analyzer settings so that the input signal is displayed more clearly.

4. Press **CENTER, 1, ., 5, 5** and **μm** .
A center wavelength of 1.55 μm is set.
5. Press **SPAN, 1, 0** and **nm**.
An analysis span of 10 nm is set.

2.2.10 WDM Optical Signal Measurements Using the Monitoring Function

6. Press **REF LEVEL, 0** and **dBm**.
The reference level is set to 0 dBm.
7. Press **RESOLUTION** and **0.1 nm**.
A resolution of 0.1 nm is set.

Performing the measurement

8. Press **SINGLE**.
A sweep is performed and the spectrum is displayed.

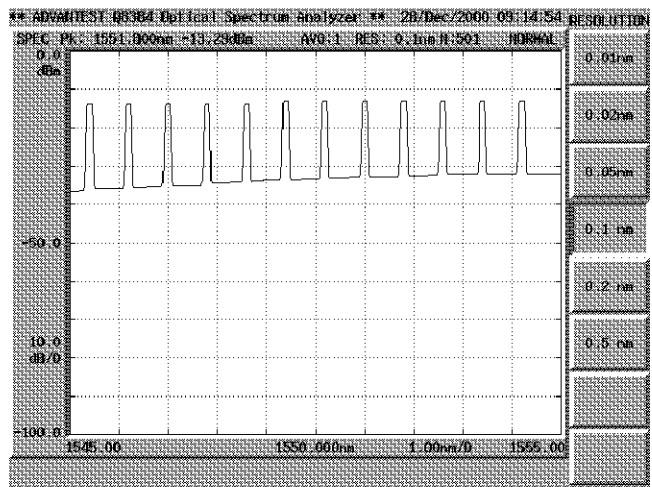

Figure 2-59 Measuring the Spectrum of a WDM Signal

Setting the measurement interval and the number of times the measurement is repeated

9. Press **APPLICATION** and **wdm monitor**.
The WDM monitor screen is displayed.

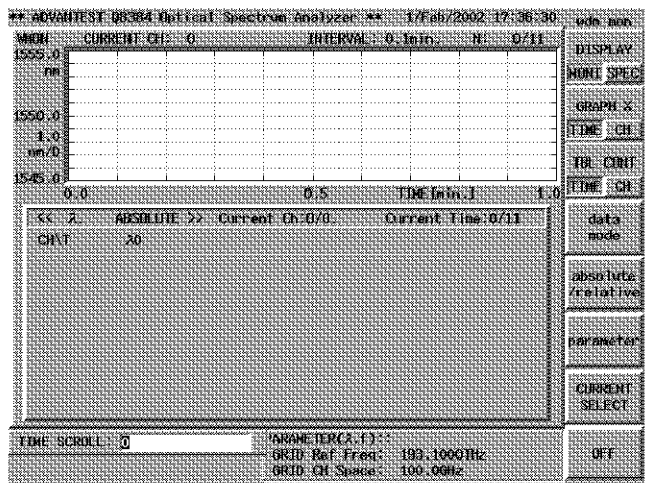

Figure 2-60 WDM Monitor Screen

2.2.10 WDM Optical Signal Measurements Using the Monitoring Function

10. Press **parameter**.
The WDM monitor parameter dialog box is displayed.

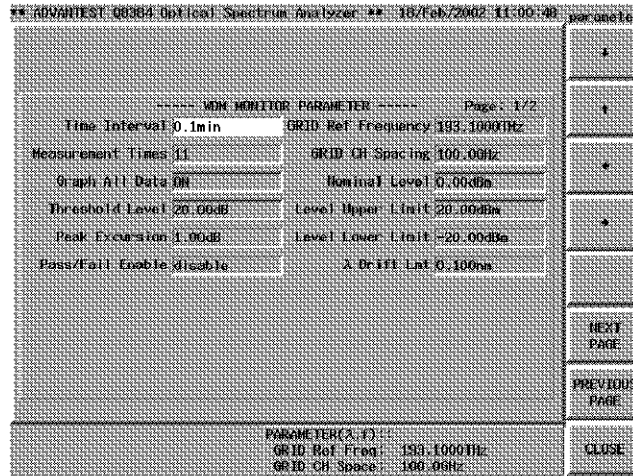

Figure 2-61 WDM Dialog Box Screen

11. Move the input cursor to Time Interval using the arrow keys on the soft keys.
12. Press **1** and **ENTER**.
The measurement interval is set to 1 minute.
13. In the same manner, move the input cursor to Measurement Times.
14. Press **2, 1** and **ENTER**.
The number of times is set to 21.
15. In the same manner, move the cursor to Graph All Data.
16. Turn Graph All Data off, using the step keys.
The graph drawn only by the current data is displayed in the upper part of the screen.
17. In the same manner, move the cursor to Nominal Level.
18. Press **-, 1, 3** and **dBm**.
Nominal level is set to -13 dBm.
19. Press **CLOSE**.
This operation closes the parameter dialog box and displays the WDM monitor screen.

2.2.10 WDM Optical Signal Measurements Using the Monitoring Function

20. Press **SINGLE**.
 (The REPEAT key is disabled when the instrument set to the WDM monitor function.)
 The WDM monitor measurement is started and the measurement is taken the specified number of times.
 The graph in the upper part of the screen indicates wavelength changes in the current channel optical signal along the time axis.
 (The current channel is set to the first channel as the initial value.)
 The wavelength measurement results for all channels are listed in absolute values in the table.

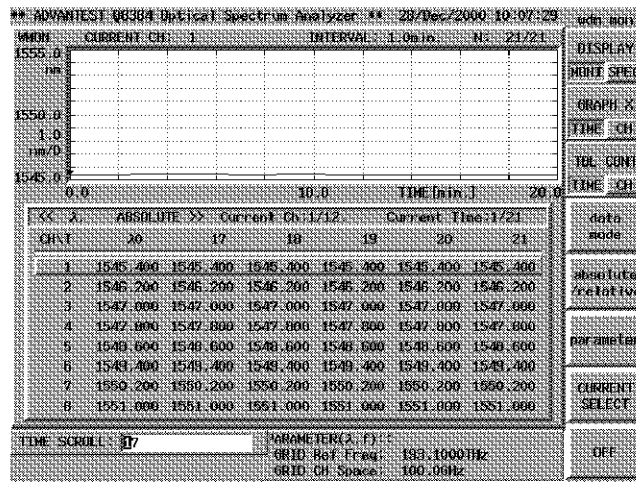

Figure 2-62 WDM Monitor Measurement Screen

21. The table data is scrolled to the top along the time axis using the arrow keys.
 (Pressing **TBL CONT TIME/CH** toggles the scroll mode between channel and time.)

Data analysis

Measurement data can be displayed in various modes.

22. Press **data mode** and **SNR**.
 The table data is now displayed as SNR for each channel, and the graph is displayed as the SNR changes for the current channel (along the time axis).
 In this case, the vertical range of a graph is within Nominal SNR \pm 10 dB.

2.2.10 WDM Optical Signal Measurements Using the Monitoring Function

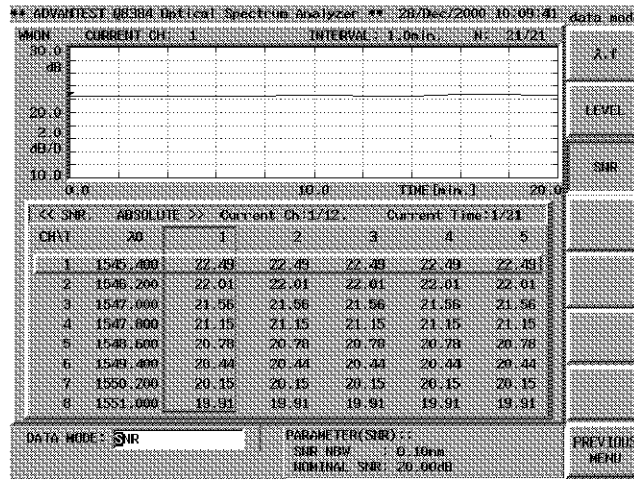

Figure 2-63 Displaying WDM Monitor SNR

23. Press **LEVEL**.

The table data is displayed as the signal level for each channel, and the graph is displayed as signal level changes for the current channel (along the time axis). In this case, the vertical range of a graph is within Nominal Level ± 10 dB.

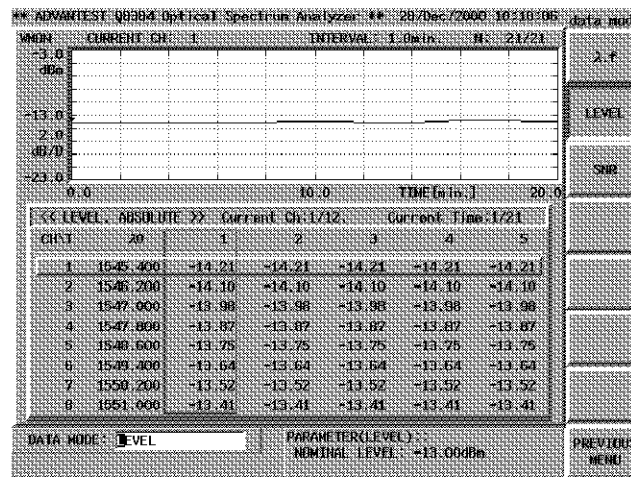

Figure 2-64 Displaying WDM Monitor Level

24. Press **PREVIOUS MENU**, *absolute/relative* and **INITIAL**.

The data is displayed as a value difference with respect to the first measurement value for each channel in a WDM signal. The graph is displayed in the same manner. In this case, the vertical range of a graph is within ± 10 dB.

2.2.10 WDM Optical Signal Measurements Using the Monitoring Function

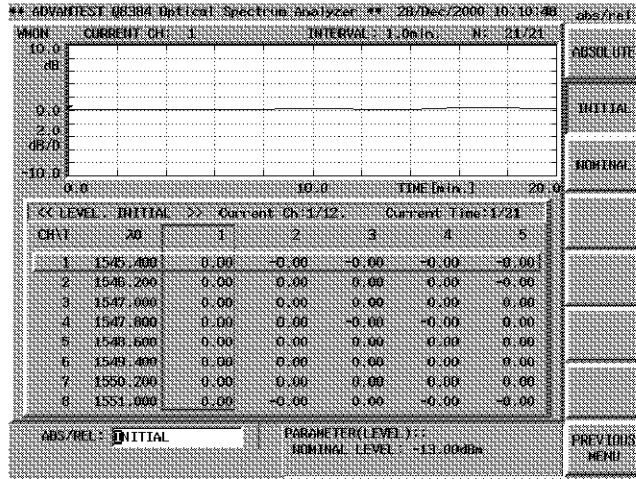

Figure 2-65 Displaying WDM Monitor Relative Values (INITIAL)

25. Press **NOMINAL**.

The data is displayed as the difference between Nominal LEVEL specified by parameter and the signal level for each channel.

The graph is displayed in the same manner.

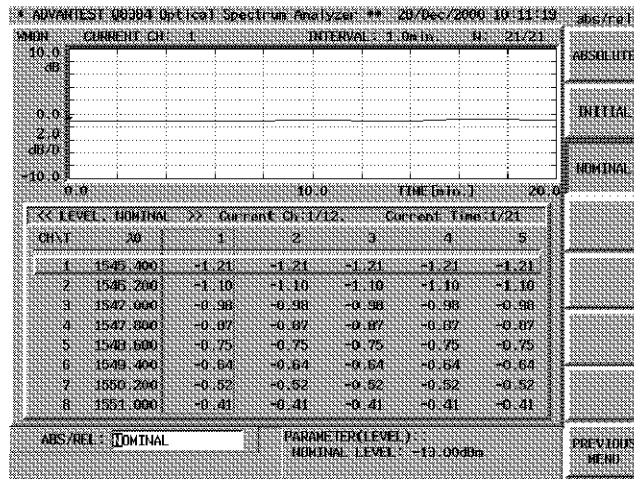

Figure 2-66 Displaying WDM Monitor Relative Values (NOMINAL)

26. Press **PREVIOUS MENU** and **GRAPH X TIME/CH**.

The horizontal axis represents the channel, and the data at the current time (the data for the first measurement is saved as the initial values) is displayed for each channel. The current channel is indicated with a marker.

2.2.10 WDM Optical Signal Measurements Using the Monitoring Function

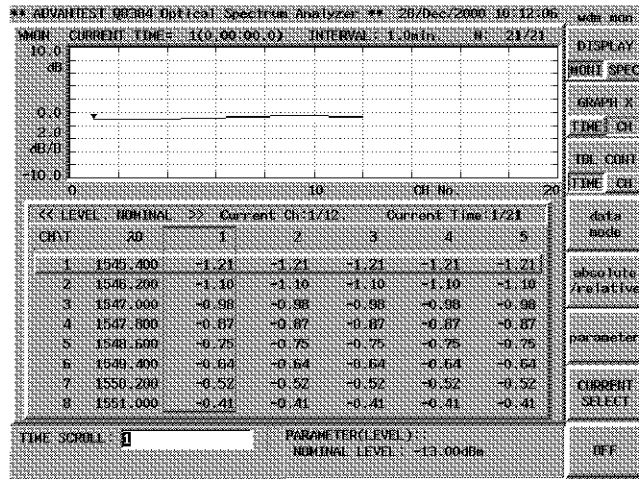

Figure 2-67 Displaying WDM Monitor Channels

27. Press **CURRENT SELECT**.

The data for an arbitrary time can be referred to by changing the current time with the arrow keys.

(Pressing **TBL CONT TIME/CH** toggles the current selection between channel and time.)

CAUTION: When the command **SAVE** is executed in the WDM monitor function, data is saved to a floppy disk as table data (extension: .WMN) in ASCII format so that it can be loaded into an external PC. Note that this data cannot be reloaded into this analyzer.

2.2.11 Limit Line Function for Device Evaluation

2.2.11 Limit Line Function for Device Evaluation

This section describes how to use the limit line function (used to make a Pass/Fail judgement based on the limit line).

Measurement conditions: Evaluating the transmission characteristics of a 1.55- μm -band bandpass filter.

Power on

1. Turn on the **POWER** switch (on the front panel).
When the self-test has completed, the startup screen is displayed.

Initialization

This resets the current settings to the initial settings.

2. Press **INSTR PRESET** and **PRESET**.
The INSTR PRESET menu is displayed.

Measuring the reference signal

3. Connect the SM fiber from the **OUTPUT** connector of the white light source to the **INPUT** connector on the optical spectrum analyzer.

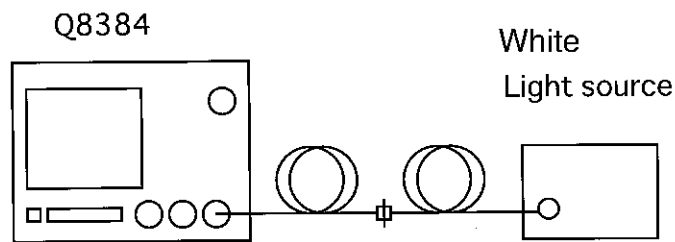

Figure 2-68 Measuring the Reference Data Used for Filter Transmission Characteristics

Measurement conditions are set so that the characteristics of a DUT can easily be observed.

4. Press **CENTER, 1, ,, 5, 5** and **μm** .
A center frequency of 1.55 μm is set.
5. Press **SPAN, 5, 0** and **nm**.
An analysis span of 50 nm is set.
6. Press **REF LEVEL, -, 2, 0** and **dBm**.
The reference level is set to -20 dBm.
7. Press **SWEEP MODE** and **ADAPTIVE**.
8. Press **RESOLUTION** and **0.5 nm**.
A resolution of 0.5 nm is set.

9. Press **SINGLE**.
The measurement is made
10. Press **NORMALIZE LOSS/TRANS** and **SAVE REF DATA**.
The reference spectrum data is saved in the memory.
11. Press **TRANS**.
The measurement mode is changed to the transmission characteristic.
(The reference waveform disappears and the transmission characteristic measurement mode is turned on.)
12. Press **LEVEL SCALE** and **5 dB/D**.
The grid spacing is set to 5 dB.

Setting the judgment criteria

Insert a floppy disk, which contains the judgment reference data file is saved, into the drive.

13. Press **ADVANCE**, *limit line* and **LOAD PATTERN FILES**.
(For information on how to create the judgment reference data, refer to Section 5.11, "Setting Limit Line.")
Load the judgment reference data from the floppy disk.

Selecting the judgment reference data

14. Press *pattern select* and **PATTERN5**.
The fifth file of the previously loaded criteria files (filename: lmtln5.txt) is selected. The criteria in the previously selected file is displayed on the measurement screen.
(If the criteria are not displayed, the settings for the criteria file and the settings for the optical spectrum analyzer do not match.)

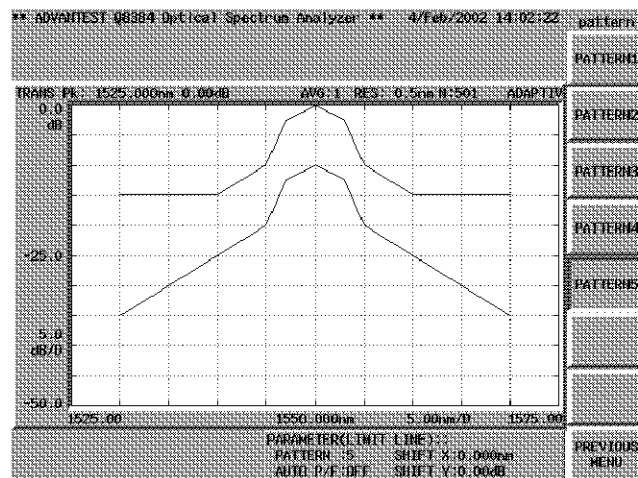

Figure 2-69 Displaying the Limit Line

2.2.11 Limit Line Function for Device Evaluation

Connecting the DUT

15. Connect the DUT.

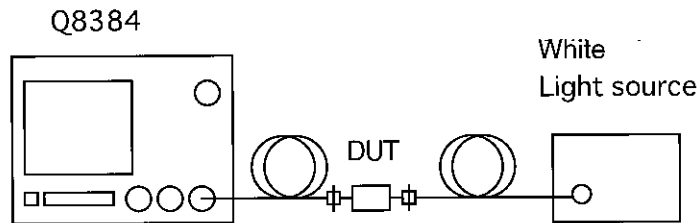

Figure 2-70 Connections Used for Device Evaluation

Transmission Characteristic Measurement

16. Press **SINGLE**.
Start the measurement.

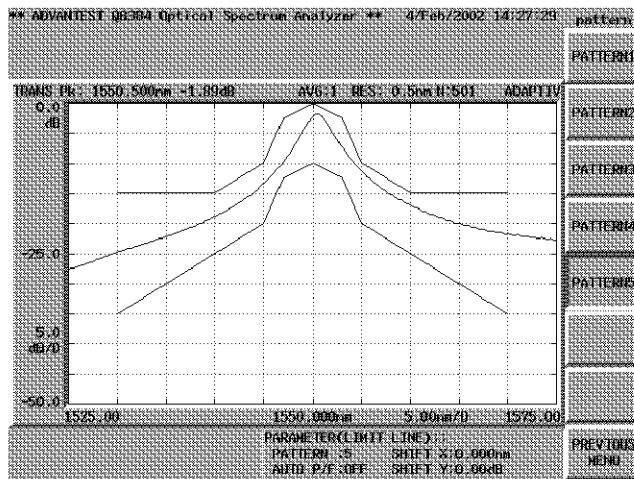

Figure 2-71 Transmission Characteristics of a Device to Be Evaluated (with the Limit Line Displayed)

17. Press **PASS/FAIL**.
This operation makes a Pass/Fail judgement based on the judgment criteria. In this analyzer, the PASS or FAIL judgement per sweep in the continuous sweep mode can be performed by turning the AUTO PASS/FAIL setting to ON.

2.2.12 Setting Measurement Conditions

This section describes the method of how to set measurement conditions for each item.

(1) Changing the horizontal axis unit

The horizontal axis of the optical analyzer can be toggled between the wavelength and the frequency when the measurement mode is set to Spectrum, Transmission or Loss Mode.

Setting the horizontal axis to the wavelength

1. Press **SPAN**.
2. Set **WAVE/FREQ nm/THz** to **nm**.

Setting the horizontal axis to the frequency

1. Press **SPAN**.
2. Set **WAVE/FREQ nm/THz** to **THz**.

(2) Setting the center wavelength or the center frequency

Setting the center wavelength using a numeric value and a unit

1. Press **CENTER**.
2. Enter a numeric value and a unit.
(If the horizontal axis is set to the wavelength, it can be adjusted in increments of 0.001 nm. If the horizontal axis is set to the frequency, it can be rounded off in increments equivalent to 0.001 nm.)

To set the wavelength (or frequency) at the maximum peak to the center wavelength (or frequency)

1. Press **CENTER** and **PEAK→CENTER**.

To set the center wavelength (or frequency) to the wavelength (or frequency) specified by the cursor

1. Move the X cursor to the desired wavelength (or frequency).
2. Press **CENTER** and **CURSOR→CENTER**.
When two X Cursors are displayed, the center wavelength or frequency is changed so that it is at the center of the wavelength or frequency between the two X Cursors.

2.2.12 Setting Measurement Conditions

(3) Setting the analysis span

Setting the span using a numeric value and a unit

1. Press **SPAN**.
2. Enter a numeric value and a unit.
(If the horizontal axis is set to the wavelength, it can be adjusted in increments of 0.1 nm. If the horizontal axis is set to the frequency, it can be rounded off in increments equivalent to 0.1 nm.)

Setting the span with a numeric value

1. Press **SPAN** and **START**.
2. Enter a numeric value and a unit.
3. Press **STOP**.
4. Enter a numeric value and a unit.

Setting the analysis span to the span specified by the X cursors

1. Determine the desired span using two X cursors.
2. Press **SPAN** and **CURSOR SPAN**.

(4) Setting the reference level

Setting the span using a numeric value and a unit

1. Press **REF LEVEL**.
2. Enter a numeric value and a unit.

Setting the reference level to the level at the maximum peak

1. Press **REF LEVEL** and **PEAK→REF LEVEL**.

Setting the reference level to the level specified by the cursor

1. Move the Y cursor to the desired wavelength.
2. Press **REF LEVEL** and **CURSOR→REF LEVEL**.

Setting a level range using two Y cursors

1. Determine the desired span using two Y cursors.
2. Press **REF LEVEL** and **CURSOR→REF LEVEL**.
A view range is set as shown below depending on the types of level display.

For LINEAR scale display

The reference level is set to the value indicated by the upper Y cursor, and the minimum level is set to the value indicated by the lower Y cursor.

For LOG scale display

The reference level is set to the value indicated by the upper Y cursor, and LEVEL SCALE is optimized automatically according to the level difference between the two cursors.

NOTE: *The optical analyzer automatically controls the input sensitivity so that the output signal reaches a suitable level.
(The REF LEVEL set during sweeps does not affect the measured trace.)*

(5) Setting the vertical axis

The vertical axis of the optical analyzer can be toggled between LINEAR and LOG Scales.

Setting the vertical axis to LINEAR Scale

1. Press **LEVEL SCALE**.
2. Set **LEVEL SCALE LIN/LOG** to LIN.

Setting the vertical axis to LOG Scale

1. Press **LEVEL SCALE**.
2. Set **LEVEL SCALE LIN/LOG** to LOG.

When the vertical axis set to the LOG scale, set the scale as follows.

Setting the scale using the soft key

1. Select a soft key from **10 dB/D**, **5 dB/D**, **2 dB/D**, **1 dB/D**, **0.5 dB/D**, **0.2 dB/D** and **0.1 dB/D**.

Setting the scale by entering a value and its unit

1. Enter a value and its unit (in increments of 0.1 dB).

2.2.12 Setting Measurement Conditions

(6) Setting the measurement resolution

Setting the resolution using the soft key

1. Press **RESOLUTION**.
2. Select an appropriate key from *0.01 nm*, *0.02 nm*, *0.05 nm*, *0.1 nm*, *0.2 nm* and *0.5 nm*.

Setting a value

1. Press **RESOLUTION**.
2. Enter a value and its unit (Any values are rounded down to 1, 2 or 5.).

(7) Setting the measurement points

Selecting the point using the soft key

1. Press **CONTROL** and *sampling point*.
2. Select an appropriate key from *101*, *201*, *501*, *1001*, *2001*, *5001* and *10001*.

Setting a value

1. Press **CONTROL** and *sampling point*.
2. Enter a value and press the **ENTER**.
(the value you entered is automatically replaced by one of the values that is the closest to the value you entered: 101, 201, 501, 1001, 2001, 5001 or 10001).

(8) Setting the averaging count

There are two types of averaging functions: the point averaging and sweep averaging functions. The point averaging function sets the sampling integration time (of the power measurement) proportional to the number of averaging.

The sweep averaging function calculates the average power for each sampling point after sweeping the specified number of times.

Choose a function as desired to improve the accuracy of low or unstable power level measurement.

Setting the number of point averaging

How to make settings using the soft keys

1. Press **AVG**, *point average*.
2. Select a soft key from *1*, *2*, *4*, *8*, *16*, *32* and *64*.

How to make settings by entering a value

1. Press **AVG** and *point average*.
2. Enter a value and press the **ENTER** (this function is turned off if you enter 1).

Setting the number of sweep averaging

How to make settings using the soft key

1. Press **AVG** and *sweep average*.
2. Select a soft key from *1, 2, 4, 8, 16, 32* and *64*.

How to make settings by entering a value

1. Press **AVG** and *sweep average*.
2. Enter a value and press the **ENTER** (this function is turned off if you enter 1).

(9) Setting the number of smoothing points

The optical spectrum analyzer has a function to obtain smoothed spectrums using the moving average.

Set the computing range for moving average (up to 11 points) if necessary, although smoothing is not normally required.

Setting the smoothing function

How to make settings using the soft key

1. Press **AVG** and *smoothing*.
2. Select a soft key from *1, 3, 5, 7, 9* and *11*.

How to make settings by entering a value

1. Press **AVG** and *smoothing*.
2. Enter a value and press the **ENTER** (A value entered is rounded up to an odd number between 3 and 11. If 1 is entered, this function is turned off).

(10) Setting the measurement mode

Choose the measurement mode according to the characteristics of the light under measurement and the sweep time.

For the measurement modes, refer to Section 5.1, "Measurement Modes."

2.2.12 Setting Measurement Conditions

(11) Sweeping

For a single sweep

1. Press **SINGLE**.

For repeated sweeps

1. Press **REPEAT**.

Stopping sweeping

1. Press **STOP**.

2.3 Using Expanded Functions and Inputting/Outputting Data

2.3.1 Entering Label Data

This function is used to enter labels (messages of up to 48 characters) which serve as comments for measured data and are displayed at the top of the screen. The initial (or current) settings are as follows. When α , β , γ , δ , λ , μ , Δ , Λ , Σ and \int included in the character list (referred to as the character menu) are sent through GPIB, they changed to blank characters.

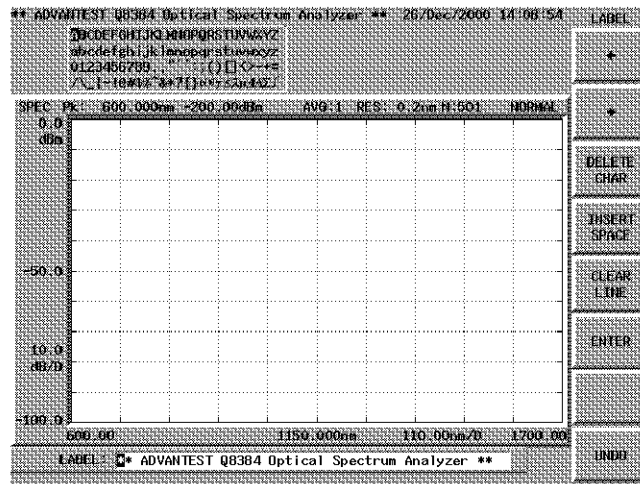

Figure 2-72 Label Data

Changing label data

The example shown below shows how to change the character string ADVANTEST to STAR by using the panel keys.

1. Press **LABEL**.
A list of characters which can be entered (referred to as the character menu) is displayed at the top of the screen.
The current label is displayed in the lower left-hand corner of the screen.
2. Position the cursor to the left of A of the character string ADVANTEST.
3. Select S from the character menu and press **ENTER**.
4. Repeat Step 3. until you finish to enter TAR.
5. Press **DELETE CHAR** five times to delete NTEST.
6. Press **ENTER** on the DATA section of the front panel to update the label.

NOTE: After LABEL has been pressed, steps 2 thru 6 can be performed directly from an external keyboard.

2.3.2 Selecting Color Patterns on the Screen

2.3.2 Selecting Color Patterns on the Screen

There are five color patterns and you can select any one from these patterns as follows: press **DEVICE**, *color* and select a pattern by pressing **PATTERN-1** through **PATTERN-5** as desired.

2.3.3 Setting Date/Time

The optical analyzer includes the clock function backed up by a battery.

Displaying Date and Time

1. Press **DEVICE**, *clock* and **DISPLAY ON/OFF**(ON).
Date and time are displayed in the upper right corner of the screen.
As an example, set a time of 15:35 for September 20, 1999.

NOTE: To delete the displayed data, press **DISPLAY ON/OFF** again.

Altering the Date

2. Select **YEAR**, and set it to 1999, using the step keys or data knob.
3. Select **MONTH**, and set it to 9 September, using the step keys or data knob.
4. Select **DAY**, and set it to 20, using the step keys or data knob.

Altering the Time

5. Select **HOUR**, and set it to 15, using the step keys or data knob.
6. Select **MINUTE**, and set it to 35, using the step keys or data knob.

NOTE: Seconds are automatically set to 0 when the hour is changed.

2.3.4 Saving or Reading Data

2.3.4.1 Floppy Disk

The optical analyzer is equipped with a 3.5-inch floppy disk drive.

Measurement data, WDM list data and BMP data (screen display) can be saved to a floppy disk. Data saved to floppy disks can also be accessed from a personal computer.

3.5-inch DD 720 K or HD 1.44 MB (compliant with the MS-DOS format) can be used with the optical spectrum analyzer.

(1) Inserting Floppy Disks

1. Insert a floppy disk into the floppy disk drive with the label surface up.

(2) Removing Floppy Disks

1. Verify that the lamp on the drive is not lit and then remove the disk.

CAUTION: *Do not remove the floppy disk while the drive lamp is lit, since this indicates that floppy disk is being accessed. If you remove the disk while the disk is being accessed, you may damage the data contained on the disk.*

2. Press the eject button.
The floppy disk is ejected from the drive.
3. Remove the disk from the drive.

(3) Formatting a Floppy Disk

To save data to a new floppy disk, be sure to format the floppy disk first. Use the following procedure to format a floppy disk.

NOTE: *Only DD 720 K or HD 1.44 MB floppy disks can be formatted. HD 1.2 MB floppy disks cannot be formatted.*

1. Make sure the write protection switch is unlocked.

CAUTION: *Formatting a floppy disk will erase any information stored on that disk, including the label Q8384.*

2. Insert the floppy disk into the disk drive.
3. Press **DEVICE**, *floppy* and *format*.
4. Press **EXECUTE** after selecting **2DD(720K)** or **2HD(1.44 M)**.

2.3.4 Saving or Reading Data

2.3.4.2 Backup Memory

The following data is stored in the backup memory: 15 or more screens (assuming a sampling of 501 sampling points) of measurement data.

2.3.4.3 Saving Data

Measurement data can be saved to the backup memory or to a floppy disk. This section describes the procedure used to save measurement data to the backup memory.

Selecting a device to save data

1. Press **SAVE** and **SAVE MEM/FDD(MEM)**.
Backup memory is selected as the destination to save data.

Setting a file name

2. Press **SAVE**, **save meas data** and **name**.
The character menu is displayed.
For information on how to enter data, refer to Section 2.3.1, "Entering Label Data."
3. After typing the file name, press **ENTER** on the DATA section of the front panel.
The file name is registered.
4. Execute **SAVE**.
The file name is saved into the backup memory.

A file name can also be entered from an external keyboard.

The data saved on a floppy disk using the optical spectrum analyzer can be loaded into an external personal computer. Refer to Appendix A.4.

NOTE: *If you save data without specifying the file name, the center frequency of the file is saved as the file name.
When the value which is going to be saved already exists, the last center frequency value added by 1 becomes the file name having a value between 001 and 999.*

2.3.4.4 Reading Data

This reads data from a floppy disk.

Selecting the device to be used

1. Press **RECALL** and **RECALL MEM/FDD(FDD)**.
The floppy disk drive is selected as the device.

Selecting Data

2. Press **RECALL**, **recall meas data** and **RECALL**.
The measurement data selected is recalled.
The floppy disk file list is displayed on the screen.
3. Position the cursor on the name of the file you wish to open.
4. Press **RECALL**.
The specified file is opened and the contents are displayed on the screen.

2.3.5 Outputting Data (Hard Copy)

2.3.5 Outputting Data (Hard Copy)

2.3.5.1 Internal printer

1. Press **DEVICE**, *select output* and **INTERNAL PRINTER**.
The internal printer is selected as the output destination.
2. Press **DEVICE**, *printer* and **MENU OUT ON/OFF**.
MENU OUT ON/OFF is used to set whether to output the soft menu.
3. Press **COPY**.
The data is output to the internal printer.

2.3.5.2 External printer

This section describes how to print out screen data.

This analyzer system can output screen data to the provided printer using a parallel interface (compliant with the Centronics). Even though a color printer is connected to the analyzer, the printer prints out in monochrome.

NOTE: *The output resolution of this analyzer system is 180 dots/inch. Using a printer with a resolution other than integral multiples of 180 dots/inch may cause striped patterns to appear.*

Printers provided with ESC/P, ESC/P raster, or HP PCL as the printer control code can be used with this analyzer (some printer operations may be restricted).
Table 2-1 shows typical examples.

Table 2-2 Recommended Printers

Manufacturer	Model
EPSON	PM-750C (ESC/P R)
HEWLETT-PACKARD	DeskJet 694C (PCL), DeskJet 880L (PCL)
CANON	BJC-430J (ESC/P)

Connecting the printer

1. Connect the printer cable to the **PRINTER** connector on the rear panel.
The printer cable specified by the printer manufacturer must conform to IBM-PC specifications.

CAUTION: *To prevent the units from being damaged, the printer cable should be connected after turning the power off.*

2. Press **DEVICE**, *select output* and **EXTERNAL PRINTER**.
The external printer is selected as the output destination.

Setting the Print Mode

3. Press **DEVICE**, *printer* and *external printer*.
The soft menu used to select the print mode and the printer control code is selected.
4. Select **MODE:GRAY**, **MODE:MONO S** or **MODE:MONO L**.
The grayscale, small monochrome or large monochrome output mode is selected.
5. Press one of **COMMAND:ESC/P**, **COMMAND:HP PCL** and **COMMAND:ESC/P RAS**.
ESC/P, HP PCL or ESC/P RAS is enabled. The optical analyzer can use any of these printer control codes: ESC/P (Epson Standard Code for Printer), HP PCL (Hewlett Packard Printer Command Language) or ESC/P (Epson Standard Code for Printer Raster mode). Select the desired mode.
6. Press **DEVICE**, *printer* and **MENU OUT ON/OFF**.
This turns MENU OUT on or off.

Printing Data

7. Display the screen you wish to print and press **COPY**.
The data is output to the external printer.

2.3.5.3 Floppy disk

The analyzer is used to save screen data in BMP (bitmap) format onto floppy disks so that the data can be loaded on an external computer.(The analyzer cannot be used to load data in BMP format.)

Inserting a floppy disk

1. Insert a floppy disk into the floppy disk drive.

Setting the destination device

2. Press **DEVICE**, *select output* and **FLOPPY DISK**.
The floppy disk is selected as the output destination.

2.3.5 Outputting Data (Hard Copy)

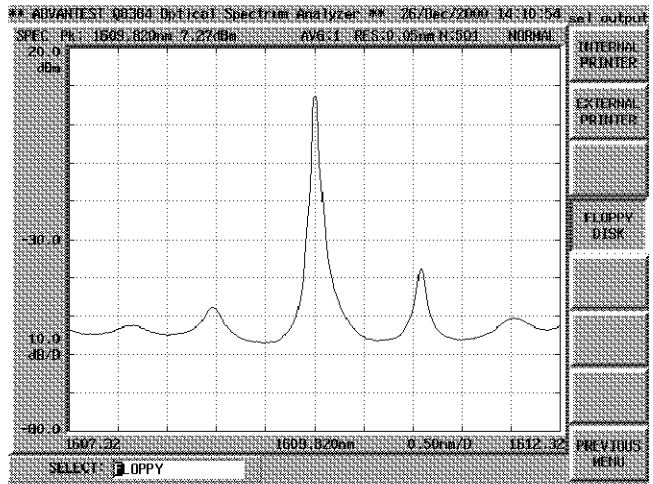

Figure 2-73 Selecting the Floppy Disk

3. Press **DEVICE**, *floppy*, *bit map* and **MODE:MONO**.
The bitmap is saved in monochrome.
4. Press **DEVICE**, *floppy*, *bit map* and **COMPRESS ON/OFF**.
This sets whether to compress the bit map.
5. Press **COPY** after displaying the screen data to be saved. The access lamp remains lit while the screen data is being saved to disk, and goes out when the file has been saved.

CAUTION: Do not remove the floppy disk while the access lamp is lit, since the floppy disk is being accessed. If you remove the disk while the disk is being accessed, you may damage the data on the disk.

3 REFERENCE

This chapter describes the functions of all panel and soft keys.

- Menu index: Use this index as a key index to Chapter 3.
- Menu map: Shows a list of hierarchical menus on a panel key basis.
- Functional descriptions: Explains the functions of the panel and soft keys.

3.1 Menu Index

This menu index is used to easily find the keys described in Chapter 3.

<u>Operation Key</u>	<u>Pages</u>	<u>Operation Key</u>	<u>Pages</u>
↑	3-9, 3-10, 3-11, 3-12, 3-29, 3-31, 3-34, 3-37, 3-39, 3-40	0.2dB/D	3-6, 3-21
↓	3-9, 3-10, 3-11, 3-12, 3-29, 3-31, 3-34, 3-37, 3-39, 3-40	0.2nm	3-7, 3-22
←	3-9, 3-10, 3-11, 3-12, 3-15, 3-17, 3-29, 3-31, 3-34, 3-37, 3-39, 3-40, 3-45, 3-52	0.5dB/D	3-6, 3-21
→	3-9, 3-10, 3-11, 3-12, 3-15, 3-17, 3-29, 3-31, 3-34, 3-37, 3-39, 3-40, 3-45, 3-52	0.5nm	3-7, 3-22
ΔMODE	3-13, 3-42	1(OFF)	3-7, 3-25
λ Drift Lmt	3-11, 3-35	10001	3-14, 3-44
λ OFFSET	3-17, 3-51	1001	3-14, 3-44
λ.f	3-10, 3-33	101	3-14, 3-44
λ1	3-13	10dB/D	3-6, 3-21
λ2	3-13	11	3-7, 3-26
0.01nm	3-7, 3-22	16	3-7, 3-25
0.02nm	3-7, 3-22	1dB/D	3-6, 3-21
0.05nm	3-7, 3-22	2	3-7, 3-25
0.1dB/D	3-6, 3-21	2001	3-14, 3-44
0.1nm	3-7, 3-22	201	3-14, 3-44
		2dB/D	3-6, 3-21
		2DD(720K)	3-16, 3-48
		2HD(1.44M)	3-16, 3-48
		2ND PEAK	3-13, 3-42
		3	3-7, 3-25
		32	3-7, 3-25
		4	3-7, 3-25
		5	3-7, 3-25
		5001	3-14, 3-44
		501	3-14, 3-44
		5dB/D	3-6, 3-21
		64	3-7, 3-25
		7	3-7, 3-26
		8	3-7, 3-25
		9	3-7, 3-26
		ABORT	3-8, 3-26
		ABSOLUTE	3-10, 3-34
		absolute/relative	3-10, 3-34
		acpr	3-9, 3-40
		ACT U&L ON/OFF	3-14, 3-43

3.1 Menu Index

ADAPTIVE	3-7, 3-23	DELETE ALL.....	3-14, 3-43
ADDRESS DOWN.....	3-17, 3-50	DELETE CHAR	3-17, 3-52
ADDRESS UP	3-17, 3-50	DELETE CURRENT.....	3-14, 3-43
ADVANCE.....	3-13	DEVICE.....	3-16
APPLICATION	3-9	device	3-9, 3-37
ASE Converted NBW	3-10, 3-11,	dfb-ld.....	3-11, 3-39
	3-32, 3-36	DIRECTORY.....	3-16, 3-47
ASE Fitting	3-9, 3-10,	DISPLAY MONI/SPEC	3-10, 3-33
	3-11, 3-30,	DISPLAY ON/OFF	3-16, 3-48
	3-31, 3-35	DUAL ON/OFF	3-14, 3-43
ASE NBW.....	3-10, 3-11,	EDGE RISE/FALL.....	3-7, 3-24
	3-32, 3-36	ENTER.....	3-15, 3-17,
AUTO	3-8		3-45, 3-52
AUTO ALIGNMENT.....	3-17, 3-51	ENVELOPE.....	3-9, 3-28
AUTO ON/OFF	3-14, 3-44	EXECUTE	3-16, 3-17,
AUTO PASS/FAIL ON/OFF.....	3-13, 3-41		3-47, 3-51
AUTO PKC ON/OFF	3-6, 3-18	EXIT	3-15, 3-45,
AUTO RELV ON/OFF.....	3-6, 3-20		3-46
AUTO TRAC ON/OFF	3-14, 3-43	EXT KEY US/JP	3-16, 3-48
AVG.....	3-7	EXTERNAL PRINTER.....	3-16, 3-47
BEEP ON/OFF	3-16, 3-49	external printer	3-16, 3-47
bit map	3-16, 3-48	FEED	3-17
buzzer.....	3-16, 3-49	Filter $\Delta\lambda$	3-9, 3-30
CAL	3-17	filter tilt	3-11, 3-39
CAL λ (Ext.).....	3-17, 3-51	Fitting Span.....	3-9, 3-10,
CAL λ (Int.)	3-17, 3-51		3-11, 3-30,
CENTER	3-6		3-32
CLEAR LINE	3-17, 3-52	Fitting span	3-35
clock.....	3-16, 3-48	floppy	3-16, 3-47
CLOSE.....	3-9, 3-10,	FLOPPY DISK	3-16, 3-47
	3-11, 3-12,	format.....	3-16, 3-47
	3-29, 3-31,	fp-ld.....	3-11, 3-39
	3-34, 3-37,	FULL SPAN	3-6, 3-19
	3-39, 3-40	GATE TIME.....	3-7, 3-24
color	3-16, 3-48	Graph All Data.....	3-11, 3-34
COMMAND:ESC/P	3-16, 3-47	GRAPH X TIME/CH.....	3-10, 3-33
COMMAND:ESC/P RAS.....	3-16, 3-47	GRID CH Spacing	3-10, 3-11,
COMMAND:HP PCL.....	3-16, 3-47		3-12, 3-32,
COMPRESS ON/OFF	3-16, 3-48		3-35, 3-37,
CONTROL.....	3-14		3-40
COPY	3-17	GRID ON/OFF	3-14, 3-43
CUR+MEAS1→CURRENT	3-8, 3-27	GRID Ref Frequency	3-10, 3-11,
CUR-MEAS1→CURRENT	3-8, 3-27		3-12, 3-32,
CURRENT SELECT	3-10, 3-36		3-35, 3-37,
CURSOR SPAN	3-6, 3-19		3-40
CURSOR→CENTER	3-6, 3-18	Half Band Threshold.....	3-11, 3-37
CURSOR→REF LEVEL.....	3-6, 3-20	HEADER ON/OFF	3-17, 3-50
data mode.....	3-10, 3-33	HI DYNAMIC1	3-7, 3-23
DAY	3-16, 3-49	HI DYNAMIC2	3-7, 3-23
DELAY	3-7, 3-24	HI-SENS1	3-7, 3-23
DELETE	3-15, 3-45	HI-SENS2	3-7, 3-23

HOUR.....	3-16, 3-49	multi trace	3-14, 3-43
INITIAL.....	3-10, 3-34	name.....	3-15, 3-45
INSERT SPACE.....	3-17, 3-52	NAME CLEAR.....	3-15, 3-45
INSTR PRESET	3-17	NEXT.....	3-14, 3-43
INTERNAL PRINTER.....	3-16, 3-47	NEXT PAGE	3-9, 3-10,
INTERVAL TIME.....	3-13, 3-41		3-11, 3-29,
Isolation Pass	3-11, 3-38		3-31, 3-34,
Isolation Stop.....	3-11, 3-38		3-38
ITU GRID	3-10, 3-31	NF K	3-9, 3-30
K.....	3-9, 3-28	NF Select.....	3-9, 3-30
Kr(RMS).....	3-9, 3-28	NOMINAL.....	3-10, 3-34
L1	3-13	Nominal Level	3-11, 3-35
L2	3-13	Nominal SNR.....	3-11, 3-35
LABEL.....	3-17	NORMAL	3-7, 3-13,
led.....	3-11, 3-40		3-23, 3-42
LEFT PEAK	3-13, 3-42	NORMALIZE LOSS/TRANS.....	3-8
LEVEL.....	3-9, 3-10,	notch width	3-9, 3-29
	3-29, 3-33	o-bpf.....	3-11, 3-37
Level Lower Lmt	3-11, 3-35	OFF	3-9, 3-10,
LEVEL OFFSET	3-17, 3-51		3-11, 3-12,
LEVEL SCALE	3-6		3-13, 3-14,
Level Upper Lmt.....	3-11, 3-35		3-29, 3-31,
limit line	3-13, 3-41		3-33, 3-36,
LIST ALL ON/OFF.....	3-10, 3-32		3-38, 3-39,
LOAD PATTERN FILES.....	3-13, 3-41		3-40, 3-41,
LOCAL	3-17		3-42, 3-43
LOSS.....	3-8, 3-27	ON/OFF	3-13
LVL SCALE LIN/LOG	3-6, 3-21	opt.amp	3-9, 3-29
Manual ASE Level.....	3-9, 3-10,	parameter	3-7, 3-9,
	3-11, 3-30,		3-10, 3-11,
	3-32, 3-35		3-12, 3-23,
Masked Span	3-9, 3-10,		3-28, 3-29,
	3-11, 3-30,		3-31, 3-34,
	3-31, 3-35		3-37, 3-39,
MAX HOLD ON/OFF.....	3-6, 3-20		3-40
MAX HOLD→CURRENT	3-6, 3-20	Pass Band Threshold.....	3-11, 3-37
Measurement Times.....	3-11, 3-34	PASS/FAIL.....	3-13, 3-41
MENU OUT ON/OFF	3-16, 3-47	Pass/Fail Enable	3-11, 3-35
Method	3-9, 3-30	pattern select	3-13, 3-41
MIN HOLD ON/OFF	3-6, 3-20	PATTERN-1	3-16, 3-48
MIN HOLD→CURRENT	3-6, 3-20	PATTERN1	3-13, 3-41
MINUTE.....	3-16, 3-49	PATTERN-2	3-16, 3-48
MODE SNG/WDM	3-9, 3-29	PATTERN2	3-13, 3-41
MODE:COLOR	3-16, 3-48	PATTERN-3	3-16, 3-48
MODE:GRAY	3-16, 3-47,	PATTERN3	3-13, 3-41
	3-48	PATTERN-4	3-16, 3-48
MODE:MONO	3-16, 3-48	PATTERN4	3-13, 3-41
MODE:MONO L.....	3-16, 3-47	PATTERN-5	3-16, 3-48
MODE:MONO S	3-16, 3-47	PATTERN5	3-13, 3-41
MONTH.....	3-16, 3-48	Peak Excursion	3-9, 3-10,
MULTI PEAK	3-10, 3-31		3-11, 3-12,

3.1 Menu Index



	3-30, 3-32, 3-35, 3-39	SAVE REF DATA.....	3-8, 3-15, 3-27, 3-45
PEAK NORMALIZE	3-8, 3-27	SCALE.....	3-10, 3-33
peak power-mon	3-13, 3-41	Search Area Pass.....	3-11, 3-37
PEAK RMS.....	3-9, 3-28	Search Area Stop	3-11, 3-38
PEAK TO PEAK	3-13, 3-42	select output	3-16, 3-47
PEAK→CENTER.....	3-6, 3-18	SELF TEST.....	3-17, 3-50
PEAK→REF LEVEL	3-6, 3-20	SHIFT X	3-13, 3-41
PEAK-THRESHOLD	3-9, 3-28	shift X/Y	3-13, 3-41
Pin Loss.....	3-9, 3-30	SHIFT Y	3-13, 3-41
point average.....	3-7, 3-25	SHOW PARAM ON/OFF	3-13, 3-41
Pout Loss.....	3-9, 3-31	Signal Power Mode.....	3-10, 3-32
POWER	3-13, 3-42	SINGLE	3-8
PRESET	3-17, 3-50	smoothing.....	3-7, 3-25
PREV	3-14, 3-43	SNR.....	3-10, 3-31, 3-33
PREVIOUS PAGE	3-9, 3-10, 3-11, 3-29, 3-31, 3-34, 3-38	SNR Lower Lmt.....	3-11, 3-35
printer.....	3-16, 3-47	SPAN	3-6, 3-19
PULSE	3-7, 3-23	spectral width.....	3-9, 3-28
QUIET ON/OFF	3-16, 3-49	START.....	3-6, 3-8, 3-19, 3-26
RECALL.....	3-15, 3-46	Start Wavelength.....	3-11, 3-39
RECALL MEAS 1	3-15, 3-46	Std Wavelength.....	3-11, 3-38
RECALL MEAS 2.....	3-15, 3-46	STOP.....	3-6, 3-8, 3-19
RECALL MEAS 3.....	3-15, 3-46	Stop Band Threshold	3-11, 3-37
recall meas data.....	3-15, 3-46	Stop Wavelength.....	3-11, 3-39
RECALL MEM/FDD	3-15, 3-46	sweep average	3-7, 3-25
RECALL OFFSET ON/OFF	3-17, 3-51	SWEEP MODE.....	3-7
RECALL REF DATA	3-15, 3-46	SYNC HI/LOW	3-7, 3-23
RECOVER.....	3-15, 3-45	TBL CONT TIME/CH.....	3-10, 3-33
REF LEVEL	3-6	Threshold Level	3-9, 3-10, 3-11, 3-30, 3-32, 3-35
REFERENCE.....	3-10, 3-33	Threshold Level 1	3-12, 3-39
RELATIVE.....	3-10, 3-31	Threshold Level 2	3-12, 3-40
REPEAT	3-8	THRESHOLD LVL1(dB).....	3-9, 3-28
RESOLUTION	3-7	THRESHOLD LVL2(dB).....	3-9, 3-28
RIGHT PEAK.....	3-13, 3-42	Time Interval.....	3-11, 3-34
Ripple Select	3-11, 3-37	TRACE MAX.....	3-14, 3-43
RMS	3-9, 3-28	TRANS	3-8, 3-27
S.IMPOSE ON/OFF	3-14, 3-43	UNDO.....	3-17, 3-52
SAMPLING POINT	3-13, 3-41	WARNING ON/OFF.....	3-16, 3-49
sampling point.....	3-14, 3-44	WAVE/FREQ nm/THz.....	3-6, 3-19
SAVE	3-15, 3-45	wdm	3-9, 3-31
SAVE MEAS 1	3-8, 3-15, 3-27, 3-45	WDM ASE Method	3-9, 3-10, 3-11, 3-30, 3-31, 3-36
SAVE MEAS 2	3-15, 3-45	wdm monitor.....	3-9, 3-33
SAVE MEAS 3.....	3-9, 3-15, 3-31, 3-45	WIDTH	3-9, 3-28, 3-29
save meas data	3-15, 3-45		
SAVE MEM/FDD	3-15, 3-45		
SAVE Pin→REF DATA	3-9, 3-31		

X-CHANGE UPR/LOW.....	3-14, 3-44
XdB WIDTH.....	3-9, 3-29
Xnm LEVEL.....	3-9, 3-28, 3-29
YEAR.....	3-16, 3-48

3.2 Menu Map

3.2 Menu Map

This section shows the hierarchical menu configuration on a panel key basis.

NOTE:  Represents a panel key.
 Represents a dialog box.
Unless otherwise noted, the soft menus are shown.

CENTER



PEAK→CENTER
CURSOR→CENTER
AUTO PKC ON/OFF

SPAN

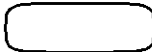

SPAN
START
STOP
CURSOR SPAN
FULL SPAN
WAVE/FREQ nm/THz

REF LEVEL



PEAK→REF LEVEL
CURSOR→REF LEVEL
MAX HOLD→CURRENT
MIN HOLD→CURRENT
MAX HOLD ON/OFF
MIN HOLD ON/OFF
AUTO RELV ON/OFF

LEVEL SCALE



LVL. SCALE LIN/LOG
10dB/D
5dB/D
2dB/D
1dB/D
0.5dB/D
0.2dB/D
0.1dB/D

RESOLUTION

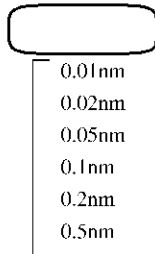

SWEEP MODE

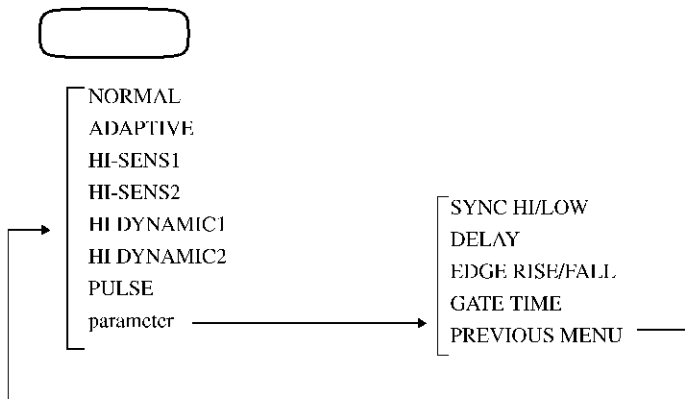

AVG

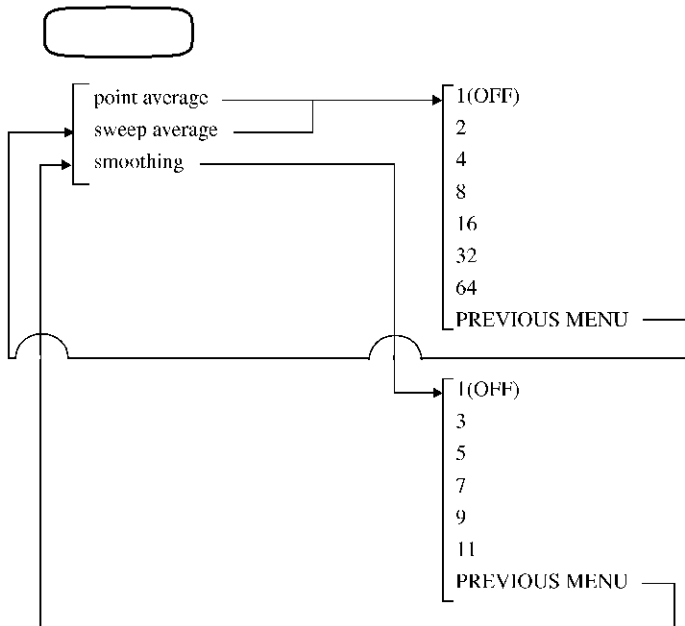

3.2 Menu Map

AUTO



- START
- ABORT

SINGLE

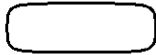

REPEAT



STOP



**NORMALIZE
LOSS/TRANS**

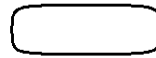

- PEAK NORMALIZE
- LOSS
- TRANS
- CUR+MEAS1→CURRENT
- CUR-MEAS1→CURRENT
- SAVE REF DATA
- SAVE MEAS 1

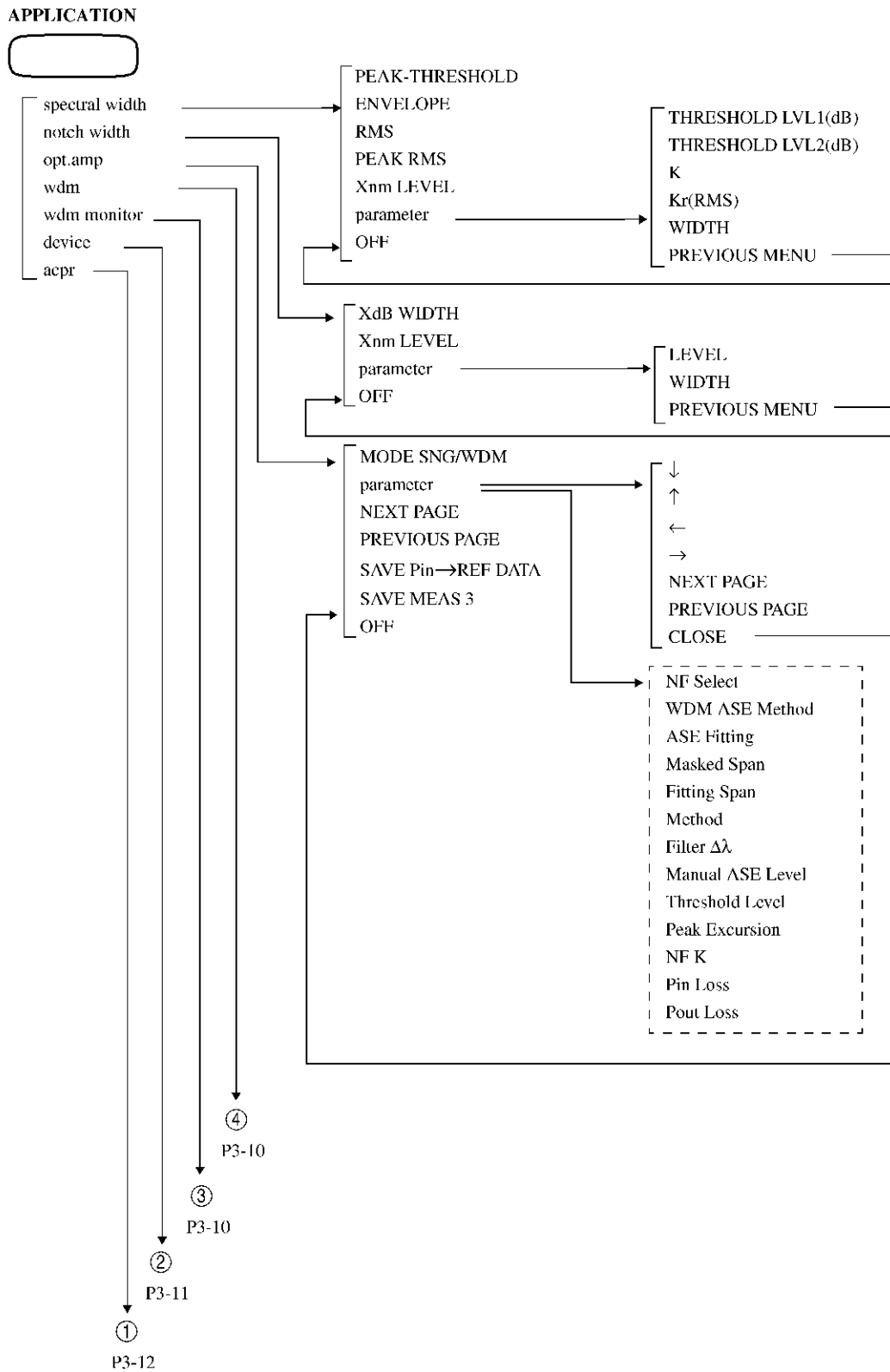

3.2 Menu Map

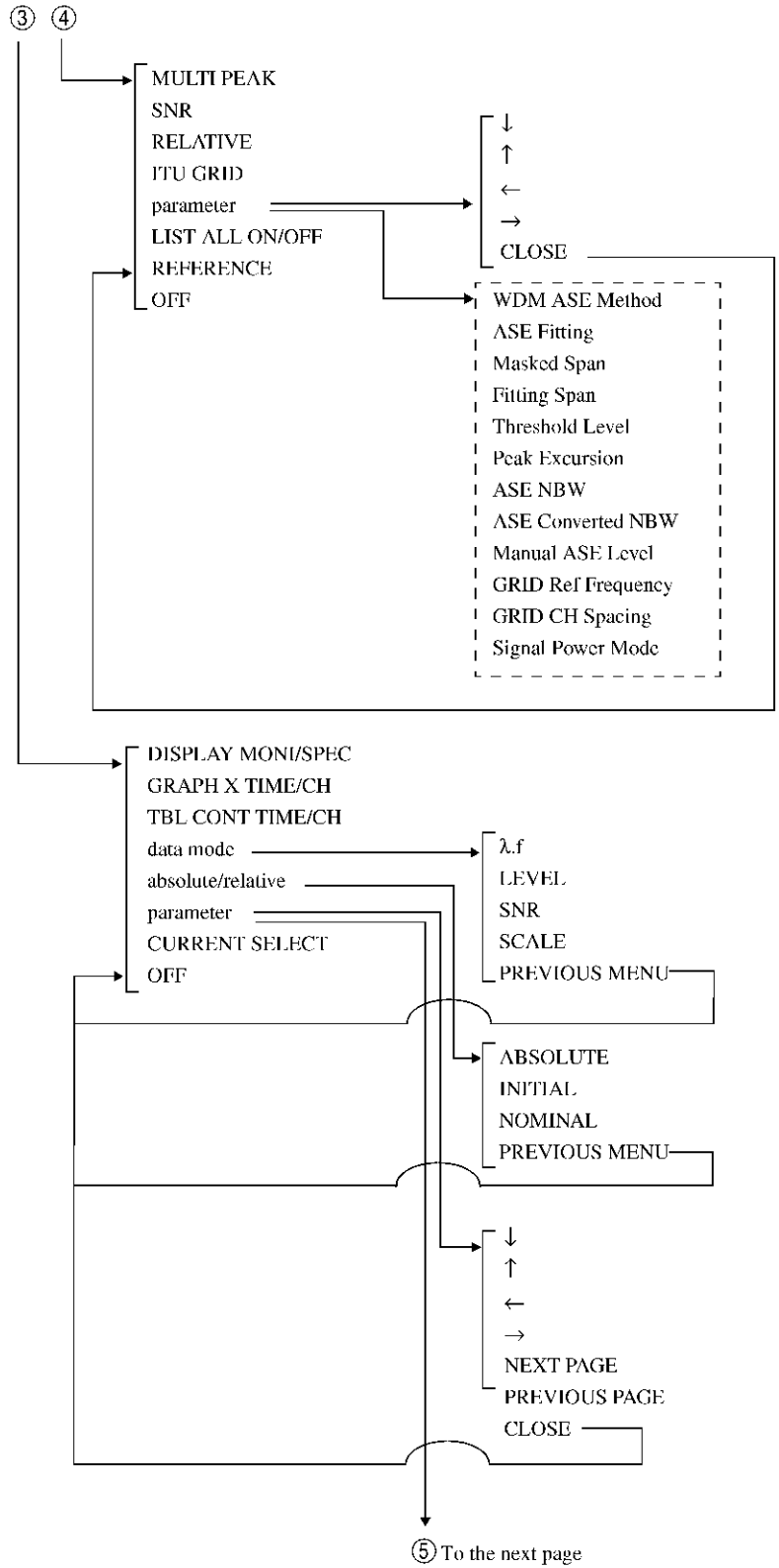

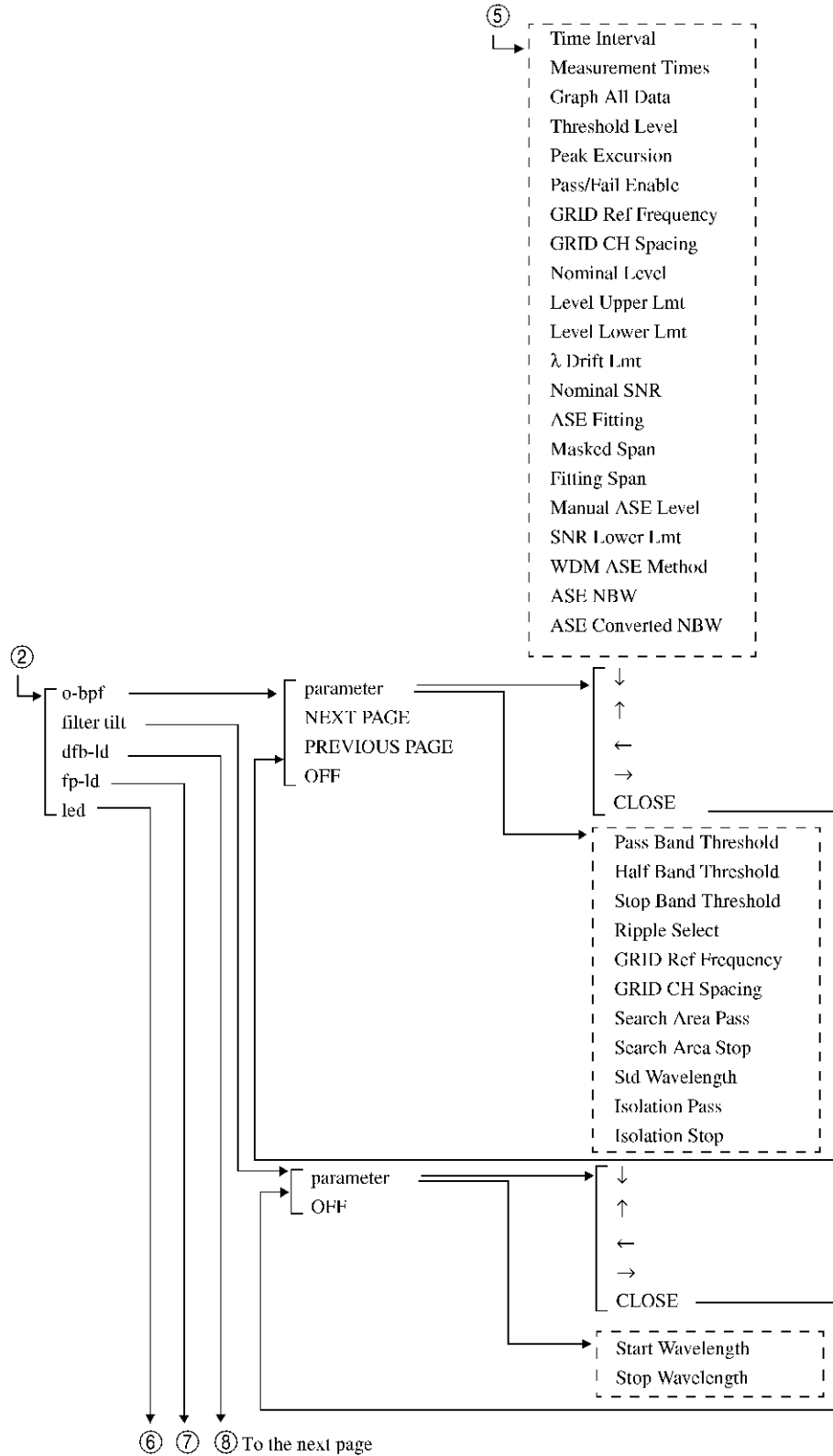

3.2 Menu Map

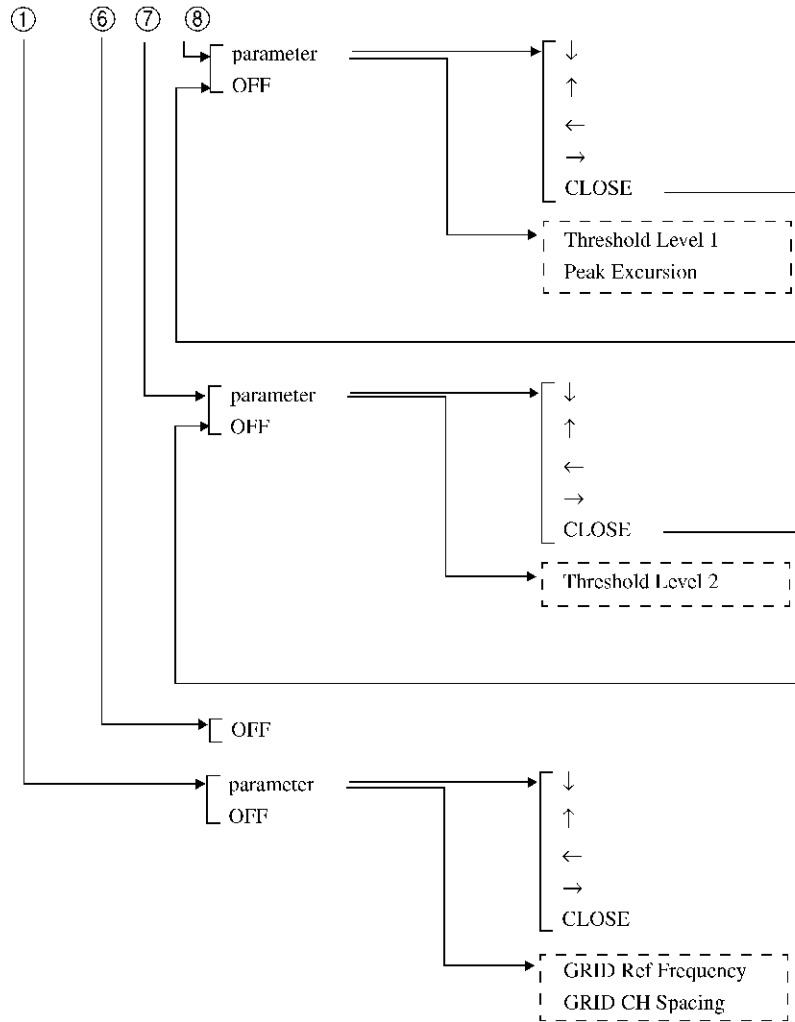

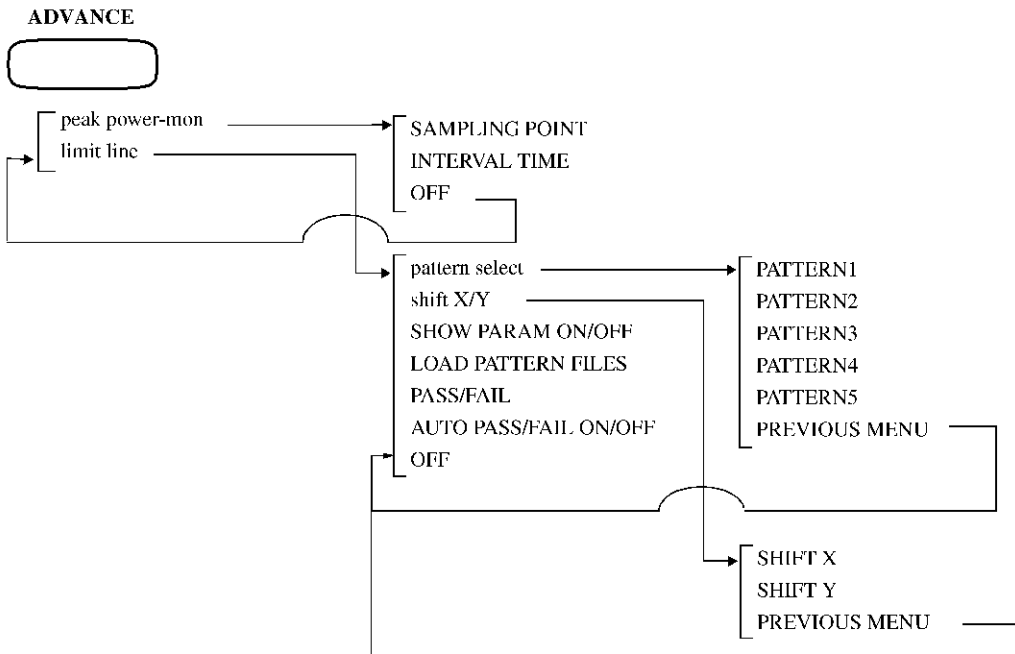

ON/OFF (CURSOR Section)



- NORMAL
- ΔMODE
- 2ND PEAK
- POWER
- PEAK TO PEAK
- LEFT PEAK
- RIGHT PEAK

λ_1



λ_2

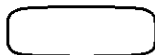

L1

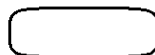

L2

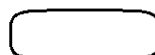

3.2 Menu Map

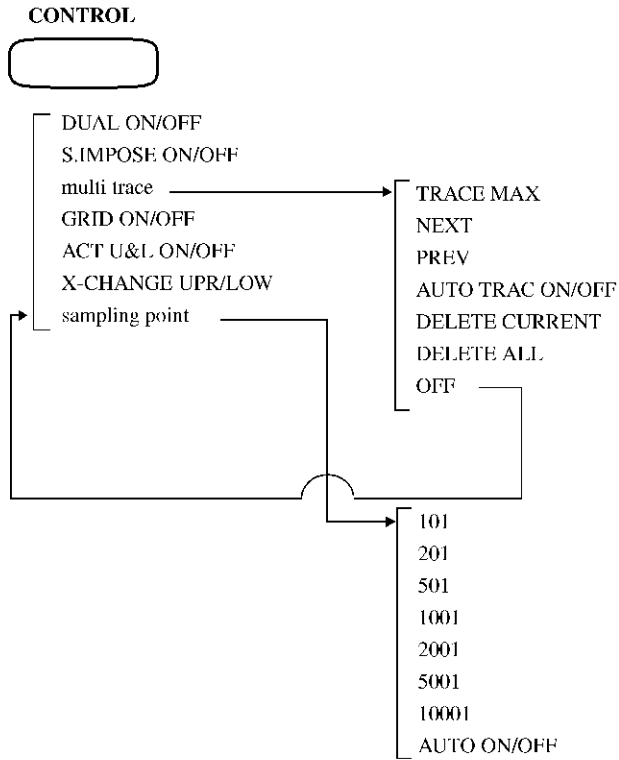

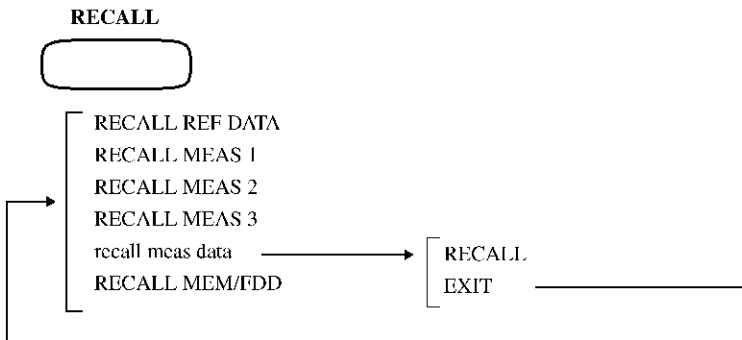
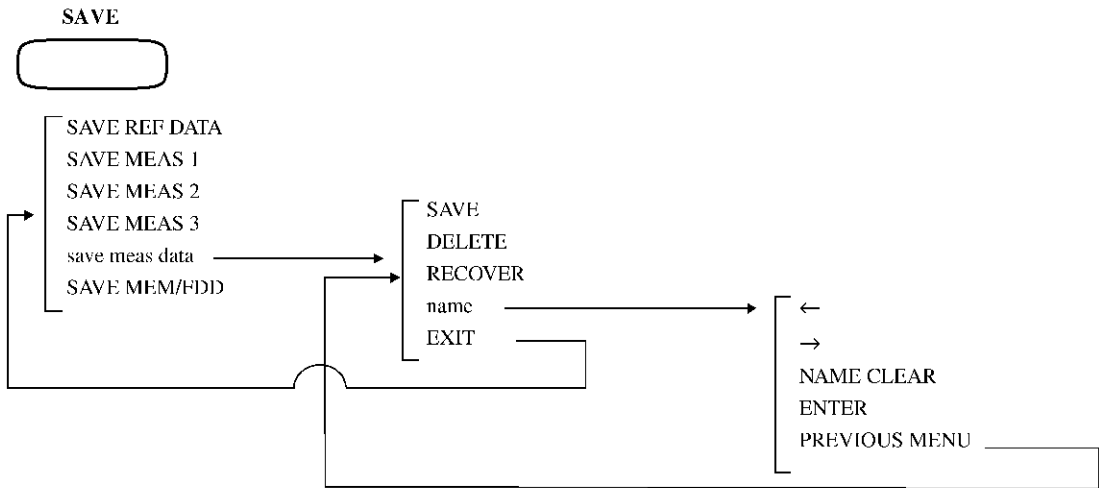

3.2 Menu Map

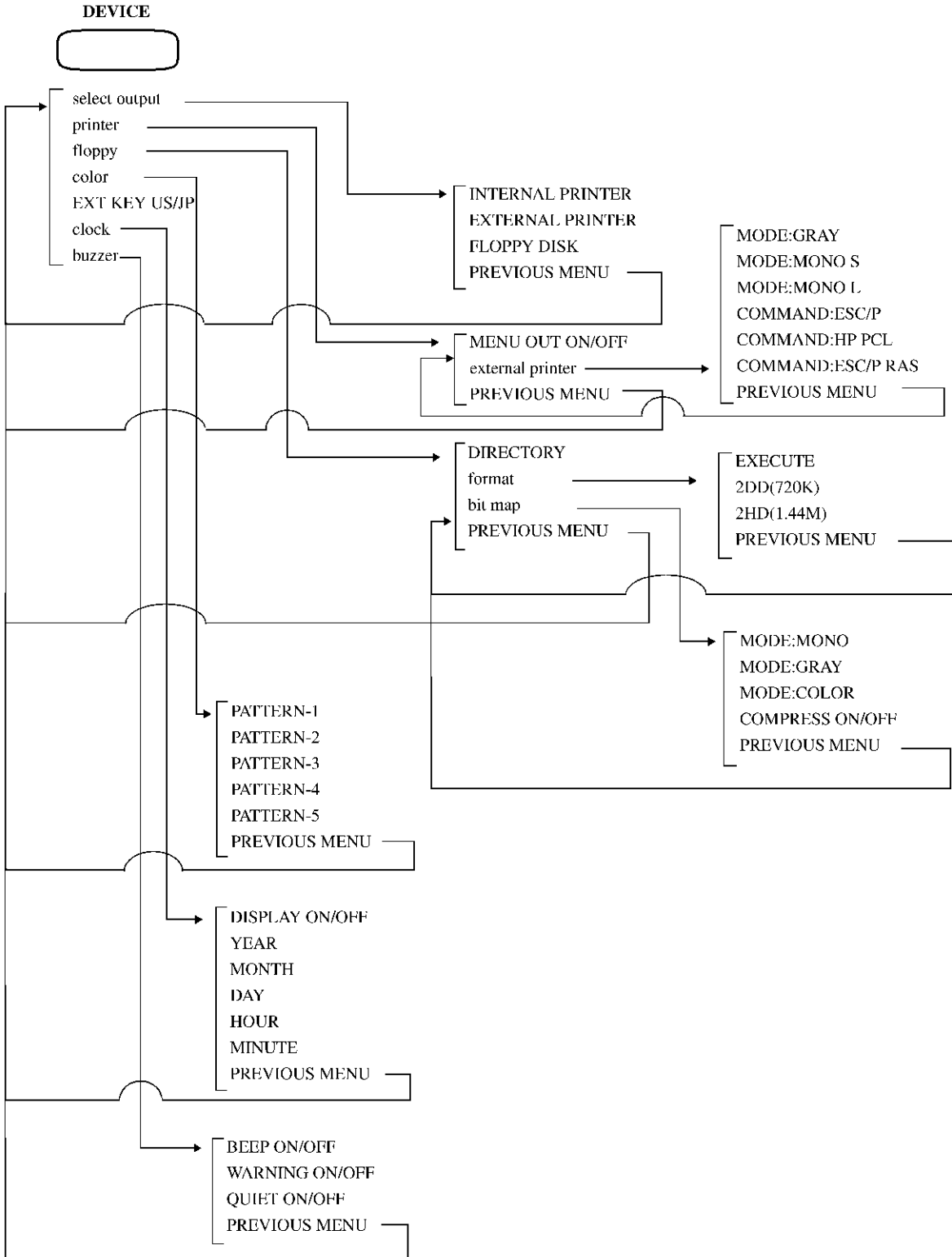

COPY

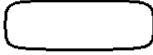

FEED



LOCAL

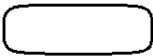

- HEADER ON/OFF
- ADDRESS UP
- ADDRESS DOWN

INSTR PRESET



- PRESET
- SELF TEST

CAL

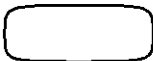

- CAL λ (Int.)
- CAL λ (Ext.)
- EXECUTE
- λ OFFSET
- LEVEL OFFSET
- RECALL OFFSET ON/OFF
- AUTO ALIGNMENT

LABEL



- ←
-
- DELETE CHAR
- INSERT SPACE
- CLEAR LINE
- ENTER
- UNDO

3.3 Functional Description

3.3 Functional Description

This chapter describes the functions of panel key and soft key operations.

3.3.1 CENTER Key

Pressing the **CENTER** key displays the CENTER menu and allows you to set the center wavelength (or frequency).

PEAK→CENTER

Sets the maximum peak wavelength of the displayed spectrum to the center wavelength (or frequency).

CURSOR→CENTER

Sets the center wavelength (or frequency) according to the value of the X cursor.

If the X cursor is not displayed, pressing this key will be ignored.

When using the single X cursor mode, the wavelength of the X cursor is set to the center wavelength (or frequency).

When using the dual X cursor mode, the wavelength at the intermediate position of each cursor is set to the center wavelength (or frequency).

AUTO PKC ON/OFF

Toggles the auto peak center function on or off.

ON: The measured maximum peak wavelength is set to the center wavelength (or frequency) and the measurement is performed again. If the difference between the peak wavelength and the center wavelength is more than approximately 1/100 of the span, the auto peak center function will be activated.

OFF: Turns the auto peak center function off.

When the upper and lower screens in the dual display are both active (ACT U&L is ON), the auto peak center function is effective for the upper screen.

3.3.2 SPAN Key

Pressing the **SPAN** key displays the SPAN menu and allows you to set the span wavelength (or frequency).

<i>SPAN</i>	Sets the span wavelength (or frequency) of the spectrum to be measured.
<i>START</i>	Sets the start wavelength (the wavelength on the left side of the screen) (or frequency) of the spectrum to be measured.
<i>STOP</i>	Sets the stop wavelength (the wavelength on the right side of the screen) (or frequency) of the spectrum to be measured.
<i>CURSOR SPAN</i>	Sets the wavelength (or frequency) range of the spectrum to be measured into the area sandwiched by the two X cursors. The center wavelength (or frequency) will be set at the center position of the two X cursors.
<i>FULL SPAN</i>	Sets the wavelength (or frequency) range of the spectrum to be measured to the maximum (1100 nm). The center wavelength will be changed to 1150 nm.(338.0013 THz)
<i>WAVE/FREQ nm/THz</i>	The horizontal axis is changed to the wavelength or frequency. nm: Sets the spectrum horizontal axis to the wavelength. THz: Sets the spectrum horizontal axis to the frequency.

3.3.3 REF LEVEL Key

3.3.3 REF LEVEL Key

Pressing the **REF LEVEL** key allows display of the REF LEVEL menu and allows you to set the reference level.

PEAK→REF LEVEL Sets and displays the reference level again so that the peak level of the currently displayed spectrum is located at a height covering approximately 95% of the screen.

CURSOR→REF LEVEL Sets and displays the position of the Y cursor as the reference level.

MAX HOLD→CURRENT The MAX HOLD waveform is changed to Current.

MIN HOLD→CURRENT The MIN HOLD waveform is changed to Current.

MAX HOLD ON/OFF Toggles the MAX HOLD function on or off.

ON: Displays a spectrum whose measurement points have the maximum level among the sweeps performed up to this time.

OFF: Turns the MAX HOLD function off.

MIN HOLD ON/OFF Toggles the MIN HOLD function on or off.

ON: Displays a spectrum whose measurement points have the minimum level among the sweeps performed up to this time.

OFF: Turns the MIN HOLD function off.

AUTO RELV ON/OFF Toggles the function for setting the optimum reference level for each measurement to the input signal on or off.

ON: Displays the reference level automatically optimized for each sweep.

OFF: Turns off the function for automatically setting the reference level.

CAUTION *The contents indicated by the cursor are changed when MIN HOLD or MAX HOLD is turned on. For more information, refer to Section 5.10, "Cursor Modes and Explanation for Displayed Data"*

3.3.4 LEVEL SCALE Key

Pressing the LEVEL SCALE key displays the LEVEL SCALE menu and allows you to set the level scale.

LVL SCALE LIN/LOG

Toggles the function of the level scale between linear and logarithmic modes.

The graduation scale on the display can be changed only when the display is set to the log mode.

LIN: Displays the level scale linearly.

LOG: Displays the level scale logarithmically.

When the level scale is set to log mode, press the LEVEL SCALE key and enter a scale value using the numeric keys so that the scale can be set in steps of 0.1 dB/div.

10dB/D

The grid is displayed at 10 dB intervals.

5dB/D

The grid is displayed at 5 dB intervals.

2dB/D

The grid is displayed at 2 dB intervals.

1dB/D

The grid is displayed at 1 dB intervals.

0.5dB/D

The grid is displayed at 0.5 dB intervals.

0.2dB/D

The grid is displayed at 0.2 dB intervals.

0.1dB/D

The grid is displayed at 0.1 dB intervals.

3.3.5 RESOLUTION Key

3.3.5 RESOLUTION Key

Pressing the **RESOLUTION** key displays the RESOLUTION menu.

The following seven types of resolution can be set. Each resolution can be achieved by changing the slit width in the spectroscope.

<i>0.01nm</i>	The wavelength resolution is set to 0.01 nm.
<i>0.02nm</i>	The wavelength resolution is set to 0.02 nm.
<i>0.05nm</i>	The wavelength resolution is set to 0.05 nm.
<i>0.1nm</i>	The wavelength resolution is set to 0.1 nm.
<i>0.2nm</i>	The wavelength resolution is set to 0.2 nm.
<i>0.5nm</i>	The wavelength resolution is set to 0.5 nm.

3.3.6 SWEEP MODE Key

Pressing the **SWEEP MODE** key displays the SWEEP MODE menu. (Refer to Section 5.1, “Measurement Modes.”)

<i>NORMAL</i>	Selects NORMAL in the sweep mode. This is selected when a normal signal is measured at high speeds.
<i>ADAPTIVE</i>	Selects ADAPTIVE in the sweep mode. Measures signals which require relatively high sensitivity at relatively high speeds. This mode is also used to measure optical signals from pulsing emission in sync with an external signal.
<i>HI-SENS1</i>	Selects HI-SENS1 in the sweep mode. Used to make measurements at high sensitivity.
<i>HI-SENS2</i>	Selects HI-SENS2 in the sweep mode. Used to make measurements at a higher sensitivity than HI-SENSE1.
<i>HI DYNAMIC1</i>	Selects HI DYNAMIC1 in the sweep mode. This is selected when a wide dynamic range must be measured by making the stray light level (of the internal optical system) lower than the ADAPTIVE.
<i>HI DYNAMIC2</i>	Selects HI DYNAMIC2 in the sweep mode. Used to make measurements at a higher sensitivity than HI DYNAMIC1.
<i>PULSE</i>	Selects PULSE in the sweep mode. This is selected when the spectrum in pulse emission status is measured without using an external synchronizing signal. The internal peak hold circuit performs the measurement after GATE TIME has been set.
<i>parameter</i>	Sets the following conditions when ADAPTIVE or PULSE is selected in the sweep mode.
<i>SYNC HI/LOW</i>	The response speed of the internal amplifier is switched when performing pulse synchronizing measurement in accordance with an external synchronizing signal using the GATE MEAS INPUT terminal (be sure to set the sweep mode to ADAPTIVE). HI: The response of the inner amplifier will become faster. Sampling is performed using the timing previously set by DELAY and EDGE RISE/FALL. LOW: The response of the inner amplifier will be returned to the normal speed. Sampling is performed using the HIGH level of an external synchronizing signal.

3.3.6 SWEEP MODE Key

<i>DELAY</i>	If SYNC HI mode is turned on when making an external synchronizing measurement using the GATED MEAS INPUT terminal, sets the sampling timing using the delay time from the edge of the external synchronizing signal.
<i>EDGE RISE/FALL</i>	If SYNC HI mode is turned on when making an external synchronizing measurement using the GATED MEAS INPUT terminal, selects the sampling timing trigger. RISE: The edge of trigger will rise. FALL: The edge of trigger will fall.
<i>GATE TIME</i>	Sets the gate time for measurement when PULSE is selected in the sweep mode.
<i>PREVIOUS MENU</i>	Returns to the previous soft key menu.

3.3.7 AVG Key

Pressing the **AVG** key displays the AVG menu. (Refer to Section 5.2, “Averaging Functions.”)

<i>point average</i>	Average is performed after the data has been measured the specified number of times for each measurement point.
<i>1(OFF)</i>	Turns the average function off.
<i>2</i>	Sets the number of averaging processes to 2.
<i>4</i>	Sets the number of averaging processes to 4.
<i>8</i>	Sets the number of averaging processes to 8.
<i>16</i>	Sets the number of averaging processes to 16.
<i>32</i>	Sets the number of averaging processes to 32.
<i>64</i>	Sets the number of averaging processes to 64.
<i>PREVIOUS MENU</i>	Returns to the previous soft menu.
<i>sweep average</i>	Performs the averaging of the measurement data after the measurements are taken the number of averaging times.
<i>1(OFF)</i>	Turns the average function off.
<i>2</i>	Sets the number of averaging processes to 2.
<i>4</i>	Sets the number of averaging processes to 4.
<i>8</i>	Sets the number of averaging processes to 8.
<i>16</i>	Sets the number of averaging processes to 16.
<i>32</i>	Sets the number of averaging processes to 32.
<i>64</i>	Sets the number of averaging processes to 64.
<i>PREVIOUS MENU</i>	Returns to the previous soft menu.
<i>smoothing</i>	Corrects the measurement data at the specified measurement point using measurement data before and after that point (moving average).
<i>1(OFF)</i>	Turns the smoothing function off.
<i>3</i>	Performs a moving average using three points.
<i>5</i>	Performs a moving average using five points.

3.3.8 AUTO Key

<i>7</i>	Performs a moving average using seven points.
<i>9</i>	Performs a moving average using nine points.
<i>11</i>	Performs a moving average using eleven points.
<i>PREVIOUS MENU</i>	Returns to the previous soft menu.

3.3.8 AUTO Key

Pressing the **AUTO** key displays the AUTO menu.

Automatically sets optimum measurement conditions according to the input signal.

START Executes the AUTO function.

ABORT Terminates the AUTO function.

3.3.9 SINGLE Key

Pressing the **SINGLE** key allows one measurement operation to be performed. The LED on the **SINGLE** key lights up during measurement. When the measurement is completed, the LED turns off.

Pressing the **SINGLE** key during measurement causes the current measurement to be interrupted and starts a new measurement.

3.3.10 REPEAT Key

Pressing the **REPEAT** key causes the measurement operation to be performed repeatedly. During repeat measurements, the LED on the **REPEAT** key lights up until the **SINGLE** key or the **STOP** key is pressed. Pressing the **REPEAT** key during measurement causes the current measurement to be interrupted and starts a set of new repeated measurements.

3.3.11 STOP Key

Pressing the **STOP** key causes the measurement operation to be stopped. The measurement operation is stopped immediately after the **STOP** key is pressed. The LED on the **SINGLE** key or the LED on the **STOP** key turns off. When pressing the **STOP** key to stop measurement, the data displayed at that time will be retained as is.

3.3.12 NORMALIZE LOSS/TRANS Key

Pressing the **NORMALIZE LOSS/TRANS** key displays the **NORMALIZE** menu. (Refer to Section 5.9, "Auto-Panning and Auto-Zooming Functions").

PEAK NORMALIZE Selects the mode for normalizing the measurement data at the maximum value.

LOSS Selects the mode for calculating and displaying the loss characteristics.
Normalizes the measurement data to the reference data saved in the memory using the same (and corresponding) wavelengths between the current spectrum and the spectrum data saved to memory.

NOTE: LINEAR display is impossible under this mode.

TRANS Selects the mode for calculating and displaying the transparency characteristics.
Normalizes the measurement data to the reference data saved in the memory using the same (and corresponding) wavelengths between the current spectrum and the spectrum data saved to memory.

CUR+MEAS1→CURRENT CURRENT results in the sum of the current waveform and Memory MEAS1 data.

CUR-MEAS1→CURRENT CURRENT results in the remainder by removing Memory MEAS1 data from the current waveform.

SAVE REF DATA Saves the current measurement data as reference data in memory.

SAVE MEAS 1 Saves the current measurement data in memory MEAS1.

3.3.13 APPLICATION Key

3.3.13 APPLICATION Key

Pressing the **APPLICATION** key displays the APPLICATION menu.

NOTE: Parameters marked with (#) commonly apply to the all APPLICATION menu functions.

<i>spectral width</i>	Selects the function for calculating the pulse duration. Refer to Section 5.3.1, “Calculating the Spectral Width.”
PEAK-THRESHOLD	Selects the mode for calculating the pulse duration to the maximum value or noise level according to the threshold method.
ENVELOPE	Selects the mode for calculating the pulse duration according to the envelope method.
RMS	Selects the mode for calculating the pulse duration according to the RMS method.
PEAK RMS	Selects the mode for calculating the pulse duration according to the peak RMS method.
Xnm LEVEL	Selects the mode for calculating the ratio of the peak level to the level of a wavelength separated by a specified wavelength width as centered approximately the maximum value wavelength.
<i>parameter</i>	Displays the operation parameter menu related to spectral widths.
THRESHOLD LVL1(dB) (#)	Sets the level threshold used in the PEAK THRESHOLD or ENVELOPE method. (The initial value is 3dB.)
THRESHOLD LVL2(dB) (#)	Sets the threshold level from the maximum peak used by the peak RMS method. Peaks that are higher than or equal to the threshold level are used for calculations. (The initial value is 20dB.)
K	Sets the coefficient multiplied to the calculated pulse duration. (The initial value is 1.0.)
Kr(RMS)	Sets the coefficient multiplied to the pulse duration calculated by the RMS method or the PEAK RMS method. (The initial value is 2.3548.)
WIDTH	Sets the width for calculating the level ratio in the Xnm-LEVEL calculation.
PREVIOUS MENU	Returns to the previous soft key menu.

<i>OFF</i>	Turns the half band width calculation function off.
<i>notch width</i>	Selects the notch width calculation function. Refer to Section 5.3.2, "Notch Width."
<i>XdB WIDTH</i>	Calculates the notch width at the user-set threshold level.
<i>Xnm LEVEL</i>	Calculates the threshold level matched to the user-set notch width.
<i>parameter</i>	Displays the operation parameter menu related to notch width.
<i>LEVEL</i>	Sets the level ratio.
<i>WIDTH</i>	Sets the wavelength width.
<i>PREVIOUS MENU</i>	Returns to the previous soft key menu.
<i>OFF</i>	Turns the notch width calculation function off.
<i>opt.amp</i>	Changes to the menu for calculating the gain/noise index of the EDFA. For information on how to operate this function, refer to Section 5.4, "GAIN&NF and SNR."
<i>MODE SNG/WDM</i>	Switches between single wave and wavelength multiplexing in the calculation result display mode. SNG: To calculate a single signal. WDM: To calculate a WDM signal.
<i>parameter</i>	Switches the current menu to the menu for setting the calculation parameter.
↓	Moves the setting parameter downward by one position.
↑	Moves the setting parameter upward by one position.
←	Moves the setting parameter to the left by one position.
→	Moves the setting parameter to the right by one position.
<i>NEXT PAGE</i>	Displays the next page of the calculation parameter setting window.
<i>PREVIOUS PAGE</i>	Displays the previous page of the calculation parameter setting window.
<i>CLOSE</i>	Closes the window for setting the calculation parameter.

3.3.13 APPLICATION Key

<i>NF Select</i>	Sets whether only the term of the beat noise between the signal light and spontaneous emission light (s-sp) is used, or four terms (total) consisting of the beat noise between the signal light and spontaneous emission light, the beat noise between spontaneous emission lights, the shot noise of signal light, and the shot noise of spontaneous emission light are used when calculating the noise figure.
<i>WDM ASE Method (#)</i>	Sets whether or not to automatically calculate ASE when set to WDM mode.
<i>ASE Fitting (#)</i>	Controls whether the Gaussian fitting is used, the measured data stored in memory MEAS3 is used, or data is manually entered to calculate the ASE level When “WDM ASE METHOD” is set to “AUTO OFF.”
<i>Masked Span (#)</i>	Sets the width to be masked around the center of the signal light in the fitting process.
<i>Fitting Span (#)</i>	Sets the target wavelength used in the fitting process when calculating the ASE level.
<i>Method (#)</i>	Sets whether or not SPE DIV Mode is turned on. SPE DIV Mode cancels errors caused by stray light, input signal’s amplified spontaneous emission, side mode, and so on.
<i>Filter $\Delta\lambda$</i>	Sets the effective optical filtering width of the optical amplifier output which is used for the noise figure calculation when NF SELECT is set to total. When set to 0, the NF is calculated including the terms “Beat noise between the optical signal and the spontaneous emission” and “Optical signal shot noise.”
<i>Manual ASE Level (#)</i>	Sets the ASE level when ASE Fitting is set to Manual Mode.
<i>Threshold Level (#)</i>	Sets the threshold level from the maximum peak. Peaks that are higher than or equal to the threshold level are used for calculations.
<i>Peak Excursion (#)</i>	Sets the amplitude conditions (dB) that are required for the signal peak recognition.
<i>NF K</i>	Sets the coefficient for the noise figure calculated. This parameter is used when the correction is required other than input/output loss.
<i>Pin Loss</i>	Sets the differences between the optical signal level input into the instrument and the optical signal level actually input into the optical amplifier.

<i>Pout Loss</i>	Sets the differences between the output optical signal level of the optical amplifier input into the instrument and the optical signal level actually output from the optical amplifier.
<i>NEXT PAGE</i>	Moves the signal list display in WDM to the next page.
<i>PREVIOUS PAGE</i>	Moves the signal list display in WDM to the previous page.
<i>SAVE Pin→REF DATA</i>	Saves an optical amplifier input signal waveform in the reference memory.
<i>SAVE MEAS 3</i>	Saves the waveform data in memory MEAS3.
<i>OFF</i>	Exits from the optical amplifier analysis mode.
<i>wdm</i>	Selects the WDM analysis mode.
<i>MULTI PEAK</i>	Selects MULTI PEAK in the list display mode.
<i>SNR</i>	Selects SNR in the list display mode. For information on how to operate this function, refer to Section 5.4, "GAIN&NF and SNR."
<i>RELATIVE</i>	Selects RELATIVE in the list display mode.
<i>ITU GRID</i>	Selects ITU-GRID in the list display mode.
<i>parameter</i>	Switches the current menu to the menu for setting the calculation parameter.
↓	Moves the setting parameter downward by one position.
↑	Moves the setting parameter upward by one position.
←	Moves the setting parameter to the left by one position.
→	Moves the setting parameter to the right by one position.
<i>CLOSE</i>	Closes the window for setting the calculation parameter.
<i>WDM ASE Method (#)</i>	Sets whether or not an ASE interpolation is automatically performed.
<i>ASE Fitting (#)</i>	Controls whether the Gaussian fitting is used, the measured data stored in memory MEAS3 is used, or data is manually entered to calculate the ASE level. When "WDM ASE METHOD" is set to "AUTO OFF."
<i>Masked Span (#)</i>	Sets the width to be masked around the center of the signal light in the fitting process.

3.3.13 APPLICATION Key

Fitting Span (#) Sets the target wavelength used in the fitting process when calculating the ASE level.

Threshold Level (#) Sets the threshold level by the maximum peak. The optical signal peaks that are higher than or equal to the threshold level are used for calculations.

Peak Excursion (#) Sets the amplitude conditions (dB) that are required for the signal peak recognition.

ASE NBW (#) A parameter used to calculate the amplified spontaneous emission level (Pase) when the list display mode is set to SNR.
(NBW:Noise acquisition Band Width)

Current: The measurement spectrum is used as the amplified spontaneous emission level (Pase).

Conversion:

The amplified spontaneous emission level is calculated by assigning an arbitrary wavelength resolution to the expression shown below.

$$\text{Pase (Calculated)} = \text{Pase (Measurement value)} \times \text{Res (Set resolution of "ASE Converted NBW")}/\text{Res (Current measurement wavelength resolution)}$$

ASE Converted NBW (#)

Sets the wavelength resolution used to calculate Pase when the ASE NBW is set to Conversion.

Manual ASE Level (#)

Sets the ASE level when ASE Fitting is set to Manual Mode.

GRID Ref Frequency (#)

Sets the reference frequency of the WDM-signal nominal frequency when the list display mode is set to ITU GRID.

GRID CH Spacing (#)

Sets the channel spacing frequency of the WDM-signal nominal frequency when the list display mode is set to ITU GRID.

Signal Power Mode

This parameter is used to select a calculation method for SNR when SNR is selected in the list display mode. For more information on the calculation method, refer to Section 5.4, "GAIN&NF and SNR."

Peak: SNR is calculated from the signal peak.

ΣPower: SNR is calculated from the total power within a Masked Span setting range.

LIST ALL ON/OFF

When this is set to ON, up to 24 signals can be displayed on the screen simultaneously.

REFERENCE	Sets the reference CH No. in the list. The signal assigned to the reference CH is indicated with an inverted triangle ▽ on the spectrum screen.
OFF	Exits from the WDM analysis mode.
<i>wdm monitor</i>	
DISPLAY MONI/SPEC	Toggles the display mode (in the upper display area) between the Monitor graph and Spectrum.
GRAPH X TIME/CH	Toggles the monitor graph X-axis between the time and channel.
TBL CONT TIME/CH	Changes scrolling and CURRENT in the data table in combination with the CURRENT SELECT key. For more information, refer to Table 3-2.
<i>data mode</i>	
λ,f	The table and graph can be displayed in the wavelength (frequency) mode.
LEVEL	The table and graph can be displayed in the level mode.
SNR	The table and graph can be displayed in the SNR mode. For information on how to operate this function, refer to Section 5.4, "GAIN&NF and SNR."
SCALE	Switches the monitor graph Y-axis scale. When the data mode is set to λ,f, the SCALE key function is restricted when using GRAPH X and absolute/relative mode settings (refer to Table 3-1).

Table 3-1 The Scale Change of the λ,f Mode

		GRAPH X	
		TIME	CH
absolute/ relative	ABSOLUTE	Fixed with the current measuring span	Fixed with the current measuring span
	INITIAL	Scale is changeable	Fixed with the measuring span between 0 and +.
	NOMINAL	Scale is changeable	Scale is changeable

PREVIOUS MENU

Returns to the previous menu.

3.3.13 APPLICATION Key

<i>absolute/relative</i>	Changes to the display mode for the table and graph displays.
ABSOLUTE	The table and graph can be displayed using absolute values.
INITIAL	The table and graph can be displayed including variations from the initial values. (When the X-axis is set to TIME, the first measurement value of each channel is set as the initial value.) (When the X-axis is set to CH, the first channel measurement value at each specified time is set as the initial value.)
NOMINAL	The table and graph are displayed using the differences from the target values. When the Data mode is set to λ .f, the frequency specified by GRID Ref Frequency and GRID CH Spacing is used as the target value. When the Data mode is set to LEVEL, the Nominal Level value set is used as the target value. When the Data mode is set to SNR, the Nominal SNR value set is used as the target value.
PREVIOUS MENU	Returns to the previous menu.
<i>parameter</i>	Switches to the desired operation parameter menu.
↓	Shifts the parameter downwards by one position.
↑	Shifts the parameter upwards by one position.
←	Shifts the parameter to the left by one position.
→	Shifts the parameter to the right by one position.
NEXT PAGE	Displays the next page of the calculation parameter setting window.
PREVIOUS PAGE	Displays the previous page of the calculation parameter setting window.
CLOSE	Closes the menu used to set operation parameters.
Time Interval	Sets the measurement time interval.
Measurement Times	Sets the number of times the measurement is repeated.
Graph All Data	Selects whether only the currently selected data or all data is to be displayed in the graph display. ON: Displays all data. The currently selected data is displayed in yellow and the rest is displayed in green.

OFF: Displays only the currently selected data in yellow.

Threshold Level (#)

Sets the threshold level by the maximum peak level. peaks that are higher than or equal to the threshold level are used for calculations.

Peak Excursion (#)

Sets the amplitude conditions (dB) that are required for the signal peak recognition.

Pass/Fail Enable

Sets whether or not a Pass/Fail judgment is made. If the value is judged Fail since it has exceeded the limit, the number in the table is intensified.

GRID Ref Frequency (#)

Sets the reference frequency of a WDM signal.

GRID CII Spacing (#)

Sets the reference frequency of a WDM signal.

Nominal Level

Sets the target signal level for each channel of a WDM signal.

Level Upper Lmt

Sets the upper limit for each signal level when making a Pass/Fail judgment.

Level Lower Lmt

Sets the lower limit for each signal level when making a Pass/Fail judgment.

λ Drift Lmt

Sets the upper limit of the wavelength drift for each channel when making a Pass/Fail judgment.

Nominal SNR

Sets the target SNR for each channel of a WDM signal.

ASE Fitting (#)

Sets how the ASE level is entered when WDM ASE METHOD is set to AUTO OFF: entering the ASE level after it has been calculated using the Gaussian fitting, entering the data saved in memory MEAS3 for the ASE level, or entering data manually for the ASE level.

Masked Span (#)

Sets a span that is masked around the center of the optical signal and removed from the fitting process.

Fitting span (#)

Sets a wavelength width for the fitting process when calculating the ASE level.

Manual ASE Level (#)

Sets the ASE level when ASE FITTING is set to Manual Mode.

SNR Lower Lmt

Sets the lower limit for each SNR when making a Pass/Fail judgment.

3.3.13 APPLICATION Key

WDM ASE Method (#)

Sets whether or not an interpolation for the ASE is automatically performed.

ASE NBW (#)

A parameter used to calculate the amplified spontaneous emission level (Pase) when the contents of the data table is SNR. (NBW:Noise acquisition Band Width)

Current: The measurement spectrum is used as the amplified spontaneous emission level (Pase).

Conversion:

The amplified spontaneous emission level is calculated by assigning an arbitrary wavelength resolution to the expression shown below.

$Pase \text{ (Calculated)} = Pase \text{ (Measurement value)} \times Res \text{ (Set resolution of "ASE Converted NBW")}/Res \text{ (Current measurement wavelength resolution)}$

ASE Converted NBW (#)

Sets the wavelength resolution used to calculate Pase when the ASE NBW is set to Conversion.

CURRENT SELECT

Changes scrolling and CURRENT in the data table in combination with the **TBL CONT** key.

Table 3-2 Changing the Table Data Display and the Current Time or Channel

		TBL CONT	
		TIME	CH
CURRENT SELECT	ON	Changes the current time.	Changes the current channels.
	OFF	Scrolls the table data along the time axis.	Scrolls the table data along the channel axis.

The expressions CURRENT TIME and CURRENT CH refer to the data displayed in the upper display area (When Graph All Data is selected, the color of the current waveform is different from the other waveform colors.).

If the X-axis represents the time, the channel data specified by CURRENT CH is displayed as a monitor graph along the time axis.

If the X-axis represents the channel, the data specified at CURRENT TIME is displayed as a monitor graph along the channel axis.

OFF

Turns WDM MONITOR off.

<i>device</i>	Displays the selection menu for the filter characteristic analysis function, LD spectrum analysis function, and LED spectrum analysis function.
<i>o-bpf</i>	Selects the Optical BPF mode. For more information on the calculation, refer to Section 5.5, "Optical BPF Analysis."
<i>parameter</i>	Switches the current menu to the menu for setting the calculation parameter.
↓	Moves the setting parameter downward by one position.
↑	Moves the setting parameter upward by one position.
←	Moves the setting parameter to the left by one position.
→	Moves the setting parameter to the right by one position.
CLOSE	Closes the Calculation Parameter Setting window.
Pass Band Threshold	Sets the threshold level for Pass Band.
Half Band Threshold	Sets the threshold level for Half Band.
Stop Band Threshold	Sets the threshold level for Stop Band.
Ripple Select	Selects the calculation method for ripple.
max-min:	Calculates using the maximum value and the minimum value in passband.
ripple:	Calculates using a maxima and the minima in Pass Band.
search area:	Calculates using the maximum value and minimum value within the analyzed range in passband.
GRID Ref Frequency (#)	Sets the reference frequency for the GRID.
GRID CH Spacing (#)	Sets the frequency span of the GRID.
Search Area Pass	Sets the calculation wavelength range in the passband for the filter waveform when calculating the Isolation.

3.3.13 APPLICATION Key

Search Area Stop

Sets the calculation wavelength range in the stopband for the filter waveform when calculating Isolation.

Std Wavelength

Selects how the standard (Reference) wavelength is defined in the passband when calculating Isolation.

peak:

Sets the standard wavelength to the maximum peak wavelength.

pass_center:

Sets the standard wavelength to the Pass Band center wavelength of the filter waveform.

half_center:

Sets the standard wavelength to the Half Band center wavelength of the filter waveform.

GRID:

Sets the standard wavelength to the GRID which is closest to the peak wavelength.

Isolation Pass

Selects what level in the analyzing range of the passband set by Search Area Pass is used to calculate Isolation.

max: Calculates using the maximum level value within the analysis range.

min: Calculates using the minimum level value within the analysis range.

avg: Calculates using the average level value within the analysis range.

Isolation Stop

Selects what level in the analyzing range of the stopband set by Search Area Stop is used to calculate Isolation.

max: Calculates using the maximum level value within the analysis range.

min: Calculates using the minimum level value within the analysis range.

avg: Calculates using the average level value within the analysis range.

NEXT PAGE Displays the next page of the analysis result list.

PREVIOUS PAGE Displays the previous page of the analysis result list.

OFF Quits the Optical BPF analysis mode.

<i>filter tilt</i>	Selects the Filter Tilt analysis mode. For more information on the calculation, refer to Section 5.6, "Tilt Calculation Function."
<i>parameter</i>	Switches the current menu to the menu for setting the calculation parameter.
↓	Moves the setting parameter downward by one position.
↑	Moves the setting parameter upward by one position.
←	Moves the setting parameter to the left by one position.
→	Moves the setting parameter to the right by one position.
CLOSE	Closes the window for setting the calculation parameter.
Start Wavelength	Sets the start wavelength for the fitting process.
Stop Wavelength	Sets the stop wavelength for the fitting process.
OFF	Quits the Filter Tilt analysis mode.
<i>dfb-ld</i>	Selects the DFB-LD analysis mode. For more information on the calculation, refer to Section 5.7, "LD Performance Analysis."
<i>parameter</i>	Switches the current menu to the menu for setting the calculation parameter.
↓	Moves the setting parameter downward by one position.
↑	Moves the setting parameter upward by one position.
←	Moves the setting parameter to the left by one position.
→	Moves the setting parameter to the right by one position.
CLOSE	Closes the window for setting the calculation parameter.
Threshold Level 1 (#)	Sets the threshold level used when calculating spectrum width.
Peak Excursion (#)	Sets the amplitude condition (dB) that is required for signal peak recognition.
OFF	Quits the DFB-LD analysis mode.
<i>fp-ld</i>	Selects the FP-LD analysis mode. For more information on the calculation, refer to Section 5.7, "LD Performance Analysis."

3.3.13 APPLICATION Key

	<i>parameter</i>	Switches the current menu to the menu for setting the calculation parameter.
	↓	Moves the setting parameter downward by one position.
	↑	Moves the setting parameter upward by one position.
	←	Moves the setting parameter to the left by one position.
	→	Moves the setting parameter to the right by one position.
	CLOSE	Closes the window for setting the calculation parameter.
	Threshold Level 2 (#)	Sets the threshold level from the maximum peak level. Peaks that are higher than or equal to the threshold level are used for calculations.
	OFF	Quits the FP-LD analysis mode.
<i>led</i>		Selects the FP-LD analysis mode. For more information on the calculation, refer to Section 5.7, "LD Performance Analysis."
	OFF	Quits the LED analysis mode.
<i>acpr</i>		Selects the ACPR analysis mode. For more information on the calculation, refer to Section 5.8, "ACPR (Adjacent Channel Leakage Power Ratio)."
	<i>parameter</i>	Switches the current menu to the menu for setting the calculation parameter.
	↓	Moves the setting parameter downward by one position.
	↑	Moves the setting parameter upward by one position.
	←	Moves the setting parameter to the left by one position.
	→	Moves the setting parameter to the right by one position.
	CLOSE	Closes the window for setting the calculation parameter.
	GRID Ref Frequency (#)	Sets the reference frequency for the GRID.
	GRID CII Spacing (#)	Sets the frequency span of the GRID.
	OFF	Quits the ACPR analysis mode.

3.3.14 ADVANCE Key

Pressing the **ADVANCE** key displays the **ADVANCE** menu.

<i>peak power-mon</i>	Selects the peak power monitor function.
<i>SAMPLING POINT</i>	Sets the maximum measuring numbers in SINGLE measurement.
<i>INTERVAL TIME</i>	Sets the time interval for measuring.
<i>OFF</i>	Exits from the peak power monitor function.
<i>limit line</i>	Selects a function from the limit line function.
<i>pattern select</i>	Switches to the Pattern File Selection menu for the limit line to be loaded.
<i>PATTERN1</i>	Loads data from the PATTERN1 file as the limit line.
<i>PATTERN2</i>	Loads data from the PATTERN2 file as the limit line.
<i>PATTERN3</i>	Loads data from the PATTERN3 file as the limit line.
<i>PATTERN4</i>	Loads data from the PATTERN4 file as the limit line.
<i>PATTERN5</i>	Loads data from the PATTERN5 file as the limit line.
<i>PREVIOUS MENU</i>	Returns to the previous menu.
<i>shift X/Y</i>	Switches to the Shift Volume Setting menu for the limit line along the X or Y-axis.
<i>SHIFT X</i>	Sets the shift volume of a limit line along the X-axis.
<i>SHIFT Y</i>	Sets the shift volume for a limit line along the Y-axis.
<i>PREVIOUS MENU</i>	Returns to the previous menu.
<i>SHOW PARAM ON/OFF</i>	Switches the display function for the list of loaded pattern file parameters to on or off.
<i>LOAD PATTERN FILES</i>	Loads the limit line pattern file from a floppy disk. For information how to create the pattern file, refer to Section 5.11, "Setting Limit Line" in the technical notes.
<i>PASS/FAIL</i>	Makes a Pass/Fail judgment.
<i>AUTO PASS/FAIL ON/OFF</i>	Switches the repetitive execution function for PASS/FAIL to on or off.

3.3.15 ON/OFF Key

OFF Exits from the limit line function.

3.3.15 ON/OFF Key

Pressing the **ON/OFF** key (in the **CURSOR** section) displays the **CURSOR** menu.

The selection of cursor displays and display formats for cursor data can be performed. (Refer to 5.10 Cursor Modes and Explanation for Displayed Data.)

NORMAL	Sets the cursor call mode to the NORMAL .
ΔMODE	Sets the cursor call mode to the ΔMODE .
2ND PEAK	Sets the cursor call mode to 2ND PEAK . X cursor 1 moves to the highest peak and X Cursor 2 moves to the second highest peak.
POWER	Sets the cursor call mode to POWER . Displays the total power of the signal section between the two X Cursors.
PEAK TO PEAK	Sets the cursor call mode to PEAK TO PEAK . One X Cursor moves to the maximum level, and the other X Cursor moves to the minimum level.
LEFT PEAK	Moves X Cursor 2 over the next peak on the left side. In addition, if Y Cursor 2 is displayed, only the peaks whose levels are above the Y Cursor 2 level are targeted.
RIGHT PEAK	Moves X Cursor 2 over the next peak on the right side. In addition, if Y Cursor 2 is displayed, only the peaks whose levels are above the Y Cursor 2 level are targeted.

3.3.16 λ1 Key

Pressing the **λ1** key displays the first cursor perpendicular to the wavelength axis. Pressing the **λ1** key again erases the cursor.

3.3.17 λ2 Key

Pressing the **λ2** key displays the second cursor perpendicular to the wavelength axis. Pressing the **λ2** key again erases the cursor.

3.3.18 L1 Key

Pressing the **L1** key displays the first cursor horizontal to the wavelength axis. Pressing the **L1** key again erases the cursor.

3.3.19 L2 Key

Pressing the **L2** key displays the second cursor horizontal to the wavelength axis. Pressing the **L2** key again erases the cursor.

3.3.20 CONTROL Key

Pressing the **CONTROL** key displays the CONTROL menu.

<i>DUAL ON/OFF</i>	Toggles the dual screen display function for the upper and the lower screens on or off. ON: Displays the dual upper and lower screens. OFF: Displays only one screen.
<i>S.IMPOSE ON/OFF</i>	Toggles the function for superimposing display on or off. ON: Displays by superimposing. OFF: Turns the function for superimposing display off.
<i>multi trace</i>	Turns the multi-trace function on. The current trace is saved as No. 1. The color of the current trace is displayed in yellow. The colors of the traces other than the current trace are displayed in the order of green, blue, sky blue and red.
<i>TRACE MAX</i>	Sets the maximum trace number (1 to 32).
<i>NEXT</i>	The current trace is shifted to the next number.
<i>PREV</i>	The current trace is shifted to the previous number.
<i>AUTO TRAC ON/OFF</i>	Toggles the auto-trace function on or off. When the auto-trace function is turned on, the current trace number is automatically incremented for each sweep.
<i>DELETE CURRENT</i>	Deletes the current trace.
<i>DELETE ALL</i>	Deletes all traces.
<i>OFF</i>	Turns the multi-trace function off. Only the current trace is left undeleted.
<i>GRID ON/OFF</i>	Toggles the grid display function on or off. Displays and erases the grid lines within the data display frame.
<i>ACT U&L ON/OFF</i>	Toggles the function used to update the upper and lower screens (for each measurement in the dual screen mode) on or off. ON: The upper and lower screens are updated for each measurement. OFF: Only the upper screen is updated.

3.3.20 CONTROL Key

<i>X-CHANGE UPR/LOW</i>	Exchanges between the upper and lower screens only in Dual Screen Mode.
<i>sampling point</i>	Sets the sampling point within the wavelength range.
<i>101</i>	Sets the sampling point within the wavelength range to 101 points.
<i>201</i>	Sets the sampling point within the wavelength range to 201 points.
<i>501</i>	Sets the sampling point within the wavelength range to 501 points.
<i>1001</i>	Sets the sampling point within the wavelength range to 1001 points.
<i>2001</i>	Sets the sampling point within the wavelength range to 2001 points.
<i>5001</i>	Sets the sampling point within the wavelength range to 5001 points.
<i>10001</i>	Sets the sampling point within the wavelength range to 10001 points.
<i>AUTO ON/OFF</i>	Toggles the auto-sampling point function on or off. ON: Automatically sets the sampling points according to the span and resolution. The character "A" is affixed to the screen annotation for the number of sampling points. OFF: Turns the auto-sampling point function off.

3.3.21 SAVE Key

Pressing the **SAVE** key displays the SAVE menu. (Refer to Section 2.3.4, " Saving or Reading Data.")

SAVE REF DATA	Stores the current measurement data into memory as reference data. The reference data is used with NORMALIZE LOSS/TRANS . In addition, the reference data is used as the optical amplifier input signal spectrum in the opt amp function (used to calculate the gain and NF of an optical amplifier).
SAVE MEAS 1	Saves the current measurement data into memory MEAS1. However, the data created using the Peak Normalized, Peak Power Monitor, Loss or Trans function cannot be saved.
SAVE MEAS 2	Saves the current measurement data into memory MEAS2.
SAVE MEAS 3	Saves the current measurement data into memory MEAS3. This trace data is used as a fitting function when ASE fitting is set to MEAS3.
save meas data	Moves to the save menu for the measurement data.
SAVE	Saves the current measurement data in the file name selected.
DELETE	Deletes the file selected.
RECOVER	Recovers the file deleted just before recovering.
name	Moves to the menu that inputs the file name.
←	Moves the input cursor to the left by one character.
→	Moves the input cursor to the right by one character.
NAME CLEAR	Clears the input memory name (file name).
ENTER	Selects characters from the character menu.
PREVIOUS MENU	Returns to the previous soft key menu.
EXIT	Returns to the waveform display mode.
SAVE MEM/FDD	Switch the media for saving the data between memory and FDD. MEM: Saves the data in the internal memory. FDD: Saves the data to the floppy disk drive.

3.3.22 RECALL Key

3.3.22 RECALL Key

Pressing the **RECALL** key displays the RECALL menu.

<i>RECALL REF DATA</i>	Recalls data from the reference data memory.
<i>RECALL MEAS 1</i>	Recalls data from memory MEAS1.
<i>RECALL MEAS 2</i>	Recalls data from memory MEAS2.
<i>RECALL MEAS 3</i>	Recalls data from memory MEAS3.
<i>recall meas data</i>	Moves to the recall menu for the measurement data.
<i>RECALL</i>	Recalls from the selected file.
<i>EXIT</i>	Returns to the waveform display mode.
<i>RECALL MEM/FDD</i>	Switch the media for recalling data between memory and FDD. MEM: Data is loaded from internal memory. FDD: Data is loaded from the floppy disk drive.

3.3.23 DEVICE Key

Pressing the **DEVICE** key displays the **DEVICE** menu.

<i>select output</i>	Selects the output device.
INTERNAL PRINTER	Selects the internal thermal printer as the output device.
EXTERNAL PRINTER	Selects the external printer as the output device.
FLOPPY DISK	Selects the floppy disk as the output device.
PREVIOUS MENU	Returns to the previous soft key menu.
<i>printer</i>	Sets the printer parameter.
MENU OUT ON/OFF	Toggles the soft key menu on (to output) or off (not to output).
	ON: Outputs the soft key menu on the right side of the screen when the printer is outputting.
	OFF: Does not output the soft key menu.
<i>external printer</i>	Sets the parameter for external printer output.
MODE:GRAY	Prints in 4 gradations.
MODE:MONO S	Prints in 2 gradations of white and black in small size.
MODE:MONO L	Prints in 2 gradations of white and black in large size.
COMMAND:ESC/P	Outputs according to ESC/P.
COMMAND:HP PCL	Outputs according to HP PCL.
COMMAND:ESC/P RAS	Outputs according to ESC/P RAS.
PREVIOUS MENU	Returns to the previous soft key menu.
PREVIOUS MENU	Returns to the previous soft key menu.
<i>floppy</i>	Sets the parameter for outputting data to the floppy disk.
DIRECTORY	Used to display the directory information of all the files in the floppy disk.
<i>format</i>	Sets the format parameter.
EXECUTE	Executes the format.

3.3.23 DEVICE Key

	2DD(720K)	Selects format capacity 2DD-720K.
	2HD(1.44M)	Selects format capacity 2HD-1.44M.
	PREVIOUS MENU	Returns to the previous soft key menu.
bit map		Records the display screen using the bitmap.
	MODE:MONO	Records in 2 gradation of white and lack.
	MODE:GRAY	Records in gray scale.
	MODE:COLOR	Records in 256 colors.
	COMPRESS ON/OFF	Toggles the compression function of the bitmap on or off.
	PREVIOUS MENU	Returns to the previous soft key menu.
	PREVIOUS MENU	Returns to the previous soft key menu.
color		Selects the color pattern.
	PATTERN-1	Selects color pattern 1.
	PATTERN-2	Selects color pattern 2.
	PATTERN-3	Selects color pattern 3.
	PATTERN-4	Selects color pattern 4.
	PATTERN-5	Selects color pattern 5.
	PREVIOUS MENU	Returns to the previous soft key menu.
	EXT KEY US/JP	Toggles the keyboard between the US layout (104) and the Japanese layout (109).
clock		Sets the real time clock. (Refer to Section 2.3.3, "Setting Date/Time.")
	DISPLAY ON/OFF	Toggles on (to display) or off (not to display) the date display. ON: Displays the date. OFF: Does not display the date.
	YEAR	Sets the year.
	MONTH	Sets the month.

DAY	Sets the day.
HOUR	Sets the hour.
MINUTE	Sets the minute. At the same time it sets the seconds to 00.
PREVIOUS MENU	Returns to the previous soft key menu.
buzzer	Sets the conditions for sounding the buzzer. Buzzer sounds include two types: one sound that is activated when the panel keys are pressed and another sound that is activated when measurement conditions, etc. are set illegally.
BEEP ON/OFF	Sets whether to beep when the panel keys are pressed. ON: Beeps when the panel keys are pressed. OFF: Does not beep when the panel keys are pressed.
WARNING ON/OFF	Sets whether the warning buzzer is sounded or not when error occurs. ON: Sounds the warning buzzer when error occurs. OFF: Does not sound the warning buzzer when error occurs.
QUIET ON/OFF	Toggles on or off the function of decreasing buzzer sound volume. ON: Decreases the sound volume of the buzzer. OFF: Does not control the sound volume of the buzzer.
PREVIOUS MENU	Returns to the previous soft key menu.

3.3.24 COPY Key

3.3.24 COPY Key

Pressing the **COPY** key outputs the data to be copied to the output device set by Select Output. (Refer to Section 2.3.5, "Outputting Data (Hard Copy).")

3.3.25 FEED Key

Pressing the **FEED** key performs paper feed in the internal printer.

3.3.26 LOCAL Key

<i>HEADER ON/OFF</i>	Turns ON (to add)/OFF (not to add) the header when outputting the GP-IB data. ON: Adds the header when outputting data. OFF: Does not add the header when outputting data.
<i>ADDRESS UP</i>	Increments the GPIB address by 1.
<i>ADDRESS DOWN</i>	Decrements the GPIB address by 1.

3.3.27 INSTR PRESET Key

<i>PRESET</i>	Sets the panel setting conditions to the initial setting status.
<i>SELF TEST</i>	Conducts a self test and displays the results after approximately 90 seconds.

3.3.28 CAL Key

(Refer to Section 2.2.4, "Alignment" and Section 2.2.5, "Calibration.")

<i>CAL λ (Int.)</i>	Calibrates the wavelength using the optional self-contained light source.
<i>CAL λ (Ext.)</i>	Calibrates the wavelength using the external laser light source as the calibration light source.
<i>EXECUTE</i>	Executes the calibration operation.
<i>λ OFFSET</i>	Inputs the offset value of the wavelength.
<i>LEVEL OFFSET</i>	Inputs the offset value of the level.
<i>RECALL OFFSET ON/OFF</i>	Toggles the function used to load wavelength and level offset data (before a data file or panel information is loaded) on or off. ON: Recalls the offset parameter. OFF: Does not recall the offset parameter.

NOTE: When the offset data is not enabled, please input 0 to the λ offset and the LEVEL OFFSET.

AUTO ALIGNMENT This function adjusts the optical axis of the monochromator used with the optical spectrum analyzer.

CAUTION: Prior to operating this instrument immediately after having transported it with fierce vibrations, or operating this instrument in a place having abrupt temperature changes, be sure to warm up the instrument and then perform the AUTO ALIGNMENT function in advance.

3.3.29 LABEL Key

3.3.29 LABEL Key

(Refer to Section 2.3.1, “Entering Label Data.”)

←	Moves the input cursor in the label to the left by one character.
→	Moves the input cursor in the label to the right by one character.
<i>DELETE CHAR</i>	Deletes a character at the input cursor position.
<i>INSERT SPACE</i>	Inserts a space at the input cursor position.
<i>CLEAR LINE</i>	Clears all data in the label input buffer.
<i>ENTER</i>	Sets the input character selected by the character menu.
<i>UNDO</i>	Recovers the label data to the status before the LABEL key is pressed.

3.4 List of Settings

3.4.1 Defaults Configuration Values

The center wavelength and span wavelength along the horizontal axis are calculated into the center frequency and span frequency, respectively.

Table 3-3 Default Settings (1 of 6)

Item	Default	Minimum value	Maximum value	Setting resolution	Backup	File save
Center wavelength (nm)	1150	600	1700	0.001	<input type="radio"/>	<input type="radio"/>
Span wavelength (nm)	1100	0.2	1100	0.1	<input type="radio"/>	<input type="radio"/>
Auto peak center	OFF	-	-	-	<input type="radio"/>	<input type="radio"/>
Spectral horizontal axis	nm	-	-	-	<input type="radio"/>	<input type="radio"/>
Reference level (dBm)	0	-90	30	0.1	<input type="radio"/>	<input type="radio"/>
Reference level (LIN)	1mW	1pW	1000mW	0.1	<input type="radio"/>	<input type="radio"/>
Minimum hold	OFF	-	-	-	<input type="radio"/>	<input type="radio"/>
Maximum hold	OFF	-	-	-	<input type="radio"/>	<input type="radio"/>
Reference auto	OFF	-	-	-	<input type="radio"/>	<input type="radio"/>
LIN/LOG	LOG	-	-	-	<input type="radio"/>	<input type="radio"/>
Level scale	10dB/DIV	0.1	10	0.1	<input type="radio"/>	<input type="radio"/>
AUTO measurement	OFF	-	-	-	<input checked="" type="radio"/>	<input checked="" type="radio"/>
Point average	OFF	1	64	1	<input type="radio"/>	<input type="radio"/>
Sweep average	OFF	1	64	1	<input type="radio"/>	<input type="radio"/>
Smoothing	OFF	1	11	2	<input type="radio"/>	<input type="radio"/>
Sweep mode	NORMAL	-	-	-	<input type="radio"/>	<input type="radio"/>
Gate Time(sec)	0.01	0	1	0.001	<input type="radio"/>	<input type="radio"/>
SYNC	Low	-	-	-	<input type="radio"/>	<input type="radio"/>
DELAY(μ sec)	10	0	1000	0.1	<input type="radio"/>	<input type="radio"/>
EDGE	RISE	-	-	-	<input type="radio"/>	<input type="radio"/>
Wavelength resolution (nm)	0.2	0.01	0.5	-	<input type="radio"/>	<input type="radio"/>
Cursor	OFF	-	-	-	<input checked="" type="radio"/>	<input checked="" type="radio"/>

3.4.1 Defaults Configuration Values

Table 3-3 Default Settings (2 of 6)

Item	Default	Minimum value	Maximum value	Setting resolution	Backup	File save
Cursor data	NORMAL	-	-	-	○	○
Dual screen display	OFF	-	-	-	×	×
Superimpose mode	OFF	-	-	-	×	×
Multi trace	OFF	-	-	-	×	×
Trace max	8	1	32	1	○	○
Current trace No.	1	1	32	1	×	×
Auto trace	ON	-	-	-	○	○
Grid	ON	-	-	-	○	○
Sampling point	501	101	10001 Note 1	-	○	○
Auto sample	OFF	-	-	-	○	○
Peak normalize	OFF	-	-	-	×	○
Power monitor	OFF	-	-	-	○	○
Power monitor times	101	11	1001	1	○	○
Power monitor interval (sec)	0.5	0.5	3600	0.1	○	○
Limit line	OFF	-	-	-	×	×
Spectral width	OFF	-	-	-	×	×
Spectral width type	pk-XdB	-	-	-	○	○
THRESHOLD LVL1 (dB)	3	-59.9	59.9	0.01	○	○
THRESHOLD LVL2 (dB)	20	0.1	99.9	0.01	○	○
K Parameter (RMS, Peak RMS)	1	0.1	100	0.01	○	○
Kr(RMS)	2.3548	1	10	0.0001	○	○
Spectral width width(nm)	1	0.01	100	0.01	○	○
Notch width	OFF	-	-	-	×	×
Notch width level(dB)	3	-59.9	59.9	0.01	○	○
Notch width width(nm)	1	0.01	100	0.01	○	○

Note 1:Up to 2001 points when the multi-trace function is turned on

Table 3-3 Default Settings (3 of 6)

Item	Default	Minimum value	Maximum value	Setting resolution	Backup	File save
Opt AMP	OFF	-	-	-	×	×
Opt AMP MODE	Single	-	-	-	○	○
NF(s-sp) or NF(total)	NF(s-sp)	-	-	-	○	○
ASE Fitting	GAUSS	-	-	-	○	○
SPECTRUM DIVISION	OFF	-	-	-	○	○
K Parameter(OPT AMP)	1	0.1	100	0.01	○	○
Masked SPAN(nm)	0.4	0	1100	0.01	○	○
Fitting SPAN(nm)	1	0	1100	0.01	○	○
FILTER $\Delta\lambda$ (nm)	0	0	1100	0.01	○	○
Pin LOSS(dB)	0	-10	10	0.01	○	○
Pout LOSS(dB)	0	-10	10	0.01	○	○
Peak Excursion (dB)	1	0	100	0.01	○	○
WDM LIST	OFF	-	-	-	×	×
WDM MODE	Multi Peak	-	-	-	○	○
WDM LIST ALL	OFF	-	-	-	○	○
WDM ASE Method	AUTO OFF	-	-	-	○	○
Threshold Level (dB)	20	0.1	99.9	0.01	○	○
GRID Ref Frequency (THz)	193.10	100	500	0.0001	○	○
GRID CH Spacing (GHz)	100.0	10	10000	0.1	○	○
Manual ASE Level (dBm)	-40	-90	23	0.01	○	○
ASE converted NBW (nm)	1	0.01	10	0.001	○	○
ASE NBW	current	-	-	-	○	○
Reference CH No.	1	1	256	1	×	×
Signal Power Mode	Peak	-	-	-	○	○
WDM Monitor	OFF	-	-	-	×	×
SPECTRUM display	OFF	-	-	-	○	○

3.4.1 Defaults Configuration Values

Table 3-3 Default Settings (4 of 6)

Item	Default	Minimum value	Maximum value	Setting resolution	Backup	File save
GRAPH X	Time	-	-	-	<input type="radio"/>	<input type="radio"/>
DATA MODE	λ .f	-	-	-	<input type="radio"/>	<input type="radio"/>
ABSOLUTE/RELATIVE	ABS	-	-	-	<input type="radio"/>	<input type="radio"/>
Graph All Data	ON	-	-	-	<input type="radio"/>	<input type="radio"/>
Current Time No.	1	1	501	1	<input checked="" type="checkbox"/>	<input checked="" type="checkbox"/>
Current Channel No.	1	1	256	1	<input checked="" type="checkbox"/>	<input checked="" type="checkbox"/>
Measurement Times	11	1	501 Note 2	1	<input type="radio"/>	<input type="radio"/>
Time Interval (min.)	0.1	0.1	1440	0.1	<input type="radio"/>	<input type="radio"/>
Pass/Fail Enable	disable	-	-	-	<input type="radio"/>	<input type="radio"/>
λ Drift Limit (nm)	0.1	0.01	10	0.001	<input type="radio"/>	<input type="radio"/>
Nominal Level (dBm)	0	-90	+23	0.01	<input type="radio"/>	<input type="radio"/>
Level Upper Limit (dBm)	20	-90	+23	0.01	<input type="radio"/>	<input type="radio"/>
Level Lower Limit (dBm)	-20	-90	+23	0.01	<input type="radio"/>	<input type="radio"/>
Norminal SNR (dB)	20	0	60	0.01	<input type="radio"/>	<input type="radio"/>
SNR Lower Limit (dB)	10	0	60	0.01	<input type="radio"/>	<input type="radio"/>
O-BPF	OFF	-	-	-	<input checked="" type="checkbox"/>	<input checked="" type="checkbox"/>
Pass Band Threshold (dB)	0.5	0.1	99.9	0.01	<input type="radio"/>	<input type="radio"/>
Half Band Threshold (dB)	3	0.1	99.9	0.01	<input type="radio"/>	<input type="radio"/>
Stop Band Threshold (dB)	26	0.1	99.9	0.01	<input type="radio"/>	<input type="radio"/>
Ripple Select	ripple	-	-	-	<input type="radio"/>	<input type="radio"/>
Search Area Pass (nm)	0	0	10	0.01	<input type="radio"/>	<input type="radio"/>
Search Area Stop (nm)	0	0	10	0.01	<input type="radio"/>	<input type="radio"/>
Std Wavelength	GRID	-	-	-	<input type="radio"/>	<input type="radio"/>
Isolation Pass	min	-	-	-	<input type="radio"/>	<input type="radio"/>
Isolation Stop	max	-	-	-	<input type="radio"/>	<input type="radio"/>

Note 2: When the analyzer is set to the monitoring function, up to 201 times if the number of WDM signals is between 65 and 128, or up to 101 times if the number of WDM signals is 129 or more.

Table 3-3 Default Settings (5 of 6)

Item	Default	Minimum value	Maximum value	Setting resolution	Backup	File save
Filter Tilt	OFF	-	-	-	×	×
DFB-LD	OFF	-	-	-	×	×
FP-LD	OFF	-	-	-	×	×
LED	OFF	-	-	-	×	×
Limit Line Shift X (nm)	0	-1100	1100	0.001	×	×
Limit Line Shift Y (dB)	0	-220	220	0.01	×	×
Show Param	OFF	-	-	-	×	×
Auto Pass/Fail	OFF	-	-	-	○	○
DEVICE TYPE	Internal PRT	-	-	-	○	×
FLOPPY ON/OFF	OFF	-	-	-	○	×
FLOPPY FORMATTING	2HD	-	-	-	○	×
Bitmap Compless	OFF	-	-	-	○	×
Bitmap Save	Color	-	-	-	○	×
Color Pattern	PATTERN-1	-	-	-	○	×
Ext. PRT MODE	GRAY	-	-	-	○	×
Ext. PRT COMMAND	ESC/P	-	-	-	○	×
BUZZER(BEEP)	ON	-	-	-	○	×
WARNING	ON	-	-	-	○	×
QUIET BEEP	NORMAL	-	-	-	○	×
EXT Key	US	-	-	-	○	×
CLOCK ON/OFF	ON	-	-	-	○	×
MENU OUT(printer)	ON	-	-	-	○	×
CAL λ (Int.)	-	-	-	-	○	×
CAL λ (Ext.)	-	600	1700	0.001	○	×
λ OFFSET(nm)	0	-100	100	0.001	○	○

3.4.1 Defaults Configuration Values

Table 3-3 Default Settings (6 of 6)

Item	Default	Minimum value	Maximum value	Setting resolution	Backup	File save
LEVEL OFFSET(dB)	0	-20	20	0.01	○	○
RECALL OFFSET	OFF	-	-	-	○	×

○: The parameter is saved to Backup or File save.

×: The parameter is not saved to Backup or File save.

4 REMOTE CONTROL

4.1 GPIB Command Index

This GPIB command index can be used as the index for Chapter 4.

GPIB Command	Pages	GPIB Command	Pages
*IDN	4-49	FEE	4-46
*TST	4-49	FFO	4-46
ACP	4-45	FMT	4-47
ALM	4-47	FON	4-46
APC	4-36	FPL	4-45
APF	4-40	FRQ	4-36
ASP	4-39	FSP	4-36
AUL	4-39	FTL	4-45
AUT	4-37	FTM	4-44
AVG	4-37	GRF	4-42, 4-44, 4-45
AVS	4-37	GRI	4-39
BCP	4-46	GSP	4-42, 4-44, 4-45
BPF	4-44	HBT	4-44
BSV	4-46	HED(HD)	4-47
BUZ	4-46	IPR	4-47
C(*RST)	4-49	ISP	4-44
CEN	4-36	ISS	4-44
CKD	4-46	LAB	4-38
CLE	4-47	LAR	4-42
CLF	4-47	LCC	4-42
CLM	4-47	LCT	4-42
CLO	4-46	LDA	4-42
CLS	4-47	LED	4-45
COP	4-46	LEV	4-37
CPT	4-46	LFD	4-43
CSB	4-47	LHA	4-42
CUC	4-36	LIN	4-37
CUD	4-38	LLL	4-43
CUL	4-37	LMT	4-42
CUR	4-38	LNL	4-43
DEL(DL)	4-47	LNS	4-43
DEV	4-46	LOS	4-40
DFB	4-45	LPF	4-48
DLY	4-37	LPI	4-41
DMD	4-39	LPO	4-41
DUA	4-39	LPR	4-40
E(*TRG)	4-49	LPS	4-38
EGE	4-37	LPT	4-40
EKB	4-46	LRS	4-48
EPM	4-46		
FDL	4-41		

4.1 GPIB Command Index

LSC	4-37	OPK	4-47
LSD	4-42	OPM	4-48
LSL	4-43	OPN	4-48
LSP	4-36	OSD	4-47
LTF	4-42	OSW	4-48
LTI	4-42	OVS	4-47
LTM	4-42	OWN	4-48
LUL	4-43	OWP	4-48
LVA	4-42	PAN	4-48
MAL	4-44	PAS	4-48
MAT	4-39	PBT	4-44
MCU	4-39	PGT	4-37
MDA	4-39	PIN	4-40
MDC	4-39	PKC	4-36
MEA	4-38	PKL	4-37
MEN	4-46	PKX	4-44, 4-45
MIM	4-40	PLM	4-40
MMX	4-39	PLV	4-41
MNC	4-37	PLW	4-41
MNH	4-37	PMO	4-40
MNT	4-39	PNR	4-40
MPT	4-39	PNX	4-40
MSK	4-47	PRT	4-46
MSP(MS)	4-47	QUI	4-46
MTE	4-39	RAU	4-37
MXC	4-37	RCL	4-40
MXH	4-37	REF	4-37
NFK	4-41	RES	4-37
NFT	4-41	RPL	4-44
NLV	4-41	RPS	4-38
NPK	4-41	S	4-47
NWD	4-41	SAP	4-44
NWI	4-41	SAS	4-44
OAC	4-49	SAV	4-39
OAM	4-41	SBT	4-44
OBP	4-49	SCR	4-42
OCD	4-48	SDL(DS)	4-47
ODF	4-49	SDV	4-41
ODN	4-47	SFX	4-40
OFP	4-49	SFY	4-40
OFT	4-49	SIM	4-39
OGN	4-48	SMD	4-42
OLE	4-49	SMN	4-37
OLM	4-48	SNA	4-44
OLN	4-48	SNB	4-44
OLS	4-48	SPA	4-36
OLT	4-48	SPT	4-39
OMD	4-41	SPW	4-41
ONT	4-48	SRQ	4-47
ONW	4-48	SRS	4-42
OPA	4-48	SRW	4-45

STA	4-36
STO	4-36
STW	4-45
SWE	4-37
SWL	4-44
SYN	4-37
TRA	4-40
WAL	4-42
WAR	4-46
WAU	4-44
WDM	4-42
WMD	4-42
WPK	4-41
WPR	4-41
WPW	4-41
WPX	4-41, 4-45
WPY	4-41, 4-45
WRF	4-42
WSL	4-43
WSS	4-43
WSW	4-43
WTY	4-41
WYD	4-44
XAC	4-38
XAS	4-38
XBC	4-38
XBS	4-38
XUL	4-39
YAC	4-38
YAS	4-38
YBC	4-38
YBS	4-38

4.2 Overview of GPIB

4.2 Overview of GPIB

The GPIB is an interface connected to the measurement device, controller, and peripheral units, etc., through a simple cable (bus line).

The GPIB is more expandable than conventional interfaces, is easy to use, and has electrical, mechanical, and functional compatibility with other manufacturers' products, making it applicable to system configurations from simple systems to automatic design systems with high-level functions using one bus cable.

To use the GPIB, first setting an "address" for each instrument connected to the bus line is required. Each instrument is assigned one or more roles from the following three roles: controller, talker (TALKER), or listener (LISTENER).

During system operation, only one "talker" can send data to the bus line, but plural "listeners" can receive it.

The controller specifies the addresses of "talker" and "listener" to transfer data from "talker" to "listener", and the controller sets setting conditions from "talker" to "listener".

Data is synchronously transferred synchronously bidirectionally between devices via eight data lines in the bit-parallel, byte-serial form. Because this is a synchronous system, using high-speed and low-speed devices together in the same system is possible.

Data (messages) transferred between devices include measurement data, measurement conditions (programs), and commands; they are in ASCII.

In addition to eight data lines, the GPIB has three handshake lines for controlling the synchronous data transmission between instruments, and five control lines for controlling the bus information flow.

4.3 Interface Functions

Table 4-1 shows analyzer interface functions.

Table 4-1 Interface Functions

Code	Function
SH1	Source handshake
AH1	Acceptor handshake
T6	Basic talker Serial polling Talker reset based on listener specification
L4	Basic listener Listener reset based on talker specification
SR1	Service request
RL1	Remote
PP0	No parallel function
DC1	Device clear
DT1	Device trigger
C0	No controller function
E2	Three-state-bus-driver used

4.4 Program Code

4.4 Program Code

This section explains the program code through which the outside controller sets analyzer conditions.

Each program code consists of three English characters which indicate the functions and numerical data for setting functions as follows:

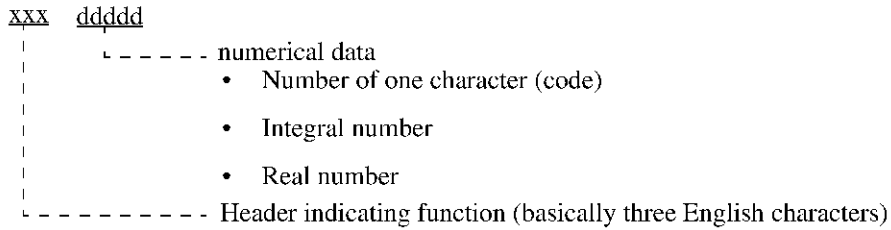

The state of each condition is read in by adding “?” after the functional header.

NOTE:

1. *For the functional header and unit, either a capital letter or a lower-case letter is used for setting. Any space code (20H) is set in a program code.*
 2. *In this analyzer, the program code is processed in one row to the terminator. The maximum allowable characters set in one row are 255. When describing a plurality of program codes in one row, set the program codes by punctuating with comma (,) or semicolon (;).*
-

4.5 Talker Formats (Data Output Formats)

This section describes the talker formats used when this analyzer system transfers data to an external controller.

Data is classified roughly into eighteen types of formats.

- Header: 2 to 4 characters (not output if Header OFF)
- SP: Space (20H)
- DS: Data Separator (either ',' or CR or NL)
Can be specified by the program code "SDLn" ("DSn").
- T: Terminator (either NL<EOI>, NL, <EOI>, or CR,NL<EOI>)
Can be specified by the program code "DELn" ("DLn").

Mantissa part data: polarity + decimal point + 5 to 7 numbers (digits)

Exponent part data: 10⁻¹² to 10¹² (delimited by every three digits)

- (1) Waveform data (program code "OSD0", "OSD1", "OSD2", "OSD3", "OPA")
 - ASCII format (format specification code "FMT0")

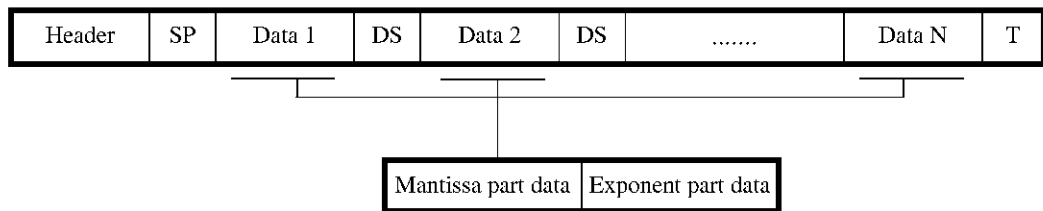

Header	Data type
LMUM	Wavelength [m]
FQTH	Frequency [Hz]
LVLG	Level data in logarithmic scale [dB, dBm]
LVLI	Level data in linear scale
LVPC	Level data of unit %
TM S	Time data in trend chart
OPA	ASE fitting data [dBm]

4.5 Talker Formats (Data Output Formats)

- BINARY format (format specification code (“FMT1”, “FMT2”, “FMT3”, “FMT4”))



Is output in either of the following four formats according to the setting of the format specification code “FMTn.”

- (a) “FMT1” ... 16 bits (integer type)

Is output within the range of 0 to 10000 on the X axis and within 0 to 10000 on the Y axis by setting all data on the screen as linear scale.

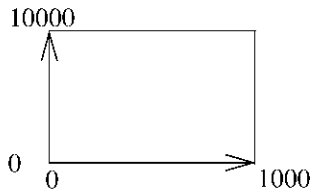

- (b) “FMT2” ... 64 bits (floating point type)

Outputs data in the floating-point format (IEEE Std.754-1985 format) as shown below.

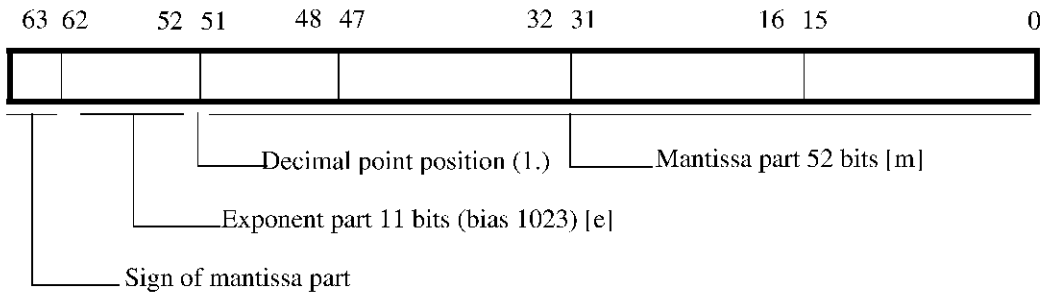

The formula is shown below.

$$(-1)^S \times 1.m \times 2^{(e-1023)}$$

(c) "FMT3" ... 32 bits (IEEE floating-point type)

Outputs data in the floating-point format (IEEE Std.754-1985 format) as shown below.

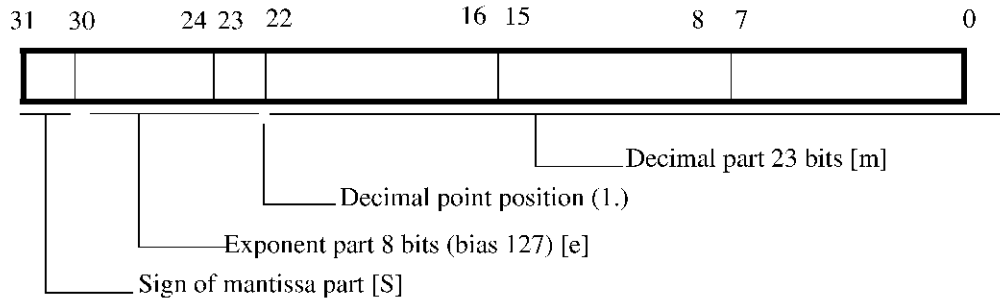

The formula is shown below.

$$(-1)^S \times 1.m \times 2^{(e-127)}$$

4.5 Talker Formats (Data Output Formats)

(2) Peak search data (Program code "OPK")

- Spectrum measurement

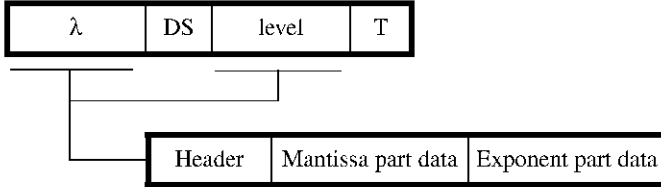

Header	Data type
LMPK	Peak wavelength (λ)
LQPK	Peak frequency (f)
LVPK	Peak level (level)

- Power monitor display

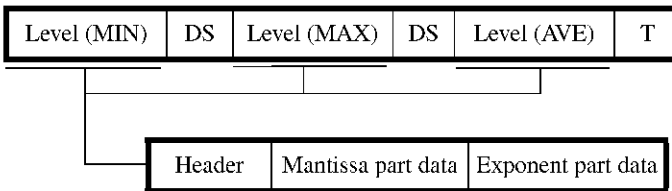

Header	Data type
LVMN	Minimum of the level data
LVMX	Maximum of the level data
LVAV	Average value of the level data

(3) Cursor data (Program code "OCD")

One of the following four formats is used according to the "CUDn" code for specifying the cursor display mode.

(In power monitor display, the cursor data output is fixed not according to the "CUDn".)

- "CUD0" ... Normal

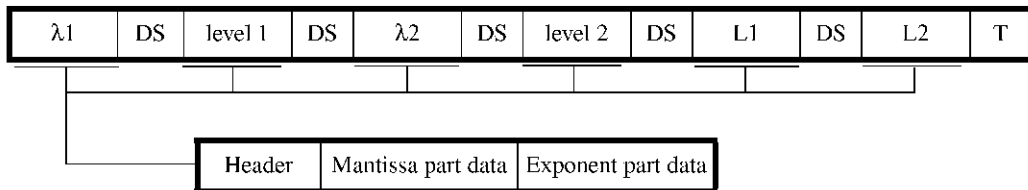

Header	Data type
LMXA	Wavelength of X cursor 1 (λ_1)
FQXA	Frequency of X cursor 1 (f1)
LVXA	Level of X cursor 1 (level 1)
LMXB	Wavelength of X cursor 2 (λ_2)
FQXB	Frequency of X cursor 2 (f2)
LVXB	Level of X cursor 2 (level 2)
LVYA	Level of Y cursor 1 (L1)
LVYB	Level of Y cursor 2 (L2)

4.5 Talker Formats (Data Output Formats)

- “CUD0” ... Normal (Case of minimum/maximum hold mode)

$\lambda 1$	DS	level1	DS	level2	DS	level3	DS	$\lambda 2$	DS	level4	DS	level5	DS	level6	T
-------------	----	--------	----	--------	----	--------	----	-------------	----	--------	----	--------	----	--------	---

Header	Data type
LMXA	Wavelength of X cursor 1 ($\lambda 1$)
FQXA	Frequency of X cursor 1 (f1)
MXXA	Maximum hold level of X cursor 1 (level 1)
LVXA	Current waveform level of X cursor 1 (level 2)
MNXA	Minimum hold level of X cursor 1 (level 3)
LMXB	Wavelength of X cursor 2 ($\lambda 2$)
FQXB	Frequency of X cursor 2 (f2)
MXXB	Maximum hold level of X cursor 2 (level 4)
LVXB	Current waveform level of X cursor 2 (level 5)
MNXB	Minimum hold level of X cursor 2 (level 6)

- “CUD1” ... Δ MODE

$\lambda 1$	DS	level 1	DS	$\Delta\lambda$	DS	Δ level	DS	L1	DS	Δ L	T
-------------	----	---------	----	-----------------	----	----------------	----	----	----	------------	---

Header	Data type
LMXA	Wavelength of X cursor 1 ($\lambda 1$)
FQXA	Frequency of X cursor 1 (f1)
LVXA	Level of X cursor 1 (level 1)
LMDX	Wavelength difference between X cursor 1 and 2 ($\Delta\lambda$)
FQDA	Frequency difference between X cursor 1 and 2 (Δ f)
LVDX	Level difference between X cursor 1 and 2 (Δ level)
LVYA	Level of X cursor 1 (L1)
LVDY	Level difference between Y cursor 1 and 2 (Δ L)

- “CUD1” ... ΔMODE (Case of minimum/maximum hold mode)

$\lambda 1$	DS	level1	DS	level2	DS	level3	DS	$\lambda 2$	DS	level4	DS	level5	DS	level6	T
-------------	----	--------	----	--------	----	--------	----	-------------	----	--------	----	--------	----	--------	---

Header	Data type
LMXA	Wavelength of X cursor 1 ($\lambda 1$)
FQXA	Frequency of X cursor 1 (f1)
MMXA	Level difference between max hold and min hold at X cursor 1 (level 1)
MCXA	Level difference between max hold and Current at X cursor 1 (level 2)
CMXA	Level difference between Current and min hold at X cursor 1 (level 3)
LMXB	Wavelength of X cursor 2 ($\lambda 2$)
FQXB	Frequency of X cursor 2 (f2)
MMXB	Level difference between max hold and min hold at X cursor 2 (level 4)
MCXB	Level difference between max hold and Current at X cursor 2 (level 5)
CMXB	Level difference between Current and min hold at X cursor 2 (level 6)

- “CUD2” ... 2ND PEAK

$\lambda 1$	DS	level 1	DS	$\Delta \lambda$	DS	Δlevel	T
-------------	----	---------	----	------------------	----	-----------------------	---

Header	Data type
LMPK	Peak wavelength ($\lambda 1$)
FQPK	Peak frequency (f1)
LVPK	Peak level (level 1)
LMDP	Wavelength difference between 1st and 2nd peaks ($\Delta \lambda$)
FQDP	Frequency difference between the 1st and the 2nd peaks (Δf)
LVDP	Level difference between 1st and 2nd peaks (Δlevel)

4.5 Talker Formats (Data Output Formats)

- “CUD3” ... POWER

$\lambda 1$	DS	$\lambda 2$	DS	ΣL	T
-------------	----	-------------	----	------------	---

Header	Data type
LMXA	Wavelength of X cursor 1 ($\lambda 1$)
FQXA	Frequency of X cursor 1 (f1)
LMXB	Wavelength of X cursor 2 ($\lambda 2$)
FQXB	Frequency of X cursor 2 (f2)
LVPW	Sum of levels between X cursor 1 and 2 (ΣL).

- “CUD4” ... Peak to Peak

$\lambda 1$	DS	level 1	DS	$\lambda 2$	DS	level 2	DS	$\Delta \lambda$	DS	$\Delta level$	T
-------------	----	---------	----	-------------	----	---------	----	------------------	----	----------------	---

Header	Data type
LMXA	Wavelength of X cursor 1 ($\lambda 1$).
FQXA	Frequency of X cursor 1 (f1).
LVXA	Level of X cursor 1 (level 1).
LMXB	Wavelength of X cursor ($\lambda 2$).
FQXB	Frequency of X cursor 2 (f2).
LVXB	Level of X cursor 2 (level 2).
LMPP	Wavelength difference of maximum and minimum ($\Delta \lambda$).
FQPP	Frequency difference between the maximum and the minimum values (Δf).
LVPP	Level difference of Maximum and minimum ($\Delta level$).

- (4) Spectral width data and notch width data (Program code “OSW”, “ONW”)
- Calculation results of Peak Threshold, Envelope, RMS, Peak RMS, and X dB Width
The results of five types of calculations are all output in the following format:

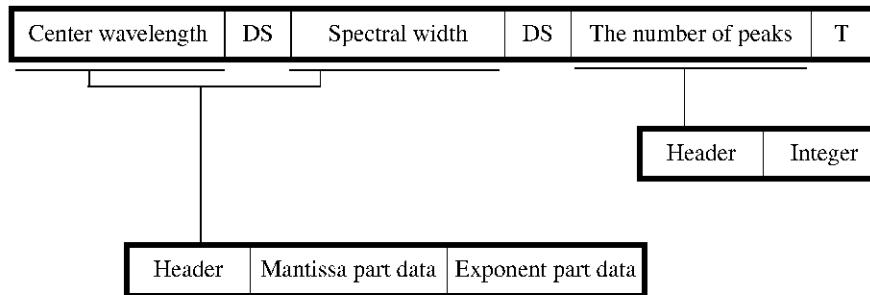

Header	Data type
LMCN	Center wavelength
FQCN	Center frequency
LMHW	Spectral wavelength width
FQHW	Spectral frequency width
NOSP	Numbers of peaks

- Calculation result of the Xnm Level

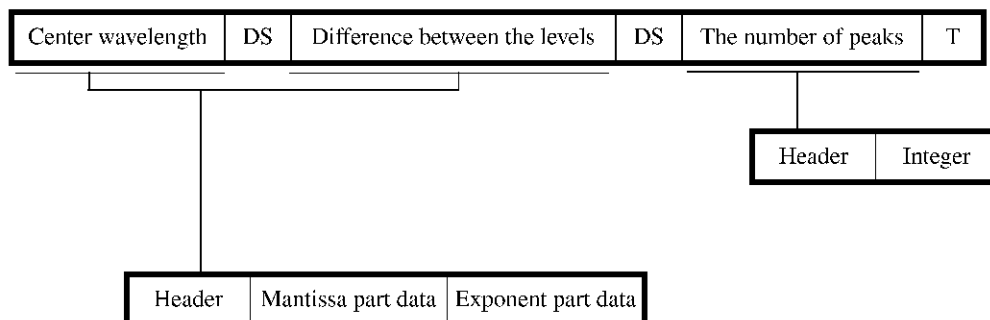

Header	Data type
LMCN	Center wavelength
FQCN	Center frequency
LVLX	The difference between the maximum level and the Spectral width level of Xnm
NOSP	Numbers of peaks

4.5 Talker Formats (Data Output Formats)

(5) GPIB output format of gain and noise figure operation result (“OGN”).

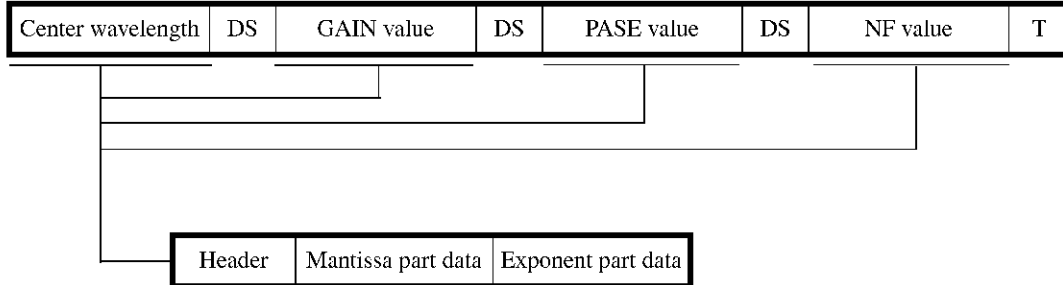

Header	Data type
LMCN	Center wavelength
FQCN	Center frequency
GAIN	GAIN value
PASE	PASE value
NF	NF value

(6) GPIB output format of gain, noise figure and total ASE power operation result (“OPN”).

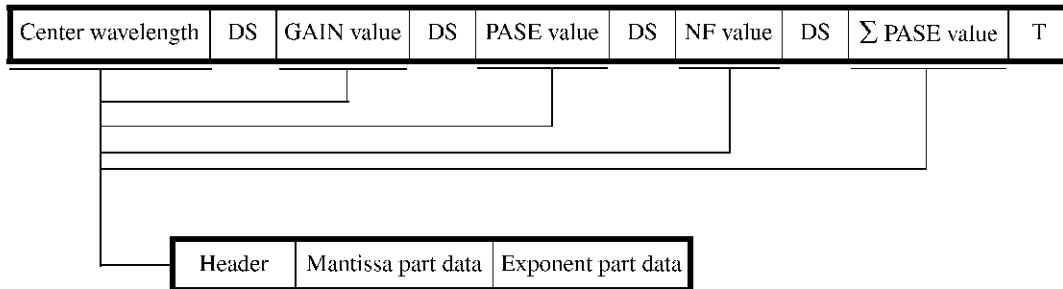

Header	Data type
LMCN	Center wavelength
FQCN	Center frequency
GAIN	GAIN value
PASE	PASE value
NF	NF value
PSPW	ΣPASE value (Total ASE power)

(7) List data output (“OLS”)

- OPE, AMP and WDM operation results 1

Operation results are output for the number of peaks (the value read by OWP) of the output formats shown in (5) “OGN”. However, the terminator is sent at the last of the output only. The terminator is sent only to the end of the output.

- Multi peak

Operation results are output for the number of peaks (the value read by OLN) of the output formats shown in (2) “OPK”. However, the terminator is sent at the last of the output only. The terminator is sent only to the end of the output.

- SNR

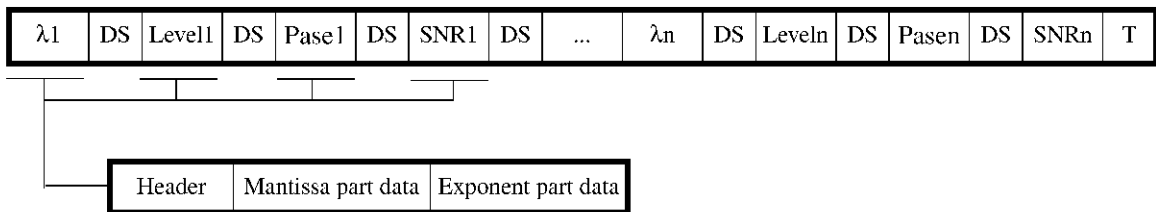

Header	Data type
LMLS	Wavelength
FQLS	Frequency
LVLS	Level value
PASE	PASE value
SNR	SNR value

4.5 Talker Formats (Data Output Formats)

- Relative

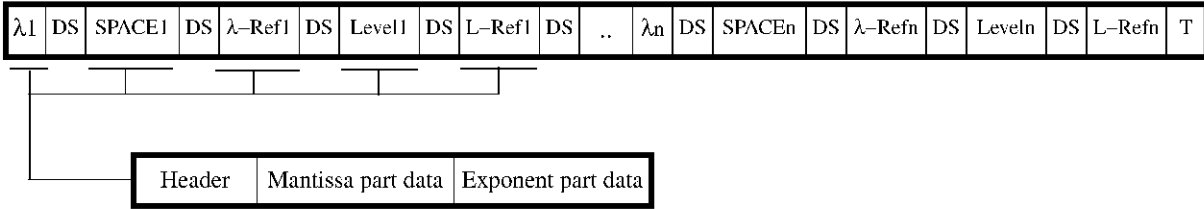

Header	Data type
LMLS	Wavelength
FQLS	Frequency
LSPC	Spacing value (wavelength)
FSPC	Spacing value (frequency)
LMRF	λ -Ref value (wavelength)
FMRF	f-Ref value (frequency)
LVLS	Level value
LVRF	L-Ref value

- ITU-GRID

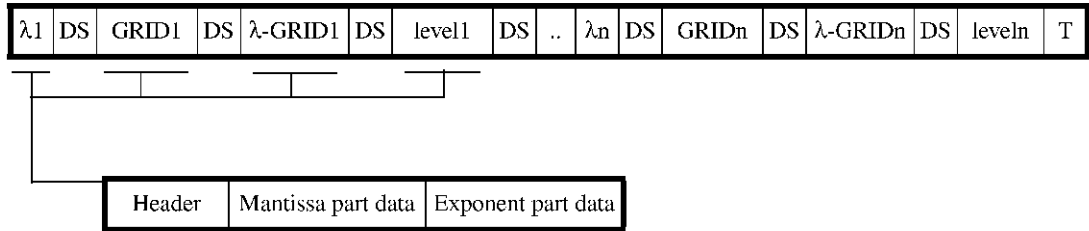

Header	Data type
LMLS	Wavelength
FQLS	Frequency
LMGD	GRID wavelength
FQGD	GRID frequency
LMRG	λ -GRID value (wavelength)
FQRG	f-GRID value (frequency)
LVLS	Level value

4.5 Talker Formats (Data Output Formats)

(8) GPIB output format of Opt.AMP result 2 (“OWN”)

This format has the level values of all signals added to the “OGN” output format described in paragraph (5).

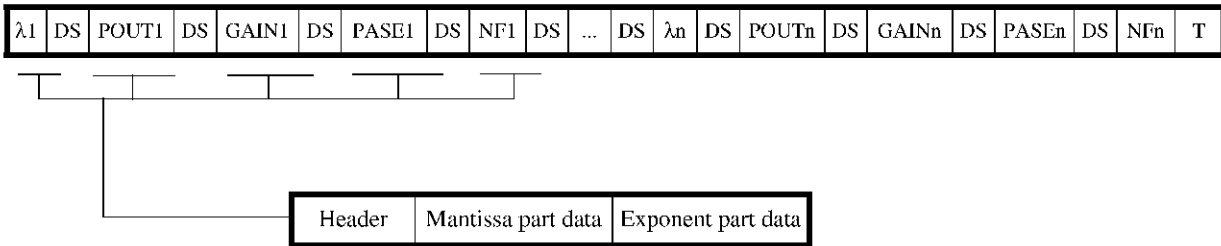

Header	Data type
LMCN	Center wavelength
FQCN	Center frequency
POUT	Level value
GAIN	GAIN value
PASE	PASE value
NF	NF value

(9) Output format for WDM list ("OLM")

- Multi Peak

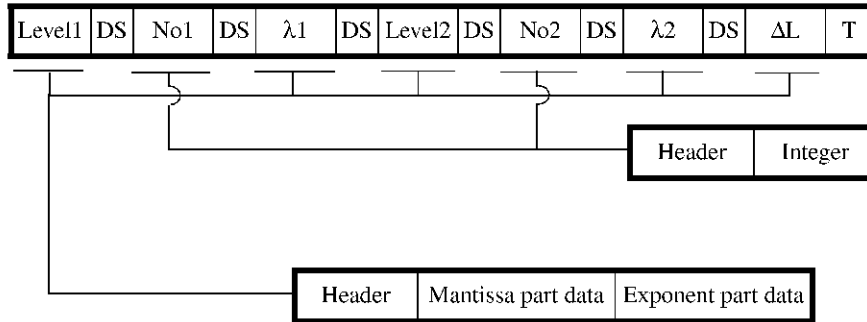

Header	Data type
LVPX	Maximum peak level (Level1)
XCHN	Channel number for the maximum peak (No1)
LMXP	Wavelength of the maximum peak (λ_1)
FQXP	Frequency of the maximum peak (f1)
LVPN	Minimum peak level (Level2)
NCHN	Channel number for the minimum peak (No2)
LMNP	Wavelength of the minimum peak (λ_2)
FQNP	Frequency of the minimum peak (f2)
LVXN	Level difference between the maximum peak and the minimum peak (ΔL)

4.5 Talker Formats (Data Output Formats)

- SNR

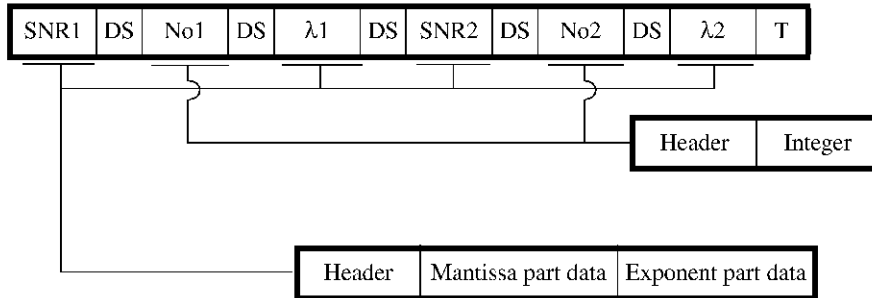

Header	Data type
SNRX	SNR of maximum peak level (SNR1)
XCHN	Channel number for the maximum peak (No1)
LMXP	Wavelength of the maximum peak (λ_1)
FQXP	Frequency of the maximum peak (f1)
SNRN	SNR of minimum peak level (SNR2)
NCHN	Channel number for the minimum peak (No2)
LMNP	Wavelength of the minimum peak (λ_2)
FQNP	Frequency of the minimum peak (f2)

- Relative

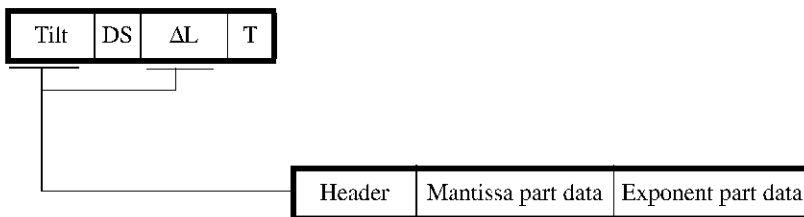

Header	Data type
TILT	Tilt (slope) of the approximated line (Tilt)
TLVD	Level difference between both ends of the approximated line (ΔL)

(10) GPIB output format used in the WDM monitor data table (OLTxxx)

- When Pass/Fail is set to OFF

Outputs the measurement time number and the nth measurement data.

The data group consisting of λ , level and SNR is output once for each peak (that has been loaded using OLN)

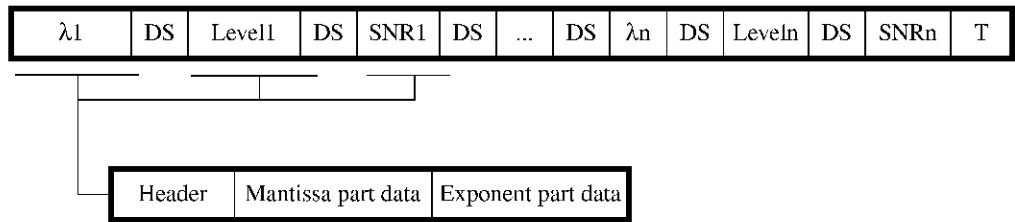

Header	Data type
LMLS	Wavelength
FQLS	Frequency
LVLS	Level value
SNR	SNR value

4.5 Talker Formats (Data Output Formats)

- When Pass/Fail is set to ON
 A data group consisting of λ , level and SNR, and the Pass/Fail judgment for each parameter are output once for each peak (that has been loaded using OLS).

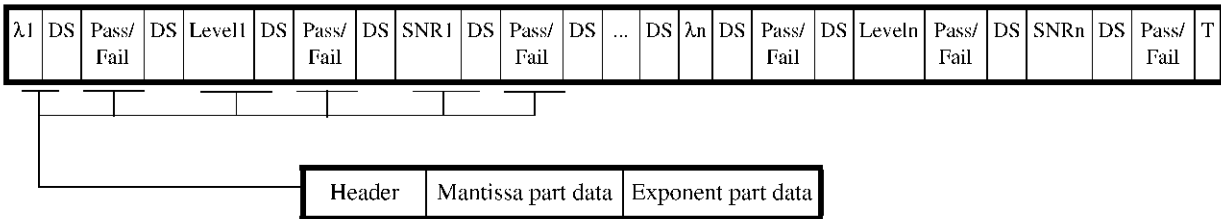

Header	Data type
LMLS	Wavelength
FQLS	Frequency
LVLS	Level value
SNR	SNR value
PSLM	Pass/Fail for the wavelength (frequency)
PSLV	Pass/Fail for the level
PSSR	Pass/Fail for SNR

(11) GPIB output format for the O-BPF calculation result ("OBP")

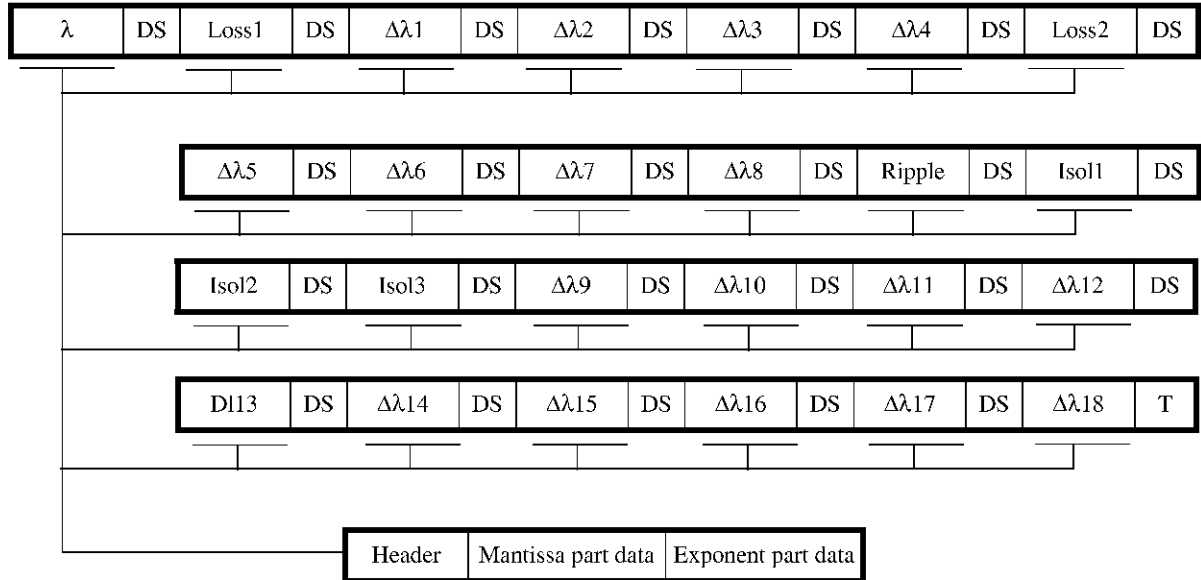

Header	Data type
LMPK	Peak wavelength (λ)
FQPK	Peak frequency (f)
LVPK	Insertion Loss (Loss1)
LMPW	Pass Bandwidth (wavelength $\Delta\lambda_1$)
FQPW	Pass Bandwidth (frequency Δf_1)
LMPC	Pass Center Wavelength (wavelength $\Delta\lambda_2$)
FQPC	Pass Center Wavelength (frequency Δf_2)
LMPL	Pass Left Wavelength (wavelength $\Delta\lambda_3$)
FQPL	Pass Left Wavelength (frequency Δf_3)
LMPR	Pass Right Wavelength (wavelength $\Delta\lambda_4$)
FQPR	Pass Right Wavelength (frequency Δf_4)
PBLS	Pass Band Loss (Loss2)
LMHW	Half Bandwidth (wavelength $\Delta\lambda_5$)
FQHW	Half Bandwidth (frequency Δf_5)
LMCN	Half Center Wavelength (wavelength $\Delta\lambda_6$)
FQCN	Half Center Wavelength (frequency Δf_6)
LMHL	Half Left Wavelength (wavelength $\Delta\lambda_7$)

4.5 Talker Formats (Data Output Formats)

Header	Data type
FQHL	Half Left Wavelength (frequency Δf_7)
LMHR	Half Right Wavelength (wavelength $\Delta \lambda_8$)
FQHR	Half Right Wavelength (frequency Δf_8)
RPPL	Ripple
AISO	Adjacent Isolation (Isol1)
NISO	Non Adjacent Isolation (Isol2)
TISO	Total Isolation (Isol3)
LPKP	Peak-Pass Center Diff (wavelength $\Delta \lambda_9$)
FPKP	Peak-Pass Center Diff (frequency Δf_9)
LPKH	Peak-Half Center Diff (wavelength $\Delta \lambda_{10}$)
FPKH	Peak-Half Center Diff (frequency Δf_{10})
LPSH	Pass-Half Center Diff (wavelength $\Delta \lambda_{11}$)
FPSH	Pass-Half Center Diff (frequency Δf_{11})
LPSG	Pass Center Error (wavelength $\Delta \lambda_{12}$)
FPSG	Pass Center Error (frequency Δf_{12})
LHFG	Half Center Error (wavelength $\Delta \lambda_{13}$)
FHFG	Half Center Error (frequency Δf_{13})
LPKG	Peak Wavelength Error (wavelength $\Delta \lambda_{14}$)
FPKG	Peak Wavelength Error (frequency Δf_{14})
LMSW	Stop Bandwidth (wavelength $\Delta \lambda_{15}$)
FQSW	Stop Bandwidth (frequency Δf_{15})
LMSC	Stop Center Wavelength (wavelength $\Delta \lambda_{16}$)
FQSC	Stop Center Wavelength (frequency Δf_{16})
LMRH	RMS Bandwidth (wavelength $\Delta \lambda_{17}$)
FQRH	RMS Bandwidth (frequency Δf_{17})
LMRC	RMS Center Wavelength (wavelength $\Delta \lambda_{18}$)
FQRC	RMS Center Wavelength (frequency Δf_{18})

(12) GPIB output format for the Filter Tilt calculation result ("OFT")

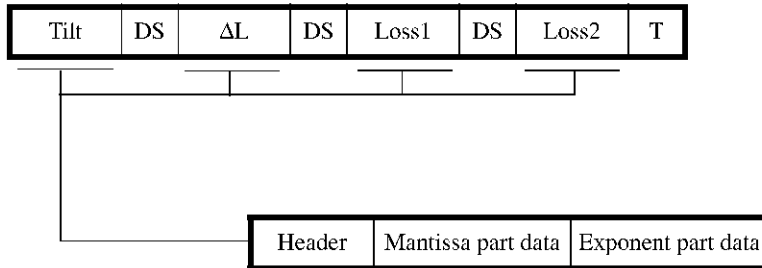

Header	Data type
TILT	Tilt (slope) of the approximated line (Tilt)
TLVD	Level difference between both ends of the approximated line (ΔL)
TILL	Insertion Loss Left (Loss1)
TILR	Insertion Loss Right (Loss2)

4.5 Talker Formats (Data Output Formats)

(13) GPIB output format for the DFB-LD calculation result ("ODF")

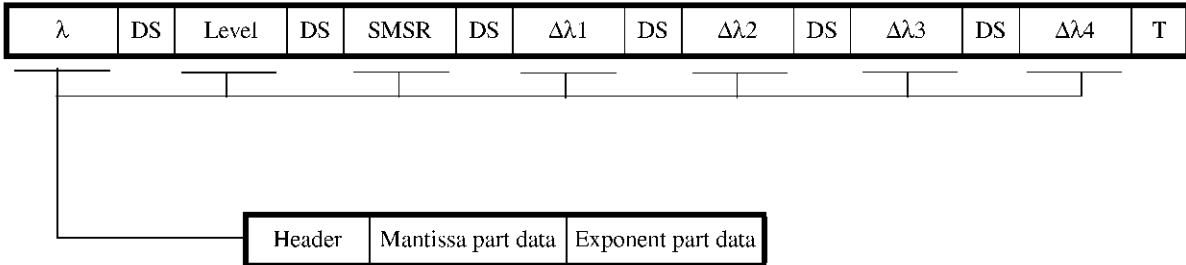

Header	Data type
LMPK	Peak wavelength (λ)
FQPK	Peak frequency (f)
LVPK	Peak level value (Level)
LVDP	SMSR
LMDP	Mode Offset (wavelength $\Delta\lambda_1$)
FQDP	Mode Offset (frequency Δf_1)
LMSW	Stop Band (wavelength $\Delta\lambda_2$)
FQSW	Stop Band (frequency Δf_2)
LMCO	Center Offset (wavelength $\Delta\lambda_3$)
FQCO	Center Offset (frequency Δf_3)
LMHW	Spectral width (wavelength $\Delta\lambda_4$)
FQHW	Spectral width (frequency Δf_4)

(14) GPIB output format for the FP-LD calculation result ("OFP")

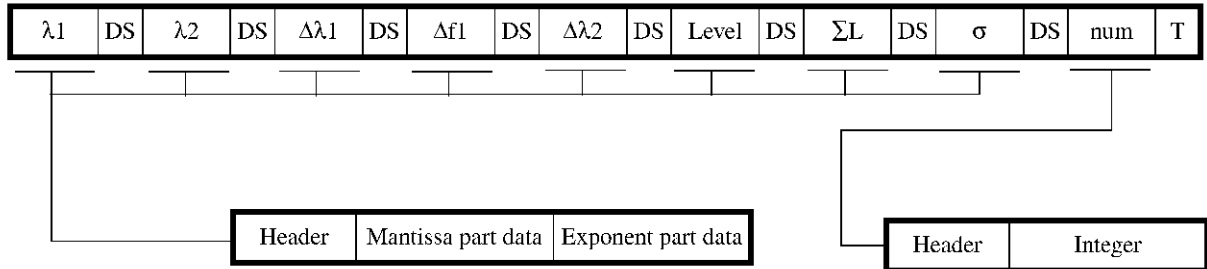

Header	Data type
LMCN	Mean Wavelength (wavelength λ_1)
FQCN	Mean Wavelength (frequency f_1)
LMPK	Peak wavelength (λ_2)
FQPK	Peak frequency (f_2)
LMSP	Mode wavelength span ($\Delta\lambda_1$)
FMSP	Mode frequency span (Δf_1)
LMHW	Half power bandwidth wavelength ($\Delta\lambda_2$)
FQHW	Half power bandwidth frequency (Δf_2)
LVPK	Peak level value (Level)
TTPW	Total Power (ΣL)
STDV	Standard deviation (σ)
NOSP	Number of modes (num)

4.5 Talker Formats (Data Output Formats)

(15) GPIB output format for the LED calculation result ("OLE")

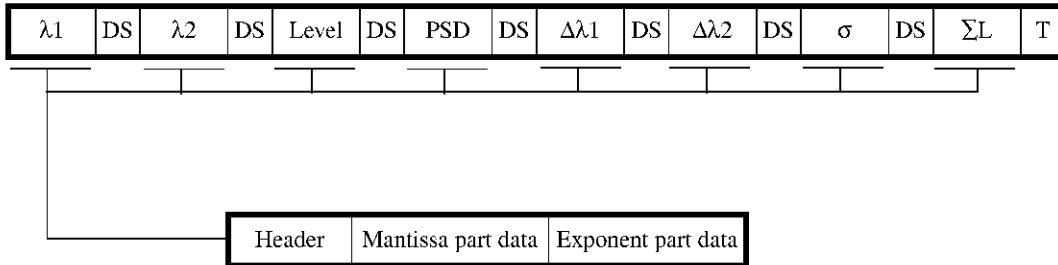

Header	Data type
LMCN	Mean Wavelength (wavelength λ_1)
FQCN	Mean Wavelength (frequency f1)
LMPK	Peak wavelength (λ_2)
FQPK	Peak frequency (f2)
LVPK	Peak level value (Level)
LDPK	Peak power density (PSD)
LMHW	Half power bandwidth wavelength ($\Delta\lambda_1$)
FQHW	Half power bandwidth frequency (Δf_1)
LMDW	3dB Threshold Width (wavelength $\Delta\lambda_2$)
FQDW	3dB Threshold Width (frequency Δf_2)
STDV	Standard deviation (σ)
TTPW	Total Power (ΣL)

(16) GPIB output format for the ACPR calculation result ("OAC")

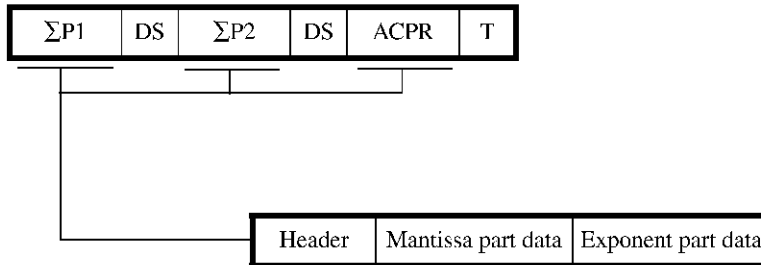

Header	Data type
SGPW	Signal Power ($\Sigma P1$)
LKPW	Leakage Power ($\Sigma P2$)
ACPR	ACPR

(17) Device identification

When program code "*IDN?" is received, the following data is output:

ADVANTEST, Q8384, 123456789, B00 A00

----- Software revision
 (Processing, Measurement)
 ----- Serial number (Production number)

4.5 Talker Formats (Data Output Formats)

(18) Setting condition data

The current setting state can be read by using “?” instead of setting data if the code is readable.

The setting state is output in the following format:

Header	Data	T
--------	------	---

- Integer
 APC, RAU, LIN, LEV, SWE, CUR, XAC, XBC, YAC, YBC, CUD, MEA, DUA, SIM, GRI, AUL, PNR, LOS, TRA, SPW, WTY, PMO, OAM, NFT, FTM, SDV, NPK, WDM, WAU, DEV, FON, BUZ, WAR, QUI, CKD, MEN, SRQ, HED, DEL, SDL, MSP, FMT, OVS, MNH, MXH, AUT, AVM, SYN, EGE, NWD, OMD, WMD, EPM, CPT, BSV, BCP, FFO, PRT, OSD, SPT, SNE, FRQ, ASP, MTE, NPK, SRS, WAL, LTM, LSD, LHA, LVA, LAR, LDA, LTF, EKB, AVG, SMN, AVS, MMX, MCU, MSK, LMT, LCT, LCC, WRF, PNX, BPF, RPL, SWL, ISP, ISS, FTL, DFB, FPL, LED, ACP, SMD, WSW, WSL, WSS, APF

- Mantissa part data + Exponent part data
 CEN, SPA, STA, STO, REF, PGT, XAS, XBS, YAS, YBS, WPX, WPY, WPK, WPR, PIN, NFK, SNA, SNB, FDL, LPL, LPO, PLV, PLW, WYD, RES, DLY, NLV, NWI, CLE, WPW, CLF, CLS, LTI, LSC, GRF, GSP, SCR, LFD, LNL, LLL, LNS, LSL, MAL, PBT, HBT, SBT, SAP, SAS, SRW, STW, PKX, SFX, SFY, OPM

- Others
 LAB: 1 to 48 characters
 CLO: YY-MM-DD, hh:mm:ss
 SAV, DMD, RCL: 1 to 11 characters

Same as the functional header specified.

4.6 Device Triggering Function

This analyzer system performs a SINGLE measurement operation similar to the case in which it receives the program codes "MEA1," "E" and "*TRG" through the address specification command 'GET' (Group Execute Trigger).

4.7 Device Clear Function

This analyzer system is set to the initial state when turning the power on, similar to the case in which it receives the program codes "C" and "*RST" through the address specification command 'SDC' (Selected Device Clear) and the universal command 'DCL' (Device CLear).

The initial state after turning the power on is shown in Table 4-2.

Table 4-2 Initial State After Turning the Power On

Item	Initial state
1. Measurement conditions (FUNCTION section)	Previous state
2. Data display	Normal display (Dual screen, superimposing and list display are all OFF).
3. Cursor display	All are OFF.
4. Half width calculation	OFF
5. GPIB-related Status byte Masking status bytes Transmission of SRQ signal Output format of waveform data Terminator Data separator	0 (Clear) "MSK0" (No mask) "SRQ0" (Mode in which the SQR signal is not sent) "FMT0" (ASCII) "DEL0" (DL0) ⇒(NL<EOI>) "SDL0" (DS0) ⇒(,)

4.8 State Changes According to the Commands

4.8 State Changes According to the Commands

This analyzer system will be in the states listed in Table 4-3 after turning the power on and receiving the various commands.

Table 4-3 State Changes According to the Commands

Command code	Talker	Listener	Remote	SRQ	Status byte	Transferred data	Parameters and Operation State
POWER ON	Clear	Clear	Local	Clear	Clear	Clear	Partial initialization
IFC	Clear	Clear	-	-	-	-	-
DCL	-	-	-	Clear	Clear	Clear	Partial initialization
SDC	Clear	Set	-	Clear	Clear	Clear	Partial initialization
C, *RST	Clear	Set	Remote	Clear	Clear	Clear	Partial initialization
IPR	Clear	Set	Remote	Clear	Clear	Clear	Initialization
GET	Clear	Set	-	=	Clear b0, 2, 3 and 5	Clear	-
E, *TRG	Clear	Set	Remote	=	Clear b0, 2, 3 and 5	Clear	-
Specifying the talker for this analyzer system.	Set	Clear	-	-	-	-	-
Command for turning the talker off.	Clear	-	-	-	-	-	-
Specifying the listener for this analyzer system.	Clear	Set	-	-	-	-	-
Command for turning the listener off.	-	Clear	-	-	-	-	-
Serial polling	Set	Clear	-	Clear	-	-	-

-: Indicates that the previous state does not change.

=: Indicates indefinite state

DCL: Device Clear

SDC: Selected Device Clear

GET: Group Execute Trigger

4.9 Status Byte

The functions of each bit in the status byte (used for this analyzer system) are shown below.

b7	b6	b5	b4	b3	b2	b1	b0
----	----	----	----	----	----	----	----

- b0: measure end
Set to 1 at the end of calibration and alignment.
Set to 0 upon starting the next measurement.
- b1: syntax error
Set to 1 if there are any grammatical/setting errors in the received program codes.
Set to 0 upon receiving the next program codes.
- b2: calculation end
Set to 1 at the end of half width calculation.
Set to 0 upon starting a measurement.
- b3: copy end or floppy access end
Set to 1 at the end of printer output or access to the floppy disk (writing, reading or initialization).
Set to 0 upon starting a measurement, receiving an "COP" code.
- b4: trend end
Set to 1 when one trend chart measurement is completed on the power monitor display.
Set to 0 when the next trend measurement is started.
- b6: RQS
Is the bit that indicates that it is issuing a service request and Set to 1 if any of bits b0 to b5 and b7 is 1.
Set to 0 if all bits are 0.
- b7: self-test error
Set to 1 if any abnormality occurs while performing the self-test function.
Set to 1 when a calibration or alignment is abnormally terminated.

4.10 GPIB Command Codes

4.10 GPIB Command Codes

The following tables list the GPIB commands by function.

- Listener Code Column: An asterisk (*) in the Listener Code Column indicates that the function requires numeric data together with the function code.

Table 4-4 FUNCTION (1 of 2)

	Function	Header	Query	Contents
CENTER	CENTER	CEN *	CEN?	Unit When the horizontal axis is set to wavelength UM: μm (default setting), NM: nm When the horizontal axis is set to frequency THZ: THz (default setting), GHZ: GHz
	PEAK	PKC	-	peak to center
	CURSOR	CUC	-	cursor to center
	AUTO PKC	APC *	APC?	Auto Peak Center 0:OFF,1:ON
SPAN	SPAN	SPA *	SPA?	Unit When the horizontal axis is set to wavelength UM: μm (default setting), NMD: nm/DIV When the horizontal axis is set to frequency THZ: THz (default setting), GHZ: GHz THZD:THz/DIV, GHZD:GHz/DIV Example: SPA12.3NM
	START	STA *	STA?	Unit When the horizontal axis is set to wavelength UM: μm (default setting), NM: nm When the horizontal axis is set to frequency THZ: THz (default setting), GHZ: GHz
	STOP	STO *	STO?	Unit When the horizontal axis is set to wavelength UM: μm (default setting), NM: nm When the horizontal axis is set to frequency THZ: THz (default setting), GHZ: GHz
	Cursor SPAN	LSP	-	$\lambda_1 \Leftrightarrow \lambda_2$ set to span
	FULL	FSP	-	FULL SPAN 0.6 to 1.70 μm (setting wavelength 176.349 to 499.654 THz)
	Wavelength/Frequency	FRQ *	FRQ?	Setting the horizontal axis 0: Wavelength, 1: Frequency

Table 4-4 FUNCTION (2 of 2)

	Function	Header	Query	Contents
REF LEVEL	REF LEVEL	REF *	REF?	Unit DBM: dBm (default setting), MW: mW, UW: μ W, NW: nW
	PEAK	PKL	-	ref-level set to peak
	CURSOR	CUL	-	ref-level set to cursor
	MAX HOLD→CURRENT	MXC	-	Specifying the waveform in MAX HOLD for the current waveform.
	MIN HOLD→CURRENT	MNC	-	Specifying the waveform in MIN HOLD for the current waveform.
	MAX HOLD	MXH *	MXH?	0: OFF, 1: ON
	MIN HOLD	MNH *	MNH?	0: OFF, 1: ON
	AUTO	RAU *	RAU?	0: OFF, 1: ON
LEVEL SCALE	LEVEL SCALE	LEV *	LEV?	-1: other, 0: 10dB/D, 1: 5dB/D, 2: 2dB/V, 3: 1dB/D, 4: 0.5dB/D, 5: 0.2dB/D, 6: 0.1dB/D
		LSC *	LSC?	Setting range: 0.1 to 10
	LIN/LOG	LIN *	LIN?	0: LOG, 1: LINEAR
AUTO	AUTO	AUT *	-	0: ABORT (STOP), 1, 2, 3: START
AVERAGE	POINT AVERAGE	AVG *	AVG?	Setting range: 1 (OFF) to 64
	SWEEP AVERAGE	AVS *	AVS?	Setting range: 1 (OFF) to 64
	SMOOTHING	SMN *	SMN?	Setting range: 1 (OFF), 3, 5, 7, 9, 11
SWEEP MODE	SWEEP MODE	SWE *	SWE?	0: NORMAL, 1: ADAPTIVE, 2: HI-SENS1, 3: HI-SENS2, 4: PULSE, 5: HI-DYNAMIC1, 6: HI-DYNAMIC2
	GateTime	PGT *	PGT?	Unit SEC: sec (default setting), MSEC: msec
	SYNC	SYN *	SYN?	0: LOW, 1: HI
	DELAY	DLY *	DLY?	Sync HI Delay Time[μ sec], 0 to 1000
	EDGE	EGE *	EGE?	0: RISE, 1: FALL
RESOLUTION		RES *	RES?	Unit UM: μ m, NM:nm (default setting)

4.10 GPIB Command Codes

Table 4-5 CURSOR

Function		Header	Query	Contents
CURSOR ON/OFF		CUR *	CUR?	0: CURSOR OFF, 1: CURSOR ON
λ1	ON/OFF	XAC *	XAC?	0: λ1 OFF, 1: λ1 ON
	SET λ1	XAS *	XAS?	When the horizontal axis is set to the wavelength: UM: μm (Default), NM: nm When the horizontal axis is set to frequency: THZ: THz (Default), GHZ:GHz
λ2	ON/OFF	XBC *	XBC?	0: λ2 OFF, 1: λ2 ON
	SET λ2	XBS *	XBS?	When the horizontal axis is set to the wavelength: UM: μm (Default), NM: nm When the horizontal axis is set to frequency: THZ: THz (Default), GHZ:GHz
L1	ON/OFF	YAC *	YAC?	0: L1 OFF, 1: L1 ON
	SET L1	YAS *	YAS?	Unit DBM: dBm, DB: dB, MW: mW, UW: μW, NW: nW, PC: %
L2	ON/OFF	YBC *	YBC?	0: L2 OFF, 1: L2 ON
	SET L2	YBS *	YBS?	Unit DBM: dBm, DB: dB, MW: mW, UW: μW, NW: nW, PC: %
CURSOR DATA		CUD *	CUD?	0: NORMAL, 1: ΔMODE, 2: 2nd PEAK, 3: POWER, 4: PEAK TO PEAK
LEFT PEAK		LPS	-	λ1 set next left peak
RIGHT PEAK		RPS	-	λ1 set next right peak

Table 4-6 LABEL

Function	Header	Query	Contents
LABEL	LAB#string#	LAB?	Up to 48 characters Example:LAB#ABC-890#

Table 4-7 MEASURE

Function	Header	Query	Contents
MEASURE	MEA *	MEA?	0: STOP, 1: SINGLE, 2: REPEAT

Table 4-8 DISPLAY (1 of 7)

	Function	Header	Query	Contents
CONTROL	DUAL	DUA *	DUA?	0: OFF, 1: ON (Dual-screen)
	SUPER IMPOSE	SIM *	SIM?	0: OFF, 1: ON (Super-impose)
	GRID	GRI *	GRI?	0: OFF, 1: ON
	act.U&L	AUL *	AUL?	0: Upper screen active, 1: Both upper and lower screens active
	xcng U/L	XUL	-	Switches between the upper and lower screens
	Sampling Point	SPT *	SPT?	0: 101, 1: 201, 2: 501, 3: 1001, 4: 2001, 5: 5001, 6:10001
	AUTO SAMPLE	ASP *	ASP?	0: OFF, 1: ON
CONTROL (MULTI TRACE)	MULTI TRACE ON/OFF	MTE *	MTE?	0: OFF, 1: ON
	TRACE MAX	MMX *	MMX?	Setting the maximum number of traces, Range: 1 to 32
	NEXT TRACE	MNT	-	Selecting the next trace number.
	PREVIOUS TRACE	MPT	-	Selecting the previous trace number.
	CURRENT TRACE SET	MCU *	MCU	Selecting a trace number, Range: 1 to MMX
	AUTO TRACE INCREMENT	MAT *	MAT	0: OFF, 1: ON
	DELETE CURRENT TRACE	MDC	-	Clearing the waveform data of the current trace number.
	DELETE ALL TRACE	MDA	-	Clearing all waveform data.
SAVE	SAVE MEAS DATA	SAV#file name#	-	#REF#: Saves into memory as reference data. #MEAS1#: Saves into memory MEAS1. #MEAS2#: Saves into memory MEAS2. #MEAS3#: Saves into memory MEAS3. #file name#: Saves into memory or FD. Example:SAV#LD123#
	DELETE MEAS	DMD#file name#	-	#file name#: Deletes data into memory or FD. Example:DMD#1550LD.SPE#

4.10 GPIB Command Codes

Table 4-8 DISPLAY (2 of 7)

Function		Header	Query	Contents
RECALL	RECALL MEAS	RCL#file name#	-	#REF#: Recalls data from the reference data memory. #MEAS1#: Recalls data from MEAS1. #MEAS2#: Recalls data from MEAS2. #MEAS3#: Recalls data from MEAS3. #file name#: Recalls data from memory or FD. Example:RCL#MEAS1#
PEAK NORMALIZE		PNR *	PNR?	0: OFF, 1: ON (Peak normalize)
LOSS		LOS *	LOS?	0: OFF, 1: ON
TRANS		TRA *	TRA?	0: OFF, 1: ON
CUR+MEAS1→CURRENT		PLM	-	CURRENT results in the sum of the current waveform and memory MEAS1 data.
CUR-MEAS1→CURRENT		MIM	-	CURRENT results in the remainder taking MEAS1 data from the current wave.
ADVANCE (PEAK POWER MONITOR)	PEAK POWER MONITOR ON/OFF	PMO *	PMO?	0: OFF (Spectrum), 1: ON (Power Monitor)
	PEAK POWER MONITOR N-MAX	PNX *	PNX?	Integer (11 to 1001) Point of trend-chart
	PEAK POWER MONITOR INTERVAL	PIN *	PIN?	Numeric (0.5 to 3600) Measurement interval of power monitor [sec]
ADVANCE (LIMIT LINE)	PATTERN SELECT	LPT *	LPT?	Selecting LIMIT LINE ON/OFF and the pattern file. 0: LIMIT LINE OFF 1 to 5: Selecting a pattern file 1 to 5.
	LOAD PATTERN FILES	LPR	-	Loading a pattern file from a floppy disk.
	Auto Pass/Fail ON/OFF	APF *	APF?	0: OFF, 1: ON
	Shift X	SFX *	SFX?	Setting range:-1100 to 1100 (nm) -500 to 500 (THz)
	Shift Y	SFY *	SFY?	Setting range: -220 to 220 (dB)

Table 4-8 DISPLAY (3 of 7)

	Function	Header	Query	Contents
APPLICATION (SPEC. WIDTH)	SPEC. WIDTH	SPW *	SPW?	0:OFF, 1:ON
	WIDTH TYPE	WTY *	WTY?	0:Pk-XdB, 1:Envelope, 2:RMS, 3:Peak RMS, 4:Xnm Level
	THRESHOLD LVL1	WPX *	WPX?	Setting range: -59.9 to 59.9
	THRESHOLD LVL2	WPY *	WPY?	Setting range: 0.1 to 99.9
	K parameter	WPK *	WPK?	K parameter setting (used for WTY2 and 3) Setting range: 0.1 to 100
	Kr(RMS) param	WPR *	WPR?	Setting range: 1 to 10
	Xnm Level	WPW *	WPW?	Unit UM;μm, NM:nm (default setting)
(NOTCH WIDTH)	Notch Width	NWD *	NWD?	0:OFF, 1:XdB Width, 2:Xnm Level
	XdB Width(Notch)	NLV *	NLV?	Setting range: -59.9 to 59.9
	Xnm Level(Notch)	NWI *	NWI?	Unit UM;μm, NM:nm (default setting)
(OPT AMP)	Optical Amp ON/OFF	OAM *	OAM?	0:OFF, 1:ON
	Optical AMP Mode	OMD *	OMD?	0:Single, 1:WDM
	NF(s-sp) or NF(total)	NFT *	NFT?	0:NF (s-sp), 1:NF (total)
	Spectrum Division	SDV *	SDV?	0:OFF, 1:ON
	K parameter (OPT AMP)	NFK *	NFK?	K parameter setting Setting range: 0.1 to 100
	Filter $\Delta\lambda$	FDL *	FDL?	Unit UM;μm, NM:nm (default setting)
	Pin LOSS	LPI *	LPI?	Measuring system input loss setting (-10 to +10)
	Pout LOSS	LPO *	LPO?	Measuring system output loss setting (-10 to +10)
	Select Pin	NPK *	NPK?	0: OFF (displayed data or REF data) 1: ON (set using PLV)
	Select Level	PLV *	PLV?	Setting the input level used for NPK1, Unit DBM:dBm (as the initial value), MW:mW, UW: μW, NW: nW
	Set Pin Wavelength	PLW *	PLW?	Setting the center wavelength used for NPK1, Unit UM: μm, NM: nm (as the initial value)

4.10 GPIB Command Codes

Table 4-8 DISPLAY (4 of 7)

	Function	Header	Query	Contents
(WDM LIST)	WDM LIST ON/OFF	WDM *	WDM?	0:OFF, 1:ON
	WDM Mode	WMD *	WMD?	0:Multi Peak, 1:SNR, 2:Relative, 3:ITU GRID
	WDM Ref CH	WRF *	WRF?	Setting the reference channel number in the WDM list function.
	GRID Ref Frequency	GRF *	GRF?	WMD3 reference frequency setting Unit THZ:THz (default setting), GHZ:GHz
	GRID CH Spacing	GSP *	GSP?	WMD3 CH spacing frequency setting Unit THZ:THz, GHZ:GHz (default setting)
	ASE NBW	SRS *	SRS?	Sets whether the current or calculated value is used for the WMD1 ASE level. 0:Current, 1:Conversion
	ASE Converted NBW	SCR *	SCR?	SRS1 wavelength resolution setting using the calculated value Unit UM; μ m, NM:nm (default setting)
	LIST ALL	WAL *	WAL?	0: OFF, 1: ON
	Signal Power Mode	SMD *	SMD?	0: Peak, 1: Σ Power
(WDM MONITOR)	WDM MONIT ON/OFF	LTM *	LTM?	0: OFF, 1: ON
	SPECTRUM display	LSD *	LSD?	0: OFF, 1: ON
	GRAPH X	LHA *	LHA?	0: Time, 1: CH No.
	DATA MODE	LVA *	LVA?	0: Wavelength/Frequency, 1: Level, 2: SNR
	ABSOLUTE/RELATIVE	LAR *	LAR?	0: Absolute value, 1: Relative value to the initial value, 2: Relative value to the nominal value
	Graph All Data	LDA *	LDA?	0: OFF, 1: ON
	Current Time No.	LCT *	LCT?	Setting the reference time number. Example: LCT101
	Current Channel No.	LCC *	LCC?	Setting the reference channel number, Example: LCC256
	Measurement Times	LMT *	LMT?	Number of measurements (1 to 501)
	Time Interval	LTI *	LTI?	Measurement interval [Min] (0.1 to 1440), Example: LT160
	Pass/Fail Enable	LTF *	LTF?	0: OFF, 1: ON

Table 4-8 DISPLAY (5 of 7)

Function	Header	Query	Contents	
(WDM MONI-TOR)	λ Drift Lmt.	LFD *	LFD?	Drift limit wavelength from ITU GRID when LTF1 is set to 1, Unit UM: μ m, NM: nm (as the initial value)
	Nominal Level	LNL *	LNL?	Reference power level when LAR2, Unit DBM: dBm (as the initial value), MW:mW, UW: μ W, NW: nW
	Level Upper Lmt.	LUL *	LUL?	Maximum power limit when LTF1, Unit DBM: dBm (as the initial value), MW:mW, UW: μ W, NW: nW
	Level Lower Lmt.	LLL *	LLL?	Minimum power limit when LTF1, Unit DBM: dBm (as the initial value), MW:mW, UW: μ W, NW: nW
	Nominal SNR	LNS *	LNS?	Reference SNR value [dB] when LAR2, Range: 0 to 60
	SNR Lower Lmt.	LSL *	LSL?	Minimum SNR limit value [dB] when LTF1 is set to 1, Range: 0 to 60
	SCALE (λ .f)	WSW *	WSW?	0: 2.0nm/D, 1: 1.0nm/D, 2: 0.5nm/D, 3: 0.2nm/D, 4: 0.1nm/D
	SCALE (LEVEL)	WSL *	WSL?	0: 10dB/D, 1: 5dB/D, 2: 2dB/D, 3: 1dB/D, 4: 0.5dB/D
	SCALE (SNR)	WSS *	WSS?	0: 10dB/D, 1: 5dB/D, 2: 2dB/D, 3: 1dB/D, 4: 0.5dB/D

4.10 GPIB Command Codes

Table 4-8 DISPLAY (6 of 7)

	Function	Header	Query	Contents
(OPT AMP, WDM LIST, WDM MONI- TOR)	WDM THRESHOLD LEVEL	WYD *	WYD?	Threshold level (from the peak) setting used to detect the WDM signal Setting range: 0.1 to 99.9
	WDM ASE Method	WAU *	WAU?	ASE automatic detection function when set to OMD1 or WDM1. 0:AUTO OFF, 1:AUTO ON
	ASE Fitting	FTM *	FTM?	Selecting an interpolation curve when not set to ASE AUTO. 0:GAUSS,1:FIT MEM3, 2:Manual ASE
	Manual ASE Level	MAL *	MAL?	ASE level setting for FTM2 Unit DBM:dBm (default setting), MW:mW, UW:μW, NW:nW
	Masked SPAN	SNA *	SNA?	Setting ASE interpolation range "A" for FTM 0 and FTM 1 Unit UM;μm, NM:nm (default setting)
	Fitting SPAN	SNB *	SNB?	Setting ASE interpolation range "B" for FTM 0 and FTM 1 Unit UM;μm, NM:nm (default setting)
	Peak Excursion	PKX *	PKX?	Setting range: 0 to 100.0
(O-BPF)	O-BPF ON/OFF	BPF *	BPF?	0: OFF, 1: ON
	Pass Band Threshold	PBT *	PBT?	Setting range: 0.1 to 99.9
	Half Band Threshold	HBT *	HBT?	Setting range: 0.1 to 99.9
	Stop Band Threshold	SBT *	SBT?	Setting range: 0.1 to 99.9
	Ripple Select	RPL *	RPL?	0: max-min, 1: ripple, 2: search area
	GRID Ref Frequency	GRF *	GRF?	SWL3 reference frequency setting Unit THZ:THz (default setting) Unit THZ: THz (default setting), GHZ: GHz
	GRID CH Spacing	GSP *	GSP?	SWL3 CH spacing frequency setting Unit THZ: THz, GHZ: GHz (default setting)
	Search Area Pass	SAP *	SAP?	Setting range: 0 to 10.0
	Search Area Stop	SAS *	SAS?	Setting range: 0 to 10.0
	Std Wavelength	SWL *	SWL?	0: peak, 1: pass_center, 2: half_center, 3: GRID
	Isolation Pass	ISP *	ISP?	0: max, 1: min, 2: avg
	Isolation Stop	ISS *	ISS?	0: max, 1: min, 2: avg

Table 4-8 DISPLAY (7 of 7)

	Function	Header	Query	Contents
(FILTER TILT)	Filter Tilt ON/OFF	FTL *	FTL?	0: OFF, 1: ON
	Start Wavelength	SRW *	SRW?	Unit When the horizontal axis is set to wavelength, UM: μm (default setting), NM: nm When the horizontal axis is set to frequency, THZ: THz (default setting), GHZ: GHz
	Stop Wavelength	STW *	STW?	Unit When the horizontal axis is set to wavelength, UM: μm (default setting), NM: nm When the horizontal axis is set to frequency, THZ: THz (default setting), GHZ: GHz
(DFB-LD)	DFB-LD ON/OFF	DFB *	DFB?	0: OFF, 1: ON
	Threshold Level 1	WPX *	WPX?	Setting range: -59.9 to 59.9
	Peak Excursion	PKX *	PKX?	Setting range: 0 to 100.0
(FP-LD)	FP-LD ON/OFF	FPL *	FPL?	0: OFF, 1: ON
	Threshold Level 2	WPY *	WPY?	Setting range: 0.1 to 99.9
(LED)	LED ON/OFF	LED *	LED?	0: OFF, 1: ON
(ACPR)	ACPR ON/OFF	ACP *	ACP?	0: OFF, 1: ON
	GRID Ref Frequency	GRF *	GRF?	Unit THZ:THz (default setting), GHZ: GHz
	GRID CH Spacing	GSP *	GSP?	Unit THZ:THz, GHZ:GHz (default setting)

4.10 GPIB Command Codes

Table 4-9 DATA OUT

Function		Header	Query	Contents
DEVICE	DEVICE TYPE	DEV *	DEV?	0: Internal printer, 1: External printer, 2: Floppy disk
	FLOPPY ON/OFF	FON *	FON?	0: FLOPPY-OFF(MEMORY), 1: FLOPPY-ON
	FLOPPY FORMATTING	FFO *	-	1: 2DD(720K), 2: 2HD(1.44M)
	Bitmap Compless	BCP *	BCP?	0: Compress OFF, 1: Compress ON
	Bitmap Save	BSV *	BSV?	0: B&W, 1: Gray, 2: Color Bitmap
	EXT KEY	EKB *	EKB?	External keyboard settings 0: US, 1: JP
	Color Pattern	CPT *	CPT?	0 to 4 Selecting color patterns
	Ext. PRT MODE	EPM *	EPM?	0: GRAY, 1:B&W-S, 2: B&W-L
	Ext. PRT COMMAND	PRT *	PRT?	0: ESC/P, 1: ESC/P RAS, 2: HP PCL
	BUZZER(BEEP)	BUZ *	BUZ?	0: OFF, 1: ON
	WARNING	WAR *	WAR?	0: OFF, 1: ON
	QUIET BEEP	QUI *	QUI?	0: NORMAL, 1: QUIET
	CLOCK	CLO #YY-MM-DD,hh:mm:ss//	CLO?	-
	CLOCK ON/OFF	CKD *	CKD?	0: OFF, 1: ON
	MENU OUT(printer)	MEN *	MEN?	0: OFF, 1: ON
COPY		COP	-	Start outputting to selecting device by DEVICE TYPE
FEED		FEE	-	Paper fed about 5 mm to printer. (Internal printer)

Table 4-10 Codes Corresponding to Other Keys

Function		Header	Query	Contents
INSTR PRESET		IPR	-	Measurement conditions initialized.
CAL	CAL λ (Int.)	CLM	-	
	CAL λ (Ext.)	CLE *	CLE?	Unit UM: μ m, NM:nm(default setting)
	λ OFFSET	CLF *	CLF?	Unit UM: μ m, NM:nm(default setting)
	LEVEL OFFSET	CLS *	CLS?	Unit DB:dB(default setting)
	AUTO ALIGNMENT	ALM	-	-

Table 4-11 Controlling Data Output and Others (1 of 3)

Function	Header	Query	Contents
SRQ signal control-1	SRQ *	SRQ?	0: Mode not transmitting SRQ, 1: Mode transmitting SRQ
SRQ signal control-2	S *	S?	0: Mode transmitting SRQ, 1: Mode not transmitting SRQ
Status byte mask	MSK *	MSK?	0 to 255 (Bit 6 can not be masked.) Status byte bit "1" to be masked switched on. (Initial value: 0)
Status byte clear	CSB	-	
Header data output control	HED(HD) *	HED?	0: HEADER OFF, 1: HEADER ON
Terminator	DEL(DL) *	DEL?	0: NL<EOI>, 1: NL, 2: <EOI>, 3: CR NL<EOI>
Data separator	SDL(DS) *	SDL?	0: ,(comma), 1: SP(space), 2: CR NL
Message separator	MSP(MS) *	MSP?	0: ;(semicolon), 1: CR NL
Data output format (valid for waveform data)	FMT *	FMT?	0: ASCII, 1: BINARY(16bit), 2: BINARY(64bit float), 3: BINARY(32bit float)
Data output screen	OVS *	OVS?	0: upper(upper screen), 1: lower(lower screen)
Request for waveform data output	OSD *	-	0: Y-axis data output, 1: X-axis data output, 2: Outputs Y-axis data for MIN HOLD, 3: Outputs Y-axis data for MAX HOLD
Request for output of the number of waveform data	ODN	ODN?	Output of the number of data contained on the screen specified by OVSn or trend-chart
Request for peak search data output	OPK	OPK?	-

4.10 GPIB Command Codes

Table 4-11 Controlling Data Output and Others (2 of 3)

Function	Header	Query	Contents
Request for cursor data output	OCD	OCD?	Output data differs depending on cursor display mode.
Request for spectral width data output	OSW	OSW?	Output of the spectral width calculated
Output of notch width data	ONW	ONW?	Output of the notch width calculated
Request for operation result of gain and noise figure	OGN	OGN?	Output of gain and noise figure calculated.
Request for power monitor data output	OPM	OPM?	Output of point data measured by power monitor
Request for outputting operation results of gain, noise figure and total ASE power	OPN	OPN?	Output of gain, noise figure and total ASE power calculated.
WDM PEAK NO	OWP	OWP?	Number of WDM signal lights that have been measured using the NF command.
Request for outputting number of list data	OLN	OLN?	Number of optical signals in the WDM list
Request for outputting operation results of WDM	OLS	OLS?	Request to output data consisting of Multi Peak, SNR and Relative ITV GRID that have been selected using NF data (obtained from WDM operation) or WDM LIST operation.
Request for WDM gain noise in real type	OWN	OWN?	Adding Pout output to OLS.
Request for outputting start point at the X axis of the ASE fitted data	PAS	PAS?	Output of start point at the X axis of the ASE fitted data in gain or WDM operation.
Request for outputting the number of ASE fitted data	PAN	PAN?	Output of the number of ASE fitted data in gain or WDM operation.
Request for outputting ASE fitted data	OPA	OPA?	Output of ASE fitted data in gain or WDM operation
Request for output of the WDM peak information	OLM	OLM?	Outputs information for the Multi Peak, SNR, and Relative data selected in the WDM LIST.
Request for data from the WDM monitor	OLT*	-	Outputs the nth time data for each channel using OLTn.
Outputs the number of WDM MONITOR time data sets	ONT	ONT?	
Request for LIMIT judgment results of the WDM monitor function	LRS	LRS?	0: FAIL 1: PASS
Request for LIMIT judgment results of the LIMIT LINE function	LPF	LPF?	0: FAIL 1: PASS

Table 4-11 Controlling Data Output and Others (3 of 3)

Function	Header	Query	Contents
Request for output of the O-BPF calculation result.	OBP	OBP?	Outputs information of the calculated analysis result.
Request for output of the Filter Tilt calculation result.	OFT	OFT?	Outputs information of the calculated analysis result.
Request for output of the DFB-LD calculation result.	ODF	ODF?	Outputs information of the calculated analysis result.
Request for output of the FP-LD calculation result.	OFD	OFD?	Outputs information of the calculated analysis result.
Request for output of the LED calculation result.	OLE	OLE?	Outputs information of the calculated analysis result.
Request for output of the ACPR calculation result.	OAC	OAC?	Outputs information of the calculated analysis result.
Single measurement	E(*TRG)	-	Code identical to "MEA1" Single measurement executed
Initialization	C(*RST)	-	Resets the parameter values to the factory defaults.
Device identification	-	*IDN?	Request to output company name, device name, serial number and software revision.
Execution of self-diagnosis and output of results.	*TST	*TST?	Request to execute the self-diagnosis and output the results.

Table 4-12 Error Codes Associated with the Self-diagnosis Function

Code	Description
0000	Normal
XXX1	Decimal place: Analysis board error
XX1X	Tens place: Backup RAM error
X1XX	Hundreds place: Measurement error
1XXX	Thousands place: Error in the optional light source for calibration

4.11 Example Programs

4.11 Example Programs

This section describes remote control examples used with GPIB port.

4.11.1 Sample Programs for Setting or Reading Measurement Conditions

CAUTION: *Visual Basic 4.0 (referred to as VB henceforth) is used in the sample programs shown here. Also, National Instruments-made GPIB board (referred to as NI-made for brevity henceforth) is used for the GPIB control board; NI-made driver is used for the control driver.*

- Program examples using VB

Example VB-1: Setting the center wavelength after performing an analyzer master reset

```

Call ioclr(spa) 'Performs a Device Clear.

Call iowrt(spa,"C") 'Preset
Call iowrt(spa,"CEN1550nm") 'Set the center wavelength to 1550 nm.
Call iowrt(spa,"SPA20nm") 'Set the span to 20 nm.
    
```

Example VB-2: After the center wavelength, span and so on have been set, the peak wavelength and level are read. (SRQ is used.)

```

Dim boardID As Integer
Dim res As Integer
Dim Peak_lambda#, Peak_Level#

boardID = 0

Call ioclr(spa) 'Performs a Device Clear.

Call iowrt(spa,"C") 'Preset
Call iowrt(spa,"CEN1550nm,SPA20nm") 'Set the center wavelength to 1550 nm and the span to 20 nm.
Call iowrt(spa,"REF0dBm") 'Set the reference level to 0 dBm.
Call iowrt(spa,"LIN0,LEV0") 'Set the LOG display to 10 dB/DIV.
Call iowrt(spa,"SWR",RES0.1nm") 'Set the sweep mode to ADAPTIVE and the resolution to 0.1 nm.
Call iowrt(spa,"MSK254") 'Enable measurement-end of status byte (b0)
Call iowrt(spa,"SRQ") 'Enable SRQ interrupt
Call iowrt(spa,"MTA") 'Start single measurement

Call iowait(spa,RQS Or TTMO) 'Waiting for SRQ interrupt
Call iorsp(spa,res) 'Read the status byte

Call iowrt(spa,"DEL0,SDL2,HEDC") 'Set the delimiter and the output header to OFF
Call iowrt(spa,"OPK") 'Output of peak search data is requested.

Rebuff = Space(15) 'Allocate a maximum of 15 bytes, including delimiters.
Call iord(spa,Rdbuff) 'Read the peak search data (wavelength).
Peak_lambda = Val(Rdbuff) 'Convert ASCII format into numeric values.
Rebuff = Space(12) 'Allocate a maximum of 12 bytes, including delimiters.
Call iord(spa,Rdbuff) 'Read the peak search data (level).
Peak_Level = Val(Rdbuff) 'Convert ASCII format into numeric values.
    
```

Example VB-3: Center wavelength and span are set for spectrum analysis and peak wavelength and level are read. (SRQ is not used.)

```

Dim res As Integer

Call ioclr(spa) 'Performs a Device Clear.

Call iowrt(spa, "C") 'Preset
Call iowrt(spa, "STA1220nm, SPT1400nm") 'Set the center wavelength to 1220 nm and the stop wavelength to
1400 nm.
Call iowrt(spa, "REF0.1mW") 'Set the reference level to 0.1 mW.
Call iowrt(spa, "SWE2, RES0.5nm") 'Set the sweep mode to HI-SENS1 and the resolution to 0.5 nm.
Call iowrt(spa, "AVG2") 'Averaging is set to 2.
Call iowrt(spa, "MSK254") 'Enable measurement-end of status byte (b0)
Call iowrt(spa, "CSB") 'Clear the status byte.
Call iowrt(spa, "MEAL") 'Start single measurement.
Do
    Call iobrsp(spa, res) 'Read the status byte.
    DoEvnt. 'Check for other events occurring in the loop.
Loop Until (res AND 1) 'Exit from the loop if the measurement end bit is set.

Call iowrt(spa, "DFT0, SDF2, ITD0") 'Set the delimiter and the output header to OFF
Call iowrt(spa, "OPK") 'Output of peak search data is requested.

Rdbuf1 = Space(15) 'Allocate a maximum of 15 bytes, including delimiters.
Call iord(spa, Rdbuf1) 'Read the peak search data (wavelength).
Peak_Lambda = Val(Rdbuf1) 'Convert ASCII format into numeric values.
Rdbuf2 = Space(12) 'Allocate a maximum of 12 bytes, including delimiters.
Call iord(spa, Rdbuf2) 'Read the peak search data (level).
Peak_Level = Val(Rdbuf2) 'Convert ASCII format into numeric values.

```

Example VB-4: After setting measurement conditions for spectrum analysis, the spectrum data obtained is read in the ASCII format.

```

Dim l%, n%, res%
Dim Rdbuf As String
Dim spLev() As String, spLen() As String
Dim spLev() As Double, spLength() As Double

Call ioclr(spa) 'Performs a Device Clear.

Call iowrt(spa, "C") 'Preset
Call iowrt(spa, "CEN1550nm, SPA20nm") 'Set the center wavelength to 1550 nm and the span to 20 nm.
Call iowrt(spa, "REF0dBm") 'Set the reference level to 0 dBm.
Call iowrt(spa, "SWE1, RES0.1nm") 'Set the sweep mode to ADAPTIVE and the resolution to 0.1 nm.
Call iowrt(spa, "MSK254") 'Enable measurement-end of status byte (b0).
Call iowrt(spa, "SRQ") 'Enable SRQ interrupt

Call iowrt(spa, "MEAL") 'Start single measurement.
Call iowait(spa, RQS Or TIMO) 'Waiting for SRQ interrupt.
Call iobrsp(spa, res) 'Read the status byte.

Call iowrt(spa, "SMT0, ASD0, SBL2") 'Set the ASCII format and the delimiter. Data output of header is
set to OFF.
Call iowrt(spa, "OPN") 'Output of data number is requested.

Rdbuf = Space(8) 'Allocate a maximum of 8 bytes, including delimiters.
Call iord(spa, Rdbuf) 'Read the number of data.
n = Val(Rdbuf) 'Convert ASCII format into numeric values.

```

4.11 Example Programs

```

ReDim spLev(n), spLen(n)
ReDim spLevel(r), spLength(n)

Call iowrt(spa, "OSD0")           'Request the wavelength data (vertical axis)
For i = 1 To n
    spLev(i) = Space(13)         'Allocate a maximum of 13 bytes, including delimiters.
    Call ibrd(spa, spLev(i))     'Read the level data.
    DoEvents                     'Check for other events occurring in the loop.
Next i
Call iowrt(spa, "OSD1")           'Request the wavelength data (horizontal axis)
For i = 1 To n
    spLen(i) = Space(15)        'Allocate a maximum of 15 bytes, including delimiters.
    Call ibrd(spa, spLen(i))     'Read the wavelength data.
    DoEvents                     'Check for other events occurring in the loop.
Next i
For i = 1 To 10
    spLeve(i) = Val(spLev(i))   'Convert ASCII format into numeric values.
    spLength(i) = Val(spLen(i)) 'Convert ASCII format into numeric values.
Next i

```

Example VB-5: After setting measurement conditions for spectrum analysis, the spectrum data obtained is read in the binary format.

```

Dim i%, r%, res%
Dim Rdbuf1 As String
Dim d1%, d2%, d3%, d4%
Dim si#, de#, dk#
Dim spLev() As Integer, spLen() As Integer
Dim spLeve() As Double, spLength() As Double

Call ioclr(spa)                   'Performs a Device Clear.

Call iowrt(spa, "C")              'Preset
Call iowrt(spa, "CEN1550nm, SPA20nm") 'Set the center wavelength to 1550 nm and the span to 20 nm.
Call iowrt(spa, "REF0dBm")        'Set the reference level to 0 dBm.
Call iowrt(spa, "SWEL, RES0.1nm") 'Set the sweep mode to ADAPTIVE and the resolution to 0.1 nm.
Call iowrt(spa, "MSK254")         'Enable measurement-end of status byte (b0).
Call iowrt(spa, "SRQ")            'Enable SRQ interrupt
Call iowrt(spa, "MEAL")           'Start single measurement.

Call iowait(spa, RQS Or TIMO)     'Waiting for SRQ interrupt.
Call iocsp(spa, res)              'Read the status byte.

Call iowrt(spa, "FMT3, HDJ0, SBL2") 'Set the binary format and the delimiter. Data output of header is set to OFF.
Call iowrt(spa, "ON")             'Output of data number is requested.

Rdbuf1 = Space(8)                 'Allocate a maximum of 8 bytes, including delimiters.
Call iord(spa, Rdbuf1)            'Read the number of data.
n = Val(Rdbuf1)                   'Convert ASCII format into numeric values.

ReDim soLev(n * 4 / 2 - 1), soLen(n * 4 / 2 - 1)
ReDim soLevel(r), soLength(n)

Call iocconfig(spa, "bcReacAdjust, 1) 'Perform the byte swapping when reading it.
Call iowrt(spa, "OSD0, DT12")      'Request the level data (vertical axis) as output data, and specify EOI for the delimiter.

Call iordi(spa, spLev(), n * 4)    'Read the level data.

```



```

*****
'Convert the binary data into the numeric data (level data).
*****
For i = 1 To n
  If spLev((i - 1) * 2 - 0) > 0 Then
    d1 = spLev((i - 1) * 2 + 0) \ 256
    d2 = spLev((i - 1) * 2 + 0) Mod 256
  Else
    d1 = (65536 + spLev((i - 1) * 2 + 0)) \ 256
    d2 = (65536 + spLev((i - 1) * 2 + 0)) Mod 256
  End If
  If spLev((i - 1) * 2 + 1) > 0 Then
    d3 = spLev((i - 1) * 2 + 1) \ 256
    d4 = spLev((i - 1) * 2 + 1) Mod 256
  Else
    d3 = (65536 + spLev((i - 1) * 2 + 1)) \ 256
    d4 = (65536 + spLev((i - 1) * 2 + 1)) Mod 256
  End If
  If d1 > 127 Then
    si = 1
    de = (d1 - 128#) * 2# + (d2 \ 128)
  Else
    si = 0
    de = d1 * 2# + (d2 \ 128)
  End If
  If d3 > 127 Then
    dk = (d4 + d3 * 256# + d2 * 65536#) / 8388608#
  Else
    dk = (d4 + d3 * 256# + (d2 - 128#) * 65536#) / 8388608#
  End If
  spLeve(i) = si * (2 ^ (ce - 127)) * dk
Next i

Call i#wrt(spa, "OSD1,DEL2")           'Request the wavelength data (horizontal axis) as output data.
Call i#rdi(spa, spLev(), n * 4)      'Read the wavelength data.

*****
'Convert the binary data into the numeric data (wavelength data).
*****
For i = 1 To n
  If spLer((i - 1) * 2 - 0) > 0 Then
    d1 = spLer((i - 1) * 2 + 0) \ 256
    d2 = spLer((i - 1) * 2 + 0) Mod 256
  Else
    d1 = (65536 + spLer((i - 1) * 2 + 0)) \ 256
    d2 = (65536 + spLer((i - 1) * 2 + 0)) Mod 256
  End If
  If spLer((i - 1) * 2 + 1) > 0 Then
    d3 = spLer((i - 1) * 2 + 1) \ 256
    d4 = spLer((i - 1) * 2 + 1) Mod 256
  Else
    d3 = (65536 + spLer((i - 1) * 2 + 1)) \ 256
    d4 = (65536 + spLer((i - 1) * 2 + 1)) Mod 256
  End If
  If d1 > 127 Then
    si = 1
    de = (d1 - 128#) * 2# + (d2 \ 128)
  Else
    si = 0
    de = d1 * 2# + (d2 \ 128)
  End If

```

4.11 Example Programs

```
    If d2 > 127 Then
        dk = (d4 + d3 * 256# + d2 * 65536#) / 8388608#
    Else
        dk = (d4 + d3 * 256# + (d2 - 128#) * 65536#) / 8388608#
    End If
    spLength(i) = si * (2 ^ (de - 127)) * dk
Next i
Call ioconfig(spa, "bcReacAdjust, 0)      'Cancel the byte swapping when reading it.
```

5 TECHNICAL NOTES

5.1 Measurement Modes

There are six measurement modes (sweep modes) available which can be used to measure a variety of optical signals in this optical spectrum analyzer. Measuring time or the minimum measurable level (or sensitivity) varies depending on the measurement mode used. As a result, choose the appropriate mode for the optical signal used.

- **NORMAL**
Measures relatively high-level optical signals at high speeds.
- **ADAPTIVE**
Measures signals which require relatively high sensitivity at relatively high speeds. This mode is also used to measure optical signals from pulsing emission in sync with an external signal.
- **ADAPTIVE (Pulsing optical signals: External sync mode)**
Measures pulsed optical signals which are input to the GATE MEAS INPUT connector in sync with an external signal.

This input level has a logic level of TTL.

The externally synchronized measurement function automatically starts when a pulse signal is detected at the GATED MEAS INPUT terminal when the measurement is set to ADAPTIVE. When this input is not used, its level is considered HIGH because it is internally pulled up. Use a synchronization signal with a constant period.

There are two modes for the externally synchronized measurement function: SYNC LOW and SYNC HI.

- **SYNC LOW Mode**
An AD sampling is performed with the high level of a synchronization signal.
Minimum optical pulse width: 10 nsec (30 μ sec or more is recommended).
A pulse width of 30 μ sec or less is displayed a little lower than the actual level.
The internal optical detector has a bandwidth of approximately 10 kHz and the sensitivity is approximately 10 dB lower than the normal sensitivity in ADAPTIVE Mode.
- **SYNC HI Mode**
An AD sampling is performed at less than 1000 μ sec (specified by "Delay Time") after the specified rising or falling edge parameter of the synchronization signal is detected.
The internal optical detector has a bandwidth of approximately 1 MHz and the sensitivity is approximately 40 dB lower than the normal sensitivity in ADAPTIVE Mode.
- **HI DYNAMIC1/2**
Used to measure optical signals so that the dynamic range is larger than the range used in ADAPTIVE mode by intercepting the stray light caused by the monochromator.
The HI DYNAMIC2 has a larger dynamic range than HI DYNAMIC1.
- **HI-SENSE1/2**
A higher priority is given to the sensitivity.
HI-SENSE2 has a higher sensitivity than HISENSE1.

5.2 Averaging Functions

- PULSE (Peak Hold Mode)

A pulse optical measurement is made using the internal peak hold circuitry without using an external synchronization signal. The peak hold circuitry performs an AD sampling for the peak level of a pulse signal that is held during GATE TIME. As a result, “GATE TIME” must be longer than the input optical pulse period.

The internal optical detector has a bandwidth of approximately 10 kHz so that the measurement level is lower than actual level when an optical signal whose pulse width is 30 μsec or less.

The sensitivity is approximately 20 dB lower than the normal sensitivity in ADAPTIVE Mode.

When GATE TIME is set to 0, the built-in low-pass filter is connected instead of the peak hold circuitry, and the average power level of the optical signal is measured.

Table 5-1 Throughput, Sensitivity and Dynamic Range for Each Measurement Mode at a Wavelength of 1.55 μm (typical value)

	NORMAL	ADAPTIVE	Hi Sens 1	Hi Sens 2	Hi Dyna 1	Hi Dyna 2
Span 50 nm, 501 point	0.5 sec	3.5 sec	28 sec	55 sec	9.0 sec	50 sec
Span 50 nm, 1001 point	0.9 sec	4.5 sec	60 sec	110 sec	17 sec	100 sec
Sensitivity (1.5 μm typical value)	-65 dBm	-73 dBm	-88 dBm	-90 dBm	-74 dBm	-87 dBm
Dynamic range		+	+	+	++	++

5.2 Averaging Functions

The optical spectrum analyzer is equipped with the mode of noise reduction which can measure low-level optical signals.

- Point Average

Displays a spectrum with reduced noise after one sweep: takes data at each measurement point the specified number of times, and then performs averaging for each point.

- Sweep average

Performs sweeps repetitively, and performs averaging for each point. Noise is reduced as the number of sweeps increases.

- Smoothing

Performs averaging by assigning weights to the adjacent points to smooth the measurement waveform.

5.3 Calculating the Spectral Width and the Notch Width

There are five modes available for calculating spectral width using this optical spectrum analyzer. Notch widths can also be calculated. The center wavelength, spectral width and the number of peaks are displayed after each calculation. The description for each method is shown below.

If two X cursors are displayed, the section between the two cursors is calculated.

5.3.1 Calculating the Spectral Width

5.3.1.1 PEAK THRESHOLD

The spectral width and center wavelength can be calculated from two intersections of the level line **THRESHOLD LVL1** below the maximum peak and two lines obtained using the linear interpolation.

The linear interpolation is performed using the LOG or LIN scale coordinates.

If a negative value is assigned to **THRESHOLD LVL1**, the level is increased by the value above the minimum level.

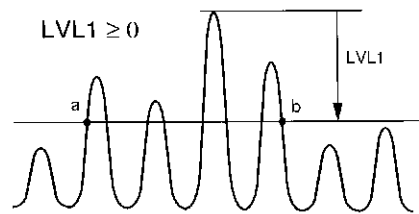

$$\lambda_0 = \frac{\lambda_a + \lambda_b}{2}$$

$$\Delta\lambda = \lambda_b - \lambda_a$$

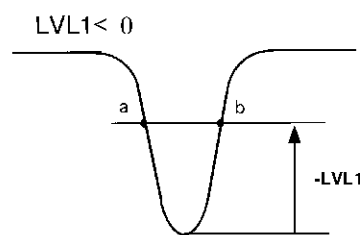

$$\lambda_0 = \frac{\lambda_a + \lambda_b}{2}$$

$$\Delta\lambda = \lambda_b - \lambda_a$$

5.3 Calculating the Spectral Width and the Notch Width

5.3.1.2 ENVELOPE

Creates an envelope of monotonous peak from the peaks whose levels are above the line a level specified by **THRESHOLD LVL 2** below the maximum peak. The spectral width and center wavelength are calculated from the points where the line a level specified by **THRESHOLD LVL1** below the maximum peak (for LVL 1 ≥ 0).

The linear interpolation is performed using the LOG or LIN scale coordinates.

If there are no peaks whose values are above the level THRESHOLD LVL2 below the maximum peak, the result is 0 because no envelope has been obtained.

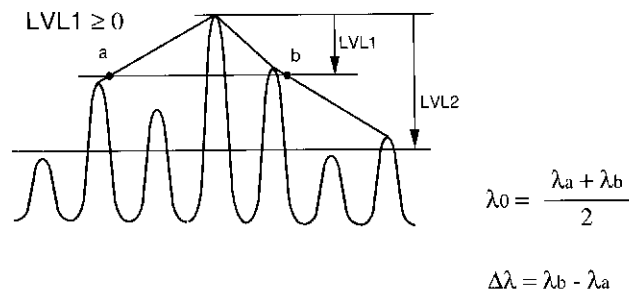

5.3.1.3 RMS

The center wavelength is calculated from the weighted average of all spectrums displayed. The half power bandwidth is defined as the result of the standard deviation for the power spectrum multiplied by the set value of Kr (RMS).

The initial value of K is 1, and the initial value of K_{RMS} is 2.3548.

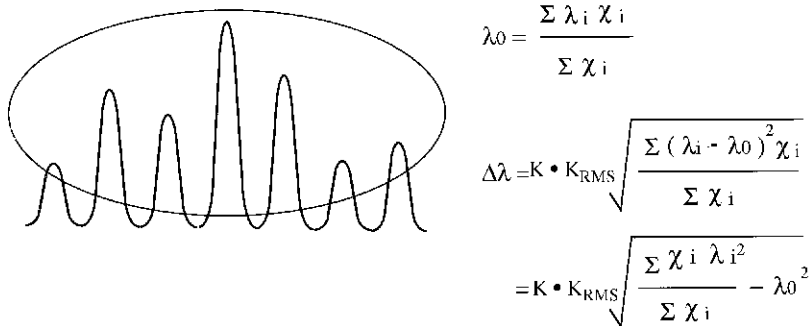

5.3.1.4 Peak RMS

The center wavelength is defined as the weighted average wavelength of peaks that are higher than or equal to the threshold level. The threshold level is given by **THRESHOLD LVL 2**. The half power bandwidth is defined as the result of the standard deviation for the wavelength of each peak multiplied by the set value of Kr (RMS).

The initial value of K is 1, and the initial value of K_{RMS} is 2.3548.

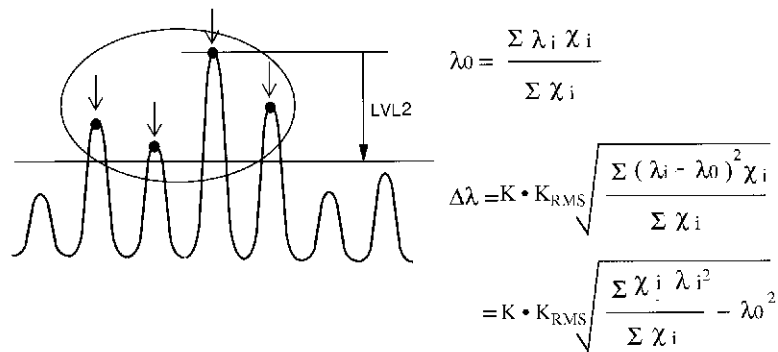

5.3.1.5 Xnm Level

Calculates the level difference between the maximum peak and the level whose spectrum width is Xnm.

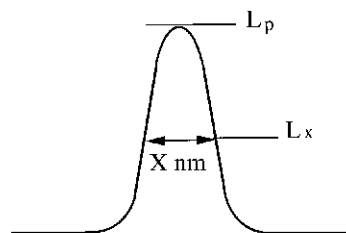

For LOG Scale

$$X \text{ nm Level [dB]} = L_p \text{ [dBm]} - L_x \text{ [dBm]}$$

For LIN Scale

$$X \text{ nm Level [\%]} = L_p \text{ [W]} / L_x \text{ [W]} * 100$$

5.3 Calculating the Spectral Width and the Notch Width

5.3.2 Notch Width

5.3.2.1 XdB WIDTH

The notch width and center wavelength are calculated from the points where the line a level specified by **THRESHOLD LVL1** below the maximum peak (for LVL1 ≥ 0). The linear interpolation is performed using the LOG or LIN scale coordinates.

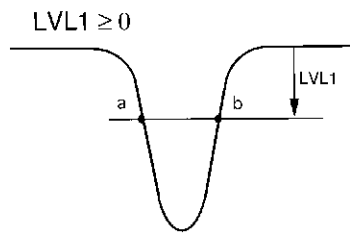

$$\lambda_0 = \frac{\lambda_a + \lambda_b}{2}$$

$$\Delta\lambda = \lambda_b - \lambda_a$$

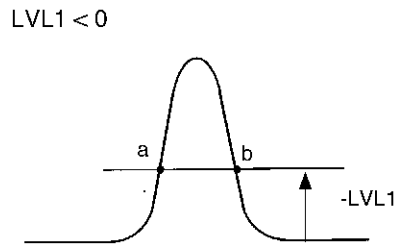

$$\lambda_0 = \frac{\lambda_a + \lambda_b}{2}$$

$$\Delta\lambda = \lambda_b - \lambda_a$$

LVL1 ≥ 0

The notch width is the difference between intersections a and b of the line XdB below the maximum level and the spectrum (the left and right intersections are referred to as a and b, respectively). The center wavelength is the midpoint between a and b.

LVL1 < 0

The notch width is the difference between intersections a and b of the line XdB above the minimum level and the spectrum (the left and right intersections are referred to as a and b, respectively). The center wavelength is the midpoint between a and b.

5.3.2.2 Xnm Level

Calculates the difference between the maximum level and the spectrum width level of Xnm (For the LIN display, the ratio of the two levels is calculated.)

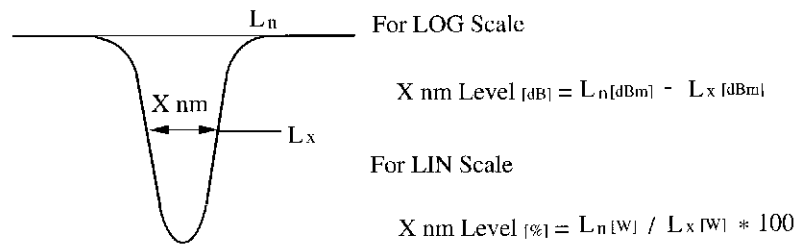

5.4 GAIN&NF and SNR

The optical spectrum analyzer calculates the noise figure characteristics and SNR of an optical amplifier after the amplified spontaneous emission (ASE) level has been calculated using the interpolation.

- The method of determining the ASE level using the ASE Fitting settings changes when WDM ASE Method is set to AUTO OFF, or when the Opt. AMP function is set to SNG mode.

(1) When ASE Fitting is set to Gauss mode

The level at the center wavelength for each signal is defined as the ASE level, and is calculated using a simulated Gaussian curve fitted to the two target sections (thick lines). These sections are calculated with Fitting SPAN and Masked SPAN.

(2) When ASE Fitting is set to MEM-3 mode

The level at the center wavelength for each signal is defined as the ASE level, and is calculated using the spectrum which was saved in MEAS 3 (memory 3) and then fitted to the two target sections (thick lines). These sections are calculated with Fitting SPAN and Masked SPAN.

(3) When ASE Fitting is set to Manual mode

Set Manual ASE LEVEL to the amplified spontaneous emission (ASE) level.

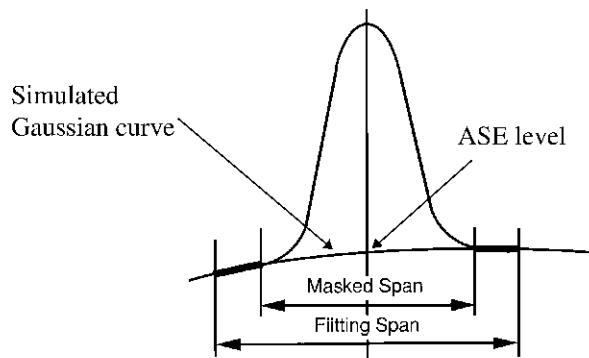

- When WDM ASE Method is set to AUTO ON, and the Opt. AMP function is not set to SNG Mode
The lowest level between WDM signals is defined as the ASE level. The method of calculating the ASE level changes according to the number of WDM signals

Table 5-2 Number of Signals and Interpolation Method.

Number of signals	Processing
1 to 8	Calculates a simulated Gaussian curve based on the lowest level between adjacent valleys of a channel. The ASE level for each channel is defined as the level at the intersection point obtained as follows: a line that starts from the peak of the channel, descends perpendicular to the X-axis and intersects the simulated Gaussian curve.
9 or more	The line that connects adjacent lowest levels of a channel must first be determined. The ASE level for a channel is then defined as the level at the intersection point obtained as follows: a line which starts from the peak of the channel, descends perpendicular to the X-axis and intersects the lowest level line.

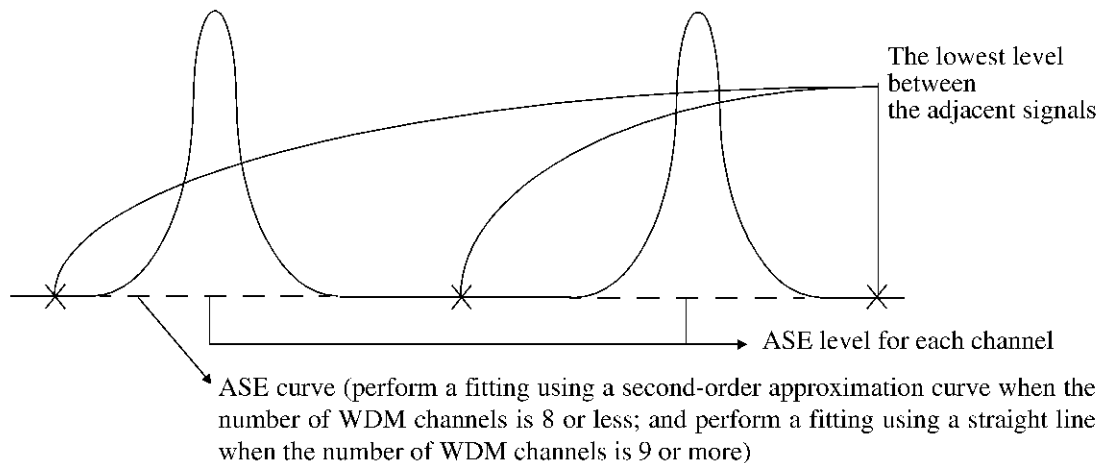

- When Conversion is selected for the ASE NBW parameter to calculate the amplified spontaneous emission optical power level for calculating SNR, the amplified spontaneous emission optical power level P_{ase} is calculated using the wavelength resolution set by the ASE Converted NBW parameter.

$$P_{ase} \text{ (After conversion)} = P_{ase} \text{ (Measurement value)} \times \frac{\text{Res (Setting resolution for ASE Converted NBW)}}{\text{Res (Current measurement wavelength resolution)}}$$

- SNR is calculated using the formula below.

$$\text{SNR} = \frac{\text{Optical signal power}}{\text{Amplified spontaneous emission level}}$$

This analyzer calculates SNR by assigning the peak level for the optical power under normal circumstances. However, when the Signal Power mode is set to Σ Power using the WDM function, SNR is calculated using the integral power of spectrum in Masked Span as the optical signal power. This analyzer can obtain SNR correctly using the Σ Power mode while observing waveforms (such as ones for modulated signals with high resolution).

5.4 GAIN&NF and SNR

5.4.1 GAIN

The gain of the optical amplifier is calculated by using the formula shown below with the input and output optical levels and the ASE level that are previously calculated.

$$G = \frac{(P_{OUT} - P_{ASEM}) L_{OUT}}{P_{IN} L_{IN}}$$

5.4.2 NF

The NF of the optical amplifier is calculated according to NF SELECT as shown below. Use the ASE and gain that have previously been obtained.

- When NF SELECT is set to total mode

Terms 1 to 4 in the first formula are as follows:

- Term1: Shot noise caused by an optical signal
- Term2: Shot noise caused by an ASE
- Term3: Beat noise between an optical signal and ASE
- Term4: Beat noise between ASEs.

Set the parameter $\Delta\lambda$ to the wavelength band of an optical receiver.

$$NF = K \left(\frac{1}{G} + \frac{2 \mu_x \Delta f}{G N} + 2 \mu_x + \frac{2 \mu_x^2 \Delta f}{N} \right)$$

$$N = \frac{P_{IN} L_{IN}}{h \nu}$$

$$\mu_x = \frac{P_{ASE}}{2 h \nu G \Delta \nu}$$

$$\Delta f = \frac{C}{\lambda_S - \Delta\lambda/2} - \frac{C}{\lambda_S + \Delta\lambda/2}$$

If $\Delta\lambda$ is set to 0, NF is calculated using the formula below. This formula contains two terms related to the beat noise between the optical signal and spontaneous emission light, and the shot noise of the optical signal.

$$NF = K \left(\frac{P_{ASE}}{h \nu G \Delta \nu} + \frac{1}{G} \right)$$

- When NF SELECT is set to S-Sp mode

NF is calculated using the term related to the beat noise between the optical signal and spontaneous emission light only.

$$NF = K \frac{P_{ASE}}{h \nu G \Delta \nu}$$

G :	Gain
NF :	Noise Figure
P _{IN} :	Input signal optical level (W)(measured value)
P _{OUT} :	Output signal optical level (W)(measured value)
P _{ASEM} :	ASE optical level before correction (W)
P _{ASE} :	ASE optical level (W)
L _{IN} :	"Pin Loss" value (setting value)
L _{OUT} :	"Pout Loss" value (setting value)
K :	Coefficient for the calculation result (setting value)(initial value: 1.000)
C :	The velocity of signal light (2.9979*10 ⁸ [m/s])
N :	Photon number
h :	Plank's constant (6.63*10 ⁻³⁴ [J s])
ν :	Signal light frequency (Hz)
Δν :	Frequency resolution during ASE measurement (Hz)
λ _s :	Wavelength of signal light
Δλ :	Effective optical filtering width of optical amplifier output (setting value)

5.4.3 SPE DIV

To interpolate ASE level using the Opt.AMP function (which is used to calculate the noise factor of an optical amplifier), It is effective for high input levels of the optical amplifier (Saturation area).

When this mode is turned on, the correction spectrum (P_{CORR}) is obtained from the output spectrum (P_{OUT}) and input spectrum (P_{IN}) using the following expression. The ASE level is calculated from the correction spectrum.

$$P_{CORR} = P_{OUT} - G \cdot P_{IN}$$

G: Gain at the signal light wavelength [G = (P_{OUT} - P_{ASE})/P_{IN}]

P_{ASE}: Temporary ASE level obtained using fitting

When this mode is off, the ASE level can be obtained directly from the output spectrum.

5.5 Optical BPF Analysis

The O-BPF function of this analyzer makes the filter characteristic measurement easier. The peak wavelength and level for the filtered waveform, the deviation from the user setting standard center frequency, the filter band, the ripple for the specified range, and Isolation can be measured.

5.5.1 Calculating Various Bands

The bandwidth and the center wavelength can be measured at the same time for four bands: Pass, Half, Stop, and RMS. For the Pass, Half, and Stop band types, they are calculated in the same way as the Peak threshold described in Section 5.3, "Calculating the Spectral Width and the Notch Width." The user can set a threshold value according to the filter design for three bands from the Pass, Half, and Stop Band Threshold settings. They are defined as Pass Band, Half Band, and Stop Band in ascending order of the loss at the cut-off point (level threshold).

For the RMS Bandwidth, it is calculated in the same way as the RMS described in Section 5.3, "Calculating the Spectral Width and the Notch Width." When it is calculated, the K value and Krms value are fixed to 1 and 2.3548, respectively.

How much the peak wavelength, Pass Band center wavelength, and the Half Band center wavelength deviate from the proximate grid to the peak wavelength can be calculated. Each result is displayed as the Peak Wavelength Error, Pass Center Error, and Half Center Error, respectively. With the GRID Ref Frequency as the reference point, grids are placed at every frequency interval which is specified as the GRID CH Spacing. Out of all of the grids, 64 grids on both sides of the nearest grid from the peak are used for calculations. Ripple in the band is calculated using one of the following three methods from the Ripple Select:

- max-min: The difference between the maximum level value and the minimum level value in the Pass Band is displayed.
- ripple: The difference between the maxima level and minima level in the Pass Band is displayed.
- search area: The difference between the maximum level and minimum level in the analysis range is displayed. (For more information on the analysis range, refer to Section 5.5.2, "Calculating Isolation.")

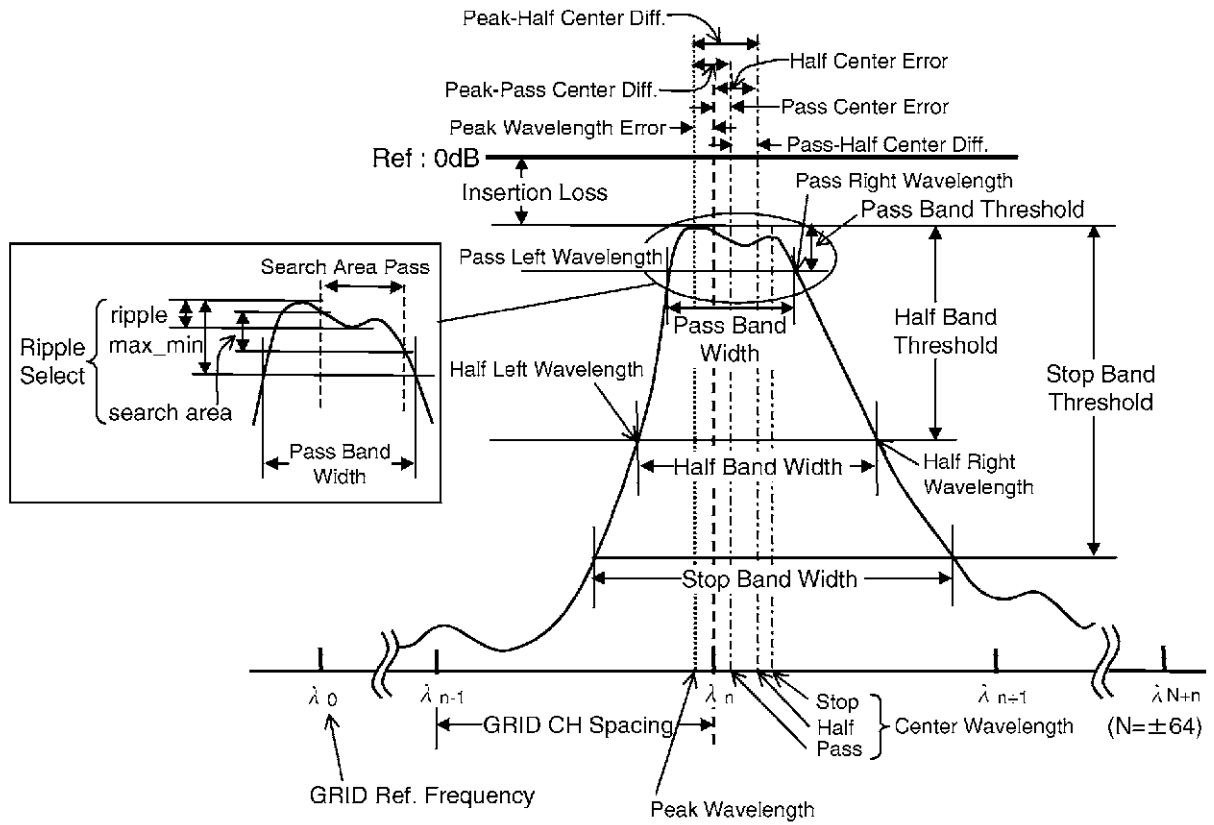

Figure 5-1 Optical BPF (Calculating Various Bands)

5.5.2 Calculating Isolation

Various isolations can be calculated using an analysis wavelength range which is set by the user. The standard wavelength for the passband used when calculating isolation can be selected from one of the four settings in the Std Wavelength setting:

- **peak:** Sets the standard wavelength in the passband to the maximum peak wavelength of waveform.
- **pass_center:** Sets the standard wavelength in the passband to the Pass Band center wavelength of the filter waveform.
- **half_center:** Sets the standard wavelength in the passband to the Half Band center wavelength of the filter waveform.
- **GRID:** Sets the standard wavelength in the passband to the most proximate grid to the maximum peak wavelength.

The grids used for calculating isolation are placed along the wavelength-axis with the pitch (converted to wavelength) set by GRID CH Spacing based on the standard wavelength which is set by Std Wavelength as shown in Figure 5-2. The horizontal axis markers display the analysis wavelength range. The range is set by Search Area Pass and Search Area Stop centered on the specified grid. Search Area Pass and Search Area Stop are the ranges to be analyzed for the passband and stopband, respectively. Usually, the communication channel bandwidth or the pass band width is used for the wavelength range to be analyzed. Isolation is the difference between the passband analyzing range loss and the stopband analyzing range loss. Search Area Pass sets the standard wavelength as the passband analyzing range center, and Search Area Stop sets the stopband range center with a grid other than the wavelength. Isolation Pass/Stop is used to set which value is selected from the range to be analyzed for the calculation. Isolation Pass and Isolation Stop are the loss calculation methods for the passband and the stopband, respectively. The setting values must be selected from one of the following settings:

- **max:** Calculates using the maximum level value in the range to be analyzed.
- **min:** Calculates using the minimum level value in the range to be analyzed.
- **avg:** Calculates using the average level value in the range to be analyzed.

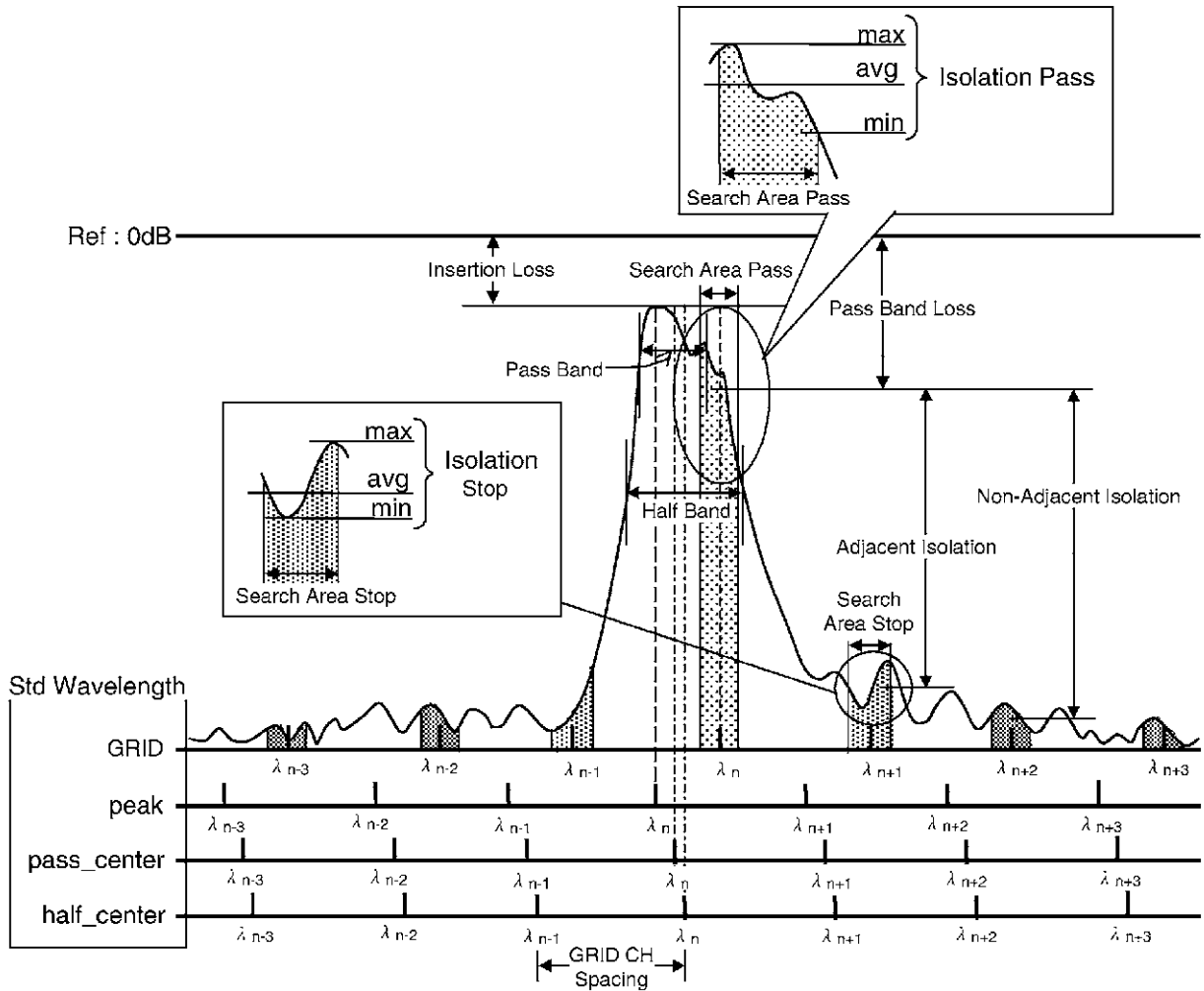

Figure 5-2 Optical BPF (Calculating Isolation)

5.5.3 Output Data

The measurements generate the following parameters:

- Peak Wavelength: Maximum peak wavelength
- Insertion Loss: The loss at the maximum peak level.
- Pass Band Width: Bandwidth calculated using Pass Band Threshold
- Pass Center Wavelength: Center wavelength of the Pass Band
- Pass Left Wavelength: Leftmost wavelength of the Pass Band
- Pass Right Wavelength: Rightmost wavelength of the Pass Band
- Pass Band Loss: Loss at a point which satisfies the conditions set by Isolation Pass in the range set by Search Area Pass
- Half Band Width: Bandwidth calculated using Half Band Threshold
- Half Center Wavelength: Center wavelength of the Half Band
- Half Left Wavelength: Leftmost wavelength of the Half Band
- Half Right Wavelength: Rightmost wavelength of the Half Band
- Ripple: Calculation result using the method set by Ripple Select
- Stop Band Width: Bandwidth calculated using Stop Band Threshold
- Stop Center Wavelength: Center wavelength of the Stop Band
- Peak-Pass Center Diff: Difference between the maximum peak wavelength and Pass Band center wavelength
- Peak-Half Center Diff: Difference between the maximum peak wavelength and Half Band center wavelength
- Pass-Half Center Diff: Difference between Pass Band and Half Band center wavelength
- Pass Center Error: The difference between the Pass Band center wavelength and the Grid nearest to the maximum peak wavelength (converted to a wavelength).
- Half Center Error: The difference between the Half Band center wavelength and the Grid nearest to the maximum peak wavelength (converted to a wavelength).
- Peak Wavelength Error: The difference between the peak wavelength and the Grid nearest to the maximum peak wavelength (converted to a wavelength).
- RMS Bandwidth: The half power bandwidth for the RMS calculation in the spectral width function.
- RMS Center Wavelength: The center wavelength calculated using the RMS calculation in the spectral width function.
- Adjacent Isolation: The worse value of the calculated values for the two ranges to be analyzed in the stopband that are adjacent to the passband.
- Non-Adjacent Isolation: The worst calculated values for stopband analysis ranges. Analysis ranges adjacent to the passband are excluded.

- Total Isolation: Total value using all results for all ranges to be analyzed in the stop-band.

5.6 Tilt Calculation Function

5.6.1 Filter Tilt

This function is used to analyze the spectral tilt in the wavelength range set by the user. The Least-Squares fit for the waveform shown in dB is found using the least squares method in the specified wavelength range. Then the tilt, the difference between both ends, and losses at both ends of the approximate line can be calculated. When this function is used with the Loss/Trans function, the filter tilt in the passband can be evaluated.

5.6.1.1 Output Data

When the measurements are performed, the following parameters are displayed:

- Tilt dB/nm: Tilt of Least-Squares fit line for the measured waveform in the user setting range
- Tilt dB: Level difference between both ends of Least-Squares fit line for the measured waveform in the user setting range
- Insertion Loss Left: Leftmost loss of Least-Squares fit line for the measured waveform in the user setting range
- Insertion Loss Right: Rightmost loss of an approximate line for the measured waveform in the user setting range

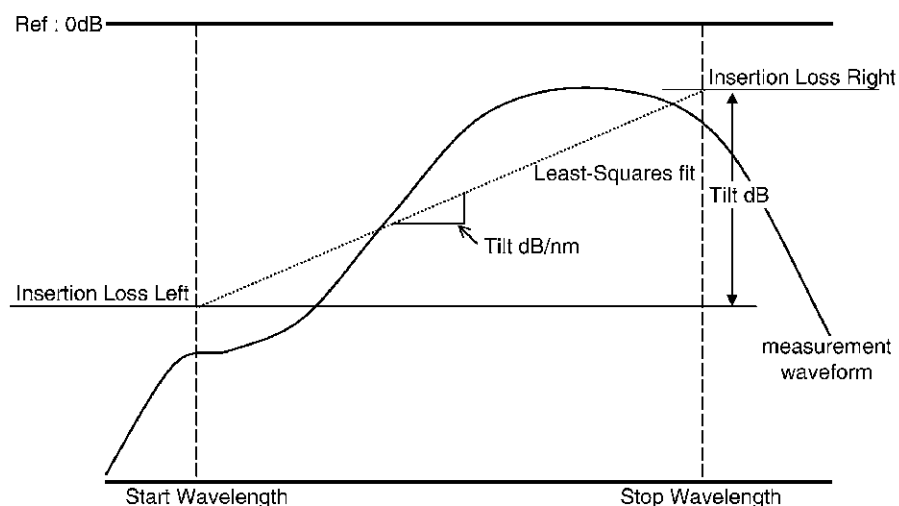

Figure 5-3 Filter Tilt

5.7 LD Performance Analysis

5.7 LD Performance Analysis

5.7.1 DFB-LD

This mode is used to easily perform various types of spectrum analysis for the DFB-LD evaluations. The wavelength and the level difference between the maximum peak and second peak of the measured waveform, as well as the wavelength deviation between the left and right peaks, adjacent to the maximum peak, can be measured.

5.7.1.1 Output Data

When the measurements are performed, the following parameters are displayed:

- Peak Wavelength: Maximum peak wavelength
- Peak Power: Maximum peak level
- SMSR: Difference between the maximum peak level and the second peak level
- Mode Offset: Difference between the maximum peak wavelength and the second peak wavelength
- Stop Band: The wavelength width between the left and right peaks adjacent to the maximum peak.
- Center Offset: The difference between the wavelength centers of the left and right peaks adjacent to the maximum peak and the maximum peak wavelength.
- Spectral Width: The bandwidth calculated by Peak Threshold in the spectral width function using Threshold Level 1.

5.7.2 FP-LD

This mode is used to easily perform various types of spectrum analysis required for FP-LD evaluations. Peaks which are higher than or equal to Threshold Level 2 are analyzed. The band center wavelength calculated from the threshold level, the maximum peak level and wavelength, the mode interval, the number of modes, and the total power can be calculated. In this mode, the K value and Krms value are fixed to 1 and 2.3548, respectively.

5.7.2.1 Output Data

When the measurements are performed, the following parameters are displayed:

- Mean Wavelength: Center wavelength calculated using Peak RMS in the spectral width function
- Peak Wavelength: Maximum peak wavelength
- Mode Spacing (nm): Mode wavelength interval (an average value of each mode interval)
- Mode Spacing (GHz): Mode frequency interval (an average value of each mode interval)
- Spectral Width: The half power bandwidth for the Peak RMS calculation in the spectral width function.
- Peak Power: Maximum peak level

- Total Power: The total power of the peak levels located above the line where the attenuation set by the Threshold Level2 setting from the maximum peak level.
- Sigma: The standard deviation for each peak wavelength calculated by the Peak RMS in the spectral width function.
- Mode No.: The number of peaks located above the line where the attenuation set by Threshold Level2 setting from the maximum peak level.

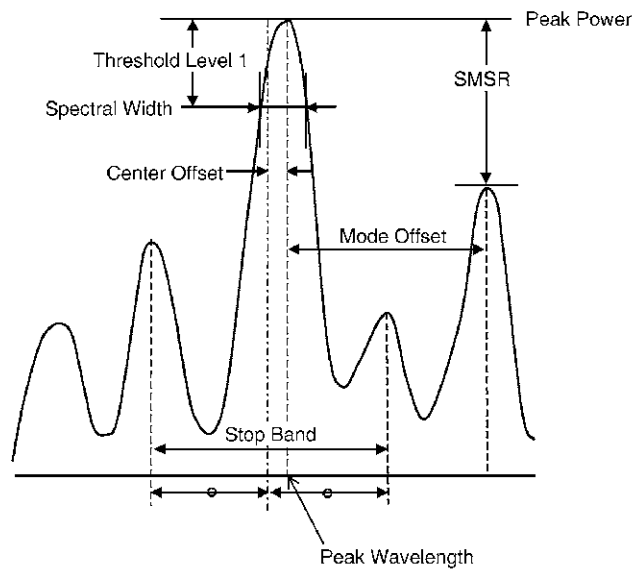

Figure 5-4 DFB-LD

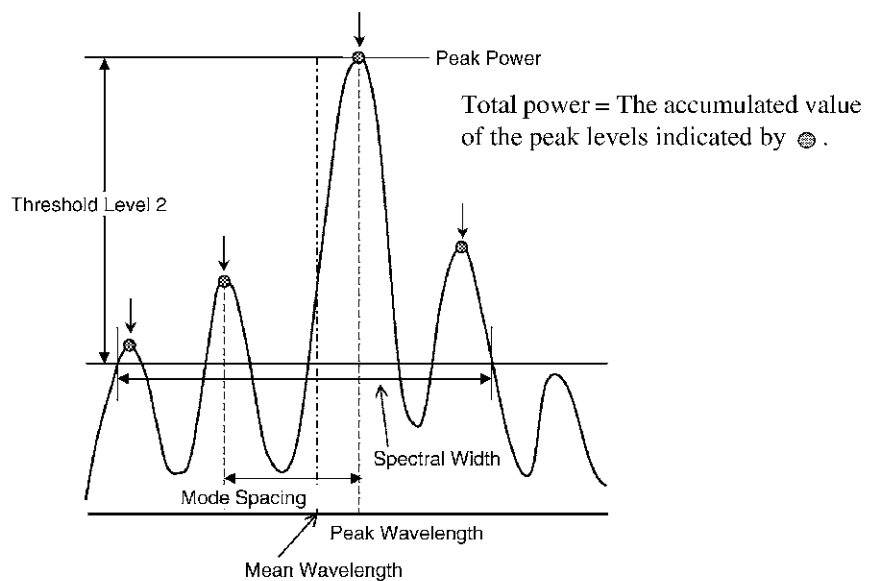

Figure 5-5 FP-LD

5.7.3 LED

This mode is used to perform various types of spectrum analysis for LED evaluations. This analysis covers all the waveforms displayed in the span. The spectrum width and the center wavelength, the maximum peak level and its wavelength, the peak power density, and the total power can be captured. In this mode, the K value and Krms value are fixed to 1 and 2.3548, respectively.

5.7.3.1 Output Data

When the measurements are performed, the following parameters are displayed:

- Mean Wavelength: Center wavelength calculated using the RMS calculation in the spectral width function
- Peak Wavelength: Maximum peak wavelength
- Peak Power: Maximum peak level
- Peak Power Density: Peak power density (power per 1nm band at the peak)
- Spectral Width: The half power bandwidth calculated using the RMS calculation in the spectral width function.
- 3dB Threshold Width: Spectrum width calculated using Peak Threshold in the spectral width function when the threshold level is set to 3dB
- Sigma: Standard deviation of each peak wavelength calculated using the RMS calculation in the spectral width function.
- Total Power: Total power of the displayed waveform

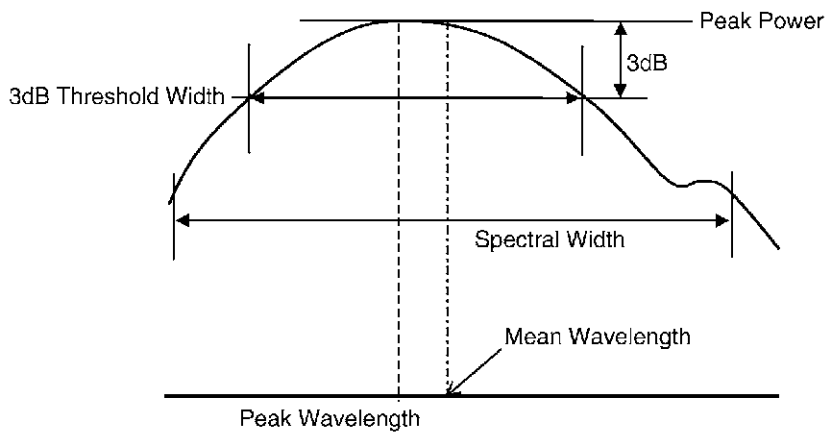

Figure 5-6 LED

5.8 ACPR (Adjacent Channel Leakage Power Ratio)

The total power in and out of the user setting signal band (it is called leakage power if it is out of the signal band), and ACPR, which is the ratio of the total power and the leak power, can be calculated.

A signal bandwidth is identified using GRID Ref Frequency and GRID CH spacing specified grids. The grids are placed with the frequency span specified in GRID CH Spacing and using GRID Ref Frequency as the reference. The grid specified by the GRID Ref Frequency and GRID CH Spacing defines the signal band. The User set GRID Ref Frequency defines the reference frequency. The User set GRID CH Spacing defines the grid spacing. The signal band is defined by the GRID CH Spacing centered on the grid nearest to the highest peak in the spectrum.

5.8.1 Output Data

When the measurements are performed, the following parameters are displayed:

- Signal Power: Total power in the signal band [dBm]
- Leakage Power: Leakage power [dBm]
- ACPR: Leakage power ratio to Signal Power [dB]

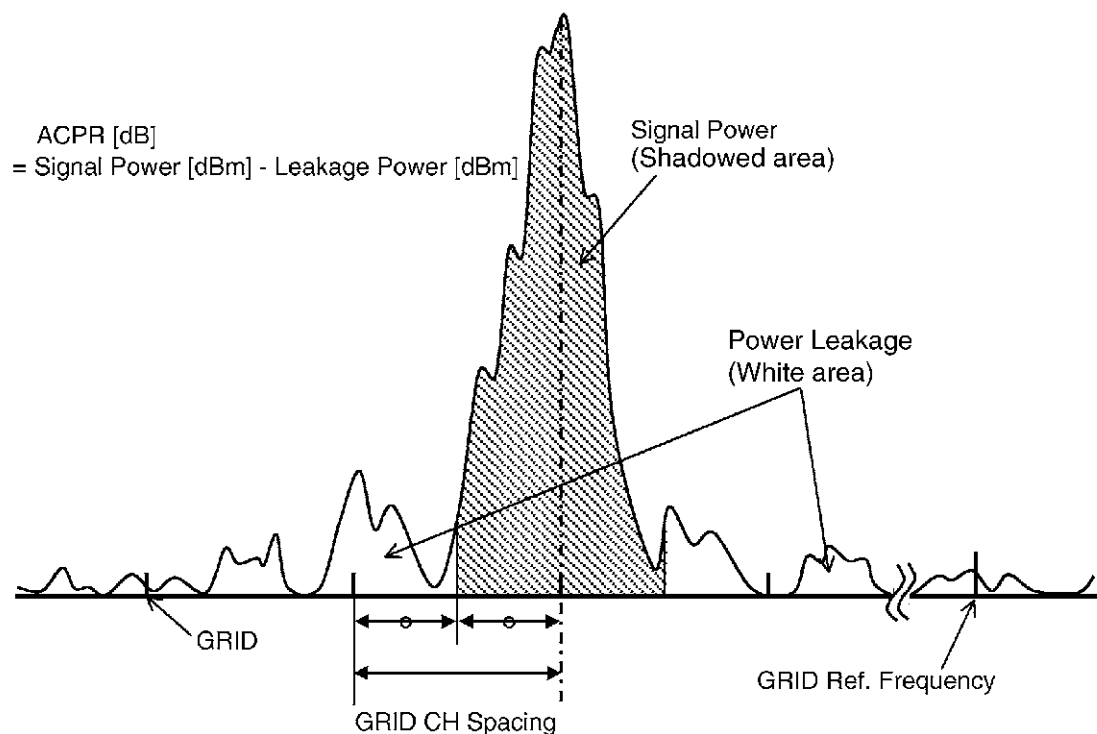

Figure 5-7 ACPR

5.9 Auto-Panning and Auto-Zooming Functions

The auto-panning and auto-zooming functions are used to interpolate or decimate measurement values automatically to match the number of sampling points when the number of sampling points or the conditions of the wavelength axis are changed.

These functions are performed under the following conditions:

- A change in the number of sampling points.
- A change in the center value or span of the wavelength axis.
- When the reference data and Loss/Trans data are measured under different conditions of the wavelength axis, the auto-panning or auto-zooming functions is performed for the reference data. (Refer to Section 2.2.6, "Measuring the Transmission-wavelength (or Loss-wavelength) Characteristics.")
- When the input and output signals of the amplifier are measured under different conditions of the wavelength axis to calculate the EDFA noise figure, the auto-panning and auto-zooming functions are performed for the input signal.

When the data is zoomed, data points are linearly interpolated.

When the data is panned, the excess data is unconditionally decimated.

5.10 Cursor Modes and Explanation for Displayed Data

The cursor modes and their display formats are as follows.

- NORMAL (when MAX HOLD and MIN HOLD are turned off)
 - $\lambda 1, I1$: Displays X cursor 1 wavelength, level
 - $\lambda 2, I2$: Displays X cursor 2 wavelength, level
 - L1, L2: Displays Y cursor 1, 2 level
- NORMAL (when MAX HOLD and MIN HOLD are turned on)
 - $\lambda 1, MX1, CR1, MN1$:
Displays the wavelength at X Cursor 1 and the levels for maxhold, current and minhold.
 - $\lambda 2, MX2, CR2, MN2$:
Displays the wavelength at X Cursor 2 and the levels for maxhold, current and minhold.
- Δ MODE (when MAX HOLD and MIN HOLD are turned off)
 - $\lambda 1, I1$: Displays X cursor 1 wavelength, level
 - $\Delta\lambda, \Delta I$: Displays wavelength difference, level difference between X cursors 1, 2
 - L1, ΔL : Displays Y cursor 1 level, level difference between Y cursor 1, 2
- Δ MODE (when MAX HOLD and MIN HOLD are turned on)
 - $\lambda 1, MM1, MC1, CM1$:
Displays the wavelength at X Cursor 1 and the level differences between maxhold and minhold, between maxhold and current, and between current and minhold.
 - $\lambda 2, MM2, MC2, CM2$:
Displays the wavelength at X Cursor 2 and the level differences between maxhold and minhold, between maxhold and current, and between current and minhold.
- 2ND PEAK

The data display format is as follows. The X cursor 1 automatically moves to the maximum peak and the X cursor 2 to the secondary peak.

 - $\lambda 1, I1$: Displays the peak wavelength, level
 - $\Delta\lambda, \Delta I$: Displays the wavelength difference and level difference between peak and 2nd peak
- POWER

X cursor 1 and X cursor 2 automatically move to the maximum peak.

 - $\lambda 1$: Displays the wavelength at X cursor 1
 - $\lambda 2$: Displays the wavelength at X cursor 2
 - ΣL : Displays the sum of the X cursor 1 and X cursor 2 levels
- PEAK TO PEAK

X cursor 1 and X cursor 2 automatically move to the maximum peak and the minimum level data, respectively. Only the peak values are used.

 - $\lambda 1, I1$: Displays the wavelength and level at X cursor 1
 - $\lambda 2, I2$: Displays the wavelength and level at X cursor 2
 - $\Delta\lambda, \Delta I$: Displays the wavelength difference and level difference between X cursor 1 and X cursor 2

5.11 Setting Limit Line

5.11 Setting Limit Line

To set the limit line, load the data file created in the specified format from a floppy disk into the optical spectrum analyzer.

Limit line data files should be created on external personal computers.

5.11.1 Data Files

Create data files in text format, and save them in the floppy disk root directory. File names are limited to lmtln1.txt thru lmtln5.txt (the uppercase and lowercase variations are ignored, and the 2-byte character mode cannot be used).

5.11.2 Limit Line Data

The limit line data consists of the header block and the data table.

- Header block

The headers below are used to set each item in the header block.

[FUNDAMENTAL]	measmode and domain
[ETC]	warning and label
[REFERENCE]	refmodex, userrefx, offsetx, refmodey, userrefy and offsety
[TABLEUP]	Specifies the upper limit line data.
[TABLELOW]	Specifies the lower limit line data.

Header blocks can be omitted as a general rule. If omitted, the initial values are used (however, either TABLEUP or TABLELOW must be specified).

The details for the above parameters are as follows:

measmode	Specifies a display mode for measurement data (Initial value: measmode=spectrum). Select a display mode from spectrum, peak normalize, loss and trans.
domain	Specifies a unit for the limit line data along the X axis (Initial value: domain=wave) Select a unit from wave (wavelength) and freq (frequency).
warning	Output when the measurement conditions (span) specified for a Pass/Fail judgment is narrower than the range (span) specified for the limit line (Initial value: warning=on). Select on and off.
label	The contents of a label is specified between a pair of double quotations. (The initial label cannot be changed.) Up to the first 48 characters are valid when 49 or more characters are specified.
refmodex	Specifies a description format for the limit line data table (in relative or absolute values). Select it from center, user and abs (Initial value: refmodex=abs).
center	A value (along the X-axis) relative to the specified center wavelength (frequency) is specified in the data table.
user	A value (along the X-axis) relative to the wavelength (frequency) specified by userrefx is specified in the data table.
abs	An absolute value along the X axis is specified in the data table.
userrefx	Specifies the reference wavelength [nm] (frequency [THz]) when refmodex is set to user (Initial value: userrefx=0).
offsetx	Offsets the limit line by the set value along the wavelength [nm] (frequency [THz]) (Initial value: offsetx=0).
refmodey	Specifies a description format for the limit line data table (in relative or absolute values). Select a format from ref, user and abs (Initial value: refmodey=abs).
ref	A value (along the Y-axis) relative to the specified ref level (or Display TOP

		Level if set to LOSS/TRANS) is specified in the data table.
	user	A value (along the X-axis) relative to the level specified by userrefy is specified in the data table.
	abs	An absolute value along the Y-axis is specified in the data table.
userrefy		Specifies the reference level [dB or dBm] when refmodey is set to user (Initial value: userrefy=0).
offsety		Offsets the limit line by the specified level [dB or dBm] along the Y-axis (Initial value: offsety=0).

- Limit line data

There are two types of limit lines: upper and lower limit lines.

The upper limit is defined by the [TABLEUP] header; and the lower limit, by the [TABLELOW] header (only one of them can be used).

Each data on each line represents a point on the measurement screen.

A limit line consists of lines which connect adjacent points.

Points, which consist of a wavelength (frequency) and a level, are delimited with a single comma (without a unit). Each points starts a new line (up to 1024 points can be specified for each line).

The units available for use are 0.001 [nm], 0.0001 [THz], 0.01 [dB] and 0.01 [dBm]. Always arrange points in ascending order of the X-axis. However, never arrange the points in the opposite direction to the X-axis, (thus resulting in returning the points to the origin) because this mode of arrangement is prohibited.

- Sample file

[FUNDAMENTAL]	'Header used to specify the display mode of a limit line.
measmode=trans	'Sets the display mode to the transmission characteristic measurement mode.
domain=wave	'Specifies the unit for the horizontal-axis waveform data.
[ETC]	'Header used to specify the presence or absence of a warning message, or a label.
warning=on	'Warns that the measurement range is narrower than that of the limit lines.
label="FILTER A"	'Enters a label.
[REFERENCE]	'Header used to specify the limit lines.
refmodex=user	'Sets limit line data along the X-axis in the user reference mode.
userrefx=1550.0	'Sets the reference wavelength to 1550 nm in the user reference mode.
offsetx=0	'Does not offset the limit line along the X-axis (Can be omitted).
refmodey=abs	'Sets limit line data along the Y axis in the absolute value mode.
userrefy=0.0	'Invalid because the limit line data along the Y axis is set using an absolute value (Can be omitted).
offsety=0	'Does not offset the limit line along the Y-axis (Can be omitted).
[TABLEUP]	'Header used to set the upper limit line. The points on the limit line are specified with X (wavelength) and Y (level) as shown below:
-20.0, -15.0	'Specifies the point consisting of a reference wavelength of 1550 nm-20 nm (1530 nm) and a level of -15 dB.
-10.0, -15.0	'Specifies the point consisting of a reference wavelength of 1550 nm-10 nm (1540 nm) and a level of -15 dB.
-5.0, -10.0	'Specifies the point consisting of a reference wavelength of 1550 nm-5 nm (1545 nm) and a level of -10 dB.

5.11 Setting Limit Line

-3.0, -3.0	'Specifies the point consisting of a reference wavelength of 1550 nm-3 nm (1547 nm) and a level of -3 dB.
0.0, 0.0	'Specifies the point consisting of a reference wavelength of 1550 nm-0 nm (1550 nm) and a level of -0 dB.
3.0, -3.0	'Specifies the point consisting of a reference wavelength of 1550 nm+3 nm (1553 nm) and a level of -3 dB.
5.0, -10.0	'Specifies the point consisting of a reference wavelength of 1550 nm+5 nm (1555 nm) and a level of -10 dB.
10.0, -15.0	'Specifies the point consisting of a reference wavelength of 1550 nm+10 nm (1560 nm) and a level of -15 dB.
20.0, -15.0	'Specifies the point consisting of a reference wavelength of 1550 nm+20 nm (1570 nm) and a level of -15 dB.

[TABLELOW] 'Header used to set the lower limit line. A point on a limit line is specified by X (wavelength) and Y (level) as shown below:

-20.0, -35.0	'Specifies the point consisting of a reference wavelength of 1550 nm-20 nm (1530 nm) and a level of -35 dB.
-5.0, -20.0	'Specifies the point consisting of a reference wavelength of 1550 nm-5 nm (1545 nm) and a level of -20 dB.
-3.0, -13.0	'Specifies the point consisting of a reference wavelength of 1550 nm-3 nm (1547 nm) and a level of -13 dB.
0.0, -10.0	'Specifies the point consisting of a reference wavelength of 1550 nm-0 nm (1550 nm) and a level of -10 dB.
3.0, -13.0	'Specifies the point consisting of a reference wavelength of 1550 nm+3 nm (1553 nm) and a level of -13 dB.
5.0, -20.0	'Specifies the point consisting of a reference wavelength of 1550 nm+5 nm (1555 nm) and a level of -20 dB.
20.0, -35.0	'Specifies the point consisting of a reference wavelength of 1550 nm+20 nm (1570 nm) and a level of -35 dB.

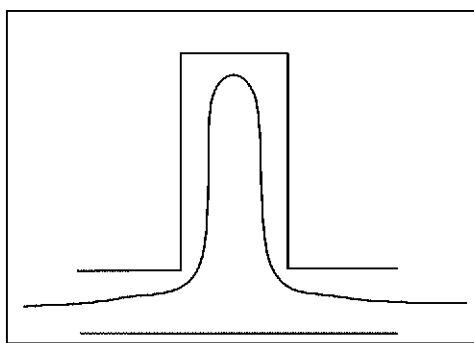

Limit Line Setting Example 1

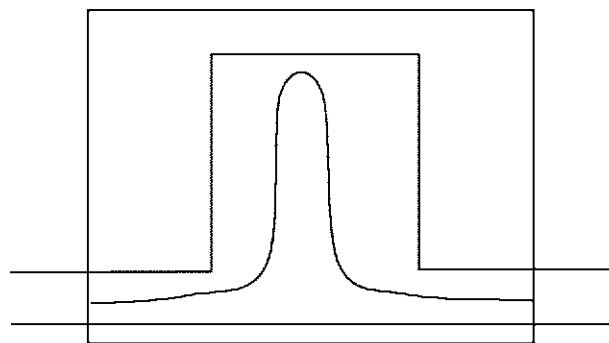

Limit Line Setting Example 2

In Example 1, the measurement range is outside of the limit line range. A PASS/FAIL judgment must always be made within the limit line range, and PASS is displayed in this example.

In Example 2, the limit line range is outside of the measurement range. When Warning is set to on, a warning is issued without making a Pass/Fail judgment. If Warning is set to off, PASS is displayed after a measurement is made within the measurement range.

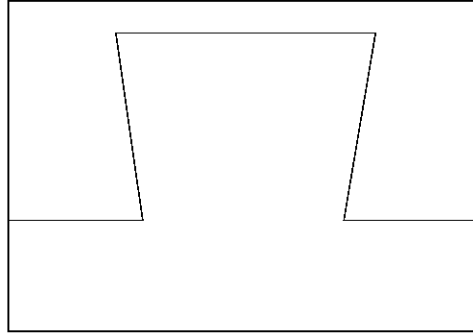

Limit Line Setting Example 3

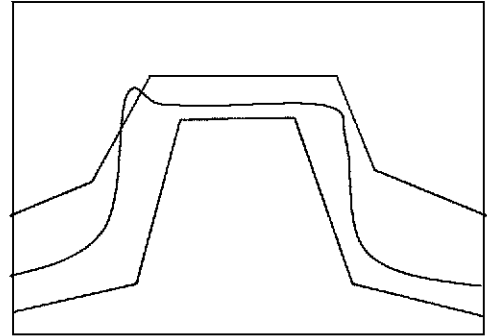

Limit Line Setting Example 4

In Example 3, LIMIT LINE FILE SYNTAX ERROR occurs and nothing will be displayed because the limit line is incorrectly set so that the points return back to the origin along the X-axis.

In Example 4, a part of the waveform is above the upper limit line. FAIL is displayed after the PASS/FAIL judgment has been made.

5.12 Operation Principle

5.12 Operation Principle

Figure 5-1 is a rough internal block diagram of the optical spectrum analyzer. The analyzer consists of the three blocks: the spectrum (monochromator), measurement control and display processing blocks.

The description below is the operating principle based on this block diagram.

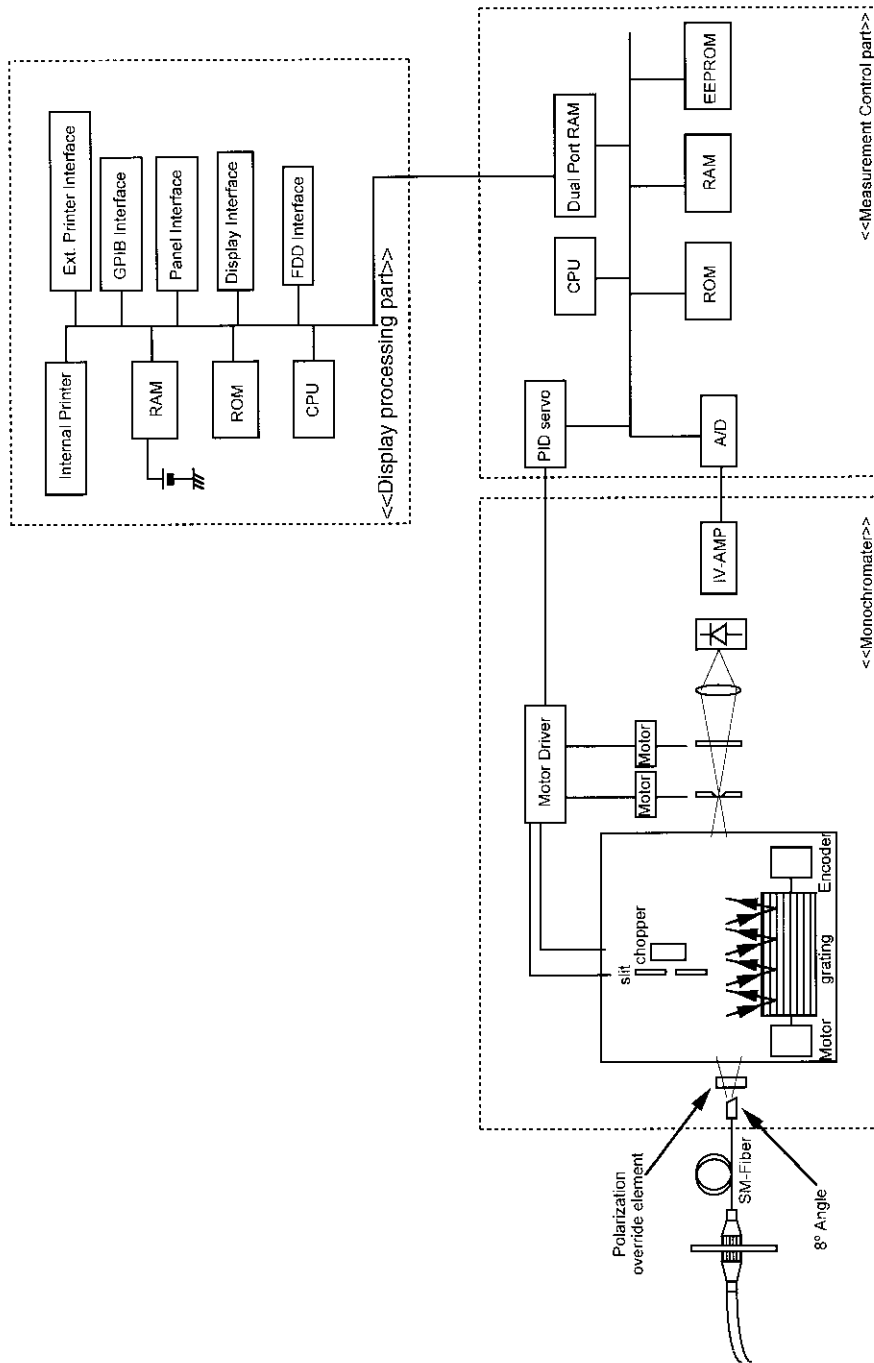

Figure 5-8 Block Diagram

(1) Spectrum block (Monochromator)

In the diffraction grating, there is a spectral characteristic that the angle of the reflecting light is different from the angle of the incident light depending on the wavelength of the incident light. The light to be measured is converted into parallel beam at the collimate mirror and the direction of the reflected light from the diffraction grating differs depending on the wavelength of the light to be measured. This analyzer uses a combination of a diffraction grating and a mirror so that the incident light is diffracted two times to obtain a better resolution. When the rotary angle of the diffraction grating is at a position that matches the incident light wavelength, the diffracted light passes through the converging mirror and the converged light at the mirror passes through the slit, and finally reaches the photodetector. The Q8384 employs the double-path method. Therefore, the light to be measured reaches the photodetector after it passes through the optical system two times. In addition, a special element is used at the monochromator input block to compensate for the polarization dependency (the diffraction efficiency changes depending on the state of the incident light polarization represented by the waves P and S) in order to obtain a constant level regardless of the polarization status.

Sweeping along the wavelengths is performed by rotating the diffraction grating. A high rotational position accuracy is obtained by directly driving the diffraction grating using a servo motor without reduction speed mechanism. In general, the wavelength resolution is determined by the incoming and outgoing slits. The resolution of this analyzer is determined by the intermediate slit typically used in the double-path method because this incoming slit is replaced by the core diameter of the input optical fiber. The intermediate slit has a function of permitting the light with the selected wavelength to be received at the photodetector. The width of the intermediate slit changes according to the set resolution and wavelength. The chopper in front of the intermediate slit chops the light to that it compensates for the offset of the stray light, detector and amplifiers to attain measurements with wide dynamic range. In addition, a light shutter is implemented at the outgoing slit block in order to measure the internal offset generated when the DC amplifier is activated. The photodetector consists of cooling-type InGaAs photodiodes. The light sensed at the photodiodes passes through the current-to-voltage conversion amplifier, range selection amplifier and then reaches the A/D converter. The amplifier block is composed of 11 ranges in increments of 10 dB where an optimum range is automatically selected based on the input signal level. The minimum range for a mode used varies depending on the sweep mode. Furthermore, under control of HI-Dynamic range mode, the signal passes through lock-in amplifiers. When under control of Pulse mode, the signal passes through other dedicated circuit (peak hold circuit).

(2) Measurement control part

This part controls the rotary angle of the diffraction grating, the slit width, and the measurement range, performs the A/D conversion, etc., and transfers the measurement data to the display processing part.

The digital servo circuit by the rotary encode is used for control of the rotary angle of the diffraction grating, allowing high speed, high precision position control.

The stepping motor is used for opening/closing the slit and rotating the chopper, to control the pulse count corresponding to the slit width and to control the pulse period corresponding to the chopper frequency.

Measurement range control includes the auto range control that selects the optimum range, and gate time control when under the pulse mode. The measurement timing (A/D conversion) by the external input signal "GATED MEAS INPUT" is also controlled.

There is also the EEPROM that stores the calibration data (wavelength offset, level offset, wavelength sensitivity offset, etc.) of each monochromator.

5.12 Operation Principle

(3) Display processing part

This part controls the measurement system by the conditions set through the panel keys or by the GP-IB, and performs various output processes (display, GP-IB, printer, floppy disk, etc.).

Data exchange with the measurement system is done through the dual-port memory. Measurement conditions as the center wavelength, span, resolution, sweep mode, etc. are sent, while measurement data are received. Wavelength sensitivity offset, display scaling, etc. are performed against the measurement data, and output to the display.

Analysis as cursor processing, spectral width operation, normalization operation, as well as save/recall against the memory/ floppy disk are done.

5.13 Notes on Using the Optical Spectrum Analyzer

Pay attention to the items shown below when using the optical spectrum analyzer.

5.13.1 Optical Fibers Suitable for the Optical Spectrum Analyzer

Single mode fibers with a mode field diameter of 9 μm to 10 μm are suitable for the optical spectrum analyzer. We recommend that the end face of input fiber be compliant with the super PC specifications and its accuracy be a master A class. If fibers that do not meet these specifications are used, measurements may not be accurate.

5.13.2 Stray Light

There is a possibility that a spurious of low level stray light (with a level of 30 to 50 dB below the level at the highest peak and a wavelength of 100 nm to 400 nm away from the highest peak) appears. If the waveform resolution is lowered, the stray light is reduced accordingly. As a result, to decrease the stray light, the wavelength resolution must be raised or the measurement mode must be set to Hi-Dynamic mode.

5.13.3 Secondary Diffracted Light

If the incident light wavelength is 633 nm, a secondary diffracted light (with a wavelength of 1266 nm) is usually observable, depending on the diffraction grating characteristics. This is caused by a characteristic of the diffraction grating, and is not a problem.

6 SPECIFICATIONS

The following is the specifications of this analyzer.

Characteristics		Specification	
Wavelength	Measurement range	600 nm to 1700 nm	
	Resolution	Setting	10 pm, 20 pm, 50 pm, 100 pm, 200 pm, 500 pm
		Accuracy (*1,*6)	±3% or less/resolution 50 pm (1530 nm to 1610 nm) ±2% or less/resolution 100 pm or more (1530 nm to 1610 nm)
	Accuracy		±500 pm or less
			±200 pm or less (After a calibration using an external light source) (*1)
			±20 pm (After a calibration using the built-in light source) (1530 nm to 1570 nm) (*1)
			±40 pm (After a calibration using the built-in light source) (1570 nm to 1610 nm) (*1)
	Linearity (*1)		±10 pm or less (1530 nm to 1570 nm)
			±20 pm or less (1570 nm to 1610 nm)
	Repeatability (*1,*4)		±3 pm or less (1530 nm to 1610 nm)
Level	Measurement range (*2,*3) (input sensitivity)	-87 dBm to +23 dBm (1250 nm to 1610 nm)	
		-77 dBm to +23 dBm (950 nm to 1250 nm, 1610 nm to 1700 nm)	
		-55 dBm to +23 dBm (600 nm to 950 nm)	
	Accuracy (*1,*3)	±0.4 dB or less (1550 nm)	
	Flatness (*1)	±0.2 dB or less (1530 nm to 1610 nm)	
	Repeatability (*1,*3,*4)	±0.02 dB or less (1530 nm to 1610 nm)	
Polarization dependency (*1,*3)	±0.05 dB or less (1250 nm to 1610 nm)		
Level	Dynamic range (*1,*5)	50 dB (±100 pm level difference from peak wavelength)	
		60 dB (±200 pm level difference from peak wavelength)	
		67 dB (±400 pm level difference from peak wavelength, High DR mode)	

6 SPECIFICATIONS

Characteristics		Specification
Sweep	Span	Full span from 0.2 nm and zero span
	Sampling points	101, 201, 501, 1001, 2001, 5001, 10001
	Measurement time	500 msec or less (10 nm span, Normal mode, 1550 nm, 501 points)
Pulse light measurement	Peak hold mode	Minimum light pulse width: 10 ns (Recommended light pulse width: 30 μsec or more) Pulse light repetition frequency: 1 Hz or more Gate time: 1ms to 10 s
	External synchronization mode	Synchronization signal input level: 74 AC (Hi:3.5 V, Lo:1.5 V) Synchronization signal pulse width: 10 ns or more.
	Sync Low mode	Synchronization signal (Input): Positive logic Minimum light pulse width: 10 ns (Recommended light pulse width: 30 μsec or more)
	Sync Hi mode	Synchronization signal (Input): Leading edge Sampling time: 0 to 1000 μsec
Processing function	Memory function	Internal RAM: Measurement data; 15 or more screens (Sampling points 501, battery backup) Internal FD: 3.5-inch 2HD 1.44 MB with the MS-DOS format
	Display	Horizontal display in wavelengths or frequencies, Superimpose display, Dual Screen display, cursor display and Multi-Trace display (Up to 32 traces)
	Operation/analysis	Auto peak search, auto peak center, auto reference, spectrum analysis (threshold, envelope, RMS, Peak RMS, Xnm level), notch width analysis (XdB width and Xnm level), WDM signal analysis (wavelengths, levels, ITU-T grids and SNRs of up to 256 channel), optical amplifier NF analyzer function (up to 256 channel), normalization using the zooming function (LOSS/TRANS), the peak power monitor function (with trend-chart), and WDM monitor function and limit line function
	Others	Calibration function for the built-in and external light sources, calibration function for wavelength and level offset, and labeling function
Input/ Output	Input connector	FC type (standard), ST type, Sc type (Optional)
	Input Fiber	9.5/125 μm SM fiber (Master A grade connector is recommended.)
	Return loss	35 dB
	Data output	GPIB standard, internal/external printer

Characteristics		Specification
General specifications	Operation environment	Temperature +10°C to +40°C, relative humidity 85% or less (no condensation)
	Shelf environment	Temperature -10°C to +50°C, relative humidity 90% or less (no condensation)
	Power supply	100 VAC to 120 VAC or 220 VAC to 240 VAC, 50/60 Hz, 200 VA or less
	External dimension	Approx. 424(W) x 221(H) x 500(D) mm
	Mass	29 kg or less
Optional Built-in EE-LED light source	Center Wavelength	Approx. 1550 nm
	Power (*1)	-45 dBm/nm or more (at 1550 nm)

*1: With 23°C ± 5°C

*2: With 10°C to 30°C

*3: With 100 pm resolution

*4: 1 minute repeat sweep

*5: With wavelength 1523 nm (10 pm resolution)

*6: Calibrated using the effective bandwidth

APPENDIX

A.1 Error Messages

Message	Description
LIGHT POWER IS TOO LOW	The light source power level of the used for calibration or alignment is too low.
LIGHT SOURCE ERROR	The light source used for calibration is inappropriate.
TOO LARGE ERROR	The light source wavelength used for calibration or alignment is very different from the specified value.
DISK FORMATTING FAILED	The floppy disk cannot be formatted.
FLOPPY MEDIA TYPE[2DD/2HD] ERROR	When formatting, a wrong floppy disk is inserted.
DISK FULL	There is no disk space to create a new file.
MEMORY FULL	There is no disk space to create a new file in the internal data memory.
DISK READ ERROR	Cannot read data from the disk correctly.
DISK WRITE ERROR	Cannot write data on the disk correctly.
ILLEGAL FILE NAME	When writing data, an illegal file name was assigned.
CAN'T DELETE	The file in the disk cannot be deleted.
MEDIA NOT IN DRIVE	No disk is inserted in the drive.
TOO MANY FILES TO WRITE	The number of files exceeds the maximum value.
INTERVAL TIME IS TOO SHORT	Warning issued when the actual measurement could not be completed within the measurement interval set prior to starting the peak power monitor or WDM monitor.
PEAK NOT FOUND	The peak of the waveform cannot be detected.
PRINTER ERROR (EXT. PRT)	Abnormal conditions are detected in the external printer cable, or the printer is out of paper.
NO PRINTER PAPER (INT. PRT)	The built-in printer runs out of paper.
PRINTER HEAD UP (EXT. PRT)	The printer head is in the raised position.
PRINTER IS NOT READY	The external printer cannot print.
PRINTER NOT RESPONDING	The external printer does not respond to commands.
LIMIT FILE NOT FOUND	No limit line data was found in the floppy disk.
PATTERN X NOT LOADED	The specified limit line data has not been loaded into memory.
DIFFERENT MEAS MODE	The mode for the limit line data does not match the current measurement mode.
LIMIT LINE PATTERN NOT SELECTED	A Pass/Fail judgment was attempted when no lines were being displayed.
LIMIT LINE EXCEEDS MEASUREMENT AREA	The specified limit line is exceeding the measurement range (displayed only when Warning is turned on).
LIMIT LINE SYNTAX ERROR	Syntax error in the limit line error

Items have the following meanings.

- (1) Manufacturer, model name, software version and type of analysis data
 - (2) Label and time
 - (3) Center wavelength [m], span wavelength [m], start wavelength [m] and stop wavelength [m]
 - (4) Number of point averages, number of sweep averages, number of smoothing processes, REF LEVEL, vertical scale, Linear/Log ON/OFF
 - (5) Frequency mode ON/OFF, number of sampling processes, wavelength resolution, measurement mode, MAX HOLD ON/OFF, MIN HOLD ON/OFF, PM ON/OFF (peak power monitor)
 - (6) λ offset and level offset
 - (7) PM N-MAX, PM interval, PM wavelength, PM minimum, PM maximum and PM average
 - (8) Empty
 - (9) Displaying the measurement data
 - (10) Measurement data [nm], [dBm]
- * When the horizontal axis is set to the frequency mode, FRQ is 1 and items (3) and (10) are as follows:
For (3), center frequency [Hz], span frequency [Hz], start frequency [Hz] and stop frequency [Hz].
For (10), Measurement data [THz], [dBm]
- * When the vertical axis is set to the linear, LIN is 1 and item (10) (measurement data power level) is changed to a power level [mW].

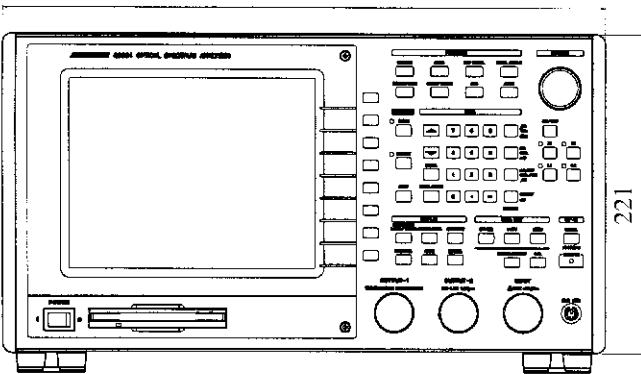

424

221

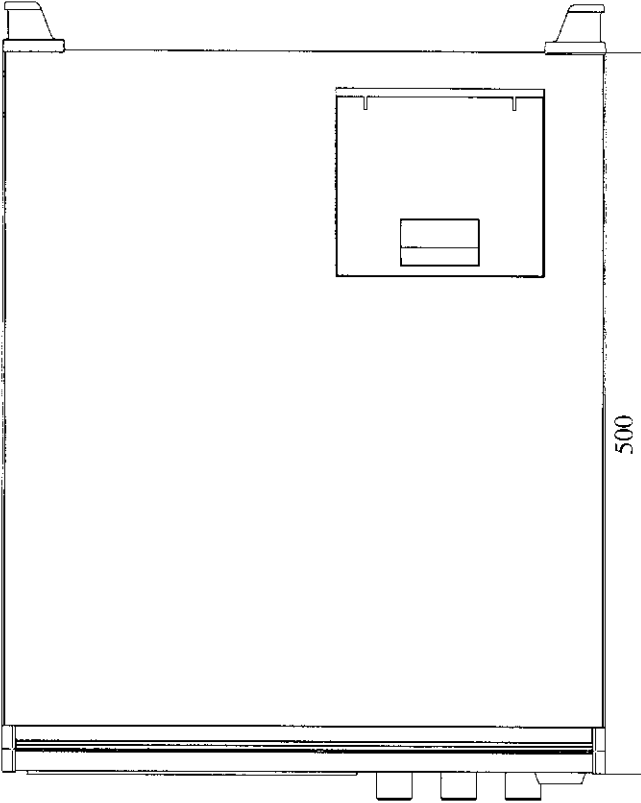

500

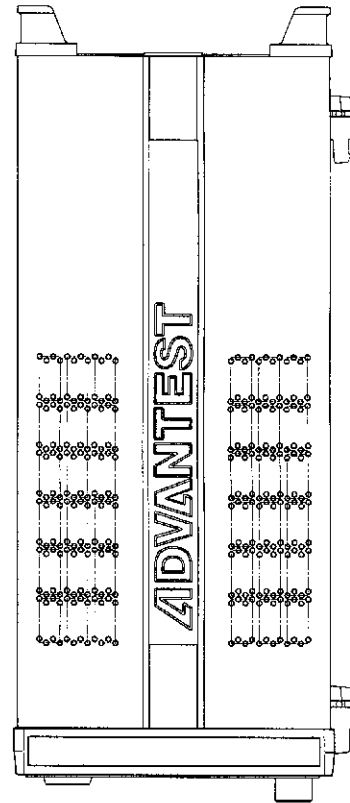
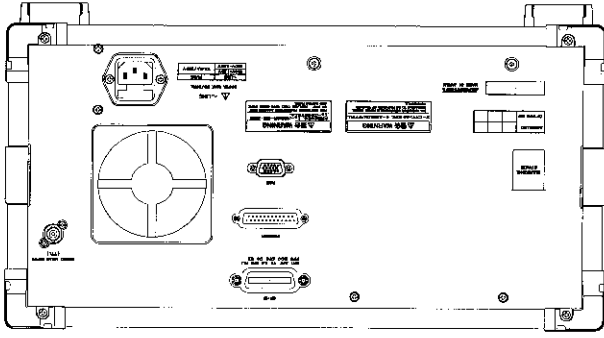

Unit : mm

CAUTION

This drawing shows external dimensions of this instrument.

The difference in products and options used can cause a change in the appearance of the instrument.

DIMENSIONAL OUTLINE DRAWING

ALPHABETICAL INDEX

[Symbol]		
↑	3-9, 3-10, 3-11, 3-12, 3-29, 3-31, 3-34, 3-37, 3-39, 3-40
↓	3-9, 3-10, 3-11, 3-12, 3-29, 3-31, 3-34, 3-37, 3-39, 3-40
←	3-9, 3-10, 3-11, 3-12, 3-15, 3-17, 3-29, 3-31, 3-34, 3-37, 3-39, 3-40, 3-45, 3-52
→	3-9, 3-10, 3-11, 3-12, 3-15, 3-17, 3-29, 3-31, 3-34, 3-37, 3-39, 3-40, 3-45, 3-52
ΔMODE	3-13, 3-42
λ Drift Lmt	3-11, 3-35
λ OFFSET	3-17, 3-51
λ.f	3-10, 3-33
λ1	3-13
λ1 Key	3-42
λ2	3-13
λ2 Key	3-42
[Numerics]		
0.01nm	3-7, 3-22
0.02nm	3-7, 3-22
0.05nm	3-7, 3-22
0.1dB/D	3-6, 3-21
0.1nm	3-7, 3-22
0.2dB/D	3-6, 3-21
0.2nm	3-7, 3-22
0.5dB/D	3-6, 3-21
0.5nm	3-7, 3-22
1(OFF)	3-7, 3-25
10001	3-14, 3-44
1001	3-14, 3-44
101	3-14, 3-44
10dB/D	3-6, 3-21
11	3-7, 3-26
16	3-7, 3-25
1dB/D	3-6, 3-21
2	3-7, 3-25
2001	3-14, 3-44
201	3-14, 3-44
2dB/D	3-6, 3-21
2DD(720K)	3-16, 3-48
2HD(1.44M)	3-16, 3-48
2ND PEAK	3-13, 3-42
3	3-7, 3-25
3.5-inch floppy disk	1-2
32	3-7, 3-25
4	3-7, 3-25
5	3-7, 3-25
5001	3-14, 3-44
501	3-14, 3-44
5dB/D	3-6, 3-21
64	3-7, 3-25
7	3-7, 3-26
8	3-7, 3-25
9	3-7, 3-26
[A]		
ABORT	3-8, 3-26
ABSOLUTE	3-10, 3-34
absolute/relative	3-10, 3-34
Accessories	1-2
acpr	3-9, 3-40
ACPR (Adjacent Channel Leakage Power Ratio)	5-21
ACPR (Adjacent Channel Leakage Power Ratio) Measurement	2-34
ACPR Output Data	5-21
ACT U&L ON/OFF	3-14, 3-43
ADAPTIVE	3-7, 3-23
ADDRESS DOWN	3-17, 3-50
ADDRESS UP	3-17, 3-50
ADVANCE	3-13
ADVANCE Key	3-41
Alignment	2-24
APPLICATION	3-9
APPLICATION Key	3-28
ASE Converted NBW	3-10, 3-11, 3-32, 3-36
ASE Fitting	3-9, 3-10, 3-11, 3-30, 3-31, 3-35
ASE NBW	3-10, 3-11, 3-32, 3-36
AUTO	3-8
AUTO ALIGNMENT	3-17, 3-51
AUTO Key	3-26

Alphabetical Index

AUTO ON/OFF 3-14, 3-44
 AUTO PASS/FAIL ON/OFF 3-13, 3-41
 AUTO PKC ON/OFF 3-6, 3-18
 AUTO RELV ON/OFF 3-6, 3-20
 AUTO TRAC ON/OFF 3-14, 3-43
 Auto-Panning and
 Auto-Zooming Functions 5-22
 Averaging Functions 5-2
 AVG 3-7
 AVG Key 3-25

[B]

Backup Memory 2-64
 Basic Operation 2-12
 BEEP ON/OFF 3-16, 3-49
 bit map 3-16, 3-48
 buzzer 3-16, 3-49

[C]

CAL 3-17
 CAL Key 3-51
 CAL λ (Ext.) 3-17, 3-51
 CAL λ (Int.) 3-17, 3-51
 Calculating Isolation 5-14
 Calculating the Half-height Width and
 the Notch Width 5-3
 Calculating Various Bands 5-12
 Calibration 1-13, 2-26
 CENTER 3-6
 CENTER Key 3-18
 Cleaning 1-10
 Cleaning, Storing and Transporting
 the Q8384 Optical Spectrum Analyzer ... 1-10
 CLEAR LINE 3-17, 3-52
 clock 3-16, 3-48
 CLOSE 3-9, 3-10,
 3-11, 3-12,
 3-29, 3-31,
 3-34, 3-37,
 3-39, 3-40
 color 3-16, 3-48
 COMMAND:ESC/P 3-16, 3-47
 COMMAND:ESC/P RAS 3-16, 3-47
 COMMAND:HP PCL 3-16, 3-47
 COMPRESS ON/OFF 3-16, 3-48
 Connector Section 2-8
 CONTROL 3-14
 CONTROL Key 3-43
 COPY 3-17
 COPY Key 3-50
 CUR+MEAS1→CURRENT 3-8, 3-27
 CUR-MEAS1→CURRENT 3-8, 3-27

CURRENT SELECT 3-10, 3-36
 Cursor Modes 5-23
 CURSOR Section 2-4
 CURSOR SPAN 3-6, 3-19
 CURSOR→CENTER 3-6, 3-18
 CURSOR→REF LEVEL 3-6, 3-20

[D]

data mode 3-10, 3-33
 DATA OUT Section 2-7
 DATA Section 2-5
 DAY 3-16, 3-49
 Defaults Configuration Values 3-53
 DELAY 3-7, 3-24
 DELETE 3-15, 3-45
 DELETE ALL 3-14, 3-43
 DELETE CHAR 3-17, 3-52
 DELETE CURRENT 3-14, 3-43
 DEVICE 3-16
 device 3-9, 3-37
 Device Clear Function 4-33
 DEVICE Key 3-47
 Device Triggering Function 4-33
 DFB-LD 5-18
 dfb-ld 3-11, 3-39
 DFB-LD Output Data 5-18
 DIRECTORY 3-16, 3-47
 DISPLAY MONI/SPEC 3-10, 3-33
 DISPLAY ON/OFF 3-16, 3-48
 DISPLAY Section 2-6
 DUAL ON/OFF 3-14, 3-43

[E]

EDGE RISE/FALL 3-7, 3-24
 ENTER 3-15, 3-17,
 3-45, 3-52
 Entering Label Data 2-61
 ENVELOPE 3-9, 3-28,
 5-4
 Environmental Conditions 1-4
 Example Programs 4-50
 EXECUTE 3-16, 3-17,
 3-47, 3-51
 EXIT 3-15, 3-45,
 3-46
 EXT KEY US/JP 3-16, 3-48
 EXTERNAL PRINTER 3-16, 3-47
 external printer 3-16, 3-47

[F]

Fan filter 1-2
 FC connector 1-2

- FEED 3-17
 FEED Key 3-50
 Filter $\Delta\lambda$ 3-9, 3-30
 Filter Tilt 5-17
 filter tilt 3-11, 3-39
 Filter Tilt Output Data 5-17
 Fitting Span 3-9, 3-10,
 3-11, 3-30,
 3-32
 Fitting span 3-35
 floppy 3-16, 3-47
 FLOPPY DISK 3-16, 3-47
 Floppy Disk 2-63
 format 3-16, 3-47
 FP-LD 5-18
 fp-ld 3-11, 3-39
 FP-LD Output Data 5-18
 Front Panel 2-1
 FULL SPAN 3-6, 3-19
 FUNCTION Section 2-3
 Functional Description 3-18
- [G]**
- GAIN 5-10
 GAIN&NF 5-8
 GATE TIME 3-7, 3-24
 GPIB Command Codes 4-36
 GPIB Command Index 4-1
 GP-IB Section 2-7
 Graph All Data 3-11, 3-34
 GRAPH X TIME/CH 3-10, 3-33
 GRID CH Spacing 3-10, 3-11,
 3-12, 3-32,
 3-35, 3-37,
 3-40
 GRID ON/OFF 3-14, 3-43
 GRID Ref Frequency 3-10, 3-11,
 3-12, 3-32,
 3-35, 3-37,
 3-40
- [H]**
- Half Band Threshold 3-11, 3-37
 Hard Copy 2-66
 HEADER ON/OFF 3-17, 3-50
 HI DYNAMIC1 3-7, 3-23
 HI DYNAMIC2 3-7, 3-23
 HI-SENS1 3-7, 3-23
 HI-SENS2 3-7, 3-23
 HOUR 3-16, 3-49
- [I]**
- INITIAL 3-10, 3-34
 INSERT SPACE 3-17, 3-52
 INSTR PRESET 3-17
 INSTR PRESET Key 3-50
 Interface Functions 4-5
 INTERNAL PRINTER 3-16, 3-47
 INTERVAL TIME 3-13, 3-41
 INTRODUCTION 1-1
 Isolation Pass 3-11, 3-38
 Isolation Stop 3-11, 3-38
 ITU GRID 3-10, 3-31
- [K]**
- K 3-9, 3-28
 Kr(RMS) 3-9, 3-28
- [L]**
- L1 3-13
 L1 Key 3-42
 L2 3-13
 L2 Key 3-43
 LABEL 3-17
 LABEL Key 3-52
 LCD Display Section 2-2
 LD Performance Analysis 5-18
 LED 5-20
 led 3-11, 3-40
 LED Output Data 5-20
 LEFT PEAK 3-13, 3-42
 LEVEL 3-9, 3-10,
 3-29, 3-33
 Level Lower Lmt 3-11, 3-35
 LEVEL OFFSET 3-17, 3-51
 LEVEL SCALE 3-6
 LEVEL SCALE Key 3-21
 Level Upper Lmt 3-11, 3-35
 Light amplifier Characteristic Analysis .. 2-37
 Light source used for calibration 1-2
 Light Spectrum Measurement 2-14
 limit line 3-13, 3-41
 Limit Line Data 5-24
 Limited-life Part 1-2
 LIST ALL ON/OFF 3-10, 3-32
 List of Settings 3-53
 LOAD PATTERN FILES 3-13, 3-41
 LOCAL 3-17
 LOCAL Key 3-50
 LOSS 3-8, 3-27
 LVL SCALE LIN/LOG 3-6, 3-21

Alphabetical Index

[M]

Manual ASE Level 3-9, 3-10,
3-11, 3-30,
3-32, 3-35

Masked Span 3-9, 3-10,
3-11, 3-30,
3-31, 3-35

MAX HOLD ON/OFF 3-6, 3-20

MAX HOLD→CURRENT 3-6, 3-20

MEASURE Section 2-4

Measurement Modes 5-1

Measurement Times 3-11, 3-34

Measuring the Transmission-wavelength
(or Loss-wavelength) Characteristics 2-29

Menu Index 3-1

Menu Map 3-6

MENU OUT ON/OFF 3-16, 3-47

Method 3-9, 3-30

MIN HOLD ON/OFF 3-6, 3-20

MIN HOLD→CURRENT 3-6, 3-20

MINUTE 3-16, 3-49

MODE SNG/WDM 3-9, 3-29

MODE:COLOR 3-16, 3-48

MODE:GRAY 3-16, 3-47,
3-48

MODE:MONO 3-16, 3-48

MODE:MONO L 3-16, 3-47

MODE:MONO S 3-16, 3-47

MONTH 3-16, 3-48

MULTI PEAK 3-10, 3-31

multi trace 3-14, 3-43

[N]

name 3-15, 3-45

NAME CLEAR 3-15, 3-45

NEXT 3-14, 3-43

NEXT PAGE 3-9, 3-10,
3-11, 3-29,
3-31, 3-34,
3-38

NF 5-10

NF K 3-9, 3-30

NF Select 3-9, 3-30

NOMINAL 3-10, 3-34

Nominal Level 3-11, 3-35

Nominal SNR 3-11, 3-35

NORMAL 3-7, 3-13,
3-23, 3-42

NORMALIZE LOSS/TRANS 3-8

NORMALIZE LOSS/TRANS Key 3-27

Notch Width 5-6

notch width 3-9, 3-29

Notes on Using
the Optical Spectrum Analyzer 5-31

[O]

o-bpf 3-11, 3-37

OFF 3-9, 3-10,
3-11, 3-12,
3-13, 3-14,
3-29, 3-31,
3-33, 3-36,
3-38, 3-39,
3-40, 3-41,
3-42, 3-43

ON/OFF 3-13

ON/OFF Key 3-42

Operating Environment 1-4

Operating Menus and Entering Data 2-12

OPERATION 2-1

Operation Principle 5-28

opt.amp 3-9, 3-29

Optical BPF Analysis 5-12

Optical Fibers Suitable for
the optical spectrum analyzer 5-31

Option 1-2

Output Data 5-16

Outputting Data 2-66

Overview of GPIB 4-4

[P]

Panel Description 2-1

parameter 3-7, 3-9,
3-10, 3-11,
3-12, 3-23,
3-28, 3-29,
3-31, 3-34,
3-37, 3-39,
3-40

Pass Band Threshold 3-11, 3-37

PASS/FAIL 3-13, 3-41

Pass/Fail Enable 3-11, 3-35

pattern select 3-13, 3-41

PATTERN-1 3-16, 3-48

PATTERN1 3-13, 3-41

PATTERN-2 3-16, 3-48

PATTERN2 3-13, 3-41

PATTERN-3 3-16, 3-48

PATTERN3 3-13, 3-41

PATTERN-4 3-16, 3-48

PATTERN4 3-13, 3-41

PATTERN-5 3-16, 3-48

PATTERN5 3-13, 3-41

Peak Excursion 3-9, 3-10,

3-11, 3-12,
3-30, 3-32,
3-35, 3-39

PEAK NORMALIZE 3-8, 3-27

Peak Power Monitor Measurement 2-21

peak power-mon 3-13, 3-41

PEAK RMS 3-9, 3-28

Peak RMS 5-5

PEAK THRESHOLD 5-3

PEAK TO PEAK 3-13, 3-42

PEAK→CENTER 3-6, 3-18

PEAK→REF LEVEL 3-6, 3-20

PEAK-THRESHOLD 3-9, 3-28

Pin Loss 3-9, 3-30

point average 3-7, 3-25

Pout Loss 3-9, 3-31

POWER 3-13, 3-42

Power Cable 1-7

Power cable 1-2

Power Fuse 1-6

Power fuse 1-2

Power Monitor Measurement 2-22

Power Requirements 1-5

POWER Switch/Floppy Disk
Drive Section 2-8

PRESET 3-17, 3-50

PREV 3-14, 3-43

PREVIOUS PAGE 3-9, 3-10,
3-11, 3-29,
3-31, 3-34,
3-38

Print paper 1-2

printer 3-16, 3-47

Product Overview 1-1

Program Code 4-6

PULSE 3-7, 3-23

[Q]

QUIET ON/OFF 3-16, 3-49

[R]

Reading Data 2-65

Rear Panel 2-11

RECALL 3-15, 3-46

RECALL Key 3-46

RECALL MEAS 1 3-15, 3-46

RECALL MEAS 2 3-15, 3-46

RECALL MEAS 3 3-15, 3-46

recall meas data 3-15, 3-46

RECALL MEM/FDD 3-15, 3-46

RECALL OFFSET ON/OFF 3-17, 3-51

RECALL REF DATA 3-15, 3-46

RECOVER 3-15, 3-45

REF LEVEL 3-6

REF LEVEL Key 3-20

REFERENCE 3-1, 3-10,
3-33

RELATIVE 3-10, 3-31

REMOTE CONTROL 4-1

REPEAT 3-8

REPEAT Key 3-26

Replacing and Cleaning
the Optical-Connector Adapter of Q8384 1-11

RESOLUTION 3-7

RESOLUTION Key 3-22

RIGHT PEAK 3-12, 3-42

Ripple Select 3-11, 3-37

RMS 3-9, 3-28,
5-4

[S]

S.IMPOSE ON/OFF 3-14, 3-43

Sample Programs for Setting or
Reading Measurement Conditions 4-50

SAMPLING POINT 3-13, 3-41

sampling point 3-14, 3-44

SAVE 3-15, 3-45

SAVE Key 3-45

SAVE MEAS 1 3-8, 3-15,
3-27, 3-45

SAVE MEAS 2 3-15, 3-45

SAVE MEAS 3 3-9, 3-15,
3-31, 3-45

save meas data 3-15, 3-45

SAVE MEM/FDD 3-15, 3-45

SAVE Pin→REF DATA 3-9, 3-31

SAVE REF DATA 3-8, 3-15,
3-27, 3-45

Saving Data 2-64

Saving or Reading Data 2-63

SC connector 1-2

SCALE 3-10, 3-33

Screen Annotation 2-9

Search Area Pass 3-11, 3-37

Search Area Stop 3-11, 3-38

Secondary Diffracted Light 5-31

select output 3-16, 3-47

Selecting Color Patterns on the Screen ... 2-62

SELF TEST 3-17, 3-50

Setting Date/Time 2-62

Setting the print paper 1-9

SHIFT X 3-13, 3-41

shift X/Y 3-13, 3-41

SHIFT Y 3-13, 3-41

SHOW PARAM ON/OFF 3-13, 3-41

Alphabetical Index

Signal Power Mode 3-10, 3-32
 SINGLE 3-8
 SINGLE Key 3-26
 smoothing 3-7, 3-25
 SNR 3-10, 3-31, 3-33, 5-8
 SNR Lower Lmt 3-11, 3-35
 SPAN 3-6, 3-19
 SPAN Key 3-19
 SPE DIV 5-11
 SPECIFICATIONS 6-1
 spectral width 3-9, 3-28
 ST connector 1-2
 Standard Accessories 1-2
 START 3-6, 3-8, 3-19, 3-26
 Start Wavelength 3-11, 3-39
 State Changes According to the Commands 4-34
 Status Byte 4-35
 Std Wavelength 3-11, 3-38
 STOP 3-6, 3-8, 3-19
 Stop Band Threshold 3-11, 3-37
 STOP Key 3-26
 Stop Wavelength 3-11, 3-39
 Storing 1-10
 Stray Light 5-31
 sweep average 3-7, 3-25
 SWEEP MODE 3-7
 SWEEP MODE Key 3-23
 SYNC HI/LOW 3-7, 3-23
 System Checkout 1-8

[T]

Talker Formats 4-7
 TBL CONT TIME/CH 3-10, 3-33
 TECHNICAL NOTES 5-1
 Threshold Level 3-9, 3-10, 3-11, 3-30, 3-32, 3-35
 Threshold Level 1 3-12, 3-39
 Threshold Level 2 3-12, 3-40
 THRESHOLD LVL1(dB) 3-9, 3-28
 THRESHOLD LVL2(dB) 3-9, 3-28
 Tilt Calculation Function 5-17
 Time Interval 3-11, 3-34
 TRACE MAX 3-14, 3-43
 TRANS 3-8, 3-27
 Transporting 1-13

[U]

UNDO 3-17, 3-52
 Using Expanded Functions and Inputting/Outputting Data 2-61

[W]

Warm-up time 1-13
 WARNING ON/OFF 3-16, 3-49
 WAVE/FREQ nm/THz 3-6, 3-19
 wdm 3-9, 3-31
 WDM ASE Method 3-9, 3-10, 3-11, 3-30, 3-31, 3-36
 WDM Light Signal Characteristic Analysis 2-41
 wdm monitor 3-9, 3-33
 WIDTH 3-9, 3-28, 3-29

[X]

X-CHANGE UPR/LOW 3-14, 3-44
 XdB WIDTH 3-9, 3-29, 5-6
 Xnm LEVEL 3-9, 3-28, 3-29
 Xnm Level 5-5, 5-7

[Y]

YEAR 3-16, 3-48

IMPORTANT INFORMATION FOR ADVANTEST SOFTWARE

PLEASE READ CAREFULLY: This is an important notice for the software defined herein. Computer programs including any additions, modifications and updates thereof, operation manuals, and related materials provided by Advantest (hereafter referred to as "SOFTWARE"), included in or used with hardware produced by Advantest (hereafter referred to as "PRODUCTS").

SOFTWARE License

All rights in and to the SOFTWARE (including, but not limited to, copyright) shall be and remain vested in Advantest. Advantest hereby grants you a license to use the SOFTWARE only on or with Advantest PRODUCTS.

Restrictions

- (1) You may not use the SOFTWARE for any purpose other than for the use of the PRODUCTS.
- (2) You may not copy, modify, or change, all or any part of, the SOFTWARE without permission from Advantest.
- (3) You may not reverse engineer, de-compile, or disassemble, all or any part of, the SOFTWARE.

Liability

Advantest shall have no liability (1) for any PRODUCT failures, which may arise out of any misuse (misuse is deemed to be use of the SOFTWARE for purposes other than its intended use) of the SOFTWARE. (2) For any dispute between you and any third party for any reason whatsoever including, but not limited to, infringement of intellectual property rights.

LIMITED WARRANTY

1. Unless otherwise specifically agreed by Seller and Purchaser in writing, Advantest will warrant to the Purchaser that during the Warranty Period this Product (other than consumables included in the Product) will be free from defects in material and workmanship and shall conform to the specifications set forth in this Operation Manual.
2. The warranty period for the Product (the "Warranty Period") will be a period of one year commencing on the delivery date of the Product.
3. If the Product is found to be defective during the Warranty Period, Advantest will, at its option and in its sole and absolute discretion, either (a) repair the defective Product or part or component thereof or (b) replace the defective Product or part or component thereof, in either case at Advantest's sole cost and expense.
4. This limited warranty will not apply to defects or damage to the Product or any part or component thereof resulting from any of the following:
 - (a) any modifications, maintenance or repairs other than modifications, maintenance or repairs (i) performed by Advantest or (ii) specifically recommended or authorized by Advantest and performed in accordance with Advantest's instructions;
 - (b) any improper or inadequate handling, carriage or storage of the Product by the Purchaser or any third party (other than Advantest or its agents);
 - (c) use of the Product under operating conditions or environments different than those specified in the Operation Manual or recommended by Advantest, including, without limitation, (i) instances where the Product has been subjected to physical stress or electrical voltage exceeding the permissible range and (ii) instances where the corrosion of electrical circuits or other deterioration was accelerated by exposure to corrosive gases or dusty environments;
 - (d) use of the Product in connection with software, interfaces, products or parts other than software, interfaces, products or parts supplied or recommended by Advantest;
 - (e) incorporation in the Product of any parts or components (i) provided by Purchaser or (ii) provided by a third party at the request or direction of Purchaser or due to specifications or designs supplied by Purchaser (including, without limitation, any degradation in performance of such parts or components);
 - (f) Advantest's incorporation or use of any specifications or designs supplied by Purchaser;
 - (g) the occurrence of an event of force majeure, including, without limitation, fire, explosion, geological change, storm, flood, earthquake, tidal wave, lightning or act of war; or
 - (h) any negligent act or omission of the Purchaser or any third party other than Advantest.
5. **EXCEPT TO THE EXTENT EXPRESSLY PROVIDED HEREIN, ADVANTEST HEREBY EXPRESSLY DISCLAIMS, AND THE PURCHASER HEREBY WAIVES, ALL WARRANTIES, WHETHER EXPRESS OR IMPLIED, STATUTORY OR OTHERWISE, INCLUDING, WITHOUT LIMITATION, (A) ANY WARRANTY OF MERCHANTABILITY OR FITNESS FOR A PARTICULAR PURPOSE AND (B) ANY WARRANTY OR REPRESENTATION AS TO THE VALIDITY, SCOPE, EFFECTIVENESS OR USEFULNESS OF ANY TECHNOLOGY OR ANY INVENTION.**
6. **THE REMEDY SET FORTH HEREIN SHALL BE THE SOLE AND EXCLUSIVE REMEDY OF THE PURCHASER FOR BREACH OF WARRANTY WITH RESPECT TO THE PRODUCT.**
7. **ADVANTEST WILL NOT HAVE ANY LIABILITY TO THE PURCHASER FOR ANY INDIRECT, INCIDENTAL, SPECIAL, CONSEQUENTIAL OR PUNITIVE DAMAGES, INCLUDING, WITHOUT LIMITATION, LOSS OF ANTICIPATED PROFITS OR REVENUES, IN ANY AND ALL CIRCUMSTANCES, EVEN IF ADVANTEST HAS BEEN ADVISED OF THE POSSIBILITY OF SUCH DAMAGES AND WHETHER ARISING OUT OF BREACH OF CONTRACT, WARRANTY, TORT (INCLUDING, WITHOUT LIMITATION, NEGLIGENCE), STRICT LIABILITY, INDEMNITY, CONTRIBUTION OR OTHERWISE. TORT (INCLUDING, WITHOUT LIMITATION, NEGLIGENCE), STRICT LIABILITY, INDEMNITY, CONTRIBUTION OR OTHERWISE.**
8. **OTHER THAN THE REMEDY FOR THE BREACH OF WARRANTY SET FORTH HEREIN, ADVANTEST SHALL NOT BE LIABLE FOR, AND HEREBY DISCLAIMS TO THE FULLEST EXTENT PERMITTED BY LAW ANY LIABILITY FOR, DAMAGES FOR PRODUCT FAILURE OR DEFECT, WHETHER ARISING OUT OF BREACH OF CONTRACT, TORT (INCLUDING, WITHOUT LIMITATION, NEGLIGENCE), STRICT LIABILITY, INDEMNITY, CONTRIBUTION OR OTHERWISE.**

CUSTOMER SERVICE DESCRIPTION

In order to maintain safe and trouble-free operation of the Product and to prevent the incurrence of unnecessary costs and expenses, Advantest recommends a regular preventive maintenance program under its maintenance agreement.

Advantest's maintenance agreement provides the Purchaser on-site and off-site maintenance, parts, maintenance machinery, regular inspections, and telephone support and will last a maximum of ten years from the date the delivery of the Product. For specific details of the services provided under the maintenance agreement, please contact the nearest Advantest office listed at the end of this Operation Manual or Advantest's sales representatives.

Some of the components and parts of this Product have a limited operating life (such as, electrical and mechanical parts, fan motors, unit power supply, etc.). Accordingly, these components and parts will have to be replaced on a periodic basis. If the operating life of a component or part has expired and such component or part has not been replaced, there is a possibility that the Product will not perform properly. Additionally, if the operating life of a component or part has expired and continued use of such component or part damages the Product, the Product may not be repairable. Please contact the nearest Advantest office listed at the end of this Operation Manual or Advantest's sales representatives to determine the operating life of a specific component or part, as the operating life may vary depending on various factors such as operating condition and usage environment.

SALES & SUPPORT OFFICES

Advantest Korea Co., Ltd.

22BF, Kyobo KangNam Tower,
1303-22, Seocho-Dong, Seocho-Ku, Seoul #137-070, Korea
Phone: +82-2-532-7071
Fax: +82-2-532-7132

Advantest (Suzhou) Co., Ltd.

Shanghai Branch Office:
Bldg. 6D, NO.1188 Gumei Road, Shanghai, China 201102 P.R.C.
Phone: +86-21-6485-2725
Fax: +86-21-6485-2726

Shanghai Branch Office:
406/F, Ying Building, Quantum Plaza, No. 23 Zhi Chun Road,
Hai Dian District, Beijing,
China 100083
Phone: +86-10-8235-3377
Fax: +86-10-8235-6717

Advantest (Singapore) Pte. Ltd.

438A Alexandra Road, #08-03/06
Alexandra Technopark Singapore 119967
Phone: +65-6274-3100
Fax: +65-6274-4055

Advantest America, Inc.

3201 Scott Boulevard, Suite, Santa Clara, CA 95054, U.S.A
Phone: +1-408-988-7700
Fax: +1-408-987-0691

ROHDE & SCHWARZ Europe GmbH

Mühlendorfstraße 15 D-81671 München, Germany
(P.O.B. 80 14 60 D-81614 München, Germany)
Phone: +49-89-4129-13711
Fax: +49-89-4129-13723

ADVANTEST[®]

<http://www.advantest.co.jp>

ADVANTEST CORPORATION
Shin-Marunouchi Center Building, 1-6-2 Marunouchi, Chiyoda-ku, Tokyo 100-0005, Japan
Phone: +81-3-3214-7500