

---

---

**ADVANTEST<sup>®</sup>**

**ADVANTEST CORPORATION**

---

***R3754 Series  
Network Analyzer  
User Manual  
(Functional Descriptions)***

**MANUAL NUMBER FEE-8311280D00**

---

***Applicable models***

***R3754A***

***R3754B***



---

## Safety Summary

To ensure thorough understanding of all functions and to ensure efficient use of this instrument, please read the manual carefully before using. Note that Advantest bears absolutely no responsibility for the result of operations caused due to incorrect or inappropriate use of this instrument.

If the equipment is used in a manner not specified by Advantest, the protection provided by the equipment may be impaired.

- **Warning Labels**

Warning labels are applied to Advantest products in locations where specific dangers exist. Pay careful attention to these labels during handling. Do not remove or tear these labels. If you have any questions regarding warning labels, please ask your nearest Advantest dealer. Our address and phone number are listed at the end of this manual.

Symbols of those warning labels are shown below together with their meaning.

**DANGER:** Indicates an imminently hazardous situation which will result in death or serious personal injury.

**WARNING:** Indicates a potentially hazardous situation which will result in death or serious personal injury.

**CAUTION:** Indicates a potentially hazardous situation which will result in personal injury or a damage to property including the product.

- **Basic Precautions**

Please observe the following precautions to prevent fire, burn, electric shock, and personal injury.

- Use a power cable rated for the voltage in question. Be sure however to use a power cable conforming to safety standards of your nation when using a product overseas.
- When inserting the plug into the electrical outlet, first turn the power switch OFF and then insert the plug as far as it will go.
- When removing the plug from the electrical outlet, first turn the power switch OFF and then pull it out by gripping the plug. Do not pull on the power cable itself. Make sure your hands are dry at this time.
- Before turning on the power, be sure to check that the supply voltage matches the voltage requirements of the instrument.
- Connect the power cable to a power outlet that is connected to a protected ground terminal. Grounding will be defeated if you use an extension cord which does not include a protected ground terminal.
- Be sure to use fuses rated for the voltage in question.
- Do not use this instrument with the case open.
- Do not place anything on the product and do not apply excessive pressure to the product. Also, do not place flower pots or other containers containing liquid such as chemicals near this

---

## Safety Summary

product.

- When the product has ventilation outlets, do not stick or drop metal or easily flammable objects into the ventilation outlets.
- When using the product on a cart, fix it with belts to avoid its drop.
- When connecting the product to peripheral equipment, turn the power off.

- **Caution Symbols Used Within this Manual**

Symbols indicating items requiring caution which are used in this manual are shown below together with their meaning.

**DANGER:** Indicates an item where there is a danger of serious personal injury (death or serious injury).

**WARNING:** Indicates an item relating to personal safety or health.

**CAUTION:** Indicates an item relating to possible damage to the product or instrument or relating to a restriction on operation.

- **Safety Marks on the Product**

The following safety marks can be found on Advantest products.

 : ATTENTION - Refer to manual.

 : Protective ground (earth) terminal.

 : DANGER - High voltage.

 : CAUTION - Risk of electric shock.

- **Replacing Parts with Limited Life**

The following parts used in the instrument are main parts with limited life.

Replace the parts listed below before their expected lifespan has expired to maintain the performance and function of the instrument.

Note that the estimated lifespan for the parts listed below may be shortened by factors such as the environment where the instrument is stored or used, and how often the instrument is used. The parts inside are not user-replaceable. For a part replacement, please contact the Advantest sales office for servicing.

Each product may use parts with limited life.

For more information, refer to the section in this document where the parts with limited life are described.



## Main Parts with Limited Life

Part name	Life
Unit power supply	5 years
Fan motor	5 years
Electrolytic capacitor	5 years
LCD display	6 years
LCD backlight	2.5 years
Floppy disk drive	5 years
Memory backup battery	5 years

- **Hard Disk Mounted Products**

The operational warnings are listed below.

- Do not move, shock and vibrate the product while the power is turned on.  
Reading or writing data in the hard disk unit is performed with the memory disk turning at a high speed. It is a very delicate process.
- Store and operate the products under the following environmental conditions.  
An area with no sudden temperature changes.  
An area away from shock or vibrations.  
An area free from moisture, dirt, or dust.  
An area away from magnets or an instrument which generates a magnetic field.
- Make back-ups of important data.  
The data stored in the disk may become damaged if the product is mishandled. The hard disc has a limited life span which depends on the operational conditions. Note that there is no guarantee for any loss of data.

- **Precautions when Disposing of this Instrument**

When disposing of harmful substances, be sure dispose of them properly with abiding by the state-provided law.

Harmful substances: (1) PCB (polycarbon biphenyl)  
(2) Mercury  
(3) Ni-Cd (nickel cadmium)  
(4) Other  
Items possessing cyan, organic phosphorous and hexadic chromium and items which may leak cadmium or arsenic (excluding lead in solder).

Example: fluorescent tubes, batteries

# Environmental Conditions

This instrument should only be used in an area which satisfies the following conditions:

- An area free from corrosive gas
- An area away from direct sunlight
- A dust-free area
- An area free from vibrations
- Altitude of up to 2000 m

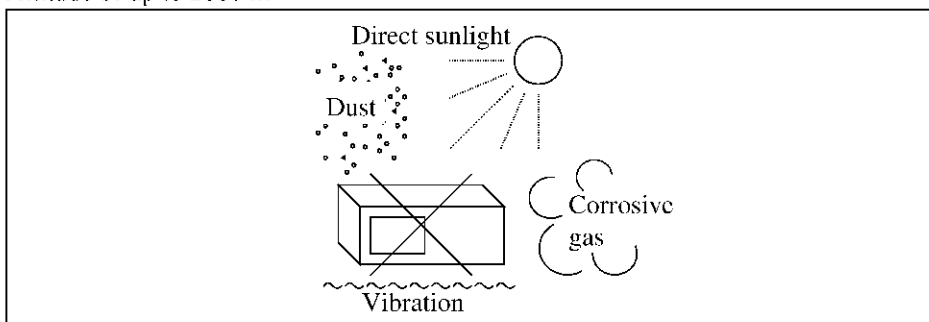

**Figure-1 Environmental Conditions**

- Operating position

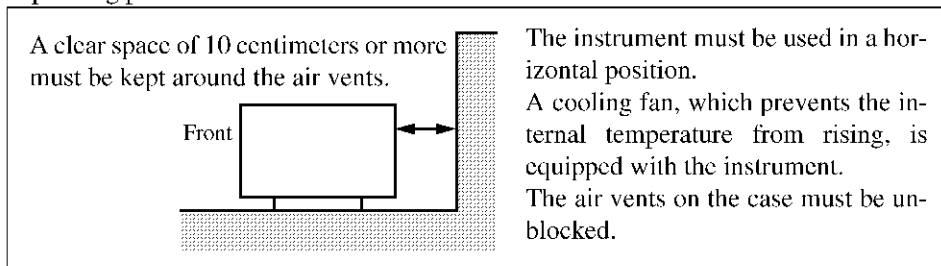

**Figure-2 Operating Position**

- Storage position

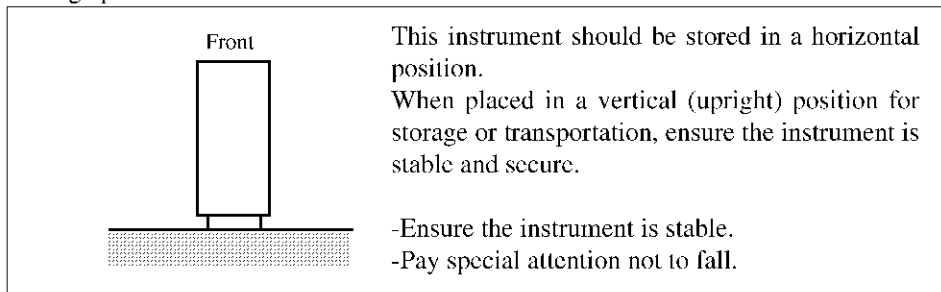

**Figure-3 Storage Position**



- The classification of the transient over-voltage, which exists typically in the main power supply, and the pollution degree is defined by IEC61010-1 and described below.

Impulse withstand voltage (over-voltage) category II defined by IEC60364-4-443

Pollution Degree 2

## Types of Power Cable

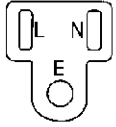
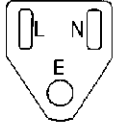
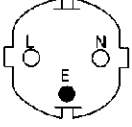
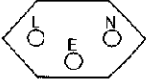
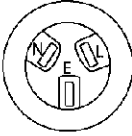
Replace any references to the power cable type, according to the following table, with the appropriate power cable type for your country.

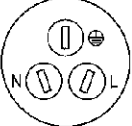
Plug configuration	Standards	Rating, color and length	Model number (Option number)
	PSE: Japan  Electrical Appliance and Material Safety Law	125 V at 7 A Black 2 m (6 ft)	Straight: A01402  Angled: A01412
	UL: United States of America  CSA: Canada	125 V at 7 A Black 2 m (6 ft)	Straight: A01403 (Option 95)  Angled: A01413
	CEE: Europe DEMKO: Denmark NEMKO: Norway VDE: Germany KEMA: The Netherlands CEBEC: Belgium OVE: Austria FIMKO: Finland SEMKO: Sweden	250 V at 6 A Gray 2 m (6 ft)	Straight: A01404 (Option 96)  Angled: A01414
	SEV: Switzerland	250 V at 6 A Gray 2 m (6 ft)	Straight: A01405 (Option 97)  Angled: A01415
	SAA: Australia, New Zealand	250 V at 6 A Gray 2 m (6 ft)	Straight: A01406 (Option 98)  Angled: -----
	BS: United Kingdom	250 V at 6 A Black 2 m (6 ft)	Straight: A01407 (Option 99)  Angled: A01417
	CCC: China	250 V at 10 A Black 2 m (6 ft)	Straight: A114009 (Option 94)  Angled: A114109



## Cautions on Using the R3754 Series

The front two feet beneath the front panel have small extensions which can be used to provide a better viewing angle (12-degree tilt).

Note the following when using the extensions:

- Use the analyzer on flat surfaces so that the weight of the analyzer is evenly distributed.
- Do not put any objects on the analyzer.
- Do not lean on the analyzer.
- Do not place anything (hands or other objects) between the analyzer and the flat surface on which it is placed.
- Do not slide the analyzer.
- Do not use excessive force when pressing keys (more than 1 kg).

Make sure the extensions are folded shut when:

- Transporting the analyzer.
- Connecting or disconnecting cables.
- Using the analyzer on a cart.
- The analyzer is not in use.
- The analyzer is in storage.
- The extensions show signs of wear.

Do not use the extensions if they show signs of excessive wear. The extensions may wear out over time. If this occur, contact ADVANTEST or our service agency for information on how to replace them



## PREFACE

This manual explains all processes from the preliminary checks to actual operation of the R3754 Series network analyzers. The R3754 Series uses the following four manuals:

Manual	Outline	Remarks
1. R3754 Series Network Analyzer User Manual (Functional Descriptions) (this manual)	The following related to the R3754 Series are explained. <ul style="list-style-type: none"> <li>• Operation methods</li> <li>• Functions and their descriptions</li> <li>• Measurement methods</li> <li>• Other information</li> </ul>	Option 91
2. R3754 Series Network Analyzer User Manual (Product Overview) (separate volume)	This manual only explains the product outline of the R3754 Series.	Standard attachment
3. R3752H/53H/54 Series Network Analyzer Programming Manual (separate volume)	GPIB and built-in BASIC are explained.	Option 91
4. R3752/53/64/65/66/67H Series R3754 Series Network Analyzer Programming Guide (separate volume)	The creation and execution of BASIC program with the editor are explained.	Option 91

**Note :** *These manuals (above items 1., 3., 4.) are available optionally. The user is provided with the R3754 Series User Manual (Product Overview) (see above item 2.). The contents of the R3754 Series User Manual (Product Overview), however, is included in this manual.*

### <Caution>

Information in this manual is subject to change without notice.

Do not reproduce or reprint all or part of this manual without the permission of ADVANTEST Corporation. The address and the telephone number of ADVANTEST Corporation are listed in the end of this manual for your reference.

**<Using this Manual>**

(1) Organization of this manual

Organization		Remarks
Preface	In the beginning. Confirmation of the product and components.	Necessary to read before using of R3754 Series for the first time.
Contents	The configuration and the page of description.	Use it to find needed information easily.
1.	Necessary information before starting to measure: installation, setup, cleaning, transportation and storage. The general remarks	
2.	Explanation of the front and rear panels and display screen. Name, functions and operations of the front and rear panel components. Contents of display screen	The usage of R3754 Series can be understood by reading it through.
3.	Basic operating guidelines Actual example of operation	
4.	Function descriptions	It is a chapter of practice.
5.	Optional functions Explanation of Option 70, Option 71 and Option 72.	Refer if necessary.
6.	Performance test Method of confirming performance of catalog spec. of R3754 Series	
7.	Specifications Technical information and general information	
8.	Error message	
Appendix	Initial setting Soft key menu list GPIB command list	
Dimensional outline drawings		
Index	Associated word and the description page	Use it to find needed information easily.



- (2) Mark of caution level in this manual.

***DANGER!***

*Indicates an imminently hazardous situation which will result in death or serious personal injury.*

***WARNING!***

*Indicates remarks concerned with personal safety and injury.*

***CAUTION!***

*Indicates remarks on damage or fire of the machine equipment, or explanations restrictions of use.*

***REFERENCE***

*Information helpful to you.*

***Note: Used for supplementary explanations.***

- (3) This manual has the page with the mark (\*) to the upper right of the pagination.  
The mark (\*) indicates the final page of each chapter.  
(Pagination: Page number in the margin is called "pagination".)

## <Confirmation of Product and Attachment>

When you open packing, confirms the following in the beginning.  
If any flaw, damage and shortage in the product or the attachment, etc., is found, contact the nearest dealer or the sales and support office.

(1) Product main unit

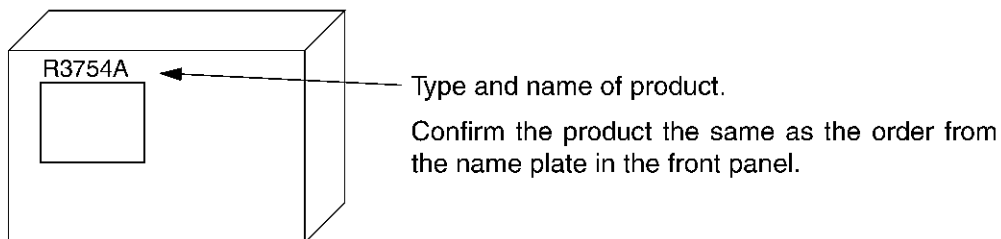

(2) Standard attachment lists

**Note:** Order the addition of the attachment etc. with type name or parts code.

Name of articles	Type name	Parts code	Quantity	Remarks
Power cable	A01402	DCB-DD2428X01	1	3 pins plug
		JCD-AL003EX03	1 <sup>*1</sup>	AC adapter
BNC-BNC cable	---	DCB-FF4894X04	1	60cm
User Manual (Product Overview)	---	JR3754SERIES(P)	1 <sup>*2</sup>	Japanese
	---	ER3754SERIES(P)		English

**Note:** <sup>\*1</sup>: The AC adaptor is a standard attachment only for the instruments used in Japan.  
<sup>\*2</sup>: One volume in either Japanese or English.

(3) Optional attachment lists

**Note:** Order the addition of the attachment with parts code.

Name	Parts code	Remarks
User Manual (Functional Descriptions)	ER3754OPT91	One set consists of three manuals written in English.
Programming Manual		
Programming Guide		
Sample Program Disk	PR37670003-FJ	DD 720K bytes

## TABLE OF CONTENTS

<b>1</b>	<b>GETTING STARTED</b> .....	<b>1-1</b>
1.1	Introduction to the R3754 Series .....	1-1
1.1.1	Product Description .....	1-1
1.1.2	Overview .....	1-2
1.1.3	Data Flow .....	1-3
1.2	Environmental Conditions .....	1-4
1.3	Power Supply Description .....	1-6
1.3.1	Power Supply Specifications .....	1-6
1.3.2	Replacing the Power Fuse .....	1-6
1.3.3	Connecting the Power Cable .....	1-7
1.4	FET Probe .....	1-8
1.5	System Setup Cautions .....	1-9
1.5.1	Notes on the Use of Parallel I/O Ports .....	1-9
1.5.2	Notes on the Use of Serial I/O Ports .....	1-9
1.6	Input Signal Level Overload Cautions .....	1-10
1.7	Cleaning, Storage and Transportation .....	1-11
1.8	Notes on Use .....	1-12
<b>2</b>	<b>PANEL DESCRIPTION</b> .....	<b>2-1</b>
2.1	Front Panel Descriptions .....	2-1
2.2	Screen Display Descriptions .....	2-4
2.3	Rear Panel Descriptions .....	2-6
<b>3</b>	<b>BASIC OPERATING GUIDELINES</b> .....	<b>3-1</b>
3.1	Basic Operation .....	3-1
3.1.1	Basic Key Operation .....	3-1
3.1.2	Example of Basic Key Operation .....	3-9
3.2	Measurement Method Example .....	3-13
3.2.1	Filter Measurement .....	3-14
3.2.2	Phase Measurement .....	3-17
3.2.3	Group Delay Measurement .....	3-19
3.2.4	Narrow-band and Wide-band Measurements .....	3-21
3.2.5	Logarithmic Magnitude and Phase Measurements .....	3-23
3.2.6	Logarithmic Magnitude and Group Delay Measurements .....	3-25
3.2.7	Linear Magnitude and Phase Measurements .....	3-27
3.2.8	Dual Channel Simultaneous Display Measurement .....	3-29
3.2.9	Reflection Characteristic Measurement .....	3-32
3.2.10	Crystal Resonator Measurement .....	3-42
3.2.11	Multi-marker Measurement .....	3-47
3.2.12	Delta Marker Measurement .....	3-49
3.2.13	Delta Section Marker Measurement .....	3-52

---

 Table of Contents

3.2.14	Marker Analysis Measurement .....	3-57
3.2.15	Marker Coupling and Interpolation Measurements .....	3-60
3.2.16	Program Sweep Measurement .....	3-63
3.2.17	Ceramic Oscillator Resonance and Antiresonance Point Measurements .....	3-68
3.2.18	Measured Data Plotter Output .....	3-72
3.2.19	Using the Save/Recall Register .....	3-76
3.2.20	Saving to Floppy Disks .....	3-78
3.2.21	Crystal Resonator Impedance Measurement .....	3-83
3.2.22	GO/NG Measurement Using Limit Line Function .....	3-88
<b>4</b>	<b>FUNCTION DESCRIPTIONS .....</b>	<b>4-1</b>
4.1	ACTIVE CHANNEL Block .....	4-2
4.2	ENTRY Block .....	4-3
4.3	STIMULUS Block .....	4-5
4.3.1	Setting Signal Source .....	4-6
4.3.2	Interlocking between Channels .....	4-8
4.4	RESPONSE Block .....	4-9
4.4.1	Setting Input and Parameter Conversion .....	4-10
4.4.2	Display Data Format .....	4-12
4.4.3	Setting Display Coordinate Scale .....	4-13
4.4.4	Split-Screen Display and Display Selection Information .....	4-14
4.4.5	TRACE Operation .....	4-15
4.4.6	Label input .....	4-16
4.4.7	Colors Settings .....	4-17
4.4.8	Averaging/Smoothing and Resolution Bandwidth .....	4-19
4.4.9	Selecting the Input Attenuator and Input Preamplifier .....	4-23
4.5	Calibration .....	4-25
4.5.1	Normalizing .....	4-25
4.5.2	One Port Full Calibration .....	4-26
4.5.3	Transmission Full Calibration .....	4-27
4.5.4	Calibration Method .....	4-27
4.5.5	Definition of Calibration Standard .....	4-30
4.5.6	Interpolating Calibration Data .....	4-31
4.5.7	Extending Measurement Reference Plane .....	4-32
4.5.8	Calibration Data Clear .....	4-34
4.6	Marker Function .....	4-35
4.6.1	Setting Marker .....	4-36
4.6.2	Marker Coupling between Channels .....	4-37
4.6.3	Interpolation Between Measurement Points .....	4-39
4.6.4	Displaying Marker Read out Value .....	4-39
4.6.5	Delta-Marker Function .....	4-40
4.6.6	Marker Menu during Impedance Measurement .....	4-43

4.6.7	Marker Analysis Function .....	4-45
4.7	Sweep .....	4-56
4.7.1	Setting Sweep Type .....	4-56
4.7.2	Editing Segment of User Frequency Sweep .....	4-57
4.7.3	Editing Program Sweep Segments .....	4-58
4.8	INSTRUMENT STATE Block .....	4-62
4.8.1	System Menu .....	4-63
4.8.2	Limit Function .....	4-65
4.8.3	CDMA IF Filter Analysis Function .....	4-70
4.8.4	Direct Analysis Functions .....	4-75
4.8.5	Self-diagnosis Function .....	4-77
4.9	GPIB Block .....	4-78
4.9.1	Controller Menu .....	4-78
4.9.2	GPIB Menu .....	4-79
4.10	Save/Recall .....	4-80
4.10.1	Selection of Save Type .....	4-80
4.10.2	Executing the Save Register Function .....	4-81
4.10.3	Executing Store File .....	4-83
4.10.4	Setting Register Name .....	4-84
4.10.5	Setting File Name .....	4-86
4.10.6	Clearing Saved Register .....	4-86
4.10.7	Purging Stored File .....	4-87
4.10.8	Executing Recall .....	4-88
4.11	Hard Copy .....	4-91
4.11.1	Setting Plot Scale .....	4-91
4.11.2	Selecting Plot Data .....	4-92
4.11.3	Specifying Pen .....	4-93
4.11.4	Plotter Setup .....	4-93
4.11.5	Printer Setup .....	4-96
4.11.6	Bitmap File Setup .....	4-97
4.12	Communication with Peripheral Devices .....	4-98
4.12.1	Parallel I/O Port (Option 01) .....	4-98
4.12.2	Parallel I/O Port (Option 02) .....	4-107
4.12.3	OPT Isolation Parallel I/O Port (Option 03) .....	4-116
4.12.4	RS-232 Interface .....	4-123
5	OPTIONAL FUNCTIONS .....	5-1
5.1	Time Domain Function (Option 70) .....	5-1
5.1.1	Time Domain Transformation Function .....	5-1
5.1.2	Window Processing .....	5-3
5.1.3	Gate Function .....	5-3
5.2	Drive Level Measurement (DLD) Functions (Option 71) .....	5-5
5.2.1	Measurement Example .....	5-5

---

Table of Contents

5.2.2	Operating the DLD Function Key .....	5-9
5.2.3	List of DLD Function Error Messages .....	5-16
5.2.4	Initial Settings for DLD Functions .....	5-18
5.2.5	Soft Key Related GPIB Commands .....	5-19
5.3	Three-terminal Resonator Measurement Function (Option 72) .....	5-22
5.3.1	A Measurement Example Using Three-terminal Resonator .....	5-23
5.3.2	Operating Keys of Three-terminal Resonator Measurement .....	5-28
5.3.3	Error Messages on the Three-Terminal Resonator Measurement Function .....	5-31
5.3.4	GPIB Commands Corresponding to the Soft Keys .....	5-31
<b>6</b>	<b>PERFORMANCE TEST .....</b>	<b>6-1</b>
6.1	Preparing for a Performance Test .....	6-1
6.2	Frequency Accuracy and Range .....	6-3
6.3	Output Level Accuracy and Flatness .....	6-4
6.4	Output Level Linearity .....	6-6
6.5	Spectrum Purity (Phase Noise) .....	6-7
6.6	Input Return Loss .....	6-8
6.7	Input Level Accuracy (Absolute value measurement) .....	6-10
6.8	Input Level Accuracy (Relative value measurement) ----- Only for model with Option 10/Option 11 .....	6-12
6.9	Noise Floor .....	6-13
6.10	Crosstalk (between the input and output) .....	6-15
6.11	Crosstalk (between the inputs) ----- Only for model with Option 10/Option 11 .....	6-16
<b>7</b>	<b>SPECIFICATIONS .....</b>	<b>7-1</b>
<b>8</b>	<b>ERROR MESSAGES .....</b>	<b>8-1</b>
8.1	Hardware Trouble .....	8-1
8.2	Overloading an Input Part .....	8-2
8.3	Notice of Hardware Information .....	8-2
8.4	Operating Error .....	8-3
8.5	Warning of Internal Set, Change, etc. ....	8-7
8.6	Completion Operating Condition Messages .....	8-9
	<b>APPENDIX .....</b>	<b>A-1</b>
A.1	Initial Setting .....	A-1
A.2	Soft Key Menu List .....	A-4
A.3	GPIB Command List for Panel Key/Soft Key .....	A-16
A.3.1	ACTIVE CHANNEL Block .....	A-17
A.3.2	STIMULUS Block .....	A-17
A.3.3	RESPONSE Block .....	A-22

A.3.4 INSTRUMENT STATE Block .....	A-41
A.3.5 GPIB Block .....	A-57
DIMENSIONAL OUTLINE DRAWING .....	EXT-1





## LIST OF ILLUSTRATIONS

No.	Title	Page
1-1	Block Diagram .....	1-2
1-2	Data Flow .....	1-3
1-3	Operating Environment .....	1-4
1-4	Check or Replace of Fuse .....	1-6
1-5	Power Cable .....	1-7
1-6	Connecting FET Probe to R3754 Series (Case of Measurement) .....	1-8
2-1	Front Panel Descriptions (R3754A) .....	2-1
2-2	Screen Display Descriptions .....	2-4
2-3	Rear Panel Descriptions (R3754A) .....	2-6
3-1	Soft key .....	3-8
3-2	Setup (Connection of DUT) .....	3-9
3-3	Frequency Setting .....	3-10
3-4	Scale Setting .....	3-11
3-5	Marker Display .....	3-12
3-6	Calibration (Normalization) .....	3-14
3-7	Auto Scale .....	3-15
3-8	Filter Analysis (3dB) .....	3-16
3-9	Filter Analysis (6dB) .....	3-17
3-10	Phase Measurement .....	3-18
3-11	Phase Measurement ( $-\infty$ to $+\infty$ ) .....	3-19
3-12	Group Delay Measurement .....	3-20
3-13	Aperture Setting .....	3-21
3-14	Narrow-band and Wide-band Measurements by Alternate Sweeping .....	3-22
3-15	Narrow-band and Wide-band Measurements by Alternate Sweeping (Divided Display) .....	3-23
3-16	Logarithmic Magnitude and Phase Measurements (Two Traces Display) .....	3-24
3-17	Selection of Scaling Trace .....	3-25
3-18	Logarithmic Magnitude and Group Delay (Two Traces Display) .....	3-26
3-19	Scale Changing of Two Traces Display .....	3-27
3-20	Linear Magnitude and Phase (Two Traces Display) .....	3-28
3-21	Scale Changing of Two Traces Display .....	3-29
3-22	Dual Channel Simultaneous Measurement (Logarithmic Magnitude and Phase) .....	3-30
3-23	Dual Channel Simultaneous Measurement (Logarithmic Magnitude and Group Delay) .....	3-31
3-24	Dual Channel Simultaneous Measurement (Linear Magnitude and Phase) .....	3-32
3-25	Calibration of Reflection Characteristic Measurement (Open) .....	3-33
3-26	Calibration of Reflection Characteristic Measurement (Short) .....	3-34
3-27	Calibration of Reflection Characteristic Measurement (Load) .....	3-35
3-28	Connection for Reflection Characteristic Measurement .....	3-36
3-29	Scale Changing for Reflection Characteristic Measurement .....	3-37
3-30	Format Changing (Smith Chart) .....	3-38

---

 List of Illustrations

No.	Title	Page
3-31	Format Changing (Admittance Chart) .....	3-39
3-32	Format Changing (Polar Chart) .....	3-40
3-33	Scale Changing for Reflection Characteristic Measurement (1) .....	3-41
3-34	Scale Changing for Reflection Characteristic Measurement (2) .....	3-41
3-35	Connection for Crystal Resonator Measurement .....	3-42
3-36	Search for Resonance Point .....	3-43
3-37	Marker Frequency $\Delta$ E Center Frequency .....	3-44
3-38	Calibration at Crystal Resonator Measurement .....	3-44
3-39	Result of Calibration .....	3-45
3-40	Search for Phase 0 .....	3-46
3-41	Search for Specified Phase .....	3-47
3-42	Multi-marker Display .....	3-48
3-43	Multi-marker List .....	3-49
3-44	Delta Marker Display (1) .....	3-50
3-45	Delta Marker Display (2) .....	3-51
3-46	Fixed Marker Display .....	3-52
3-47	Partial Analysis (Range Specifying) .....	3-53
3-48	Partial Analysis (ON) .....	3-54
3-49	Partial Analysis (MAX Search) .....	3-55
3-50	Partial Analysis (MIN Search) .....	3-56
3-51	Partial Analysis (Ripple Search) .....	3-57
3-52	Marker Search (MAX) .....	3-58
3-53	Marker $\Delta$ E Center Frequency .....	3-59
3-54	Delta Marker $\Delta$ E Span .....	3-60
3-55	Marker Compensation .....	3-61
3-56	Marker Un-compensation .....	3-62
3-57	Markers Uncouple .....	3-63
3-58	Before Program Sweep Measurement .....	3-64
3-59	Segment Specification .....	3-65
3-60	Program Sweep .....	3-66
3-61	Condition Changing of Specified Segment .....	3-67
3-62	Point Number of Segment .....	3-67
3-63	Connection for Ceramic Oscillator Resonance Measurement .....	3-68
3-64	Calibration at Ceramic Oscillator Resonance Measurement .....	3-69
3-65	Impedance Display .....	3-70
3-66	Marker List (1) .....	3-71
3-67	Marker List (2) .....	3-72
3-68	Output to Plotter (Measurement Result) .....	3-73
3-69	Setting of Output to Plotter .....	3-74
3-70	Output to Plotter .....	3-75
3-71	Example Plot .....	3-75
3-72	Save Register .....	3-77
3-73	Recall Register .....	3-78
3-74	Preparation for Data Storing .....	3-80
3-75	File Name Input .....	3-81
3-76	Reproduce of Stored Data .....	3-82
3-77	Connection for Crystal Resonator Impedance Measurement .....	3-84
3-78	Selection of Calibration .....	3-85

No.	Title	Page
3-79	Calibration (Open) .....	3-85
3-80	Calibration (Short) .....	3-86
3-81	Calibration (Load) .....	3-86
3-82	Measurement after Calibration Executing .....	3-87
3-83	Calibration (Interpolation ON) .....	3-88
3-84	Screen before Execution of Limit Line Measurement .....	3-89
3-85	Setting of the Limit Line .....	3-90
3-86	Limit Line Editing .....	3-90
3-87	Setting of Segment 0 .....	3-91
3-88	Setting of Each Segment .....	3-93
3-89	Execution of Limit Test .....	3-94
3-90	Change of Limit Line .....	3-95
4-1	Label Window Display .....	4-16
4-2	Calibration Standard Equivalent Circuit .....	4-30
4-3	Band Pass Filter Analysis/MAX Reference .....	4-51
4-4	Band Pass Filter Analysis/Active Marker Reference .....	4-52
4-5	Band Pass Filter Analysis/Reference Line Reference .....	4-52
4-6	Notch Filter Analysis/MAX Reference .....	4-53
4-7	Notch Filter Analysis/Active Marker Reference .....	4-53
4-8	Notch Filter Analysis/Reference Line Reference .....	4-54
4-9	File List Display .....	4-81
4-10	Label Window Display .....	4-84
4-11	Register List Display .....	4-85
4-12	Setting DIP Switches .....	4-94
4-13	Timing Chart of WRITE STROBE .....	4-98
4-14	36-pin Connector Internal Pin Assignment and Signal .....	4-100
4-15	Internal Circuit .....	4-101
4-16	Timing Chart of WRITE STROBE .....	4-107
4-17	36-pin Connector Internal Pin Assignment and Signal .....	4-109
4-18	Internal Circuit .....	4-110
4-19	Timing Chart of WRITE STROBE .....	4-116
4-20	36-pin Connector Internal Pin Assignment and Signal .....	4-118
4-21	Output Circuit .....	4-119
4-22	Input Circuit .....	4-119
4-23	OUTPUT .....	4-120
4-24	INPUT .....	4-120
5-1	Connecting the p Network Jig and DUT .....	5-5
5-2	Screen Displaying DLD Analysis .....	5-7
5-3	Screen Displaying DLD Analysis List .....	5-8
5-4	Maximum and Minimum Applicable Power to Crystal .....	5-11
5-5	Connecting the Three-terminal Measurement Fixture to This Instrument .....	5-23
5-6	Screen Showing the Execution of Open Cal .....	5-24
5-7	Screen Showing the Execution of Short Cal .....	5-25
5-8	Screen Showing the Execution of Load Cal (50W) .....	5-25
5-9	Screen Showing the Execution of Load Cal (100W) .....	5-26
5-10	Screen Showing the Execution of Load Cal (200 W) .....	5-26

---

List of Illustrations

No.	Title	Page
5-11	Measuring a Three-terminator Resonator .....	5-27
6-1	Frequency Accuracy and Range .....	6-3
6-2	Output Level Accuracy and Flatness .....	6-4
6-3	Output Level Linearity .....	6-6
6-4	Spectrum Purity .....	6-7
6-5	Connection for Measuring Return Loss .....	6-8
6-6	Input Return Loss .....	6-9
6-7	Input Level Accuracy (Output Level Calibration) .....	6-10
6-8	Input Level Accuracy .....	6-11
6-9	Input Level Accuracy (Relative Value) .....	6-12
6-10	Crosstalk (Between the Inputs) .....	6-16

## LIST OF TABLES

No.	Title	Page
4-1	Factory settings .....	4-30
4-2	DSW1 Function .....	4-94
4-3	DSW2 Function .....	4-95
4-4	Rated Values of the Signals .....	4-120
4-5	Rated Values of the Signals .....	4-121
6-1	Required Measurement Instruments for Performance Test (1 of 2) .....	6-1
6-1	Required Measurement Instruments for Performance Test (2 of 2) .....	6-2



# 1 GETTING STARTED

## 1.1 Introduction to the R3754 Series

### 1.1.1 Product Description

The R3754 Series is the 150MHz vector network analyzer, which has newly been designed based on a concept "an optimum tool for each application".

We have fully pursued high throughput such as 50 $\mu$ s/points high-speed measurement at a resolution bandwidth (RBW) of 15kHz, 127dB (RBW 1kHz) wide dynamic-range measurement, and two-device simultaneous measurement with two-channel/four-trace display. Also, we have added the program sweeping function that can freely change the resolution bandwidth (RBW), output level, and input attenuator during sweep operation for each segment.

Since the R3754 Series employs semiconductor switches for changing the output level and for switching the input attenuator, it allows the optimum high-speed level sweeping for the drive level test of the oscillator.

With the built-in BASIC controller, a high-speed ATE system can be easily configured with no external controller for processes from adjustment to inspection.

<Features>

- (1) High throughput
  - 50 $\mu$ s/point high-speed frequency sweeping and 5ms short blanking time  
When two-channel/four-trace (magnitude/phase) and RBW 15kHz
  - 50 $\mu$ s/point high-speed level sweeping (RBW 15kHz)  
High speed and long life using semiconductor switches
- (2) Wide dynamic range
  - With switching of input attenuator/preamplifier, 127dB wide dynamic range
  - High speed and long life using semiconductor switches for switching input attenuator (RBW 1kHz)
- (3) Program sweeping function
  - For each segment, allows setting of frequency, output level, input attenuator, RBW and settling time.
- (4) MS-DOS format disk
  - By using an MS-DOS personal computer, it is possible to easily create programs and analyze data because of the disk conformed to MS-DOS format standard.
  - Three modes of storage capacity are available (DD 720KB, HD 1.2MB and HD 1.44MB).

<About the Defective Picture Element (PIXEL) of the Color LCD>

The color LCD may present display problems caused by defective PIXELs as missing or normally lit ones.

Although ADVANTEST strives for zero defects in our LCD production line, this is not yet possible.

1.1 Introduction to the R3754 Series

1.1.2 Overview

(1) Signal source

The signal output range is 10kHz to 150MHz and the output power range is +21dBm to -43dBm.

(2) Receiver

Signals in the receiver flow as follows:

- ① Input signal ranging from 10kHz to 150MHz are converted into 820kHz 1st IF signal by the 1st Mixer and transferred to the 2nd Mixer.
- ② The 1st IF signal is converted into 20kHz 2nd IF signal by the 2nd Mixer and output to the A/D circuit.
- ③ The A/D-converted data is calculated at a high speed by the digital signal processor (DSP) and displayed on the display.

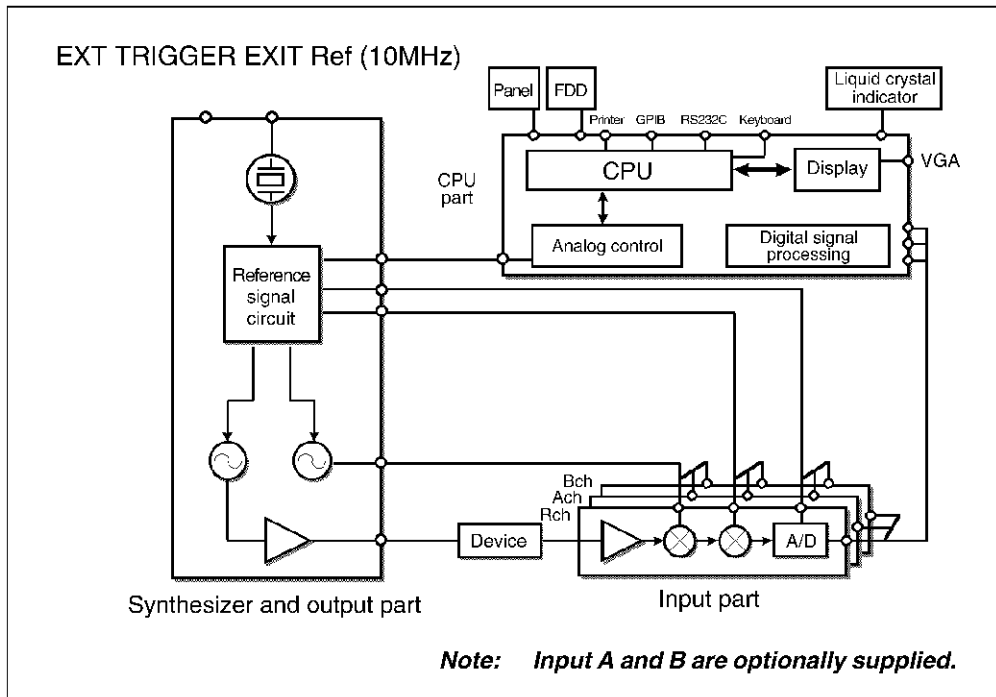

Figure 1-1 Block Diagram



### 1.1.3 Data Flow

The signal input in the receiver is processed according to the following flow:

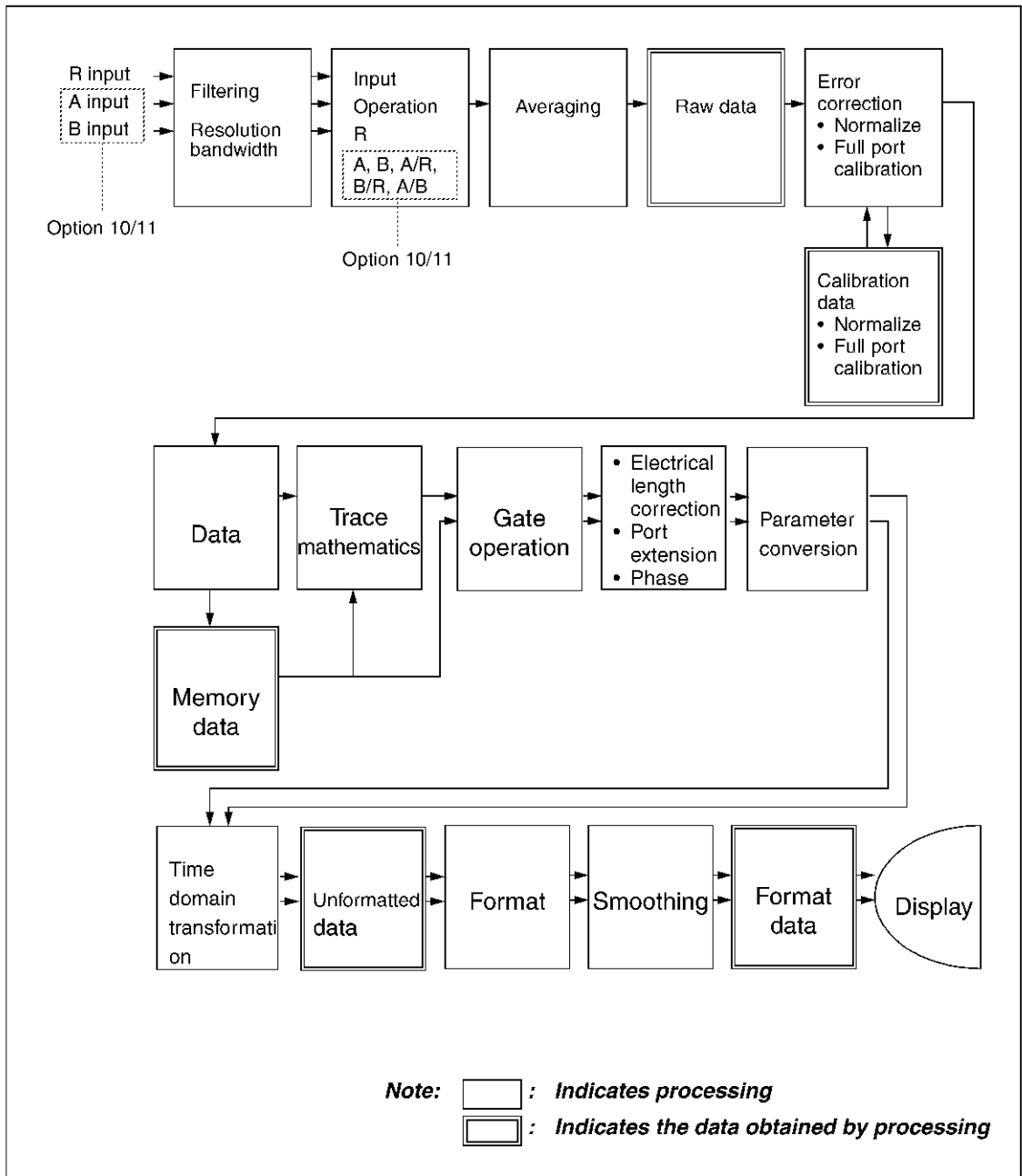

Figure 1-2 Data Flow

1.2 Environmental Conditions

1.2 Environmental Conditions

- Operating Environment

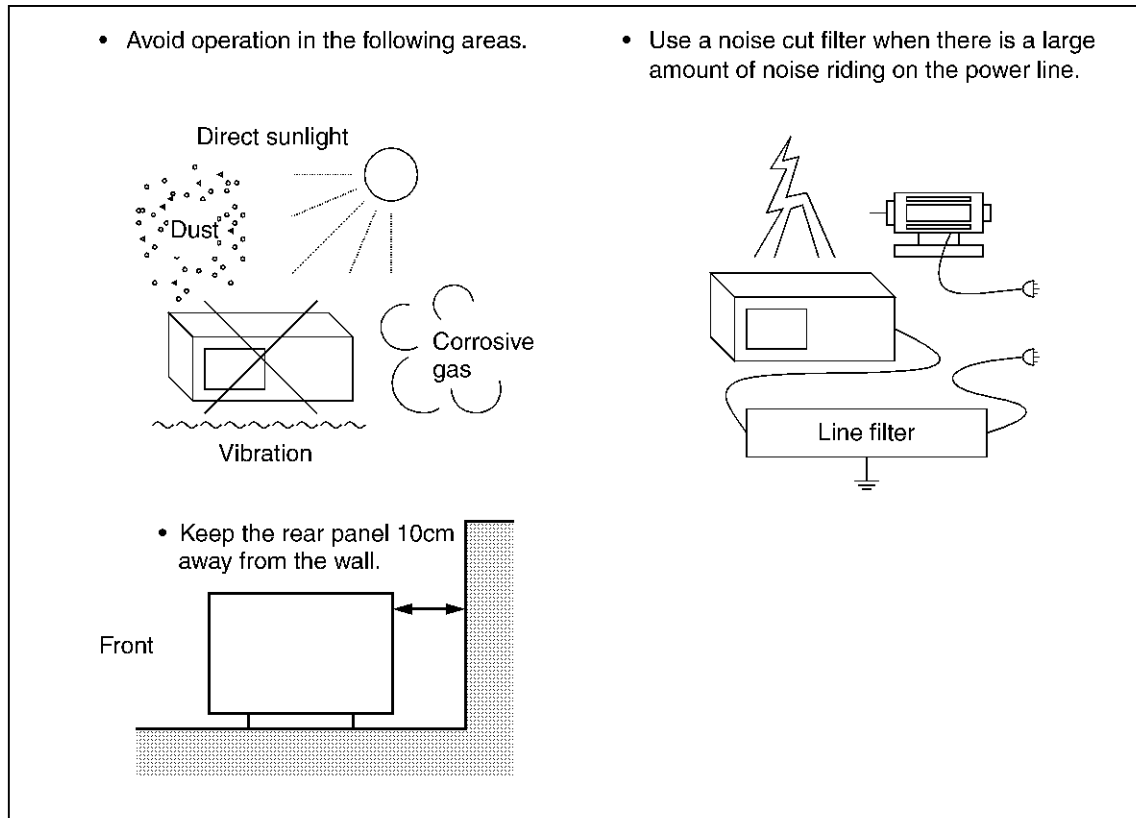

Figure 1-3 Operating Environment

The R3754 Series should be installed in an area which satisfies the following conditions:

- Operating temperature range: 0°C to +40°C (R3754A)  
0°C to +50°C (R3754B)
- Relative humidity: 80% or less (no condensation)
- An area free from corrosive gas
- An area away from direct sunlight
- A dust-free area
- An area free from vibrations
- A low noise area  
Although the R3754 Series has been designed to withstand a certain amount of noise riding on the AC power line, it should be used in an area of low noise. Use a noise cut filter when ambient noise is unavoidable.
- Installation position  
The R3754 Series has an air outlet hole on its rear panel. Never block or plug the hole, as the resulting internal temperature rise will affect measurement accuracy.

The R3754 Series can be used safely under the following conditions:

- Altitude: 2000m maximum above the sea level
- Installation category II
- Pollution degree 2

1.3 Power Supply Description

1.3 Power Supply Description

1.3.1 Power Supply Specifications

**WARNING!**

*Safely use R3754 Series according to the power requirement.*

*R3754 Series might be damaged in the case not following the power requirement.*

The power requirement of R3754 Series is shown in the following.

Use the power supply by which the power requirement of R3754 Series is satisfied.

Input Voltage	100V <sub>AC</sub> operation	200V <sub>AC</sub> operation
	AC100V to 120V	AC220V to 240V
Frequency	50/60Hz	
Fuse	T5.0A/250V	
Power consumption	200VA or less	

\* This input voltage is automatically switched between 100V<sub>AC</sub> system and 200V<sub>AC</sub> system. The above input voltage is the standard of the R3754 Series. The available range of the AC power is 90 to 132V and 198 to 250V.

1.3.2 Replacing the Power Fuse

**WARNING!**

*Use the power fuse of the standard by which power supply voltage is satisfied.*

The power fuse is located in the power connector on the rear panel.

Check or replace the power fuse as follows.

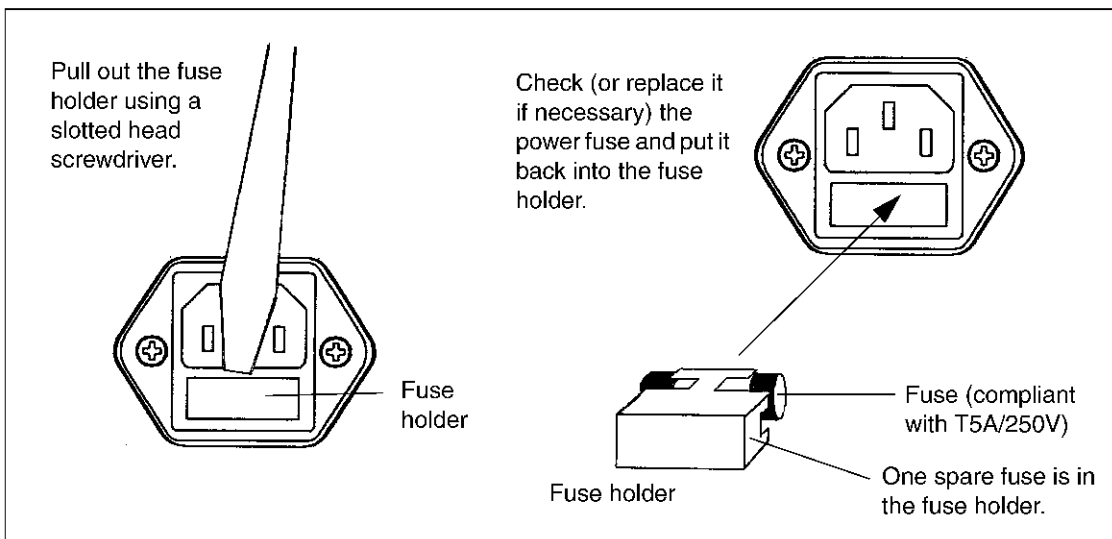

Figure 1-4 Check or Replace of Fuse

### 1.3.3 Connecting the Power Cable

**WARNING!****1. Power cable**

- Use power cable of the attachment for prevention electric shock and fire. A standard attachment conforms to The Law on Electrical Appliances of Japan.
- Use power cable in accordance with the safety standard of the country for use excluding Japan.
- When you connect power cable with the outlet, turn off the power switch.
- When you pull out power cable from the outlet, have the plug.

**2. Protective earth**

- Connect the power plug cable with the power outlet which has the protective earth terminal.
- If the code for the extension without the protective earth terminal is used, the protective earth will become invalid.
- Case in which use of AC adapter (Three pins to two pins conversion adapter), connect the earth pin of the adapter to the earth of the outlet, or connect ground terminal of the rear panel with the earth of the outside, and ground it to the earth.

**(1) Power cable**

The spectrum analyzer has a detachable power cable with a three-contact plug for connection to the power source and a protective earth ground. The protective earth ground contact on the plug connects (through the power cable) to the accessible metal parts of the instrument. For protection against electrical shock, insert the plug into a power-source outlet that has a properly grounded, protective-ground contact.

The manufacturer ships the required power cable, as ordered, with the spectrum analyzer. Information about the available power cords is shown in Power Cable Option. Contact your ADVANTEST representative or the local ADVANTEST Field Office for additional information about power cables.

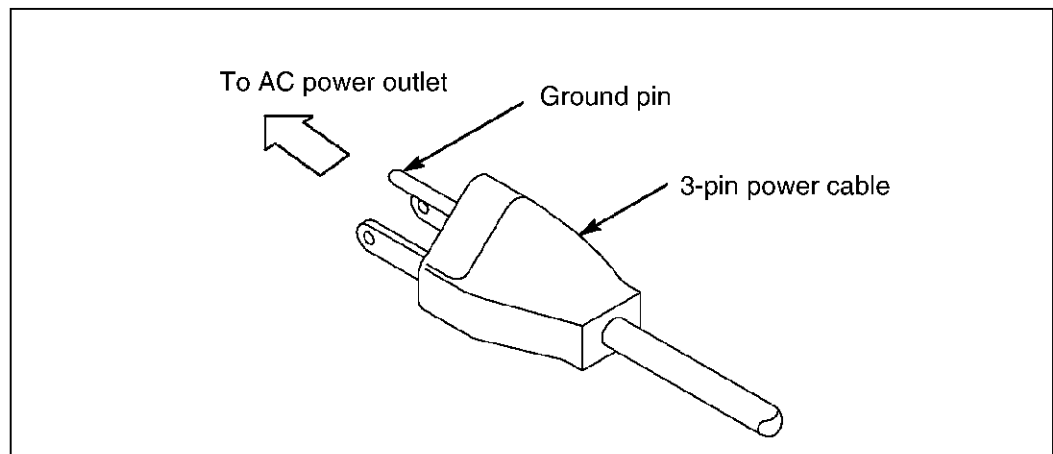

Figure 1-5 Power Cable

**(2) Power plug for overseas use**

A separately-sold plug for overseas use is available. For more information, contact ADVANTEST's Service Department.

### 1.4 FET Probe

**Note:** The FET probe cannot be used without Option 10 or 11.

(1) Setup

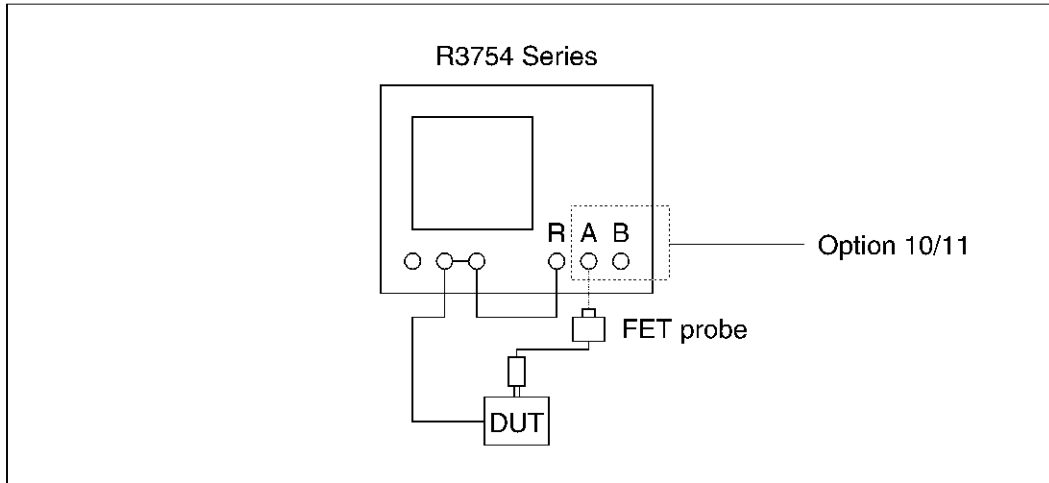

**Figure 1-6 Connecting FET Probe to R3754 Series (Case of Measurement)**

(2) Usage precautions

The stability and repeatability of the measurement value are affected by the ground of FET probe tip.

The input impedance of the FET probe is listed in the following Table. In high frequency, it is necessary to consider the effect of parallel capacitance.

Model name	Input impedance	Remarks
AP003	10MΩ ±5% Input capacitance: 1.9 ± 0.3pF	DC to 1GHz Manufactured by STACK ELECTRONICS CO., LTD.

(3) Calibration method

Operation procedure

- ① Connect the FET probe to the measurement circuit reference point.
- ② Select the calibration menu of the R3754 Series to normalize the frequency characteristic probe.
- ③ Connect the FET probe to the point to be measured, then perform the measurement.

**Note:** When measuring the point in high frequency, note that the data repeatability will be changed by the ground condition of the FET probe tip.

## 1.5 System Setup Cautions

### 1.5.1 Notes on the Use of Parallel I/O Ports

*Note: The parallel I/O is optional function. (Option 01)*

- (1) In +5V power output from parallel I/O port, maximum current capacity is 100mA.  
Use it within 100mA.  
One overcurrent protection element is used for +5 V power output from the parallel I/O port.
- (2) The + 5 V power supply turns off when it senses an overcurrent of 100 mA or more. The power supply is automatically turned back on as soon as the cause of the overcurrent is removed.
- (3) Use the shield cable for the cable for parallel I/O port. (to prevent malfunction by noise)
- (4) The standard of the cable for the radiation test of R3754 Series is MO-27.
- (5) Cautions of wiring  
Do not bundle I/O cable and the AC line.

### 1.5.2 Notes on the Use of Serial I/O Ports

- (1) The length of the cable used for serial I/O port is 15m or less.
- (2) Use the shield cable for the cable for serial I/O port. (to prevent malfunction by noise)
- (3) The standard of the cable used for the radiation test of R3754 Series is A01235.
- (4) Cautions of wiring upper  
Do not bundle I/O cable and the AC line.

## 1.6 Input Signal Level Overload Cautions

### 1.6 Input Signal Level Overload Cautions

A maximum level that can be measured at the input part is 5dBm. (When an input attenuator is set to 25dB)

If a signal with its level 5dBm and more is added to the input, some messages are displayed.

- (1) If a signal with its level 6dBm or more and with its frequency 100kHz or more is added to the input, "Overload" is displayed.



## 1.7 Cleaning, Storage and Transportation

### (1) Cleaning

Wipe the dirt of R3754 Series off with a soft cloth (or wet cloth). At this time, attend to the following points.

- Do not remain the fluff of the cloth and do not soak water into the internal of R3754 Series.
- Do not use an organic solvent (for example, benzene and acetone, etc.) which changes plastics in quality.

### (2) Storage

The cases in which R3754 Series is not used for a long time, cover with the vinyl cover or put in the cardboard box and prevent dust. Keep it in a dry place where dust and direct sunshine are prevented.

Storage temperature range: -20°C to +60°C

### (3) Transportation

When you transport the R3754 Series, pack it equally to the first packing material or any more.

Packing procedure

- ① Wrap R3754 Series itself with cushion material and put in the cardboard box.
- ② After putting the attachments, fill the box with cushion again.
- ③ Close the lid of the cardboard box. Fix the outside with string or tape.

## 1.8 Notes on Use

(1) Before starting the measurement

When turning on the power, do not connect the DUT.

Before starting the measurement, check to see the output power level.

(2) Opening the case

Only ADVANTEST authorized service personnel can open this case.

(3) When abnormality occurs

When smoke rises from R3754 Series, smell nastily, or hear unusual sound feel, turn off the power switch. Pull out power cable from the outlet. And contact to our company.

The address and the telephone number of our company are in the end of this manual.

(4) Electromagnetic interference

High frequency noise of the small power is generated at R3754 Series use.

Therefore, electromagnetic interference is generated to the television or the radio by an improper installation and use of R3754 Series.

If the power of R3754 Series is turned off, and the electromagnetic interference is reduced, then R3754 Series is the cause of it.

Prevent electromagnetic interference by the following procedure.

- Change the direction of antenna of the television or the radio.
- Place R3754 Series the other side of the television or the radio.
- Place R3754 Series away from the television or the radio.
- Use another line of power source for the television or the radio than R3754 Series.

## 2 PANEL DESCRIPTION

The front panel is explained in section 2.1.

The front panel screen display is explained in section 2.2.

The rear panel is explained in section 2.3.

### 2.1 Front Panel Descriptions

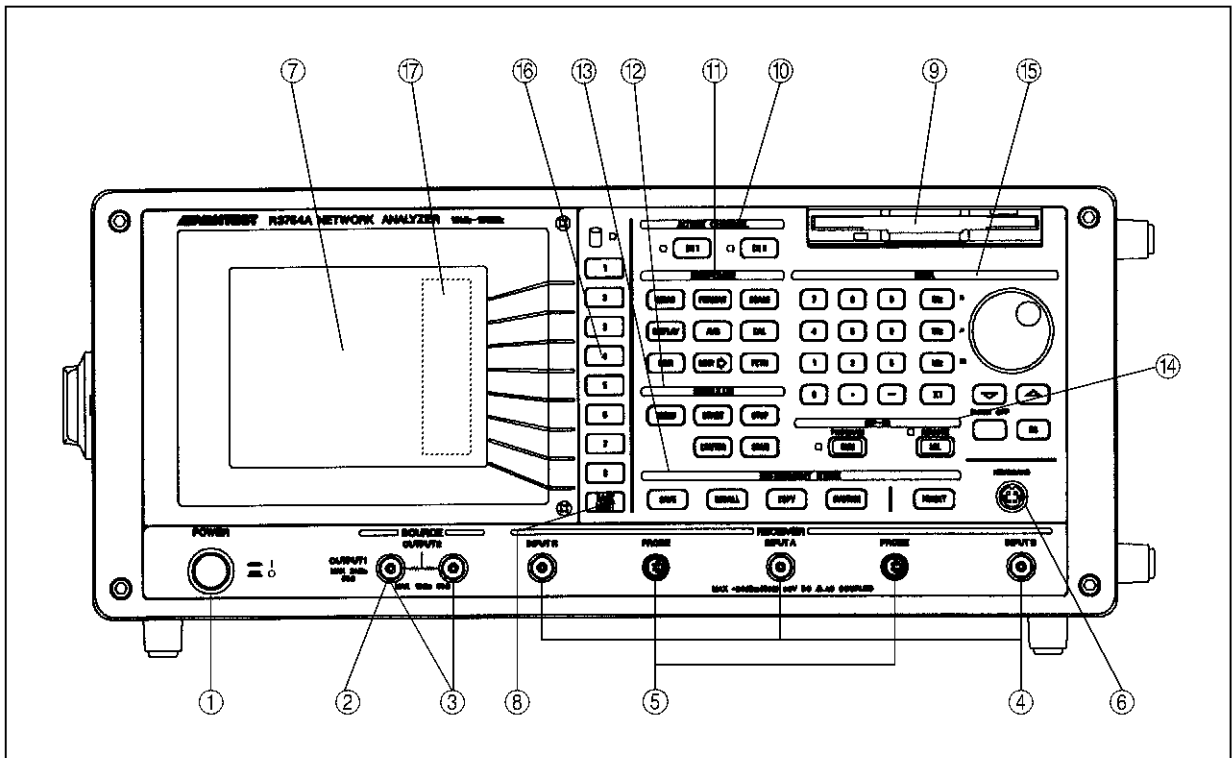

Figure 2-1 Front Panel Descriptions (R3754A)

## 2.1 Front Panel Descriptions

(1 of 2)

No.	Name	Description
①	POWER switch	Turns on or off the power supply of the R3754 Series.
②	SIGNAL SOURCE OUTPUT connector (OUTPUT1)	Single output The OUTPUT connector is used to perform a measurement by connecting 3-branch power splitter for absolute measurement or 2-device measurement.
③	SIGNAL SOURCE OUTPUT connector (OUTPUT2)	Power splitter output
④	RECEIVER SECTION INPUT connector INPUT R INPUT A INPUT B	The INPUT connector is used for reference input and measurement input. <b>Note: The input connector differs according to additional option.</b> Standard: INPUT R Option 10: INPUT R, A Option 11: INPUT R, A, B
⑤	PROBE POWER connector	Connector for probe power $\pm 12V$ output Standard: None Option 10: 1-connector Option 11: 2-connector
⑥	KEYBOARD INPUT connector	The KEYBOARD INPUT connector is used to connect a keyboard belonging to IBM-PC/AT or PS/2 series. An external keyboard can be used to input a label name, a saving register name and a BASIC text.
⑦	LCD display	Displays measurement data, setting conditions and other informations.
⑧	BACK LIGHT	Selects the back light ON/OFF of LCD display. (For the R3754A, pressing this switch turns the screen contrast on or off.)
⑨	Floppy disk drive	Stores a program and measurement data. Three modes of storage capacity (DD: 720KB, HD: 1.2MB, HD: 1.44MB).
⑩	ACTIVE CHANNEL block	The ACTIVE CHANNEL block is used to select an active channel from independent two measurement channels. After selecting, functions to be operated are effective to the selected active channel.

(2 of 2)

No.	Name	Description
⑪	RESPONSE block	The RESPONSE block is used to set measurement conditions of receiver section, data display and data analysis.
⑫	STIMULUS block	The STIMULUS block is used to set frequencies, level and sweep conditions of signal source.
⑬	INSTRUMENT STATE block	The INSTRUMENT STATE block is used set the system functions which have no concern with the measurement.
⑭	GPIB block	The GPIB block is used to set a GPIB and controller functions.
⑮	ENTRY block	The ENTRY block is used to input numeric data and to move a marker.
⑯	Soft keys	Selects the soft key menu described in ⑰ in each function block.
⑰	Soft key menu	Displays each function menu. To select a menu, use the soft key described in ⑯.

2.2 Screen Display Descriptions

2.2 Screen Display Descriptions

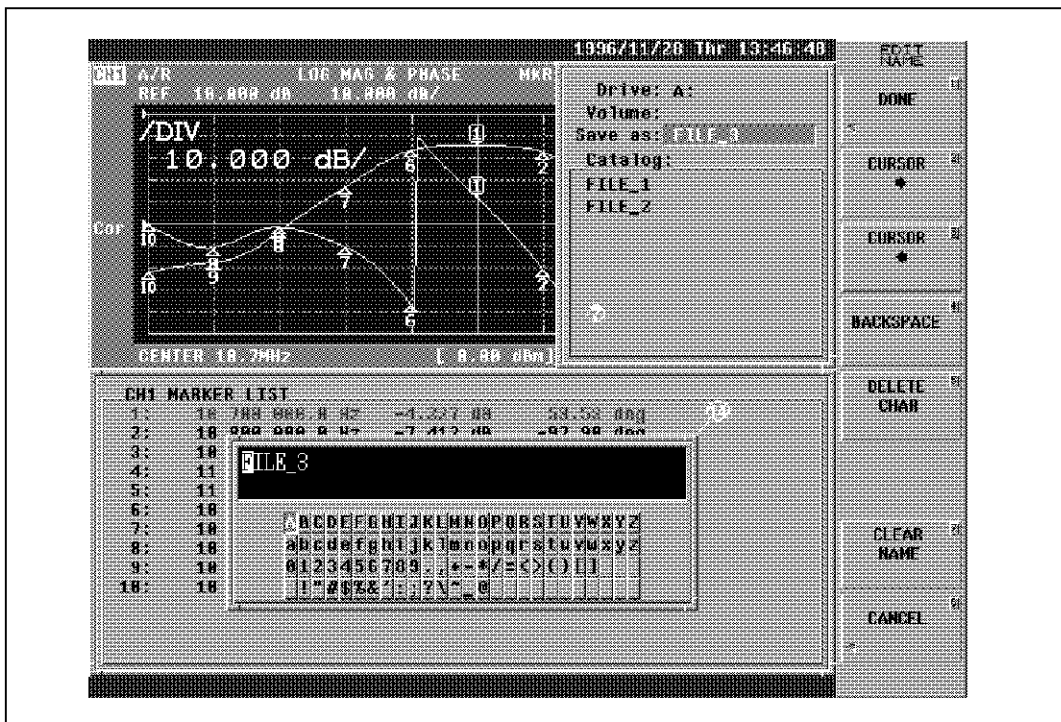
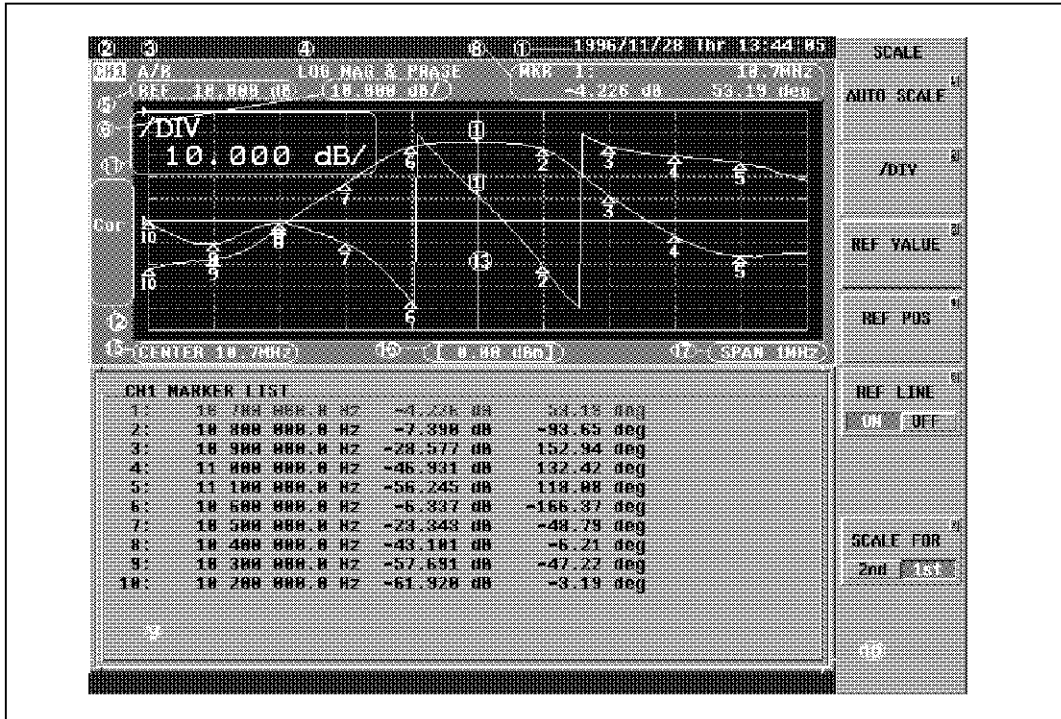

Figure 2-2 Screen Display Descriptions

No.	Name	Description
①	Real time clock	Displays year, month, date and time.
②	Channel	Displays a channel number.
③	INPUT port	Displays an input port.
④	Format	Displays data format (format data).
⑤	Scale reference	Displays a reference value of display coordinate. The reference position is displayed by using ▷ mark.
⑥	Scale/DIV	Displays one scale value of display coordinate.
⑦	Load menu	Displays files in this area when loading program from the disk drive.
⑧	Active marker	Displays an active marker value.
⑨	Marker list	Displays a marker list.
⑩	Soft key menu	Displays a soft key menu.
⑪	Active area	Displays items selected by panel keys or soft keys and those input values.
⑫	Status area	Displays status which shows an operating state of the R3754 Series.
⑬	Trace display area	Displays measurement data.
⑭	Label window	Displays character lists used for a label and a register name.
⑮	Start/Center	Displays the start/center of signal source.
⑯	Power/CW	Displays the power/CW of signal source.
⑰	Stop/Span	Displays the stop/span of signal source.

2.3 Rear Panel Descriptions

2.3 Rear Panel Descriptions

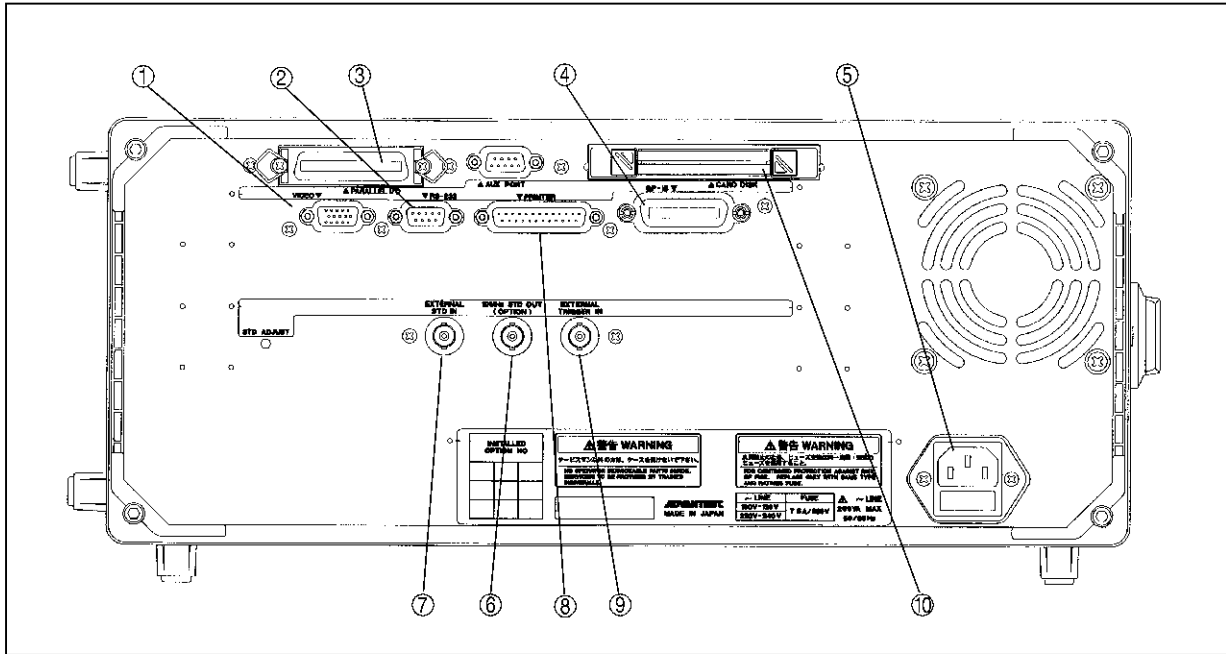

Figure 2-3 Rear Panel Descriptions (R3754A)



No.	Name	Description
①	VIDEO SIGNAL output	Video signal output corresponding to VGA (15-pin).
②	SERIAL I/O	Input/output connector conformed to RS-232 standard.
③	PARALLEL I/O connector	The I/O port connector is used to communicate peripheral devices such as an automatic machine and a foot switch. (Output: 8-bit 2 systems, Input/output: 4-bit 2 systems) EXT TRIGGER input (Negative logic, pulse width: 1 $\mu$ s or more, 18-pin terminal) <b>Note: Use shielded cables for connection (to prevent malfunction by noise).</b>
④	GPIB connector	The GPIB connector is used to remotely control external peripheral devices and to be remotely controlled by an external controller.
⑤	AC POWER connector	The AC POWER connector which has three-pin structure includes an earth pin. To remove a power fuse, pull out the upper cover.
⑥	High stability reference frequency output connector (option 20)	This connector is used to output a high stability reference frequency when Option 20 is installed.
⑦	External reference frequency input connector	This connector is used to input a reference frequency from an external device. Input frequency: 1, 2, 5, 10MHz, 0dBm or more Input frequency accuracy: Within $\pm 10$ ppm
⑧	Printer output connector	Connector for printer conformed to Centronix standard.
⑨	EXT TRIG IN	Connector for external trigger signal input (Negative logic, pulse width: 1 $\mu$ s or more)
⑩	Slot for option card	Slot for option card (PCMCIA)



### 3 BASIC OPERATING GUIDELINES

This section explains basic key operation for beginners, containing specific examples.

#### 3.1 Basic Operation

##### 3.1.1 Basic Key Operation

(1) Functional blocks on front panel

The front panel keys are grouped into six functional blocks as shown below. With a combination of these blocks, the R3754 Series is operated.

- ACTIVE CHANNEL block : The R3754 Series has two measurement channels. The block is used to select an active channel which can be set or changed. (See section 4.1.)
- ENTRY block : Enters a numeric value for the selected function. (See section 4.2.)
- STIMULUS block : Selects the settings for the signal source. (See section 4.3.)
- RESPONSE block : Selects the settings of the receiver and the setting of the conditions of the display. (See section 4.4.)
- INSTRUMENT STATE block : Selects the system settings such as save/recall and hard copy. (See section 4.8.)
- GPIB block : Selects the settings of the controller and the GPIB. (See section 4.9.)

When the key of each block mentioned above is pressed, the item (Soft key menu) corresponding to the function is displayed on a right side of the display screen.

(2) Key operation

Two types of key operations are available for the R3754 Series as follows :

- When a numeric value is required to be entered :  
**[Panel key] → {Soft key} → [ENTRY block]**
- When only soft key menus are required for selection :  
**[Panel key] → {Soft key}**

If some key is pressed for more than about 0.5 second, the pressed key is entered repetitively.

However, pressing more than two keys or more at the same time brings nothing.

3.1 Basic Operation

(3) Configuration of soft key menu

The soft key menu has two or more pages and hierarchic structures.

- Two or more-page's soft key menus that are:
  - When *{More 1/2}* is pressed, the menu will move to the next page.
  - When *{More 2/2}* is pressed, the menu will return to the page of former.
- Soft key menu of hierarchic structure:
  - When *{Return}* is pressed, the menu will return to the previous layer menu.
  - When [**Panel key**] is pressed during the layer menu display, the menu will return to the first layer menu.

(4) Front panel key

Each function of the front panel key is explained briefly here. Refer to chapter 4. for details of each function.

① ACTIVE CHANNEL block

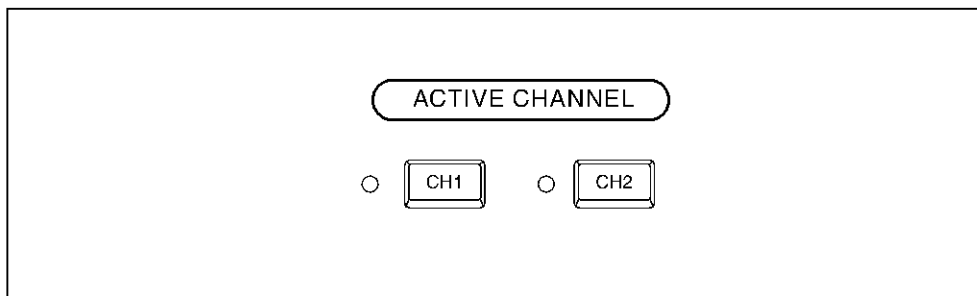

R3754 Series can measure the reflection and transmission characteristics of the devices at the same time. Moreover, simultaneous measurement by a different frequency can be done.

R3754 Series has two measurement channels. Therefore, measurement and the data display for each channel can be done independently.

In the ACTIVE CHANNEL block, which channel is set to the active channel is selected. The active channel is a channel that can set various conditions such as measurement and data displays. That is, the function depend on the channel is effective only to the active channel. LED is lit to the current active channel.

**[CH1]** : The channel 1 is set to the active channel.

**[CH2]** : The channel 2 is set to the active channel.

The signal source can interlock between channels. In this case, the condition set in the active channel is also set to other channel automatically.

## ② ENTRY block

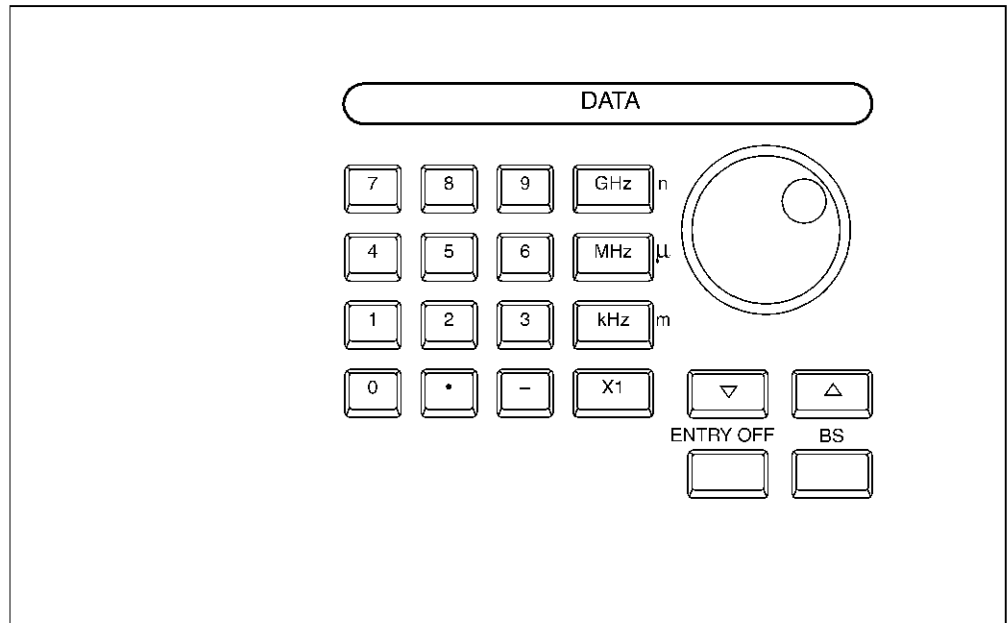

In the ENTRY block, data entry and the change are done to the function selected with the **[Panel key]** and the *{Soft key}*.

Moreover, this is used to set and to change the marker.

Numeric keys: **[0]** to **[9]** ; It is a ten-key.  
**[.]** ; It is a decimal point key.  
**[-]** ; It is a minus sign key.  
**[BS]** ; It is a back space key.  
**[ENTRY OFF]** ; It is an entry off key. All numerical data under input is deleted. And input request is canceled.

**Note:** *After operation of a numeric key.  
Press the unit key.*

Unit keys: **[GHz] n** ; It is giga/nano unit keys.  
**[MHz] μ** ; It is mega/micro unit key.  
**[kHz] m** ; It is of kilo/milli unit key.  
**[X1]** ; Base unit key. It is used in the case of base unit or not provided unit.  
 (dB, dBm, degree, seconds and Hz etc.)

Step keys: **[↑]** to **[↓]** ; The set value is changed by a specific step size.  
 After operation of the step key, the unit input is unnecessary.

Data knob:  ; The set value is continuously changed. After operation of the data knob, the unit input is unnecessary.

3.1 Basic Operation

③ STIMULUS block

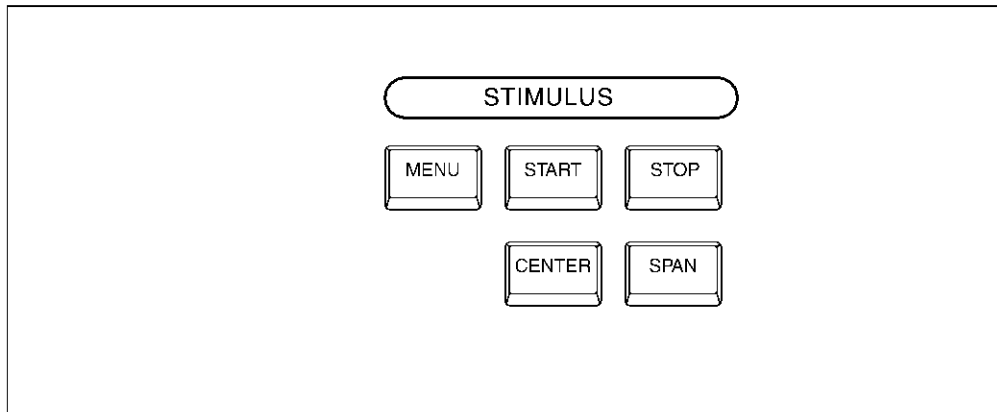

In the STIMULUS block, the condition in the signal sources such as the frequency range, the power level setting, the sweep type, sweep time and the sweep resolution is set.

**[MENU]** : The output level, sweep time, the sweep type and the sweep resolution, etc. are set.

**[START]** : The start of the sweep is set.  
As for the case of the frequency sweep, the frequency is set. And as for the case of the power sweep, power is set.

**[STOP]** : The stop of the sweep is set.  
As for the case of the frequency sweep, the frequency is set. And as for the case of the power sweep, power is set.

**[CENTER]** : The center of the sweep is set. As for the case of the frequency sweep, the frequency is set.

**[SPAN]** : Span of the sweep is set. As for the case of the frequency sweep, the frequency is set.

The range of the sweep is set with **[START]**, **[STOP]**, **[CENTER]** and **[SPAN]**.  
Other setting is set by the signal source menu called with **[MENU]**.

## ④ RESPONSE block

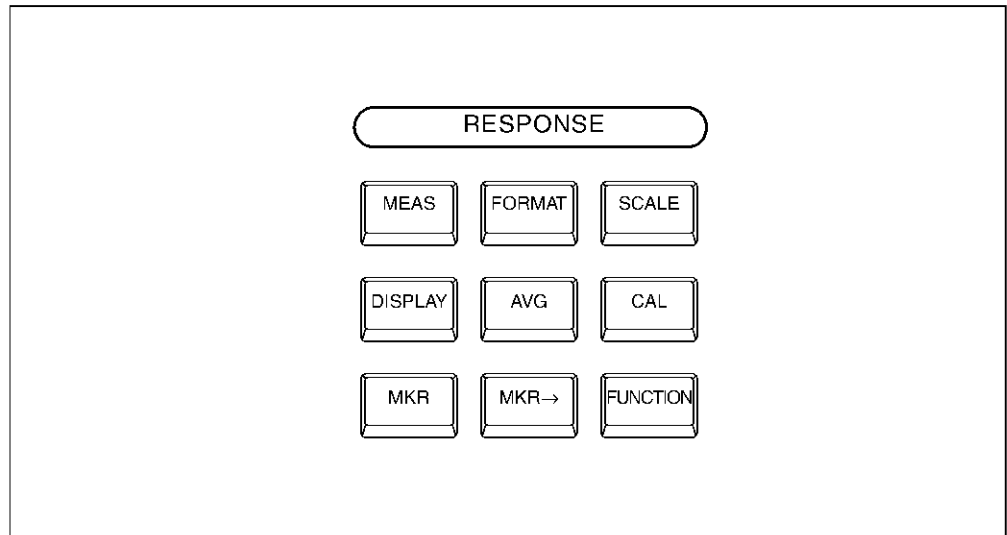

In the RESPONSE block, the measurement condition in the receiver section, the measurement parameter, the measurement format, the display format and the marker of the active channel are set.

- [MEAS]** : The input port and the measurement parameter are set.
- [FORMAT]** : The format of measured data is set.
- [SCALE]** : Coordinate axis of the display is set.
- [DISPLAY]** : Two channels simultaneous display, trace conversion and the label input are set.
- [AVG]** : Data average, smoothing and resolution bandwidth are set.
- [CAL]** : The calibration function is set.
- [MKR]** : The marker is set.
- [MKR→]** : The analysis by the marker is set.
- [FUNCTION]** : Input attenuator and impedance in the receiver section are set.

3.1 Basic Operation

⑤ INSTRUMENT STATE block

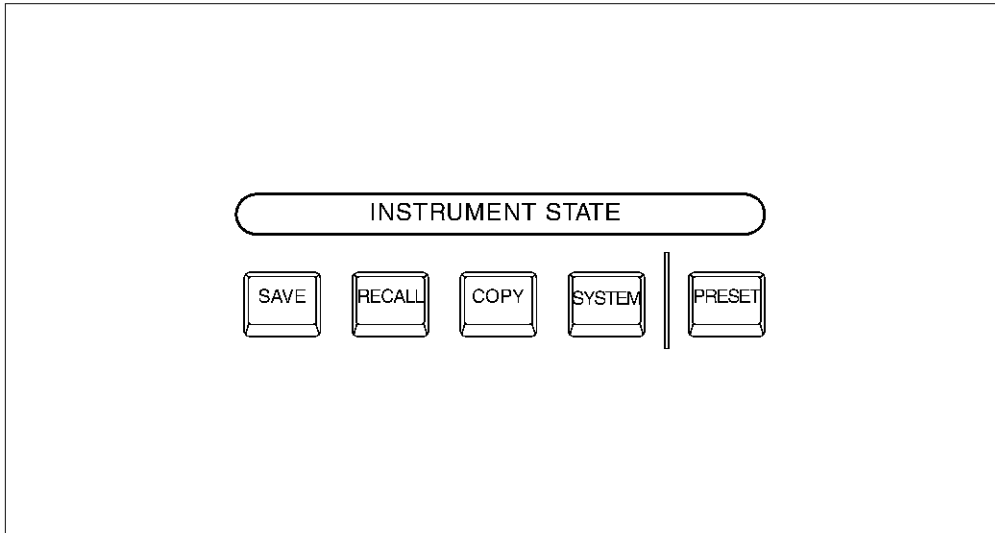

In the INSTRUMENT STATE block, the system control functions that have no effect to the measured data are set.

The displays of the date and time, the limit line test, the saving and the recall, and the hard copies are included in the system control function.

- [SAVE]** : Setting state and the calibration data of R3754 Series are saved.
- [RECALL]** : Setting state and the calibration data of R3754 Series are recalled.
- [COPY]** : The measurement trace is output to the plotter or measured data are printed.
- [SYSTEM]** : The display of the date and time are set.
- [PRESET]** : The setting state of R3754 Series is initialized.



## ⑥ GPIB block

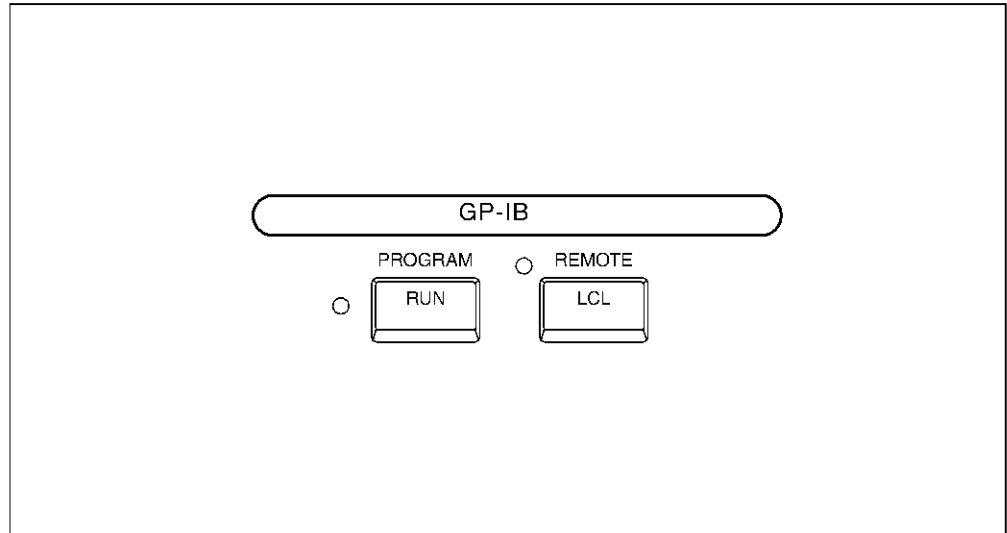

In the GPIB block, the BASIC controller function, GPIB-bus and the GPIB address are set. Refer to the programming manual of the separate volume for programming.

**PROGRAM**

**[RUN]** : The BASIC controller function is called.

**REMOTE**

**[LCL]** : GPIB is set.

The operation of all panel keys are invalid when R3754 Series is in remote status by GPIB.

If this key is pressed, R3754 Series will become local status. And the operation of the panel key becomes possible.

3.1 Basic Operation

(5) Soft key

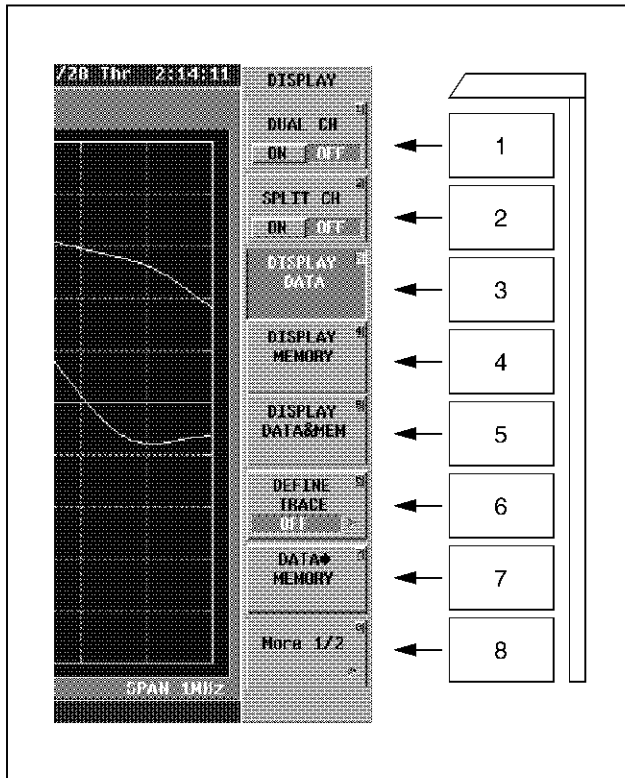

When the panel key is pressed, a set item corresponding to the function of the key will be displayed.

Those items can be chosen with the corresponding soft key.

(A left figure is an example of the soft key displayed when the DISPLAY key in the RESPONSE block is pressed. The display and the key of the figure correspond as shown.)

Figure 3-1 Soft key

### 3.1.2 Example of Basic Key Operation

Basic key operation of R3754 Series is explained here by the example of measuring the pass characteristic and the phase characteristic of the filter.

The characteristic impedance of the measured filter is assumed the nominal value  $50\Omega$ .

**Note:** *The Rate measurement is only available for the analyzers with Option 10 or 11 installed.*

#### (1) Setup

When carrying out a Rate measurement, the filter is connected between the OUTPUT2 and INPUT A (or B) connectors by the cables (refer to Figure 3-2 (a)).

When carrying out an Absolute measurement, the filter is connected between the OUTPUT1 and INPUT R connectors by the cables (refer to Figure 3-2 (b)).

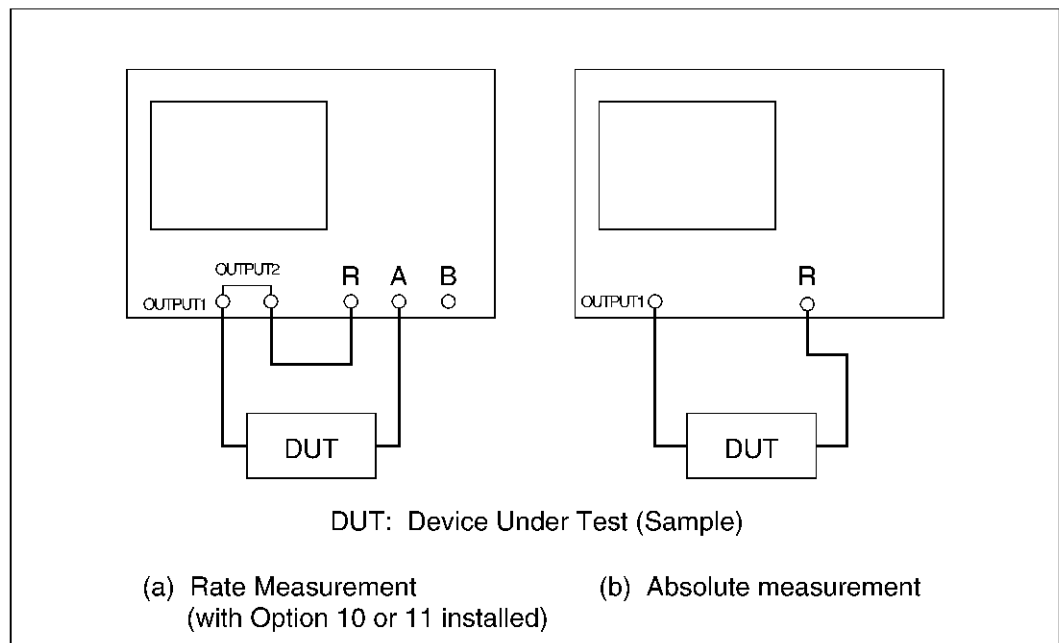

**Figure 3-2 Setup (Connection of DUT)**

#### (2) Presetting

**[PRESET]** is pressed. And R3754 Series is made an initial state. Refer to the section A.1 for the initial setting.

3.1 Basic Operation

(3) Frequency setting of signal source

Set the frequency of the signal source according to the characteristic of the filter. The band pass filter of 10.7MHz is measured here. Therefore the following are set.

[CENTER] → [1] → [0] → [.] → [7] → [MHz]

[SPAN] → [1] → [MHz]

The trace shown in the following figure is displayed by the above-mentioned operation.

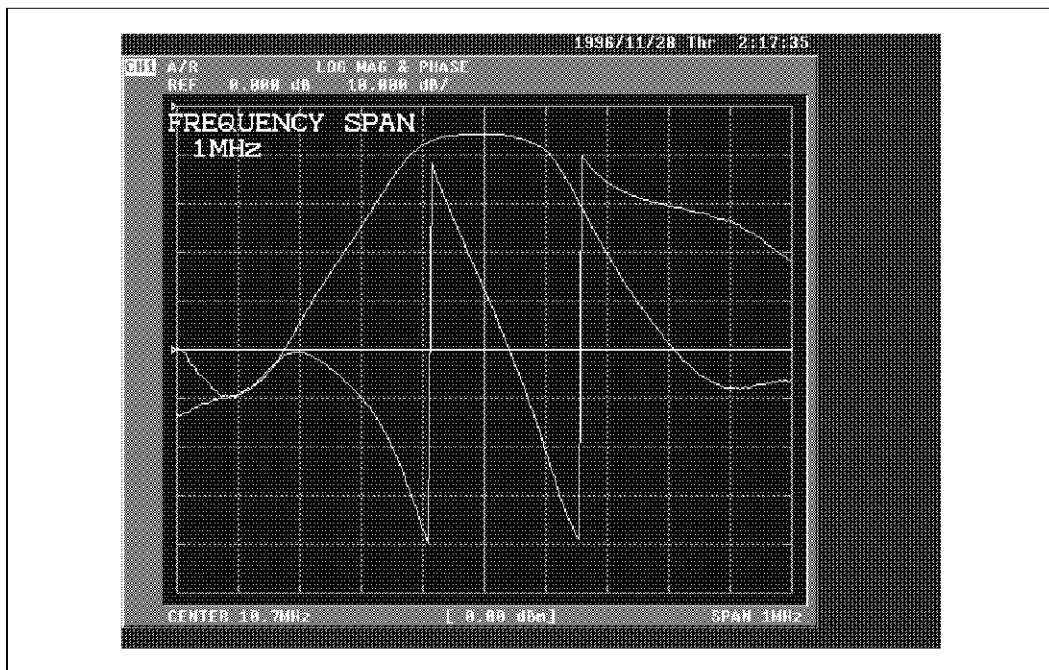

Figure 3-3 Frequency Setting

Next, the display coordinates are optimized to the display trace. The current FORMAT is two traces displays of LOG MAG & PHASE. (The first trace: LOG MAG, the second trace: PHASE) AUTO SCALE is executed for each trace. (Automatic setting of display coordinates)

[SCALE] Confirm SCALE FOR of the display menu is in 1st (the first trace) when the SCALE key is pressed.

{AUTO SCALE}

{SCALE FOR 2nd/1st} (2nd (the second trace) is selected)

{AUTO SCALE}

The trace is displayed as shown in the following figure by the above-mentioned operation.

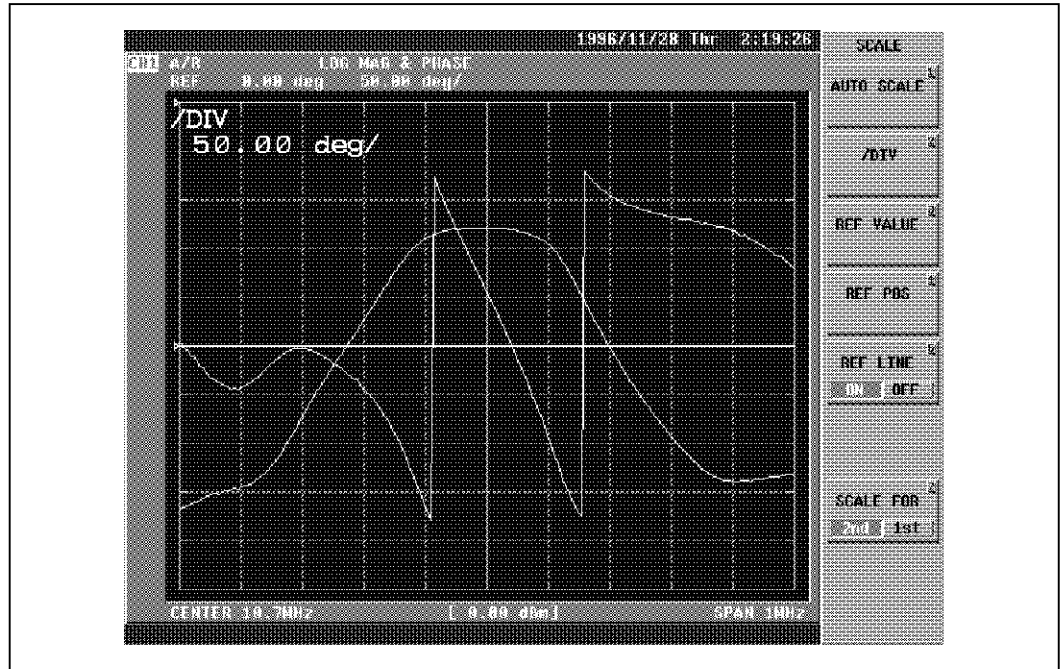

Figure 3-4 Scale Setting

- (4) Display of marker

Measured value of each point can be directly read by the marker display.

[MKR]



3.1 Basic Operation

The marker is displayed as shown in the figure below by the above-mentioned operation.

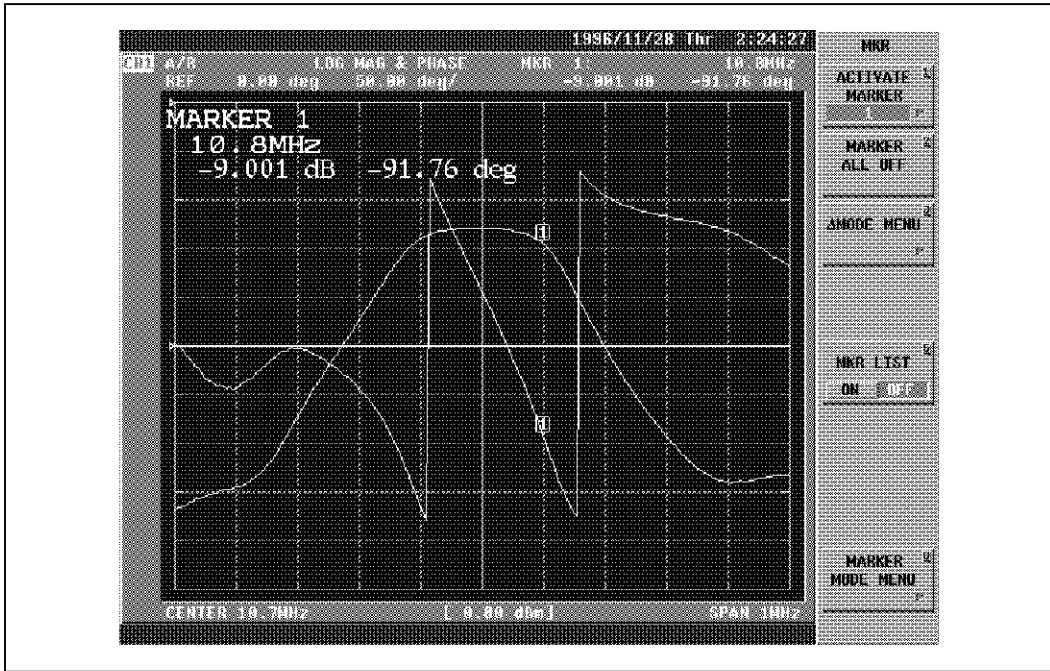

Figure 3-5 Marker Display

## 3.2 Measurement Method Example

A basic operation method is explained here by the example of measuring the actual band pass filter (BPF) and crystal resonator.

The measurement method examples are shown as follows.

1. Filter Measurement
2. Phase Measurement
3. Group Delay Measurement
4. Narrow-band and Wide-band Measurements
5. Logarithmic Magnitude and Phase Measurements
6. Logarithmic Magnitude and Group Delay Measurements
7. Linear Magnitude and Phase Measurements
8. Dual Channel Simultaneous Display Measurement
9. Reflection Characteristic Measurement
10. Crystal Resonator Measurement
11. Multi-marker Measurement
12. Delta Marker Measurement
13. Delta Section Marker Measurement
14. Marker Analysis Measurement
15. Marker Coupling and Interpolation Measurements
16. Program Sweep Measurement
17. Ceramic Oscillator Resonance and Antiresonance Point Measurements
18. Measured Data Plotter Output
19. Using the Save/Recall Register
20. Saving to Floppy Disks
21. Crystal Resonator Impedance Measurement

All screen displays here are displays of R3754B.



3.2 Measurement Method Example

3.2.1 Filter Measurement

The operation method of filter analysis is explained here by the example of measuring the band pass filter of center frequency 21.4MHz.

- ① Setup (filter connection) and presetting (Refer to section 3.1.2 and Figure 3-2).
- ② The measurement format is made a magnitude (Logarithmic display).

[FORMAT] → {LOG MAG}

- ③ Set center frequency and span.

[CENTER] → [2] → [1] → [.] → [4] → [MHz]

[SPAN] → [5] → [0] → [kHz]

- ④ Make the condition of through and calibrate the frequency characteristic.

First of all, remove the DUT. And instead, connect the short adapter. Under such a condition, execute normalization.

[CAL] → {NORMALIZE (THRU)}

The display is shown in the figure below. The CORRECT key automatically turns on.

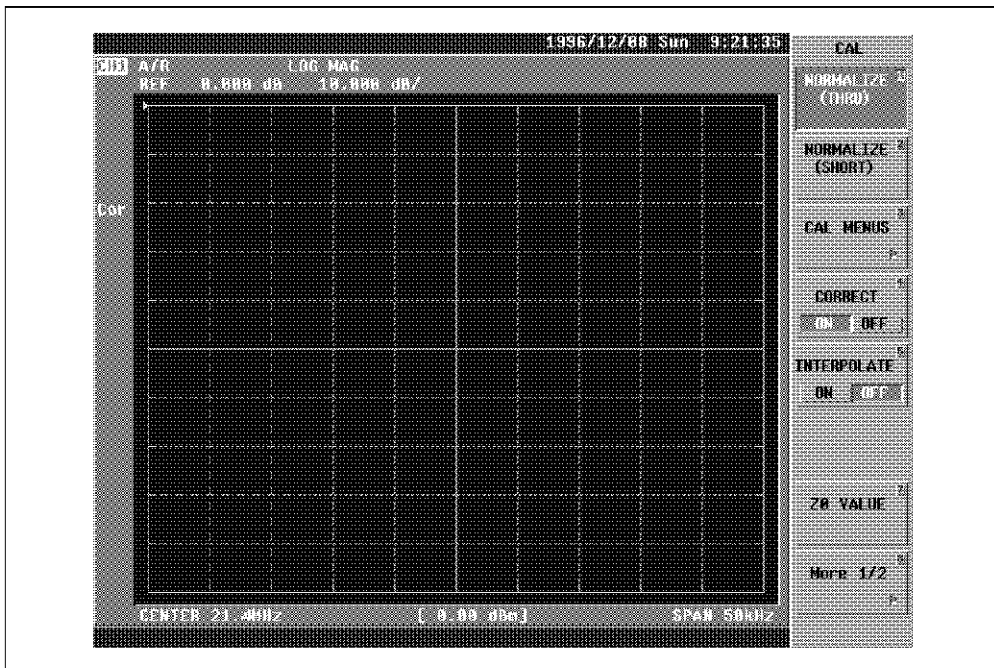

Figure 3-6 Calibration (Normalization)

After ending, the connection will be returned to DUT (Filter).



- ⑤ Adjust the scale of the trace display. The display comes to see easily.

[SCALE] → {AUTO SCALE}

The display is shown in the figure below.

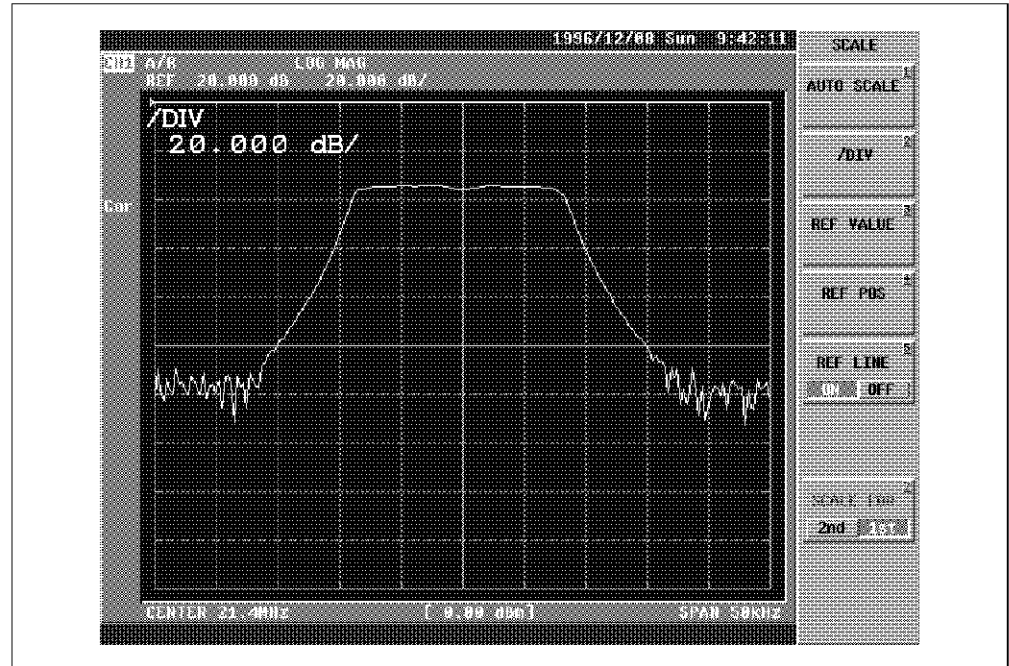

Figure 3-7 Auto Scale

- ⑥ It is measurement of bandwidth of 3dB.

The marker is set. And the filter analysis function is started.

[MKR →] → {MKR SEARCH [ ]} → {FLTR ANAL} → {FLTR ANAL ON/OFF}

3.2 Measurement Method Example

The screen display is shown in the figure below. Measured bandwidth is shown on the trace by the arrow (↓).  
 The analysis result is displayed.

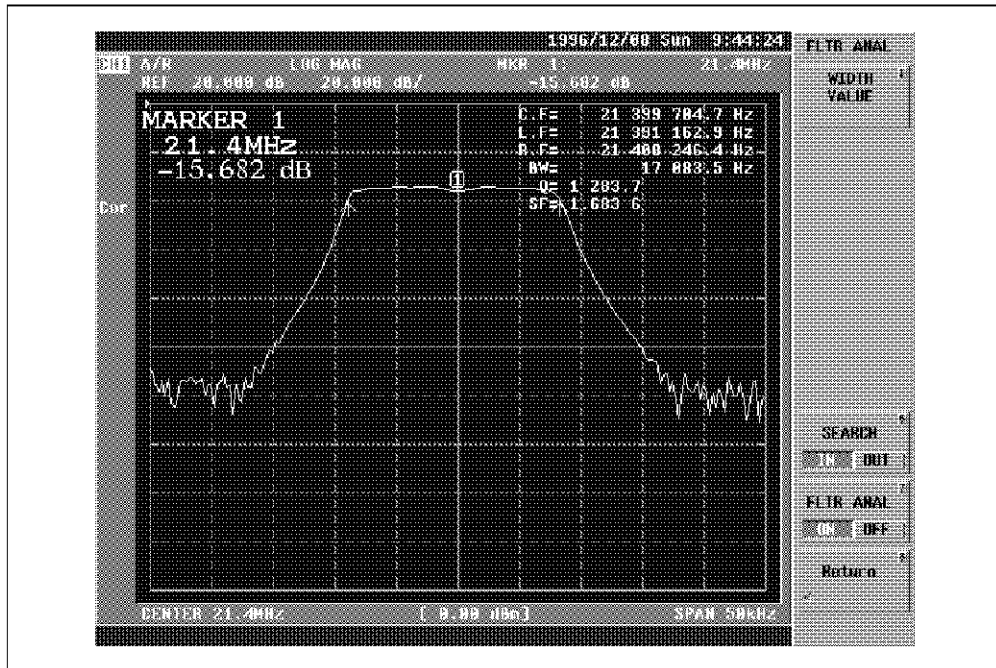

Figure 3-8 Filter Analysis (3dB)

- ⑦ It is measurement of bandwidth of 6dB.  
 WIDTH VALUE (searched bandwidth) is changed from 3dB (initial value) to 6dB.  
 {WIDTH VALUE} → [6] → [X1]

The display is shown in the figure below.

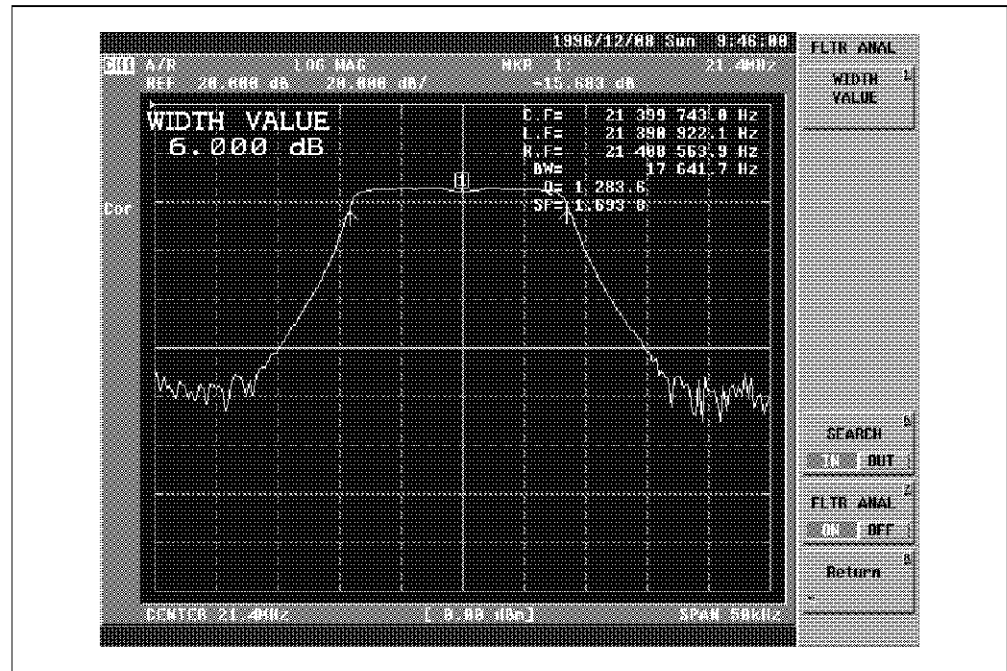

Figure 3-9 Filter Analysis (6dB)

### 3.2.2 Phase Measurement

The method of measuring the phase is explained here by the example of the band pass filter of center frequency 10.7MHz as well as the preceding clause.

- ① Setup (filter connection) and presetting (Refer to section 3.1.2 and Figure 3-2).
- ② The measurement format is made a phase display.

[FORMAT] → {PHASE}

- ③ Set center frequency and span.

[CENTER] → [1] → [0] → [.] → [7] → [MHz]

[SPAN] → [1] → [MHz]

3.2 Measurement Method Example

- ④ Calibrate the frequency characteristic.

Operate similarly by the item ④ of section 3.2.1 (measurement of filter).  
The display becomes an usual phase display as shown in the figure below.

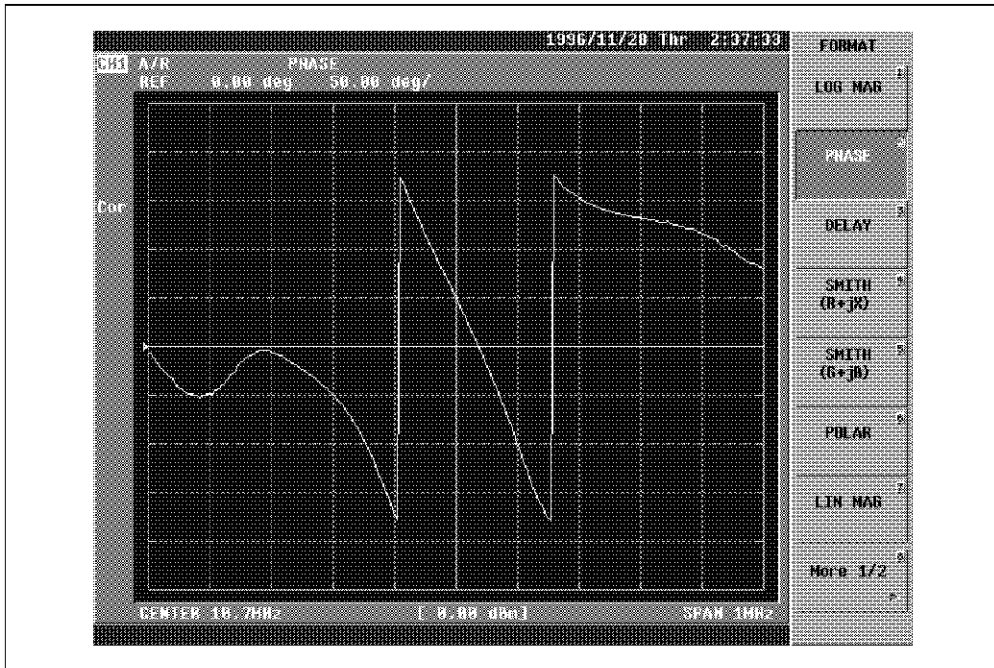

Figure 3-10 Phase Measurement

- ⑤ Make it to the phase extension display.

[FORMAT] → {More 1/2} → {PHASE - ∞, + ∞}

The display is shown in the figure below.

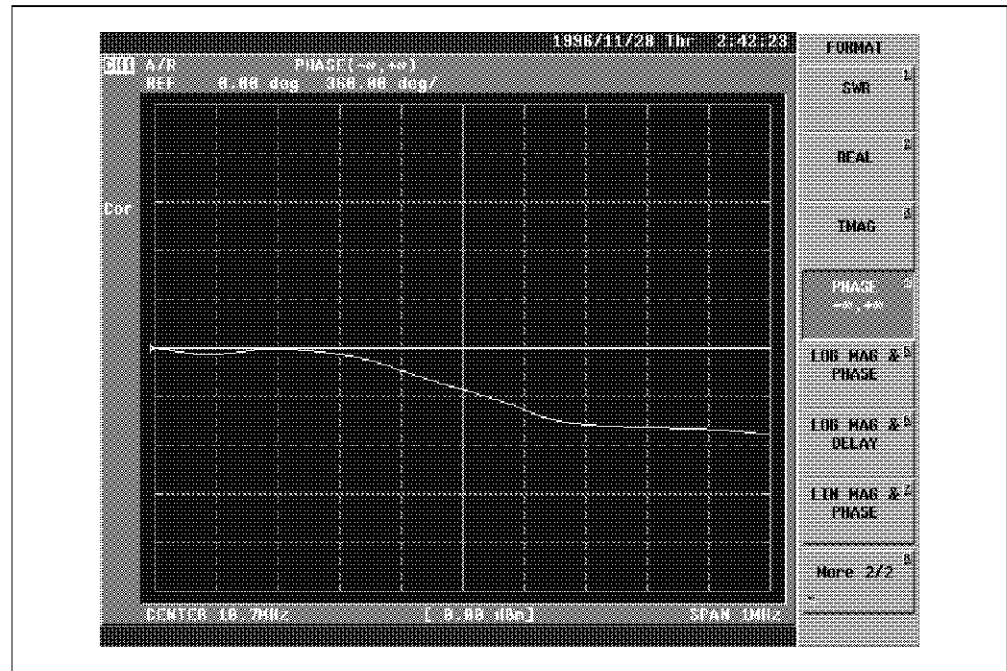

Figure 3-11 Phase Measurement ( $-\infty$  to  $+\infty$ )

### 3.2.3 Group Delay Measurement

The method of measuring the group delay is explained here by the example of the band pass filter of center frequency 10.7MHz as well as the preceding clause.

- ① Setup (filter connection) and presetting (Refer to section 3.1.2 and Figure 3-2).
- ② The measurement format is made a group delay display.

**[FORMAT]** → {DELAY}

- ③ Set center frequency and span.

**[CENTER]** → [1] → [0] → [.] → [7] → [MHz]

**[SPAN]** → [1] → [MHz]

- ④ Calibrate the frequency characteristic.

Operate similarly by the item ④ of section 3.2.1 (measurement of filter).



3.2 Measurement Method Example

- ⑤ Adjust the scale of the display trace. The display comes to see easily.

[SCALE] → {AUTO SCALE}

The display is shown in the figure below.

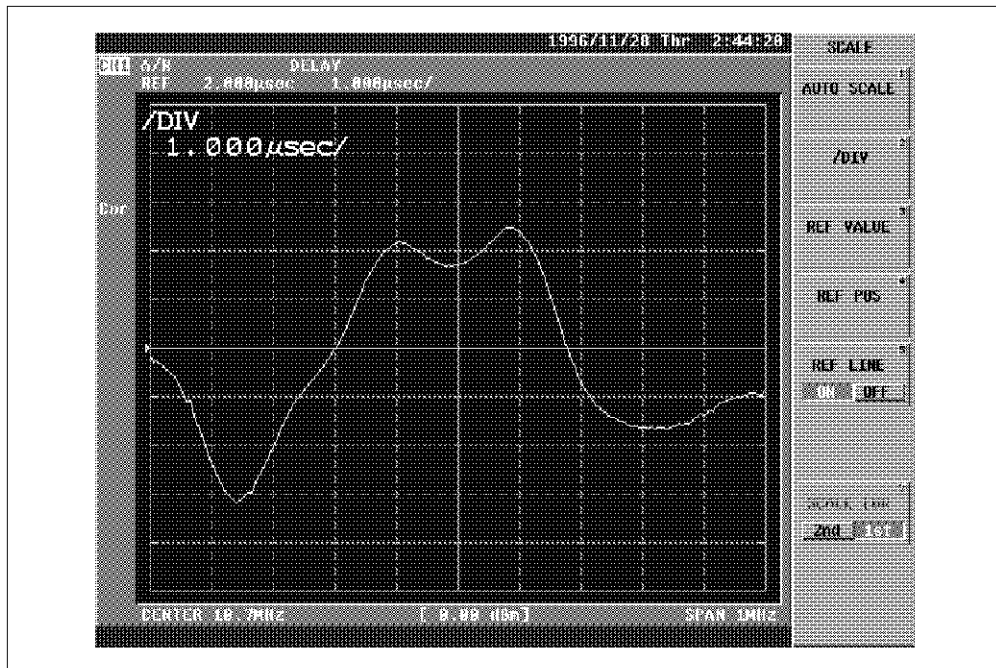

Figure 3-12 Group Delay Measurement

- ⑥ The aperture of the group delay is changed to 20 percent.

[AVG] → {GROUP DELAY APERTURE} → [2] → [0] → [X1]

The display is shown in the figure below.

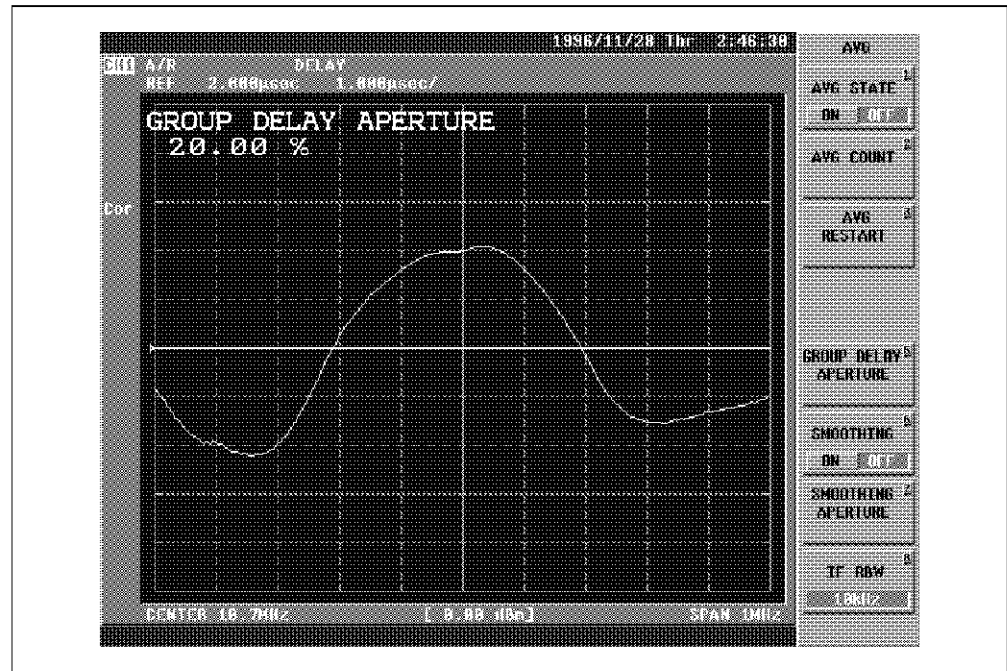

Figure 3-13 Aperture Setting

### 3.2.4 Narrow-band and Wide-band Measurements

The operation methods of setting for the difference measuring condition to the channel 1 and 2 is explained here by the example of the band pass filter of center frequency 10.7MHz.

- ① Setup (filter connection) and presetting (Refer to section 3.1.2 and Figure 3-2).
- ② Make the measuring condition of the channel 1 and 2 set independence.

[MENU] → {COUPLED CH ON/OFF}

- ③ Set frequency range of the channel 1.

[CENTER] → [1] → [0] → [.] → [7] → [MHz]

[SPAN] → [1] → [MHz]

- ④ Set frequency range of the channel 2.

[CH2]

[CENTER] → [1] → [0] → [.] → [7] → [MHz]

[SPAN] → [0] → [.] → [5] → [MHz]

3.2 Measurement Method Example

- ⑤ Calibrate the frequency characteristic of the channel 1.

First of all, connect the short adapter instead of DUT.  
Under such a condition, normalize is done.

[CH1] → [CAL] → {NORMALIZE (THRU)}

- ⑥ Calibrate frequency characteristic of the channel 2 similarly.

[CH2] → {NORMALIZE (THRU)}

After ending, return the connection to DUT (filter).

- ⑦ Two channels are made a simultaneous display.

[DISPLAY] → {DUAL CH ON/OFF}

The display is shown in the figure below.

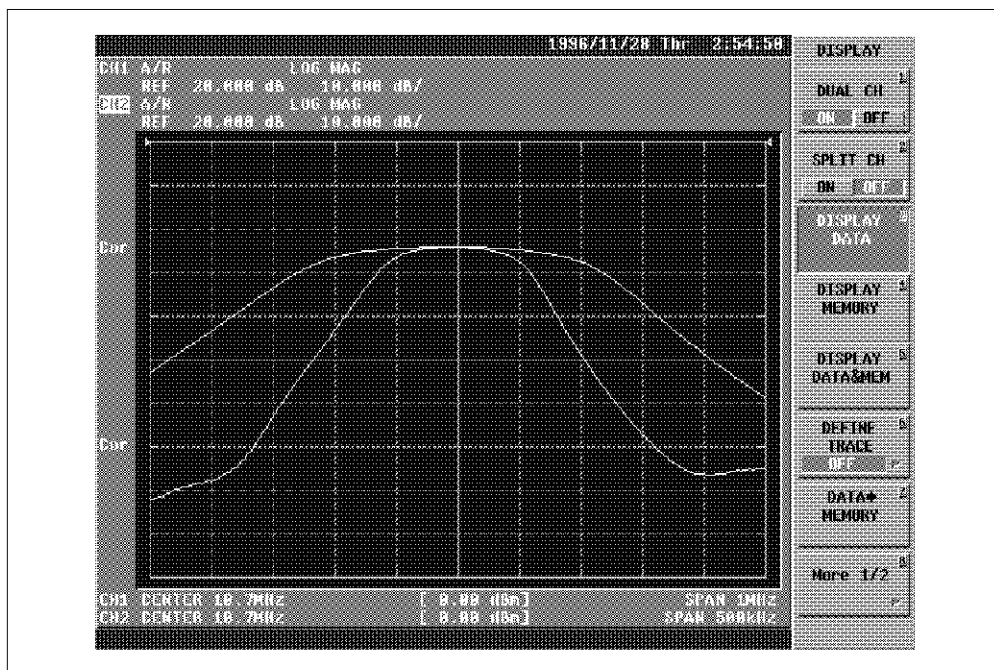

Figure 3-14 Narrow-band and Wide-band Measurements by Alternate Sweeping

- ⑧ The display is divided into the 2 of up and down.

{SPLIT CH ON/OFF}



The display is shown in the figure below.

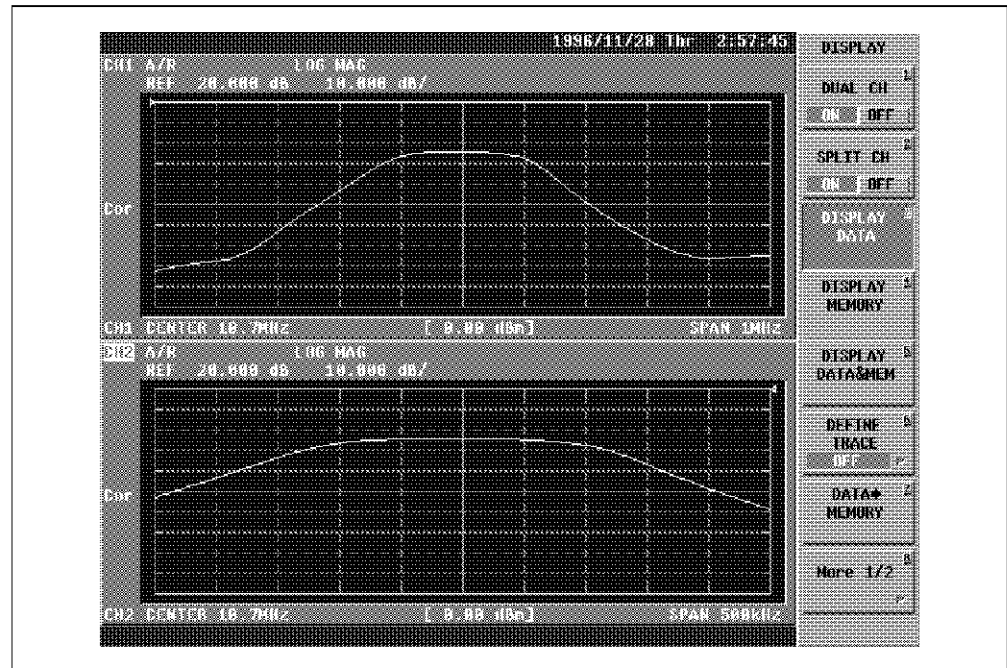

Figure 3-15 Narrow-band and Wide-band Measurements by Alternate Sweeping (Divided Display)

### 3.2.5 Logarithmic Magnitude and Phase Measurements

The measurement method of the logarithmic magnitude and the phase of two traces simultaneously displayed is explained here by the example of the band pass filter of center frequency 10.7MHz.

- ① Setup (filter connection) and presetting (Refer to section 3.1.2 and Figure 3-2).
- ② Set center frequency and span.

[CENTER] → [1] → [0] → [.] → [7] → [MHz]

[SPAN] → [1] → [MHz]

- ③ Calibrate the frequency characteristic.  
Operate similarly by the item ④ of section 3.2.1 (measurement of filter).

3.2 Measurement Method Example

- ④ Change the scale of the display trace.

When such two traces are simultaneously displayed by format, which trace is changed can be selected with SCALE FOR. The scale of first trace (logarithmic magnitude) is changed.

[SCALE] → {AUTO SCALE}

The display is shown in the figure below.

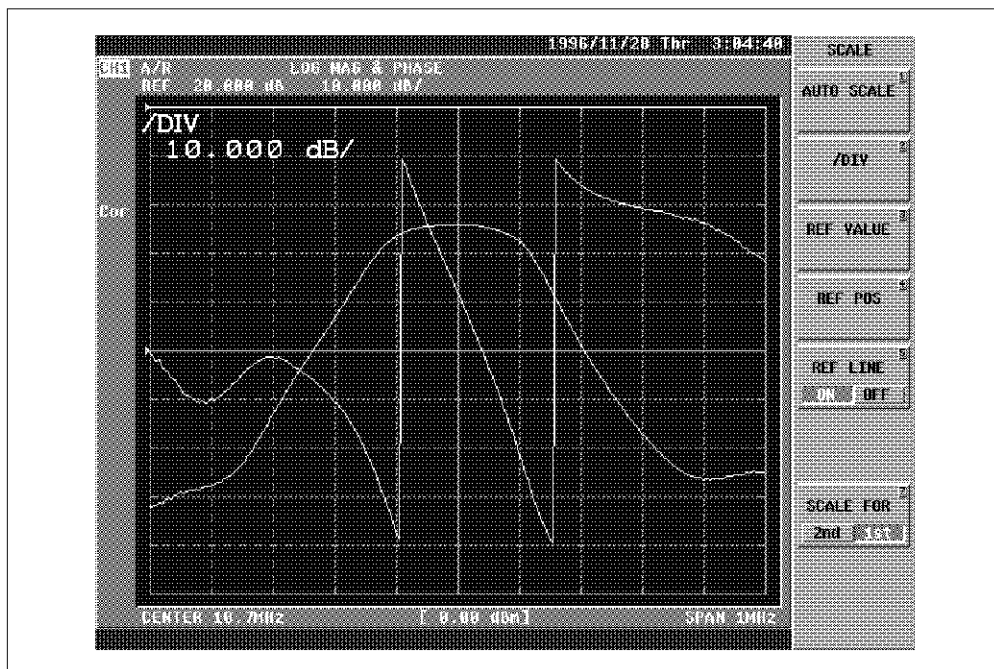

Figure 3-16 Logarithmic Magnitude and Phase Measurements (Two Traces Display)

- ⑤ To change scale of the second trace (phase), 2nd is selected with SCALE FOR.

{SCALE FOR 2nd/1st}

The display is shown in the figure below.

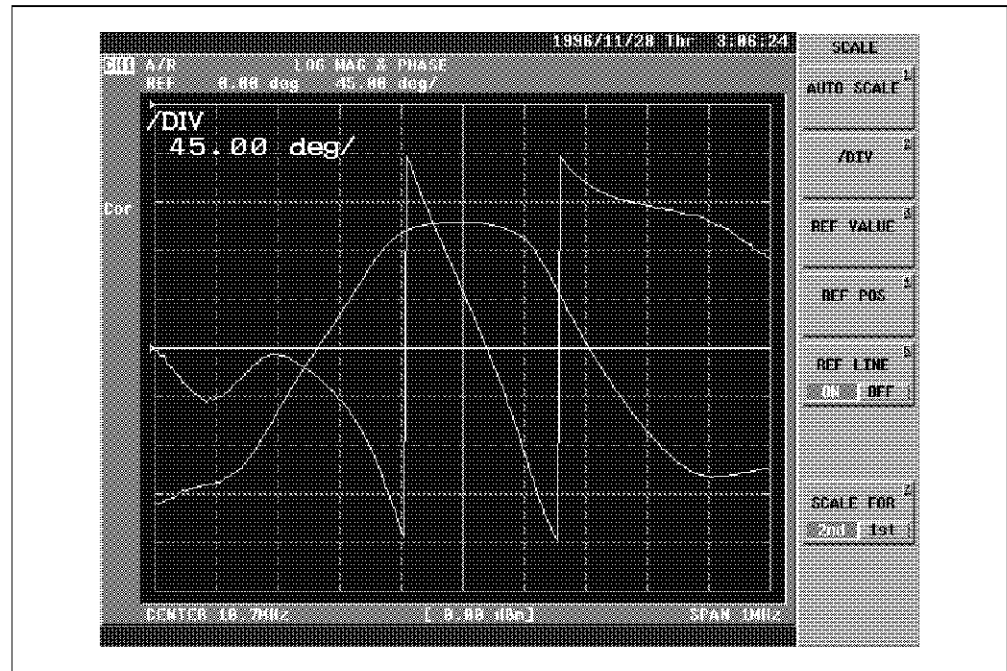

Figure 3-17 Selection of Scaling Trace

### 3.2.6 Logarithmic Magnitude and Group Delay Measurements

The measurement method for the logarithmic magnitude and the group delay by which two traces are simultaneously displayed is explained here by the example of the band pass filter of center frequency 10.7MHz.

- ① Setup (filter connection) and presetting (Refer to section 3.1.2 and Figure 3-2).
- ② Set center frequency and span.

[CENTER] → [1] → [0] → [.] → [7] → [MHz]

[SPAN] → [1] → [MHz]

- ③ Calibrate the frequency characteristic.  
Operate similarly by the item ④ of section 3.2.1 (measurement of filter).
- ④ Set the format in measurement to the logarithmic magnitude/the group delay.

[FORMAT] → {More 1/2} → {LOG MAG & DELAY}

3.2 Measurement Method Example

- ⑤ The scale of the first trace (logarithmic magnitude) is changed.

[SCALE] → {AUTO SCALE}

The display is shown in the figure below.

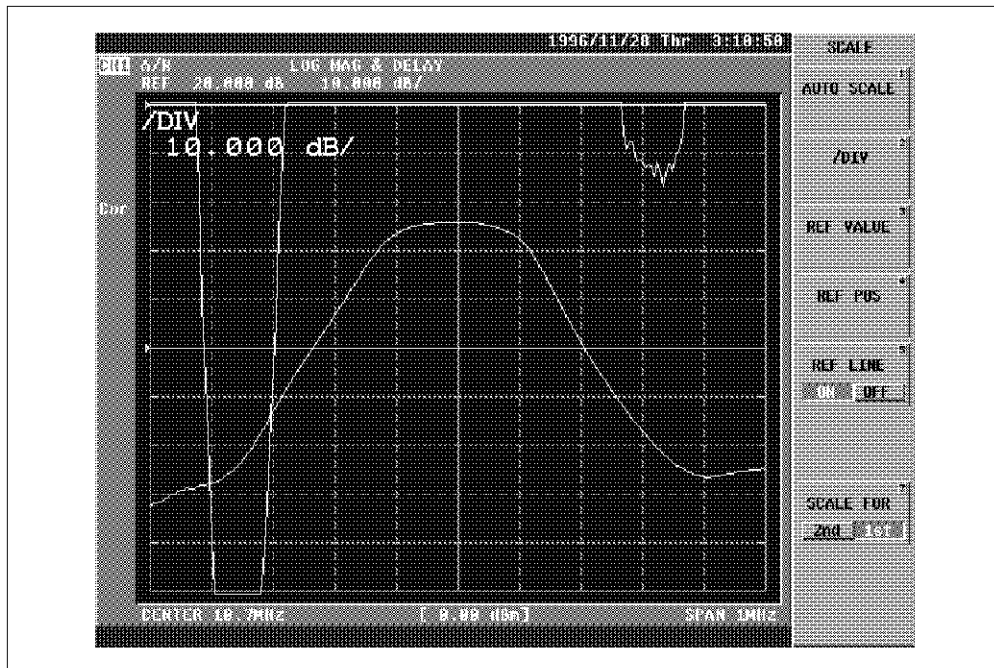

Figure 3-18 Logarithmic Magnitude and Group Delay (Two Traces Display)

- ⑥ The scale of the second trace (group delay) is changed.

{SCALE FOR 2nd/1st} → {AUTO SCALE}



The display is shown in the figure below.

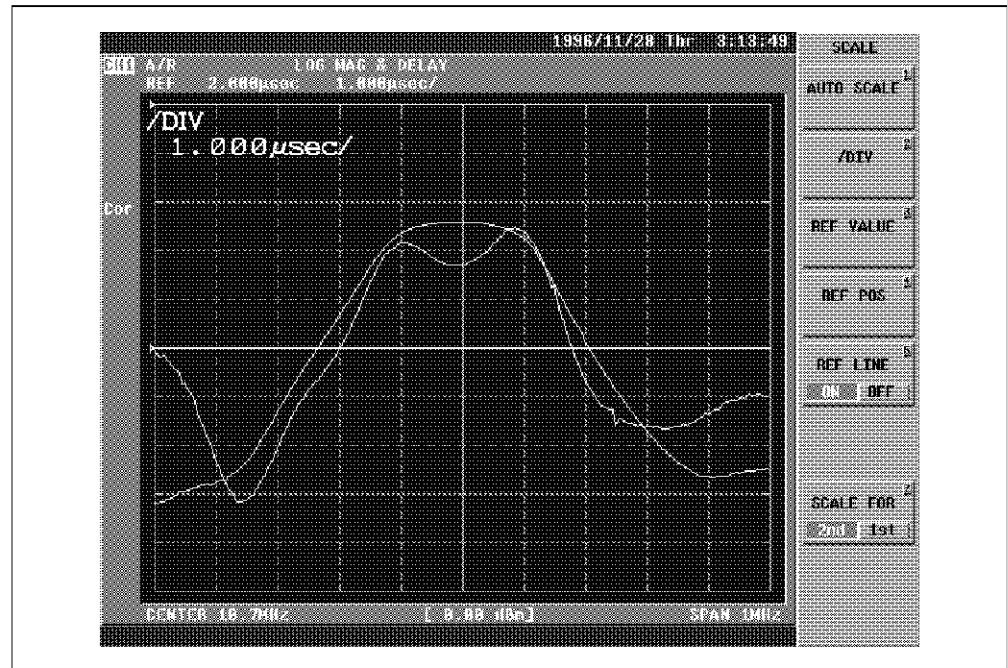

Figure 3-19 Scale Changing of Two Traces Display

### 3.2.7 Linear Magnitude and Phase Measurements

The measurement method for the linear magnitude and the phase by which two traces are simultaneously displayed is explained here by the example of the band pass filter of center frequency 10.7MHz.

- ① Setup (filter connection) and presetting (Refer to section 3.1.2 and Figure 3-2).
- ② Set center frequency and span.

[CENTER] → [1] → [0] → [.] → [7] → [MHz]

[SPAN] → [1] → [MHz]

- ③ Calibrate the frequency characteristic.  
Operate similarly by the item ④ of section 3.2.1 (measurement of filter).
- ④ The measurement format is set to the linear magnitude/the phase.

[FORMAT] → {More 1/2} → {LIN MAG & PHASE}

3.2 Measurement Method Example

- ⑤ The scale of the first trace (linear magnitude) is changed.

[SCALE] → {AUTO SCALE}

The display is shown in the figure below.

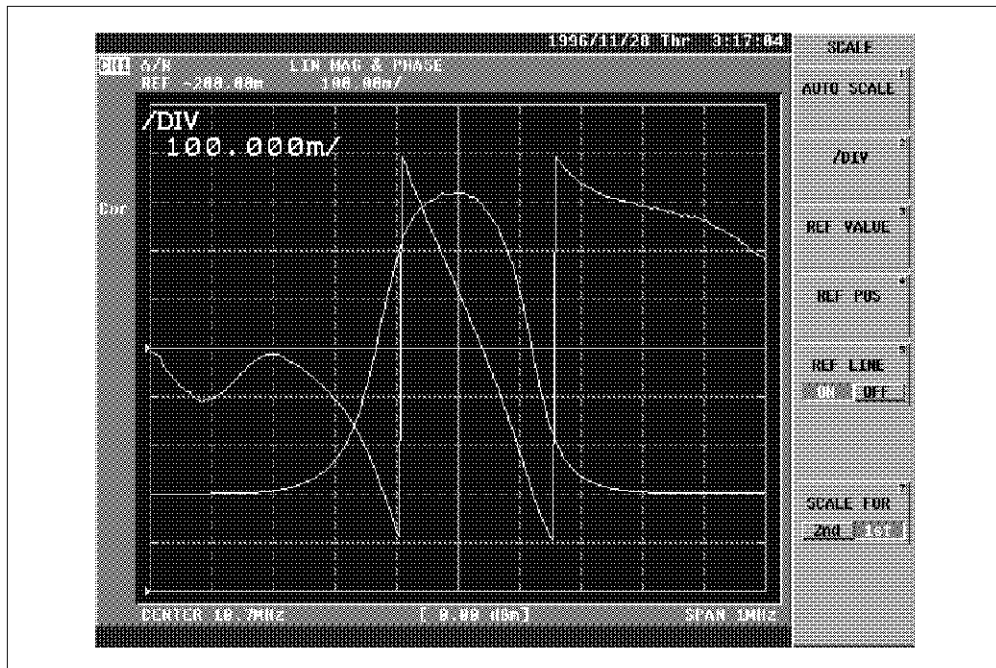

Figure 3-20 Linear Magnitude and Phase (Two Traces Display)

- ⑥ To change scale of the second trace, 2nd is selected with SCALE FOR for the second trace (phase).

{SCALE FOR 2nd/1st}

The display is shown in the figure below.

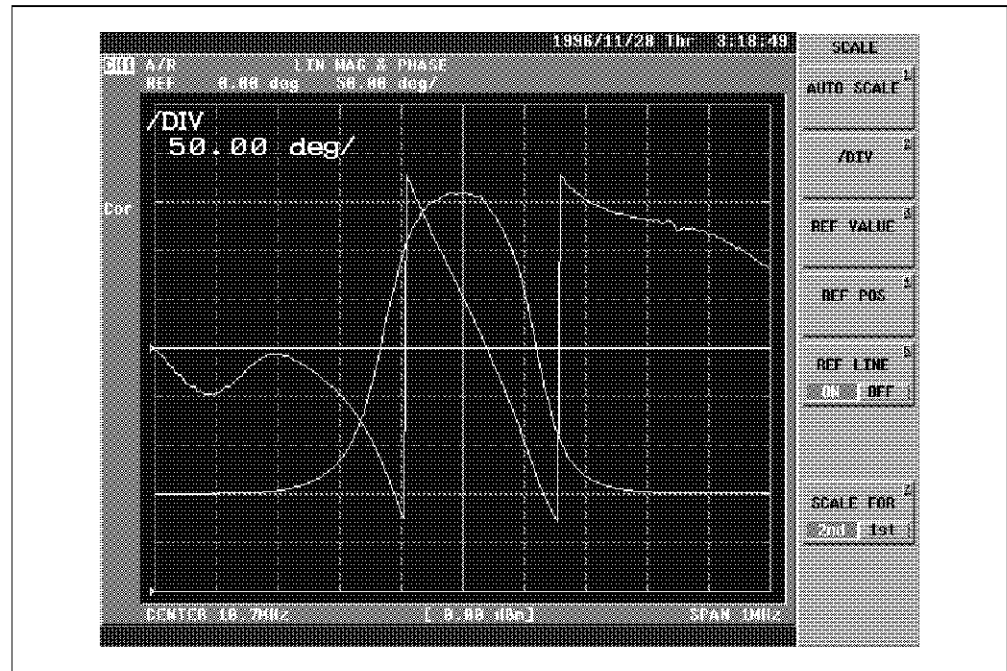

Figure 3-21 Scale Changing of Two Traces Display

### 3.2.8 Dual Channel Simultaneous Display Measurement

The operation method of simultaneously display of the channel 1 and 2 is explained here by the example of the band pass filter of center frequency 10.7MHz.

- ① Setup (filter connection) and presetting (Refer to section 3.1.2 and Figure 3-2).
- ② Set center frequency and span. The channels 1 and 2 are interlocked.

[CENTER] → [1] → [0] → [.] → [7] → [MHz]

[SPAN] → [1] → [MHz]

- ③ Calibrate the frequency characteristic. Each channel should be calibrated. First of all, the short adapter is connected instead of DUT. Under such a condition, normalization is done.

[CAL] → {NORMALIZE(THRU)} → [CH2] → {NORMALIZE(THRU)} → [CH1]

After ending, return the connection to DUT (filter).

- ④ Make it to dual channel simultaneous display.

[DISPLAY] → {DUAL CH ON/OFF} → {SPLIT CH ON/OFF}

3.2 Measurement Method Example

- ⑤ In dual channel simultaneous display, the operation of the format and the scale, etc. are done to the active channel independently. The channel 1 is made a magnitude format. And the scale is changed.

[CH1] → [FORMAT] → {LOG MAG} → [SCALE] → {AUTO SCALE}

The channel 2 is made a phase format.

[CH2] → [FORMAT] → {PHASE}

The display is shown in the figure below. This corresponds to measurement of logarithmic magnitude and phase of section 3.2.5.

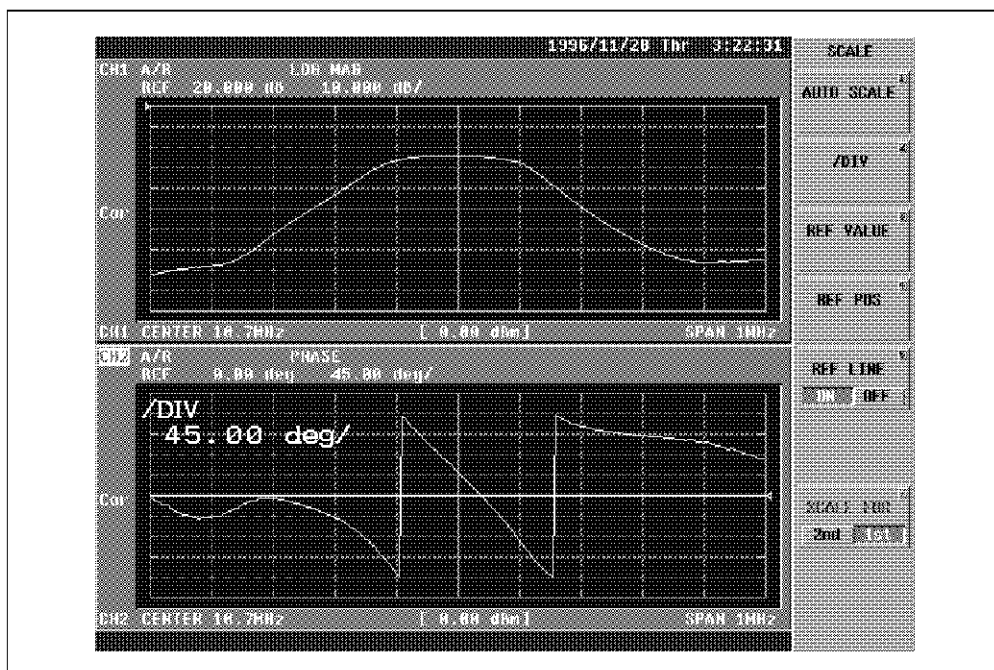

Figure 3-22 Dual Channel Simultaneous Measurement (Logarithmic Magnitude and Phase)



- ⑥ The channel 2 is made a group delay format.

{DELAY} → [SCALE] → {AUTO SCALE}

The display is shown in the figure below. This corresponds to measurement of logarithmic magnitude and group delay of section 3.2.6.

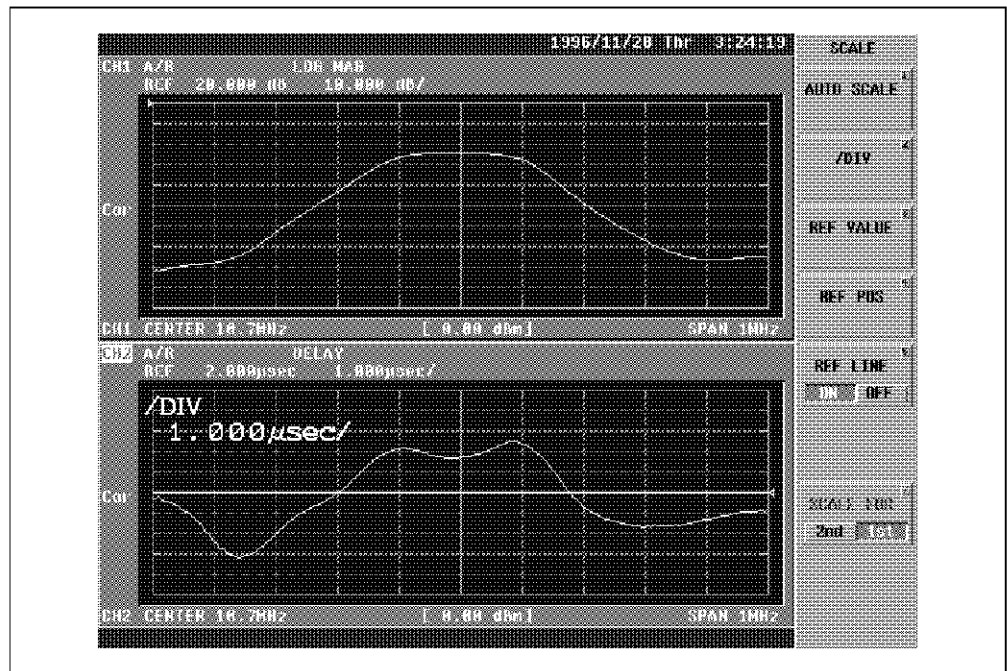

**Figure 3-23 Dual Channel Simultaneous Measurement  
(Logarithmic Magnitude and Group Delay)**

- ⑦ The channel 2 is made a phase. And the channel 1 is made a linear magnitude.

[FORMAT] → {PHASE}

[CH1] → {LIN MAG} → [SCALE] → {AUTO SCALE}

3.2 Measurement Method Example

The display is shown in the figure below. This corresponds to the measurement of linear magnitude and phase of section 3.2.7.

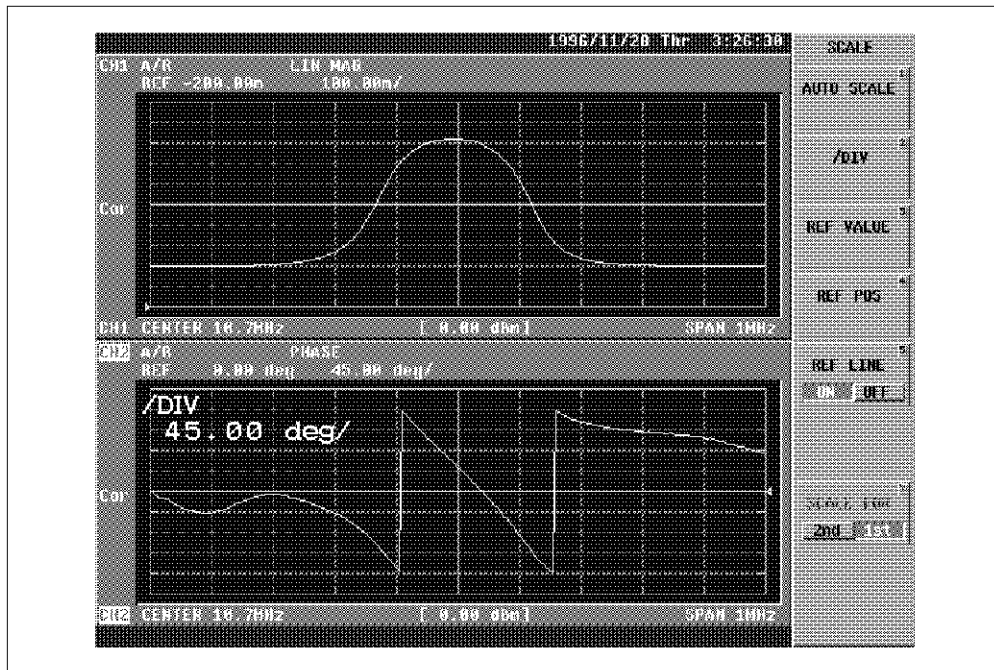

Figure 3-24 Dual Channel Simultaneous Measurement (Linear Magnitude and Phase)

3.2.9 Reflection Characteristic Measurement

The measurement method of the reflection characteristic is explained here by the example of the band pass filter of center frequency 38.5MHz.

- ① Setup it (bridge connection) and presetting. Use a directional bridge and ZRB2VAR-52 for the bridge.
- ② Set frequency range of measurement.

[CENTER] → [3] → [8] → [.] → [5] → [MHz]

[SPAN] → [5] → [MHz]

- ③ Calibrate as follows.

Call one port full calibration menu.

[CAL] → {CAL MENUS} → {1PORT FULL CAL}

- ④ The open standard is connected with the test port of the bridge. And the calibration data is acquired.

{OPEN}

The display is shown in the figure below.

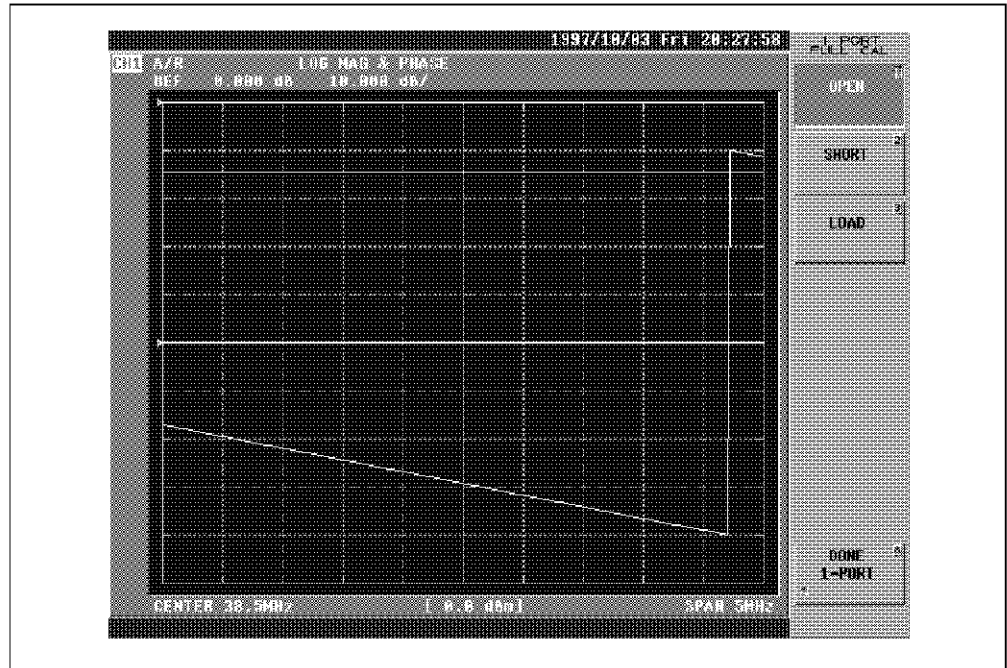

Figure 3-25 Calibration of Reflection Characteristic Measurement (Open)

3.2 Measurement Method Example

- ⑤ Short standard is connected with the test port of the bridge. And the calibration data is acquired.

{SHORT}

The display is shown in the figure below.

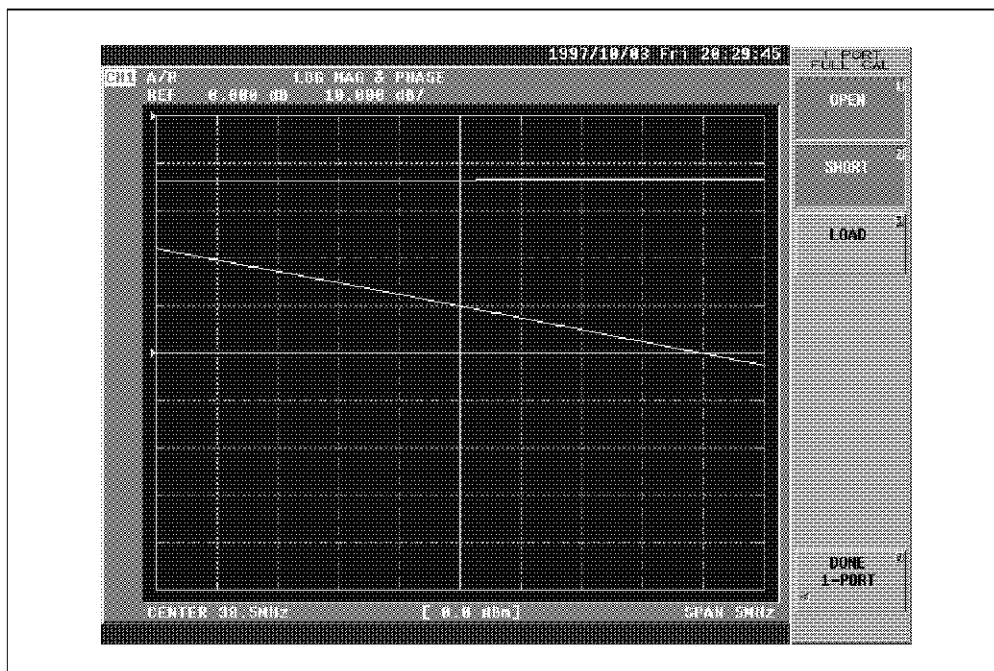

Figure 3-26 Calibration of Reflection Characteristic Measurement (Short)

- ⑥ Load standard is connected with the test port of the bridge. And the calibration data is acquired.

{LOAD}

The display is shown in the figure below.

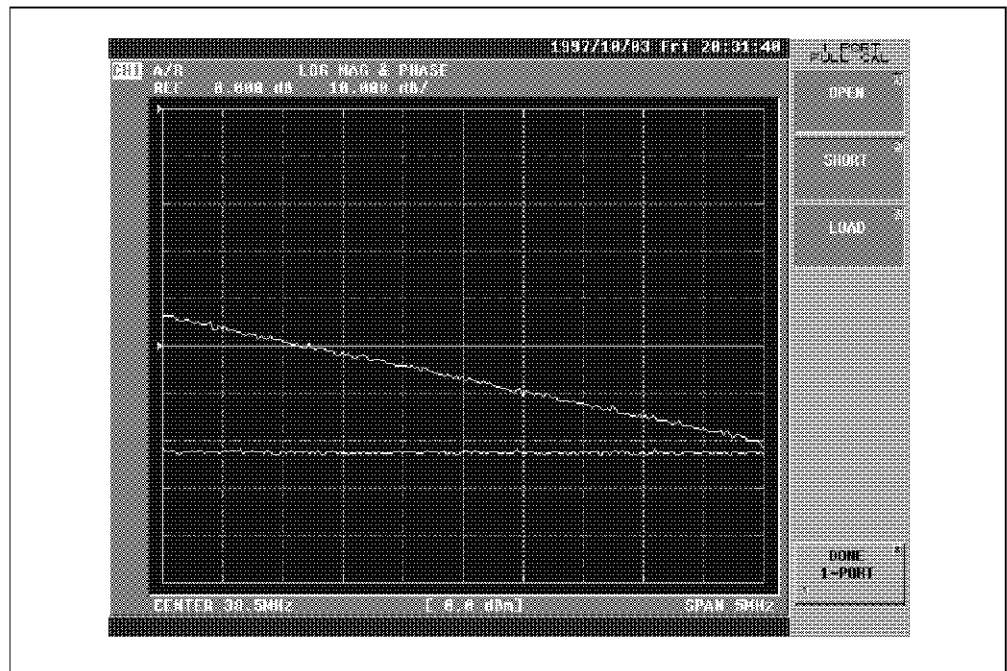

Figure 3-27 Calibration of Reflection Characteristic Measurement (Load)

- ⑦ The calibration is ended.

{DONE 1-PORT}

The calibration data becomes automatically effective.



3.2 Measurement Method Example

- ⑧ DUT (Filter) is connected with the test port of the bridge.

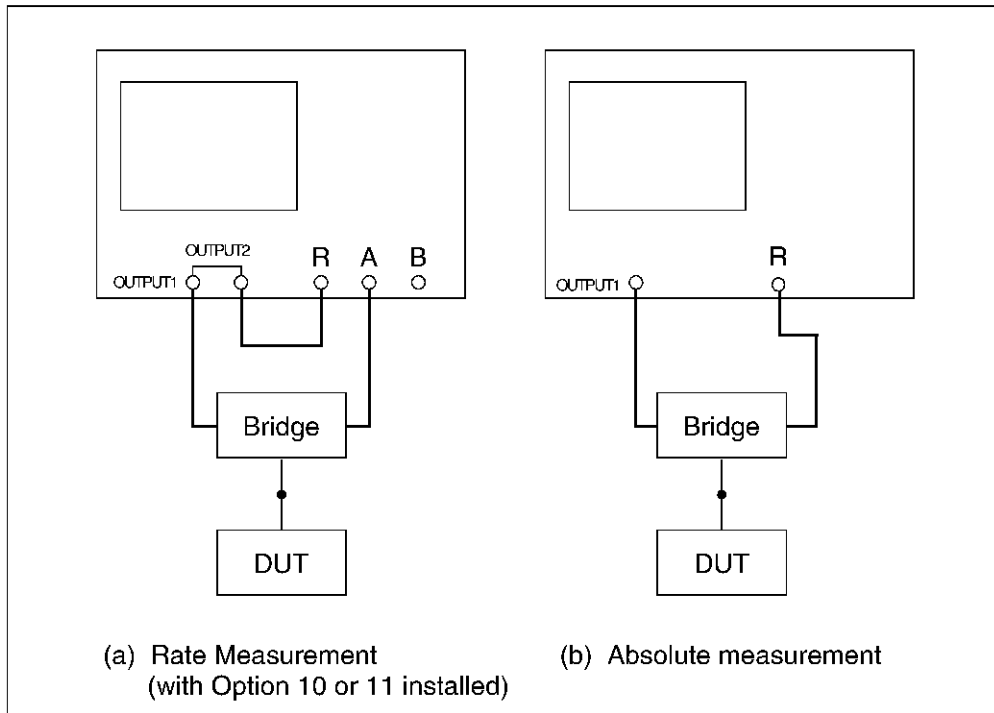

Figure 3-28 Connection for Reflection Characteristic Measurement

- ⑨ Adjust the scale of the display trace (Logarithmic magnitude). The display trace comes to see easily.

[SCALE] → {AUTO SCALE}

The display is shown in the figure below.

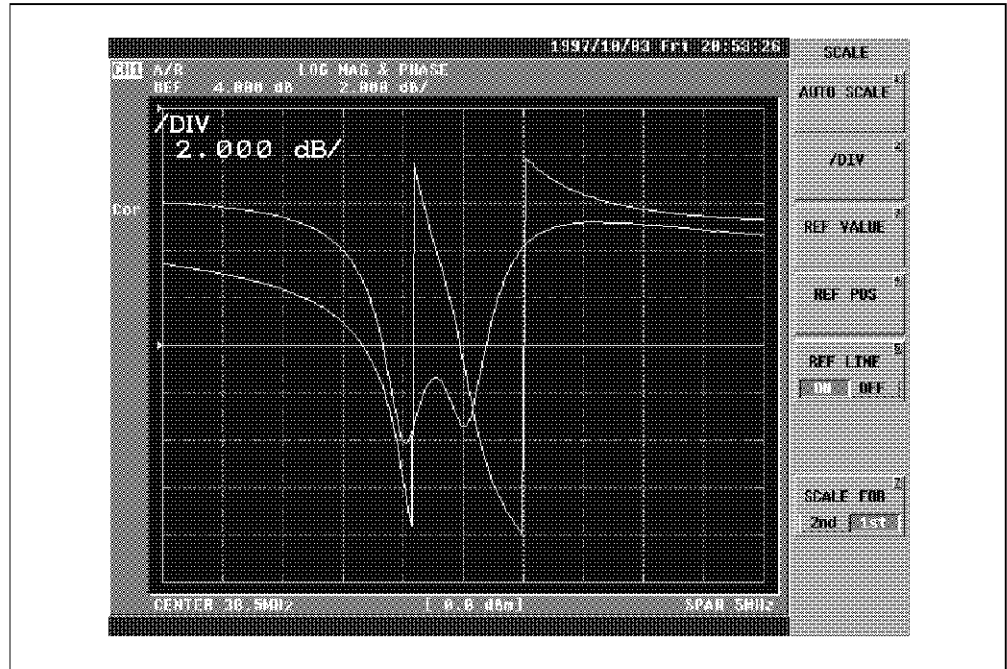

Figure 3-29 Scale Changing for Reflection Characteristic Measurement

- ⑩ Measured data is displayed in Smith chart.

[FORMAT] → {SMITH (R+jX)}

3.2 Measurement Method Example

The display is shown in the figure below.

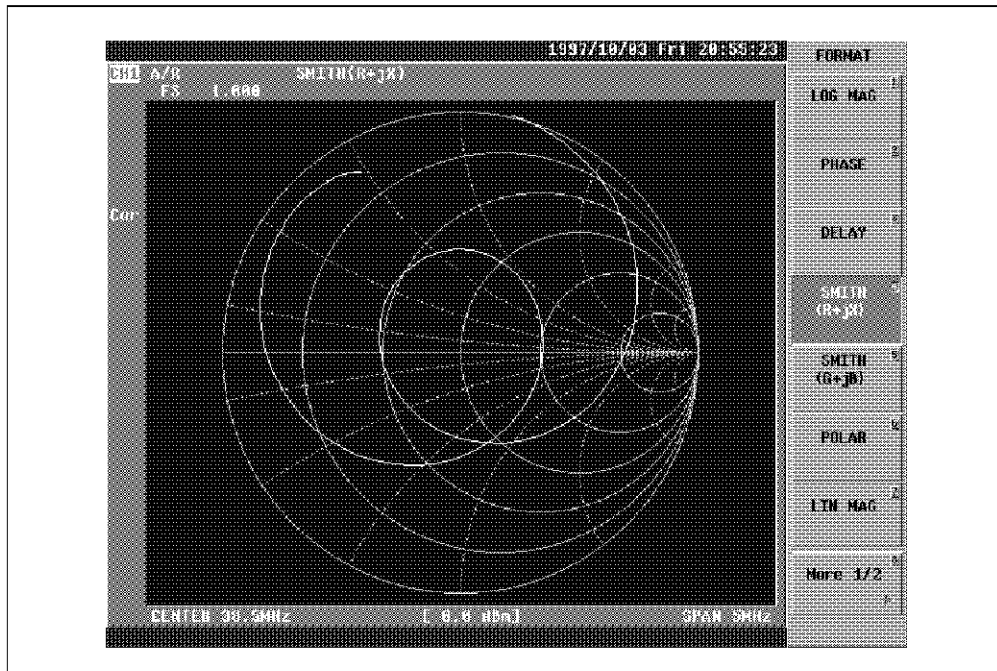

Figure 3-30 Format Changing (Smith Chart)

- ⑪ Measured data is displayed in the admittance chart.

{SMITH (G+jB)}



The display is shown in the figure below.

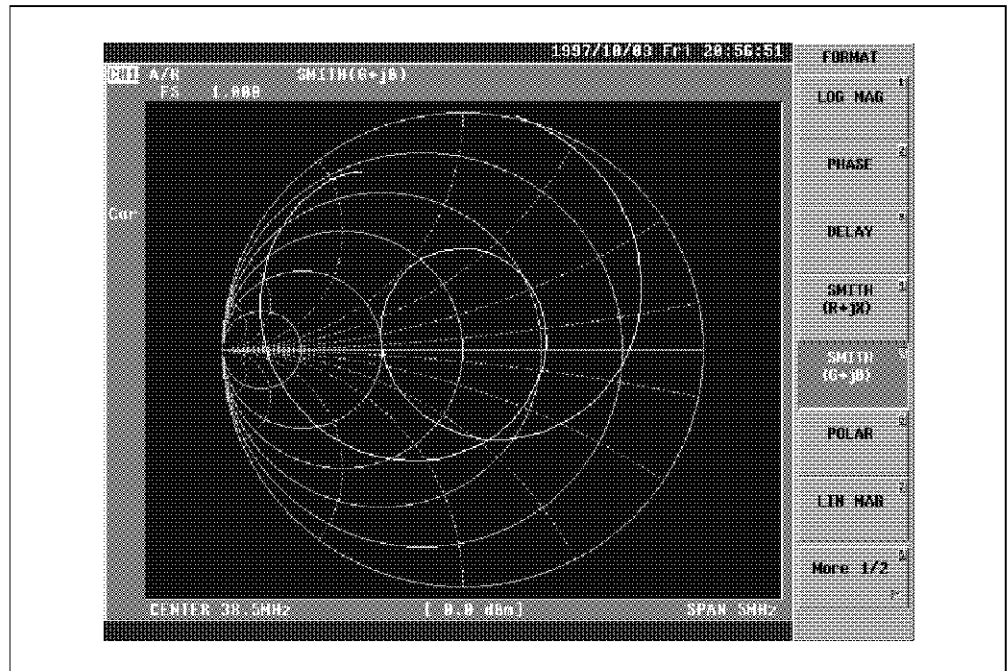

**Figure 3-31 Format Changing (Admittance Chart)**

- ⑫ Measured data is displayed in the polar coordinates (Polar).

{POLAR}

3.2 Measurement Method Example

The display is shown in the figure below.

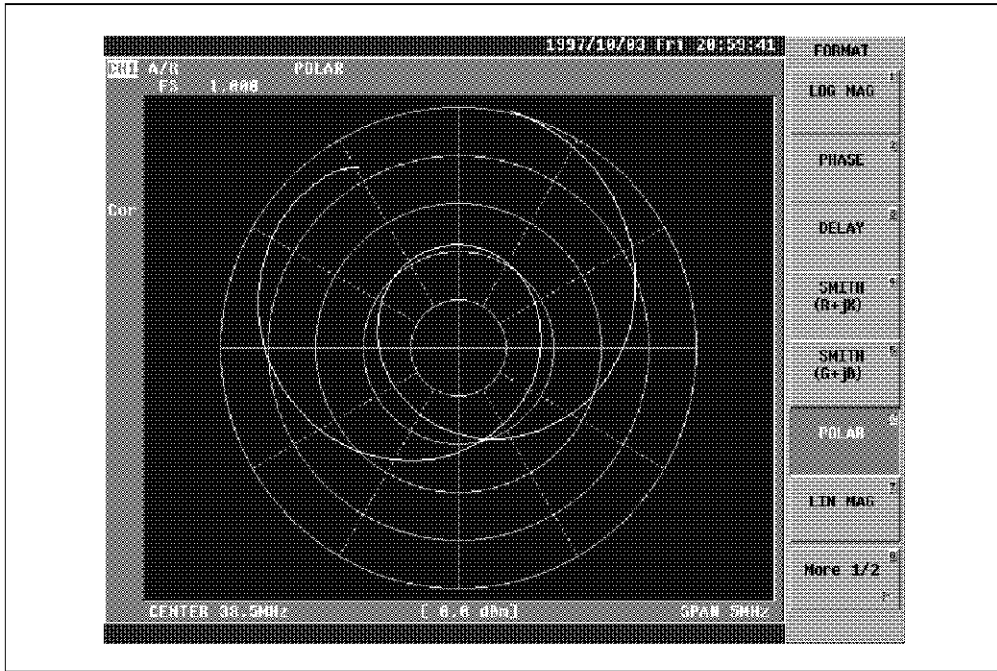

Figure 3-32 Format Changing (Polar Chart)

- ⑬ The scale is changed.

[SCALE] → [.] → [5] → [X1]

The display is shown in the figure below.

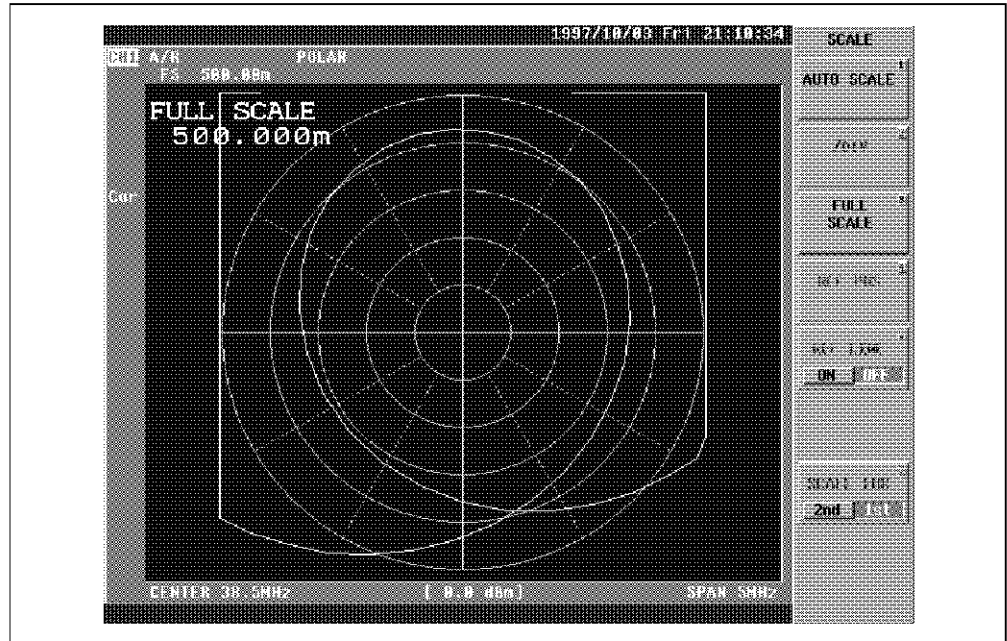

Figure 3-33 Scale Changing for Reflection Characteristic Measurement (1)

[2] → [X1]

The display is shown in the figure below.

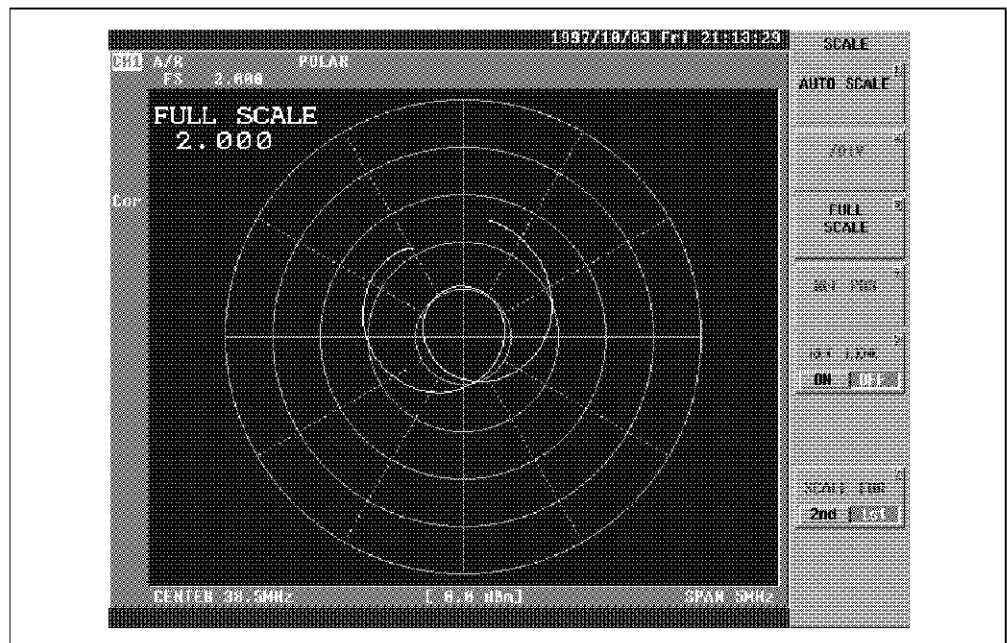

Figure 3-34 Scale Changing for Reflection Characteristic Measurement (2)

3.2 Measurement Method Example

**3.2.10 Crystal Resonator Measurement**

The measurement method the crystal resonator is explained here by the example of the crystal of 42MHz in which  $\pi$  network is used.

- ① Setup it ( $\pi$  network jig connection). Preset it. Use the PIC-001  $\pi$  network jig for the  $\pi$  network jig.
- ② Connect crystal to the test port of the  $\pi$  network jig.

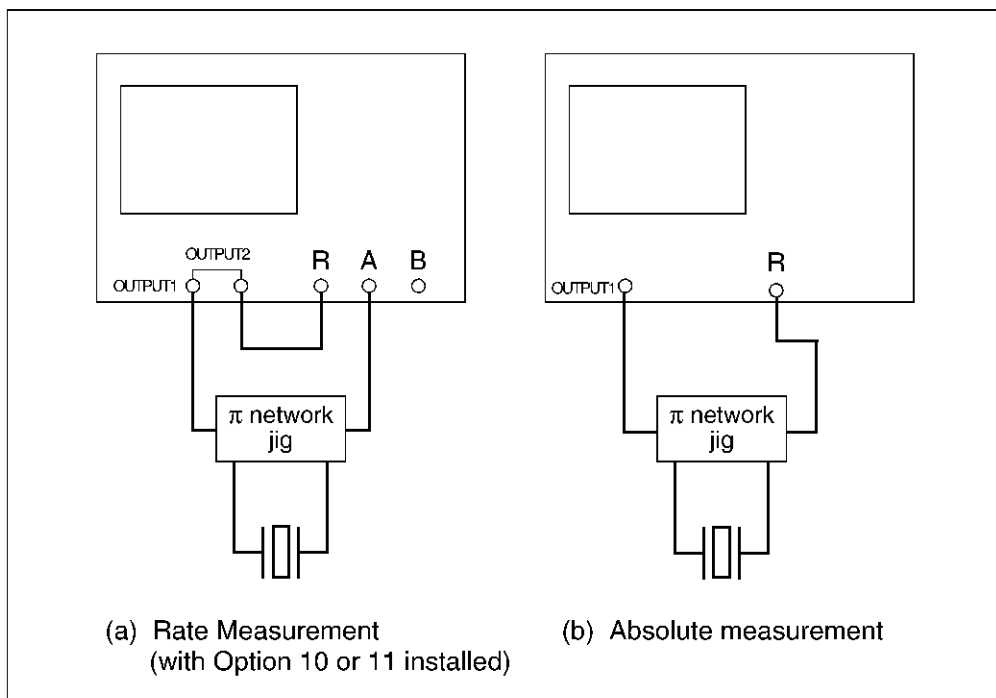

**Figure 3-35 Connection for Crystal Resonator Measurement**

- ③ Set center frequency and span.

[CENTER] → [4] → [2] → [MHz]

[SPAN] → [5] → [kHz]

- ④ The resonance point (Magnitude maximum point) is found by using the marker search function.

[MKR→] → {MKR SEARCH [ ]} → {MAX}

The display is shown in the figure below.

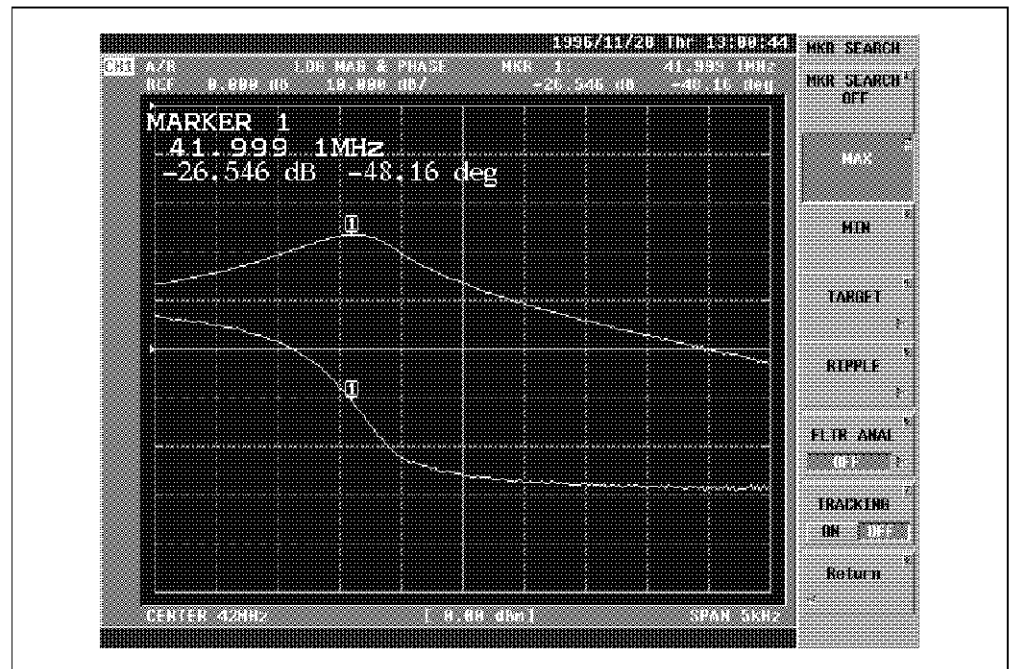

Figure 3-36 Search for Resonance Point

- ⑤ The resonance point is made a center frequency.

{Return} → {MARKER → CENTER}



3.2 Measurement Method Example

The display is shown in the figure below.

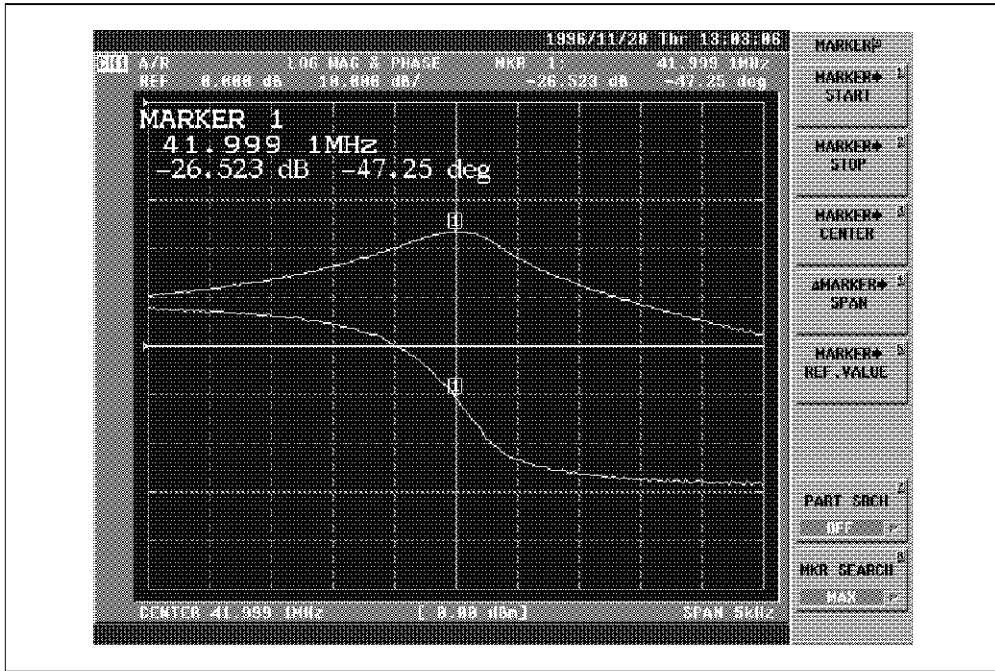

Figure 3-37 Marker Frequency → Center Frequency

- ⑥ Calibrate the frequency characteristic.  
Connect the through (Short) to the test port of the  $\pi$  network jig.

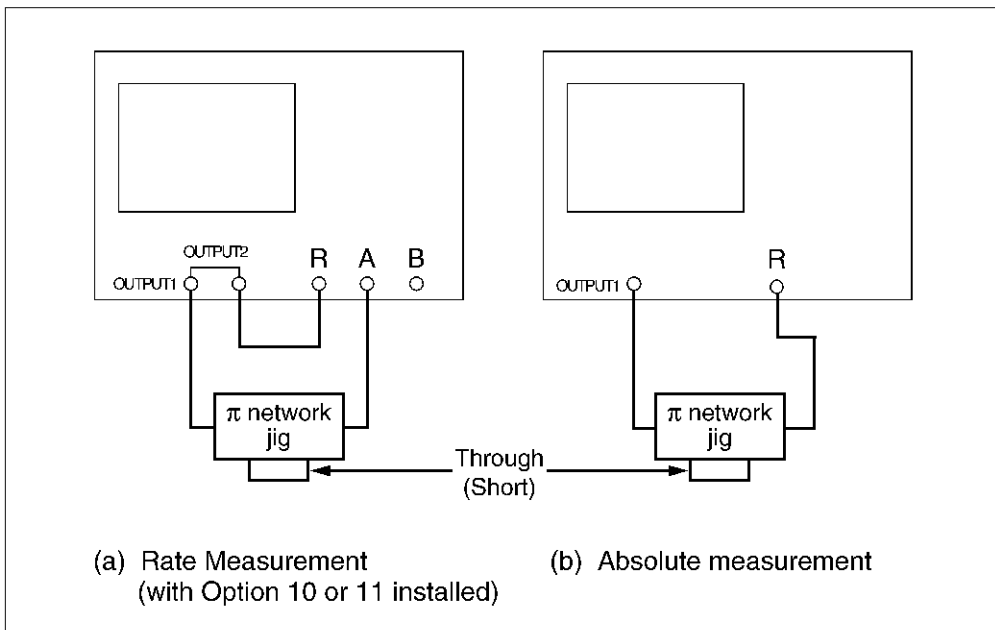

Figure 3-38 Calibration at Crystal Resonator Measurement

Normalization is done.

[CAL] → {NORMALIZE (THRU)}

The display is shown in the figure below.

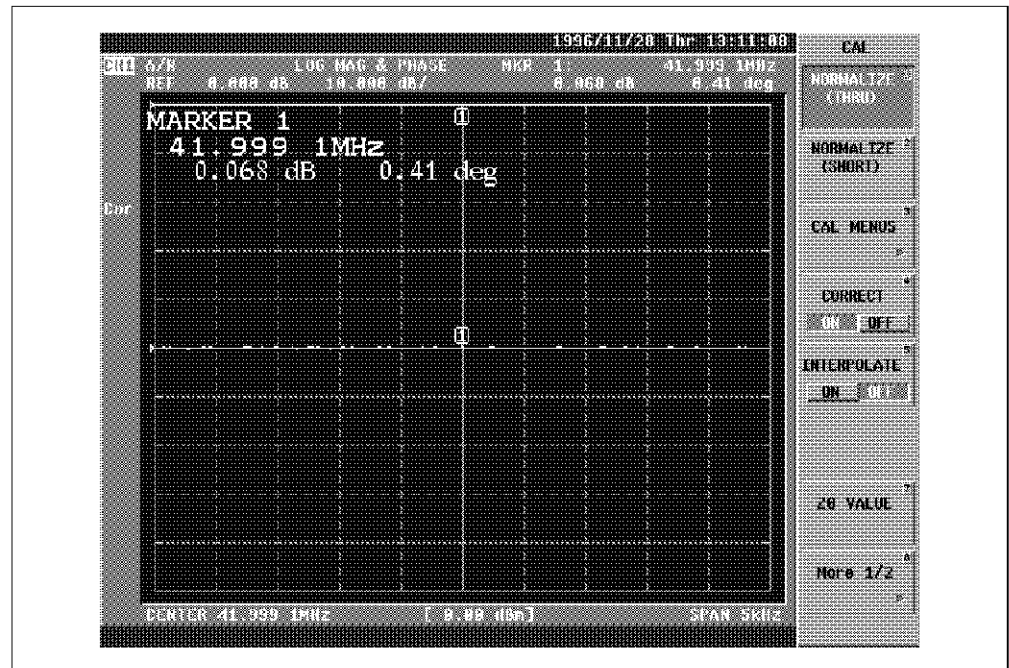

Figure 3-39 Result of Calibration

Connect crystal to the test port of the  $\pi$  network jig again.

- ⑦ Set the object of the scale change to the second trace (Phase). As a result, the operation of the marker becomes effective for the second trace.

[SCALE] → {SCALE FOR 2nd/1st}

- ⑧ The search for phase 0 is executed.

[MKR→] → {MKR SEARCH [ ]} → {TARGET} → {0°}

3.2 Measurement Method Example

The display is shown in the figure below.

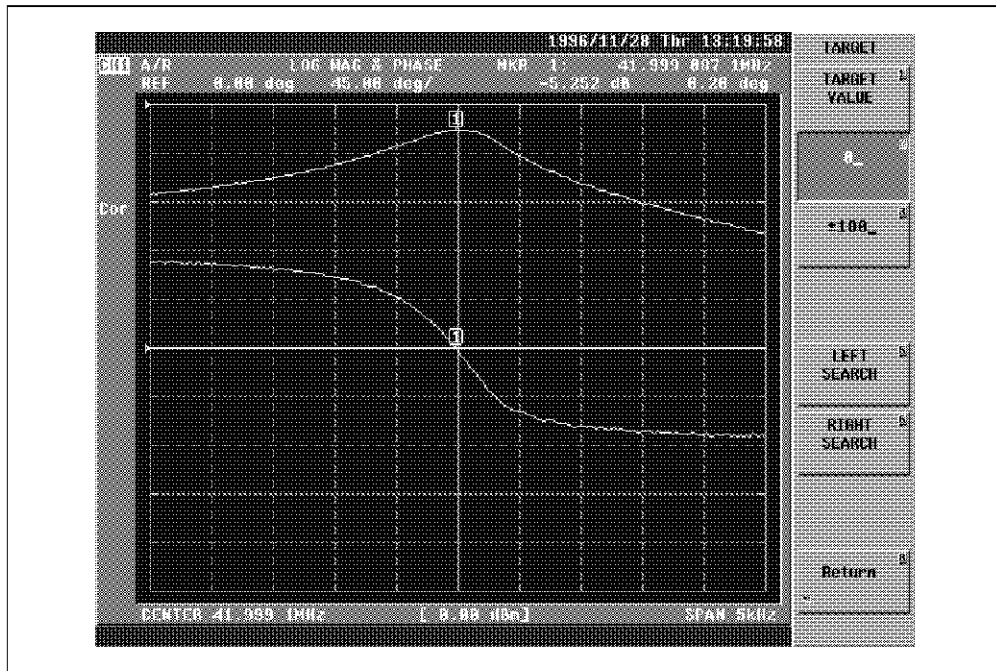

Figure 3-40 Search for Phase 0

- ⑨ The search for specified phase (45 degree) is executed.

{TARGET} → [4] → [5] → [X1]



The display is shown in the figure below.

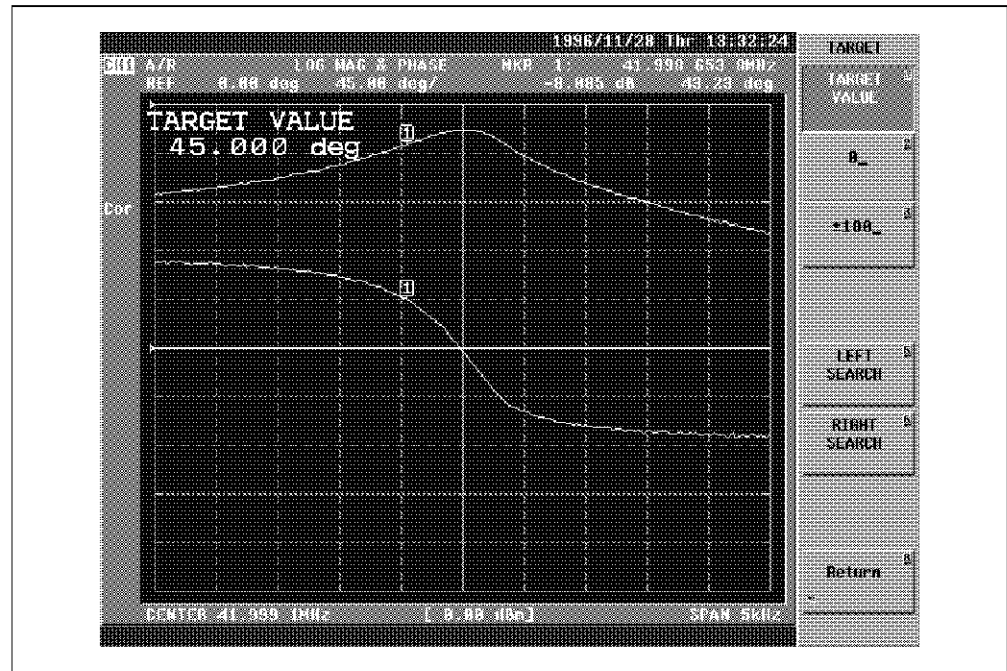

Figure 3-41 Search for Specified Phase

### 3.2.11 Multi-marker Measurement

The method of operation of multi-marker is explained here by example of band pass filter measurement of center frequency 10.7MHz.

- ① Setup (filter connection) and presetting (Refer to section 3.1.2 and Figure 3-2).
- ② Set center frequency and span.

[CENTER] → [1] → [0] → [.] → [7] → [MHz]

[SPAN] → [1] → [MHz]

- ③ Calibrate the frequency characteristic.  
Operate similarly by the item ④ of section 3.2.1 (Measurement of filter).

3.2 Measurement Method Example

- ④ Multi-marker is displayed. The marker of 10 maximums a channel can be displayed.

[MKR]

{ACTIVATE MARKER [ ]} → {MARKER 2} → [↑]

{MARKER 3} → [↑] → [↑]

{MARKER 4} → [↑] → [↑] → [↑]

{MARKER 5} → [↑] → [↑] → [↑] → [↑]

{More 1/2} → {MARKER 6} → [↓]

{MARKER 7} → [↓] → [↓]

{MARKER 8} → [↓] → [↓] → [↓]

{MARKER 9} → [↓] → [↓] → [↓] → [↓]

{MARKER 10} → [↓] → [↓] → [↓] → [↓] → [↓]

The display is shown in the figure below.

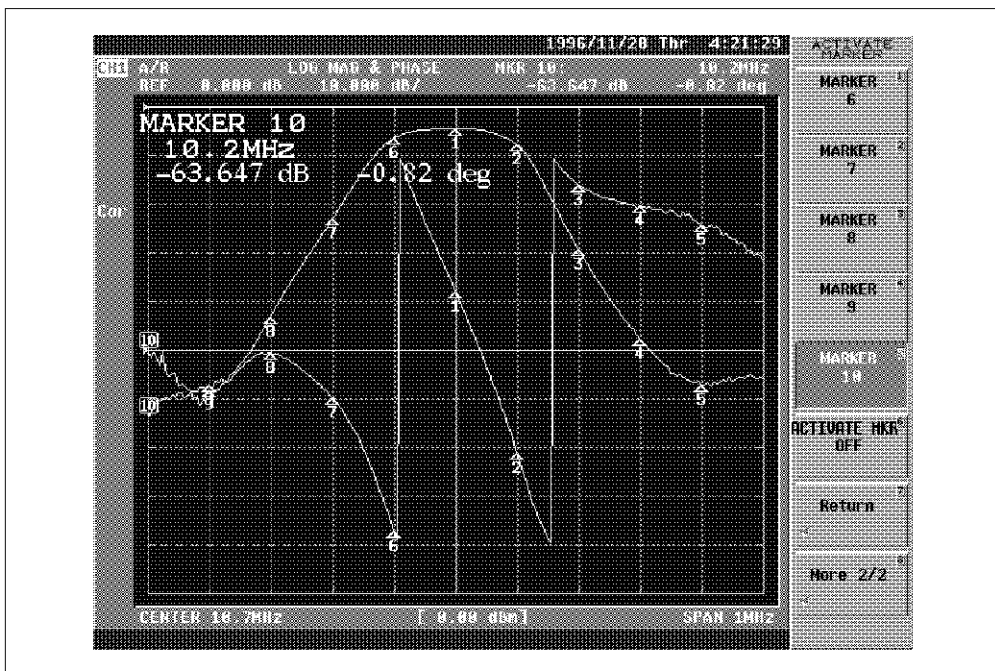

Figure 3-42 Multi-marker Display

- ⑤ The marker list is displayed to read the data of all markers.

{Return} → {MKR LIST ON/OFF}

The marker list is displayed as shown in the figure below by the above-mentioned operation.

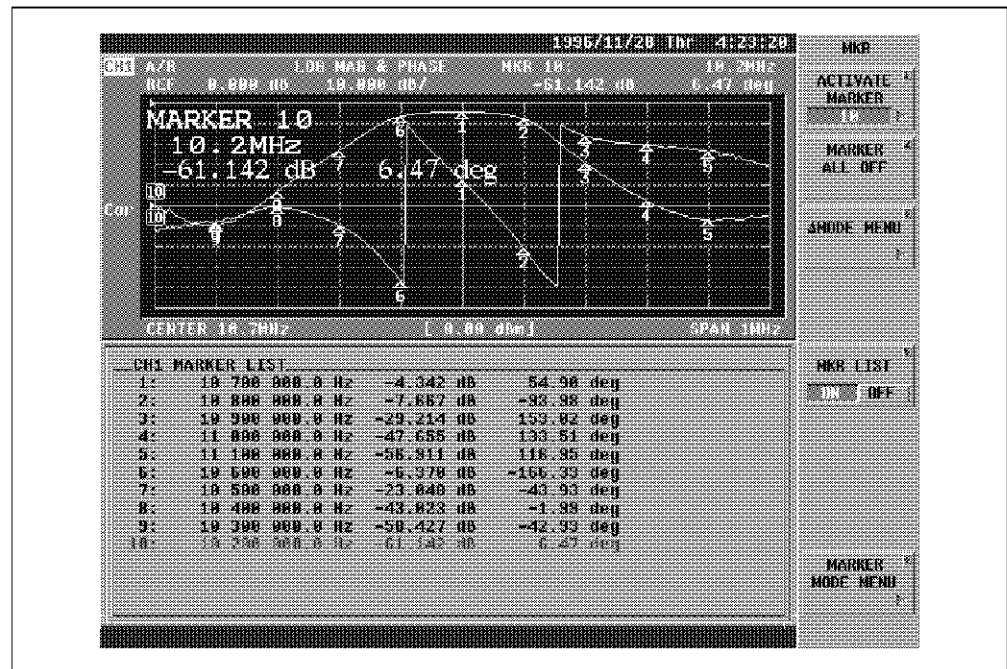

Figure 3-43 Multi-marker List

### 3.2.12 Delta Marker Measurement

The operation method for the delta marker is explained here by the example of the band pass filter of center frequency 43MHz.

- ① Setup (filter connection) and presetting (Refer to section 3.1.2 and Figure 3-2).
- ② Make the measurement format a magnitude (Logarithmic display).

{FORMAT} → {LOG MAG}

- ③ Set center frequency and span.

{CENTER} → [4] → [3] → [MHz]

{SPAN} → [1] → [0] → [MHz]

- ④ Adjust the scale of the display trace. The display becomes to see easily.

{SCALE} → {AUTO SCALE}

3.2 Measurement Method Example

- ⑤ The difference of the value between two points is measured with a reference marker.

[MKR] → [↓] → [↓] → {ΔMODE MENU} → {ΔREF = ΔMKR}

The reference marker appears at the current active marker position. The reference marker is displayed by a red \* sign. The active marker is moved.

[4] → [3] → [MHz]

The display is shown in the figure below. The difference of the value of both markers is displayed in the active marker area.

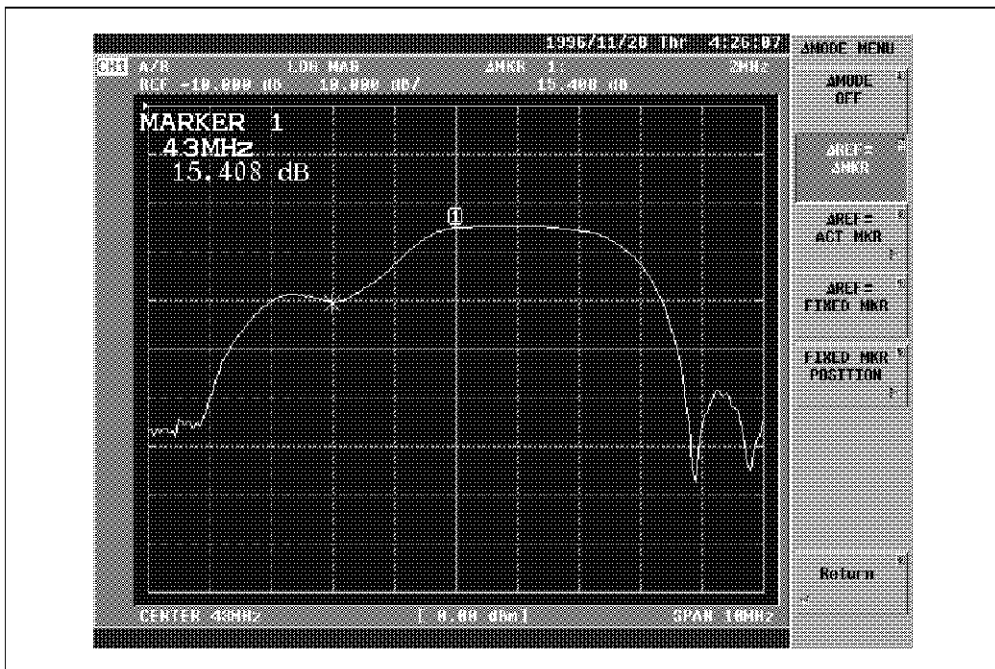

Figure 3-44 Delta Marker Display (1)

- ⑥ The difference of the value between two points is measured by using the comparison between markers.

{ΔMODE OFF} → {ΔREF = ACT MKR}

{ACTIVATE MARKER [ ]} → {MARKER 2} → [↓] → [↓] → {MARKER 1} → {Return}  
 {COMPARE MARKER 2}



The display is shown in the figure below. The difference of the value of both markers is displayed in the active marker area.

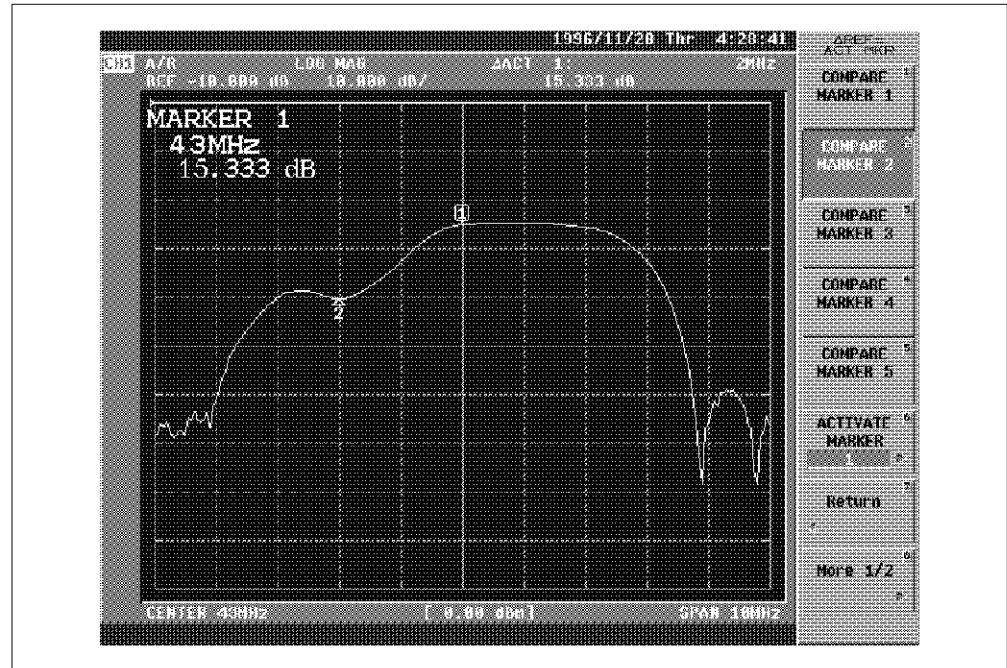

Figure 3-45 Delta Marker Display (2)

- ⑦ The difference between two points is measured with a fixed marker.

*{Return}* → *{ΔREF = FIXED MKR}*

The fixed marker appears at the center of the screen. The fixed marker is shown by a red  $\diamond$  sign. And it can be fixed to an arbitrary position without any relation to the trace. The position of the fixed marker is moved.

*{FIXED MKR POSITION}* → *{FIXED MKR VALUE}* → [-] → [1] → [0] → [X1]

The fixed marker moves to the position of -10dB of vertical axis. The display is shown in the figure below. The difference between the fixed marker value and the active marker value is displayed in the active marker area.

3.2 Measurement Method Example

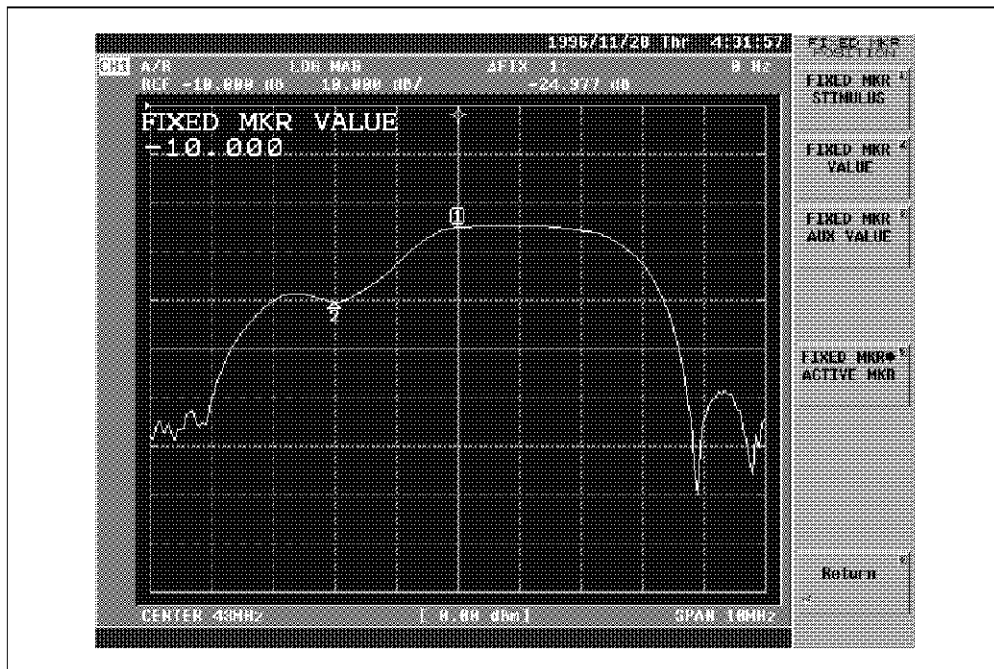

Figure 3-46 Fixed Marker Display

3.2.13 Delta Section Marker Measurement

The partial (Delta section) analysis operation method is explained here by the example of the band pass filter of center frequency 43MHz.

- ① Setup (filter connection) and presetting (Refer to section 3.1.2 and Figure 3-2).
- ② The measurement format is made a magnitude (Logarithmic display).

[FORMAT] → {LOG MAG}

- ③ Set center frequency and span.

[CENTER] → [4] → [3] → [MHz]

[SPAN] → [1] → [0] → [MHz]

- ④ Adjust the scale of the display trace. The display becomes to see easily.

[SCALE] → {AUTO SCALE}

- ⑤ The delta section is specified.

The marker 1 is moved to a suitable position with the data knob.

[MKR] 

The reference marker is set to the position of the marker 1.

{ $\Delta$ MODE MENU}  $\rightarrow$  { $\Delta$ REF= $\Delta$ MKR}

The marker 1 is moved to a suitable position again with the data knob.



The display is shown in the figure below. The area between the reference marker and the marker 1 becomes a delta section.

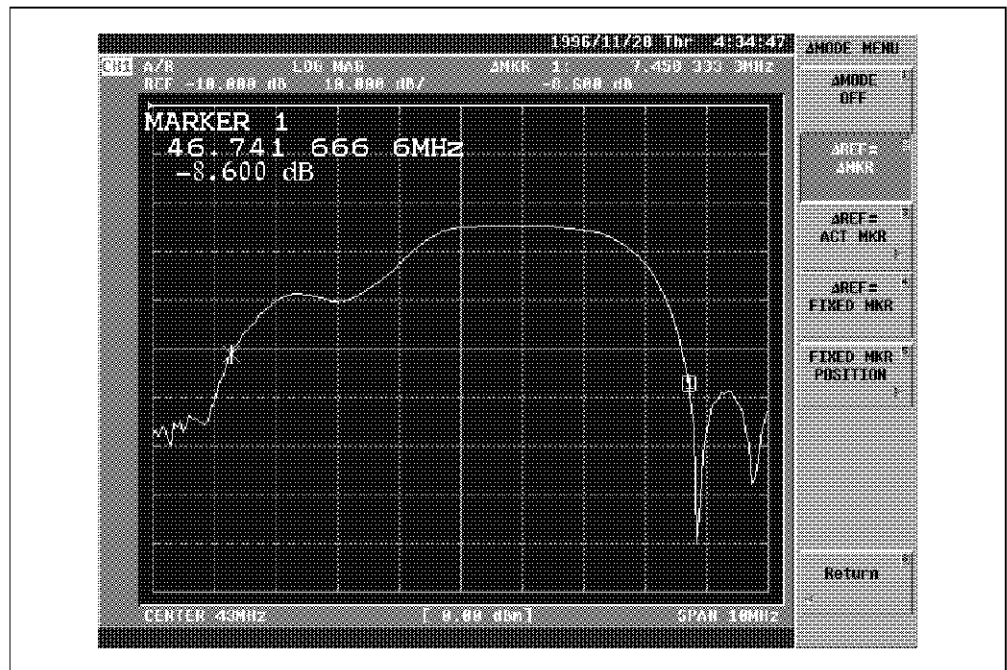

Figure 3-47 Partial Analysis (Range Specifying)

3.2 Measurement Method Example

- ⑥ The delta section is specified within the range of a partial analysis.

[MKR→] → {PART SRCH [    ]} → {SET RANGE}

- ⑦ A partial analysis is enabled.

{PART SRCH ON/OFF}

The display is shown in the figure below.

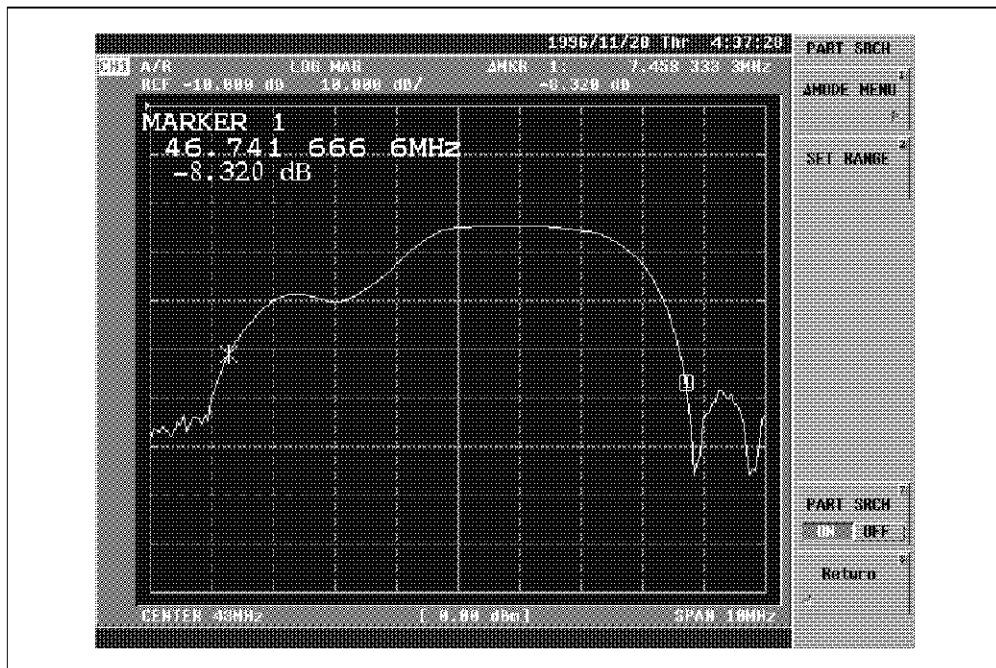

Figure 3-48 Partial Analysis (ON)



- ⑧ The maximum value in the delta section is searched.

{Return} → {MKR SRCH [    ]} → {MAX}

The display is shown in the figure below.

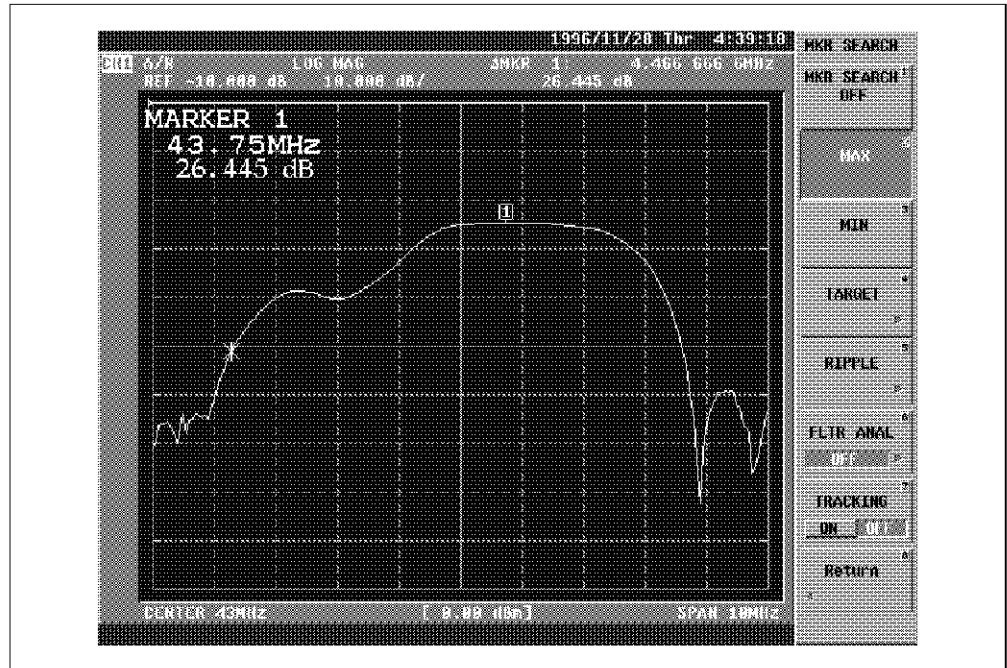

Figure 3-49 Partial Analysis (MAX Search)

- ⑨ Minimum value in the delta section is searched.

{MIN}

3.2 Measurement Example

The display is shown in the figure below.

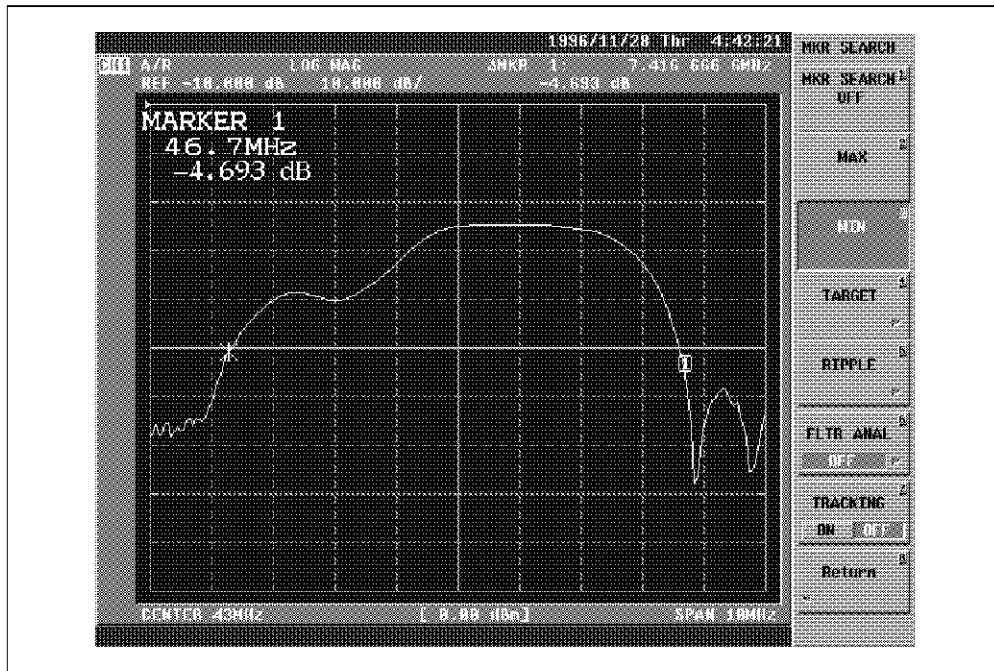

Figure 3-50 Partial Analysis (MIN Search)

- ⑩ The ripple in the delta section is searched.

$$\{RIPPLE\} \rightarrow \{\Delta MAX \cap -MIN \cup\}$$

The reference marker moves to a minimum point in the local minimum peak. And the active marker moves to the point of the maximum in the local maximum peak. The display is shown in the figure below. The difference of the value of both markers is displayed in the active marker area.

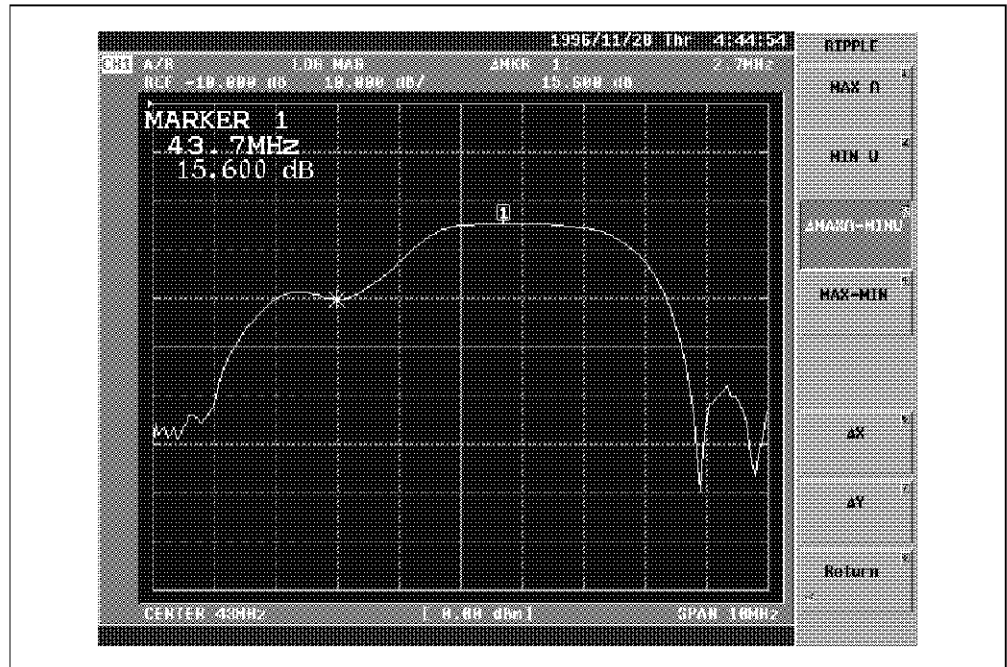

Figure 3-51 Partial Analysis (Ripple Search)

### 3.2.14 Marker Analysis Measurement

The method of operation of the marker → is explained here by the example the band pass filter measurement of center frequency 43MHz .

- ① Setup (filter connection) and presetting (Refer to section 3.1.2 and Figure 3-2).
- ② Set center frequency and span.

[CENTER] → [4] → [3] → [MHz]

[SPAN] → [1] → [0] → [MHz]

- ③ The magnitude maximum point is searched by displaying the marker.

[MKR →]

{MKR SEARCH [ ]} → {MAX}

3.2 Measurement Example

The display is shown in the figure below by the above-mentioned operation.

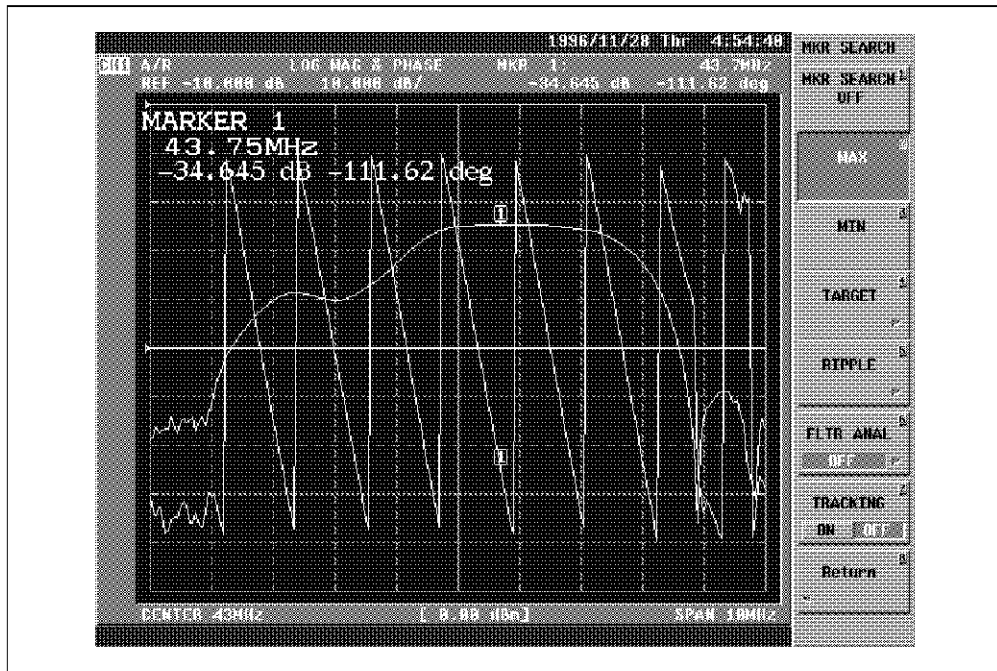

Figure 3-52 Marker Search (MAX)

- ④ The center frequency is set to the marker value by the marker →.

{Return}

{MARKER → CENTER}

The display is shown in the figure below by the above-mentioned operation.

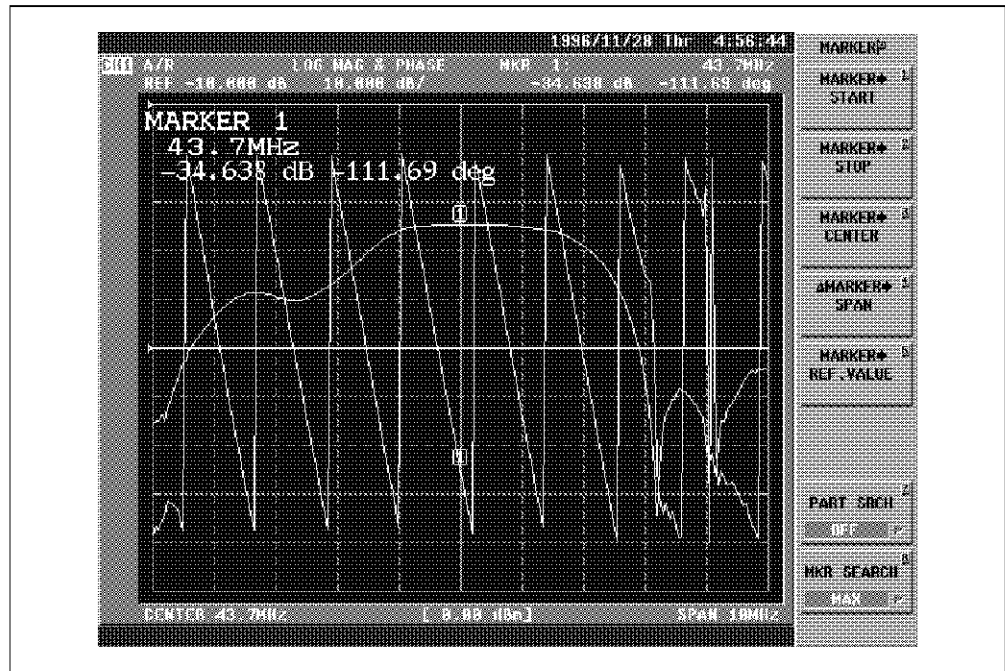

Figure 3-53 Marker → Center Frequency

- ⑤ Span is expanded by the marker →. From 40MHz to 46MHz is displayed here.

[4] → [0] → [MHz] : The active marker is moved to 40MHz.

[MKR] → {ΔMODE MENU} → {ΔREF = ΔMKR}

[4] → [6] → [MHz] : The active marker is moved to 46MHz.

[MKR →] → {ΔMARKER → SPAN}

The display is shown in the figure below by the above-mentioned operation.



3.2 Measurement Example

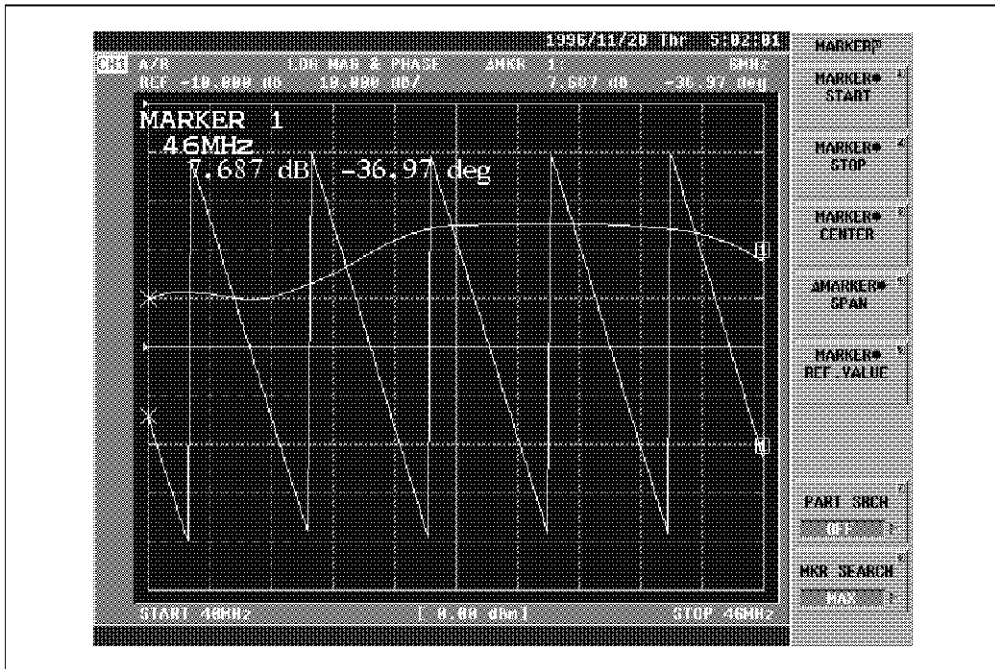

Figure 3-54 Delta Marker → Span

The section specified with the delta marker is displayed.

3.2.15 Marker Coupling and Interpolation Measurements

This section explains how to use the Interpolation Marker and Marker coupling, showing the measurement of the band-pass filter of which the center frequency is 43MHz.

- ① Setup (filter connection) and presetting (Refer to section 3.1.2 and Figure 3-2).
- ② Set center frequency and span.

[CENTER] → [4] → [3] → [MHz]

[SPAN] → [1] → [0] → [MHz]

- ③ Make the format of the channel 1 a magnitude (Logarithmic display).

[FORMAT] → {LOG MAG}

- ④ Set the active channel to the channel 2. Make the format of the channel 2 a phase.

[CH2]

{PHASE}

- ⑤ The active channel is returned to the channel 1. And both channels are displayed simultaneously.

[CH1]

[DISPLAY] → {DUAL CH ON/OFF} → {SPLIT CH ON/OFF}

- ⑥ The marker is displayed and moved to 42.125MHz.

[MKR] → [4] → [2] → [.] → [1] → [2] → [5] → [MHz]

- ⑦ The marker mode menu is displayed.

{MARKER MODE MENU}

The display is shown in the figure below by the above-mentioned operation.

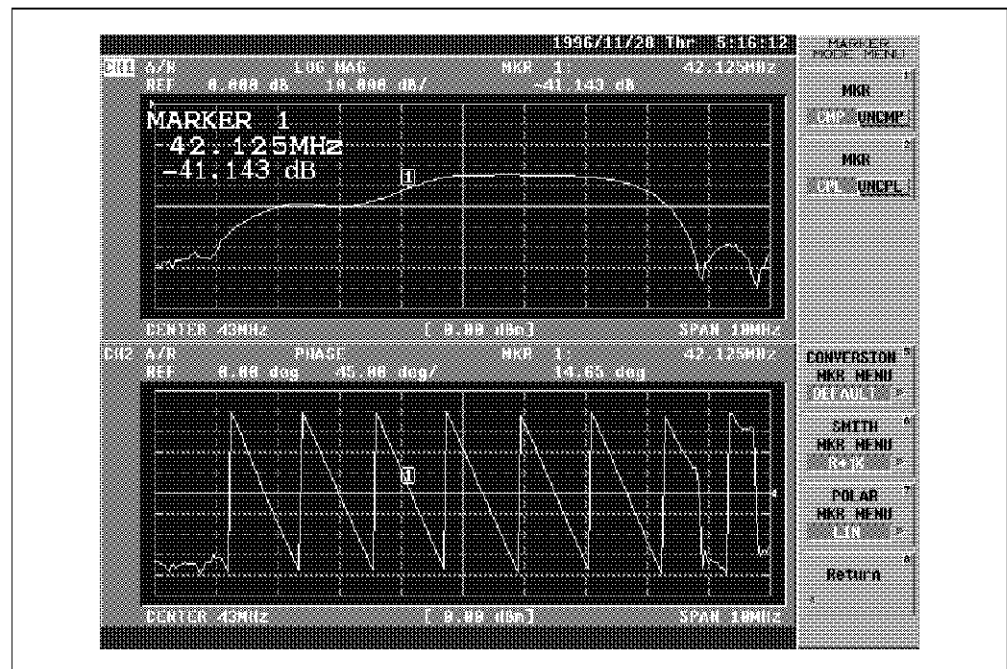

Figure 3-55 Marker Compensation

MKR CMP (Marker compensation mode) is selected. Therefore, the marker is interpolated. As a result, the value not on the measurement point is displayed by using the value on interpolation point.

Moreover, because MKR CPL (Marker coupling mode) is selected when the marker of the channel 1 moves, the marker of the channel 2 will move according to it.

3.2 Measurement Example

- ⑧ Setting MKR UNCMP (Marker un-compensation mode). Move the marker to 42.125MHz.

{MKR CMP/UNCMP}

[4] → [2] → [.] → [1] → [2] → [5] → [MHz]

The display is shown in the figure below by the above-mentioned operation.

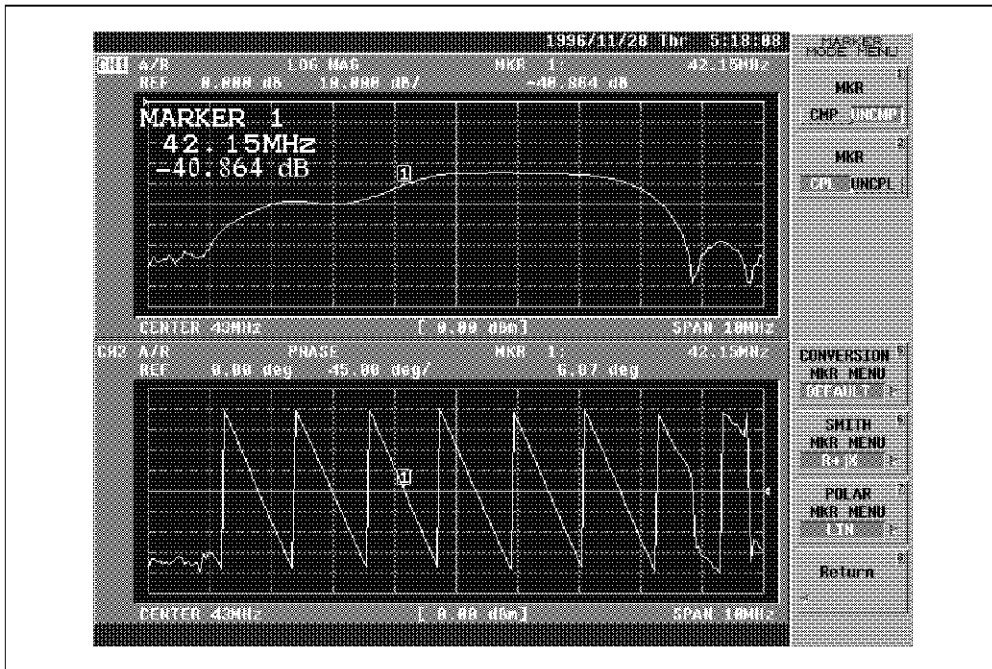

Figure 3-56 Marker Un-compensation

When MKR UNCMP (Marker un-compensation mode) is selected, the marker moves to 42.15MHz with the actually measured point because the marker will not be interpolated.



- ⑨ Set it in MKR UNCPL (Markers uncouple mode). Move the marker.

{MKR CPL/UNCPL}



The display is shown in the figure below by the above-mentioned operation.

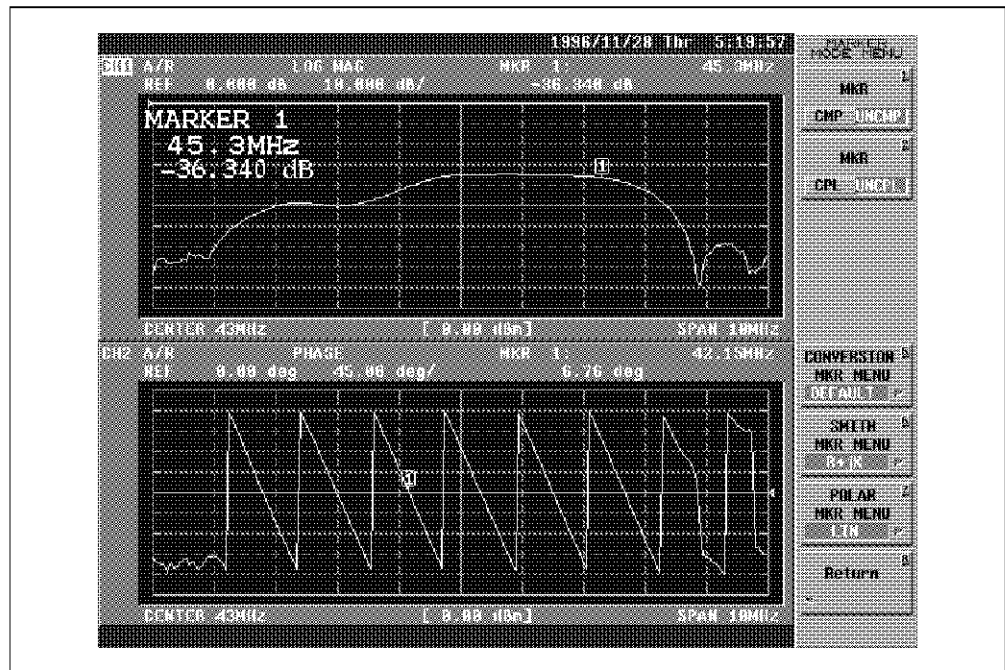

Figure 3-57 Markers Uncouple

MKR UNCPL (Markers uncouple mode) is selected. Therefore the coupling of the marker is not done, and the marker on each channel moves independently.

### 3.2.16 Program Sweep Measurement

The program sweep method of operation is explained here by the example of the band pass filter measurement of center frequency 21.4MHz.

- ① Setup (filter connection) and presetting (Refer to section 3.1.2 and Figure 3-2).
- ② The measurement format is made a magnitude (Logarithmic display).

[FORMAT] → {LOG MAG}

3.2 Measurement Example

- ③ Set center frequency and span.

[CENTER] → [2] → [1] → [.] → [4] → [MHz]

[SPAN] → [1] → [0] → [0] → [MHz]

- ④ Set the scale (Display coordinates). Set the value of the reference to -20dBm here.

[SCALE] → {REF VALUE} → [-] → [2] → [0] → [X1]

The display is shown in the figure below by the above-mentioned operation.

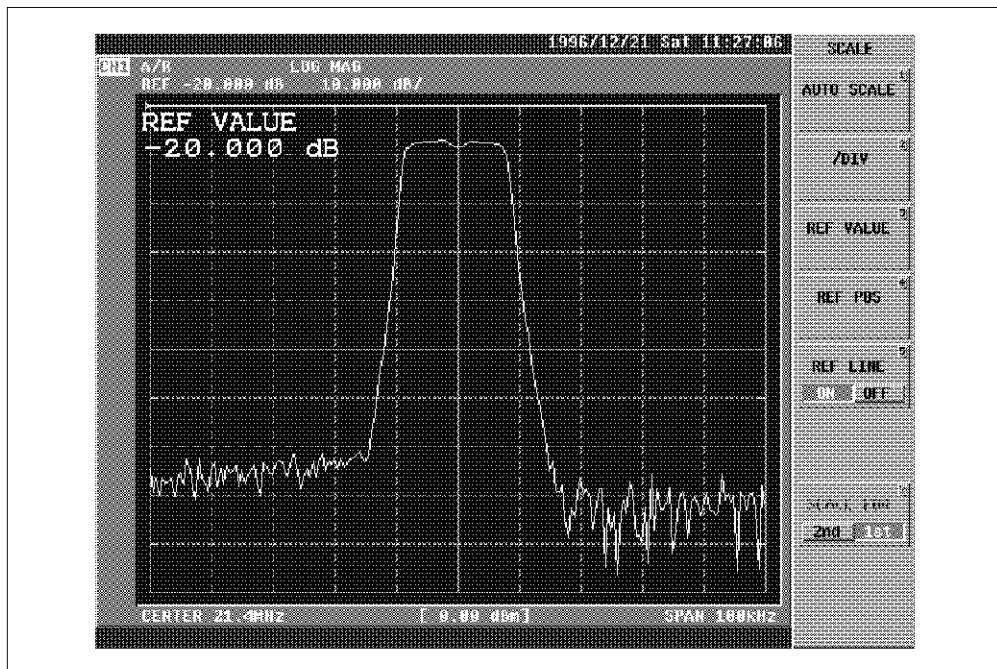

Figure 3-58 Before Program Sweep Measurement

Next, specific frequency range of this filter is expanded and is measured by using the program sweep.

Three parts of 21.360MHz to 21.390MHz, 21.392MHz to 21.408MHz, 21.410MHz to 21.440MHz are expanded and are measured here.

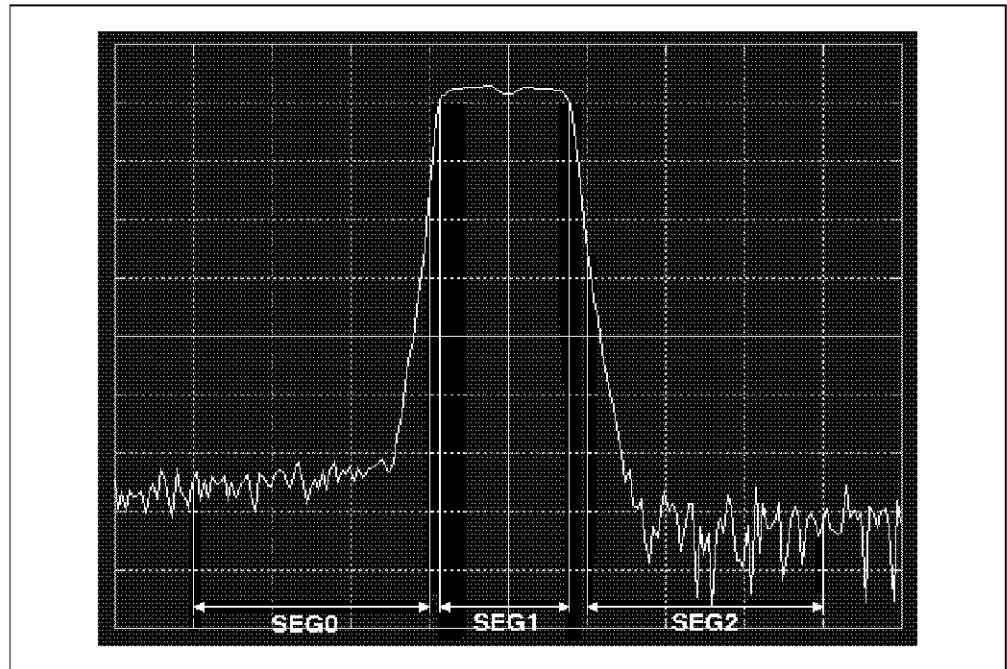

Figure 3-59 Segment Specification

- ⑤ Each set value of the program sweep is edited. The data is set here in the three segments of 0, 1 and 2 separately.

```

[MENU] → {SWEEP TYPE [  ]} → {EDIT PROG SWEEP}
{SEGMENT NUMBER} → [0] → [X1]
{START} → [2] → [1] → [.] → [3] → [6] → [0] → [MHz]
{STOP} → [2] → [1] → [.] → [3] → [9] → [0] → [MHz]
{POINT} → [2] → [0] → [0] → [X1]
{SEGMENT NUMBER} → [1] → [X1]
{START} → [2] → [1] → [.] → [3] → [9] → [2] → [MHz]
{STOP} → [2] → [1] → [.] → [4] → [0] → [8] → [MHz]
{POINT} → [2] → [0] → [0] → [X1]
{SEGMENT NUMBER} → [2] → [X1]
{START} → [2] → [1] → [.] → [4] → [1] → [0] → [MHz]
{STOP} → [2] → [1] → [.] → [4] → [4] → [0] → [MHz]
{POINT} → [2] → [0] → [0] → [X1]

```

3.2 Measurement Example

- ⑥ Set the sweep type to the program sweep.

{Return} → {PROGRAM SWEEP}

The display is shown in the figure below by the above-mentioned operation.

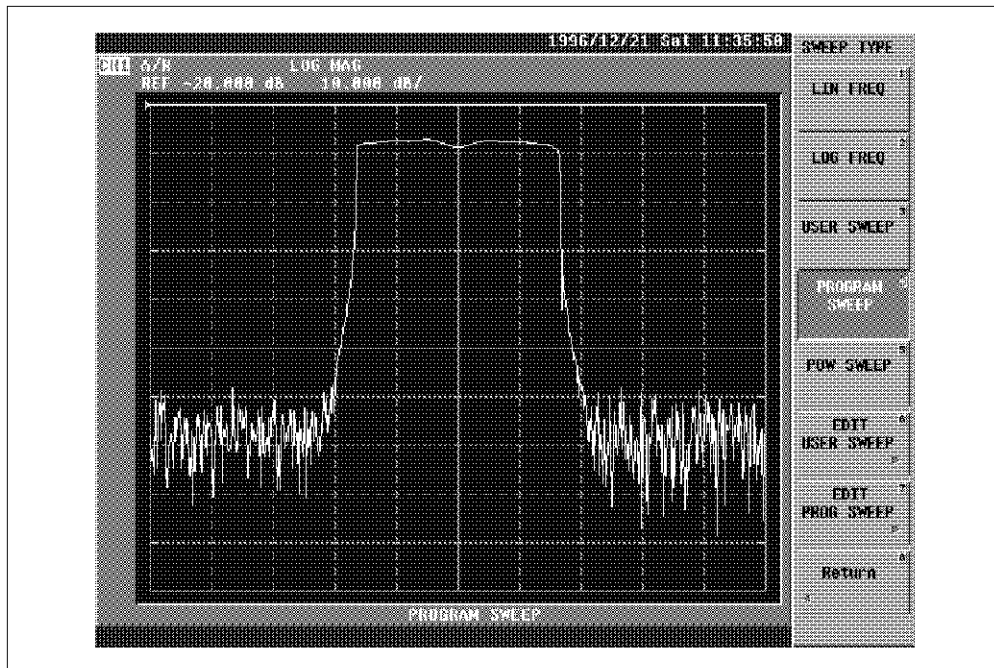

Figure 3-60 Program Sweep

- ⑦ Output level and resolution bandwidth of segment 0 are changed.

{EDIT PROG SWEEP}

{SEGMENT NUMBER} → [0] → [X1]

{More 1/2}

{SEGMENT POWER} → [5] → [.] → [0] → [X1]

{IF RBW [ ]} → [1] → [kHz]

{Return}

{PROGRAM SWEEP}



The display is shown in the figure below by the above-mentioned operation.

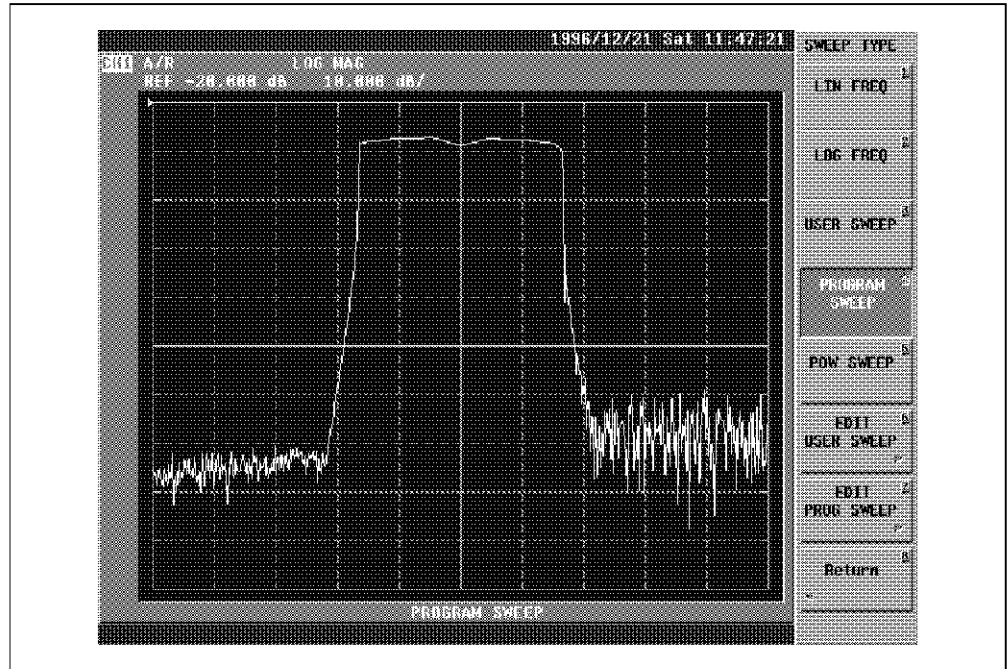

Figure 3-61 Condition Changing of Specified Segment

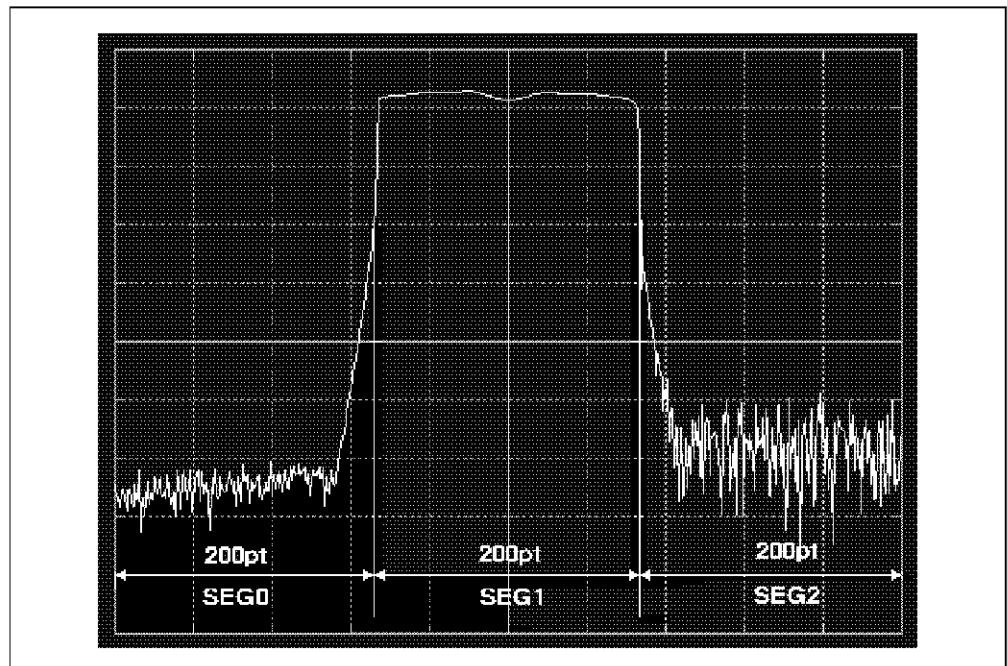

Figure 3-62 Point Number of Segment

3.2 Measurement Example

The data of each segment is edited and shows the result in the following.

SEG	START	STOP	POWER	IF RBW	POINT
0	21.360MHz	21.390MHz	5.0dBm	1kHz	200
1	21.392MHz	21.408MHz	0.0dBm	10kHz	200
2	21.410MHz	21.440MHz	0.0dBm	10kHz	200

**3.2.17 Ceramic Oscillator Resonance and Antiresonance Point Measurements**

The resonance point and antiresonance point of ceramic oscillator (f=42.0MHz) are measured here by the transmission measurement.

- ① Setup ( $\pi$  network jig connection).  
The PIC-001  $\pi$  network jig is used.
- ② Connect crystal to the test port of the  $\pi$  network jig.

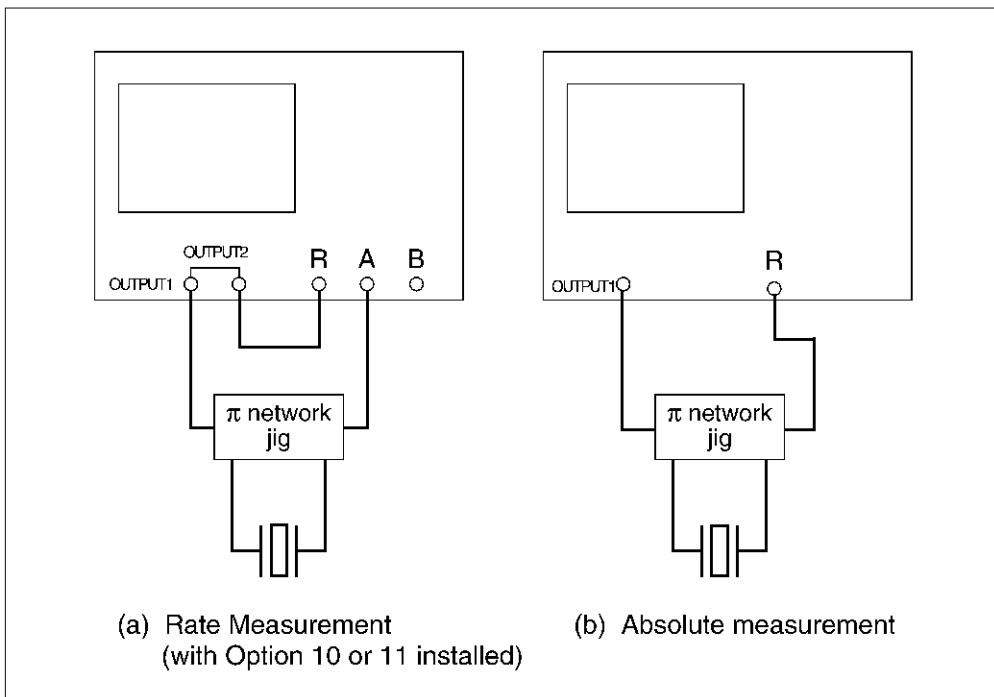

**Figure 3-63 Connection for Ceramic Oscillator Resonance Measurement**

- ③ Set center frequency and span.  
[CENTER] → [4] → [2] → [MHz]  
[SPAN] → [2] → [0] → [kHz]

- ④ Set resolution bandwidth. At this time, sweep time is automatically set.

[AVG] → {IF RBW [ ]} → [1] → [kHz]

- ⑤ Calibrate frequency characteristic.

Connect the through (Short) to the test port of the  $\pi$  network jig.

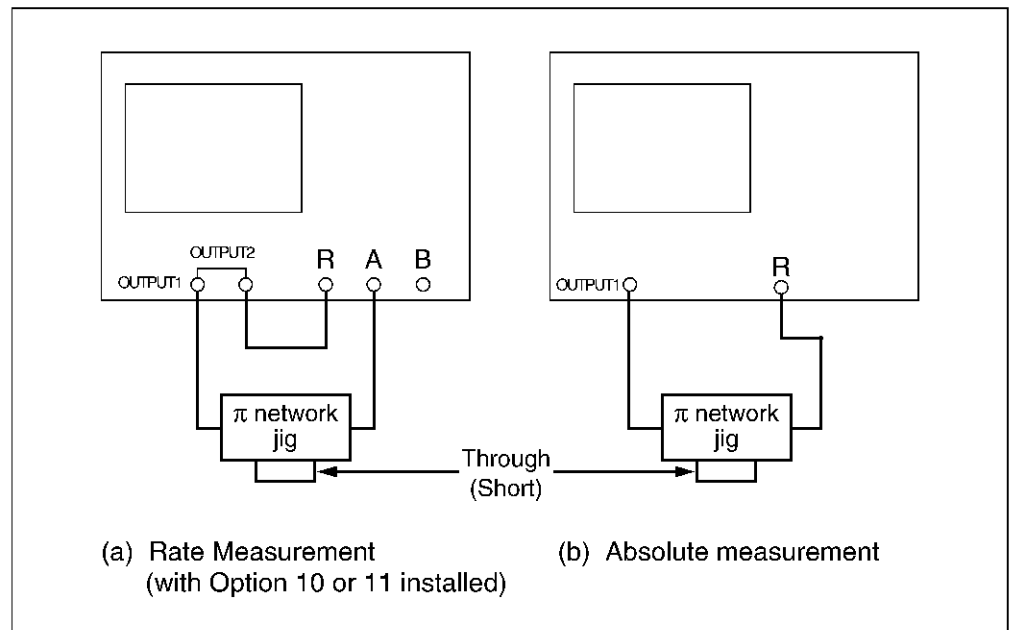

Figure 3-64 Calibration at Ceramic Oscillator Resonance Measurement

[CAL] → {NORMALIZE (THRU)}

After ending, return it to the connection of ①.

- ⑥ Set the characteristic impedance of the  $\pi$  network jig. The characteristic impedance of the device used is  $12.5\Omega$  at this time. Set this value.

[MEAS] → {CONVERSION [OFF]} → {Z0 VALUE} → [1] → [2] → [.] → [5] → [X1]

- ⑦ Select the impedance conversion by the transmission measurement.

{Z (TRANS)}

- ⑧ Adjust the scale of the display trace (Logarithmic magnitude). The display becomes to see easily.

[SCALE] → {AUTO SCALE}

3.2 Measurement Example

- ⑨ The marker is displayed to read the measured value directly. The marker data display modes are changed.

[MKR] → {MKR MODE MENU}

{CONVERSION MKR MENU [ ]} → {LIN MKR}

Display screen is shown in the figure below by the above-mentioned operation.

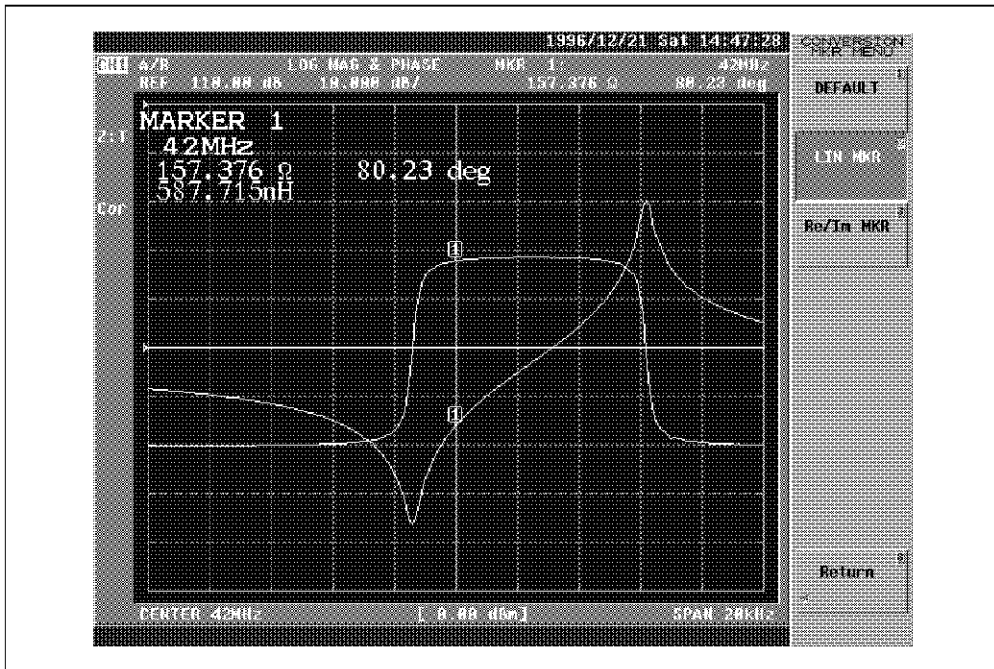

Figure 3-65 Impedance Display

Thus, when the impedance conversion is selected, impedance and the phase can be read directly by using the marker.

- ⑩ The search for the phase 0° is executed to search the resonance point.

[MKR →] → {MKR SEARCH [ ]}

{TARGET} → {0°}

- ⑪ Display of marker 2. The search for the phase 0° is executed to search antiresonance point.

[MKR] → {Return} → {Return}

{ACTIVATE MARKER [ ]} → {MARKER 2}

[MKR →] → {0°} → {RIGHT SEARCH}



- ⑫ The marker list is displayed to read the values of both marker directly at the same time.

[MKR] → {Return} → {MKR LIST ON/OFF}

The display is shown in the figure below by the above-mentioned operation.

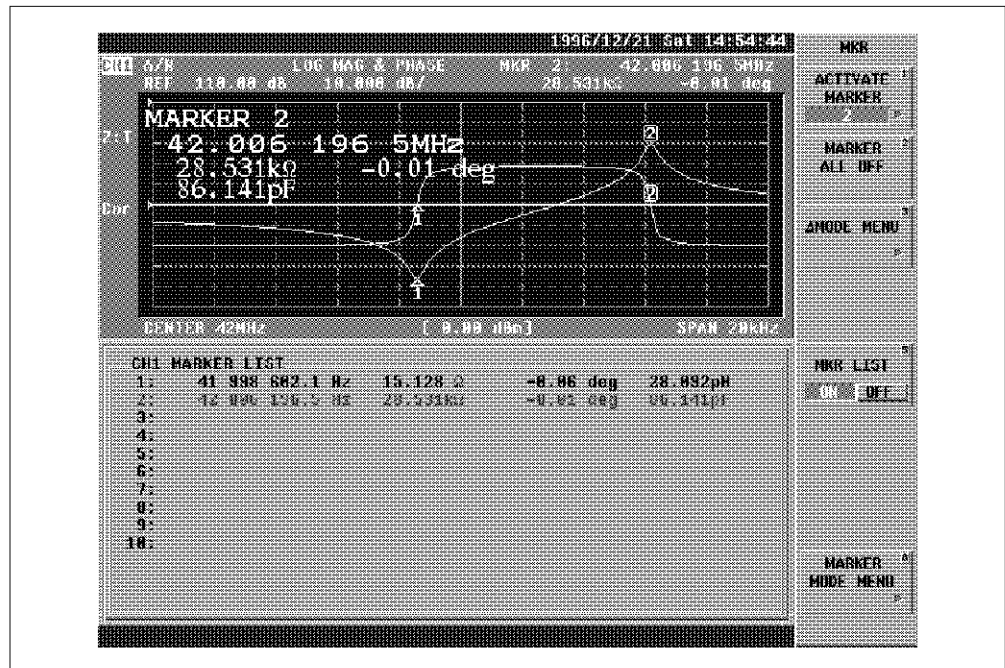

Figure 3-66 Marker List (1)

- ⑬ Admittance conversion by the transmission measurement is selected.

[MEAS] → {Y (TRANS)}

- ⑭ Adjust the scale of the display trace (Logarithmic magnitude). The display becomes to see easily.

[SCALE] → {AUTO SCALE}

- ⑮ Specify the marker 1 for the active marker. The search for the phase 0° is executed to search the resonance point.

[MKR] → {ACTIVATE MARKER [ 1 ]} → {MARKER 1}

[MKR →] → {0°}

3.2 Measurement Example

- ⑩ Specify the marker 2 for the active marker. The search for the phase  $0^\circ$  is executed to search antiresonance point.

[MKR] → {MARKER 2}

[MKR →] → {0°} → {RIGHT SEARCH}

Display screen is shown in the figure below by the above-mentioned operation.

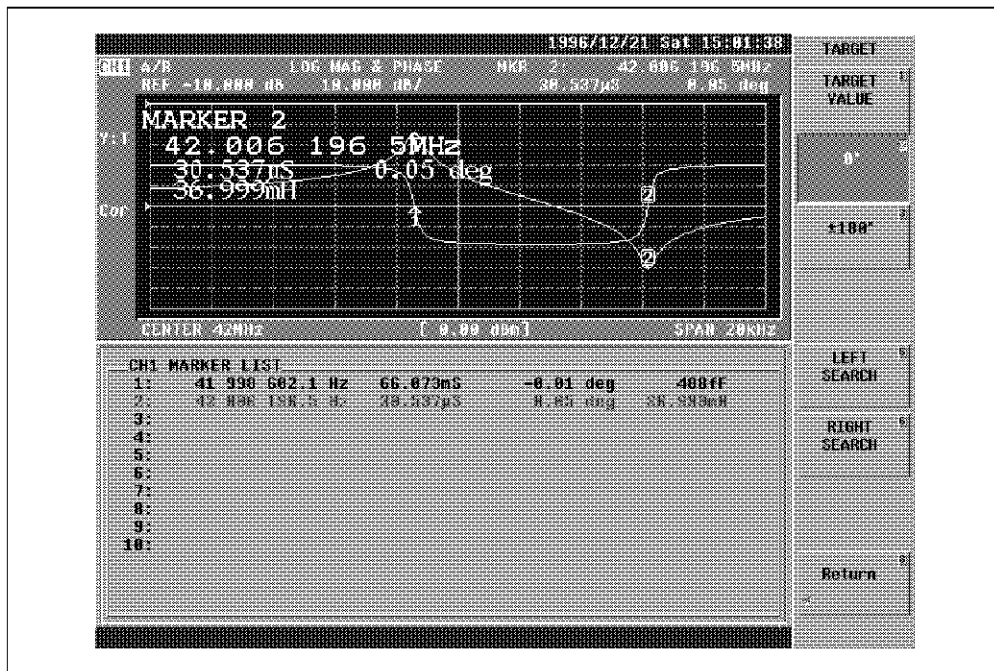

Figure 3-67 Marker List (2)

3.2.18 Measured Data Plotter Output

The output method to the plotter of measured data is explained here by the example the band pass filter measurement of 38.5MHz.

The plotter assumes HP mode and the address to be set 5.

- ① Setup (filter connection) and presetting (Refer to section 3.1.2 and Figure 3-2).
- ② The measurement format is made a magnitude (Logarithmic display).

[FORMAT] → {LOG MAG}

- ③ Set center frequency and span.

[CENTER] → [3] → [8] → [.] → [5] → [MHz]

[SPAN] → [2] → [0] → [MHz]

- ④ Adjust the scale of the display trace. The display becomes to see easily.

[SCALE] → {AUTO SCALE}

- ⑤ The marker is displayed and moved to the measurement point.

[MKR] 

- ⑥ R3754 Series is set to the system controller to use the plotter.

[LCL] → {SYSTEM CONTROLLER}

- ⑦ The GPIB address of the plotter is set.

{SET ADDRESS} → {ADDRESS PLOTTER} → [5] → [X1]

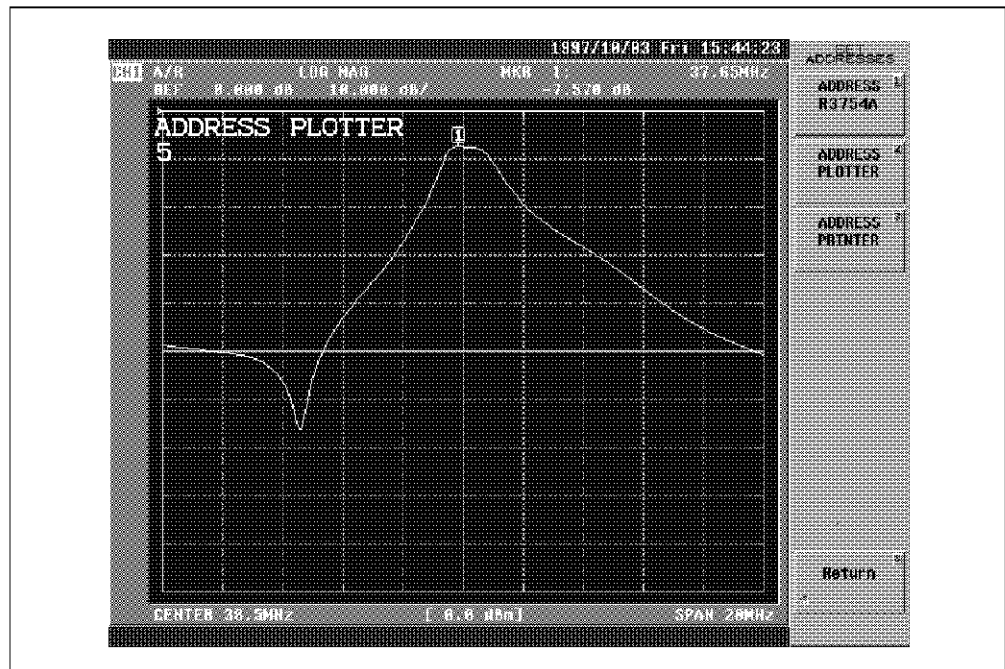

Figure 3-68 Output to Plotter (Measurement Result)

- ⑧ The plotter mode is selected.

According to the mode setting of plotter, plotter mode HP is selected.

[COPY] → {PRINT/PLOT SETUPS}

{DEFAULT SETUPS}

{PLOTTER HP/AT} (HP is selected)

{Return}

3.2 Measurement Example

- ⑨ The data output to the plotter is selected. Measured data, the coordinates data, the text data, the marker data and the reference data are made to set it of the output here. The memory data is made to set it of no output. Initial value is all "ON" (Output it). Only the memory data is made "OFF" (Do not output it).

{DEFINE PLOT}

{PLOT MEMORY ON/OFF} This is turned off.

The display is shown in the figure below by the above-mentioned operation.

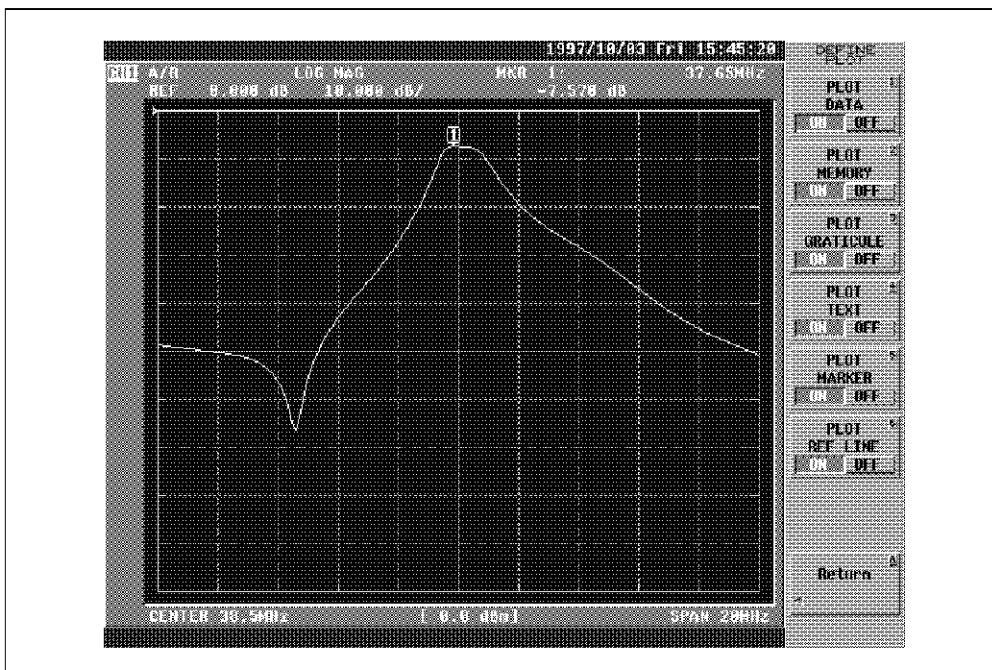

Figure 3-69 Setting of Output to Plotter

- ⑩ The output is started to the plotter.

{Return} → {PLOT}



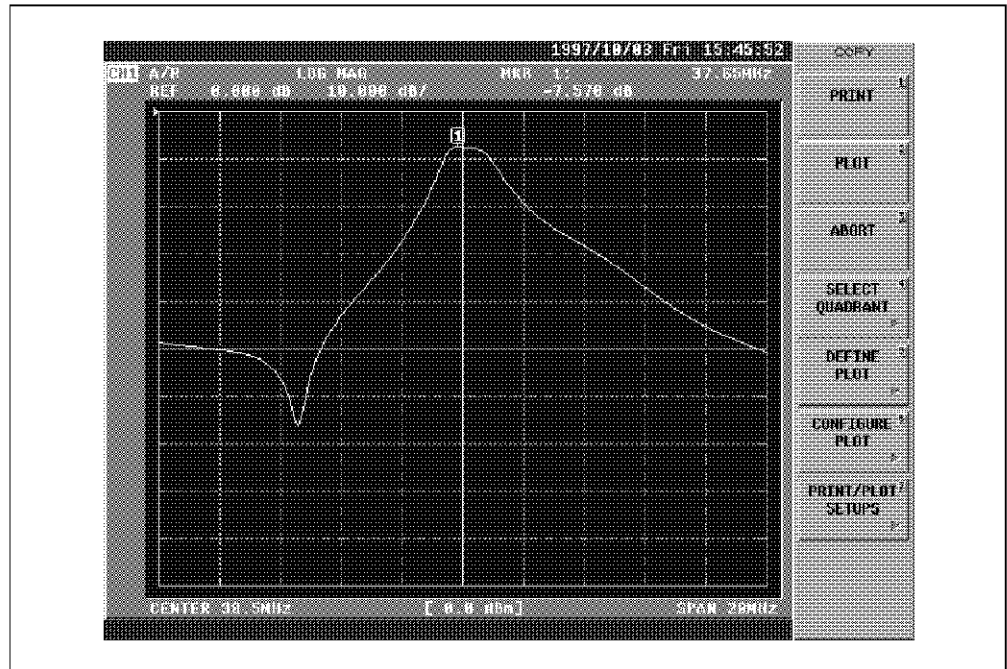

Figure 3-70 Output to Plotter

The output copy of the plotter is shown in the figure below.

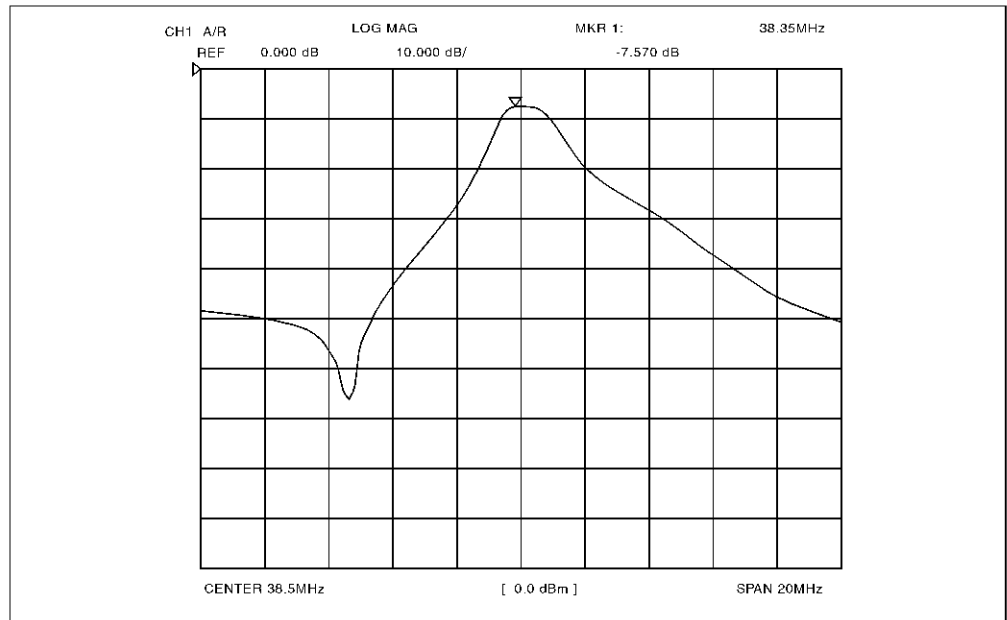

Figure 3-71 Example Plot

**Note:** When plotter of HP company is used, the error such as lighting the error lamp will be occasionally displayed even though plotting it normally.

---

3.2 Measurement Example

### 3.2.19 Using the Save/Recall Register

The method of operation of the storage and reproducing the set value of measurement is explained here in the saving/the recall register by the example the band pass filter measurement of 10.7MHz.

- ① Setup (filter connection) and presetting (Refer to section 3.1.2 and Figure 3-2).

- ② Set center frequency and span.

**[CENTER]** → [1] → [0] → [.] → [7] → [MHz]

**[SPAN]** → [1] → [MHz]

- ③ Make the measurement format a magnitude (Logarithmic display).

**[FORMAT]** → {LOG MAG}

- ④ Select the channel 2. Change the format.

**[CH2]**

**[FORMAT]** → {PHASE}

- ⑤ Dual-channel is simultaneously displayed.

**[DISPLAY]** → {DUAL CH ON/OFF} → {SPLIT CH ON/OFF}

- ⑥ The marker is displayed.

**[MKR]** 

- ⑦ The above-mentioned setting is saved with the saving register.

**[SAVE]** → {SAVE REGISTER} → {SAVE REG-1}

The display is shown in the figure below by the above-mentioned operation.

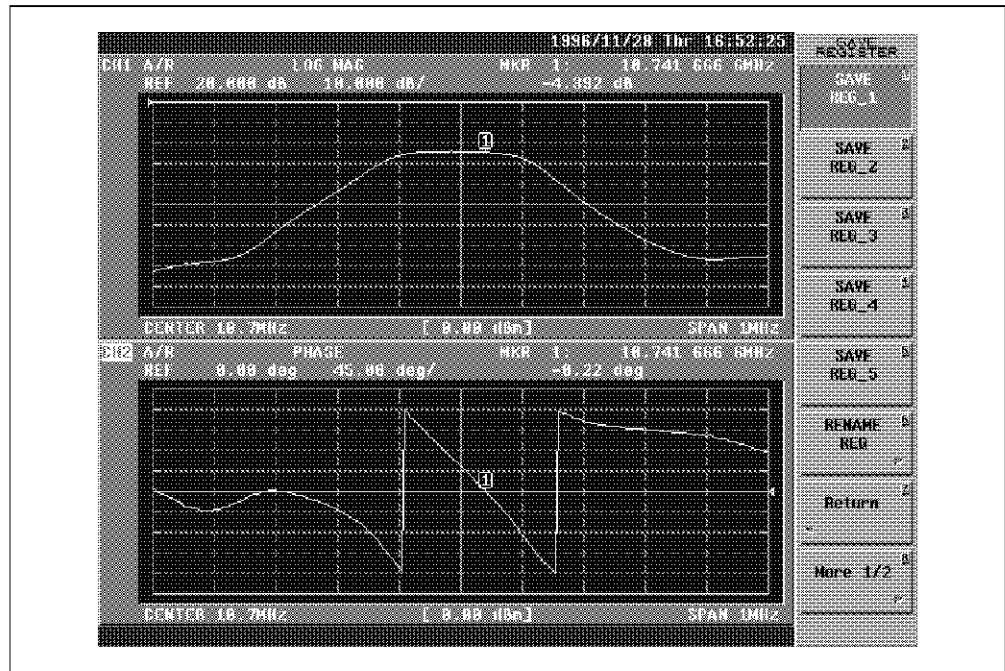

Figure 3-72 Save Register

Set value storage is completed by the above-mentioned operation. Next, the saved set value is reproduced.

- ⑧ Presetting is executed. And setting is initialized.

[PRESET]

- ⑨ The set value is reproduced by the recall register.

[RECALL] → {RECALL REG-1}

3.2 Measurement Example

The display is shown in the figure below by the above-mentioned operation.

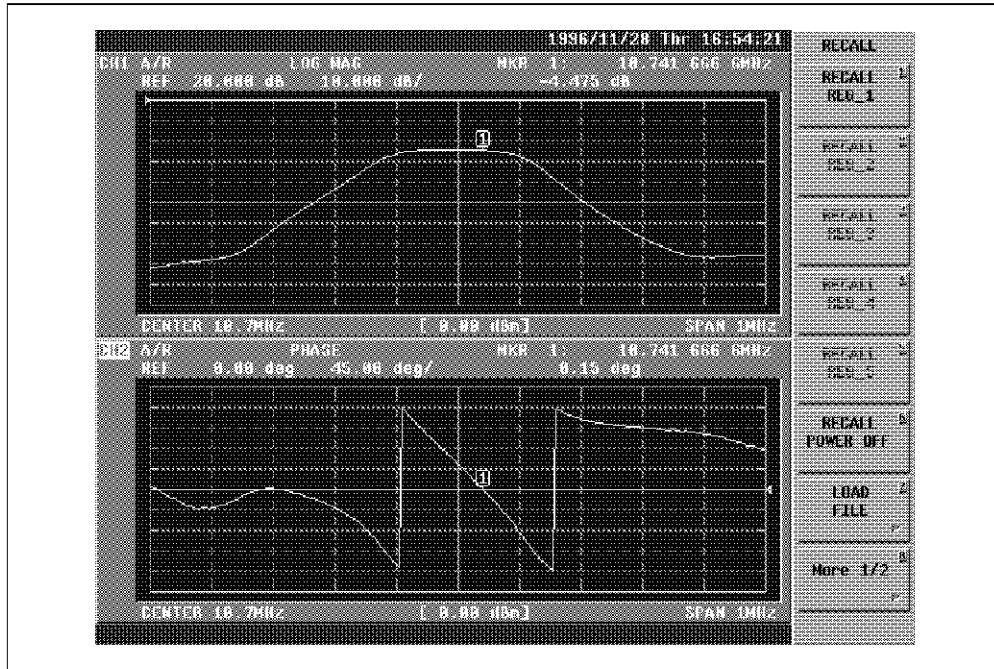

Figure 3-73 Recall Register

When the data has been saved by using the save register function, each data is then saved to the C drive (RAM disk with back up).

3.2.20 Saving to Floppy Disks

The operation method of the storage and reproducing the set value of measurement with the store and loading file is explained here by the example of measuring the band pass filter of 10.7MHz.

In the store/loading file, the data is stored on the floppy disk inserted in A drive.

**Note:** Prepare the floppy disk that has been formatted. Available format type is DD 720KB, HD 1.2MB or HD 1.44MB.

- Formatting procedure of floppy disk
  - (a) Insert the floppy disk in the floppy disk drive. The format type in the initial state is DD 720KB or HD 1.2MB (8SECTORS).
  - (b) The floppy disk is formatted according to the following procedures.

[SAVE] → {FORMAT DISK} → {OK}



① Setup (filter connection) and presetting (Refer to section 3.1.2 and Figure 3-2).

② Set center frequency and span.

[CENTER] → [1] → [0] → [.] → [7] → [MHz]

[SPAN] → [1] → [MHz]

③ Calibrate the frequency characteristic as follows.

Connect the short adapter instead of DUT. Under such a condition, R3754 Series is normalized.

[CH1] → [CAL] → {NORMALIZE (THRU)}

[CH2] → [CAL] → {NORMALIZE (THRU)}

After ending, return the connection to DUT (filter).

④ The channel 1 is mode a magnitude (Logarithmic) display, and channel 2 a phase display.

[CH1]

[FORMAT] → {LOG MAG}

[CH2]

[FORMAT] → {PHASE}

⑤ Dual-channel is displayed at the same time.

[DISPLAY] → {DUAL CH ON/OFF} → {SPLIT CH ON/OFF}

⑥ The marker is displayed.

[MKR] 

3.2 Measurement Example

The display is shown in the figure below by the above-mentioned operation.

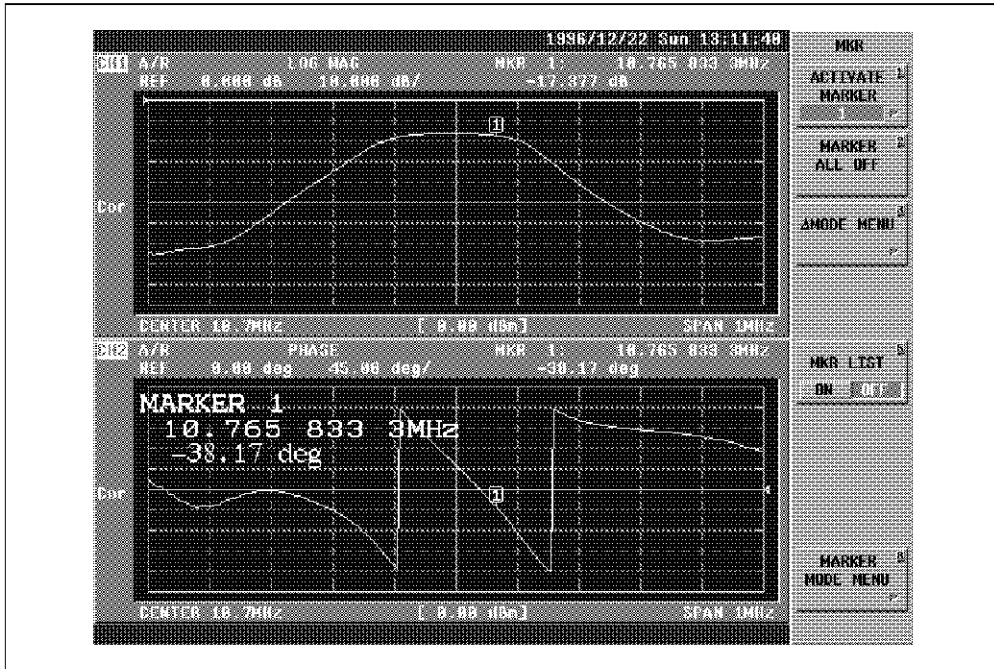

Figure 3-74 Preparation for Data Storing

- ⑦ The floppy disk that has been formatted is inserted in A drive. And the store file menu is selected.

(After floppy disk is inserted)

[SAVE] → {STORE FILE}

The file list window is displayed here.

- ⑧ Select the data to be saved. A set condition, the unformatted raw data and the calibration data are saved here.

{DEFINE STORE}

{STATE ON/OFF}

{RAW ARRAY ON/OFF}

{CORR COEF ON/OFF}

{Return}

Set them to ON.

When the calibration is executed, this will be automatically turned on.

- ⑨ The name will be set in the file before the data is saved. This makes retrieval easy. In the case saved by the file name of default, advance it to the following step ⑩.

{EDIT NAME}

{CLEAR NAME}

○ or [↑][↓] (The cursor is moved to "T") [X1]

○ or [↑][↓] (The cursor is moved to "E") [X1]

○ or [↑][↓] (The cursor is moved to "S") [X1]

○ or [↑][↓] (The cursor is moved to "T") [X1]

The display is shown in the figure below by the above-mentioned operation.

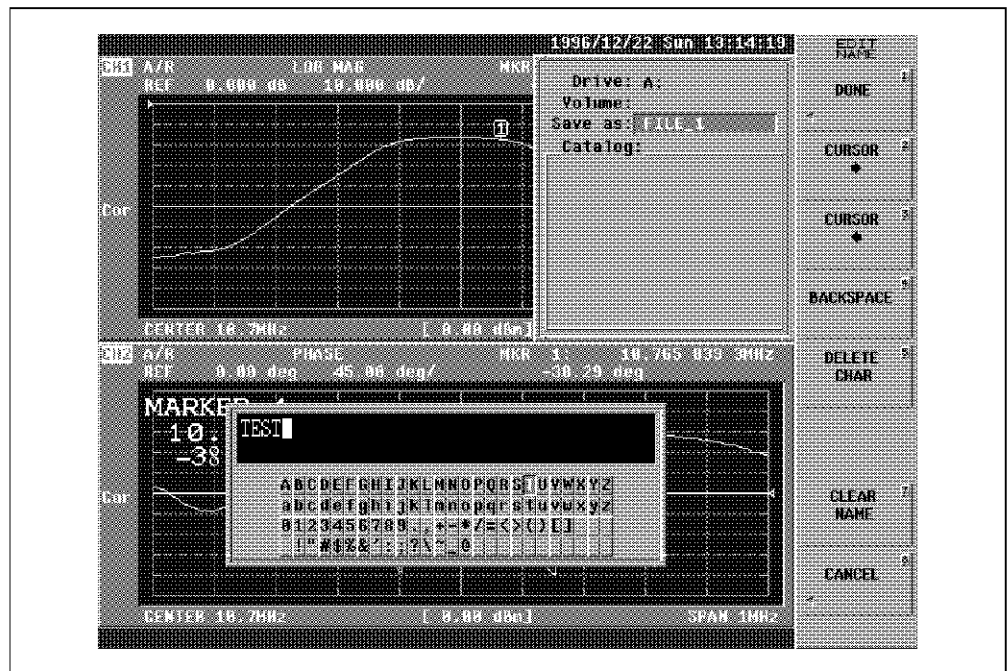

Figure 3-75 File Name Input

{DONE}

- ⑩ The data is stored.

{STORE}

Saving the data is completed through the above-mentioned operation. Next, the saved data is reproduced.

3.2 Measurement Example

- ⑪ Presetting. The set value is initialized.

[PRESET]

- ⑫ The storage data is reproduced from the file.

[RECALL] → {LOAD FILE}

The file list window is displayed here.

- ⑬ The file list window is displayed. The reproducing file is selected from the list. The cursor is moved to the file that reproduces by [↑] or [↓].

[LOAD]

Display screen is shown in the figure below by the above-mentioned operation.

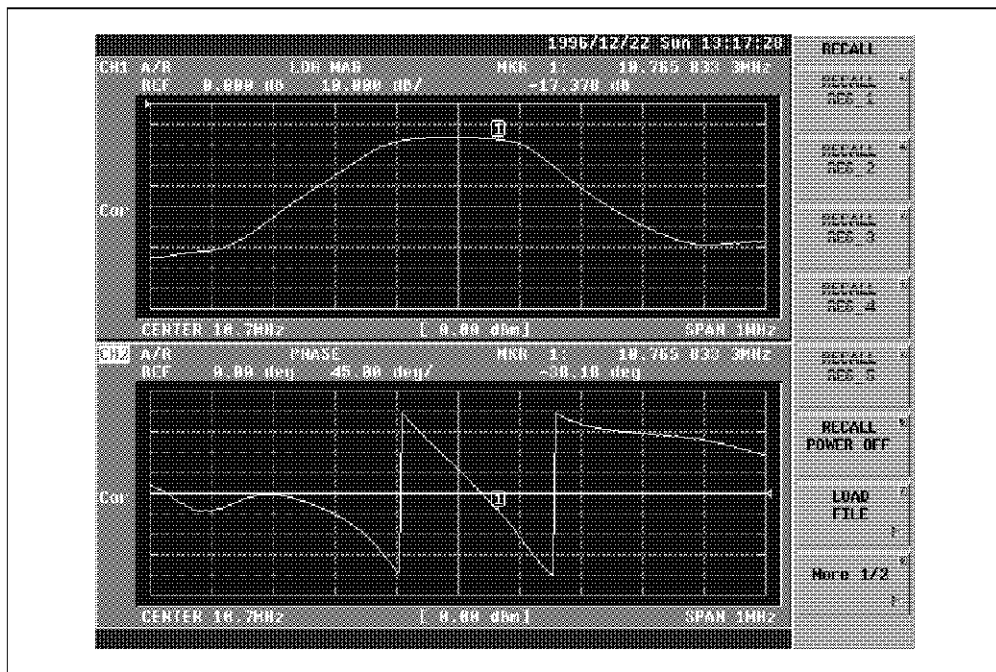

Figure 3-76 Reproduce of Stored Data

After the reproduction ends, the sweep will become a hold status automatically.

**Note: About stored measured data**

There is three ways in the storage of measured data.

1. RAW ARRAY (raw data)
2. DATA ARRAY (format data)
3. MEM ARRAY (memory data)

Among these, 1. RAW ARRAY and 2. DATA ARRAY saves the display data. The difference of these two data is the following. 1. RAW ARRAY saves the data before the error correction and the trace operation, etc. are processed. On the other hand, 2. DATA ARRAY saves the data on the display.

For instance, when the data saved by RAW ARRAY is reproduced, even if the measurement format is changed, a correct value at the storage can be displayed.

2. In DATA ARRAY, when the display format at the storage is displayed with LOG MAG, a correct value is indicated only by the LOG MAG format.

Refer to the data flow of section 1.1.3 for three data flows.

### 3.2.21 Crystal Resonator Impedance Measurement

This section explains how to measure a crystal impedance, showing the measurement of 10MHz crystal in which  $\pi$  network is used.

And this section introduces the interpolate function that can make calibration effective under the narrow span setting.

- ① Connect the  $\pi$  network jig to the R3754 Series and perform a preset. The type of the  $\pi$  network jig is PIC-001.

3.2 Measurement Example

- ② Attach a crystal to the test port of the  $\pi$  network jig.

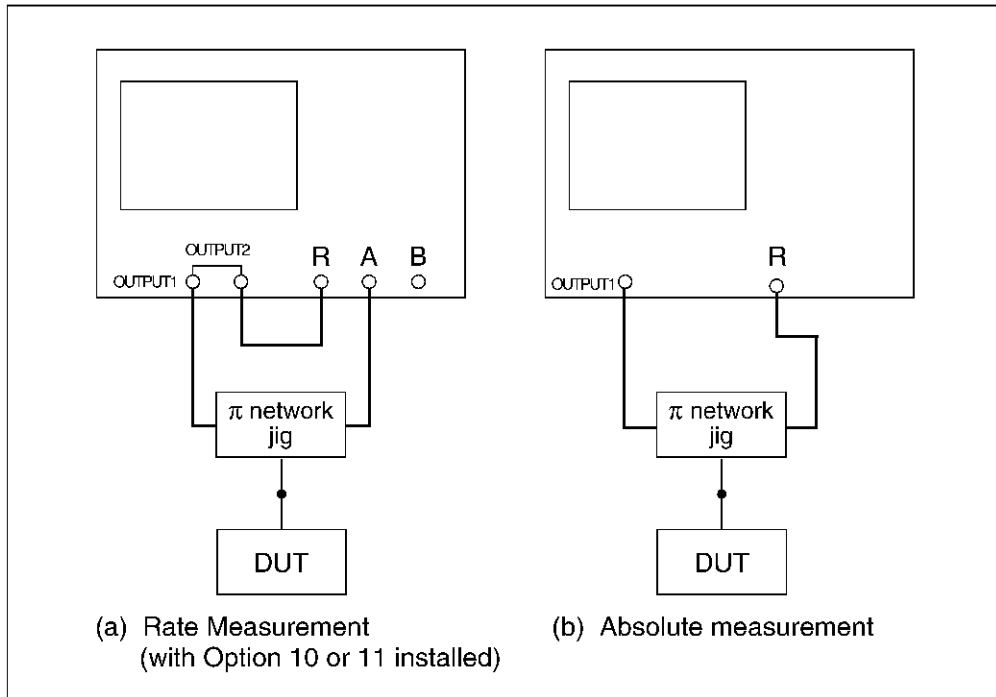

Figure 3-77 Connection for Crystal Resonator Impedance Measurement

- ③ Set the center frequency and the frequency span.

[CENTER] → [1] → [0] → [MHz]

[SPAN] → [1] → [0] → [0] → [kHz]

- ④ Enter the load standard value ( $50\Omega$ ).

[CAL] → {Z0 VALUE} → [5] → [0] → [X1]

- ⑤ Press [CAL] and {CAL MENUS} for the transmission full calibration.

The following screen appears with the full calibration menu.



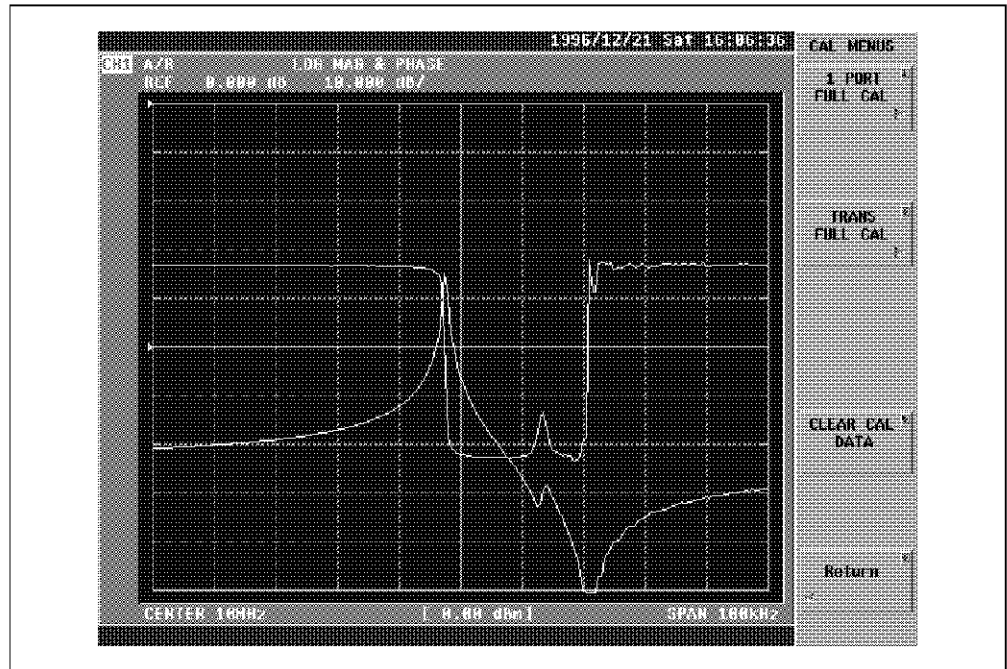

Figure 3-78 Selection of Calibration

- ⑥ Press {*TRANS FULL CAL*} to perform the calibration. After opening the test port of the  $\pi$  network jig, press {*OPEN*}.

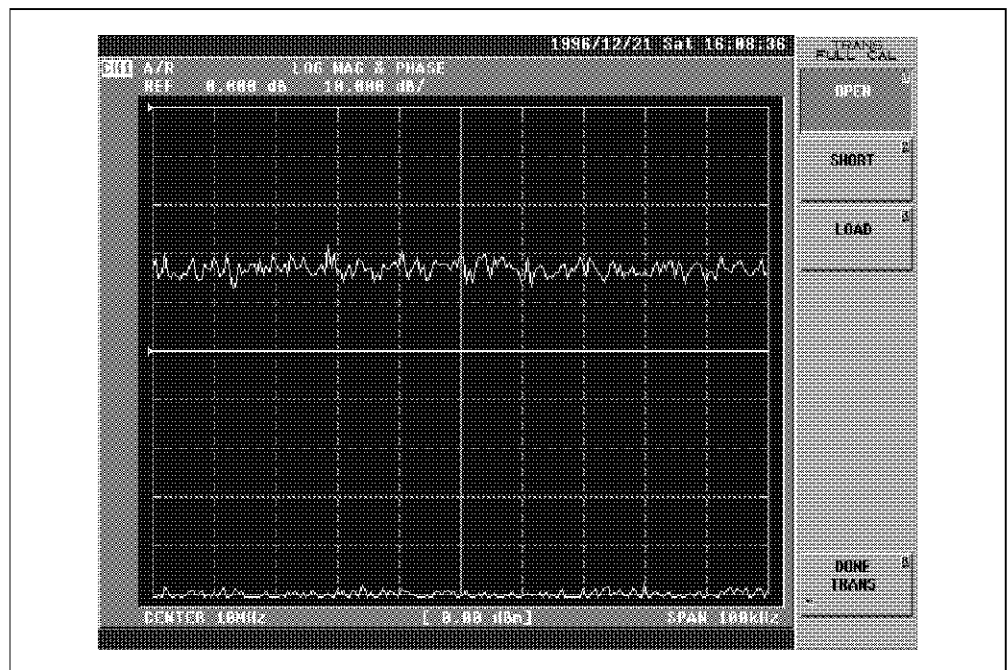

Figure 3-79 Calibration (Open)



3.2 Measurement Example

- ⑦ Attach the Short standard to the jig and then press {SHORT}.

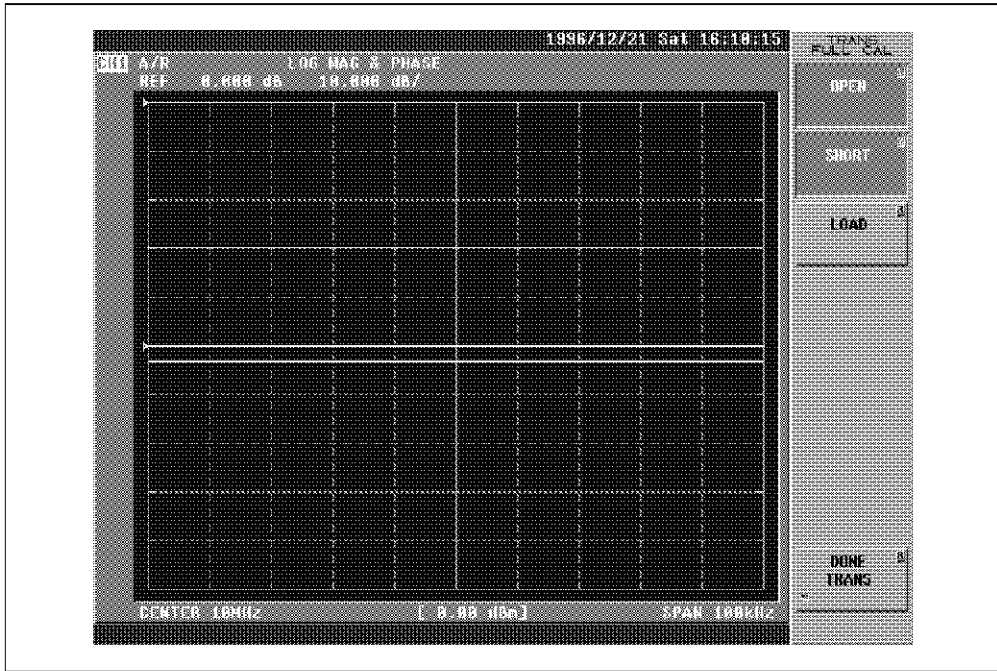

Figure 3-80 Calibration (Short)

- ⑧ Attach the Load standard (50Ω) to the jig and then press {LOAD}.

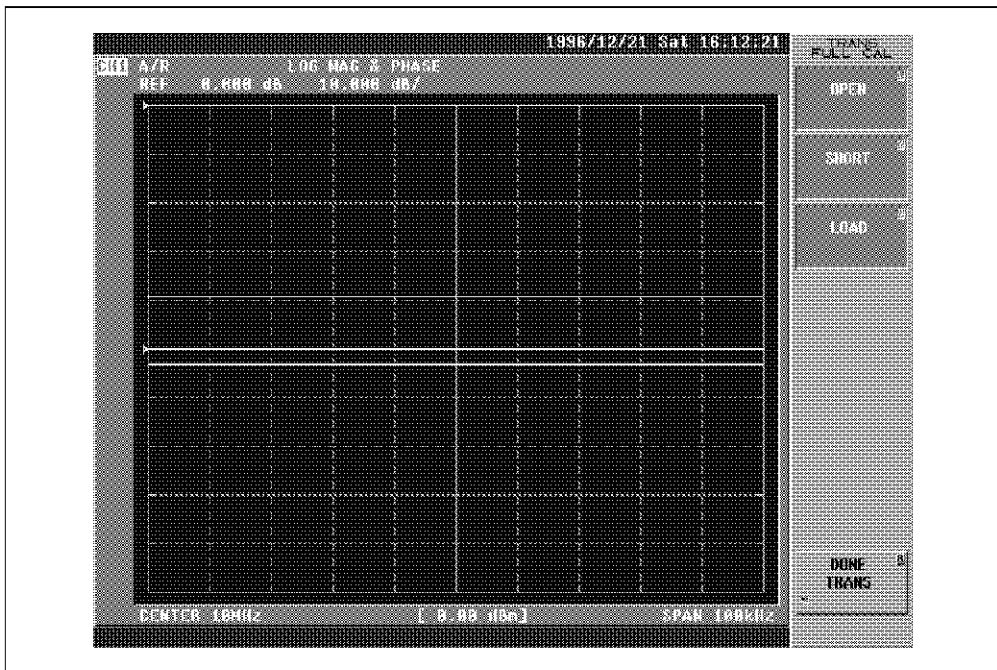
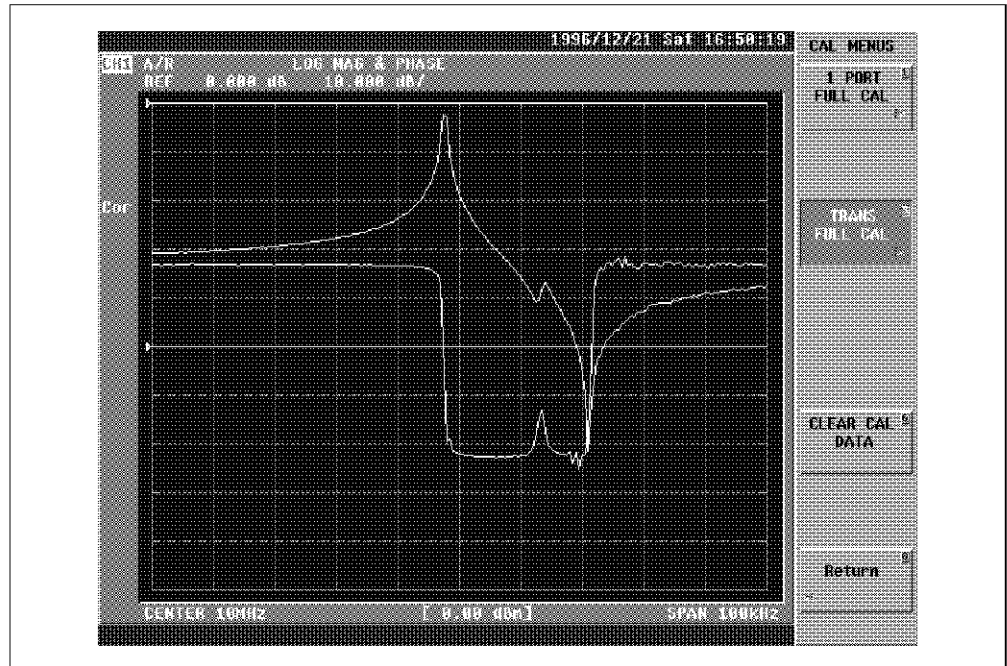

Figure 3-81 Calibration (Load)

- ⑨ Press *{DONE TRANS}* and then attach the crystal.

The screen shown in Figure 3-82 appears.



**Figure 3-82 Measurement after Calibration Executing**

- ⑩ Change the frequency span under the interpolate function and then change the screen to an impedance scale display.

Press **[CAL]** → *{INTERPOLATE ON/OFF}* to set the interpolate to ON.

Next, press **[SPAN]** → **[2]** → **[0]** → **[kHz]** to make the span narrow.

Then, press **[MEAS]** → *{CONVERSION [ ]}* → *{Z(TRANS)}* → **[SCALE]** → *{AUTO SCALE}*.

The screen shown in Figure 3-83 appears.

“C?” appears on the left side of the screen. “C?” indicates that the previous calibration data was interpolated and used.

3.2 Measurement Example

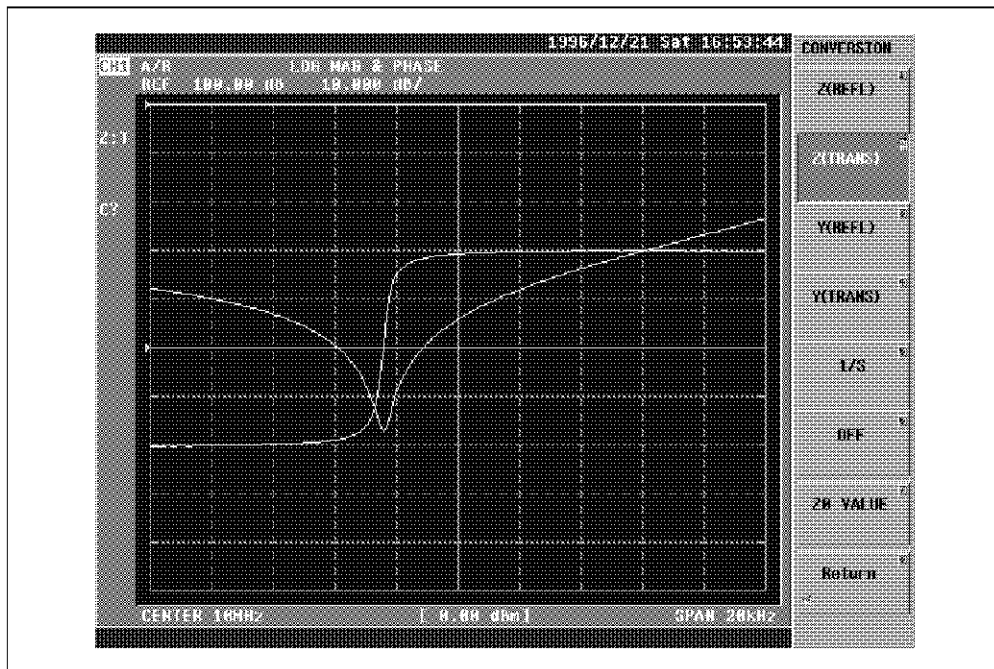

Figure 3-83 Calibration (Interpolation ON)

3.2.22 GO/NG Measurement Using Limit Line Function

GO/NG of DUT can be judged by using the limit line function of the R3754 Series. Besides the judgement of magnitude, GO/NG of Smith chart and Polar format can be judged.

- The following shows an example of how the limit line of 38MHz band-pass filter is generated.

Setting procedure

- Setup (filter connection) and presetting (Refer to section 3.1.2 and Figure 3-2).
- Setup start-frequency and stop-frequency.

[CENTER] → [3] → [8] → [MHz]

[SPAN] → [2] → [0] → [MHz]

- Set the measurement format to logarithmic magnitude.
- Calibrate the frequency characteristic.

Remove DUT and connect the through adapter instead.

Normalize in this state.

Following the completion of [CAL] → {NORMALIZE (THRU)}, return the connection to DUT.

The display on the screen is as follows.

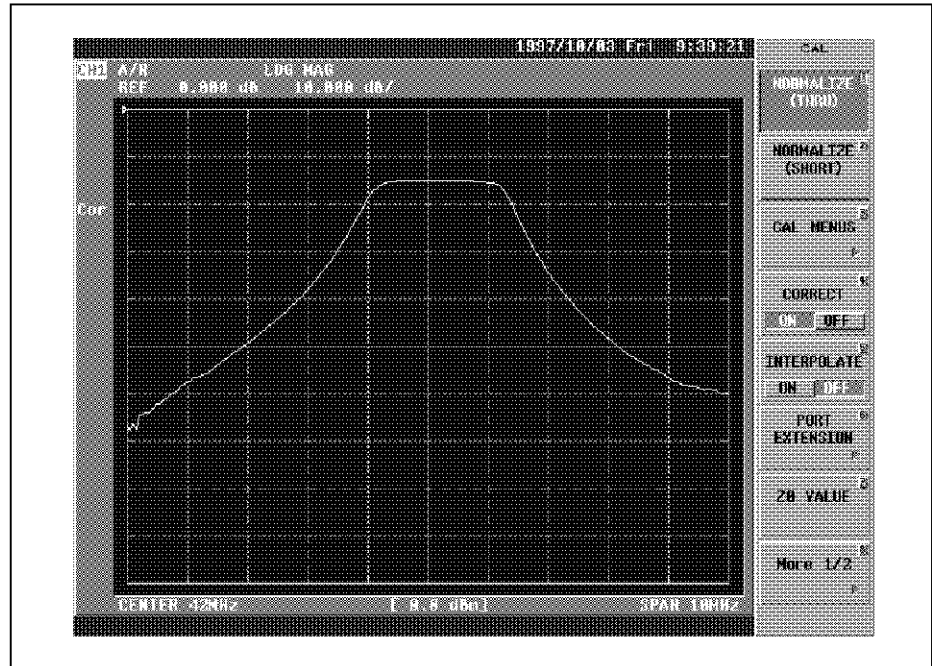

**Figure 3-84 Screen before Execution of Limit Line Measurement**

⑤ Set limit line.

Limit line is set the upper limit value and the lower limit line for each segment. The segment can be setup to 31 pcs. (0 to 30).

Here generates the limit line of the following table.

SEGMENT No.	0	1	2	3	4
Stimulus value	28MHz	30MHz	36.5MHz	40MHz	44MHz
Upper limit value	-50dB	-50dB	-10dB	-10dB	-45dB
Lower limit value	-70dB	-70dB	-30dB	-30dB	-65dB



3.2 Measurement Example

The following figure shows the limit lines.

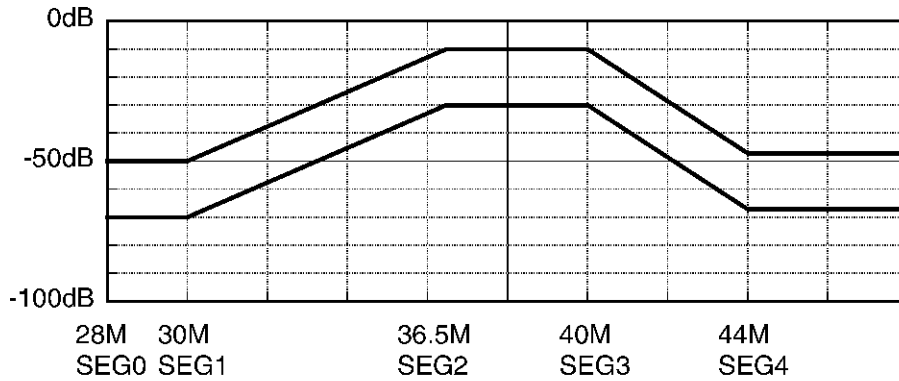

Figure 3-85 Setting of the Limit Line

- Establish the edit mode.

[SYSTEM] → {LIMIT MENU} → {EDIT LIMIT LINE}

The display on the screen is as follows.

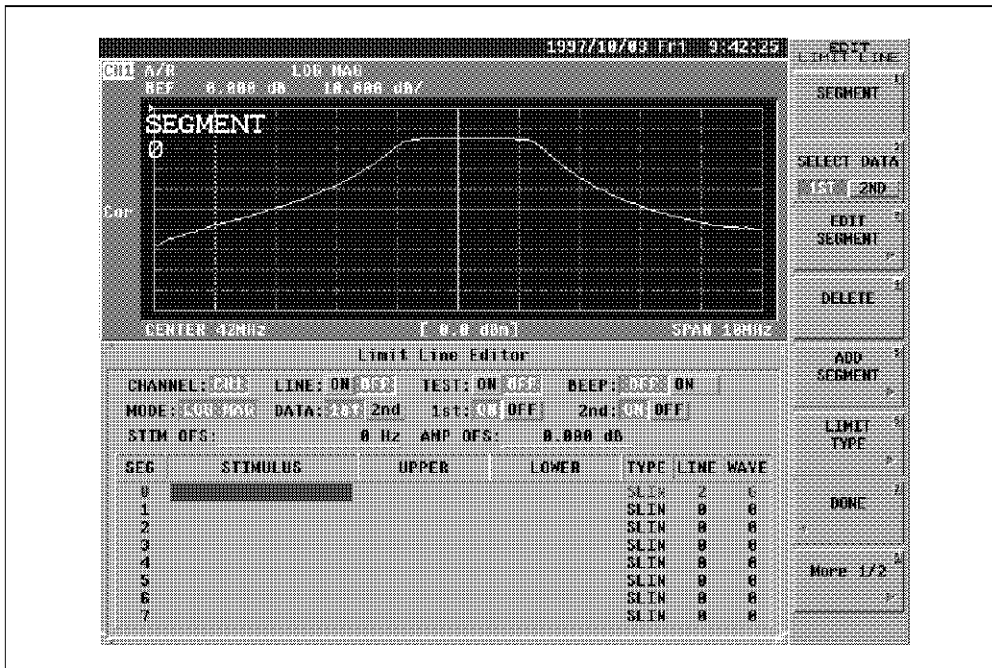

Figure 3-86 Limit Line Editing

- Set each segment.

Setting of segment 0.

SEGMENT 0: {EDIT SEGMENT}  
 {STIMULUS VALUE} → [2] → [8] → [MHz]  
 {UPPER LIMIT} → [-] → [5] → [0] → [X1]  
 {LOWER LIMIT} → [-] → [7] → [0] → [X1]  
 {Return}

As the marker can be used with data knob, it's useful to confirm the setting value of each segment.

The display on the screen is as follows.

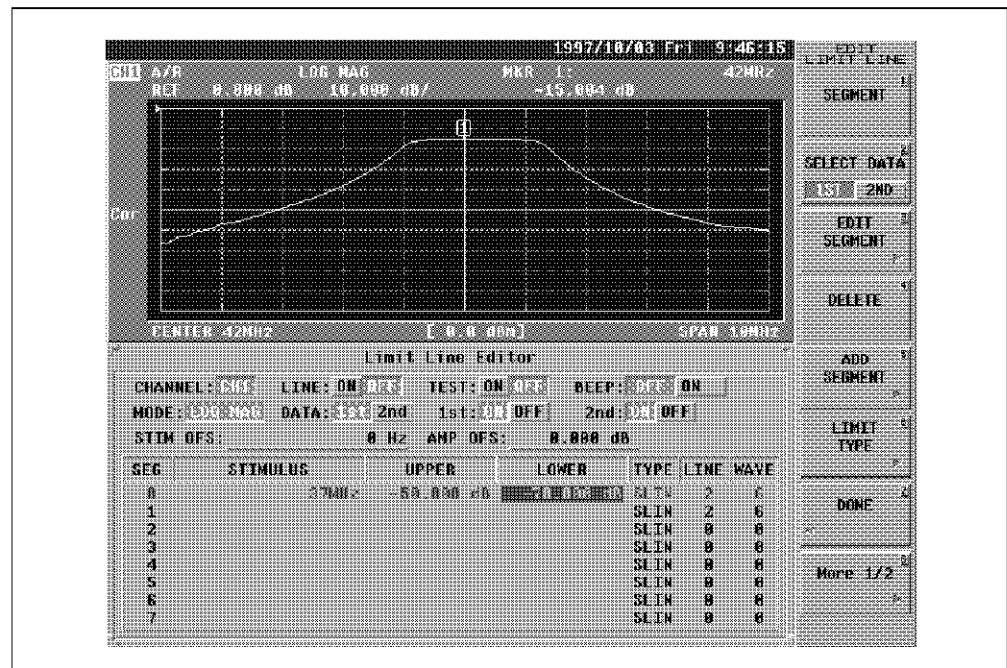

Figure 3-87 Setting of Segment 0

### 3.2 Measurement Example

Set segment 1, segment 2, segment 3 and segment 4 in the same way.

SEGMENT 1: {ADD SEGMENT}  
{STIMULUS VALUE} → [3] → [0] → [MHz]  
{UPPER LIMIT} → [-] → [5] → [0] → [X1]  
{LOWER LIMIT} → [-] → [7] → [0] → [X1] → {Return}

SEGMENT 2: {ADD SEGMENT}  
{STIMULUS VALUE} → [3] → [6] → [.] → [5] → [MHz]  
{UPPER LIMIT} → [-] → [1] → [0] → [X1]  
{LOWER LIMIT} → [-] → [3] → [0] → [X1] → {Return}

SEGMENT 3: {ADD SEGMENT}  
{STIMULUS VALUE} → [4] → [0] → [MHz]  
{UPPER LIMIT} → [-] → [1] → [0] → [X1]  
{LOWER LIMIT} → [-] → [3] → [0] → [X1] → {Return}

SEGMENT 4: {ADD SEGMENT}  
{STIMULUS VALUE} → [4] → [4] → [MHz]  
{UPPER LIMIT} → [-] → [4] → [5] → [X1]  
{LOWER LIMIT} → [-] → [6] → [5] → [X1] → {Return}



The display on the screen is as follows.

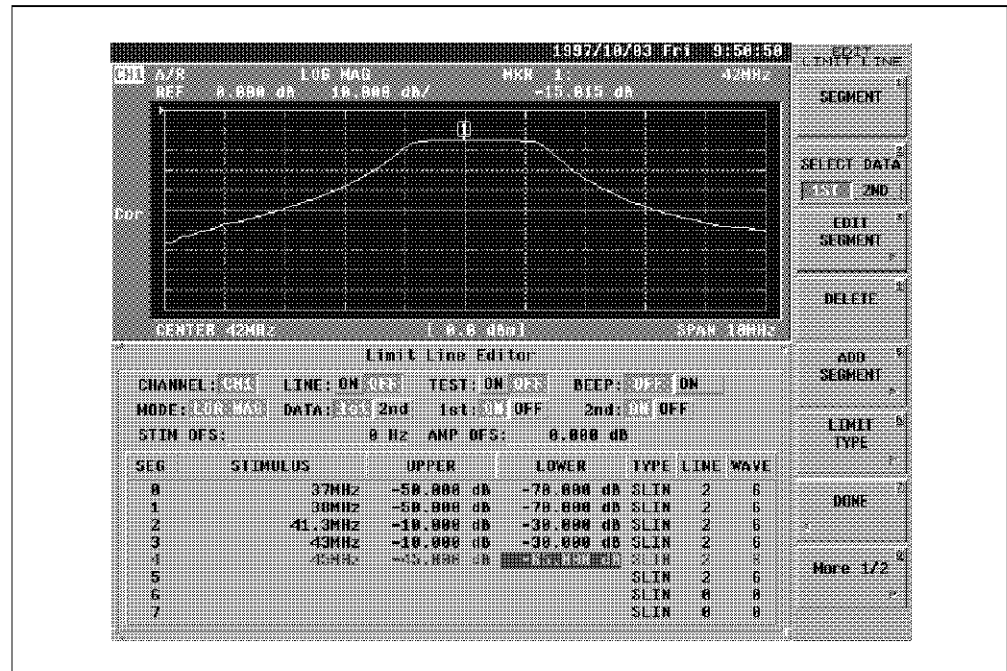

Figure 3-88 Setting of Each Segment

- Select a display type of limit line from the following 3 types for each segment.
  - [1] SLOPING LINE (SLIN) : Links to the next segment with a straight-line.
  - [2] FLAT LINE (FLIN) : Links to the next segment with horizontal lines.
  - [3] SINGLE POINT (SPO) : Shows each segment with a point.

In the above example, the type is not set as it's linked with SLOPING LINE of default.

For example, if you want to set FLAT LINE, operate as follows when the menu returned to the edit menu.

{LINE TYPE} → {FLAT LINE}

Returns to the edit menu of limit line.

{Return}

3.2 Measurement Example

- ⑥ Define the setting of limit line and return to the edit menu.

{DONE}

- ⑦ Switch ON the GO/NG judgement.

{LIMIT TEST ON/OFF}

- ⑧ Switch ON the limit line display.

{LIMIT LINE ON/OFF}

The display on the screen is as follows.

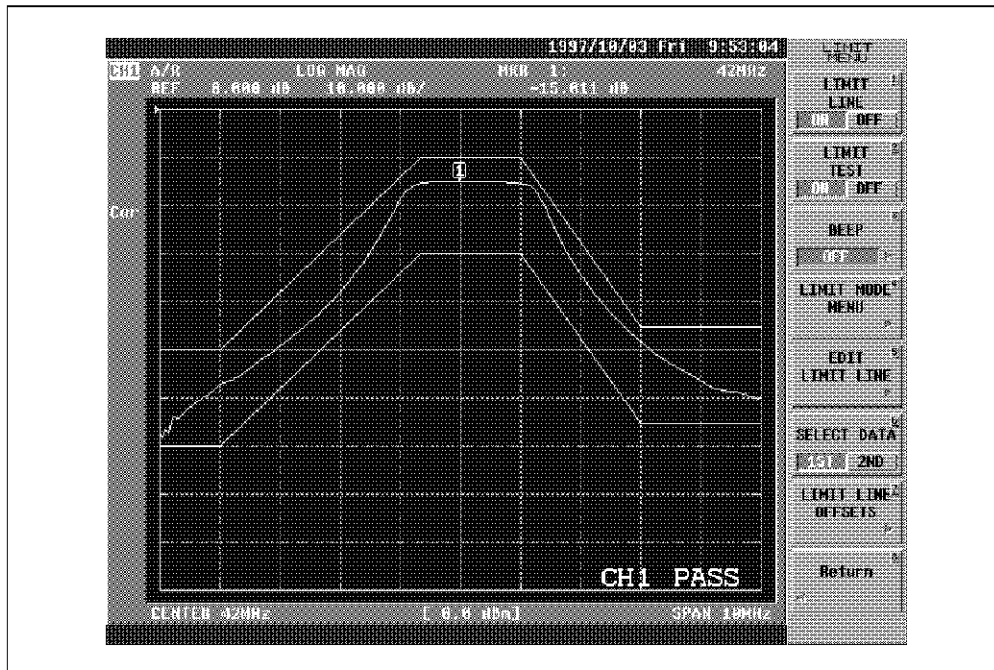

Figure 3-89 Execution of Limit Test

- ⑨ Change the lower limit values of segment 2 and segment 3 to -20dB.

{EDIT LIMIT LINE}

{SEGMENT} → [2] → [X1] → {EDIT SEGMENT}

{LOWER LIMIT} → [-] → [2] → [0] → [X1]

{Return}

{SEGMENT} → [3] → [X1] → {EDIT SEGMENT}

{LOWER LIMIT} → [-] → [2] → [0] → [X1]

{Return}

{DONE}

The display on the screen is as follows.

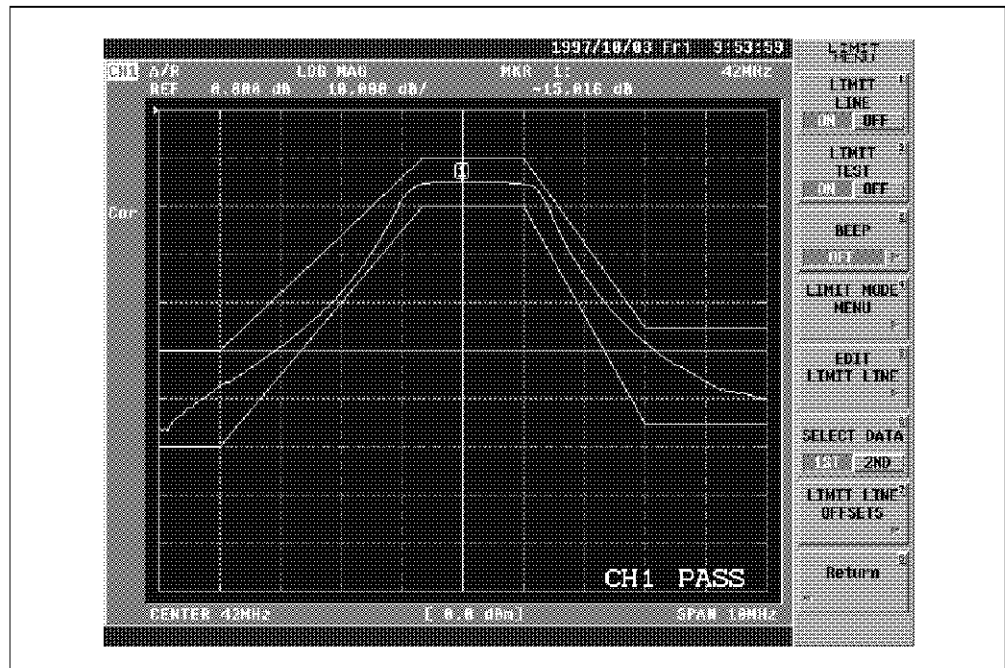

Figure 3-90 Change of Limit Line



## 4 FUNCTION DESCRIPTIONS

### (1) Functional blocks on front panel

The front panel keys are grouped into six functional blocks as shown below. With a combination of these blocks, the R3754 Series is operated.

- **ACTIVE CHANNEL block** : The R3754 Series has two measurement channels. The block is used to select an active channel which can be set or changed. (See section 4.1.)
- **ENTRY block** : Enters a numeric value for the selected function. (See section 4.2.)
- **STIMULUS block** : Selects the settings for the signal source. (See section 4.3.)
- **RESPONSE block** : Selects the settings of the receiver and the setting of the conditions of the display. (See section 4.4.)
- **INSTRUMENT STATE block** : Selects the system settings such as save/recall and hard copy. (See section 4.8.)
- **GPIB block** : Selects the settings of the controller and the GPIB. (See section 4.9.)

When the key of each block mentioned above is pressed, the item (Soft key menu) corresponding to the function is displayed on a right side of the display screen.

### (2) Key operation

Two types of key operations are available for the R3754 Series as follows :

- When a numeric value is required to be entered :  
**[Panel key]** → {Soft key} → **[ENTRY block]**
- When only soft key menus are required for selection :  
**[Panel key]** → {Soft key}

If some key is pressed for more than about 0.5 second, the pressed key is entered repetitively.

However, pressing more than two keys or more at the same time brings nothing.

### (3) Structures of soft key menus

The soft key menu has multiple-page structure and hierarchical structure.

- **Multiple-page structure type** :  
 Pressing the {More 1/2} moves to next page and pressing the {More 2/2} moves to previous page.
- **Hierarchical structure type** :  
 Pressing the {Return} to the previous layer menu.  
 When **[Panel key]** is pressed during the layer menu display, the menu will return to the first layer menu.

---

4.1 ACTIVE CHANNEL Block

### 4.1 ACTIVE CHANNEL Block

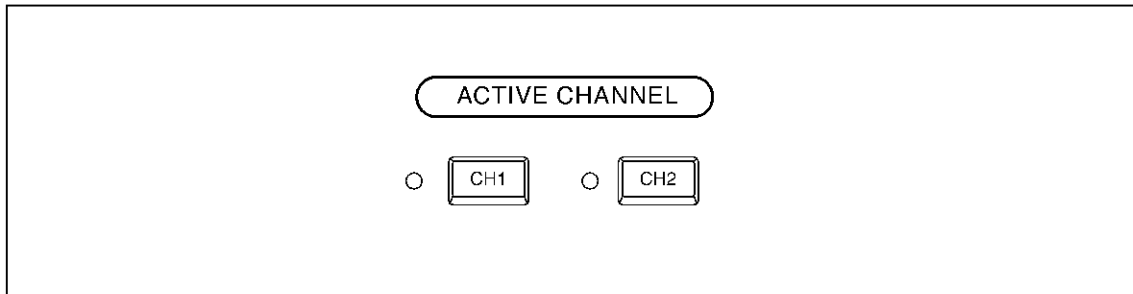

The R3754 Series can perform the simultaneous measurement for reflection and transfer characteristics of sample devices or the simultaneous measurement under different frequency conditions.

The R3754 Series has two measurement channels which can be independently used for measurement and data display. ACTIVE CHANNEL block is used to select which channel will be used for the active channel. The active channel is the channel for which various conditions can be set such as measurement and data display, that is, all the channel dependent functions will apply to the active channel. The channel with its LED lit up is the current active channel.

**[CH1]** : Sets channel 1 to active channel.

**[CH2]** : Sets channel 2 to active channel.

The setting of the signal source can be interlocked between channels.

In the case, the condition which has been set to the active channel will be also set to the other channel. (See section 4.3.2.)



## 4.2 ENTRY Block

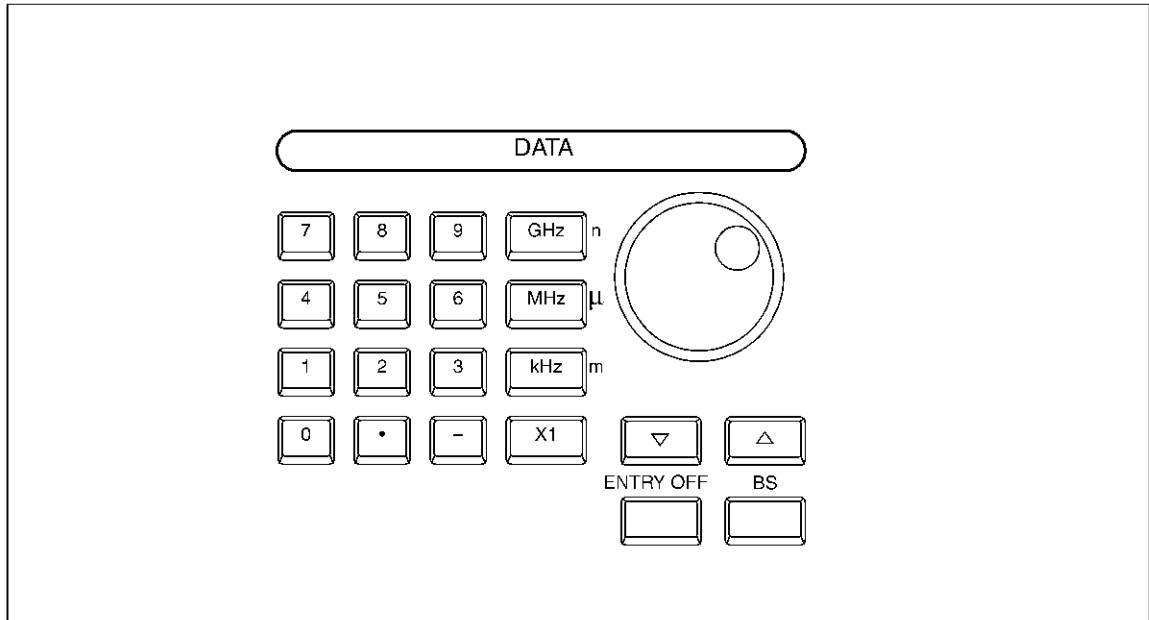

The ENTRY block is used to set data input/change for the selected function by using the **[Panel key]** and *{Soft key}*.

This block is also used to set/change a marker.

Numeric keys : **[0] to [9]** ; Ten keys.

**[.]** ; Decimal point key.

**[-]** ; Minus sign key.

**[BS]** ; Back space key.

**[ENTRY OFF]** ; Entry off key.

Clears all numeric data and also cancels an input request.

**Note:** After numeric key operation, press unit keys.

Input numeric values by using numeric keys, a decimal point key, and a minus sign key. Then, press a unit key after inputting the numeric value.

Pressing the unit key determines the unit of the input numeric values and terminates numeric entry. Namely the numeric entry is not complete until is specified by pressing a unit key.

While an arrow (→) is being displayed on the left side of the active entry area, the numeric entry does not complete.



### 4.3 STIMULUS Block

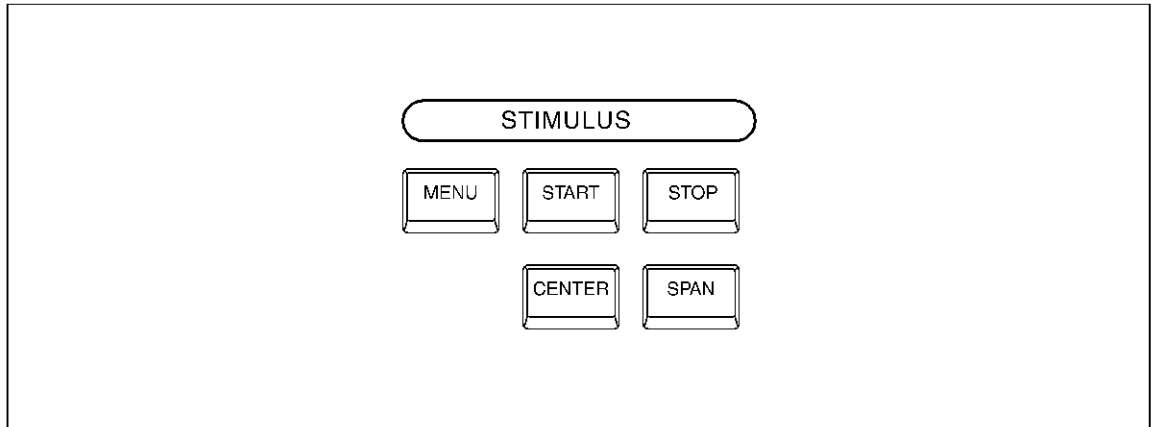

This block is used to set the conditions concerning the signal sources such as a frequency range, power level setting, sweep type, sweep time and sweep resolution. When an S parameter test-set is connected, the attenuator setting of the S parameter test-set can be also performed.

- [MENU]** : Calls the signal source menu to be set such as an output level, sweep time, sweep type, and sweep resolution. (See section 4.3.1.)
- [START]** : Specifies the sweep start.  
Sets each start frequency or start power when the sweep type is a frequency type or power type.
- [STOP]** : Specifies sweep stop.  
Sets each stop frequency or power when the sweep type is a frequency type or power type.
- [CENTER]** : Specifies the center sweep.  
Set center frequency when the sweep type is a frequency type.
- [SPAN]** : Specifies the sweep span.  
Set frequency span when the sweep type is a frequency type.

Set the sweep range by pressing the **[START]**, **[STOP]**, **[CENTER]** or **[SPAN]**.

For the other settings, press the **[MENU]** to call the signal source menu, then perform the setting.

### 4.3.1 Setting Signal Source

#### Operation procedure

- ① Press the [MENU] to call the signal source menu.
- ② Signal source menu

- |                            |   |  |
|----------------------------|---|--|
| <i>{POWER}</i>             | : | Calls the power menu used for selecting an output power and an output port. (See step ③.)  |
| <i>{SWEEP TIME}</i>        | : | Sets the sweep time.<br>When a zero is set, AUTO is selected.<br>When AUTO is set, the minimum sweep time is set according to the sweep frequency range and receiver section resolution bandwidth. |
| <i>{SWEEP TYPE [ ]}</i>    | : | Calls the sweep type menu for selecting a sweep type. (See section 4.7.)   |
| <i>{TRIGGER [ ]}</i>       | : | Calls the trigger menu for selecting a sweep trigger condition. (See step ④.)  |
| <i>{POINTS}</i>            | : | Sets the number of sweep point. The number of settable points are: 3, 6, 11, 21, 51, 101, 201, 301, 401, 601, 801 or 1201 points.  |
| <i>{COUPLED CH ON/OFF}</i> | : | Selects whether the setting conditions concerning the channels 1 and 2 are same or not. (See section 4.3.2.)   |
| <i>{CW FREQ}</i>           | : | Sets the frequency at power sweep.   |
| <i>{RESTART}</i>           | : | Restarts the measurement from sweep start.<br>When this key is pressed, the sweep restarts from the start, even if the sweep is uncompleted.   |

## ③ Power menu

- {OUTPUT 1}* : Sets the output port to OUTPUT1 (single output).  
*{OUTPUT 2}* : Sets the output port to OUTPUT2 (dual output).  
(Note 1)  
*{POWER}* : Sets the output level during frequency sweep.

**Note1: This menu is displayed only when Option 10 or 11 is installed.**

## ④ Trigger menu

- {CONTINUOUS}* : Continuously performs sweep.  
*{SINGLE}* : Performs sweep once.  
If this key is pressed in the middle of a sweep, the measurement of the sweep is interrupted and a sweep is restarted.  
*{HOLD}* : Stops sweep measurement.  
If this key is pressed in the middle of sweep, immediately sweep is interrupted.  
*{INT TRIG}* : Automatically starts sweep by an internal source.  
*{EXT TRIG}* : Starts sweep by an external synchronization signal.  
The external synchronization signal is input through the parallel I/O connector 18-pin of the rear panel.  
Negative logic, pulse width: 1  $\mu$ s or more  
*{TRIGGER DELAY}* : Sets delay time between receiving the trigger signal and the start of sweep.

---

## 4.3 STIMULUS Block

### 4.3.2 Interlocking between Channels

Selects whether the measurement condition concerning the signal source is set at the same condition or independently set in each channel when two-channel simultaneous measurement.

For interlock setting : The conditions which has been set to the active channel will be automatically set to the other channel as same.

For independent setting : Different measuring condition can be set to channel 1 and 2, respectively.

The setting conditions which can be interlocked between channels are shown below:

- Sweep type
- Frequency
- Output level
- Sweep time
- Number of measurement point
- Resolution bandwidth

#### Operation procedure

- ① Press the **[MENU]** to call the signal source menu.
- ② Press the **{COUPLED CH ON/OFF}** to select whether the setting condition concerning the measurement between the channel 1 and channel 2 is set at the same condition or not.
  - ON : Measures the channel 1 and channel 2 simultaneous at the same condition.
  - OFF : Measures the channel 1 and channel 2 alternately. (Performs the measurement of channel 1, then channel 2.)



#### 4.4 RESPONSE Block

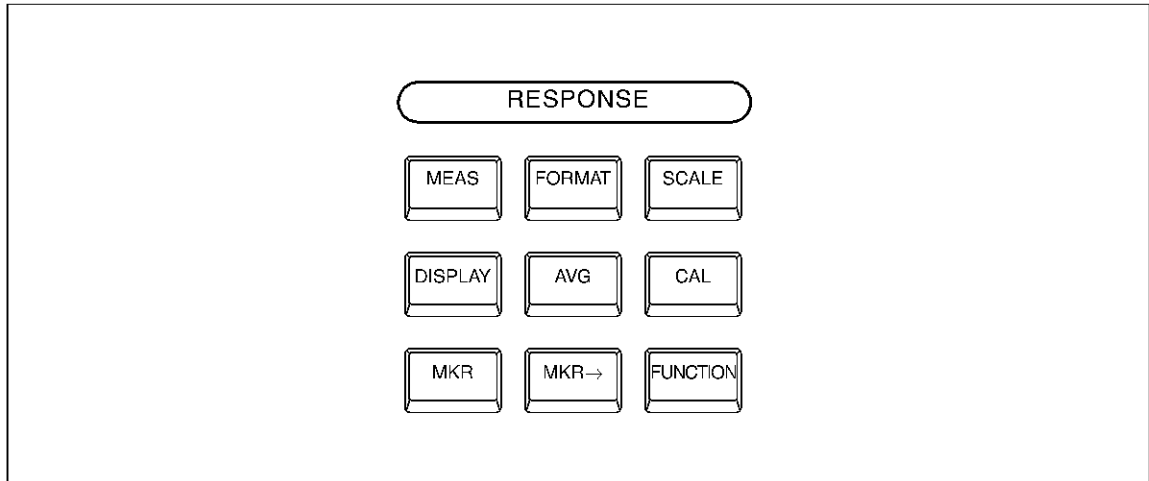

The RESPONSE block is used to set the measurement conditions of receiver section, measurement parameters, measurement format, display format and marker for an active channel.

- [MEAS]** : Calls the measurement menu for selecting an input port and measurement parameters. (See section 4.4.1.)
- [FORMAT]** : Calls the format menu for selecting the format of measurement data. (See section 4.4.2.)
- [SCALE]** : Calls the scale menu for setting the display coordinate axis. (See section 4.4.3.)
- [DISPLAY]** : Calls display menu for executing 2-channel simultaneous display, trace operation function and label input. (See section 4.4.4.)
- [AVG]** : Calls the average menu for executing data average, smoothing, resolution bandwidth setting. (See section 4.4.8.)
- [CAL]** : Calls the calibration menu for setting calibration function. (See section 4.5.)
- [MKR]** : Calls the marker menu for setting a marker. (See section 4.6.)
- [MKR→]** : Calls the marker search menu for setting analysis by using a marker. (See section 4.6.)
- [FUNCTION]** : Calls the attenuator menu for selecting a receiver section input attenuator and impedance. (See section 4.4.9.)

### 4.4.1 Setting Input and Parameter Conversion

Selects the receiver section input port.

The data which is measured in the selected input port is a "complex data". This data is also formatted such as the magnitude, phase, group delay. Data before formatting can be changed to impedance, admittance, reverse S parameter.

Operation procedure

① Press the [MEAS] to call the measurement menu.

② Measurement menu

{A/R} : Sets the input port to A/R. (Note 1)

{B/R} : Sets the input port to B/R. (Note 2)

{A/B} : Sets the input port to A/B. (Note 2)

{CONVERSION[ ]} : Calls the parameter menu for converting the measured data to an impedance, admittances or reverse S parameters. (See step ③.)

**Note1:** This menu is displayed only when Option 10 or 11 is installed.

**Note2:** This menu is displayed only when Option 11 is installed.

## ③ Parameter conversion menu

{Z (REFL)} : Executes the impedance conversion by the reflection measurement.

$$\text{Conversion expression} = \frac{1 + \rho}{1 - \rho} \times Z_0 \text{ (Note)}$$

{Z (TRANS)} : Executes the impedance conversion by the transmission measurement.

$$\text{Conversion expression} = \frac{2(1-T)}{T} \times Z_0 \text{ (Note)}$$

{Y (REFL)} : Executes the admittance conversion by the reflection measurement.

$$\text{Conversion expression} = \frac{1 - \rho}{1 + \rho} \times \frac{1}{Z_0} \text{ (Note)}$$

{Y (TRANS)} : Executes the admittance conversion by the transmission measurement.

$$\text{Conversion expression} = \frac{T}{2(1-T)} \times \frac{1}{Z_0} \text{ (Note)}$$

{1/S} : Converts the S parameter to the reverse S parameter.

$$\text{Conversion expression} = \frac{1}{S} \text{ (Note)}$$

{OFF} : Turns off the conversion function.

{Z0 VALUE} : Sets the characteristics impedance.

**Note:**  $\rho$  : **Reflection coefficient**  
 $T$  : **Gain**  
 $S$  : **Reflection coefficient or gain**  
 $Z_0$  : **Characteristics impedance**

### 4.4.2 Display Data Format

Formats the measurement data. Data is displayed as the type formatted.

Operation procedure

- ① Press the [**FORMAT**] to call the format menu.
- ② Format menu
  - Format menu (1 of 2)
    - {LOG MAG}* : Sets to the logarithmic magnitude display.
    - {PHASE}* : Sets to the phase display.  
The display is changed to the loop back display in  $\pm 180^\circ$ .
    - {DELAY}* : Sets to the group delay display.
    - {SMITH (R+jX)}* : Sets to the Smith chart.
    - {SMITH (G+jB)}* : Sets to the admittance chart.
    - {POLAR}* : Sets to the polar coordinates display.
    - {LIN MAG}* : Sets to the linear magnitude.
  - Format menu (2 of 2)
    - {SWR}* : Sets to the SWR (standing wave ratio) display.
    - {REAL}* : Sets to the measurement data real display.
    - {IMAG}* : Sets to the measurement data imaginary display.
    - {PHASE  $-\infty, +\infty$ }* : Sets to the continuous phase display.  
The phase is changed to the no loopback display in  $\pm 180^\circ$  based on the one point data.
    - {LOG MAG & PHASE}*: Sets to the simultaneous display with logarithmic magnitude and phase.
    - {LOG MAG & DELAY}*: Sets to the simultaneous display with logarithmic magnitude and group delay.
    - {LIN MAG & PHASE}* : Sets to the simultaneous display with linear magnitude and phase.

### 4.4.3 Setting Display Coordinate Scale

The coordinate in accordance with selected format is displayed on the screen.  
The coordinate scale is changed on the scale menu.

#### Operation procedure

① Press the **[SCALE]** to call the scale menu.

② Scale menu

- {AUTO SCALE}* : Automatically sets the display coordinate to be an optimize value for display trace.
- {DIV}* : For the cartesian format, sets the value of the vertical axis 1 scale.
- {REF VALUE}* : Sets the reference position value of the display coordinate.
- {REF POS}* : Specifies the reference position of the display coordinate.
- {REF LINE ON/OFF}* : Selects ON/OFF of the reference position display.
- {FULL SCALE}* : Sets a full scale value for a smith chart and polar coordinate display.
- {SCALE FOR 2nd/1st}*: Selects a preferred trace in displaying two traces simultaneously.

#### 4.4.4 Split-Screen Display and Display Selection Information

The 2-channel simultaneous display can be performed.

The selection of trace data, the coordinate display ON/OFF, the label input can be performed.

##### Operation procedure

- ① Press the [**DISPLAY**] to call the display menu.
- ② Display menu
  - Display menu (1 of 2)
    - {DUAL CH ON/OFF}* : Selects ON/OFF of the 2-channel simultaneous display.
    - {SPLIT CH ON/OFF}* : Selects ON/OFF of the split-screen (upper/lower) display.  
When the split-screen is selected, upper screen for channel 1 and lower screen for channel 2 are set.
    - {DISPLAY DATA}* : Displays the measurement data only.
    - {DISPLAY MEMORY}* : Displays the memory data only.
    - {DISPLAY DATA & MEM}* : Displays both the measurement data and memory data.
    - {DEFINE TRACE [ ]}* : Calls the trace operation menu.  
Perform the fundamental arithmetic operation between measurement data and memory data in the trace operation. (See section 4.4.5.)
    - {DATA → MEMORY}* : Sets the measurement data to the memory.
  - Display menu (2 of 2)
    - {GRATICULE ON/OFF}* : Selects ON/OFF of the coordinate display.
    - {LABEL}* : Calls the label menu for entering the label. (See section 4.4.6.)
    - {COLOR}* : Sets the color of traces and markers for each channel. (See section 4.4.7.)
    - {DEFAULT COLOR}* : Changes all color settings back to their defaults.

#### 4.4.5 TRACE Operation

The trace operation is used to execute fundamental arithmetic operation between the measurement data and memory data.

Operation procedure

- ① Press the **[DISPLAY]** to call the display menu.
- ② Press the **{DEFINE TRACE [ ]}** to call the trace operation menu.
- ③ Trace operation menu

**{DATA/MEM}** : Executes the division of measurement data and memory data, then displays the result as the measurement data.

**{DATA-MEM}** : Executes the subtraction of measurement data and memory data, then displays the result as the measurement data.

**{DATA\*MEM}** : Executes the multiplication of measurement data and memory data, then displays the result as the measurement data.

**{DATA+MEM}** : Executes the addition of measurement data and memory data, then displays the result as the measurement data.

**{OFF}** : Cancels the operation (calculation).



4.4 RESPONSE Block

4.4.6 Label input

An annotation of measurement data and so on is input as a label.  
 Maximum 64 characters can be input.

Operation procedure

- ① Press the [DISPLAY] to call the display menu.
- ② Press the {More 1/2}.
- ③ Press the {LABEL} to call the label window and label menu.
- ④ Label menu (Select the character of label menu by using the data knob, and press the [X1].)

- {DONE} : Completes the label input.
- {CURSOR →} : Shifts the cursor indicating the label input position to the right.
- {CURSOR ←} : Shifts the cursor indicating the label input position to the left.
- {BACK SPACE} : Backspaces.
- {DELETE CHAR} : Deletes one character.
- {CLEAR LINE} : Deletes all characters.
- {CANCEL} : Cancels the edit.

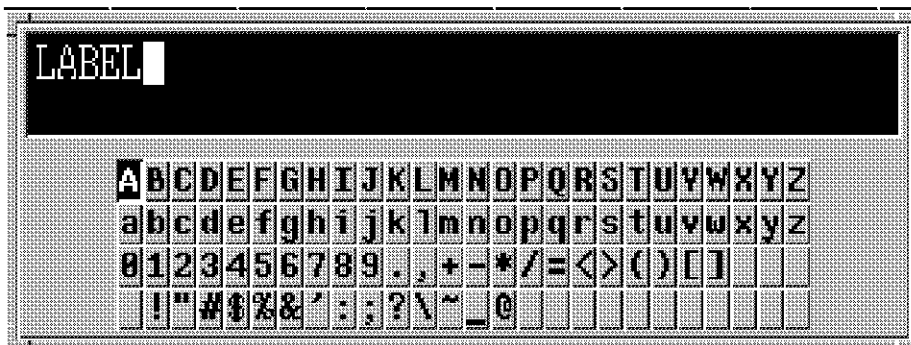

Figure 4-1 Label Window Display

### 4.4.7 Colors Settings

The following explains how to set the colors of traces and markers for each channel.

#### Operation procedure

- ① Press the [DISPLAY] to call the display menu.

Press the {More 1/2}.

Press the {COLOR} to call the color menu.

{DEFAULT COLOR} : Changes all color settings to their default values.

- ② Color menu

- Color menu (1 of 3)

{1ST TRACE} : Sets the color of the first trace for the active channel.  
When this function is selected, the RGB menu is displayed.

{2ND TRACE} : Sets the color of the second trace for the active channel.  
When this function is selected, the RGB menu is displayed.

{1ST MARKER} : Sets the color of the normal marker on the first trace for the active channel.  
When this function is selected, the RGB menu is displayed.

{2ND MARKER} : Sets the color of the normal marker on the second trace for the active channel.  
When this function is selected, the RGB menu is displayed.

{REF LINE} : Sets the color of the reference line for the active channel.  
When this function is selected, the RGB menu is displayed.

{ACTIVE MARKER}: Sets the color of the active marker for the active channel.  
When this function is selected, the RGB menu is displayed.

- Color menu (2 of 3)

{SCREEN} : Sets the screen color.  
When this function is selected, the RGB menu is displayed.

{GRID FD} : Sets the color of the grid of coordinates display.  
When this function is selected, the RGB menu is displayed.

{GRID BG} : Sets the background color of the trace display area.  
When this function is selected, the RGB menu is displayed.

{WINDOW BG} : Sets the box color of the trace display window.  
When this function is selected, the RGB menu is displayed.

{SWEEP MARKER}: Displays the color of the sweep indicator.  
When this function is selected, the RGB menu is displayed.

---

#### 4.4 RESPONSE Block

- Color menu (3 of 3)

- {ANNOTATION}* : Sets the color of the channel name being displayed on the box of the trace display window and the color of the annotation such as stimulus data.  
When this function is selected, the RGB menu is displayed.
- {CLOCK}* : Sets the color of the date and clock display at the top right-hand corner of the screen.  
When this function is selected, the RGB menu is displayed.
- {LABEL}* : Sets the color of the label display.  
When this function is selected, the RGB menu is displayed.
- {OVERLAY TEXT}* : Sets the color of the overlay text displayed in the active area.  
When this function is selected, the RGB menu is displayed.
- {BASIC TEXT}* : Sets the color of the BASIC TEXT.  
When this function is selected, the RGB menu is displayed.

③ RGB menu

Determines the color of each item by the proportions of R(Red), G(Green) and B(Blue). Each value of RGB can be set in the range 0 to 255. A setting of 0 for each value is displayed as black while a setting of 255 for each value is displayed as white.

- {RED}* : Performs the setting of RED.
- {GREEN}* : Performs the setting of GREEN.
- {BLUE}* : Performs the setting of BLUE.

The changed value is stored in the environmental file of the system. It is valid in turning on the power next time.

#### 4.4.8 Averaging/Smoothing and Resolution Bandwidth

Averaging (time average) and smoothing (moving average) are provided as the function which statistically reduces random errors that cannot be reproduced. Narrow resolution bandwidth will reduce noise component, thus decreasing random errors. However, the case will increase the sweeping time.

##### Operation procedure

① Press the **[AVG]** to call the average menu.

② Average menu

*{AVG STATE ON/OFF}* : Selects ON/OFF of averaging. (Note)

*{AVG COUNT}* : Sets the number of times for averaging. (Note)

*{AVG RESTART}* : Resets the averaging and restarts at the average time 1. (Note)

*{GROUP DELAY APERTURE}*

: Sets the aperture for group delay measurement. The aperture should be considered in the same manner as the smoothing aperture. (Note)

*{SMOOTHING ON/OFF}*: Selects ON/OFF of smoothing. (Note)

*{SMOOTHING APERTURE}*

: Sets the smoothing aperture. (Note)

*{IF RBW [ ]}* : Sets the resolution bandwidth. If "0" is set, it is set to AUTO which automatically sets the bandwidth according to the measurement frequency.

4.4 RESPONSE Block

Resolution bandwidth	Maximum sweeping per point
15kHz	0.05ms/POINT
10kHz	0.10ms/POINT
7kHz	0.15ms/POINT
5kHz	0.20ms/POINT
4kHz	0.25ms/POINT
3kHz	0.35ms/POINT
2kHz	0.50ms/POINT
1.5kHz	0.70ms/POINT
1kHz	1.0ms/POINT
700Hz	1.4ms/POINT
500Hz	1.9ms/POINT
400Hz	2.7ms/POINT
300Hz	3.4ms/POINT
200Hz	5.0ms/POINT
150Hz	7.0ms/POINT
100Hz	10.0ms/POINT
70Hz	14.0ms/POINT
50Hz	19.0ms/POINT
40Hz	26.1ms/POINT
30Hz	34.9ms/POINT
20Hz	50.1ms/POINT
15Hz	70.1ms/POINT
10Hz	99.3ms/POINT
7Hz	160.1ms/POINT
5Hz	249.7ms/POINT
4Hz	480.1ms/POINT
3Hz	691.2ms/POINT

When the RBW is 15kHz, the attenuator AUTO Function does not operate.  
The attenuator setting is fixed to 25dB.

When IF RBW AUTO function is selected, the resolution bandwidth is not defined uniquely by the range of sweeping frequency. This automatically switches the resolution bandwidth according to the frequency under sweeping.

When AUTO is set, the resolution bandwidth as the figure below is selected and is measured automatically corresponding to the frequency of the measurement point.

Measurement frequency	Bandwidth of resolution
10kHz to 13.5kHz	400Hz
13.5kHz to 18kHz	500Hz
18kHz to 23kHz	700Hz
23kHz to 30kHz	1kHz
30kHz to 45kHz	1.5kHz
45kHz to 70kHz	2kHz
100kHz to 135kHz	3kHz
135kHz to 180kHz	4kHz
180kHz to 230kHz	5kHz
230kHz to 300kHz	7kHz
300kHz to 150MHz	10kHz

When the auto function of bandwidth is selected, the bandwidth of resolution can not be set to 15kHz.

4.4 RESPONSE Block

**Note:** In the averaging function, the measured data are averaged with time weight before formatting it. Since vector quantity is averaged, there also is an effect that reduces the noise level.

The smoothing obtains the moving average between adjacent pieces of formatted data. Since scalar quantity is averaged, the noise width is reduced but the noise level will not be reduced.

- Averaging process

$$\bar{Y}(n) = \frac{n-1}{n} \times \bar{Y}(n-1) + \frac{1}{n} \times Y(n) \quad (n \leq N)$$

$$\bar{Y}(n) = \frac{N-1}{N} \times \bar{Y}(n-1) + \frac{1}{N} \times Y(n) \quad (n > N)$$

$\bar{Y}(n)$  : nth averaged data  
 $Y(n)$  : nth data not averaged yet  
 $N$  : Number of times for averaging

- Smoothing process

$$\bar{D}(n) = \frac{D(n-m) + \dots + D(n) + \dots + D(n+m)}{2m+1}$$

$\bar{D}(n)$  : nth format data already smoothed  
 $D(n)$  : nth format data not smoothed yet  
 $2m$  : Smoothing aperture

The aperture for the setting value is obtained using the following equation :

$$\text{Aperture } \langle 2m \rangle = \frac{(\text{measurement points}) - 1}{100} \times \langle \text{value} \rangle$$

That equation means that the aperture is set by the percentage for the number of the measurement points. Even if the number of the measurement points has been changed, the setting value of the aperture will be maintained and the aperture  $\langle 2m \rangle$  will be calculated again by the number of the measurement points after the change.

(Example)

Number of measurement points : 101 (Point)

$$\text{Aperture : 2 (\%)} \rightarrow \text{Aperture } (2m) = \frac{101 - 1}{100} \times 2 = 2$$

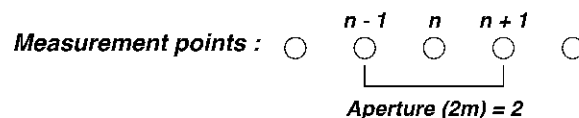



#### 4.4.9 Selecting the Input Attenuator and Input Preampifier

The input attenuator and input preampifier are selected. The attenuator is either 0 dB or 25 dB, while the preampifier is either 0 dB or 16 dB. These values determine the maximum value of the input power and the noise level. To set the measurement dynamic range to the maximum value, it is required that the values of the attenuator and preampifier are set to the optimum values according to the input power. The following combinations are possible between the input attenuator and preampifier values:

		Attenuator		
		AUTO (Note 2)	0dB	25dB
Preampifier	0dB	○	○	○
	16dB	× (Note 1)	○	× (Note 1)

**Note 1:** In this combination, the value which was set earlier has priority over a new value between the attenuator and the preampifier, and the lower priority value is forcibly set to 0 dB.

**Note 2:** To make the attenuator AUTO function operational, the following conditions must be met: an RBW setting lower than 15 kHz and a measurement frequency of 100 kHz or higher. If the RBW is 15 kHz or the measurement frequency is lower than 100 kHz, the attenuator setting is fixed internally to 25 dB.

Since the attenuator value is automatically set to an optimum value according to the input power when the attenuator is set to AUTO, the maximum dynamic range can be obtained. Typical values are as follows:

Attenuator	Preampifier	Maximum input power	Noise level	Dynamic range
0dB	16dB	-36dBm	-122dBm	86dB
0dB	0dB	-20dBm	-112dBm	92dB
25dB	0dB	+5dBm	-87dBm	92dB
AUTO	0dB	+5dBm	-112dBm	117dB

---

#### 4.4 RESPONSE Block

##### Operation procedure

① Press [FUNCTION] to call the input gain menu.

② Input gain menu

{Rch : ATT [ ]} : Calls the menu which selects the R input attenuator (See step ③).

{Rch : AMP 0dB/16dB} : Sets the R input preamplifier to 0 dB or 16 dB.

{Ach : ATT [ ]} : Calls the menu which selects the A input attenuator (see Note 1 and Step ③).

{Ach : AMP 0dB/16dB} : Sets the A input preamplifier to 0 dB or 16 dB (see Note 1).

{Bch : ATT [ ]} : Calls the menu which selects the B input attenuator (see Note 2 and Step ③).

{Bch : AMP 0dB/16dB} : Sets the B input preamplifier to 0 dB or 16 dB (see Note 2).

**Note 1: This menu is displayed only when Option 10 or 11 is installed.**

**Note 2: This menu is displayed only when Option 11 is installed.**

③ Attenuator selection menu

{INPUT ATT AUTO} : Automatically sets an optimum value (see Note 3).

{INPUT ATT 0dB} : Sets to 0dB.

{INPUT ATT 25dB} : Sets to 25dB.

**Note 3: To make the attenuator AUTO function operational, the following conditions must be met are: an RBW setting lower than 15 kHz and a measurement frequency of 100 kHz or higher.**

**If the RBW is 15 kHz or the measurement frequency is lower than 100 kHz, the attenuator setting is fixed internally at 25 dB.**

## 4.5 Calibration

There are five types of calibration methods to reduce the system errors, as follows:

- Normalizing ..... ① (See section 4.5.1.)
- 1-port full calibration ..... ② (See section 4.5.2.)
- Transmission full calibration ..... ③ (See section 4.5.3.)
- Averaging ..... ④ (See section 4.4.8.)
- Smoothing ..... ⑤ (See section 4.4.8.)

The methods of ①, ② and ③ are used to remove error factors which can be reproduced. These methods measure the standard whose real value has been known. The result is used to obtain the real value of the measurement according to the error model.

The methods of ④ and ⑤ are used to statistically reduce random errors by obtaining the time average and moving average respectively.

**Note:** *The calibration methods of ①, ② and ③ can not be performed simultaneously. Since the methods of ④ and ⑤ can be independently operated, they can be performed simultaneously.*

### 4.5.1 Normalizing

Calibrates the frequency characteristics of the magnitude and phase. This method can be easily performed but cannot obtain a high accuracy.

(1) For measuring transmission

Calibrates the frequency characteristics including that on the connection cable and connector by connecting the through standard with the condition where any sample is removed.

(2) For measuring reflection

An open standard or a short standard can be selected for the calibration standard. The frequency characteristics is calibrated in the reflection measurement by connecting the calibration standard.

Both the open standard and short standard are full reflection and the phase for the short standard is shifted by 180°.

For the open standard, make sure that the reflection measurement port is actually made open. For example, the calibration can be made when the measurement port is open (unloading condition) without the open standard for a calibrated N type connector.

However, if the open capacity is uncertain or if the open condition cannot be obtained because the measurement port is the line on the base board, the short standard should be used or the calibration should be made with the line made short.

4.5 Calibration

4.5.2 One Port Full Calibration

Calibrates the directivity, source match, and frequency tracking in the reflection measurement. This method highly accurately measures the reflection of a one port device or a two port device whose one end is terminated.

**Note:** Three kinds of calibration standards are required as follows:

- Open standard
- Short standard
- Load standard

The signal flow graph below shows the error model.

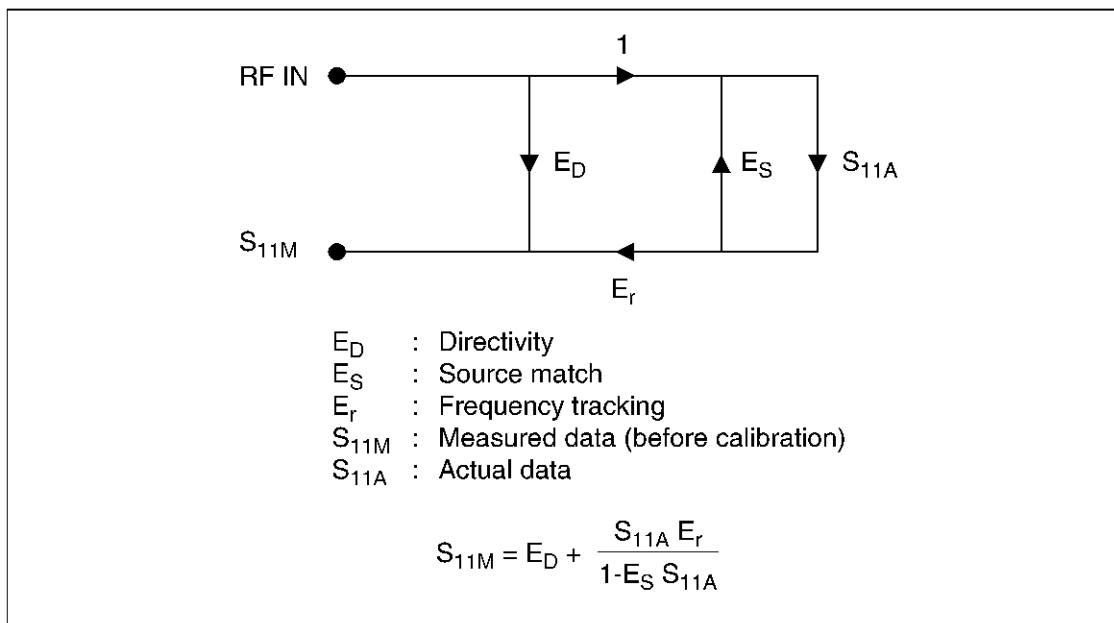

- Directivity : The directivity connector/bridge which is used for the reflection measurement detects the reflection signal from the sample device. However, it actually detects not only the reflection signal but also a few incidence signals. The limitation where the reflection signal and the incidence signal can be separated is called a “directivity”.
- Source match : The reflection signal from the sample device reflects at the signal source and is injected in the sample to make errors. The reflection coefficient at that signal source is called a “source match”.
- Frequency tracking : Is the frequency characteristics of the measurement system including the cable and connector.

### 4.5.3 Transmission Full Calibration

In transmission measurement, transmission full calibration brings higher accuracy measurement than transmission-line normalization.

This calibration can cancel errors caused by the measurement system including cables and the fixture.

Transmission parameter conversion would bring much more accuracy to the impedance measurement.

For calibration, the following standards are required.

- Short standard
- Load standard

### 4.5.4 Calibration Method

#### (1) Normalizing (transmission)

Operation procedure

- ① Setup the R3754 Series to the transmission measurement.
- ② Connect a through standard between the measurement ports.
- ③ Press the **[CAL]** to call the calibration menu.
- ④ Press the *{NORMALIZE (THRU)}*.  
The message "Wait for Sweep" is displayed and the calibration data are obtained. The calibration is completed when the message disappears. (Note)
- ⑤ Connects a sample to perform the measurement.

#### (2) Normalizing (reflection)

Operation procedure

- ① Setup the R3754 Series to the reflection measurement.
- ② Connect a open standard or a short standard to the measurement ports.
- ③ Press the **[CAL]** to call the calibration menu.
- ④ When the open standard is used, then press the *{NORMALIZE (THRU)}*.  
When the short standard is used, then press the *{NORMALIZE (SHORT)}*.  
The message "Wait for Sweep" is displayed and the calibration data are obtained. The calibration ends when the message disappears. (Note)
- ⑤ Connects a sample to perform the measurement.

**Note:** *Do not move the R3754 Series, the cable, the connector, the stand and others when the message is displayed.*

## 4.5 Calibration

### (3) 1-port full calibration

#### Operating procedure

- ① Sets the R3754 Series to the reflection measurement.
- ② Press the [CAL] to call the calibration menu.
- ③ Press the {CAL MENU} to call the full calibration selection menu.
- ④ Press the {1PORT FULL CAL} to select the 1-port full calibration selection menu, and call the 1-port full calibration menu.
- ⑤ Connect the open standard to the measurement port and press the {OPEN}.  
The message "Wait for Sweep" is displayed and the calibration data are obtained. The calibration is completed when the message disappears. (Note)
- ⑥ Connect the short standard to the measurement port and press the {SHORT}.  
The message "Wait for Sweep" is displayed and the calibration data are obtained. The calibration is completed when the message disappears. (Note)
- ⑦ Connect the load standard to the measurement port and press the {LOAD}.  
The message "Wait for Sweep" is displayed and the calibration data are obtained. The calibration is completed when the message disappears. (Note)
- ⑧ Press the {DONE 1-PORT} to complete the 1-port full calibration.
- ⑨ Connect a sample to perform the measurement.

**Note:** Do not move the R3754 Series, the cable, the connector, the standard and others when the message is displayed.

#### **CAUTION!**

1. *When calibration data has already been obtained, set the calibration setting to OFF and clear the data, then restart the calibration. The full calibration operation cannot be performed to prevent the calibration data loss by miss operation during the calibration or if the data existed. (See Section 4.5.8.)*
2. *Each calibration data can be obtained again before pressing the {DONE 1-PORT}.*
3. *When Option 72 is installed, you need an additional operation to call the calibration menu shown in step ② above. For details, see Section 5.3, "Three-terminal Resonator Measurement Function (Option 72)."*

## (4) Transmission full calibration

## Operation procedure

- ① Setting the R3754 Series for transmission measurement.
- ② Press [**CAL**] to call the calibration menu.
- ③ Press {*Z0 VALUE*} and enter the impedance of the load standard.
- ④ Press {*CAL MENU*} to call the calibration selection menu.
- ⑤ Press {*TRANS FULL CAL*} to select the transmission full calibration. The transmission full calibration menu is invoked.
- ⑥ Open the test port (by connecting nothing) and press {*OPEN*}.  
The R3754 Series shows the message, "Wait for Sweep" and starts to obtain calibration data. When the message disappears, the R3754 Series completes the data acquisition. (Note.)
- ⑦ Connect the Short standard to the test port and press {*SHORT*}.  
The R3754 Series shows the message, "Wait for Sweep" and starts to obtain calibration data. When the message disappears, the R3754 Series completes the data acquisition. (Note.)
- ⑧ Connect the Load standard to the test port and press {*LOAD*}.  
The R3754 Series shows the message, "Wait for Sweep" and starts to obtain calibration data. When the message disappears, the R3754 Series completes the data acquisition. (Note.)
- ⑨ Press {*DONE TRANS*} to complete the transmission full calibration.
- ⑩ Connect a test sample and start the measurement.

**Note:** *Do not move the R3754 Series, the cable, the connector, the standard and others when the message is displayed.*

**CAUTION!**

1. *When calibration data has already been obtained, set the calibration setting to OFF and clear the data, then restart the calibration. The full calibration operation cannot be performed to prevent the calibration data loss by miss operation during the calibration or if the data existed. (See section 4.5.8.)*
2. *Each calibration data can be obtained again before pressing the {DONE TRANS}.*
3. *When Option 72 is installed, you need an additional operation to call the calibration menu shown in step ② above. For details, see Section 5.3, "Three-terminal Resonator Measurement Function (Option 72)."*



4.5 Calibration

**4.5.5 Definition of Calibration Standard**

For transmission full calibration, the calibration standard values currently being used can be defined.

Operation procedure:

- ① Press the [CAL] to call the calibration menu.
- ② Press {MODIFY CAL KIT} to call the calibration standard definition menu.
- ③ Calibration standard definition menu

- {OPEN STD} : Defines the open standard values (Rs, Ls, Cp) which are used for transmission full calibration.
- {SHORT STD} : Defines the short standard values (Rs, Ls, Cp) which are used for transmission full calibration.
- {LOAD STD} : Defines the load standard values (Rs, Ls, Cp) which are used for transmission full calibration.
- {SAVE STD VALUE} : Stores the open, short and load standard values in the internal backup memory. When this operation has been performed, these input values are stored in the backup memory even if the spectrum analyzer power is turned OFF.

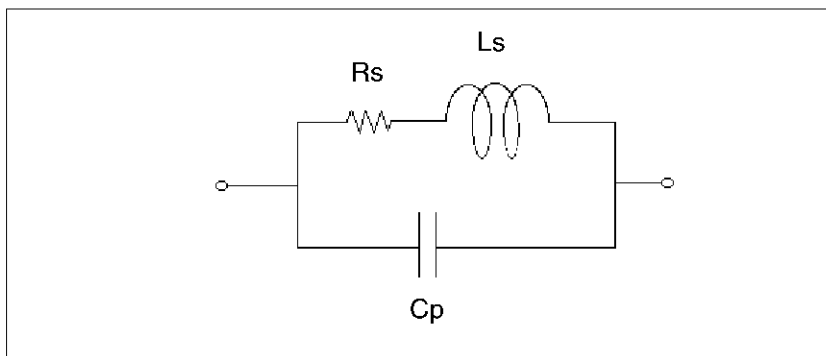

Figure 4-2 Calibration Standard Equivalent Circuit

Table 4-1 Factory settings

Type	Rs	Ls	Cp
OPEN	1GΩ	0H	0F
SHORT	0Ω	0H	0F
LOAD	50Ω	0H	0F

### 4.5.6 Interpolating Calibration Data

When the stimulus shown below is changed with {*INTERPOLATE ON/OFF*} is on, the calibration data is interpolated.

- Sweep range (to be calibrated)
- Sweep type (under constraints) (Note)
- Number of sweep points

**Note:** *Combinations of sweep types that can be interpolated.* (○: possible, ×: impossible)

Sweep type under calibration \ Current sweep type	Linear sweep	Logarithmic sweep	User sweep	Program sweep	Power sweep
Linear sweep	○	×	×	×	×
Logarithmic sweep	○	○	×	×	×
User sweep	○	×	×	×	×
Program sweep	○	×	×	×	×
Power sweep	○ *1	×	×	×	○ *2

\*1: A value sought as CW frequency among the calibration frequency range is used as calibration data of all points.  
\*2: When CW frequency is equal, calibration data is interpolated with the output level.

(Status signs)

Calibration status is shown on the side of the screen as follows.

Normal correction	"Cor"
Interpolated correction	"C?"
Abnormal correction	"C!"

Normal correction : All setting conditions are the same as that of the calibration.

Interpolated correction : Setting conditions differs from that of the calibration, however, are being interpolated.

Abnormal correction : Setting conditions differs from that of the calibration, and are not being interpolated. The last calibration data has been used.

#### **CAUTION!**

*When interpolation is impossible, when frequency range is out of calibrated range, or when "INTERPOLATE OFF" is set, "C!" is displayed. In this case, the last calibration data has been used. When the settings are changed as shown below, however, the correction becomes disabled. In this case, correction can not be enabled.*

(1) *The number of points is changed and the sweep range is changed out of the calibrated range.*

(2) *The combination, × shown in the last table is used.*

(3) *CW frequency is changed out of the calibrated range under \*1 of the last table.*

## 4.5 Calibration

## 4.5.7 Extending Measurement Reference Plane

Is the function which moves the calibration plane to the end of the cable when the extension cable is connected to the test port after calibration. The function calibrates the addition of the electrical length, assuming that the cable having no loss completely has been added. That is, it obtains the phase characteristics only for a sample by calibrating the phase shift for the addition.

- **Electrical length correction**  
Corrects the electrical length which has been set to the measurement data. The measurement port type is not identified. It can be used not only for correction but also measuring the electrical length of the cable. Also, it can be used to measure flatness of the phase by removing phase change due to the electrical length of the actual sample.

- **Port extension**  
Measurement is made, assuming that the extension cable with the electrical length already set is connected to the measurement port. That is, the electrical length already set is automatically calibrated according to the change of the measurement port. For example, if a calibration value 10ns is set to the port 1 and a value 20ns is set to the port 2 when S parameter test-set is used, the calibration is automatically made as follows:

For  $S_{11}$  measurement: (PORT 1)  $\times$  2 = 20ns

For  $S_{21}$  measurement: (PORT 1) + (PORT 2) = 30ns

- **Phase offset**  
This function does not calibrate the electrical length. It adds a constant phase value as an offset regardless of the frequency.
- **Phase Slope**  
This function corrects and displays slope of the data measured by phase measurement. The phase of the stop frequency is corrected by an input value with reference to the phase of the start frequency.
- **Velocity factor ( $V_f$ )**  
Sets the velocity factor value to be used to calculate the electrical length. The initial setting is  $V_f = 1$ .

$$V_f = \frac{1}{\sqrt{\epsilon_R}}$$

$$\begin{aligned} \text{Phase offset value/correction value } \Phi \text{ (deg)} &= \frac{L}{c} \times \frac{1}{V_f} \times f \times 360 \\ &= S \times f \times 360 \end{aligned}$$

- $V_f$  : Velocity factor
- $L$  : Electrical length (distance)
- $c$  : Light speed
- $S$  : Electrical length (time)
- $f$  : Frequency
- $\epsilon_R$  : Relative permittivity

### Operation procedure

The 1 of 2 and 2 of 2 in the calibration menu includes the menu with which the reference plane is extended.

- ① Press the **[CAL]** to call the calibration menu (1 of 2).

{PORT EXTENSION} : Calls the port extension menu. (See step ④.)

- ② Press the {More 1/2} to call the calibration menu (2 of 2).

- ③ Calibration menu (2 of 2)

{ELEC DELAY ON/OFF} : Selects ON/OFF of the electrical length correction.

{ELECTRICAL DELAY} : Sets the correction value for the electrical length in a unit of time.

{ELECTRICAL LENGTH} : Sets the correction value for the electrical length in a unit of distance.

{VELOCITY FACTOR} : Sets the velocity factor value.

{PHASE OFFSET VALUE} : Sets the phase offset value.

{PHASE SLOPE} : Sets the phase slope value.

- ④ Port extension menu

{EXTENSION ON/OFF} : Selects ON/OFF of the port extension.

{EXTENSION INPUT R} : Sets the value of the input port R extension by time.

{EXTENSION INPUT A} : Sets the value of the input port A extension by time.  
(Note 1)

{EXTENSION INPUT B} : Sets the value of the input port B extension by time.  
(Note 2)

**Note1:** This menu is displayed only when Option 10 or 11 is installed.

**Note2:** This menu is displayed only when Option 11 is installed.

## 4.5 Calibration

### 4.5.8 Calibration Data Clear

Once the calibration operation is executed, the {*CORRECT ON/OFF*} which indicates the calibration being executed is set to ON. For re-calibration, the calibration data must be cleared.

**Note:** *The re-calibration operations differs between the normalize and the full calibration.*

(1) For normalize

Whether calibrated or not, the data is re-calibrated by pressing the {*NORMALIZE*}.

**Note:** *The normalize calibration data is overwritten by the re-calibration operation so that the function for clearing the calibration data is not provided.*

(2) For full calibration

If the full-port calibration data has already existed, whether the calibration is effective or not, the re-calibration cannot be executed. To re-calibrate the data, clear the data.

The calibration data cannot be cleared during calibration being effective to prevent miss operation.

#### Operation procedure

- ① Press the [**CAL**] to call the calibration menu.
- ② Sets the {*CORRECT ON/OFF*} to OFF.
- ③ Press the {*CAL MENUS*} to call the full-calibration selection menu.
- ④ Press the {*CLEAR CAL DATA*} to clear the calibration data.
- ⑤ Select any one of 1-port/2-port full calibration and enter the calibration operation.

#### **CAUTION!**

*If the {*CORRECT ON/OFF*} is set to OFF, unless the calibration data is not cleared, the calibration can be set to ON again.*

## 4.6 Marker Function

The value of the data displayed can be read out with the marker. Also, the marker can find out the maximum or minimum value and change the settings of the signal source and the display.

Up to ten markers can be set for each channel and one of them is set to the active marker. The change of the marker setting is made to the active marker. The values on active marker is displayed on the screen. Also, the marker list function can display all the values on other markers than the active marker at the same time.

**[MKR]** : Calls a marker menu to set a marker.

**[MKR →]** : Calls a marker search menu for a marker analysis.

An active marker and a normal marker are shown in the following.

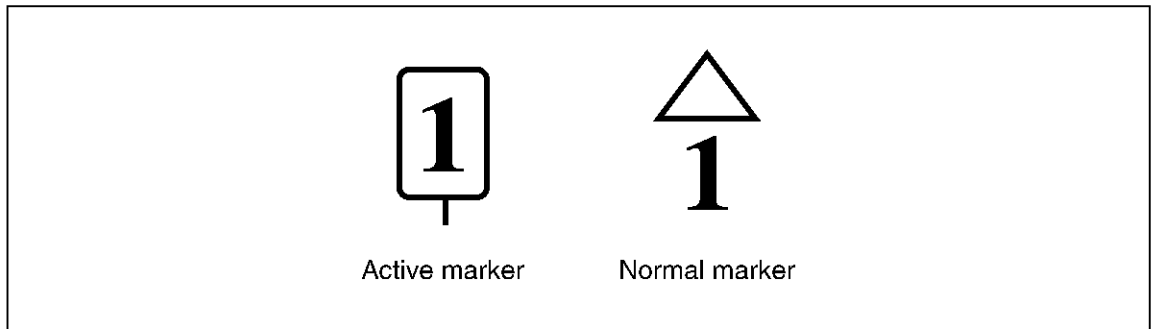

## 4.6 Marker Function

### 4.6.1 Setting Marker

Up to ten markers can be set for each channel and the marker which is displayed at the marker area on the screen is called an “active marker”.

This function sets the active marker or changes the marker already set.

#### Operation procedure

- ① Press the **[MKR]** to call the marker menu.
- ② Press the *{ACTIVATE MARKER [ ]}* to call the active marker menu.
- ③ Active marker menu
  - Active marker menu (1 of 2)
    - {MARKER 1}* : Sets the marker 1 for the active marker.
    - {MARKER 2}* : Sets the marker 2 for the active marker.
    - {MARKER 3}* : Sets the marker 3 for the active marker.
    - {MARKER 4}* : Sets the marker 4 for the active marker.
    - {MARKER 5}* : Sets the marker 5 for the active marker.
    - {ACTIVATE MKR OFF}* : Sets off only the active marker.  
If plural markers are set, a marker of the smallest number becomes an active marker.

Only when a marker frequency is displayed in the active area, its marker is controlled with the ten - key and the UP/DOWN key.

- Active marker menu (2 of 2)
  - {MARKER 6}* : Sets the marker 6 for the active marker.
  - {MARKER 7}* : Sets the marker 7 for the active marker.
  - {MARKER 8}* : Sets the marker 8 for the active marker.
  - {MARKER 9}* : Sets the marker 9 for the active marker.
  - {MARKER 10}* : Sets the marker 10 for the active marker.
  - {ACTIVATE MKR OFF}* : Sets off only the active marker.



### 4.6.2 Marker Coupling between Channels

The R3754 Series has two channels. The function is used to select if the markers are interlocked between the channels or not.

“Marker interlock between channels” means that the marker which has been set for the active channel is automatically set for the non-active channel regardless of ON/OFF of the dual channel display. “Non-interlock” means that the markers are made to independently operate for each channel.

Operation procedure

- ① Press the [MKR] to call the marker menu.
- ② Press the {MARKER MODE MENU} to call the marker mode menu.
- ③ Press the {MKR CPL/UNCPL} to select the marker coupling between the channels.
  - CPL : Coupling ON (interlock between channels)
  - UNCPL : Coupling OFF (non interlock between channels)

If sweep type satisfies the following conditions, even if the MKR CPL is specified, a marker is not coupled.

- When the sweep type of either of CH1/2 is set to the USER SWEEP or the PROG SWEEP.
- When both a frequency sweep and a level sweep are set simultaneously.

<For MKR UNCPL>

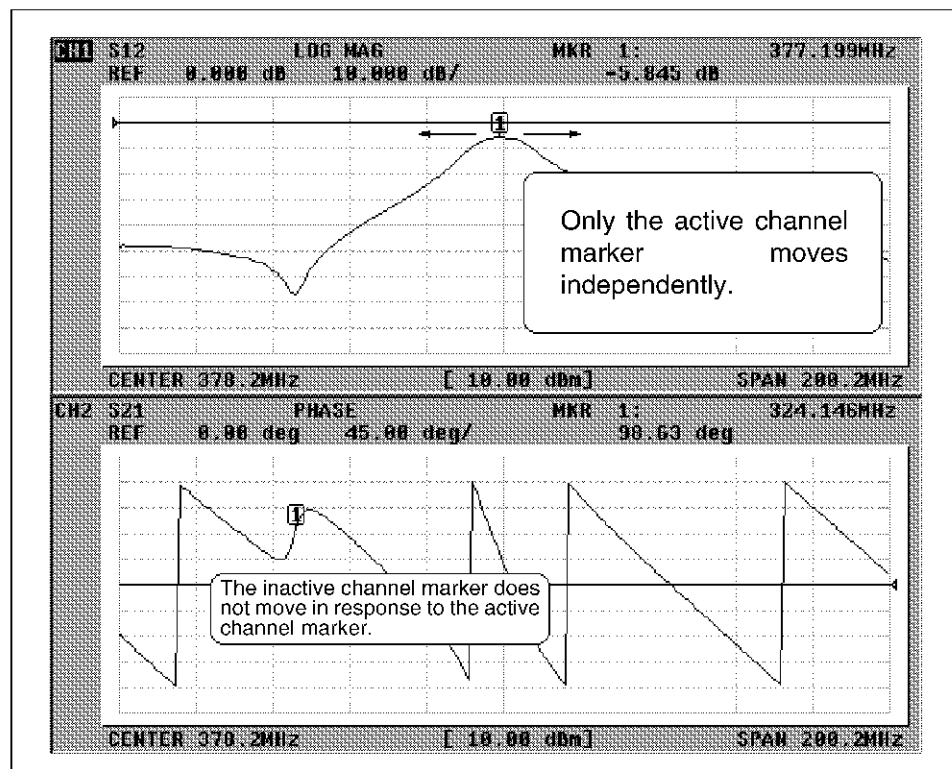

4.6 Marker Function

<For MKR CPL>

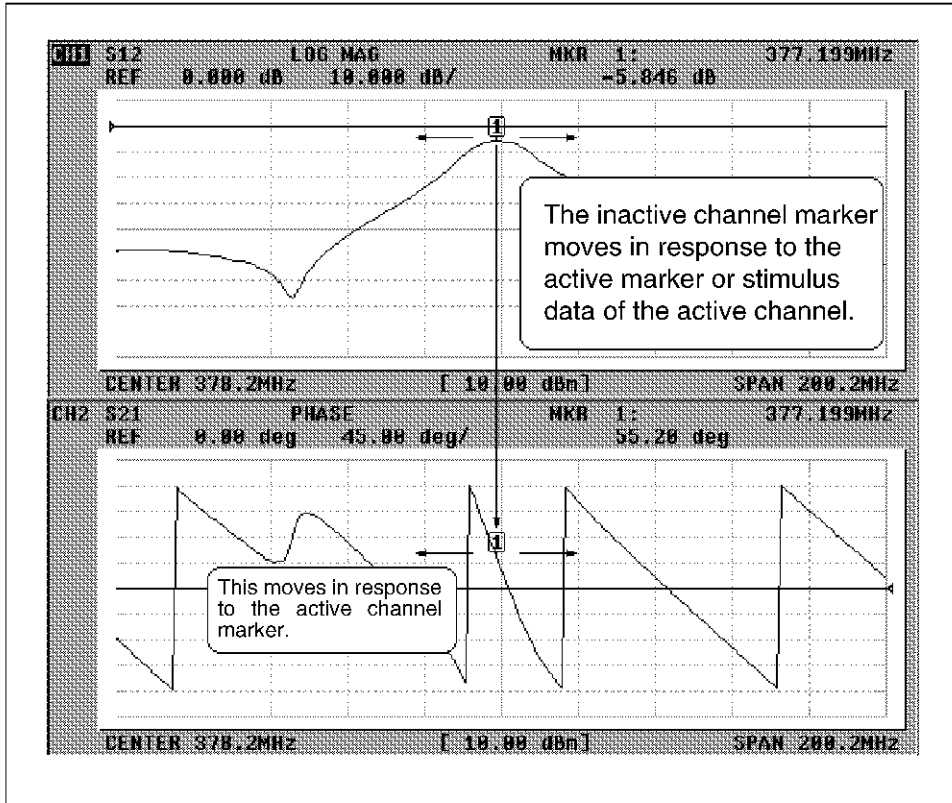

### 4.6.3 Interpolation Between Measurement Points

The marker can be assigned to either of one mode that sets markers and reads data of each marker by interpolating linearly between measurement points and another mode that sets markers to only actual measurement points.

Operation procedure

- ① Press the **[MKR]** to call the marker menu.
- ② Press the *{MARKER MODE MENU}* to call the marker mode menu.
- ③ Interpolation between measurement points is selected by *{MKR CMP/UNCMP}*.

CMP : Interpolation (compensation) ON

UNCMP : Interpolation (compensation) OFF

When the sweep type is set to USER SWEEP/PROG SWEEP, even if CMP is selected, the interpolation possibly don't work depending on the number of set points.

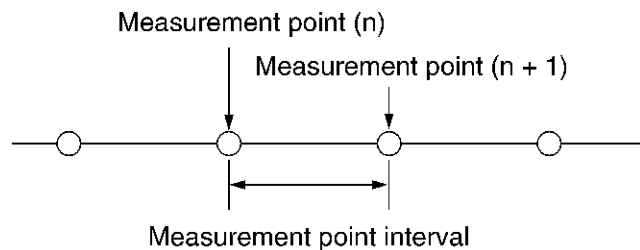

### 4.6.4 Displaying Marker Read out Value

The marker value displayed on the screen always indicates the active marker. To display other than that marker, use the marker list function to list all set markers at a time.

Operation procedure

- ① Press the **[MKR]** to call the marker menu.
- ② Press the *{MKR LIST ON/OFF}* to select ON/OFF of the marker list display.

4.6 Marker Function

4.6.5 Delta-Marker Function

The delta-marker function is used to find out the difference between the active marker and the specified marker. Three kinds of modes are available depending on the marker to be specified, as follows:

- $\Delta$ MKR mode : Obtains the difference between the child marker and the active marker by setting the child marker to the position of the active marker. The difference between the current position and the previous position (child marker) can be obtained by moving the active marker.
- ACT MKR mode : Obtains the difference between the active marker and the other marker.
- FIXED MKR mode : Obtains the difference between the active marker and the fixed marker by freely setting the fixed marker regardless of the trace data. The fixed marker is set with the stimulus and response values. That is, the fixed marker is always fixed to the position of specified stimulus and response values regardless of the trace data.

The response values for the other markers including the child marker are on the trace data.

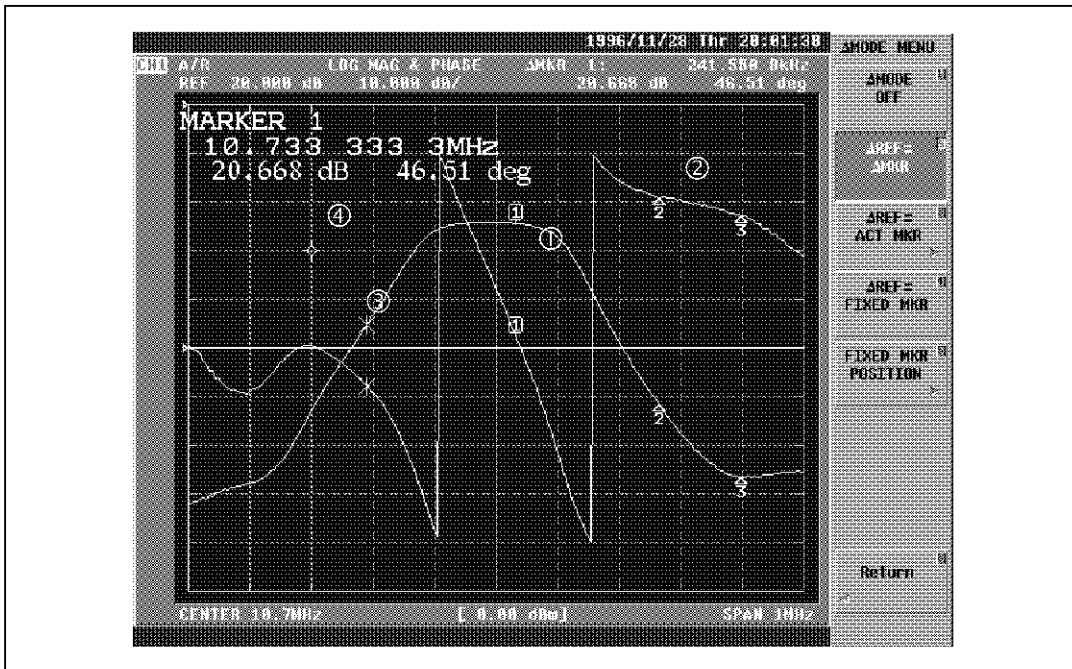

- $\Delta$ REF =  $\Delta$ MKR : The delta value of active marker ① and the child marker ③ is measured.
- $\Delta$ REF = ACT MKR : The delta values of active marker ① and compare marker ② is measured.
- $\Delta$ REF = FIXED MKR : The delta value of active marker ① and the Fixed marker ④ is measured.

## Operation procedure

- ① Press the **[MKR]** to call the marker menu.
- ② Press the  $\{\Delta MODE MENU\}$  to call the delta-mode menu.
- ③ Delta mode menu
 

$\{\Delta MODE OFF\}$	: Sets OFF the delta mode.
$\{\Delta REF = \Delta MKR\}$	: Selects the $\Delta MKR$ mode. (See step ④.)
$\{\Delta REF = ACT MKR\}$	: Selects the ACT MKR mode to call the ACT MKR menu. (See step ⑤.)
$\{\Delta REF = FIXED MKR\}$	: Selects the FIXED MKR mode.
$\{FIXED MKR POSITION\}$	: Calls the FIXED MKR setting menu. (See step ⑥.)
- ④ For  $\Delta MKR$  mode
 

Pressing the  $\{\Delta REF = \Delta MKR\}$  in step ③ causes the child marker (\*) to be displayed on the active marker position and the result to be displayed at the active area on the screen.

Since the active marker setting can be changed, obtain the data by moving the active marker using the data knob.
- ⑤ For ACT MKR mode
 

Pressing the  $\{\Delta REF = ACT MKR\}$  in step ③ calls the ACT MKR menu. Set the marker for comparison. Since the menu has also the key to change the active marker, it is possible to change the active marker without returning to the **[MKR]**.

  - ACT MKR menu (1 of 2)
 

$\{COMPARE MARKER 1\}$	: Changes the marker for comparison to the marker 1.
$\{COMPARE MARKER 2\}$	: Changes the marker for comparison to the marker 2.
$\{COMPARE MARKER 3\}$	: Changes the marker for comparison to the marker 3.
$\{COMPARE MARKER 4\}$	: Changes the marker for comparison to the marker 4.
$\{COMPARE MARKER 5\}$	: Changes the marker for comparison to the marker 5.
$\{ACTIVATE MARKER [ ]\}$	: Calls the active marker selection menu. (See section 4.6.1.)

4.6 Marker Function

- ACT MKR menu (2 of 2)
  - {COMPARE MARKER 6}* : Changes the marker for comparison to the marker 6.
  - {COMPARE MARKER 7}* : Changes the marker for comparison to the marker 7.
  - {COMPARE MARKER 8}* : Changes the marker for comparison to the marker 8.
  - {COMPARE MARKER 9}* : Changes the marker for comparison to the marker 9.
  - {COMPARE MARKER 10}* : Changes the marker for comparison to the marker 10.
  - {ACTIVATE MARKER [ ]}* : Calls the active marker selection menu. (See section 4.6.1.)

⑥ For FIXED MKR mode

Pressing the *{Δ REF = FIXED MKR}* in step ③ displays the difference between the active MKR and the FIXED MKR (◇) on the active area of the screen. To set the FIXED MKR position, press the *{FIXED MKR POSITION}* on the same menu to call the FIXED MKR setting menu.

- FIXED MKR setting menu
  - {FIXED MKR STIMULUS}* : Sets the FIXED MKR stimulus value.
  - {FIXED MKR VALUE}* : For the Smith chart and polar display, sets the FIXED MKR response value (real part).
  - {FIXED MKR AUX VALUE}* : For the Smith chart and polar display, sets the FIXED MKR response value (imaginary part).
  - {FIXED MKR → ACTIVE MKR}* : Sets the FIXED MKR to the active marker position.

If changing the stimulus reference value or others cause the fixed marker to move outside the screen, the fixed marker is not displayed.

The fixed marker can be displayed and set even if the delta mode is off.

If a parameter other than "1/S" has been set to CONVERSION ON in the measure or parameter conversion menu, the fixed marker can not be set nor displayed.

**Note:** *FIXED MKR STIMULUS/VALUE/AUX VALUE can be set only with the ten-key.*

#### 4.6.6 Marker Menu during Impedance Measurement

To read the impedance directly by the marker during parameter conversion or impedance measurement, the marker menu can be selected from three modes (parameter conversion, Smith chart display, or polar display).

- ① Press the **[MKR]** to call the marker menu.
- ② Press the *{MARKER MODE MENU}* to call the marker mode menu.
- ③ Marker mode menu

*{CONVERSION MKR MENU [ ]}*

: Calls the conversion marker menu which sets the marker data display mode during the parameter conversion. (See step ④.)

*{SMITH MKR MENU [ ]}* : Calls the Smith marker menu which sets the marker data display mode during the Smith chart display. (See step ⑤.)

*{POLAR MKR MENU [ ]}* : Calls the menu which sets the marker data display mode during the polar display. (See step ⑥.)

- ④ Conversion marker menu

*{DEFAULT}* : Displays the value corresponding to the data format.

*{LIN MKR}* : Displays the liner magnitude value and the phase value.  
When a format is selected except SMITH and POLAR in the format menu, if SMOOTHING is set to ON, a correct value can not be obtained.

*{Re/Im MKR}* : Displays the complex data.  
When a format is selected except SMITH and POLAR in the format menu, if SMOOTHING is set to ON, a correct value can not be obtained.



#### 4.6 Marker Function

⑤ Smith marker menu

- {LIN MKR}* : Displays the liner magnitude value and the phase value.
- {LOG MKR}* : Displays the logarithmic magnitude value and the phase value.
- {Re/Im MKR}* : Displays the complex data.
- {R+jX MKR}* : Displays the complex impedance.
- {G+jB MKR}* : Displays the complex admittance.
- {Z0 VALUE}* : Sets the characteristic impedance.

⑥ Polar marker menu

- {LIN MKR}* : Displays the liner magnitude value and the phase value.
- {LOG MKR}* : Displays the logarithmic magnitude value and the phase value.
- {Re/Im MKR}* : Displays the complex data.
- {Z0 VALUE}* : Sets the characteristic impedance.

### 4.6.7 Marker Analysis Function

The marker analysis function has the search functions for obtaining the values such as maximum value and minimum value.

This function also provide the functions to change the signal source and the display scale setting by the marker value.

The following items are provided for search functions:

- Maximum value
- Minimum value
- Phase : 0°
- Phase : ±180°
- Specified response value (amplitude, phase)
- Filter analysis (bandwidth, Q, shaping factor)

To perform the analysis operation, two modes are provided. Select any one of the mode for only one execution, or the mode for repeating every sweeping. The analysis area is selected the all measurement area, or the part search mode performing within the area specified by the marker delta mode.

**CAUTION!**

*Even if a parameter other than "1/S" is set in the parameter conversion menu and also "LIN MKR, Re/Im MKR" is set in the conversion marker menu, data specified in the format menu is searched. (However, for a smith chart and a polar display, LOG MAG type of data is searched.)*

Operation procedure

- ① Press the [MKR →] to call the marker search menu.
- ② Marker search menu (This menu is used to change the signal source or the display scale.)

{MARKER → START}	: Changes the sweep-start value of the signal source to the active marker position.
{MARKER → STOP}	: Changes the sweep-stop value of the signal source to the active marker position.
{MARKER → CENTER}	: Changes the sweep-center value of the signal source to the active marker position.
{ΔMARKER → SPAN}	: Changes the span of the signal source to the area specified by the Δ MARKER.
{MARKER → REF. VALUE}	: Changes the reference value of the display scale to the response value of the active marker.
{PART SRCH [ ]}	: Calls the part search menu. (See step ⑧.)
{MKR SARCH [ ]}	: Calls the search menu. (See step ③.)

#### 4.6 Marker Function

##### ③ Search menu

- {MKR SEARCH OFF}* : The search function is released.
- {MAX}* : Moves the active marker to the maximum value position.  
If SMITH or POLAR is set in the format menu, the active marker moves to the maximum value position of LOG MAG type of data.  
However, if SMOOTHING is set to ON, the active marker does not move to a correct data.
- {MIN}* : Moves the active marker to the minimum value position.  
If SMITH or POLAR is set in the format menu, the active marker moves to the minimum value position of LOG MAG type of data.  
However, if SMOOTHING is set to ON, the active marker does not move to a correct data.
- {TARGET}* : Calls the target menu which searches the specified value. (See step ④.)
- {RIPPLE}* : Calls the ripple menu which searches the ripple. (See step ⑤.)
- {FLTR ANAL}* : Calls the filter analysis menu. (See step ⑥.)
- {TRACKING ON/OFF}* : Selects the function for searching every sweep.  
OFF : Searches one time.  
ON : Searches every sweep. When ON is selected, the search is performed on the search menu, and the search is repeated/ executed every sweep.

## ④ Target menu

- {TARGET VALUE}* : Searches the specified value (response value).  
If SMITH or POLAR is set in the format menu, LOG MAG type of data is searched as TARGET VALUE.  
However, if SMOOTHING is set to ON, the active marker does not move to a correct data.
- {0°}* : Searches the phase 0°.  
The phase data is surely searched without regard to any format.  
if SMOOTHING is set to ON, the active marker does not move to a correct data.
- {±180°}* : Searches the phase 180°.  
The phase data is surely searched without regard to any format.  
if SMOOTHING is set to ON, the active marker does not move to a correct data.
- {LEFT SEARCH}* : Searches specified value of left side from current marker position.
- {RIGHT SEARCH}* : Searches specified value of right side from current marker position.

**Note:** *TARGET VALUE can be specified only with the ten-key.*

4.6 Marker Function

⑤ Ripple menu

- $\{MAX\ n\}$  : Searches for the maximum of local maximum peak values.  
(Note)
- $\{MIN\ U\}$  : Searches for the minimum of local minimum peak values.  
(Note)
- $\{\Delta MAX\ n-MIN\ U\}$  : Calculates the difference between the maximum of local maximum peak values and the minimum of local minimum peak values.  
Moves the active marker to the position of the maximum of local maximum peak values and moves the delta marker (other than FIXED MKR) to the position of the minimum of local minimum peak values.

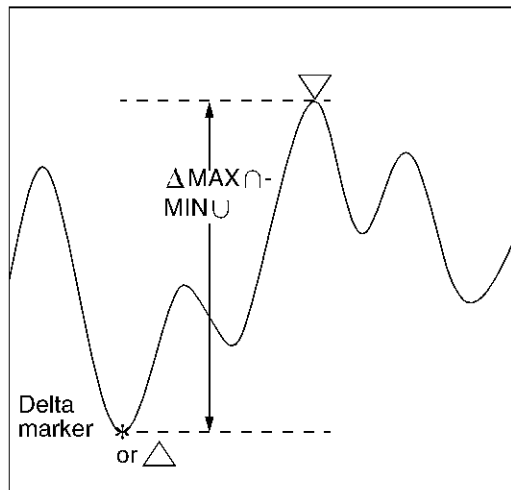

- $\{MAX-MIN\}$  : Calculates the difference between a maximum value and a minimum value.  
Moves the active marker to the position of the maximum of local maximum peak values and moves the delta marker (other than FIXED MKR) to the position of the minimum peak values.
- $\{\Delta X\}$  : Specifies the detecting sensitivity for the ripple search.  
The differential coefficient  $\Delta X$  is specified here.  
Specify a ratio, regarding the full scale of the horizontal axis as 100%.
- $\{\Delta Y\}$  : Specifies the detecting sensitivity for the ripple search.  
The differential coefficient  $\Delta Y$  is specified here.  
\*  $\Delta X$  and  $\Delta Y$  are specified only with the ten-key.

**Note:** If SMITH or POLAR is set in the format menu, LOG MAG type of data is searched. However, if SMOOTHING is set to ON, a correct data cannot be searched.

How to obtain ripple (local maximum peak value)

To obtain ripple value under the detecting sensitivity  $\Delta Y/\Delta X$ , search for a point (a) where the gradient (Y/X) of the waveform is larger than  $\Delta Y/\Delta X$ .

Next, search a point (d) where the reverse gradient (Y/X) of the waveform is larger than  $\Delta Y/\Delta X$ . Then the maximum value between (a) and (d) is obtained as a local maximum peak value.

A local minimum peak value can be obtained by reversing the polarity of  $\Delta Y/\Delta X$  in the above procedure.

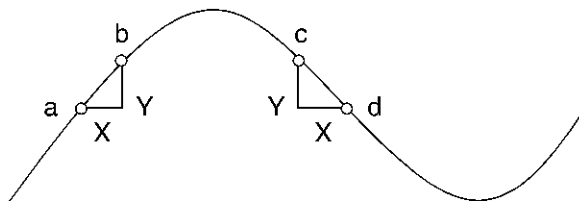

#### ⑥ Filter analysis menu

- {WIDTH VALUE}* : Specifies the maximum loss when determining the pass band. Specifies the loss (X dB) from the level reference point.
- {FILTER TYPE BAND/NOTC}* : Selects the filter type.  
 BAND : Analyzes a band pass filter.  
 NOTC : Analyzes a notch filter.
- {SEARCH FROM [ ]}* : To the search reference menu.
- {DISPLAY MODE ABS/REL}* : Selects the way in which the bandwidth is displayed.  
 ABS : Displays the bandwidth using two absolute values ( i.e., the lower and higher frequencies).  
 REL : Displays the bandwidth relative to the center frequency.
- {SEARCH IN/OUT}* : Selects the direction to be searched on the stimulus axis.  
 IN : Searches outward from the search reference point.  
 OUT : Searches inward to the reference point.
- {FILTER ANAL ON/OFF}* : Turns the measurement and its result display ON or OFF. When ON, this function starts the measurement and displays the result.  
 C.F : Displays the center frequency of the bandwidth specified by the loss (X dB) from the level reference point.  
 L.F : In ABS mode, this displays the left frequency of the bandwidth (the low frequency pointed by the ↑ marker).  
 In REL mode, this displays the difference

4.6 Marker Function

between the left frequency of the bandwidth and the center frequency.

R.F : In ABS mode, this displays the right frequency of the bandwidth (the high frequency pointed by the ↑ marker).  
In REL mode, this displays the difference between the right frequency of the bandwidth and the center frequency.

BW : Bandwidth  
Q : Q factor  
SF : Shaping factor

**Note:** When the format type is set except LOG MAG, MAG&PHASE/LOG, and MAG&DELAY, if SMOOTHING is set to ON, a correct data cannot be searched.

⑦ Search reference menu

Selects the reference point when analyzing filters (Note 1).

{ACTIVE MARKER} : Makes the active marker the level reference point.

{MAXIMUM VALUE} : Makes the minimum loss point the level reference point.

{REFERENCE LINE} : Makes the reference line the level reference point (Note 2).

**Note 1:** Each search reference (which is composed of the stimulus axis and the level axis) specified by the search reference menu is as follows:

	MAX reference		Active marker		Reference line	
	Stimulus axis	Level axis	Stimulus axis	Level axis	Stimulus axis	Level axis
Band pass filter analysis	Active Mkr	MAX	Active Mkr	Active Mkr	Active Mkr	Ref Line
Notch filter analysis	Active Mkr	MAX	MIN	Active Mkr	Active Mkr	Ref Line

MAX : Minimum loss point/MIN : Maximum loss point/Active Mkr : Active marker/  
Ref Line : Reference line

For example, when MAX reference has been selected for a band pass filter analysis, the search reference point on the stimulus axis is the Active marker; the search reference point on the level axis is the MAX (the minimum loss point).

**Note 2:** The Reference Line reference can be selected only when the FORMAT is specified as LOG MAG, LOG MAG&PHASE or LOG MAG&DELAY.



<Examples of the result of filter analysis>

Q factor is calculated from a bandwidth B.W' where data is 3dB off a minimum loss value of the measured data, and the center frequency C.F' in the bandwidth B.W'.

$$Q = \frac{C.F'}{B.W'}$$

Shaping factor is calculated from a bandwidth B.W' where data is 3dB off minimum loss value of the measured data, and a bandwidth B.W'' where data is 60dB off the minimum loss value.

$$S.F = \frac{B.W''}{B.W'}$$

The stimulus and level reference points used to calculate the Q and Shaping factors are unaffected regardless of the level reference points which are set by the {SEARCH FROM [ ]} key.

	Stimulus reference	Level reference
Band pass filter analysis	MAX	MAX
Notch filter analysis	MIN	MAX

Analysis methods for each setting are described as follows:

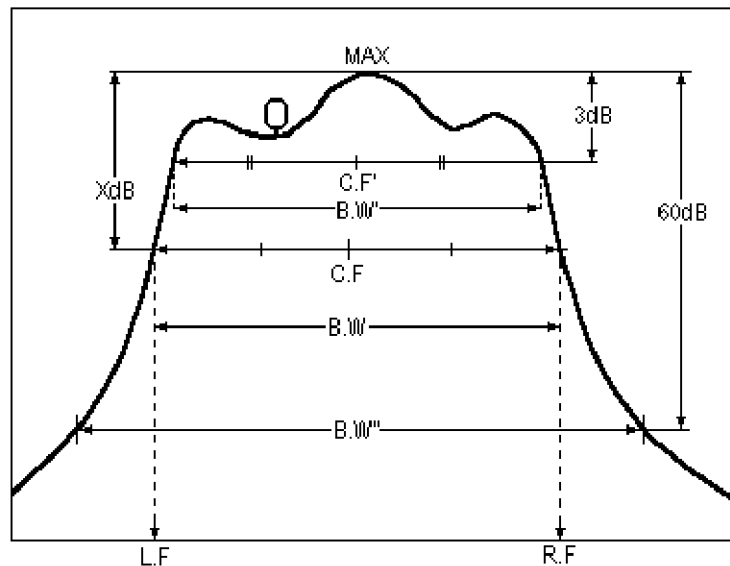

Figure 4-3 Band Pass Filter Analysis/MAX Reference

4.6 Marker Function

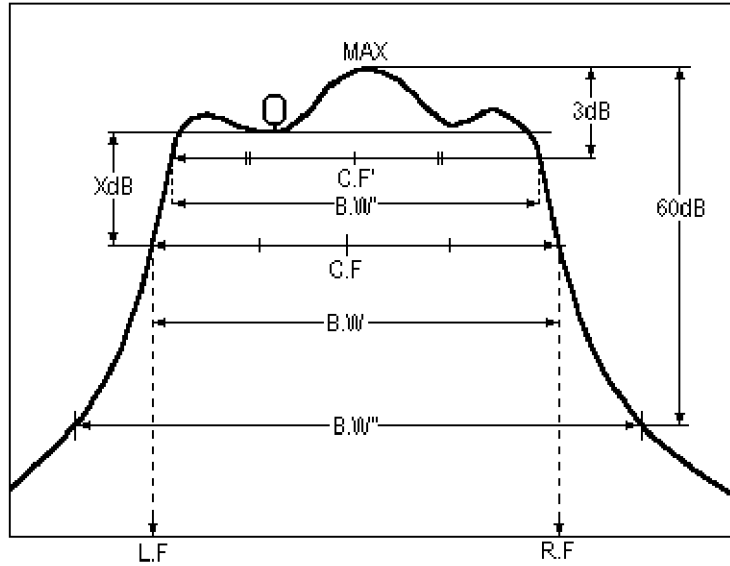

Figure 4-4 Band Pass Filter Analysis/Active Marker Reference

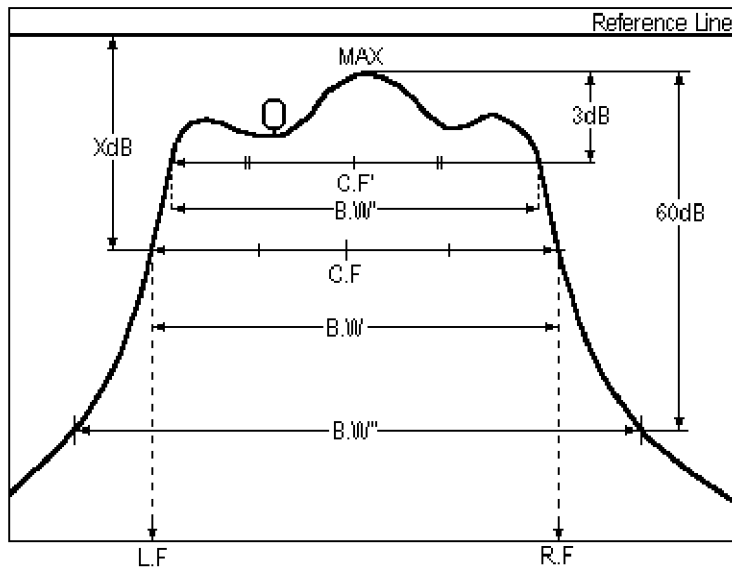

Figure 4-5 Band Pass Filter Analysis/Reference Line Reference

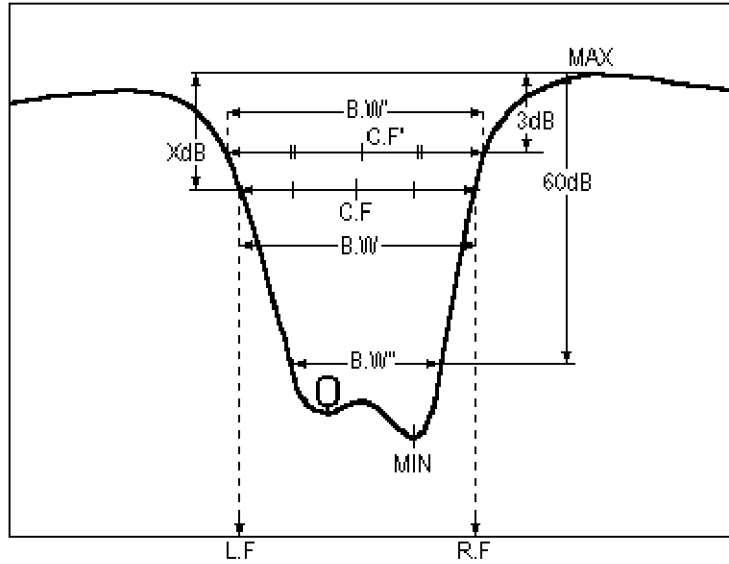

Figure 4-6 Notch Filter Analysis/MAX Reference

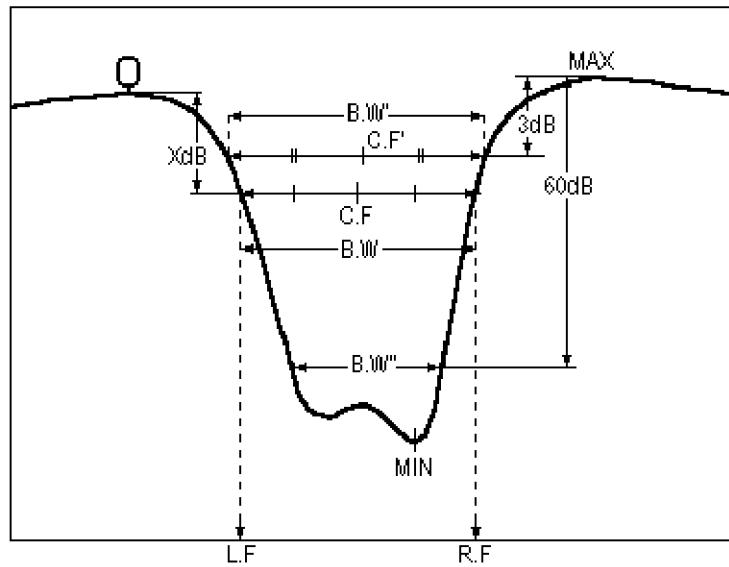

Figure 4-7 Notch Filter Analysis/Active Marker Reference

4.6 Marker Function

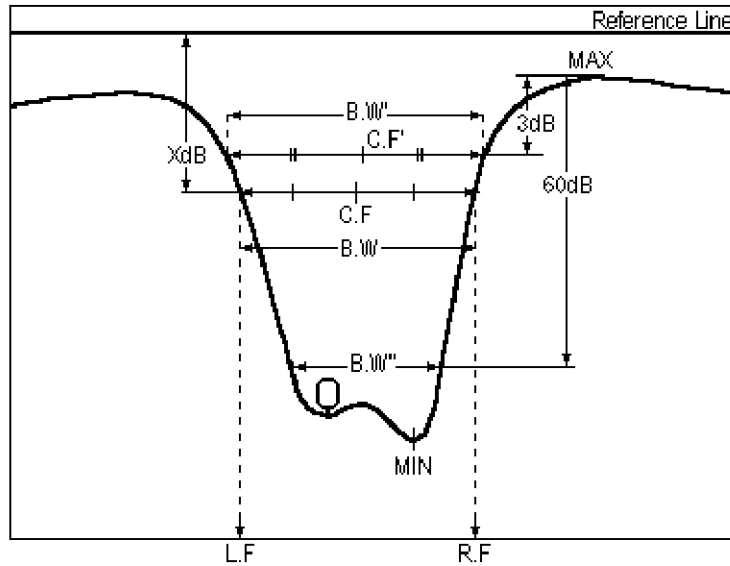
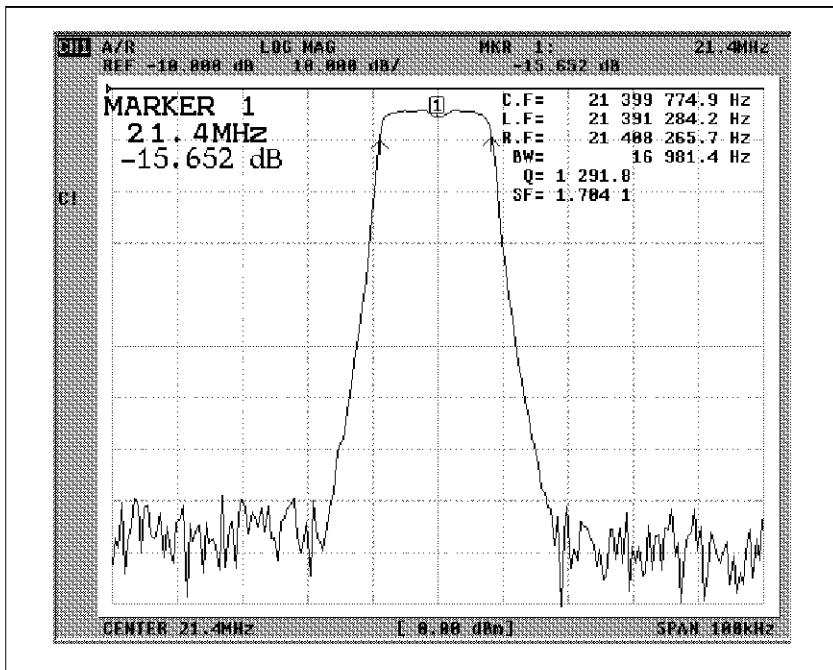

Figure 4-8 Notch Filter Analysis/Reference Line Reference

<Example of filter analysis execution>



- ⑧ Part search menu (This menu is used to search specified area instead of the whole measurement area for the analysis to obtain the maximum value, minimum value and so on.)

- { $\Delta$  MODE MENU} : Calls the  $\Delta$  marker mode menu. (See section 4.6.5.)
- {SET RANGE} : Sets partially search range which was set at  $\Delta$  marker mode.
- {STATISTICS ON/OFF} : Sets the statistical analysis function.  
The statistical analysis function calculates the average, standard deviation and peak to peak for the range specified by the part search (for the entire measurement range when the part search is turned OFF). The measurement result will be displayed on the right of the measurement screen.
- {PART SRCH ON/OFF} : Selects ON/OFF of the part search.  
ON : Part search  
OFF : All search

Measurement example by MAX search

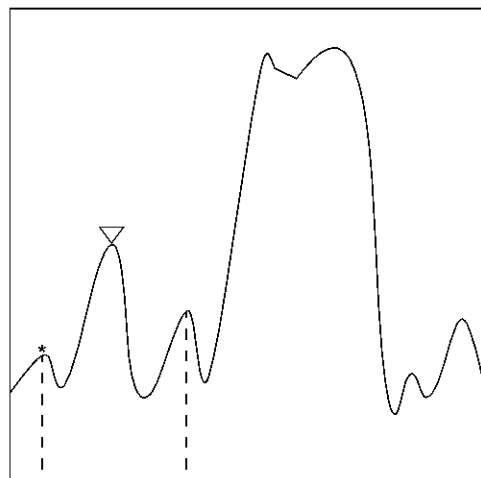

A range specified with  $\Delta$  marker.

At OFF

Searches a maximum response value within measurement frequency.

At ON

Set a range specified with  $\Delta$  marker as a partial search range with SET RANGE. Then set PART SRCH to ON and a marker begins to search the maximum value in the set range.

## 4.7 Sweep

### 4.7 Sweep

The following five types are provided for sweeping the signal source.

- Linear frequency sweep : The frequency sweep between measurement points is performed in equal steps linearly.
- Log (logarithmic) frequency sweep : The frequency sweep between measurement points is performed in logarithmic step.
- User frequency sweep : By the user frequency sweep, measurement points are divided into maximum 30 segments, and frequency range is set to each segment.  
For example, if the segments are set in the stop area, pass area, twofold pass area of the band pass filter, then high data throughput can be obtained because of no sweeping in unnecessary area.
- Program sweep : By the program sweep, measurement points are divided into maximum 30 segments, and frequency range is set to each segment.  
Other than frequency, the output level, receiver section resolution bandwidth, settling time, and attenuator can be set in every segments. The optimum sweep condition can be set, including throughput and dynamic range.
- Power sweep : The power sweep is used for level characteristic measurement.

#### 4.7.1 Setting Sweep Type

Operation procedure

- ① Press the **[MENU]** to call the signal source menu.
- ② Press the **{SWEEP TYPE [ ]}** to call the sweep type menu.
- ③ Sweep type menu

<b>{LIN FREQ}</b>	: Sets to the liner frequency sweep.
<b>{LOG FREQ}</b>	: Sets to the log (logarithmic) frequency sweep.
<b>{USER SWEEP}</b>	: Sets to the user frequency sweep.
<b>{PROGRAM SWEEP}</b>	: Sets to the program sweep.
<b>{POW SWEEP}</b>	: Sets to the power sweep.
<b>{EDIT USER SWEEP}</b>	: Calls the segment editing menu of the user frequency sweep. (See section 4.7.2.)
<b>{EDIT PROG SWEEP}</b>	: Calls the segment editing menu of the program sweep. (See section 4.7.3.)

Sweep area settings for the linear frequency sweep, log frequency sweep and power sweep are performed with **[START]**, **[STOP]**, **[CENTER]** or **[SPAN]**.

For the user frequency sweep and program sweep, set the sweep area on each segment editing menu.

**CAUTION!**

*If USER SWEEP or PROGRAM SWEEP is set, input segments are detected and arranged internally in increasing order of frequency.*

*If STOP frequency of a segment is higher than START frequency of the next segment in the arranged segments, an error occurs.*

#### 4.7.2 Editing Segment of User Frequency Sweep

Operation procedure

- ① Press the **[MENU]** to call the signal source menu.
- ② Press the **{SWEEP TYPE [ ]}** to call the sweep type menu.
- ③ Press the **{EDIT USER SWEEP}** to call the user frequency sweep segment editing menu.
- ④ User frequency sweep segment editing menu

<b>{SEGMENT: NUMBER}</b>	: Specifies the segment number in the range of 0 to 63.
<b>{START}</b>	: Sets the start frequency of the specified segment.
<b>{STOP}</b>	: Sets the stop frequency of the specified segment.
<b>{FREQ}</b>	: Sets the frequency of the specified point when the number of points of the specified segment is set to 1. Reversely, if this frequency is set, then the number of points automatically becomes 1.
<b>{POINT}</b>	: Sets the number of points of the specified segment.
<b>{CLEAR SEG}</b>	: Clears the specified segment.
<b>{CLEAR ALL SEG}</b>	: Clears all segments.

**CAUTION!**

1. *If the same segment number is edited on the segment editing menu of the program sweep, then the user frequency segment is also changed. (Segment holds the program sweep in common.)*
2. *The total number of points of each segment by user frequency sweep cannot exceed 1201 points. (The maximum number of measurement points is 1201 points.)*



### 4.7.3 Editing Program Sweep Segments

#### Operation procedure

- ① Press the [MENU] to call the signal source menu.
- ② Press the {SWEEP TYPE [ ]} to call the sweep type menu.
- ③ Press the {EDIT PROG SWEEP} to call the program sweep segment editing menu.
- ④ Program sweep segment editing menu
  - Program sweep segment editing menu (1 of 2)
    - {SEGMENT: NUMBER} : Specifies the segment number in the range of 0 to 63.
    - {START} : Sets the start frequency of the specified segment.
    - {STOP} : Sets the stop frequency of the specified segment.
    - {POINT} : Sets the point number of the specified segment.
    - {CLEAR SEG} : Clears the specified segment.
    - {CLEAR ALL SEG} : Clears all segments.
  - Program sweep segment editing menu (2 of 2)
    - {SEGMENT: POWER} : Sets the output level for the specified segment.
    - {IF RBW} : Sets the receiver section resolution bandwidth for the specified segment.
    - {SETTLING TIME} : Sets the settling time for the specified segment.
    - {Rch INPUT [ ]} : Calls the menu which selects the R input attenuator and the R input preamplifier for the specified segment (see Step ⑤ ).  
(Note 3)
    - {Ach INPUT [ ]} : Calls the menu which selects the A input attenuator and the A input preamplifier of the specified segment (see Note 1 and Step ⑤ ).  
(Note 3)
    - {Bch INPUT [ ]} : Calls the menu which selects the B input attenuator and the B input preamplifier of the specified segment (see Note 2 and Step ⑤ ).  
(Note 3)

**Note 1:** This menu is displayed only when Option 10 or 11 is installed.

**Note 2:** This menu is displayed only when Option 11 is installed.

**Note 3:** The indications bracketed with [ ] are as follows:

Indication	Attenuator	Preamplifier
[+16dB]	0dB	16dB
[0dB]	0dB	0dB
[-25dB]	25dB	0dB
[AUTO}	AUTO	0dB

⑤ Program sweep segment editing menu

- {INPUT ATT AUTO} : Automatically sets the input attenuator to the optimum value for the current input power.
- {INPUT ATT 0dB} : Sets the input attenuator to 0 dB.
- {INPUT ATT 25dB} : Sets the input attenuator to 25 dB.
- {INPUT AMP 0dB/16dB} : Sets the input preamplifier to either 0 dB or 16 dB.

The following combinations are possible between the input attenuator and preamplifier values:

		Attenuator		
		AUTO (Note 2)	0dB	25dB
Preamplifier	0dB	○	○	○
	16dB	× (Note 1)	○	× (Note 1)

**Note 1:** In this combination, the previous value takes priority over new values, and the lower priority value is forcibly set to 0 dB.

**Note 2:** To make the attenuator AUTO function operational, the following conditions must be met: an RBW setting lower than 15 kHz and a measurement frequency of 100 kHz or higher.

If the RBW is 15 kHz or the measurement frequency is lower than 100 kHz, the attenuator setting is fixed internally at 25 dB.

**CAUTION!**

- If the same segment number is edited on the segment editing menu of the program sweep, then the user frequency segment is also changed. (Segment holds the program sweep in common.)
- The total number of points of each segment by program sweep cannot exceed 1201 points. (The maximum number of measurement points is 1201 points.)

4.7 Sweep

<Example of program sweep execution>

Here is an example how the program sweep is applied to the trace on the screen.

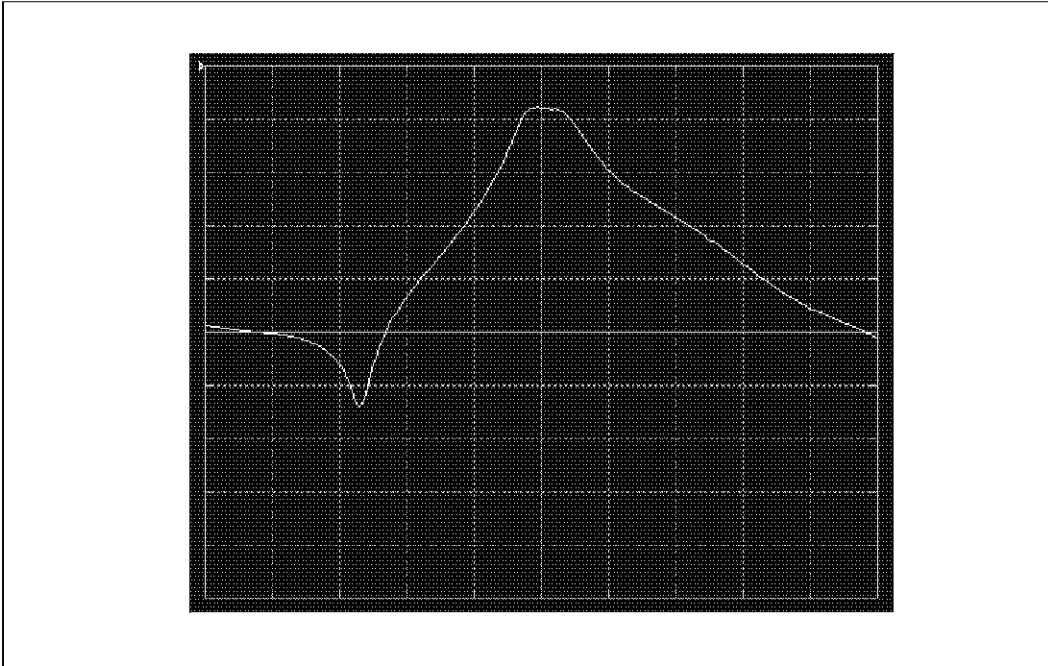

SEG	START	STOP	POWER	IF RBW	POINT
0	28.5MHz	34.5MHz	0.5dBm	1kHz	200
1	36.5MHz	40.5MHz	0.0dBm	10kHz	200
2	44.5MHz	48.5MHz	0.0dBm	10kHz	200

Each segment is edited as shown like the above-mentioned.

The result of execution is shown in the following.

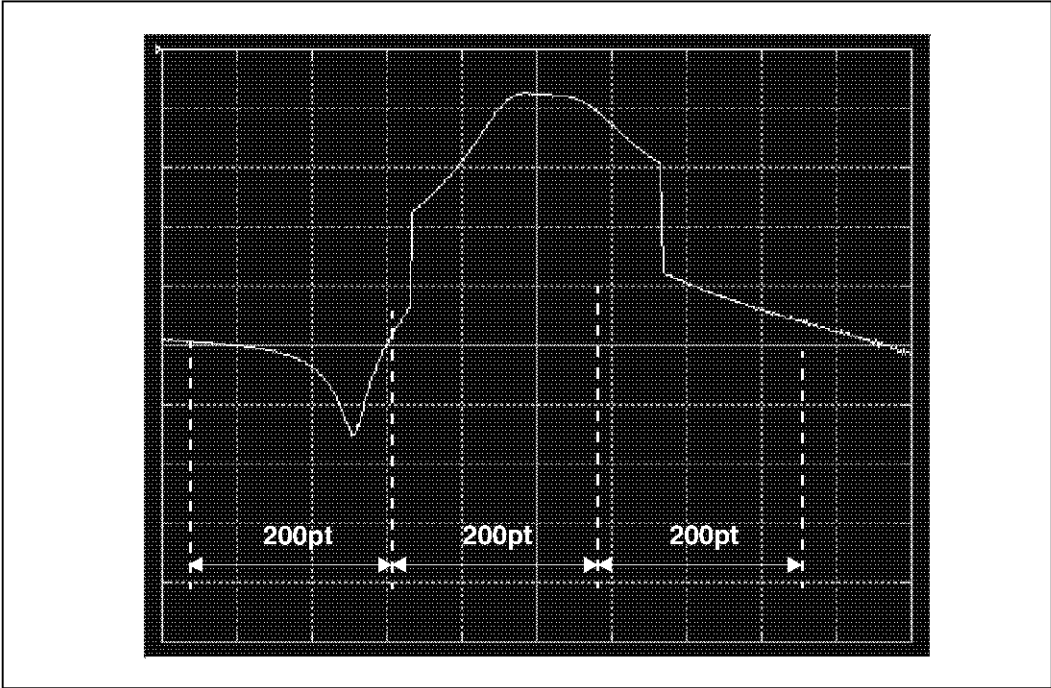

## 4.8 INSTRUMENT STATE Block

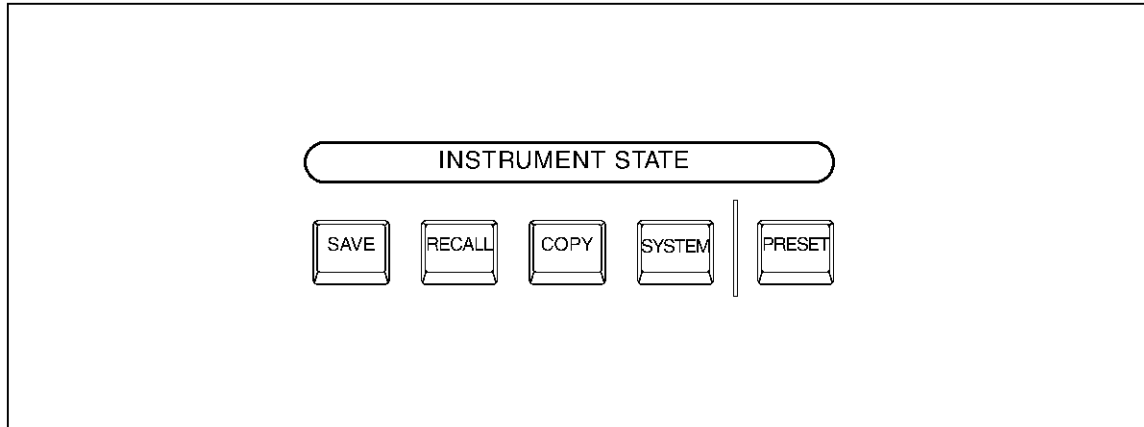

The INSTRUMENT STATE block is used to set the system control functions which have no concern with the measurement. The functions are provided such as a time/date set, limit-line test, save/recall, and hard copy.

- [SAVE]** : Calls the save menu to save such as a setting data and calibration data of the R3754 Series. (See section 4.10.)
- [RECALL]** : Calls the recall menu to recall such as a setting data and calibration data of the R3754 Series. (See section 4.10.)
- [COPY]** : Calls the copy menu to execute the hard copy of screen for a plotter/printer. (See section 4.11.)
- [SYSTEM]** : Calls the system menu to set such as an internal disk and date/time display. (See section 4.8.1.)
- [PRESET]** : Initializes the settings of the R3754 Series.

### 4.8.1 System Menu

#### Operation procedure

① Press the **[SYSTEM]** to call the system menu.

② System menu

*{SYSTEM DRIVE}* : Calls the system for selecting a drive to be used and format type of the disk. (See step ③.)

*{SET CLOCK}* : Calls the real-time clock menu for setting a date/time. (See step ⑥.)

*{LIMIT MENU}* : Calls the limit menu. (See section 4.8.2.)

*{FUNCTION}* : Calls the function menu. (See step ⑦.)

*{LCD CONTRAST[ ]}* : Sets LCD brightness.  
The brightness range is 0 to 100. The backlight, does not turn off even if the brightness is set to 0. Press **[BACK LIGHT]** and set the value indicated to turn off the backlight.

*{SERVICE MENU}* : Calls the service menu. (See step ⑧.)

③ System drive menu

*{DEFAULT DRIVE}* : Calls the default drive menu. (See step ④.)  
A drive selected on this menu is set as a current drive when power is turned on.

*{FORMAT TYPE}* : Calls the disk format menu for selecting a initialize format type. (See step ⑤.)

④ Default drive menu

*{A:}* : Select the drive A.  
Floppy disk drive

*{B:}* : Select the drive B.  
RAM disk drive (Without backup)

*{C:}* : Select the drive C.  
RAM disk drive (With backup)

*{D:}* : Select the drive D.  
ROM disk drive (Read only)

⑤ Disk format menu

*{1.2MB 8 SECTORS}* : Specifies the 1.2Mbyte 8 sectors per track when initializing a 2HD floppy disk. (Same as NEC PC98 series, 2HD floppy disk format)

*{1.2MB 15 SECTORS}* : Specifies the 1.2Mbyte 15 sectors per track when initializing a 2HD floppy disk. (Same as TOSHIBA J3100 series, 2HD floppy disk format)

---

4.8 INSTRUMENT STATE Block

*{1.44MB 18 SECTORS}* : Specifies the 1.44Mbyte 18 sectors per track when initializing a 2HD floppy disk. (Same as IBM PC series, 2HD floppy disk format)

⑥ Real-time clock menu

*{YEAR}* : Sets an year.

*{MONTH}* : Sets a month.

*{DAY}* : Sets a date.

*{HOUR}* : Sets an hour.

*{MINUTE}* : Sets a minute.

*{SECOND}* : Sets a second.

⑦ Function menu

*{CDMA IF FILTER}* : Calls the CDMA IF filter function menu (see section 4.8.3).

*{DIRECT ANALYSIS}* : Calls the direct analysis menu (see section 4.8.4).

⑧ Service menu

*{INTERNAL TEST}* : Calls up the self-diagnosis menu. Refer to the service manual for more information on the self-diagnosis. Contact the service representative or the nearest office to obtain the service manual.

*{SERVICE MODE}* : Calls the service mode menu.

*{SET KEYBOARD 101/106}* : Switches between the 101-type English keyboard and the 106-type Japanese keyboard.

*{FIRMWARE REVISION}* : Displays a version.

⑨ Service mode menu

*{INPUT CORR ON/OFF}* : Toggles the input correction on or off.



## 4.8.2 Limit Function

This function defines the segment for the measurement data, sets the upper limit and the lower limit for the segment, and judges pass/fail comparing with the data.

The limit can be set in each channel (CH1 and CH2) independently.

How to output the pass/fail judgement is as follows.

- PASS or FAIL is displayed on the screen.
- The beep can be set. When the limit test passes or fails, the beep sounds.
- Displays the trace in the Fail section with red.
- In the case of fail, sets Limit Fail Summary-Bit of Questionable Status Register.
- In the case of fail, set LOW Status on the parallel I/O port of the rear panel.

**Note:** *The parallel I/O is optional function.*

- Limit Menu

The setting and the explanation

- ① Press [**SYSTEM**] to call the system menu.
- ② Press {LIMIT MENU} to call the limit menu. (See step ③.)
- ③ Limit menu
  - {LIMIT LINE ON/OFF} : Selects ON or OFF in the display of limit line.  
When the limit line is set and this is in the state of ON, the limit line is displayed to compare the measurement data on the scale.  
The displays of the limit line are different depending on DISPLAY FORMAT and LIMIT TYPE of the segment.  
In the format of rectangular coordinate,  $\wedge$  and  $\vee$  marks or lines (straight lines or horizontal lines) are put between break points of each segment.  
In the polar coordinates, circle or straight line showing the angle is described.
  - {LIMIT TEST ON/OFF} : Selects ON/OFF of the limit test.  
Under the limit test ON, the limit values and the data set at each measurement point are compared.  
The limit test is performed when the data was updated during sweeping or after swept, or when the limit test was set to ON for the first time.
  - {BEEP [ ]} : Calls the beep mode menu and sets the beep for the limit test. (See step ④.)
  - {LIMIT MODE MENU} : Calls the limit mode menu to control the limit test mode and select the limit type of polar coordinate format. (See step ⑤.)
  - {EDIT LIMIT LINE} : Calls the edit limit menu (1 of 2) to display the list (Limit Table Window) of limit line segment in the lower half of the display to change the limit setting. (See step ⑥.)

---

4.8 INSTRUMENT STATE Block

*{SELECT DATA 1ST/2ND}*

: Switches the judgement parameter to operate.  
2 parameters per channel can be specified for the judgement parameter.  
In the display format of the rectangular coordinates, they corresponds to the first trace and the second trace.  
In the display format of polar coordinates, they corresponds to the judgement parameters selected in LIMIT MODE MENU.

*{LIMIT LINE OFFSETS}*: Calls the offset limit menu to adjust the stimulus value and the response value of the limit. (See step ⑪.)

④ Beep mode menu

*{OFF}* : Turns the beep off for the limit test.

*{FAIL}* : Sounds the beep when the limit test detects Fail.

*{PASS}* : Sounds the beep when the limit test detects Pass.

*{BEEP TONE}* : Selects the beep tone from 0 to 7.  
ZERO indicates the lowest tone and the beep tone is proportional to the numeric value of 0 to 7.

⑤ Limit mode menu

*{1ST DATA ON/OFF}* : Sets the first parameter ON/OFF.  
Judgement of the first parameter limit is performed when the LIMIT TEST is set to ON and also the 1ST DATA is set to ON.

*{2ND DATA ON/OFF}* : Sets the second parameter ON/OFF.  
Judgement of the second parameter limit is performed when the LIMIT TEST is set to ON and also the 2ND DATA is set to ON.  
But the judgement is not performed if effective 2nd trace data does not exist in the state the display format of polar coordinates selected.

*{MAG DATA LIN/LOG}* : The limit test of Smith chart and Polar display is judged with MAG and PHASE.  
Select whether this judgement is performed with LIN (linear scale) or LOG (logarithmic scale) of MAG DATA. (Default setting is LOG.)  
This soft menu is effective only when the format (See section 4.4.2.) is of Smith chart or polar display.

## ⑥ Edit limit menu (1 of 2)

- {SEGMENT}* : Selects a segment number to edit.  
 Up to 31 segments can be set with starting number 0.  
 Up to 7 segments can be displayed at a time and scroll-displayed on the Limit Table Window.  
 When no segment was set, 0 is displayed on the active area, and in other cases, the next number to the last specified segment is displayed.  
 But soon after the edit limit menu is called, the largest number of the set segments is displayed.  
 Also, the segment number is not updated after the last segment was set.
- {SELECT DATA 1ST/2ND}* : Switches the judgement parameter to operate.  
 2 parameters per channel can be specified for the judgement parameter.  
 In the display format of the rectangular coordinates, they corresponds to the first trace and the second trace.  
 In the display format of the polar coordinates, they corresponds to the judgement parameters selected in LIMIT MODE MENU.
- {EDIT SEGMENT}* : Calls the edit segment menu to set and change the stimulus value and upper/lower limit value of the specified segment. (See step ⑧.)  
 If the Limit Table is empty, the segment with initial setting is displayed.  
 Also, if an empty segment exists between the largest current set segment and the specified segment, the specified segment number is ignored.  
 In this case, the operation is the same as ADD SEGMENT soft key operation.
- {DELETE}* : Deletes the segment shown with cursor.  
 But if the specified segment is empty, this operation is ignored.
- {ADD SEGMENT}* : Calls the edit segment menu to add a new segment at the end of the Limit Table.
- {LIMIT TYPE}* : Calls the limit type menu to select current segment type selected with cursor. (See step ⑩.)
- {DONE}* : Sorts the input segments in ascending stimulus order and returns to the limit menu.  
 The updated limit becomes effective by pressing DONE soft key.
- {More 1/2}* : Calls the edit limit menu (2 of 2). (See step ⑦.)

4.8 INSTRUMENT STATE Block

⑦ Edit limit menu (2 of 2)

- {LIMIT LINE ON/OFF}* : Selects ON or OFF of the limit line display.  
 When the limit line is set and this is in the state of ON, the limit line is displayed to compare the measurement data on the scale.  
 The displays of the limit line are different depending on DISPLAY FORMAT and LIMIT TYPE of the segment.  
 In the format of rectangular coordinates,  $\wedge$  and  $\vee$  marks or lines (straight lines or horizontal lines) are put between the break points of each segment.  
 In polar coordinate, circle or straight line showing the angle is described.
- {LIMIT TEST ON/OFF}* : Selects ON/OFF of the limit test.  
 Under the limit line ON, the limit values and the data set at each measurement point are compared.  
 The limit test is performed when the data was updated during sweeping or after swept, or when the limit test was set to ON for the first time.
- {BEEP [ ]}* : Calls the beep mode menu to set the beep for the limit test. (See step ④.)
- {MAG DATA LIN/LOG}* : The limit test of Smith chart and polar display is judged with MAG and PHASE.  
 Select whether this judgement is performed with LIN (linear scale) or LOG (logarithmic scale). (Default setting is with LOG.)  
 This soft menu is effective only when the format (See section 4.4.2.) is of Smith chart or polar display.
- {LIMIT MODE MENU}* : Calls the limit mode menu to control the limit test mode and select the limit type of polar coordinates format. (See step ⑤.)
- {LIMIT LINE OFFSETS}* : Calls the offset limit menu to adjust the stimulus value and the response value of the limit. (See step ⑩.)
- {CLEAR LIST}* : Calls the clear limit menu to clear all the segments in the Limit Table. (See step ⑨.)

⑧ Edit segment menu

- {STIMULUS VALUE}* : Sets stimulus value of the segment with ENTRY block.
- {MARKER TO STIMULUS}* : Sets stimulus value of the segment to the active marker position.  
 Turning the data knob moves the active marker right and left.

- {UPPER LIMIT}* : Sets the upper limit value of the segment.  
It is necessary to set both values, upper limit and lower limit.  
If the upper limit value is not required, set an extreme large value for the upper limit value.  
Pressing UPPER LIMIT or LOWER LIMIT soft key changes limit values displayed on the screen into upper/lower expression, even if they are set with middle/delta values.  
If a value smaller than the lower limit is input for the upper limit value or the reverse, the same values are set for both the limit values.
- {LOWER LIMIT}* : Sets the lower limit value of the segment.  
It is necessary to set both values, upper limit and lower limit.  
If the lower limit value is not required, set an extreme small value for the lower limit value.
- {DELTA LIMIT}* : Sets the limit width of the segment.  
The limit range is expressed with the center value set by *{MIDDLE VALUE}*.  
For example, to set the pass area within  $-5\text{dB} \pm 3\text{dB}$ , enter  $-5\text{dB}$  as the center value and  $6\text{dB}$  as the delta value.  
Pressing MIDDLE LIMIT or DELTA LIMIT soft key changes limit values displayed on the screen into upper/lower expression, even if they are set with delta/middle values.
- {MIDDLE VALUE}* : Sets the middle value of DELTA LIMIT.
- {MARKER TO MIDDLE}* : Sets the middle value to the active marker position.
- ⑨ Clear limit menu
- {CLEAR LIST YES}* : Clears the Limit Table and returns to the edit limit menu.
- {CLEAR LIST NO}* : Returns to the edit limit menu without clearing the Limit Table.
- ⑩ Limit type menu
- {SLOPING LINE}* : Connects to the limit value of the next segment with a sloped line.  
For the final segment, horizontal lines are drawn to the largest point of stimulus.  
For the display format of polar coordinates, the limit value is fixed up to the next segment break point.  
In this case, the result is the same as flat line.  
The slope line segment is displayed with SLIN in the Limit Table.

4.8 INSTRUMENT STATE Block

- {FLAT LINE}* : Horizontal lines are drawn up to the next segment break point.  
The limit value is fixed up to the next segment if the next segment has different limit value.  
For the final segment, horizontal lines are drawn to the largest point of stimulus.  
Flat line segment is displayed with FLIN in the Limit Table.
- {SINGLE POINT}* : The judgement is performed at a single stimulus point.  
The upper limit is displayed with  $\nabla$  on the display, and the lower limit is displayed with  $\wedge$ .  
The single point segment can be used for the terminal of flat line or sloping line.  
Single point segment is displayed with SPO in the Limit Table.
- {LIMIT COLOR}* : Sets line color.  
Color-to-setup number relationship is as follows.  
2 ; Red  
3 ; Purple  
4 ; Green  
5 ; Blue  
6 ; Yellow  
7 ; White
- {WAVE COLOR}* : Sets trace data color in Pass section.  
The relationship of color-to-setup number is the same as above *{LIMIT COLOR}*.

⑪ Offset limit menu

- {STIMULUS OFFSET}* : Adds/subtracts offset value to/from stimulus value of all segments.  
Input offset value by using ENTRY block.
- {AMPLITUDE OFFSET}* : Adds/subtracts offset value to/from amplitude value of all segments.  
Input offset value by using ENTRY block.
- {MARKER TO AMP. OFS}* : Sets offset value of amplitude value by using the active marker.

**4.8.3 CDMA IF Filter Analysis Function**

This function is suitable for measuring the characteristics of CDMA IF filter.

(1) Gate function of the CDMA IF filter

Obtains the frequency characteristics specifying the defined range of the filter delay time.

## (2) Magnitude analysis function of the CDMA IF filter

The items to be analyzed are as follows:

- Center frequency: The center frequency between the two frequencies from which each magnitude is obtained by subtracting the specified value from the peak value.
- Pass band : The frequency band between the two frequencies from which each magnitude is obtained by subtracting the specified value from the peak value.
- Insertion loss : The peak value
- Ripple within the pass bandwidth :  
The difference between the peak and lowest local minimum values.
- Guaranteed attenuation :  
Lower value between the left and right values obtained by calculating the difference between the insertion loss and the value whose frequency is obtained either by adding the specified frequency to the center frequency (right side) or by subtracting the specified frequency from the center frequency (left side).

## (3) Phase analysis function of the CDMA IF filter

Calculates the phase linearity of the IF filter.

Operation procedure:

- ① Press the *{FUNCTION}* to call the function menu.  
Press the *{CDMA IF FILTER}* to call the CDMA IF filter analysis menu.
- ② CDMA IF filter analysis menu  
Each channel can be set individually.
  - {CDMA IF GATE [ ]}* : Calls the CDMA IF filter analysis menu (see ③).
  - {CDMA FILTER ANALYSIS [ ]}*: Calls the CDMA IF filter magnitude analysis menu (see ⑤).
  - {CDMA PHASE LINEARITY [ ]}*: Turns the CDMA phase linearity analysis ON or OFF. This function calculates phase linearity in compliance with the standards of the CDMA IF filter. The CDMA phase linearity analysis cannot be performed at the same time as the phase linearity analysis.
  - {PHASE LINEARITY [ ]}* : Calls the Phase linearity analysis menu (see ⑥).



4.8 INSTRUMENT STATE Block

③ CDMA IF filter gate menu

Each channel can be set individually.

*{CDMA IF GATE ON/OFF}* : Toggles the CDMA IF filter gate function ON or OFF.

The CDMA IF GATE cannot be ON together with the gate function of the time domain transformation function.

*{CDMA GATE START [ ]}* : Sets the start time of the CDMA IF filter gate.

*{CDMA GATE STOP [ ]}* : Sets the stop time of the CDMA IF filter gate.

*{GATE SHAPE [ ]}* : Calls the CDMA IF filter gate shape menu (see ④).

④ CDMA IF filter gate shape menu

Each channel can be set individually.

*{MAXIMUM}* : Specifies the 4-term Blackman-Harris type. The maximum attenuation can be obtained.

*{WIDE}* : Specifies the 3-term Blackman-Harris type.

*{NORMAL}* : Specifies the 2-term Hamming type.

*{MINIMUM}* : Specifies the rectangular type.

*{CDMA IF}* : Specifies a type which is optimized for the CDMA IF filter.

⑤ CDMA IF filter magnitude menu

*{CDMA FILTER ANALYSIS [ ]}*: Turns the magnitude analysis function ON or OFF. When this function is turned ON, the following analysis results are displayed:

**Note: This function cannot be used with the filter analysis of marker analysis function or the statistical analysis function.**

C. F : Displays the center frequency between the pass bandwidth whose magnitude is obtained by subtracting the loss from the peak value.

B. W : Displays the pass bandwidth.

I. L : Displays the insertion loss (the peak value).

RPL : The difference between the peak and local minimum values.

ATTN1 : Displays the guaranteed attenuation. The guaranteed attenuation is calculated using the higher and lower frequency points (the higher frequency point is obtained by adding ATTN FREQ1 to the center frequency; the lower frequency point, by subtracting ATTN FREQ1 from the center frequency). These points are then used to calculate difference between them and the insertion loss (I.L). The shorter of these two differences is designated as ATTN1.

ATTN2 : Displays the guaranteed attenuation. The guaranteed attenuation is calculated using the higher and lower frequency points (the higher frequency point is obtained by adding ATTN FREQ2 to the center frequency; the lower frequency point, by subtracting ATTN FREQ2 from the center frequency). These points are then used to calculate difference between them and the insertion loss (I.L). The shorter of these two differences is designated as ATTN2.

P. L : When the phase analysis function (CDMA IF filter analysis) is ON, the necessary operation is performed to check the phase linearity and the result is displayed.

{WIDTH VALUE} : Specifies the bandwidth to be searched using the loss (X dB) from the peak value.

{ATTN FREQ1} : Specifies the first frequency for the guaranteed attenuation measurement. The guaranteed attenuation is not measured when this frequency is set to 0 (zero) (as the guaranteed attenuation measurement is set to OFF).

{ATTN FREQ2} : Specifies the second frequency for the guaranteed attenuation measurement. The guaranteed attenuation is not measured when this frequency is set to 0 (zero) (as the guaranteed attenuation measurement is set to OFF)

#### ⑥ Phase linearity analysis menu

{PHASE LINEARITY ON/OFF}: Turns the Phase linearity analysis ON or OFF.

**Note: The phase linearity analysis cannot be performed at the same time as the CDMA phase linearity analysis.**

{PARTIAL ON/OFF} : Turns the partial definition analysis ON or OFF. When this function is set to ON, the phase linearity is analyzed for the section specified by the {SET RANGE} (which is in the partial menu under the marker search menu). When set to OFF, the phase linearity is analyzed for the full measurement range.

4.8 INSTRUMENT STATE Block

<Example of CDMA IF Filter Analysis>.

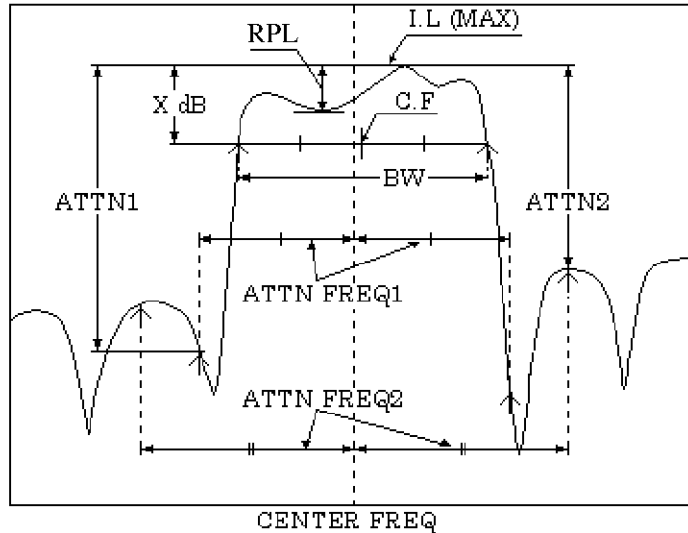

An example of CDMA IF Filter Analysis is shown above. The C.F, B.W, I.L and RPL are obtained using the loss (X dB) specified by {WIDTH VALUE}. When one of these has been calculated, the pass band is displayed with the ↑ marker.

In addition, when ATTN FREQs are specified, the guaranteed attenuations are calculated using the higher and lower frequency points (the higher frequency point is obtained by adding ATTN FREQ to the center frequency; the lower frequency point, by subtracting ATTN FREQ from the center frequency).

Then the attenuation levels at the higher and lower frequencies from the insertion loss are calculated, and finally the smaller value of them is displayed.

In this example, ATTN FREQ1 is used to calculate ATTN1 at the lower frequency point; ATTN FREQ2 is used to calculate ATTN2 at the higher frequency point.

If the results are obtained successfully, the ↑ markers are displayed at the places where the guaranteed attenuations are calculated.

#### 4.8.4 Direct Analysis Functions

Analysis results of filters and resonators are displayed using this function.  
The following functions are available:

- Filter analysis menu
- Resonator analysis menu
- Equivalent circuit analysis menu

Operation procedure:

- ① Press the **[SYSTEM]** key to call the System menu.
- ② Press the *{FUNCTION}* to call the Function menu.
- ③ Press the *{DIRECT ANALYSIS}* to call the Direct Analysis menu.
- ④ Direct analysis menu

- {FILTER ANALYSIS}* : Calls the Filter analysis menu (see ⑤).
- {RESONANT ANALYSIS}* : Calls the Resonator analysis menu (see ⑥).
- {EQUIVALENT ANALYSIS}* : Calls the Equivalent circuit constant analysis menu (see ⑦).
- {RIPPLE X VALUE}* : Specifies the X-axis ripple gradient which is used for the direct analysis.
- {RIPPLE Y VALUE}* : Specifies the Y-axis ripple gradient which is used by the direct analysis.
- {PARTIAL ON/OFF}* : Turns the partial definition analysis ON or OFF. When this function is set to ON, the direct analysis is executed for the section specified by the *{SET RANGE}* (which is in the partial menu under the marker search menu). When set to OFF, the phase linearity is analyzed for the full measurement range.

- ⑤ Filter Analysis menu

- {-3, XdB BND WIDTH(MAX)}*: Analyzes the insertion loss, the bandwidths at -3 dB and at X dB, the center frequency, the pass band ripple value, the cutoff level, and the spurious level.
- {-3, XdB BND WIDTH(Fc)}* : Analyzes the crystal filter at its nominal frequency  $f_c$ . The contents of the analyses are the same as for "-3, X dB WIDTH(MAX)".
- {BAND WIDTH}* : Specifies the bandwidth to be analyzed by the loss (XdB) from the minimum loss.
- {D VALUE}* : Enter the difference from the maximum value.
- {F1 VALUE}* : Enter the stop frequency within the cutoff level range.

4.8 INSTRUMENT STATE Block

*{F2 VALUE}* : Enter the stop frequency within the spurious level range.

*{Fc VALUE}* : Enter the nominal frequency.

⑥ Resonance analysis menu

*{RESONANT (0 PHASE)}* : Obtains the series resonance and parallel resonance parameters such as 0° phase frequency fr (series resonance frequency), 0° phase frequency fa (parallel resonance frequency), and their corresponding impedances Zr and Za, respectively.  
Set the above parameters in *{CONVERSION Z (TRANS)}* under the parameter conversion menu before analyzing the characteristics.

*{RESONANT (RIPPLE)}* : Obtains the resonance point fr, the antiresonance point fa, the RPL1 ripple to the left of the resonant point, the RPL2 ripple between the resonance and antiresonance points, and the RPL3 ripple to the right of the antiresonant point.

The resonance point is the first point detected when searching for the 0° phase in the direction the frequency increases (starting from the low frequency side). The anti-resonance point is the second point detected when searching for the 0° phase in the direction the frequency increases (starting from the low frequency side).

Set the above parameters in *{CONVERSION Z (TRANS)}* under the parameter conversion menu before analyzing the characteristics.

*{RESONANT (A dB, B dB)}* : Obtains the maximum and minimum values. Also obtains the Fa1 frequency to the left of (and at A dB down from) the maximum value; the Fa2 to the right of (and at A dB down from) the maximum value. And finally obtains the Fb1 frequency to the left of (and at B dB up from) the minimum value; the Fb2 to the right of (and at B dB up from) the minimum value.

*{A dB VALUE}* : Specifies the A dB value which is used by RESONANT (A dB, B dB).

*{B dB VALUE}* : Specifies the B dB value which is used by RESONANT (A dB, B dB).

## ⑦ Equivalent circuit analysis menu

- {EQUIVALENT CKT 4}* : Obtains four-element equivalent circuit parameters of a crystal resonator.  
Set the above parameters in *{CONVERSION Y (TRANS)}* under the parameter conversion menu before analyzing the characteristics.
- {EQUIVALENT CKT 6}* : Obtains six-element equivalent circuit parameters of a crystal resonator.  
Set the above parameters in *{CONVERSION Y (TRANS)}* under the parameter conversion menu before analyzing the characteristics.

#### 4.8.5 Self-diagnosis Function

The self-diagnosis function checks each board for failure(s). Contact the service representative or the nearest office to obtain the service manual.

## ① Self-diagnosis menu

- {SELECT TEST NO.}* : Specifies a diagnostic test number.
- {EXECUTE TEST}* : Executes the diagnostic test.
- {DISPLAY STATUS}* : Displays the diagnostic test result.

## 4.9 GPIB Block

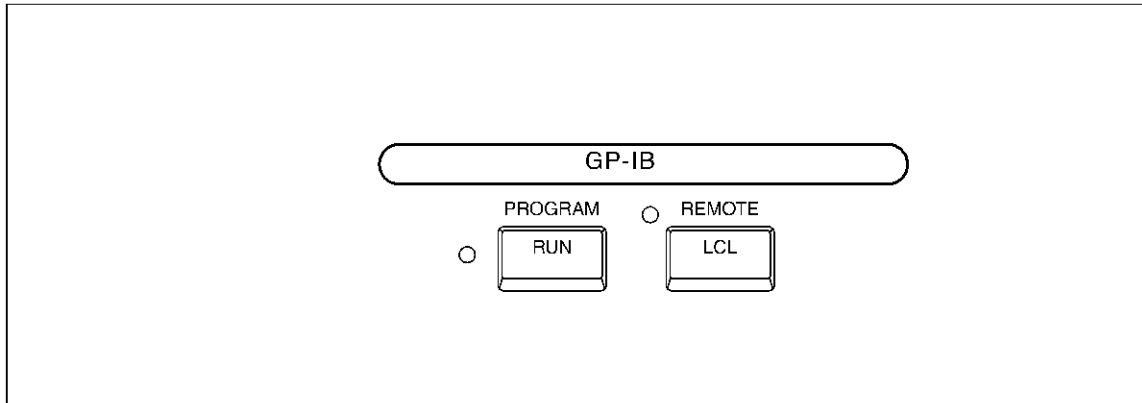

The GPIB block is used to set the BASIC controller function, GPIB bus and GPIB address. For procedure how to create a program, refer to the programming manual of the separate volume.

### PROGRAM

**[RUN]** : Call the BASIC controller menu. (See section 4.9.1.)

### REMOTE

**[LCL]** : Calls the GPIB menu. (See section 4.9.2.)

Moreover, when R3754 Series is in the remote state by GPIB, it return back to the local state by pressing the key.

**Note:** *The operation key of all the panel key becomes disable in the remote state except this key.*

### 4.9.1 Controller Menu

#### Operation procedure

- ① Press the **[RUN]** to call the controller menu.
- ② Controller menu

{RUN}	: Starts a program.
{LOAD MENU}	: Displays a file list and calls the load menu. (See step ③.)
{LIST}	: Displays a program list.
{CLS}	: Clears the text display on the screen.
{CONT}	: Restarts a program from the next line immediately after program pauses.
{STOP}	: Stops a program.



## ③ Load menu

- {LOAD}* : Loads the file specified by the cursor.  
After loading, the screen gets back to the controller menu. (See step ②.)
- {CURSOR ↑}* : Shifts up the cursor used for specifying a file.
- {CURSOR ↓}* : Shifts down the cursor used for specifying a file.
- {DRIVE CHANGE}* : Calls the drive menu to change the current drive. (See step ④.)

## ④ Drive menu

- {A:}* : Select the drive A.  
Floppy disk drive
- {B:}* : Select the drive B.  
RAM disk drive (without backup)
- {C:}* : Select the drive C.  
RAM disk drive (with backup)
- {D:}* : Select the drive D.  
ROM disk drive (Read only)

## 4.9.2 GPIB Menu

## Operation procedure

① Press the [LCL] to call the GPIB menu.

## ② GPIB menu

- {SYSTEM CONTROLLER}* : Sets the R3754 Series to the system controller.
- {TALKER LISTENER}* : Sets the R3754 Series to the talker/listener.
- {SET ADDRESSES}* : Calls the address menu used for setting the GPIB address. (See step ③.)

## ③ Address menu

- {ADDRESS R3754}* : Sets the GPIB address of the R3754 Series.
- {ADDRESS PLOTTER}* : Sets the GPIB address of the plotter.
- {ADDRESS PRINTER}* : Sets the GPIB address of the printer.

## 4.10 Save/Recall

### 4.10 Save/Recall

By using an internal disk, the R3754 Series setting and the data saving/recalling (store/read) can be performed.

The following two methods for saving data are provided in accordance with informations to be saved and an internal disk.

- Save register: Saves the R3754 Series setting and calibration data into RAM disk (Drive C).
- Store file : Store the R3754 Series setting, calibration data and measurement data on a floppy disk.  
All informations ; Drive A (floppy disk)

#### 4.10.1 Selection of Save Type

Operation procedure

- ① Press the [**SAVE**] to call the save menu.
- ② Save menu

<i>{SAVE REGISTER}</i>	: Calls the save register menu. (See section 4.10.2.)
<i>{CLEAR REGISTER}</i>	: Calls the clear register menu used for clearing the stored save register. (See section 4.10.6.)
<i>{STORE FILE}</i>	: Calls the store file menu used for storing files or setting file names. (See section 4.10.3.) The file list (Figure 4-9) will be displayed on the screen.
<i>{PURGE FILE}</i>	: Calls the purge file menu used for clearing the stored file. (See section 4.10.7.) The file list (Figure 4-9) will be displayed on the screen.
<i>{FORMAT DISK}</i>	: Initializes a floppy disk inserted in drive A.

**Note:** Before *STORE FILE* or *PURGE FILE* is executed, be sure to insert a formatted floppy disk to the drive.

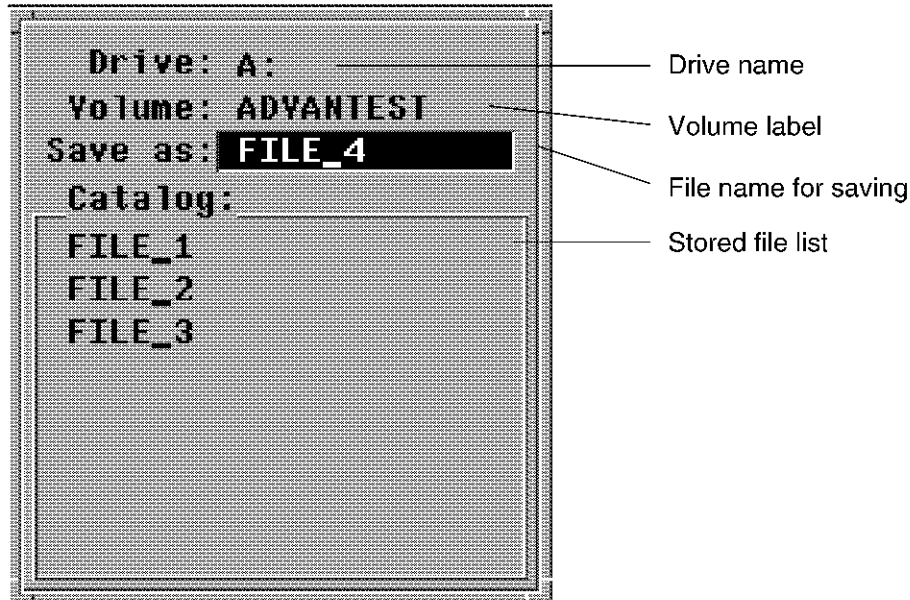

Figure 4-9 File List Display

### 4.10.2 Executing the Save Register Function

Using the save register function, a maximum of 20 sets of measurement conditions and measurement data can be saved in the built-in memory in this network analyzer (each save register function saves a set of measurement conditions and measurement data).

The data is saved as a file in the built-in memory whose capacity is 1880 kB. Therefore, the total data cannot exceed this limit (this memory is shared with the C drive). If the total data exceeds its capacity, the data will not be saved (even if there is a register whose data has not yet been saved). In this case, the user must first erase the data already saved, then try to save them again.

**Note:** *When storing data into the saved register, execute the save register operation after erasing data on the clear register menu. (See section 4.10.7.)*

Operation procedure

- ① Press the [SAVE] to call the save menu.
- ② Press the {SAVE REGISTER} to call the save register menu.
- ③ Save register menu
  - Save register menu (1 of 4)
    - {SAVE REG-1} : Saves the settings, calibration data and memory trace data into the register 1.
    - {SAVE REG-2} : Saves the settings, calibration data and memory trace data into the register 2.
    - {SAVE REG-3} : Saves the settings, calibration data and memory trace data into the register 3.

#### 4.10 Save/Recall

- {SAVE REG-4}* : Saves the settings, calibration data and memory trace data into the register 4.
- {SAVE REG-5}* : Saves the settings, calibration data and memory trace data into the register 5.
- {RENAME REG}* : Calls the name editing menu used to define a register name. (See section 4.10.4.)
- Save register menu (2 of 4)

*{SAVE REG-6}* : Saves the settings, calibration data and memory trace data into the register 6.

*{SAVE REG-7}* : Saves the settings, calibration data and memory trace data into the register 7.

*{SAVE REG-8}* : Saves the settings, calibration data and memory trace data into the register 8.

*{SAVE REG-9}* : Saves the settings, calibration data and memory trace data into the register 9.

*{SAVE REG-10}* : Saves the settings, calibration data and memory trace data into the register 10.

*{RENAME REG}* : Calls the name editing menu used to define a register name. (See section 4.10.4.)
  - Save register menu (3 of 4)

*{SAVE REG-11}* : Saves the settings, calibration data and memory trace data into the register 11.

*{SAVE REG-12}* : Saves the settings, calibration data and memory trace data into the register 12.

*{SAVE REG-13}* : Saves the settings, calibration data and memory trace data into the register 13.

*{SAVE REG-14}* : Saves the settings, calibration data and memory trace data into the register 14.

*{SAVE REG-15}* : Saves the settings, calibration data and memory trace data into the register 15.

*{RENAME REG}* : Calls the name editing menu used to define a register name. (See section 4.10.4.)

- Save register menu (4 of 4)
  - {SAVE REG-16} : Saves the settings, calibration data and memory trace data into the register 16.
  - {SAVE REG-17} : Saves the settings, calibration data and memory trace data into the register 17.
  - {SAVE REG-18} : Saves the settings, calibration data and memory trace data into the register 18.
  - {SAVE REG-19} : Saves the settings, calibration data and memory trace data into the register 19.
  - {SAVE REG-20} : Saves the settings, calibration data and memory trace data into the register 20.
  - {RENAME REG} : Calls the name editing menu used to define a register name. (See section 4.10.4.)

### 4.10.3 Executing Store File

Operation procedure

- ① Press the **[SAVE]** to call the save menu.
- ② Press the {STORE FILE} to call the store file menu.
- ③ Store file menu
  - {STORE} : Stores the setting data and calibration data as a file name for storing.
  - {ROLL ↑} : ] Shifts the cursor up/down of the saved file list.
  - {ROLL ↓} : ]
  - {DEFINE STORE} : Calls the file data menu used to select informations to be stored. (See step ④.)
  - {EDIT NAME} : Calls the character editing menu to define the file name for storing.
  - {NAME ↑} : ] Shifts the cursor up/down of the file name for storing.
  - {NAME ↓} : ]
  - {CANCEL} : Cancels the file store.
- ④ File data menu (When ON is selected, the data is stored.)
  - {STATE ON/OFF} : Store setting condition.
  - {RAW ARRAY ON/OFF} : Store the raw data before formatting.
  - {CORR COEF ON/OFF} : Store the calibration data.  
When the calibration is performed, ON is automatically selected.
  - {DATA ARRAY ON/OFF} : Stores the format data.
  - {MEM ARRAY ON/OFF} : Stores the memory data.

4.10 Save/Recall

**4.10.4 Setting Register Name**

The register name is used so that it can be searched easily. When recalling, the register is called as the named register set.

Operation procedure

- ① Press the [SAVE] to call the save menu.
- ② Press the {SAVE REGISTER} to call the save register menu.
- ③ Press the {RENAME REG} to display the label window and calls the name editing menu.
- ④ Name editing menu

- {EDIT NAME} : Displays the label window (Figure 4-10) and calls the character editing menu. (See step ⑤.)
- {CURSOR ↑} : ] Shifts the cursor up/down of the register list (Figure 4-11)
- {CURSOR ↓} : ] The register name of the cursor position can be edited.

- ⑤ Character editing menu

- {DONE} : Completes editing.
- {CURSOR →} : Shifts the label cursor right.
- {CURSOR ←} : Shifts the label cursor left.
- {BACKSPACE} : Executes the back space operation.
- {DELETE CHAR} : Deletes the character of the cursor position.
- {CLEAR NAME} : Clears all the characters (names).
- {CANCEL} : Cancels editing.

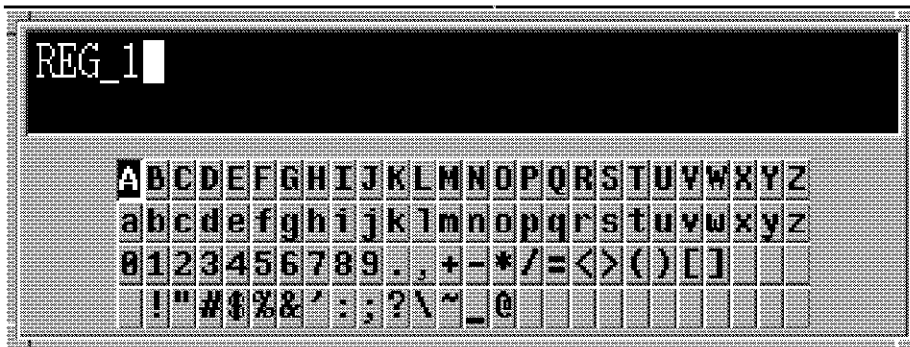

Figure 4-10 Label Window Display

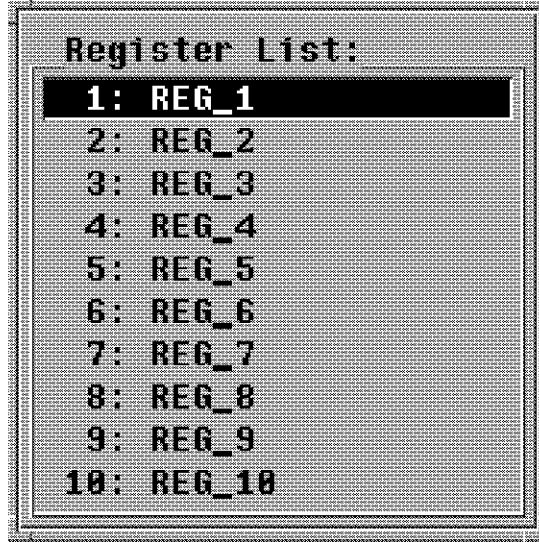

Figure 4-11 Register List Display

## 4.10 Save/Recall

### 4.10.5 Setting File Name

The file name is used so that it can be searched easily. When recalling, the file is called as the named file set.

#### Operation procedure

- ① Press the [**SAVE**] to call the save menu.
- ② Press the {*STORE FILE*} to call the store file menu.
- ③ Press the {*NAME ↑*}, {*NAME ↓*} to select a desired file name.
- ④ Press the {*EDIT NAME*} to display the label window and calls the character editing menu.

#### ⑤ Character menu

{ <i>DONE</i> }	: Completes editing.
{ <i>CURSOR →</i> }	: Shifts the label cursor right.
{ <i>CURSOR ←</i> }	: Shifts the label cursor left.
{ <i>BACKSPACE</i> }	: Executes the back space operation.
{ <i>DELETE CHAR</i> }	: Deletes the character of the cursor position.
{ <i>CLEAR NAME</i> }	: Clears all the characters (names).
{ <i>CANCEL</i> }	: Cancels editing.

### 4.10.6 Clearing Saved Register

Clears registers. When the register name is defined, the defined name is displayed on the screen.

#### Operation procedure

- ① Press the [**SAVE**] to call the save menu.
- ② Press the {*CLEAR REGISTER*} to call the clear register menu.
- ③ Clear register menu

- Clear register menu (1 of 4)

{ <i>CLEAR REG-1</i> }	: Clears the register 1.
{ <i>CLEAR REG-2</i> }	: Clears the register 2.
{ <i>CLEAR REG-3</i> }	: Clears the register 3.
{ <i>CLEAR REG-4</i> }	: Clears the register 4.
{ <i>CLEAR REG-5</i> }	: Clears the register 5.



- Clear register menu (2 of 4)
  - {CLEAR REG-6} : Clears the register 6.
  - {CLEAR REG-7} : Clears the register 7.
  - {CLEAR REG-8} : Clears the register 8.
  - {CLEAR REG-9} : Clears the register 9.
  - {CLEAR REG-10} : Clears the register 10.
- Clear register menu (3 of 4)
  - {CLEAR REG-11} : Clears the register 11.
  - {CLEAR REG-12} : Clears the register 12.
  - {CLEAR REG-13} : Clears the register 13.
  - {CLEAR REG-14} : Clears the register 14.
  - {CLEAR REG-15} : Clears the register 15.
- Clear register menu (4 of 4)
  - {CLEAR REG-16} : Clears the register 16.
  - {CLEAR REG-17} : Clears the register 17.
  - {CLEAR REG-18} : Clears the register 18.
  - {CLEAR REG-19} : Clears the register 19.
  - {CLEAR REG-20} : Clears the register 20.

#### 4.10.7 Purging Stored File

Purges files. When the file name is defined, the defined name is displayed on the menu.

##### Operation procedure

- ① Press the **[SAVE]** to call the save menu.
- ② Press the {PURGE FILE} to call the purge file menu.
- ③ Purges files menu

{PURGE}	:	Purges the file.
{CURSOR ↑}	:	] Shifts the cursor up/down of file list.
{CURSOR ↓}	:	

### 4.10.8 Executing Recall

Recalls register or file. When the register/file name is defined, the defined name is displayed on the screen.

#### Operation procedure

① Press the [**RECALL**] to call the recall menu.

② Recall menu

- Recall menu (1 of 4)

*{RECALL REG-1}* : Recalls the setting data, calibration data and memory trace data saved in the register 1.

*{RECALL REG-2}* : Recalls the setting data, calibration data and memory trace data saved in the register 2.

*{RECALL REG-3}* : Recalls the setting data, calibration data and memory trace data saved in the register 3.

*{RECALL REG-4}* : Recalls the setting data, calibration data and memory trace data saved in the register 4.

*{RECALL REG-5}* : Recalls the setting data, calibration data and memory trace data saved in the register 5.

*{RECALL POWER OFF}*

: The settings are stored automatically when the power of the R3754 Series is turned off. When the power is turned on again, the data is set to the initial state. By pressing this key, the stored data is read again.

*{LOAD FILE}* : Calls the load file menu used to load the all informations stored in the file. (See step ③ or Figure 4-9.)

- Recall menu (2 of 4)

*{RECALL REG-6}* : Recalls the setting data, calibration data and memory trace data saved in the register 6.

*{RECALL REG-7}* : Recalls the setting data, calibration data and memory trace data saved in the register 7.

*{RECALL REG-8}* : Recalls the setting data, calibration data and memory trace data saved in the register 8.

*{RECALL REG-9}* : Recalls the setting data, calibration data and memory trace data saved in the register 9.

*{RECALL REG-10}* : Recalls the setting data, calibration data and memory trace data saved in the register 10.

*{RECALL POWER OFF}*

: The settings are stored automatically when the power is turned off. When the power is turned on again, the data is set to the initial state. By pressing this key, the stored data is read again.

*{LOAD FILE}*

: Calls the load file menu used to load the all informations stored in the file. (See step ③ or Figure 4-9.)

- Recall menu (3 of 4)

*{RECALL REG-11}*

: Recalls the setting data, calibration data and memory trace data saved in the register 11.

*{RECALL REG-12}*

: Recalls the setting data, calibration data and memory trace data saved in the register 12.

*{RECALL REG-13}*

: Recalls the setting data, calibration data and memory trace data saved in the register 13.

*{RECALL REG-14}*

: Recalls the setting data, calibration data and memory trace data saved in the register 14.

*{RECALL REG-15}*

: Recalls the setting data, calibration data and memory trace data saved in the register 15.

*{RECALL POWER OFF}*

: The settings are stored automatically when the power is turned off. When the power is turned on again, the data is set to the initial state. By pressing this key, the stored data is read again.

*{LOAD FILE}*

: Calls the load file menu used to load the all informations stored in the file. (See step ③ or Figure 4-9.)

- Recall menu (4 of 4)

*{RECALL REG-16}*

: Recalls the setting data, calibration data and memory trace data saved in the register 16.

*{RECALL REG-17}*

: Recalls the setting data, calibration data and memory trace data saved in the register 17.

*{RECALL REG-18}*

: Recalls the setting data, calibration data and memory trace data saved in the register 18.

*{RECALL REG-19}*

: Recalls the setting data, calibration data and memory trace data saved in the register 19.

*{RECALL REG-20}*

: Recalls the setting data, calibration data and memory trace data saved in the register 20.

#### 4.10 Save/Recall

{RECALL POWER OFF}

: The settings are stored automatically when the power is turned off. When the power is turned on again, the data is set to the initial state. By pressing this key, the stored data is read again.

{LOAD FILE}

: Calls the load file menu used to load the all informations stored in the file. (See step ③ or Figure 4-9.)

**Note:** Before LOAD FILE is executed, be sure to insert a formatted floppy disk to the drive.

#### ③ Load file menu

{LOAD}

: Loads all informations stored in the file.

{CURSOR ↑}

: ] Shifts the cursor up/down of file list.

{CURSOR ↓}

: ] The file of the cursor position can be recalled.

{Return}

: Makes the control return to the recall menu.

**Note:** If a file stored with RAW ARRAY or DATA ARRAY ON is loaded, the sweep becomes HOLD without reservation.

## 4.11 Hard Copy

Data output can be performed directly to peripheral devices such as a graphic printer and a plotter. GPIB is used for plotter, and GPIB or RS-232 is used for printer. The bitmap file can be output to the floppy disk. Set the R3754 Series as a system controller on the GPIB block, furthermore, specify the GPIB address of the printer or the plotter. (See section 4.9.)

### Operation procedure

- ① Press the **[COPY]** to call the save menu.
- ② Copy menu

<code>{PRINT}</code>	: Executes hard copy for printer.
<code>{PLOT}</code>	: Executes hard copy for plotter. (Note)
<code>{ABORT}</code>	: Aborts the hard copy operation. Continued operation cannot be performed.
<code>{SELECT QUADRANT}</code>	: Calls the plot scale menu used to select the size and location of the hard copy. (See section 4.11.1.)
<code>{DEFINE PLOT}</code>	: Calls the plot data menu used to define the items for hard copy operation. (See section 4.11.2.)
<code>{CONFIGURE PLOT}</code>	: Calls the plotter pen menu used to select pen number and data-line type to be used. (See section 4.11.3.)
<code>{PRINT/PLOT SETUPS}</code>	: Calls the setup menu used to set up the setting of printer or plotter. (See section 4.11.4.)
<code>{BITMAP FILE}</code>	: Calls the bitmap file menu. (See section 4.11.6.)

**Note:** *In using the plotter of HP company, the indication of the error such as error lamp lighting will be occasionally done.*

### 4.11.1 Setting Plot Scale

Specifies the output position and the size for plotting on A4 size paper.

#### Operation procedure

- ① Press the **[COPY]** to call the copy menu.
- ② Press the `{SELECT QUADRANT}` to call the plot scale menu.
- ③ Plot scale menu

<code>{FULL PAGE}</code>	: Selects the plot scale to output one data on A4 size paper with full page.
<code>{LEFT}</code>	: Selects the plot scale to output data to the left position by dividing A4 size paper into two blocks.
<code>{RIGHT}</code>	: Selects the plot scale to output data to the right position by dividing A4 size paper into two blocks.

4.11 Hard Copy

- {LEFT UPPER}* : Selects the plot scale to output data to the upper left position by dividing A4 size paper into four blocks.
- {LEFT LOWER}* : Selects the plot scale to output data to the lower left position by dividing A4 size paper into four blocks.
- {RIGHT UPPER}* : Selects the plot scale to output data to the upper right position by dividing A4 size paper into four blocks.
- {RIGHT LOWER}* : Selects the plot scale to output data to the lower right position by dividing A4 size paper into four blocks.

(Hard copy example)

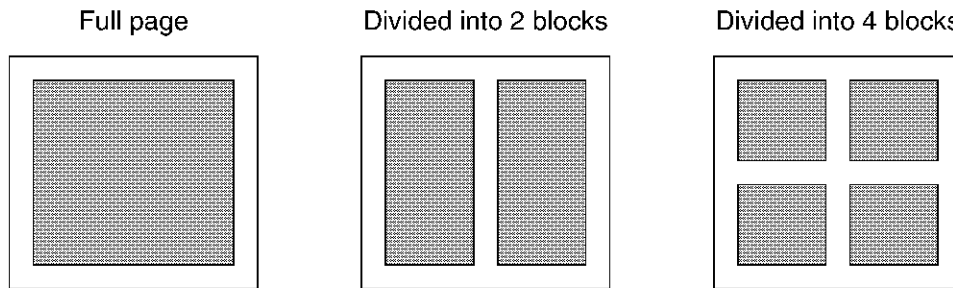

4.11.2 Selecting Plot Data

Selects items to be hard-copied.

Since the items to be set in this menu are independent to the channels, they are set to the active channel only.

Operation procedure

- ① Press the [COPY] to call the copy menu.
- ② Press the {DEFINE PLOT} to call the plot data menu.
- ③ Plot data menu

*{PLOT DATA ON/OFF}* : Sets ON/OFF of the measurement data output.

*{PLOT MEMORY ON/OFF}*  
: Sets ON/OFF of the memory data output.

*{PLOT GRATICULE ON/OFF}*  
: Sets ON/OFF of the coordinate output.

*{PLOT TEXT ON/OFF}* : Sets ON/OFF of the text data output.

*{PLOT MARKER ON/OFF}*  
: Sets ON/OFF of the marker data output.

*{PLOT REF LINE ON/OFF}*  
: Sets ON/OFF of the reference line output.

**Note:** When both the text data output and the marker data output are set to ON, the output of the marker list and filter analysis result is also set.

### 4.11.3 Specifying Pen

Selects the pen number and line type to be used.

Operation procedure

- ① Press the **[COPY]** to call the copy menu.
- ② Press the *{CONFIGURE PLOT}* to call the plotter pen menu.
- ③ Plotter pen menu

*{PEN NUM DATA}* : Specifies the pen number of the measurement data.

*{PEN NUM MEMORY}* : Specifies the pen number of the memory data.

*{PEN NUM GRATICULE}* : Specifies are pen number of the coordinate data.

*{PEN NUM TEXT}* : Specifies the pen number of the text data.

*{PEN NUM MARKER}* : Specifies the pen number of the marker data.

*{LINE TYPE DATA}* : Selects the line type of the measurement data.

*{LINE TYPE MEMORY}* : Selects the line type of the memory data.

- The selection of the line type is as follows.
  - 0 : Solid line
  - 1 : Dotted line
  - 2 : Dashed line
  - 3 : Chain line

### 4.11.4 Plotter Setup

Selects the pen number and line type to be used.

Operation procedure

- ① Press the **[COPY]** to call the copy menu.
- ② Press the *{PRINT/PLOT SETUPS}* to call the setup menu.
- ③ Setup menu

*{PRINTER}* : See section 4.11.5. (This menu is for the printer. This menu is not used at plotter setup.)

*{PRINT SPEED FAST/SLOW}* : See section 4.11.5. (This menu is for the printer. This menu is not used at plotter setup.)

*{PLOT LABEL ON/OFF}* : Selects ON/OFF of the label and real-time clock output.

*{PLOT P. TXT ON/OFF}* : Sets ON/OFF of output of the characters which have been written on the screen using the controller function.

*{DEFAULT SETUPS}* : Returns all the copy menu to the initial settings.

*{PLOTTER HP/AT}* : Selects the HP or AT plotter.

**Note:** *In using the plotter of HP company, the indication of the error such as error lamp lighting will be occasionally done.*

4.11 Hard Copy

④ Setting R9833 DIP switches

The DIP switches should be set to the standard values as shown in Figure 4-12. These switches are used to set the initial conditions at powering on and the interface conditions.

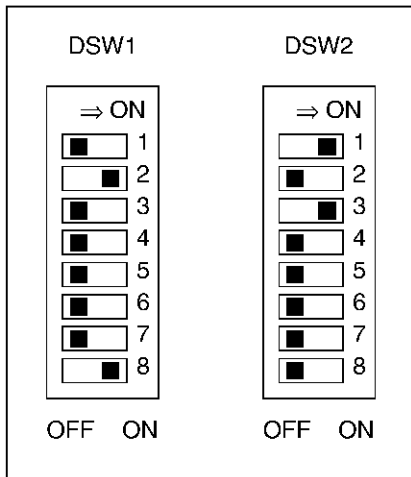

DSW1 : HP mode when SW No. 8 is ON.  
 FP-GL mode when SW No. 8 is OFF.  
 (In AT mode, it is required to set OFF SW No. 8 and ON SW No. 4.)  
 (See Table 4-2.)

DSW2 : Sets the plotter address to 5.  
 (See Table 4-3.)

Figure 4-12 Setting DIP Switches

Table 4-2 DSW1 Function

SW No.	Functions (ON = 1)				Standards
1 to 3	Paper size setting (SW3 = 0)		(SW3 = 1)		SW1 = 0 SW2 = 1 SW3 = 0  A4 long side way
	SW1	SW2	ISO/JIS	ANSI	
	0	0	A3 maximum width and depth	B maximum width and depth	
	1	0	A3 long vertical way direction filling up	B long vertical way direction filling up	
	0	1	A4 long side way direction filling up	A long side way direction filling up	
1	1	A4 long vertical way direction filling up	A long vertical way direction filling up		
4	Setting rotational coordinates 1 : rotational coordinates ON				0
5	Selection of unit length for step number 0 : normal 1 : switch				0
6	Paper detection disable 0 : with paper detection function 1 : not with paper detection function				0
7	Switching input buffer capacity 1 : maximum (12KB) 0 : 1KB				0
8	FP-GL-I/FP-GL-II select 1 : FP-GL-I 0 : FP-GL-II				1



Table 4-3 DSW2 Function

SW No.	Functions (ON = 1)	Standards					
1 to 5	Setting plotter address: defines the device address with all bits. Bit structure <table border="1" style="display: inline-table; vertical-align: middle;"><tr><td>SW5</td><td>SW4</td><td>SW3</td><td>SW2</td><td>SW1</td></tr></table> Address 31 is for listen only mode.	SW5	SW4	SW3	SW2	SW1	SW1 = 1 SW2 = 1 SW3 = 1 SW4 = 1 SW5 = 1
SW5	SW4	SW3	SW2	SW1			
6	Selection of EOI signal control 0 : EOI disabled 1 : EOI enabled However, available only when using FP-GL-II. Not defined for FP-GL-I.	0					
7	Not defined	0					
8	Selection of reduced drawing mode (only when using FP-GL-II). 1 : Selects reduced drawing mode (0.9 time)	0					

If EOI signal is set to ON (enable) and EOI terminal receives "L" when using FP-GL-II, the plotter operates in the same manner as the terminator.

When the plotter sends data, EOI terminal is set to "L" at the same time as it outputs the last "LF" code of sending data.

If the reduced drawing mode is selected when using FP-GL-II, the plotter outputs the drawing being reduced to 0.9 time, based on the global origin. Then, the actual size of the valid drawing range is not changed and the range to be specified by the program is extended.

4.11 Hard Copy

**4.11.5 Printer Setup**

Setting a printer.

Operation procedure

- ① Press [COPY] to call the copy menu.
- ② Press {PRINT/PLOT SETUPS} to call the setup menu.
- ③ Setup menu

- {PRINTER SETUP} : Calls the printer setup menu. (See step ④.)
- {PRINT SPEED FAST/SLOW} : Sets the print mode to FAST or SLOW. To set other parameters, use the printer setup menu (④).
- {PLOT LABEL ON/OFF} : See section 4.11.4. (This menu is for the printer. This menu is not used at printer setup.)
- {PLOT P.TXT ON/OFF} : See section 4.11.4. (This menu is for the printer. This menu is not used at printer setup.)
- {DEFAULT SETUPS} : See section 4.11.4. (This menu is for the printer. This menu is not used at printer setup.)
- {PLOTTER HP/AT} : See section 4.11.4. (This menu is for the printer. This menu is not used at printer setup.)

- ④ Printer setup menu

- {DPI} : Sets the print resolution.
- {UPPER MARGIN} : Sets the upper margin in millimeters.
- {LEFT MARGIN} : Sets the left margin in millimeters.
- {ZOOM SCALE} : Specifies the enlargement ratio. Select it from either one, two or three times.
- {LANDSCAPE ON/OFF} : Specifies the print direction (vertical or horizontal writings).
- {FORMFEED ON/OFF} : Toggles the formfeed ON or OFF.
- {PRINTER} : Calls the printer menu. (See step ⑤.)

- ⑤ Printer menu

- {ESC/P} : Selects a printer which supports the printer control code EPSON ESC/P J83 or J84 of the Seiko-Epson's 24-dot printer.
- {PCL} : Selects a printer (compatible with LaserJet 5L) which supports the Hewlett Packard printer control code PCL.

### 4.11.6 Bitmap File Setup

Setting a bitmap file.

Operation procedure

- ① Press [**COPY**] to call the copy menu.
- ② Press {*BITMAP FILE*} to call the bitmap file menu.
- ③ Bitmap file menu

{*SAVE TO DISK*} : Saves bitmap files to the disk.

{*COMPRESSION ON/OFF*} : Toggles the bitmap file compression ON or OFF.

{*TRUNCATE ON/OFF*} : When there is more than one file with the same name, this determines whether the older file is overwritten or saved with a different name.  
File name: printxxx.bmp  
(*<xxx>* is a three-digit integer)  
*<xxx>* is set to 000 at power-up time, then incremented each time the data is saved.  
When TRUNCATE is turned OFF, a file with the same name as another file is saved with a different name after the counter has been updated.

4.12 Communication with Peripheral Devices

4.12 Communication with Peripheral Devices

As standard, the R3754 Series is equipped with the parallel I/O interface and RS-232 interface as well as the GPIB interface. With these interfaces, it can communicate with peripherals.

- Parallel I/O : Used for communication with peripheral devices such as the handler.
- RS-232 : Used for printed output of internal BASIC.

4.12.1 Parallel I/O Port (Option 01)

(1) Outline

The parallel I/O port is the input/output port to communicate with the handler or peripherals. Use always the shield cable for the connection.

The parallel I/O connector on the back panel is used for communication. Figure 4-14 show the internal pin assignment and signals of the connector. These I/O port is controlled with ENTER and OUTPUT commands.

- Input/output port  
There are two output ports and two input/output ports, as follows:
  - Port only for output : A port : 8-bit width  
B port : 8-bit width
  - Input/output port : C port : 4-bit width  
D port : 4-bit width
- Port C status output, port D status output  
Shows the settings of the input of the input/output ports C and D. It is low when C or D port is set to input, it is high when it is set to output.
- Write strobe output for output port  
By generating a negative pulse on the write strobe output, it shows a data is output to some port.  
Figure below shows the timing chart of the write strobe output and data output.

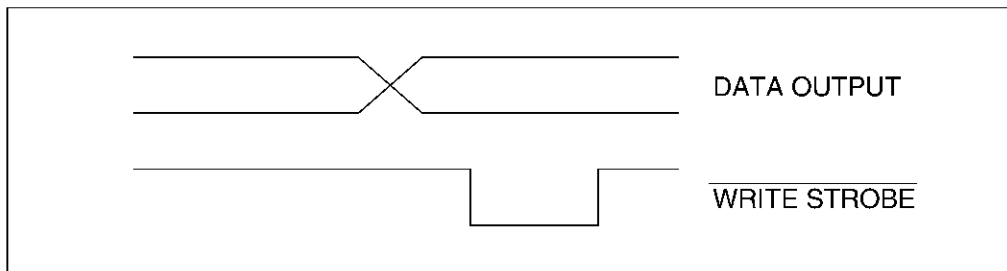
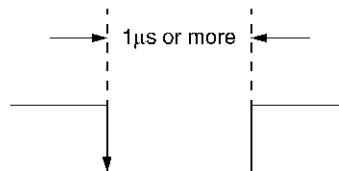

Figure 4-13 Timing Chart of WRITE STROBE

- INPUT 1  
By entering a negative pulse on the INPUT 1, the OUTPUT 1 and 2 are set to LOW. The pulse width of the input signal to be entered in the INPUT 1 should be more than 1μs.

- **OUTPUT 1 and 2**  
These two signal lines are the latch output terminals set to LOW when a negative pulse is entered on the INPUT 1. It can be set to LOW or HIGH with the BASIC command (OUTPUT).
- **PASS/FAIL output**  
Generates LOW when the result of the limit test is PASS and HIGH when the result is FAIL. This function is available only when the limit test function is ON.
- **Write strobe output for PASS/FAIL output**  
When the limit test result is output to the PASS/FAIL output line, generates a negative pulse.
- **SWEEP END**  
When the R3754 Series finishes the sweeping, generates a negative pulse with a width of  $10\mu\text{s}$ .
- **+5V output**  
+5V output is provided for the external device. The maximum current to be supplied is 100mA. This line has a fuse which will be blown when overcurrent flows for circuit protection. The blown fuse needs to be replaced.
- **EXT TRIG input**  
By entering a negative pulse on this line, it is possible to trigger the sweep of measurement. The pulse width should be at least  $1\mu\text{s}$ . The sweeping starts at the trailing edge of the pulse. When this signal line is used, the trigger mode should be set to external source.



4.12 Communication with Peripheral Devices

(2) Connector Internal Pin Assigned and Signal Standard

The table below lists signal names and their functions.

Pin No.	Signal name	Function
1	GND	Ground
2	INPUT 1	Negative logic pulse input of TTL level (width: 1 μs or more)
3	OUTPUT 1	Negative logic latch output of TTL level
4	OUTPUT 2	Negative logic latch output of TTL level
5	Output port A0	Negative logic latch output of TTL level
6	Output port A1	Negative logic latch output of TTL level
7	Output port A2	Negative logic latch output of TTL level
8	Output port A3	Negative logic latch output of TTL level
9	Output port A4	Negative logic latch output of TTL level
10	Output port A5	Negative logic latch output of TTL level
11	Output port A6	Negative logic latch output of TTL level
12	Output port A7	Negative logic latch output of TTL level
13	Output port B0	Negative logic latch output of TTL level
14	Output port B1	Negative logic latch output of TTL level
15	Output port B2	Negative logic latch output of TTL level
16	Output port B3	Negative logic latch output of TTL level
17	Output port B4	Negative logic latch output of TTL level
18	EXT TRIG	EXTERNAL TRIGGER input (width: 1 μs or more), negative logic
19	Output port B5	Negative logic latch output of TTL level
20	Output port B6	Negative logic latch output of TTL level
21	Output port B7	Negative logic latch output of TTL level
22	Input/output port C0	Negative logic state input/latch output of TTL level
23	Input/output port C1	Negative logic state input/latch output of TTL level
24	Input/output port C2	Negative logic state input/latch output of TTL level
25	Input/output port C3	Negative logic state input/latch output of TTL level
26	Input/output port D0	Negative logic state input/latch output of TTL level
27	Input/output port D1	Negative logic state input/latch output of TTL level
28	Input/output port D2	Negative logic state input/latch output of TTL level
29	Input/output port D3	Negative logic state input/latch output of TTL level
30	Port C status	TTL level, Input mode: LOW, Output mode: HIGH
31	Port D status	TTL level, Input mode: LOW, Output mode: HIGH
32	Write strobe signal	TTL level, Negative logic, Pulse output
33	PASS/FAIL signal	TTL level, PASS: LOW, FAIL: HIGH, latch output
34	SWEEP END signal	TTL level, Negative logic, Pulse output (width: 10 μs or more)
35	+5V	+5V ± 10%, 100mA MAX
36	Write strobe signal (PASS/FAIL)	TTL level, Negative logic, Pulse output

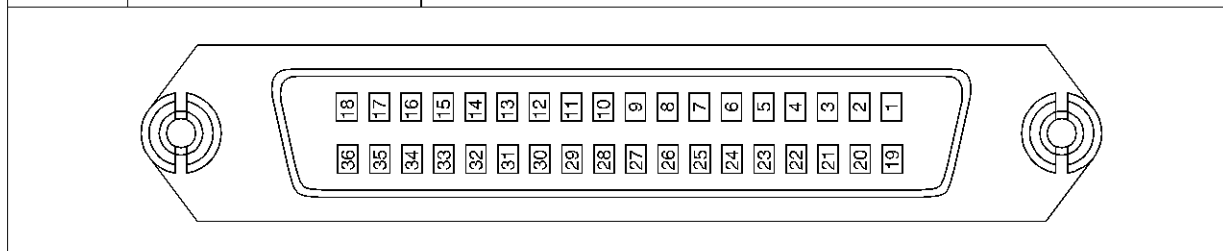

Figure 4-14 36-pin Connector Internal Pin Assignment and Signal

## (3) Internal circuit

Figure below shows input and output ports and the interface section of INPUT/OUTPUT.

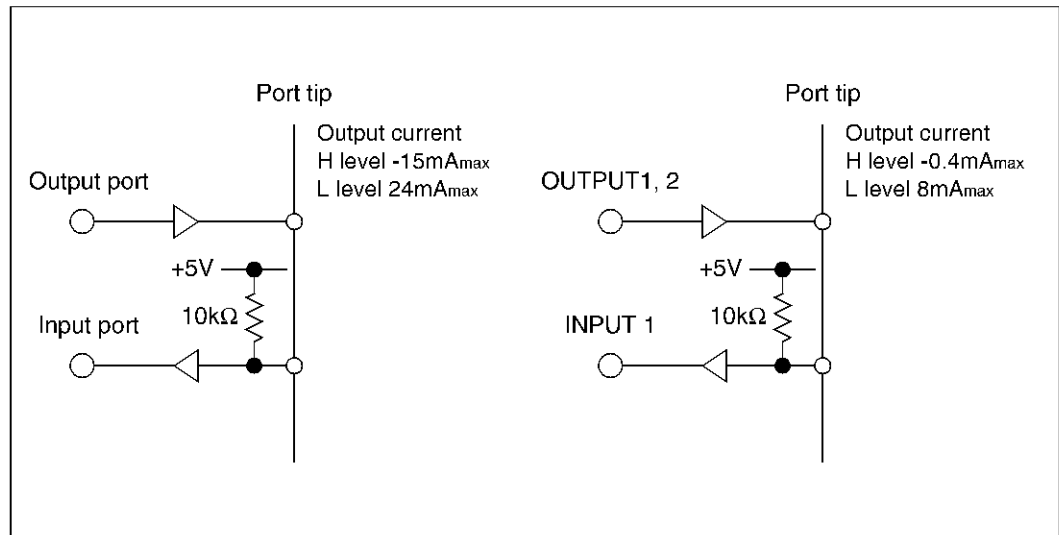

Figure 4-15 Internal Circuit

## (4) Mode setting of port

To use a parallel I/O port, first set the mode setting of port. The relationships between commands, output ports and input ports are as listed in the table below.

Command	Output port	Input port
OUTPUT 36 ; 16	A, B, C, D	
OUTPUT 36 ; 17	A, B, D	C
OUTPUT 36 ; 18	A, B, C	D
OUTPUT 36 ; 19	A, B	C, D

Example : Set the output mode to Ports A and B, and set the input ports to Ports C and D.

```
10 OUTPUT 36;19
20 OUTPUT 33;255
30 ENTER 37;A
:
```

## Description

10 Output ports are set to Ports A and B and input ports are set to Ports C and D.  
 20 Set Port A to 255.  
 30 Read the data from Ports C and D and save it into Variable A.

4.12 Communication with Peripheral Devices

(5) Each port operation method

Describes the operation method by built-in BASIC.

OUTPUT statement (for output) and ENTER statement (for input) are used for data input/output.

In the BASIC command (OUTPUT and ENTER statements), each port is distinguished by the address used in the statement.

(a) BASIC format

OUTPUT (address) ; (output data)

ENTER (address) ; [variable]

(Input data are assigned to specified variable.)

(b) Address and data range

Address	Port to be used
33	Port A (Output only: OUTPUT statement only)
34	Port B (Output only: OUTPUT statement only)
35	Port C (Input/output: ENTER, OUTPUT)
36	Port D (Input/output: ENTER, OUTPUT)
37	Port C, D (Input/output: ENTER, OUTPUT)

- OUTPUT 33, 34, 37

OUTPUT  $\times \times$  ; 0 to 255 (8-bit)

- OUTPUT 35, 36

OUTPUT  $\times \times$  ; 0 to 15 (4-bit)

**Note:** The OUTPUT 35 concerns with the Set/Reset of Flip Flop.

- ENTER 35, 36

ENTER  $\times \times$  ; numeric variable (4-bit) (Data from 0 to 15 are assigned.)

- ENTER 37

ENTER 37 ; numeric variable (8-bit) (Data from 0 to 255 are assigned.)



## (6) INPUT 1, OUTPUT 1 and OUTPUT 2 Terminals

By combining with the signal lines of INPUT 1, OUTPUT 1 and OUTPUT 2, convenient functions are provided to easily control external devices.

The functions are; function which sets two latch outputs of OUTPUTs 1 and 2 to LOW by pulse input to INPUT 1, and function which detects the state of OUTPUT 1 by INPUT 1. Also, the state of OUTPUTs 1 and 2 can be controlled by OUTPUT command.

## (a) Setting and Resetting of OUTPUT 1 and OUTPUT 2

The following four types are provided for set/reset as follows:

- Setting OUTPUT 1 : OUTPUT 35 ; 16
- Setting OUTPUT 2 : OUTPUT 35 ; 48
- Resetting OUTPUT 1 : OUTPUT 35 ; 80
- Resetting OUTPUT 2 : OUTPUT 35 ; 112

## (b) INPUT 1 (external input)

The state of OUTPUT 1 can be observed by INPUT 1 using ENTER statement.

ENTER 34; (numeric variable)

If 1 is assigned to the numeric variable, OUTPUT 1 is ON (Low level: negative logic), if 0, OUTPUT 1 is OFF (High level).

Example : By observing the state of OUTPUT 1, if OUTPUT 1 is set to ON, then 1 is output to the port A.

```
10  OUTPUT 36 ; 16
20  ENTER 34 ; A
30  IF A <> 1 THEN GOTO 20
40  OUTPUT 33 ; 1
    :
```

4.12 Communication with Peripheral Devices

(7) Usage sample of the ports

(a) INPUT 1, OUTPUT 1 and OUTPUT 2

This sample program shows how to execute a program using the trigger switch.

- Circuit example

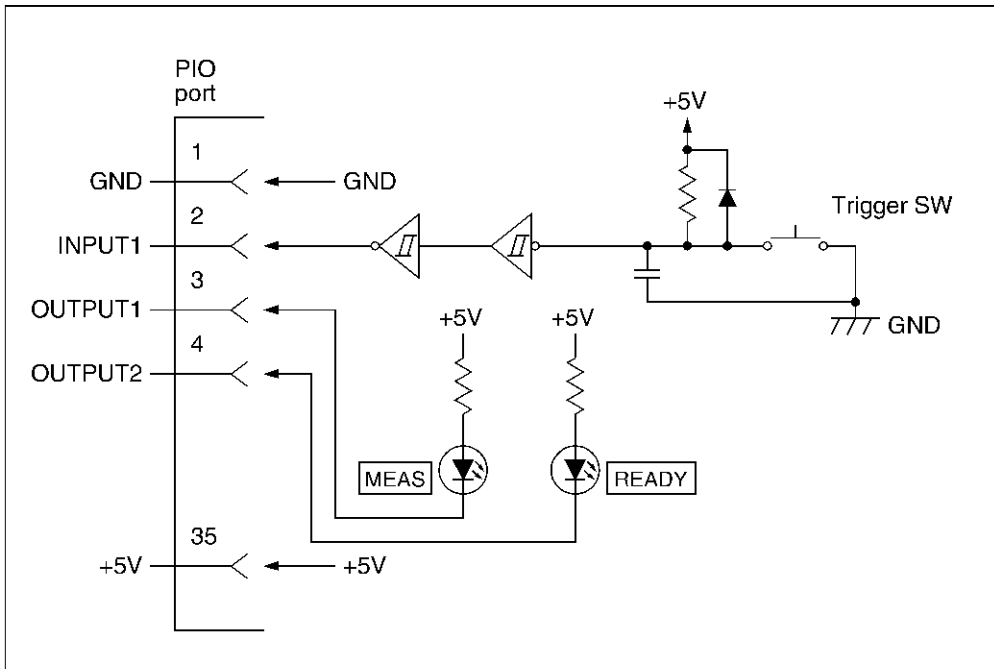

- Program example

Waiting time for measurement: Represents [READY].  
 During measurement operation: Represents [MEAS].

```

10  OUTPUT 35 ; 80 )
20  OUTPUT 35 ; 112 )      [READY], [MEAS] turns OFF.
    :
100 OUTPUT 35 ; 48      Network analyzer initial setup
110 ENTER 34 ; A        [READY] turns ON.
120 IF A <> 1 THEN GOTO 110 ) Recognition of Trigger SW
130 OUTPUT 35 ; 112    [READY] turns OFF.
    :
    :
500 OUTPUT 35 ; 80      Measurement routine
510 GOTO 100           [MEAS] turns OFF.
520 STOP              When repeating the measurement
    
```

## (b) Output port A (or B)

This sample program shows how to select a device using one of the LEDs.

**Note:** When setting the output port to Port B, you can use this sample program in the same manner as for Port A.

- Circuit example

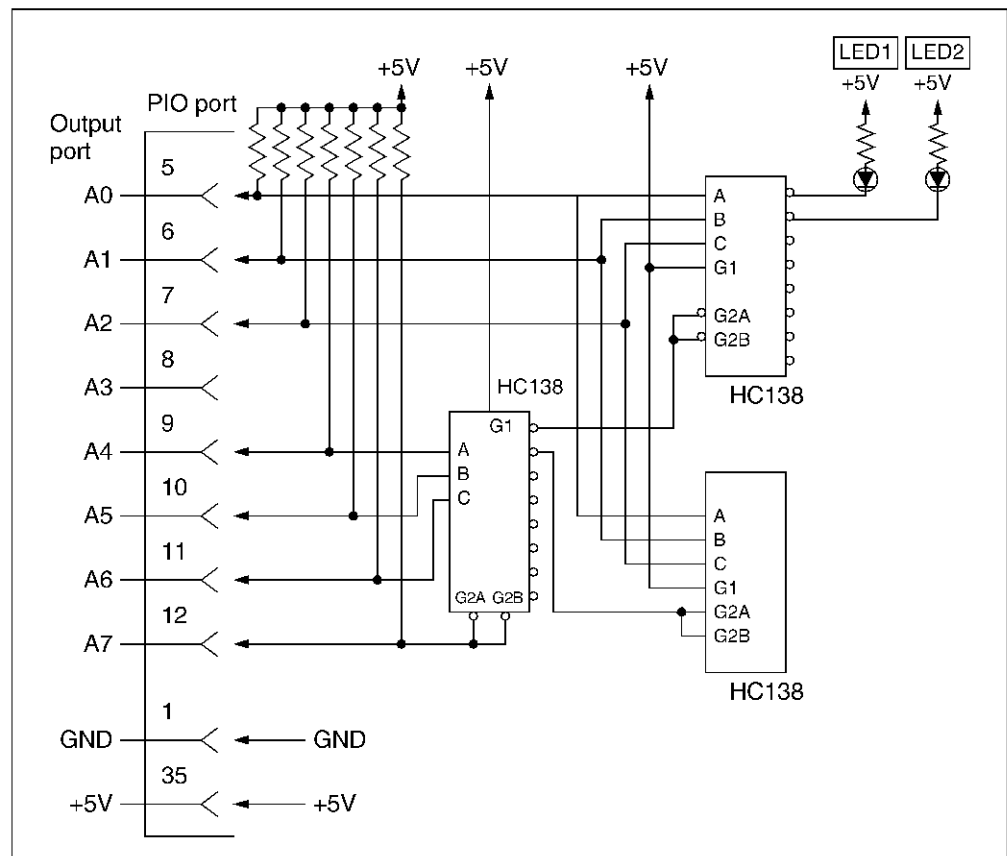

- Program example

```

10  OUTPUT 36 ; 16      Defines ports A, B, C and D as output port.
20  OUTPUT 33 ; 0      Initializes LED.
30
:
:                       Measurement and judgment
:                       ( measurement variable: A
:                       judgement range: JED0 to JED1, JED1 to JED2 ... )
500 IF A >= JED0 AND A < JED1 THEN OUTPUT 33 ; 0xFF
      (When JED0 to JED1, lights up LED 1.)
510 IF A >= JED1 AND A < JED2 THEN OUTPUT 33 ; 0xFF
      (When JED1 to JED2, lights up LED 2.)
:
800 GOTO 30
810 STOP

```

4.12 Communication with Peripheral Devices

(c) Input/Output port C (or D)

The following sample shows how to switch the process depending on the value of C0 (1 or 0).

**Note:** *When setting the input/output port to Port D, you can use this sample program in the same manner as for Port C.*

- Circuit example

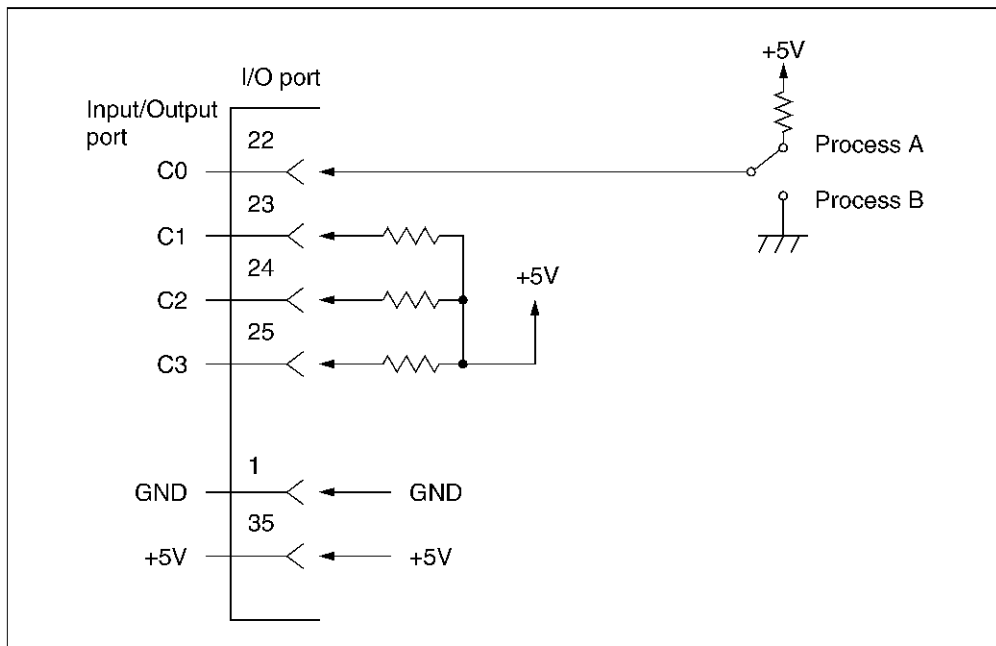

- Program example (Check the port C by pressing [Trigger SW] in example (a).)

```

10  OUTPUT 36 ; 19           Defines ports A and B as output port.
20  OUTPUT 35 ; 80           Defines ports C and D as input port.
30  OUTPUT 35 ; 112
   :
100 *TRIG                    Network analyzer initial setup
110 ENTER 34 ; A
120 IF A <> 1 THEN GOTO *TRIG
130 ENTER 35 ; B             Obtains value of port C.
140 IF B = 1 THEN GOTO *ROUT_B
150 *ROUT_A
   :
490 GOTO *TRIG              Process A
500 *ROUT_B
   :
900 GOTO *TRIG              Process B
910 STOP
    
```

### 4.12.2 Parallel I/O Port (Option 02)

#### (1) Outline

The parallel I/O port is the input/output port to communicate with the handler or peripherals. Use always the shield cable for the connection.

The parallel I/O connector on the back panel is used for communication. Figure 4-17 show the internal pin assignment and signals of the connector. These I/O port is controlled with ENTER and OUTPUT commands.

- Input/output port  
There are two output ports and two input/output ports, as follows:
  - Port only for output : A port : 8-bit width  
B port : 8-bit width
  - Input/output port : C port : 4-bit width  
D port : 4-bit width
- Port C status output, port D status output  
Shows the settings of the input of the input/output ports C and D. It is low when C or D port is set to input, it is high when it is set to output.
- Write strobe output for output port  
By generating a negative pulse on the write strobe output, it shows a data is output to some port.  
Figure below shows the timing chart of the write strobe output and data output.

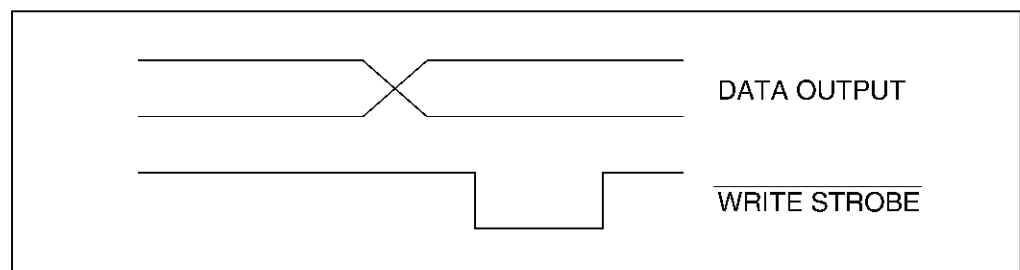
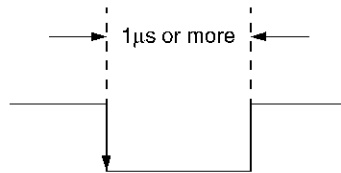

Figure 4-16 Timing Chart of WRITE STROBE

- INPUT 1  
By entering a negative pulse on the INPUT 1, the OUTPUT 1 and 2 are set to LOW. The pulse width of the input signal to be entered in the INPUT 1 should be more than 1 $\mu$ s.
- OUTPUT 1 and 2  
These two signal lines are the latch output terminals set to LOW when a negative pulse is entered on the INPUT 1. It can be set to LOW or HIGH with the BASIC command (OUTPUT).
- PASS/FAIL output  
Generates LOW when the result of the limit test is PASS and HIGH when the result is FAIL. This function is available only when the limit test function is ON.
- Write strobe output for PASS/FAIL output  
When the limit test result is output to the PASS/FAIL output line, generates a negative pulse.

#### 4.12 Communication with Peripheral Devices

- **SWEEP END**  
When the R3754 Series finishes the sweeping, generates a negative pulse with a width of  $10\mu\text{s}$ .
- **+5V output**  
+5V output is provided for the external device. The maximum current to be supplied is 100mA. This line has a fuse which will be blown when overcurrent flows for circuit protection. The blown fuse needs to be replaced.
- **EXT TRIG input**  
By entering a negative pulse on this line, it is possible to trigger the sweep of measurement. The pulse width should be at least  $1\mu\text{s}$ . The sweeping starts at the trailing edge of the pulse. When this signal line is used, the trigger mode should be set to external source.



## (2) Connector Internal Pin Assigned and Signal Standard

The table below lists signal names and their functions.

Pin No.	Signal name	Function
1	GND	Ground
2	INPUT 1	Negative logic pulse input of TTL level (width: 1 $\mu$ s or more)
3	OUTPUT 1	Negative logic latch output of TTL level
4	OUTPUT 2	Negative logic latch output of TTL level
5	Output port A0	Negative logic latch output of TTL level
6	Output port A1	Negative logic latch output of TTL level
7	Output port A2	Negative logic latch output of TTL level
8	Output port A3	Negative logic latch output of TTL level
9	Output port A4	Negative logic latch output of TTL level
10	Output port A5	Negative logic latch output of TTL level
11	Output port A6	Negative logic latch output of TTL level
12	Output port A7	Negative logic latch output of TTL level
13	Output port B0	Negative logic latch output of TTL level
14	Output port B1	Negative logic latch output of TTL level
15	Output port B2	Negative logic latch output of TTL level
16	Output port B3	Negative logic latch output of TTL level
17	Output port B4	Negative logic latch output of TTL level
18	Output port B5	Negative logic latch output of TTL level
19	Output port B6	Negative logic latch output of TTL level
20	Output port B7	Negative logic latch output of TTL level
21	Input/output port C0	Negative logic state input/latch output of TTL level
22	Input/output port C1	Negative logic state input/latch output of TTL level
23	Input/output port C2	Negative logic state input/latch output of TTL level
24	Input/output port C3	Negative logic state input/latch output of TTL level
25	Input/output port D0	Negative logic state input/latch output of TTL level
26	Input/output port D1	Negative logic state input/latch output of TTL level
27	Input/output port D2	Negative logic state input/latch output of TTL level
28	Input/output port D3	Negative logic state input/latch output of TTL level
29	Port C status	TTL level, Input mode: LOW, Output mode: HIGH
30	Port D status	TTL level, Input mode: LOW, Output mode: HIGH
31	Write strobe signal	TTL level, Negative logic, Pulse output
32		
33	SWEEP END signal	TTL level, Negative logic, Pulse output (width: 10 $\mu$ s or more)
34	+5V	+5V $\pm$ 10%, 100mA MAX
35	PASS/FAIL signal	TTL level, PASS: LOW, FAIL: HIGH, latch output
36	Write strobe signal (PASS/FAIL)	TTL level, Negative logic, Pulse output

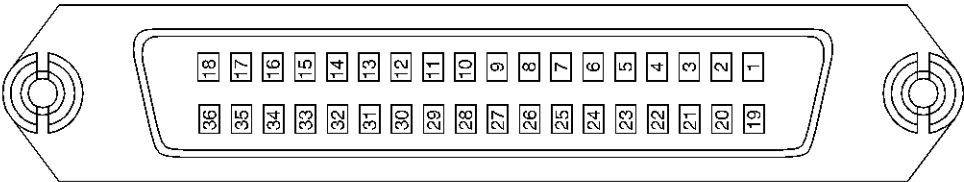

Figure 4-17 36-pin Connector Internal Pin Assignment and Signal

4.12 Communication with Peripheral Devices

(3) Internal circuit

Figure below shows input and output ports and the interface section of INPUT/OUTPUT.

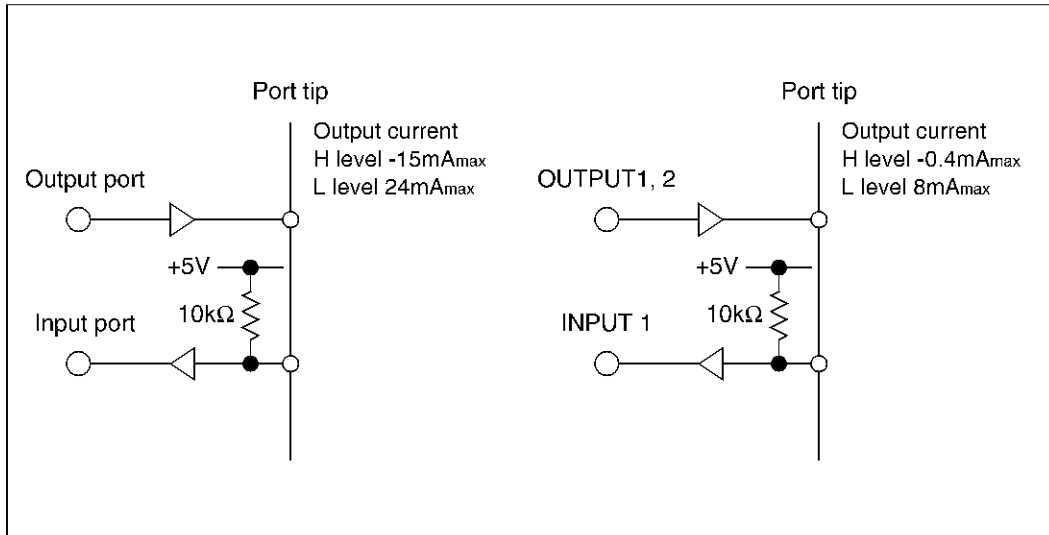

Figure 4-18 Internal Circuit

(4) Mode setting of port

To use a parallel I/O port, first set the mode setting of port. The relationships between commands, output ports and input ports are as listed in the table below.

Command	Output port	Input port
OUTPUT 36 ; 16	A, B,C, D	
OUTPUT 36 ; 17	A, B, D	C
OUTPUT 36 ; 18	A, B, C	D
OUTPUT 36 ; 19	A, B	C, D

Example : Set the output mode to Ports A and B, and set the input ports to Ports C and D.

```

10 OUTPUT 36;19
20 OUTPUT 33;255
30 ENTER 37;A
:
```

Description

- 10 Output ports are set to Ports A and B and input ports are set to Ports C and D.
- 20 Set Port A to 255.
- 30 Read the data from Ports C and D and save it into Variable A.



## (5) Each port operation method

Describes the operation method by built-in BASIC.

OUTPUT statement (for output) and ENTER statement (for input) are used for data input/output.

In the BASIC command (OUTPUT and ENTER statements), each port is distinguished by the address used in the statement.

## (a) BASIC format

OUTPUT (address) ; (output data)

ENTER (address) ; [variable]

(Input data are assigned to specified variable.)

## (b) Address and data range

Address	Port to be used
33	Port A (Output only: OUTPUT statement only)
34	Port B (Output only: OUTPUT statement only)
35	Port C (Input/output: ENTER, OUTPUT)
36	Port D (Input/output: ENTER, OUTPUT)
37	Port C, D (Input/output: ENTER, OUTPUT)

- OUTPUT 33, 34, 37

OUTPUT  $\times \times$  ; 0 to 255 (8-bit)

- OUTPUT 35, 36

OUTPUT  $\times \times$  ; 0 to 15 (4-bit)

**Note:** *The OUTPUT 35 concerns with the Set/Reset of Flip Flop.*

- ENTER 35, 36

ENTER  $\times \times$  ; numeric variable (4-bit) (Data from 0 to 15 are assigned.)

- ENTER 37

ENTER 37 ; numeric variable (8-bit) (Data from 0 to 255 are assigned.)

---

#### 4.12 Communication with Peripheral Devices

##### (6) INPUT 1, OUTPUT 1 and OUTPUT 2 Terminals

By combining with the signal lines of INPUT 1, OUTPUT 1 and OUTPUT 2, convenient functions are provided to easily control external devices.

The functions are; function which sets two latch outputs of OUTPUTs 1 and 2 to LOW by pulse input to INPUT 1, and function which detects the state of OUTPUT 1 by INPUT 1. Also, the state of OUTPUTs 1 and 2 can be controlled by OUTPUT command.

##### (a) Setting and Resetting of OUTPUT 1 and OUTPUT 2

The following four types are provided for set/reset as follows:

- Setting OUTPUT 1 : OUTPUT 35 ; 16
- Setting OUTPUT 2 : OUTPUT 35 ; 48
- Resetting OUTPUT 1 : OUTPUT 35 ; 80
- Resetting OUTPUT 2 : OUTPUT 35 ; 112

##### (b) INPUT 1 (external input)

The state of OUTPUT 1 can be observed by INPUT 1 using ENTER statement.

ENTER 34; (numeric variable)

If 1 is assigned to the numeric variable, OUTPUT 1 is ON (Low level: negative logic), if 0, OUTPUT 1 is OFF (High level).

Example : By observing the state of OUTPUT 1, if OUTPUT 1 is set to ON, then 1 is output to the port A.

```
10 OUTPUT 36 ; 16
20 ENTER 34 ; A
30 IF A <> 1 THEN GOTO 20
40 OUTPUT 33 ; 1
   :
```

## (7) Usage sample of the ports

## (a) INPUT 1, OUTPUT 1 and OUTPUT 2

This sample program shows how to execute a program using the trigger switch.

- Circuit example

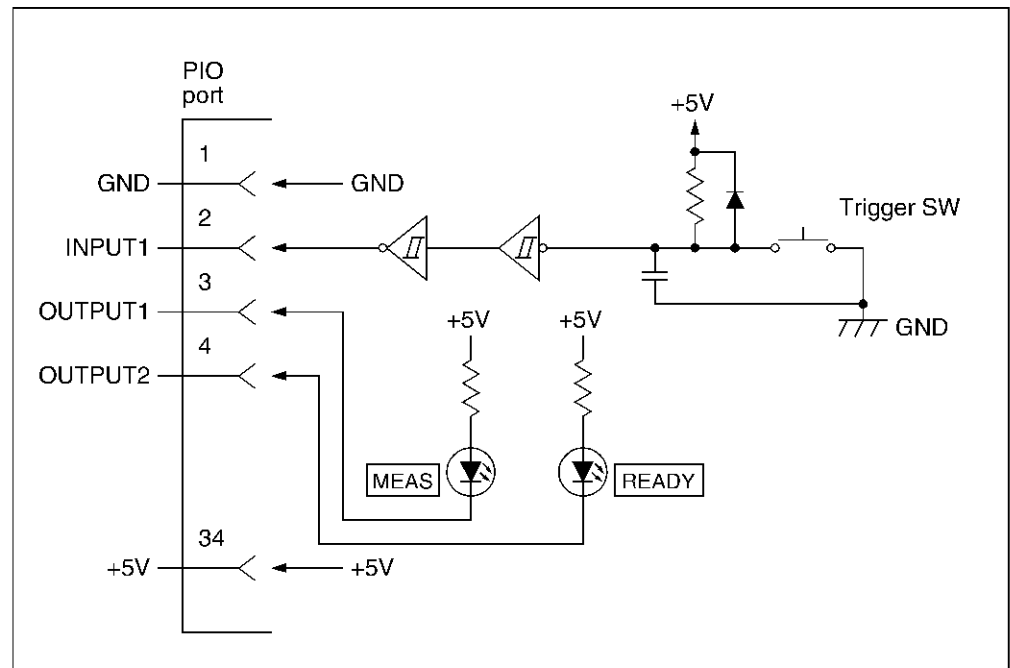

- Program example

Waiting time for measurement: Represents **[READY]**.  
 During measurement operation: Represents **[MEAS]**.

```

10  OUTPUT 35 ; 80 )
20  OUTPUT 35 ; 112 )
    :
100 OUTPUT 35 ; 48
110 ENTER 34 ; A
120 IF A <> 1 THEN GOTO 110 )
130 OUTPUT 35 ; 112
    :
    :
500 OUTPUT 35 ; 80
510 GOTO 100
520 STOP
  
```

**[READY], [MEAS] turns OFF.**

Network analyzer initial setup  
**[READY] turns ON.**

Recognition of Trigger SW  
**[READY] turns OFF.**

Measurement routine  
**[MEAS] turns OFF.**  
 When repeating the measurement

4.12 Communication with Peripheral Devices

(b) Output port A (or B)

This sample program shows how to select a device using one of the LEDs.

**Note:** When setting the output port to Port B, you can use this sample program in the same manner as for Port A.

- Circuit example

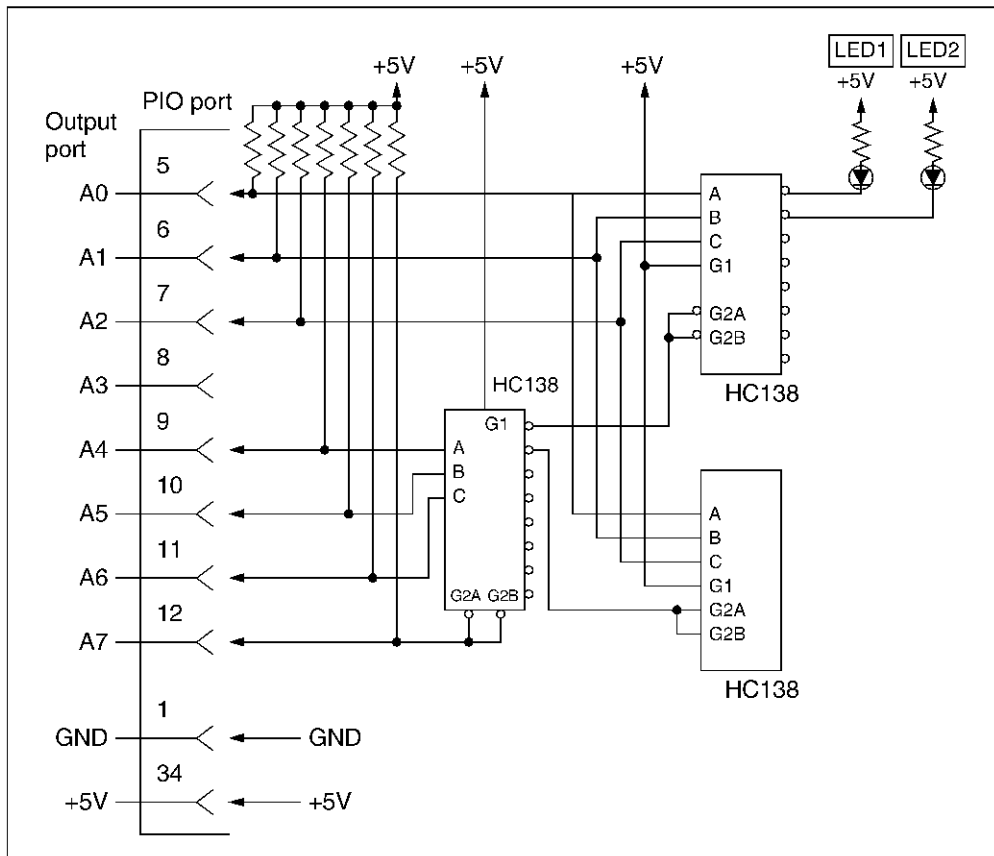

- Program example

```

10  OUTPUT 36 ; 16      Defines ports A, B, C and D as output port.
20  OUTPUT 33 ; 0      Initializes LED.
30
:
:      Measurement and judgment
:      ( measurement variable: A
:      judgement range: JED0 to JED1, JED1 to JED2 ... )
500 IF A >= JED0 AND A < JED1 THEN OUTPUT 33 ; 0xFF
      (When JED0 to JED1, lights up LED 1.)
510 IF A >= JED1 AND A < JED2 THEN OUTPUT 33 ; 0xFF
      (When JED1 to JED2, lights up LED 2.)
:
800 GOTO 30
810 STOP
    
```

## (c) Input/Output port C (or D)

The following sample shows how to switch the process depending on the value of C0 (1 or 0).

**Note:** When setting the input/output port to Port D, you can use this sample program in the same manner as for Port C.

- Circuit example

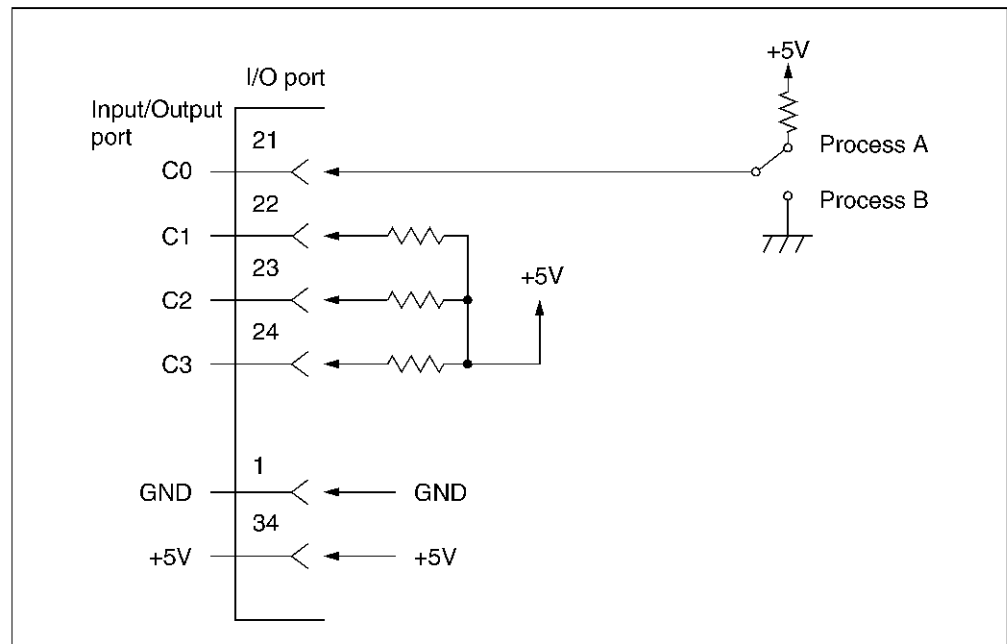

- Program example (Check the port C by pressing [Trigger SW] in example (a).)

```

10  OUTPUT 36 ; 19           Defines ports A and B as output port.
20  OUTPUT 35 ; 80           Defines ports C and D as input port.
30  OUTPUT 35 ; 112
   :
100 *TRIG                    Network analyzer initial setup
110 ENTER 34 ; A
120 IF A <> 1 THEN GOTO *TRIG
130 ENTER 35 ; B             Obtains value of port C.
140 IF B = 1 THEN GOTO *ROUT_B
150 *ROUT_A
   :                          Process A
490 GOTO *TRIG
500 *ROUT_B
   :                          Process B
900 GOTO *TRIG
910 STOP

```



- GND  
The potential of this pin is equivalent to the GND potential of the network analyzer.
- External VCC  
Connect the wire from this pin to External VCC.
- External GND  
Connect the wire from this pin to External GND.
- NC  
Do not connect any wire to this pin (Always leave this pin electrically open).

4.12 Communication with Peripheral Devices

(2) Connector Internal Pin Assigned and Signal Standard

The table below lists signal names and their functions.

Pin No.	Signal name	Function
1	GND	Ground (GND potential of the network analyzer)
2	OUTPUT 1	Negative logic latch output of OPT Isolation
3	Output port A0	Negative logic latch output of OPT Isolation
4	Output port A2	Negative logic latch output of OPT Isolation
5	Output port A4	Negative logic latch output of OPT Isolation
6	Output port A6	Negative logic latch output of OPT Isolation
7	Output port B0	Negative logic latch output of OPT Isolation
8	Output port B2	Negative logic latch output of OPT Isolation
9	Output port B4	Negative logic latch output of OPT Isolation
10	Output port B6	Negative logic latch output of OPT Isolation
11	Input port C0	Negative logic state input of OPT Isolation
12	Input port C2	Negative logic state input of OPT Isolation
13	Input port D0	Negative logic state input of OPT Isolation
14	Input port D2	Negative logic state input of OPT Isolation
15	Data write strobe signal	Negative logic state pulse output of OPT Isolation (width: 10 $\mu$ s or more)
16	SWEEP END signal	Negative logic state pulse output of OPT Isolation (width: 10 $\mu$ s or more)
17	NC	Leave this terminal electrically open.
18	External VCC (Vx)	External power supply
19	+5V	+5V $\pm$ 10%, 100mA MAX
20	OUTPUT 2	Negative logic latch output of OPT Isolation
21	Output port A1	Negative logic latch output of OPT Isolation
22	Output port A3	Negative logic latch output of OPT Isolation
23	Output port A5	Negative logic latch output of OPT Isolation
24	Output port A7	Negative logic latch output of OPT Isolation
25	Output port B1	Negative logic latch output of OPT Isolation
26	Output port B3	Negative logic latch output of OPT Isolation
27	Output port B5	Negative logic latch output of OPT Isolation
28	Output port B7	Negative logic latch output of OPT Isolation
29	Input port C1	Negative logic state input of OPT Isolation
30	Input port C3	Negative logic state input of OPT Isolation
31	Input port D1	Negative logic state input of OPT Isolation
32	Input port D3	Negative logic state input of OPT Isolation
33	PASS/FAIL strobe signal	Negative logic state pulse output of OPT Isolation (width: 10 $\mu$ s or more)
34	PASS/FAIL signal	Negative logic latch output of OPT Isolation
35	NC	Leave this terminal electrically open.
36	External GND	External GND

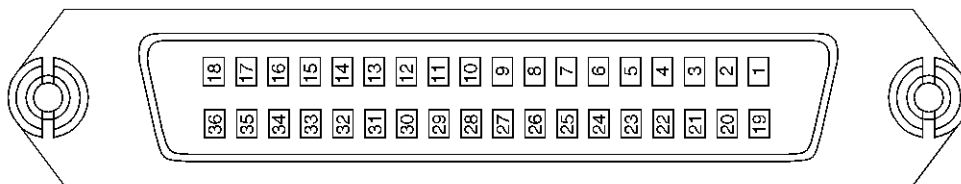

Figure 4-20 36-pin Connector Internal Pin Assignment and Signal



(3) Internal circuits of the input/output port

The explanation of the output circuit is shown in Figure 4-21.

The explanation of the Input circuit is shown in Figure 4-22.

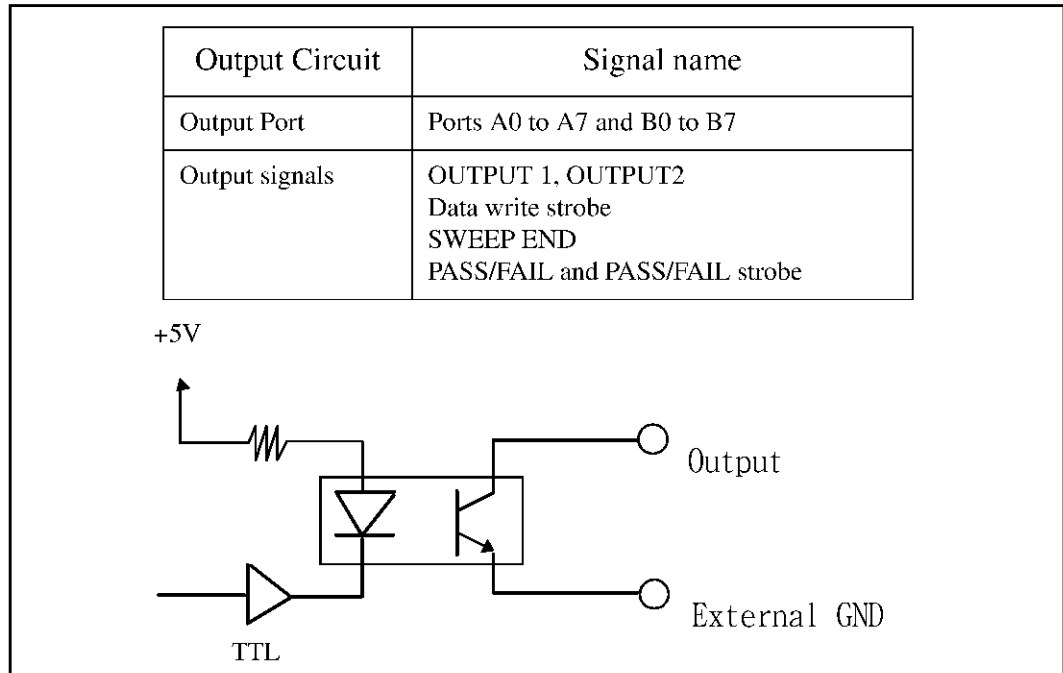

Figure 4-21 Output Circuit

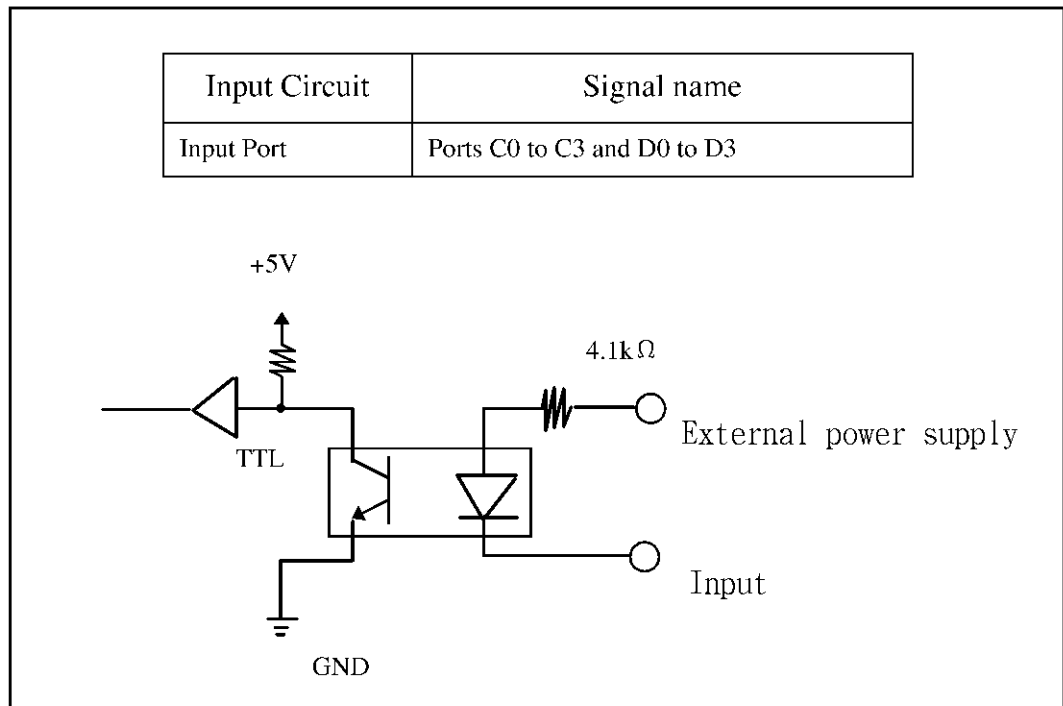

Figure 4-22 Input Circuit

4.12 Communication with Peripheral Devices

(4) Control method recommended

- Output port and output signal

Connect the output port and output signal to the external power supply using an external pull-up resistor since the output port and output signal are the open-collector type.

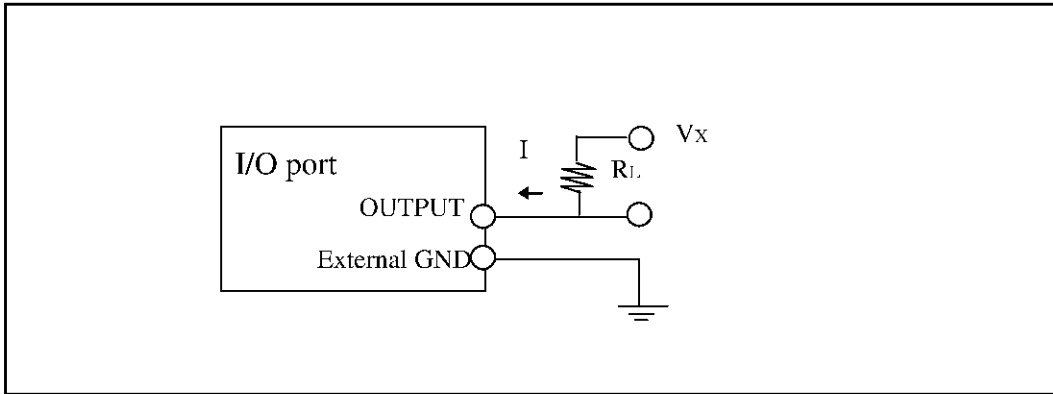

Figure 4-23 OUTPUT

The values of external resistor  $R_L$  and external power supply voltage  $V_x$  must meet the following equation.

$$(V_x / 2)^2 / R_L < 75mW$$

Table 4-4 Rated Values of the Signals

Signal Name	Variable Name	Rated Value
External power supply	$V_x$	25V
Maximum current	$I_{max}$	12mA or less
Saturation voltage	$V_{CE(SAT)}$	0.8 V for $I = 12\text{ mA}$

- Input port

Input port is internally connected to the cathode side (-) of the LED. In addition, the anode side (+) of the LED is connected to external power supply through a resistor.

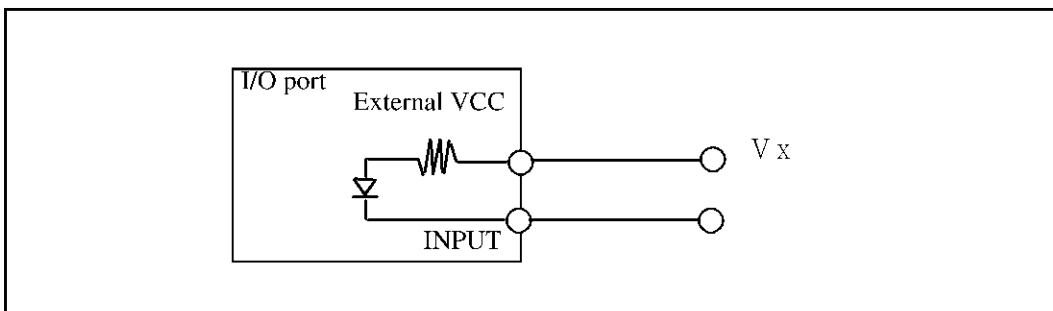

Figure 4-24 INPUT

The voltage range of the external power supply must be between 10 V and 25 V.

**Table 4-5 Rated Values of the Signals**

Signal Name	Variable Name	Rated Value
External power supply	Vx	Between 10 V and 25 V

## (5) Mode setting of port

To use a parallel I/O port, first set the mode setting of port. The relationships between commands, output ports and input ports are as listed in the table below.

Command	Output port	Input port
OUTPUT 36 ; 19	A, B	C, D

Example : Set the output mode to Ports A and B, and set the input ports to Ports C and D.

```
10 OUTPUT 36;19
20 OUTPUT 33;255
30 ENTER 37;A
  :
```

## Description

```
10 Output ports are set to Ports A and B and input ports are set to Ports C and D.
20 Set Port A to 255.
30 Read the data from Ports C and D and save it into Variable A.
```

4.12 Communication with Peripheral Devices

(6) Each port operation method

Describes the operation method by built-in BASIC.

OUTPUT statement (for output) and ENTER statement (for input) are used for data input/output.

In the BASIC command (OUTPUT and ENTER statements), each port is distinguished by the address used in the statement.

(a) BASIC format

OUTPUT (address) ; (output data)

ENTER (address) ; [variable]

(Input data are assigned to specified variable.)

(b) Address and data range

Address	Port to be used
33	Port A (Output only: OUTPUT statement only)
34	Port B (Output only: OUTPUT statement only)
35	Port C (Input only: ENTER statement only)
36	Port D (Input only: ENTER statement only)
37	Port C, D (Input only: ENTER statement only)

- OUTPUT 33, 34  
OUTPUT x x ; 0 to 255 (8-bit)
- ENTER 35, 36  
ENTER x x ; numeric variable (4-bit) (Data from 0 to 15 are assigned.)
- ENTER 37  
ENTER 37 ; numeric variable (8-bit) (Data from 0 to 255 are assigned.)

(7) OUTPUT 1 and OUTPUT 2 Terminals

The state of OUTPUTs 1 and 2 can be controlled by OUTPUT command.

(a) Setting and Resetting of OUTPUT 1 and OUTPUT 2

The following four types are provided for set/reset as follows:

- Setting OUTPUT 1 : OUTPUT 35 ; 16
- Setting OUTPUT 2 : OUTPUT 35 ; 48
- Resetting OUTPUT 1 : OUTPUT 35 ; 80
- Resetting OUTPUT 2 : OUTPUT 35 ; 112

#### 4.12.4 RS-232 Interface

The R3754 Series is equipped with an RS-232 interface as a standard. Therefore, data such as measurement and analysis data can be output to an RS-232 printer.

The RS-232 interface defines mechanical and electrical characteristics of interface for connecting between data terminal and data communication device standardized by Electronic Industries Association (EIA).

Refer to "Regulation" for details.

(1) Connection connector and signal table

Connection connector : 9-pin D-sub connector (male type)

Signal table :

Pin No.	Signal name	Function
1	CD	Carrier detect
2	RXD	Receive data
3	TXD	Transmit data
4	DTR	Data terminal ready
5	GND	Signal ground
6	DSR	Data set ready
7	RTS	Request to send
8	CTS	Transmit enable

(2) Printer output method

The LLIST or LPRINT command is used to output to the RS-232 printer by the R3754 Series. The setting such as a baud rate is defined by the CONTROL command.

Refer to "Programming manual" for details.

LLIST : Outputs BASIC program to the printer.

LPRINT : Outputs the contents of character strings, numeric values and variables.

CONTROL : Sets the values such as a baud rate, character length and others.

Setting values at power-on

Baud rate : 9600 baud

Character length : 8 bits

Parity : None

Stop bit : 1 bit



## 5 OPTIONAL FUNCTIONS

The following optional functions are available for the R3754 Series:

- Time Domain function (Option 70)
- Drive Level Measurement (DLD) function (Option 71)
- Three-terminal Resonator Measurement function (Option 72)

These options (70, 71 and 72) must be installed on this instrument to use the functions described above.

### 5.1 Time Domain Function (Option 70)

#### 5.1.1 Time Domain Transformation Function

A measurement result in the frequency domain can be transformed into the corresponding response in the time domain by using the Time domain transformation function. The result in the time domain will be represented as an impulse response or step response of the DUT.

The relationship between a frequency domain response and the corresponding time domain response of this analyzer is defined by the Fourier transform.

The time domain result can be obtained by calculating a frequency domain measurement result with the inverse Fourier transform.

##### (1) Transformation Mode

The bandpass and low pass modes are available for transforming the frequency domain data into time domain data.

The bandpass mode is a general purpose mode which allows the user to set the frequency range freely. This mode is used to measure a DUT impulse response with its limited bands.

Using the low pass mode, the user can obtain information about points of discontinuity. In the low pass mode, the impulse mode and the step mode are available. The former is used to obtain the response by an impulse input to a DUT ; and the latter, to obtain the response by a step input to DUT.

In the low pass mode, however, frequency range settings are restricted. Frequency data must be spaced equally in the range from the virtual DC point to the stop frequency:

$$(\text{Start frequency}) \times (\text{number of measuring points}) = (\text{stop frequency})$$

It is necessary that the above relation must be maintained.

The user can easily set frequency ranges to meet the condition above using *{SET FREQ LOW PASS}* function.

## 5.1 Time Domain Function (Option 70)

## (2) Measuring Range in the Time Domain

The measuring range in the time domain (span) is determined by the measuring range in the frequency domain and the number of measuring points:

$$\begin{aligned} \text{Measuring range in the time domain} &= \frac{\text{Number of measuring points}}{\text{Frequency span}} \\ &= \frac{\text{Number of measuring points}}{\text{Stop frequency} - \text{Start frequency}} \end{aligned}$$

The measuring range can be expanded by either increasing the number of measuring points or narrowing the frequency span.

Operating procedure:

- ① Press [FUNCTION] to call the function menu.

Press {TRANSFORM} to call the time domain transformation menu.

**Note:** When Option 70 is not installed, {TRANSFORM} will not be displayed.

- ② Time domain transformation menu

Each channel can be set individually.

{TRANSFORM ON/OFF} : Toggles the time domain display ON or OFF.

ON: Displays the time domain.

OFF: Displays the frequency domain.

{SET FREQ LOW PASS} : Sets a frequency range which conforms to the low pass mode restrictions.

{LOW PASS IMPULSE} : Selects the low pass impulse transformation mode.

{LOW PASS STEP} : Selects the low pass step transformation mode.

{BANDPASS} : Selects the bandpass transformation mode.

{WINDOW [ ]} : Calls the window menu to select a window (see Section 5.1.2).

{GATE [ ]} : Calls the gate menu to select a gate (see Section 5.1.3).



### 5.1.2 Window Processing

Leakage phenomenon in Fourier transform occurs due to data discontinuity in the frequency domain, or data truncation in the start and stop frequencies. This leakage phenomenon consequently causes the ripples called ringing. Window processing is required to reduce this, so that the window is applied to the frequency domain data to reduce ripples in the time domain.

Three types of windows are available: *{MAXIMUM}* provides the maximum effect to reduce the ringing, but the rise time (impulse width) is longer. On the other hand, *{MINIMUM}* does not suppress the ringing, but sharp rising characteristics can be obtained.

Operating procedure:

- ① Press **[FUNCTION]** to call the function menu.

Press *{TRANSFORM}* to call the time domain transformation menu.

Press *{WINDOW [ ]}* to call the window menu.

**Note:** When Option 70 is not installed, *{TRANSFORM}* will not be displayed.

- ② Window menu

Each channel can be set individually.

*{MAXIMUM}* : Specifies the 4-term Blackman-Harris type. The maximum reduction can be obtained.

*{NORMAL}* : Specifies the 2-term Hamming type.

*{MINIMUM}* : Specifies the rectangular type. Window processing is not performed.

### 5.1.3 Gate Function

The necessary components can be extracted from a result of the time domain response using this function. Peculiar frequency components can be either extracted or removed using a type of filter in the time domain response.

The results can be seen in both the frequency and time domains.

When the gate span is positive, the specified range is extracted; when negative, the specified range is removed.

There are four types of gate functions: for *{MAXIMUM}*, the attenuation at the cutoff region can be obtained to the maximum and the ripple at the pass region can be minimized. The cutoff time characteristics are degraded however.

For *{MINIMUM}*, very sharp cutoff characteristics can be obtained, but the attenuation at the cutoff region is reduced.

Operating procedure:

- ① Press *{FUNCTION}* to call the function menu.

Press *{TRANSFORM}* to call the time domain transformation menu.

Press *{GATE [ ]}* to call the gate menu.

**Note:** When Option 70 is not installed, *{TRANSFORM}* will not be displayed.

## 5.1 Time Domain Function (Option 70)

### ② Gate menu

Each channel can be set individually.

- {GATE ON/OFF}* : Toggles the gate function ON or OFF. This cannot be used at the same time as the CDMA IF gate function.
- {GATE START [ ]}* : Sets the gate start time.
- {GATE STOP [ ]}* : Sets the gate stop time.
- {GATE CENTER [ ]}* : Sets the gate center time.
- {GATE SPAN [ ]}* : Sets the gate's time span.
- {VELOCITY FACTOR}* : Sets the velocity factor.
- {GATE SHAPE [ ]}* : Calls the gate shape menu to set a type of gates (see ③).

### ③ Gate shape menu

Each channel can be set individually.

- {MAXIMUM}* : Specifies the 4-term Blackman-Harris type. The maximum attenuation can be obtained in the cutoff region.
- {WIDE}* : Specifies the 3-term Blackman-Harris type.
- {NORMAL}* : Specifies the 2-term Hamming type.
- {MINIMUM}* : Specifies the rectangular type.

## 5.2 Drive Level Measurement (DLD) Functions (Option 71)

This function is used to measure the drive levels of devices, such as a crystal vibrator, at high speeds

From these results, CI (crystal impedance) and  $\Delta F$  (difference from a nominal frequency) are obtained. In addition,  $\Delta F$  can be expressed in Hz or ppm.

The RLA method (Reactance Linear Approximation) is used with the drive level measurement function to measure drive levels accurately at high speeds.

RLA method: Used to calculate a resonance frequency and CI by measuring REAL/IMAG components (after converting the impedance) at two frequencies near the resonance point for each level.

### 5.2.1 Measurement Example

The measurement method the crystal resonator is explained here by the example of the crystal of 10.37MHz in which  $\pi$  network is used.

Typical crystal characteristics are as follows.

Q = 150000

CI = 15.0 $\Omega$

- ① Setup it ( $\pi$  network jig connection). Preset it. Use the PIC-001 $\pi$  network jig for the  $\pi$  network jig.
- ② Connect crystal to the test port of the  $\pi$  network jig.

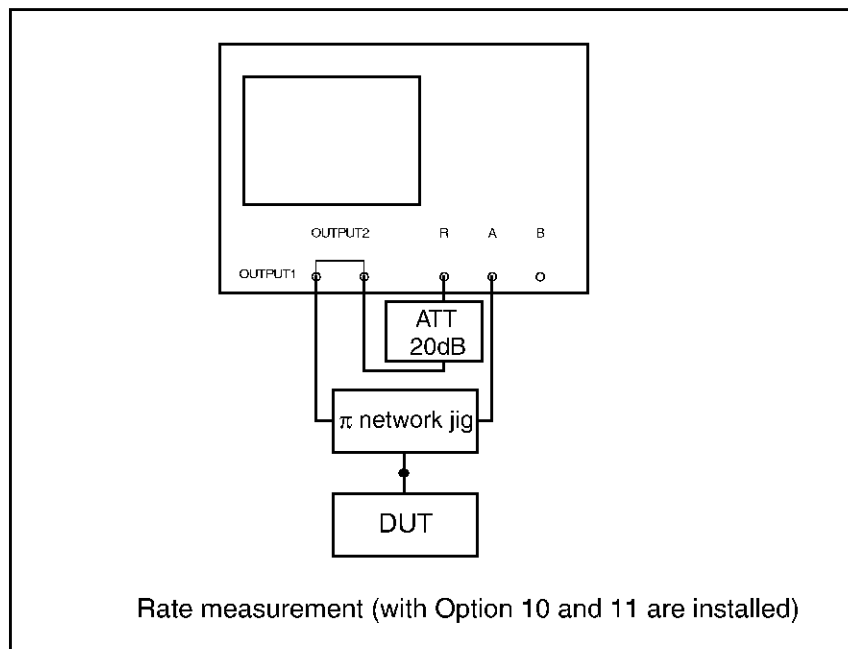

Figure 5-1 Connecting the  $\pi$  Network Jig and DUT

5.2 Drive Level Measurement (DLD) Functions (Option 71)

- ③ Set the center frequency and the span.

Make the span a little wider.

[CENTER] → [1] → [0] → [.] → [3] → [7] → [MHz]

[SPAN] → [1] → [kHz]

- ④ Perform the Transmission Full calibration.

Enter the load standard value (50Ω).

[CAL] → {Z0 VALUE} → [5] → [0] → [X1]

Perform the Transmission Full calibration

[CAL] → {CAL MENUS} → {TRANS FULL CAL}

Open the  $\pi$  network jig and press {OPEN}.

Insert the short standard into the  $\pi$  network jig and press {SHORT}.

Insert the load standard (50Ω) into the  $\pi$  network jig and press {LOAD}.

Press {DONE TRANS}, insert the crystal again.

(For details on transmission full calibration, refer to Section 3.2.21, "Impedance Measurement of Crystal Resonator.")

- ⑤ Specify DLD measurement analysis range.

The applicable power range is from 0.0002 $\mu\Omega$  to 490  $\mu\Omega$ .

This figure depends on CI (crystal impedance). See Figure 5-4 Maximum and Minimum Applicable Power to Crystal in Section 5.2.2.

Specify the units for start and stop levels.

Press the [SYSTEM] key and select the following soft menu items in the order shown: {FUNCTION}, {DRIVE LEVEL DEPENDENCY}, and {DRIVE LEVEL}. Press {LEVEL UNIT[ $\mu\Omega$ /dBm]} to select [ $\mu\Omega$ ] as the unit.

{START LEVEL} → [0] → [.] → [0] → [3] → [MHz]( $\mu\Omega$ )

{STOP LEVEL} → [3] → [0] → [0] → [MHz]( $\mu\Omega$ )

{TYPICAL CI} → [1] → [5] → [X1]

{LEVELS [ ]} → [1] → [0] → [0] → [X1]

- ⑥ Set the settling time.

Settling time: Response time required for a crystal in order to have an accurate measurement when changing the power applied to the crystal. The settling time of the crystal used in this example is approximately 15 ms.

Press the [SYSTEM] key and select the following soft menu items in the order shown: {FUNCTION}, {DRIVE LEVEL DEPENDENCY}, and {FINE SETUP}. At {FINE SETUP}, select {SETTLING TIME} and then press [1], [5] and [kHz](ms).

- ⑦ A DLD analysis starts.

The phase  $0^\circ$  frequency search starts the moment when DLD is turned on. The DLD measurement is executed by making the frequency (fr) (which is obtained from phase  $0^\circ$ ) as the center (see Note).

Press the [SYSTEM] key and select the following soft menu items in the order shown {FUNCTION}, {DRIVE LEVEL DEPENDENCY}. At {DRIVE LEVEL DEPENDENCY}, turn {DRIVE LEVEL DEPENDENCY[ON/OFF]} on.

**Note:** DLD measurement errors can occur due to a change in the frequency (fr). It is recommend that  $0^\circ$  phase searches be performed each time you replace the device with a new one.

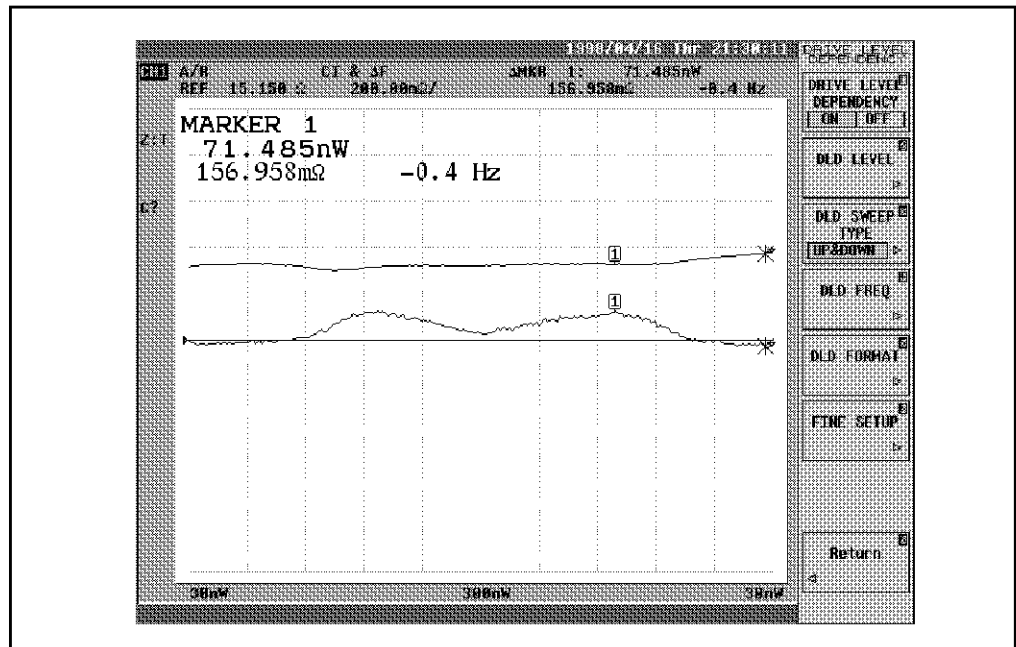

Figure 5-2 Screen Displaying DLD Analysis

5.2 Drive Level Measurement (DLD) Functions (Option 71)

- ⑧ Display the analysis result list.

Press the [SYSTEM] key and select the following soft menu items in the order shown: {FUNCTION}, {DRIVE LEVEL DEPENDENCY}, and {DLD FORMAT}. At {DLD FORMAT}, turn {DLD LIST [ON/OFF]} on.

The analysis result will be displayed in a list on the lower half of the screen. You can scroll through the list using the [↑] and [↓] keys.

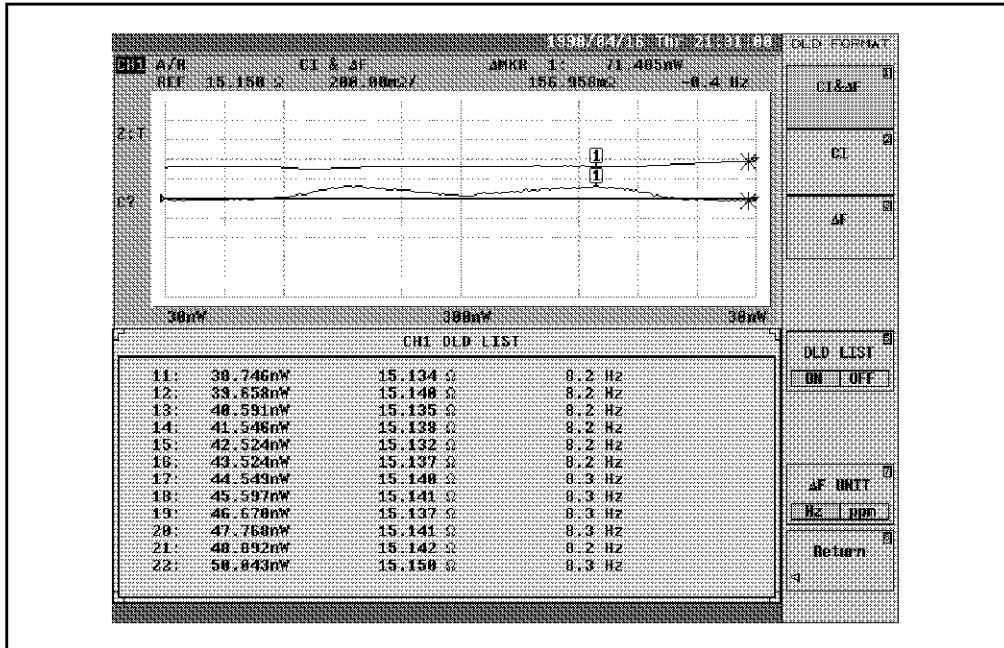

Figure 5-3 Screen Displaying DLD Analysis List

### 5.2.2 Operating the DLD Function Key

This section describes how to operate the keys associated with the DLD function.

The DLD function supports the save and recall functions as well. The save and recall functions, however, are only available if Option 71 is installed.

Operation procedure and description:

- ① Press the **[SYSTEM]** key (which is in the INSTRUMENT STATE block) to call the system menu.
- ② Press *{FUNCTION}* to call the function menu.
- ③ Press *{DRIVE LEVEL DEPENDENCY}* to call the DLD menu.
- ④ DLD menu
  - {DRIVE LEVEL DEPENDENCY ON/OFF}* : Toggles DLD measurements on or off.  
See "[DLD Operating Conditions](#)" below.
  - {DLD LEVEL}* : Calls the DLD level menu to set a level for DLD measurement (see ⑤)).
  - {DLD SWEEP TYPE [ ]}* : Calls the DLD sweep type menu to specify the level sweep method for DLD measurement (see ⑥).
  - {DLD FREQ}* : Calls the DLD frequency menu to specify the frequency for DLD measurement (see ⑦).
  - {DLD FORMAT}* : Calls the DLD format menu to specify a display format for DLD measurement (see ⑧).
  - {FINE SETUP}* : Calls the DLD detail setting menu to specify details for DLD measurement (see ⑨).

#### DLD Operating Conditions

- All conditions shown below must be met before using DLD:
  1. Calibration for either "Normalize" or TRANS-FULL-CAL must be performed
  2. The linear sweep type must be selected when performing the calibration in Step1.
  3. *{INTERPOLATE}* must be set to [ON].
  4. If *{DLD CENTER}* is [ENT], the value in *{CENTER ENTRY}* must be within the frequency range used when the calibration is performed.
  5. When *{DLD CENTER}* is [ZERO], search for phase 0° must be successful.
- The following conditions apply when DLD is ON. Failure to follow these conditions will result in an error (see Section 5.2.3):
  1. *{COUPLED CH ON}* is prohibited (COUPLE is turned off as soon as the DLD is turned on).
  2. *{CORRECT OFF}* is prohibited.
  3. *{INTERPOLATE OFF}* is prohibited.

5.2 Drive Level Measurement (DLD) Functions (Option 71)

4. Calibration data cannot be obtained again.
5. The smoothing function must be disabled.
6. Parameter conversion is fixed to  $\{Z(TRANS)\}$ .
7. Trace operation functions (such as DATA divided by MEM) are prohibited.
8. No standard measurement formats which can be selected by the [FORMAT] key are allowed (such as LOGMAG and PHASE).
9. DLD OFF must be used when changing the sweep type.
10. A stimulus used for normal sweep type cannot be changed.
11. Marker analysis functions (such as filter analysis) are partially prohibited and MARKER→ is prohibited.

⑤ DLD level menu

This menu sets a level used with DLD measurements.  
Each channel has its own settings.

- $\{START LEVEL [ ]\}$  : Sets the start level used with DLD (see Note).  
The value can be set according to the unit specified in  $\{LEVEL UNIT\}$ .  
The level is decreased if the start level is higher than the stop level; and increased if the start level is lower than the stop level.
- $\{STOP LEVEL [ ]\}$  : Sets the stop level used with DLD (see Note).  
The value can be set according to the unit specified in  $\{LEVEL UNIT\}$ .  
The level is decreased if the start level is higher than the stop level; and increased if the start level is lower than the stop level.  
When sweep type  $\{DLD SWEEP TYPE\}$  is set to  $\{UP\&\;DOWN\}$ , the level at the midpoint is used.
- $\{LEVEL UNIT [\Omega/dBm]\}$  : Selects the unit of the level used.  
The level axis is shown in plotting scale for dBm and logarithmic scale for  $\Omega$ .  
To convert a value into W, use the value used in  $\{TYPICAL C\}$ .
- $\{TYPICAL CI [ ]\}$  : Sets a typical crystal impedance value in the range 0.1 $\Omega$  to 1 k $\Omega$ . This value is used to convert the values between  $\Omega$  and dBm.
- $\{LEVELS [ ]\}$  : Sets the number of levels.  
When sweep type  $\{DLD SWEEP TYPE\}$  is  $\{UP\&\;DOWN\}$ , the range is between 3 and 300 inclusive.  
When sweep type  $\{DLD SWEEP TYPE\}$  is  $\{UP\ or\ DOWN\}$ , the range is between 3 and 600 inclusive.
- $\{Return\}$  : Returns to the DLD menu.

**Note:** This figure depends on CI (crystal impedance). For applicable power levels, see Figure 5-4 Maximum and Minimum Applicable Power to Crystal.



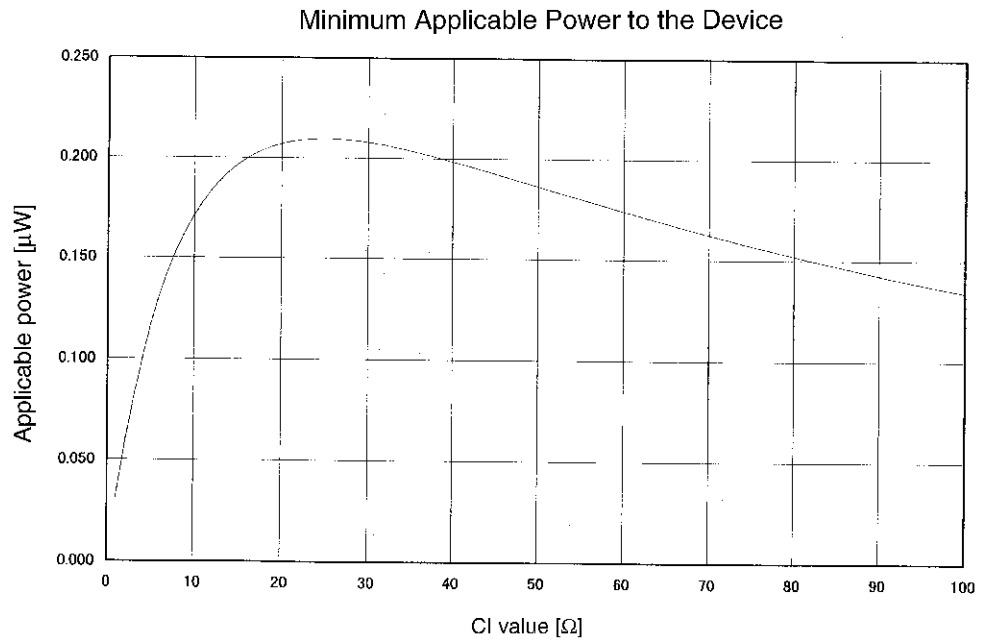
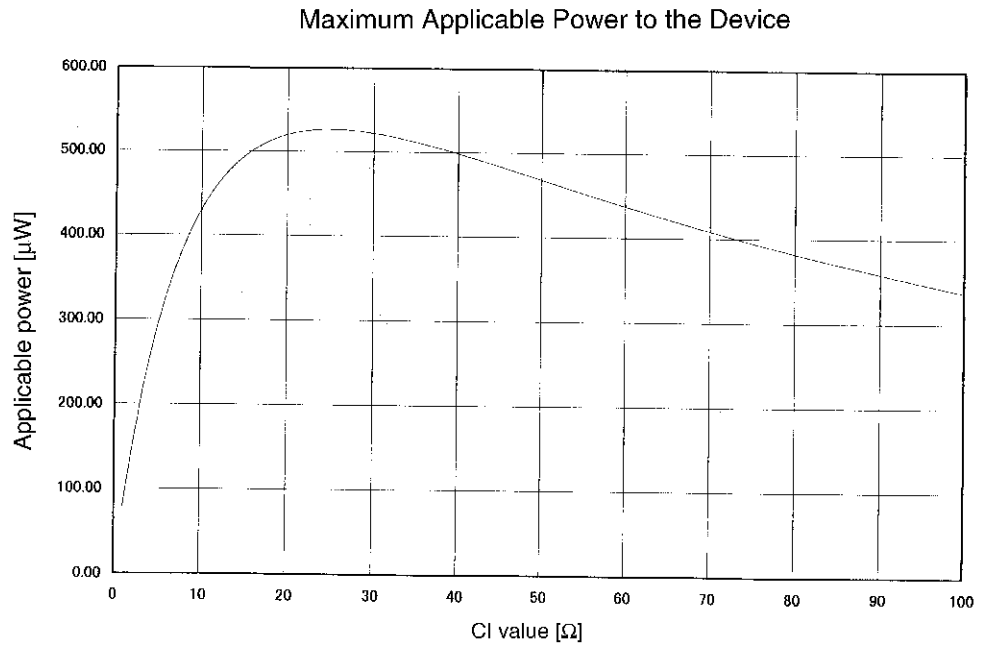

—— Maximum and minimum power

**Figure 5-4 Maximum and Minimum Applicable Power to Crystal**

5.2 Drive Level Measurement (DLD) Functions (Option 71)

⑥ DLD sweep type menu

This menu is used to set the level used with DLD measurements. Each channel has its own settings.

- {UP&DOWN}* : Selects UP&DOWN as the sweep type. Sweeps the measurement level from the start level to the stop level in units of  $[(\text{Stop} - \text{start}) / (\text{number of levels} - 1)]$ . Next, returns to the start level in units of  $[(\text{Start} - \text{stop}) / (\text{number of levels} - 1)]$  and stops.
- {UP or DOWN}* : Selects UP or DOWN as the sweep type. The stop level is calculated using the following formula, beginning with the start level, and then the operation stops:  $(\text{Stop} - \text{start}) / (\text{number of levels} - 1)$
- {USER LEVEL}* : Sweeps using the level set by the user.
- {EDIT USER LEVEL}* : Calls the user level edition menu (refer to ⑩).
- {Return}* : Returns to the DLD menu.

⑦ DLD frequency menu

This menu sets a frequency used with DLD measurements. Each channel has its own settings.

- {DLD CENTER [ENT/ZERO]}* : Specifies how to determine a center frequency used in DLD measurements.
  - ENT: The current value in *{CENTER ENTRY}* is unchanged even if DLD is turned on.
  - ZERO: When DLD is turned on, after searching for the point at phase 0, its frequency is copied to in *{CENTER ENTRY}*.
 In either case, the value in *{CENTER ENTRY}* is the center frequency used in DLD measurements.
- {CENTER ENTRY [ ]}* : Sets the center frequency used in DLD measurements. The value, which is set here, is the center frequency of the DLD sweep and the reference frequency (nominal frequency) used to calculate  $\Delta F$ . The initial value is the same as the center frequency of the linear sweep.
- {DLD SPAN [ ]}* : Specifies, for each level, a ppm value which is a ratio of the frequency span (of two-point sweep) to the center frequency.
- {Return}* : Returns to the DLD menu.

## ⑧ DLD format menu

Sets the display format used with DLD measurements.

CI (crystal impedance) and  $\Delta F$  are displayed in DLD measurements.

$\Delta F$  is the difference between the center frequency in DLD and measured resonance frequency.

The standard measurement format cannot be used when the DLD is turned on.

Each channel has its own settings.

*{CI& $\Delta F$ }* : Displays CI and  $\Delta F$ .  
CI is displayed as the first waveform;  $\Delta F$ , as the second waveform.

*{CI}* : Displays CI.

*{ $\Delta F$ }* : Displays  $\Delta F$ .

*{DLD LIST [ON/OFF]}* : Toggles the measurement result list display on or off.  
When the DLD LIST is turned on, the following information is displayed on the lower half of the screen:  
Level  
First waveform data  
Second waveform data

You can scroll through the display using [ $\uparrow$ ] and [ $\downarrow$ ] keys at this time.

When the DLD is turned off, only the level is displayed.

*{ $\Delta F$  UNIT [Hz/ppm]}* : Specifies the unit of  $\Delta F$ .  
 $\Delta F$  is a value relative to DLD center frequency.

*{Return}* : Returns to the DLD menu.

## ⑨ DLD detail setting menu

This menu is used to set the DLD measurement conditions.

Each channel has its own setting.

*{SETTLING [ON/OFF]}* : Toggles the settling for each valid (ON) or invalid point (OFF).

ON: The time specified by *{SETTLING TIME}* is set for all points.

OFF: No settling time is set.

*{SETTLING TIME}* set by user-defined level segments, however, are enabled when *{DLD SWEEP TIME}* is set to *{USER LEVEL}*.

5.2 Drive Level Measurement (DLD) Functions (Option 71)

- {SETTLING TIME [ ]}* : Sets the settling time.  
 This setting is enabled when *{SETTLING ON}* is turned on and when *{DLD SWEEP TYPE}* is set to a setting other than *{USER LEVEL}*.  
 This can be set in a range of 0 through 1.638 s at increments of 50  $\mu$ s.
- {DLD RBW[ ]}* : Sets the resolution bandwidth used with DLD measurements.
- {RBW AUTO [ON/OFF]}* : Selects whether or not to automatically set the resolution bandwidth used with DLD measurements.  
 ON: Automatically sets the RBW depending on each point on condition that the maximum RBW is the value specified in *{DLD RBW}*.  
 OFF: The RBW is a constant given in *{DLD RBW}*.  
 <Criteria to automatically set the RBW>  
 · For a point whose level is greater than -5 dBm, a constant saved in *{DLD RBW}* is used.  
 · For a point whose level is less than -5 dBm, the value in *{DLD RBW}* is divided by 10 each time the level is decreased by 10 dBm.  
 · For a point where the input amplifier is used, the RBW is multiplied by 10.
- {ATT&AMP AUTO [ON/OFF]}* : Selects whether or not to automatically set the input attenuator or preamplifier.  
 ON: Automatically sets an optimum real level (an expected value used in the R, A and B channels) for each point.  
 OFF: A constant set by the attenuator menu under **[FUNCTION]** is used for the R, A and B input channels.  
 <Criteria to automatically set ATT&AMP>  
 · For a point whose level is greater than -25 dBm, the ATT is 25 dB and the AMP is 0 dB.  
 · For a point whose level is greater than -40 dBm, the ATT is 0 dB and the AMP is 0 dB.  
 · For a point whose level is less than -40 dBm, the ATT is 0 dB and the AMP is 16 dB.
- {Return}* : Returns to the DLD menu.

## ⑩ User level edit menu

This menu edits the user-defined level segments.  
Each channel has its own settings.

- {LEVEL NUMBER [ ]}* : Specifies segment numbers.  
Segment numbers can be specified in the range of 0 through 255.
- {LEVEL [ ]}* : Sets the level of the specified segment.  
The value is set according to the unit specified in *{LEVEL UNIT}*.
- {SETTLING TIME [ ]}* : Sets the settling time of the specified segment.  
The range is from 0 to 1.638 s, and can be adjusted in increments of 50 $\mu$ s.
- {CLEAR}* : Deletes the contents of all segments.
- {Return}* : Returns to the DLD sweep type menu.

### 5.2.3 List of DLD Function Error Messages

**Note:** → marks explain supplemental remarks of error message list and problem-solving methods.

(1) Error

Please NORM or TRANS-FULL-CAL.  
(with LIN-FREQ)

When the DLD was tried to turn ON, the calibration had not been performed correctly.

→ Perform Normalize or Transmission Full Calibration in the linear sweep.

Please set INTERPOLATE ON.

When the DLD was tried to turn ON, INTERPOLATE was turned off.

→ Turn INTERPOLATE on.

DLD FREQ is outside CAL range.

The frequency specified by {CENTER ENTRY} is outside the calibration frequency range.

→ Correct {CENTER ENTRY} so that its' frequency is within the calibration frequency range, or perform the calibration again using frequencies including the one specified by {CENTER ENTRY}.

DLD ZERO PHASE search error.

Phase zero point could not be detected when DLD was turned on with {DLD CENTER} set to ZERO.

→ Change the measurement method so that it includes the phase zero point, or set {DLD CENTER} to ENT.

DLD USER LEVEL not entered.

{DLD SWEEP TYPE} was set to {USER LEVEL} with all user-defined level segments cleared.

→ Set the user-defined level segments.

Illegal DLD USER LEVEL points.

{DLD SWEEP TYPE} was turned to {USER LEVEL} when the number of entered user-defined level segments were less than three.

→ Set at least three user-defined level segments.

Can't ... When DLD ON.

One of more of the following prohibited settings existed while DLD was turned on:

1. *{COUPLED CH ON}* is prohibited (COUPLE is turned off the moment when the DLD is turned on).
2. *{CORRECT OFF}* prohibited
3. *{INTERPOLATE OFF}* prohibited
4. No calibration data can be obtained again.
5. The smoothing function must be disabled.
6. Parameter conversion is fixed to *{Z(TRANS)}*.
7. Trace operation functions (such as DATA divided by MEM) are prohibited.
8. No standard measurement formats are allowed (such as LOGMAG and PHASE).
9. DLD OFF must be used when changing the sweep type.
10. A stimulus used for normal sweep type cannot be changed.
11. MARKER → is prohibited.

→ Turn the DLD off.

## (2) Warnings

COUPLED CH turned off.

The DLD was turned on when COUPLED CH was set to on.

DLD turned off.

Sweep type was changed when the DLD was set to on.

DLD LEVEL changed.

*{START LEVEL}*, *{STOP LEVEL}* or *{LEVEL}* (in the user-defined level segment) was changed using the value set in *{TYPICAL CI}* when *{LEVEL UNIT}* was set to W.

→ Do not use the value set in *{TYPICAL CI}* to convert the unit to W.

DLD LEVELS changed.

*{DLD SWEEP TYPE}* was set to *{UP&DOWN}* when *{DLD LEVEL}* was greater than 301.

→ A maximum of 300 is allowed for *{DLD LEVELS}* when *{DLD SWEEP TYPE}* is set to *{UP&DOWN}*.

DLD CENTER FREQ changed.

The frequency at phase 0° point was stored in *{CENTER ENTRY}* when the DLD was turned on with *{DLD CENTER}* set to zero.

## 5.2.4 Initial Settings for DLD Functions

Function	Initialize method	
	Power on or preset	*RTS
DRIVE LEVEL DEPENDENCY	OFF	OFF
DLD LEVEL START LEVEL STOP LEVEL LEVEL UNIT TYPICAL CI LEVELS	-43dBm 5dBm dBm 10 $\Omega$ 51	-43dBm 21dBm dBm 10 $\Omega$ 51
DLD SWEEP TYPE	UP&DOWN	UP&DOWN
DLD FREQ DLD CENTER CENTER ENTRY DLD SPAN	ZERO 75.005MHz 10ppm	ZERO 75.005MHz 10ppm
DLD FORMAT DLD LIST $\Delta$ F UNIT	CI& $\Delta$ F OFF Hz	CI& $\Delta$ F OFF Hz
FINE SETUP SETTLING SETTLING TIME DLD RBW RBW AUTO ATT&AMP AUTO	ON 10ms 1kHz OFF OFF	ON 10ms 1kHz OFF OFF
EDIT USER LEVEL LEVEL NUMBER USER LEVEL segment	0 All clear	0 All clear



### 5.2.5 Soft Key Related GPIB Commands

Explanation of “O” and “N”

O: R3751 command mode

N: R3752H/53H/54 command mode

#### (1) DRIVE LEVEL DEPENDENCY

The drive level measurement menu

*{DRIVE LEVEL DEPENDENCY [ON/OFF]}*

O : DLD<bool>

N : [SOURCE:]DLDependency[<chno>]:STATE <bool>

*{DLD LEVEL}*

To the DLD level menu (1-1)

*{DLD SWEEP TYPE [ ]}* To the DLD sweep type menu(1-2)

O : DL{AND|OR|USER}

N : [SOURCE:]DLDependency[<chno>]:SWEep:TYPE  
{UADown|UODown|USER}

*{DLD FREQ}*

To the DLD frequency menu (1-4)

*{DLD FORMAT}*

To the DLD format menu (1-5)

*{FINE SETUP}*

To the detail setting menu (1-6)

*{RETURN}*

To the drive level measurement menu (1)

#### (1-1) DLD LEVEL

The DLD level menu

*{START LEVEL [ ]}*

O : DLSTARTL<real>

N : [SOURCE:]DLDependency[<chno>]:LEVel:START <real>

*{STOP LEVEL [ ]}*

O : DLSTOPL<real>

N : [SOURCE:]DLDependency[<chno>]:LEVel:STOP <real>

*{LEVEL UNIT [W/dBm]}*

O : DL{W|DBM}

N : [SOURCE:]DLDependency[<chno>]:LEVel:UNIT {watt|DBM}

*{TYPICAL CI [ ]}*

O : DLIMP<real>

N : [SOURCE:]DLDependency[<chno>]:LEVel:CIMPedance <real>

*{LEVELS [ ]}*

O : DLNUM<int>

N : [SOURCE:]DLDependency[<chno>]:LEVel:NUMBER <int>

*{Return}*

To the drive level measurement menu (1)

5.2 Drive Level Measurement (DLD) Functions (Option 71)

(1-2) DLD SWEEP TYPE

The DLD sweep type menu

- {UP&DOWN}*            O : DLAND  
                          N : [SOURCE:]DLDependency [<chno>]:SWEep:TYPE UADown
- {UP or DOWN}*        O : DLOR  
                          N : [SOURCE:]DLDependency [<chno>]:SWEep:TYPE UODown
- {USER LEVEL}*         O : DLUSER  
                          N : [SOURCE:]DLDependency [<chno>]:SWEep:TYPE USER
- {EDIT USER LEVEL}*    To the user level editing menu (1-3)
- {Return}*             To the drive level measurement menu (1)

(1-3) EDIT USER-LEVEL

The user level editing menu

- {LEVEL NUMBER [ ]}*    O : DLSEG<int>  
                          N : Specified by header parameter <n>
- {LEVEL [ ]}*            O : DLSEGL<real>  
                          N : [SOURCE:]DLDependency [<chno>]:SEGment<n>:LEVEl <real>
- {SETTLING TIME [ ]}*    O : DLSEGT<real>  
                          N : [SOURCE:]DLDependency [<chno>]:SEGment<n>:SETTLing <real>
- {CLEAR}*                O : DLSEGCL  
                          N : [SOURCE:]DLDependency [<chno>]:SEGment<n>:CLEAr:ALL
- {Return}*             To the DLD sweep type menu(1-2)

(1-4) DLD FREQUENCY

The DLD frequency menu

- {DLD CENTER [ENT/ZERO]}*  
                          O : DL{ENT|ZPH}  
                          N : [SOURCE:]DLDependency [<chno>]:FREQuency:MODE {ENTRy|ZPHase}
- {CENTER ENTRY [ ]}*    O : DLCENTERF<real>  
                          N : [SOURCE:]DLDependency [<chno>]:FREQuency:CENTer <real>
- {DLD SPAN [ ]}*        O : DLSPANF<real>  
                          N : [SOURCE:]DLDependency [<chno>]:FREQuency:SPAN <real>
- {Return}*             To the drive level measurement menu (1)

## (1-5) DLD FORMAT

The DLD format menu

<i>{CI&amp;ΔF}</i>	O : DLCD N : CALCulate[<chno>]:DLDependency:FORMat BOTH
<i>{CI}</i>	O : DLCI N : CALCulate[<chno>]:DLDependency:FORMat CIMPedance
<i>{ΔF}</i>	O : DLDF N : CALCulate[<chno>]:DLDependency:FORMat DFRequency
<i>{DLD LIST [ON/OFF]}</i>	O : DLLIST<bool> N : DISPlay:DLDependency[<chno>]:LIST <bool>
<i>{ΔF UNIT [Hz/ppm]}</i>	O : DL{HZ PPM} N : CALCulate[<chno>]:DLDependency:FORMat:UNIT {HertZ PPM}
<i>{Return}</i>	To the drive level measurement menu (1)

## (1-6) FINE SETUP

The detail setting menu

<i>{SETTLING [ON/OFF]}</i>	O : DLSETL<bool> N : [SOURce:]DLDependency[<chno>]:SETTLing:STATe <bool>
<i>{SETTLING TIME [ ]}</i>	O : DLSETLT<real> N : [SOURce:]DLDependency[<chno>]:SETTLing <real>
<i>{DLD RBW [ ]}</i>	O : DLRBW<real> N : [SENSe:]DLDependency[<chno>]:BANDwidth[:RESolution] <real>
<i>{RBW AUTO [ON/OFF]}</i>	O : DLRBWAUTO<bool> N : [SENSe:]DLDependency[<chno>]:BANDwidth[:RESolution]:AUTO <bool>
<i>{ATT&amp;AMP AUTO [ON/OFF]}</i>	O : DLATTAUTO<bool> N : [SENSe:]DLDependency[<chno>]:ATT:AUTO <bool>
<i>{Return}</i>	To the drive level measurement menu (1)

### 5.3 Three-terminal Resonator Measurement Function (Option 72)

#### 5.3 Three-terminal Resonator Measurement Function (Option 72)

This function is designed to measure three-terminal resonator characteristics (excluding the load capacitance) and the load capacitance at high speeds by connecting this instrument to the R17041 (three-terminal measurement fixture).

When no fixtures is available, three-terminal resonators can be measured by entering their load capacitance. Two-terminal resonators can also be measured.

Note: The following restrictions apply when using this function:

- Crosstalk cannot be applied for all frequencies.
- "1 Port Full Cal" and "Trans Full Cal" cannot be used at the same time.

<How to Use "1 Port Full Cal" and "Trans Full Cal" with Option 72 Installed>

"1 Port Full Cal" or "Trans Full Cal" cannot be selected from the calibration menu when Option 72 is installed.

To use "1 Port Full Cal" or "Trans Full Cal," turn the instrument power off, then on using the procedure shown below:

- ① Press **[SYSTEM]** and *{SERVICE MENU}* to display the service menu.
- ② Press *{IMPEDANCE CAL[ON/OFF]}* to turn impedance cal mode off.
- ③ Turn the power off. When the power is turned on again, the calibration menu (which is displayed by pressing **[CAL]** and *{CALMENU}*) is switched to the standard menu so that "1 Port Full Cal" or "Trans Full Cal" can be used.

While this change is in effect, Option 72 cannot be used.

If you wish to use Option 72, turn on *{IMPEDANCE CAL[ON/OFF]}* in the service menu and turn the instrument power off, then on.

### 5.3.1 A Measurement Example Using Three-terminal Resonator

This section shows a measurement example using a three-terminal resonator, whose oscillation frequency is 4 MHz.

- ① Set up the instrument (connect the R17041 three-terminal measurement fixture) and perform a preset.

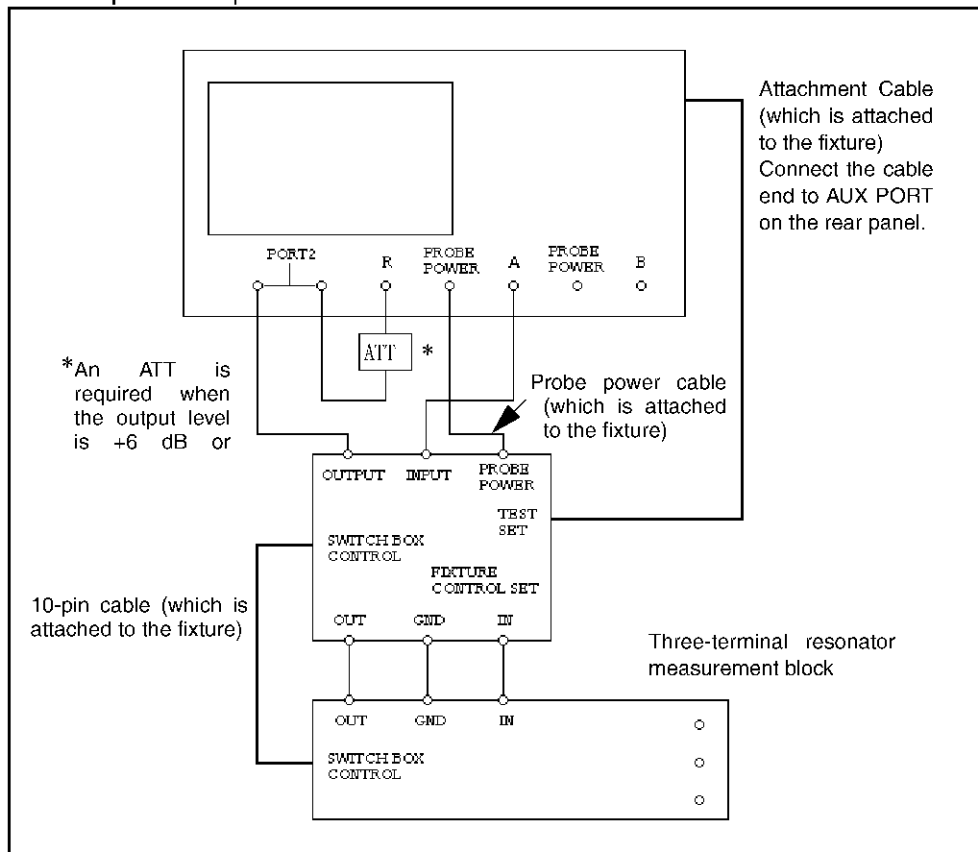

Figure 5-5 Connecting the Three-terminal Measurement Fixture to This Instrument

- ② Set the center frequency and the span.

[CENTER] → [4] → [MHz]  
 [SPAN] → [5] → [0] → [0] → [kHz]

- ③ Set the input attenuator to 25 dB.

[ATT] → {Rch ATT} → {INPUT ATT 25dB}  
 {Return} → {Ach ATT} → {INPUT ATT 25dB}

- ④ Set the resolution bandwidth.

[AVG] → [1] → [kHz]

- ⑤ Set the frequency used to measure load capacitance to 1 MHz.

[CAL] → {CAL MENU} → {C-MEASURE FREQ} → [1] → [MHz]

5.3 Three-terminal Resonator Measurement Function (Option 72)

- ⑥ Sets the measurement mode to load capacitance.

Set {C-MEASURE[ON/OFF]} to ON.

- ⑦ Obtain the calibration data.

Call the impedance cal menu and obtain the calibration data.  
Perform an open cal without connecting anything to the test port.

Press {IMPEDANCE CAL} and {OPEN}.

The message "Wait for Sweep" is displayed after each calibration is executed, and the calibration data is collected. When this message disappears, the calibration data has been obtained.

**Note: Do not move this instrument, the connecting cables, the connectors, the standard or any other related instrument while the message is displayed.**

The screen display is shown in Figure 5-6.

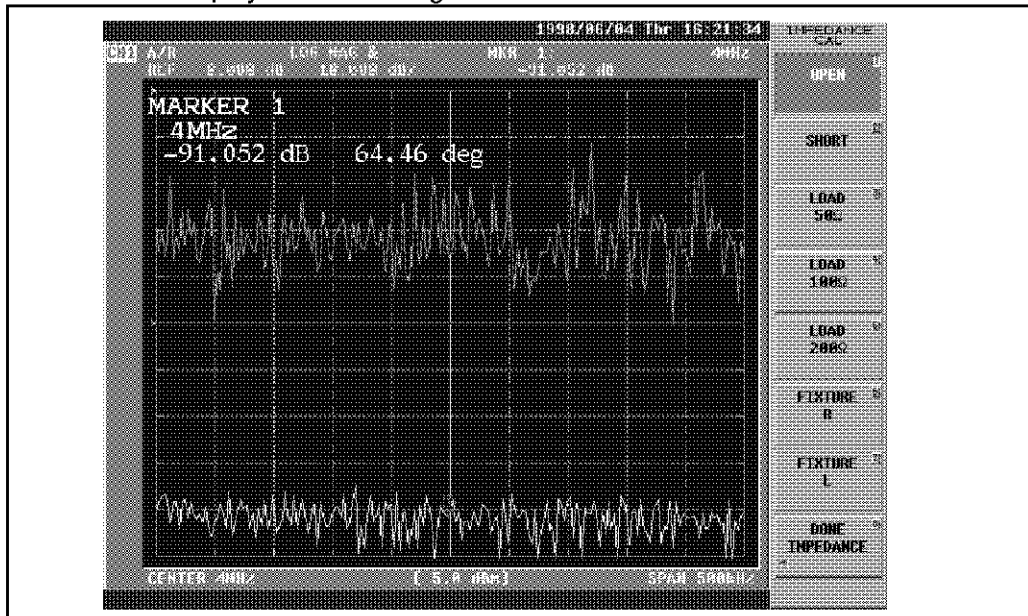

Figure 5-6 Screen Showing the Execution of Open Cal

## 5.3 Three-terminal Resonator Measurement Function (Option 72)

- ⑧ Perform the short cal by connecting a short standard to the test port.

{SHORT}

The screen display is shown in Figure 5-7.

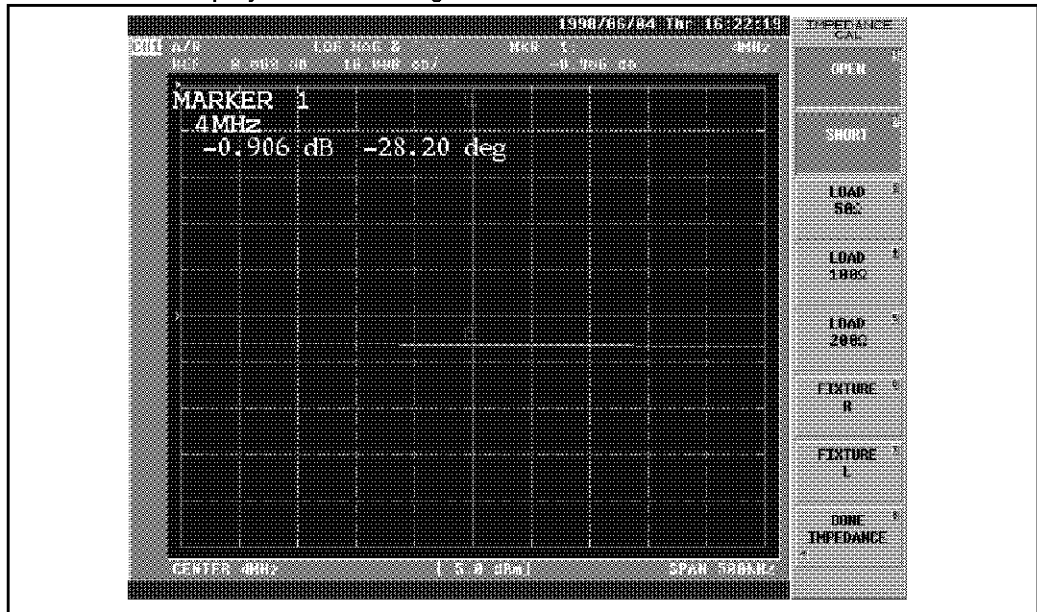

Figure 5-7 Screen Showing the Execution of Short Cal

- ⑨ Perform the load cal by connecting a 51Ω standard to the test port.

{LOAD 50Ω}

The screen display is shown in Figure 5-8.

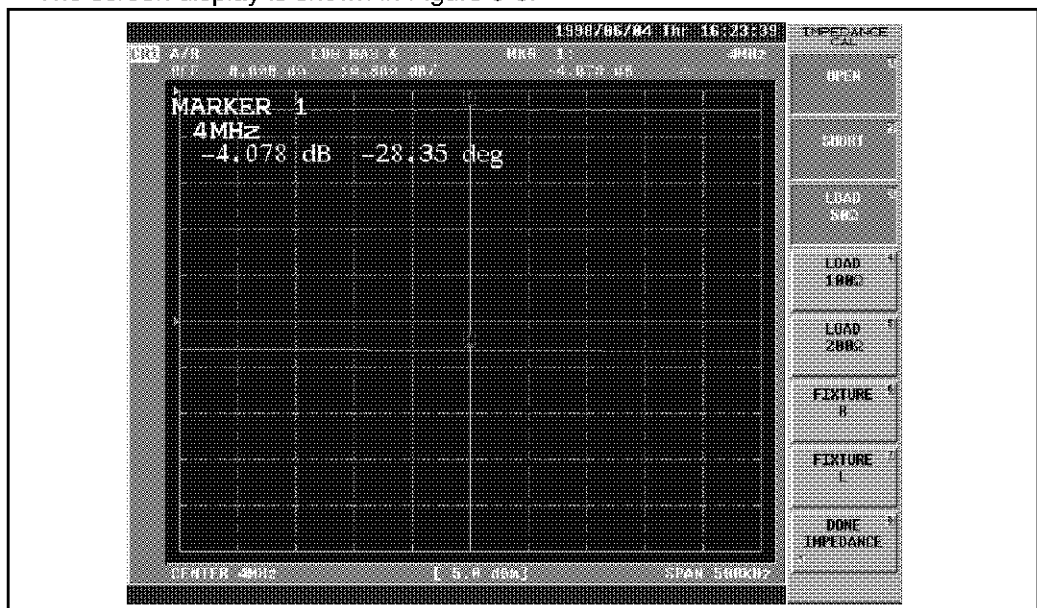

Figure 5-8 Screen Showing the Execution of Load Cal (50Ω)



5.3 Three-terminal Resonator Measurement Function (Option 72)

- ⑩ Perform the load cal by connecting a 100Ω standard to the test port.

{LOAD 100Ω}

The screen display is shown in Figure 5-9.

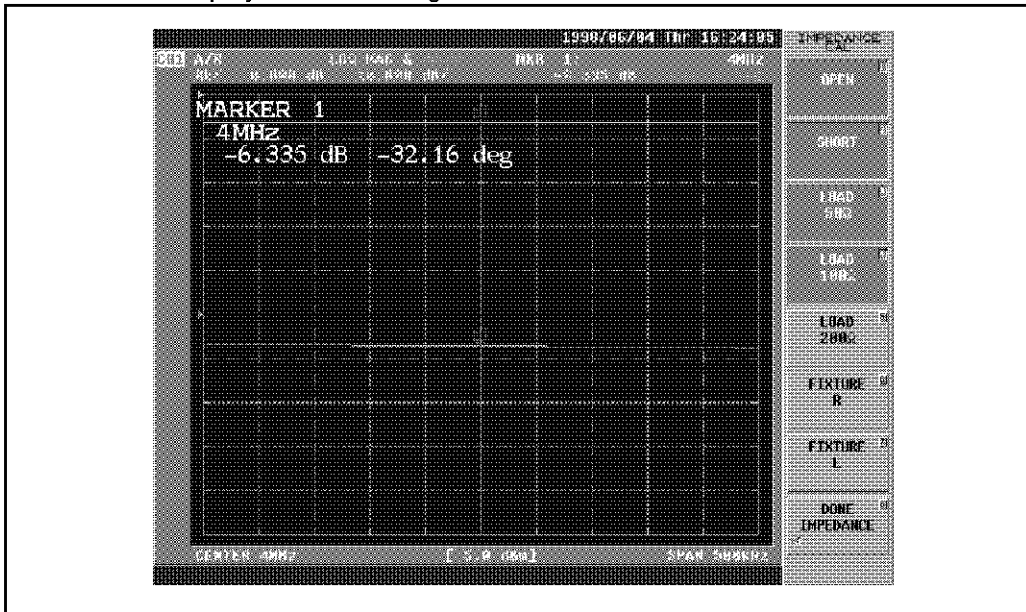

Figure 5-9 Screen Showing the Execution of Load Cal (100Ω)

- ⑪ Perform the load cal by connecting a 200Ω standard to the test port.

{LOAD 200Ω}

The screen display is shown in Figure 5-10.

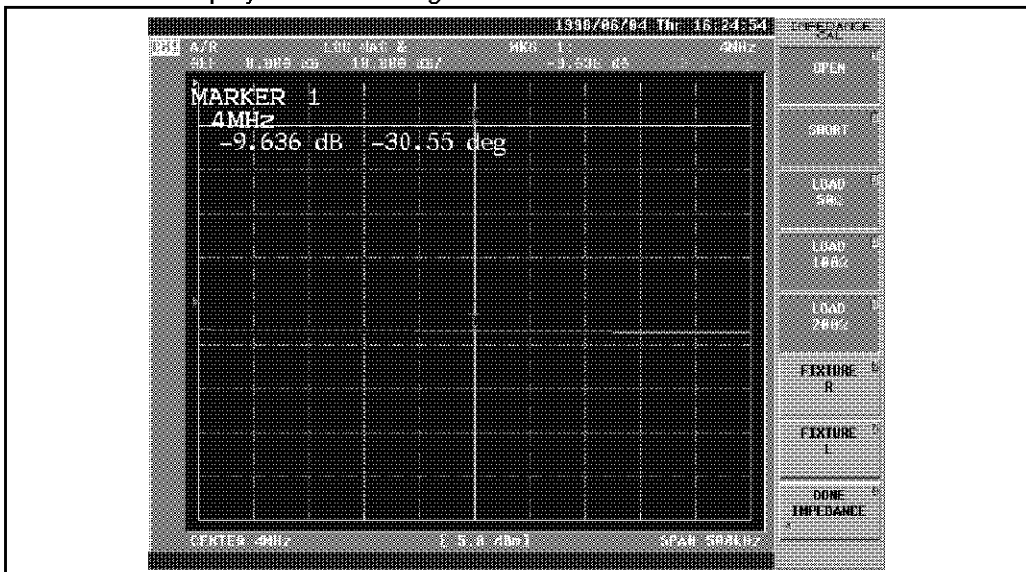

Figure 5-10 Screen Showing the Execution of Load Cal (200 Ω)



## 5.3 Three-terminal Resonator Measurement Function (Option 72)

- ⑫ Perform the correction.

{*DONE IMPEDANCE*}

- ⑬ Read the measured value using the marker.

[MKR] → {*MARKER MODE MENU*} → {*CONVERSION MKR MENU*} → {*LIN MKR*}

The screen display is shown in Figure 5-11. From here you can measure the load capacitance.

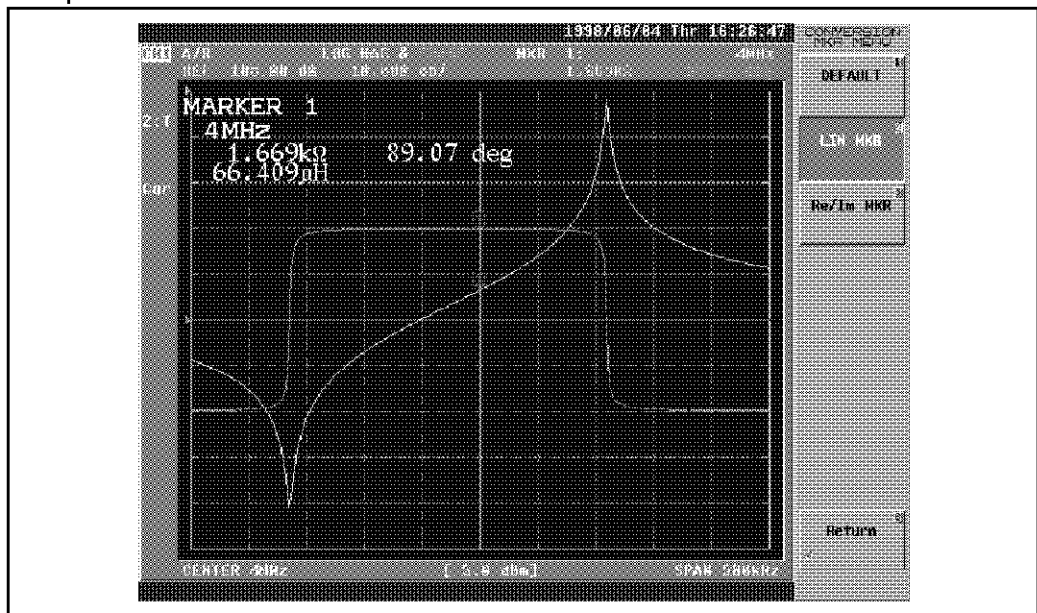

Figure 5-11 Measuring a Three-terminator Resonator

5.3 Three-terminal Resonator Measurement Function (Option 72)

5.3.2 Operating Keys of Three-terminal Resonator Measurement

This section describes how to operate the keys associated with the three-terminal resonator measurement function.

**Note:** *The three-terminal resonator measurement function supports the save (store) and recall (read) functions as well.*

*The read function, however, is only available if Option 72 is installed.*

Operation procedure and description:

- ① Press [CAL] and {CAL MENU} to call the calibration menu.

- ② Calibration menu

{IMPEDANCE CAL} : Calls the impedance cal menu.  
This menu cannot be called if a calibration has being performed.

{C-MEASURE[ON/OFF]} : Toggles the load capacitance measurement on or off.  
ON: Used to measure three-terminal resonator's load capacitance.  
OFF: Used to measure two- or three-terminal resonators by entering the load capacitance.

{C-MEASURE FREQ} : Used to enter the measurement frequency for the load capacitance. The measurement frequency can also be changed after the calibration. The error, however, becomes larger than before.

Set a frequency for which the resonator's impedance is higher. For example, if you use a resonator whose frequency is 2 MHz or higher, set the measurement frequency to either 1 MHz or its antiresonant frequency.

{C-high} : Used to enter the load capacitance of the input side when the load capacitance measurement is turned off ({C-MEASURE[OFF]}). Used to display a measured value of the input side when the load capacitance measurement is turned on ({C-MEASURE[ON]}).

The load capacitance value can be changed after the measurement. Perform a SINGLE sweep to change the value.

{C-low} : Used to enter the load capacitance of the output side when the load capacitance measurement is turned off ({C-MEASURE[OFF]}). Used to display a measured value of the output side when the load capacitance measurement is turned on ({C-MEASURE[ON]}).

The load capacitance value can be changed after the

## 5.3 Three-terminal Resonator Measurement Function (Option 72)

measurement. Perform a SINGLE sweep to change the value.

{CLEAR CAL DATA} : Clears the calibration data.  
This data can be cleared only when CORRECT is set to OFF.

## ③ Impedance cal menu

{FIXTURE R} : Enter R of the GND terminal on the three-terminal resonator measurement fixture (see Note 1).

{FIXTURE L} : Enter L of the GND terminal on the three-terminal resonator measurement fixture (see Note 1).

{OPEN} : Obtains calibration data when no standard is connected.  
Do not connect anything to the measurement port when performing this function (see Note 2).

{SHORT} : Obtains calibration data when a short standard is connected.  
Connect the short standard to the measurement port when performing this function (see Note 2).

{LOAD 50Ω} : Obtains calibration data when a 51Ω standard is connected.  
Connect the 51Ω standard to the measurement port when performing this function (see Note 2).

{LOAD 100Ω} : Obtains calibration data when a 100Ω standard is connected.  
Connect the 100Ω standard to the measurement port when performing this function (see Note 2).

{LOAD 200Ω} : Obtains calibration data when a 200Ω standard is connected.  
Connect the 200Ω standard to the measurement port when performing this function (see Note 2).

{DONE IMPEDANCE} : Performs the calibration.

**Note1:** The values of R and L are 0 (zero) in the initial state. These values cannot be entered unless you clear the calibration data (refer to Section 4.5.8, "Calibration Data Clear").

**Note2:** Calibration data is collected while the "Wait for Sweep" message is displayed. The calibration data has successfully been obtained when this message disappears from the screen.

**Do not move this instrument, the connecting cables, the connectors and the standard while this message is displayed.**

---

### 5.3 Three-terminal Resonator Measurement Function (Option 72)

#### ④ Service menu

Press [**SYSTEM**] and {*SERVICE MENU*} to display the service menu.

If Option 72 is installed, {*IMPEDANCE CAL[ON/OFF]*} is displayed in the service menu.

{*IMPEDANCE CAL[ON/OFF]*}:

Switches the calibration menu between on and off.  
To enable this setting, be sure to turn the instrument power off, then on.

ON: Allows you to use the three-terminal resonator measurement function (Option 72).  
"1 Port Full Cal" ({*1PORT FULL CAL*}) and "Trans Full Cal" ({*TRANS FULL CAL*}) cannot be used.

OFF: Prevents you from using the three-terminal resonator measurement function (Option 72).  
"1 Port Full Cal" ({*1PORT FULL CAL*}) and "Trans Full Cal" ({*TRANS FULL CAL*}) can be used.

#### **CAUTION!**

- 1. When calibration data has already been obtained, set the calibration setting to OFF and clear the data, then restart the calibration. The full calibration operation cannot be performed to prevent the calibration data loss by miss operation during the calibration or if the data existed.*
- 2. Each calibration data can be obtained again before pressing the {*DONE IMPEDANCE*}.*
- 3. The measurement frequency of the load capacitance can be changed after the calibration with the load capacitance measurement set to on ({*C-MEASURE[ON]*}), but doing so increases the calibration error.  
If the new frequency is a lot different from the one you set prior to the calibration, the {*C-high*}, {*C-low*} and measured values may not be accurate.*

### 5.3.3 Error Messages on the Three-Terminal Resonator Measurement Function

There are no error messages which are directly related to Option 72.

### 5.3.4 GPIB Commands Corresponding to the Soft Keys

Explanation of “O” and “N”

O: R3751 command mode

N: R3752H/53H/54 command mode

#### (1) Cal selection menu

<i>{IMPEDANCE CAL}</i>	Returns to the impedance cal menu.
<i>{C-MEASURE []}</i>	O : CMEAS<bool> N : [SENSE:]CORRection[<chno>]:CMEasure <bool>
<i>{C-MEASURE FREQ}</i>	O : CMFREQ<real> N : [SENSE:]CORRection[<chno>]:CMFRequency <real>
<i>{C-high}</i>	O : IMPCH<real> N : [SENSE:]CORRection[<chno>]:LCApactance:HIGH <real>
<i>{C-low}</i>	O : IMPCL<real> N : [SENSE:]CORRection[<chno>]:LCApactance:LOW <real>
<i>{CLEAR CAL DATA}</i>	O : CLEAR N : [SENSE:]CORRection[<chno>]:COLLect:DELeTe

#### (2) Impedance cal menu

<i>{OPEN}</i>	O : IMPOPEN N : [SENSE:]CORRection[<chno>]:COLLect[:ACQuire] TOPen
<i>{SHORT}</i>	O : IMPSHORT N : [SENSE:]CORRection[<chno>]:COLLect[:ACQuire] IShort
<i>{LOAD 50Ω}</i>	O : IMPLD50 N : [SENSE:]CORRection[<chno>]:COLLect[:ACQuire] ILoad50
<i>{LOAD 100Ω}</i>	O : IMPLD100 N : [SENSE:]CORRection[<chno>]:COLLect[:ACQuire] ILoad100
<i>{LOAD 200Ω}</i>	O : IMPLD200 N : [SENSE:]CORRection[<chno>]:COLLect[:ACQuire] ILoad200
<i>{DONE IMPEDANCE}</i>	O : DONEIMP N : [SENSE:]CORRection[<chno>]:COLLect:SAVE



## 6 PERFORMANCE TEST

This chapter describes testing procedures designed to maintain this analyzer's efficiency. For items not covered in this chapter, contact ADVANTEST.

### 6.1 Preparing for a Performance Test

(1) Warm up

Warm up the R3754 Series for at least 30 minutes before executing the performance test.

(2) Preparing measurement instruments

The following measurement instruments are required to perform the test items as shown in Table 5-1.

**Table 6-1 Required Measurement Instruments for Performance Test (1 of 2)**

Test items	Measurement instrument		Remarks
1. Frequency accuracy and range	<ul style="list-style-type: none"> <li>Counter Frequency: 10kHz to 150MHz Display: 7 digits or more Accuracy: 0.1ppm or less</li> </ul>	Model R5372 (to 18GHz) or Model R5373 (to 26GHz) (Manufactured by ADVANTEST)	Refer to section 6.2
	<ul style="list-style-type: none"> <li>BNC-BNC cable</li> </ul>		
2. Output/ Input level and flatness	<ul style="list-style-type: none"> <li>Power meter Frequency: 100kHz to 150MHz Power range: -43dBm to +21dBm</li> </ul>	HP436A (HP437B) (HP438A) (Calibrated under the national standard)	Refer to section 6.3
	<ul style="list-style-type: none"> <li>Power sensor Frequency: 100kHz to 150MHz Power range: -43dBm to +21dBm</li> </ul>	HP8482A	
3. Output level linearity	<ul style="list-style-type: none"> <li>Power meter Frequency: 100kHz to 150MHz Power range: -43dBm to +21dBm</li> </ul>	HP436A (HP437B) (HP438A) (Calibrated under the national standard)	Refer to section 6.4
	<ul style="list-style-type: none"> <li>Power sensor Frequency: 100kHz to 150MHz Power range: -43dBm to +21dBm</li> </ul>	HP8482A	

6.1 Preparing for a Performance Test

**Table 6-1 Required Measurement Instruments for Performance Test (2 of 2)**

Test items	Measurement instrument		Remarks
4. Spectral purity (Phase noise)	• Spectrum analyzer 10kHz to 150MHz	R3265A (to 8GHz) (Manufactured by ADVANTEST)	Refer to section 6.5
	• BNC cable		
	• N-BNC conversion connector		
5. Input return loss	• Network analyzer 300kHz to 500MHz	R3763B (to 3GHz) (Manufactured by ADVANTEST)	Refer to section 6.6
	• Calibration kit	MODEL9617K3 (Recommended by ADVANTEST)	
	• BNC cable (60cm or less)		
	• N-BNC conversion connector		
6. Input level accuracy (Absolute value measurement)	• Power meter Frequency: 50MHz Power range: -10dBm to +10dBm	HP436A (HP437B) (HP438A) (Calibrated under the national standard)	Refer to 6.7
	• BNC cable (60cm or less)		
7. Input level accuracy (Absolute value measurement)	• BNC cable × 2 (60cm or less)		Refer to section 6.8
10. Crosstalk	• BNC terminator		Refer to section 6.11
	• BNC cable (60cm or less)		

(3) General note

- Use an AC power source having a voltage of 100V to 120V, 220V to 240V and a frequency of 48Hz to 66Hz.
- Connect the power supply cable only after turning off the power switch.
- The R3754 Series should be free from dust, vibration and noise and be tested under the following conditions:  
 Temperature : 23°C ± 5°C  
 Relative humidity : 80% or less



## 6.2 Frequency Accuracy and Range

### Testing procedure

- ① Setup the R3754 Series as shown in the figure below.

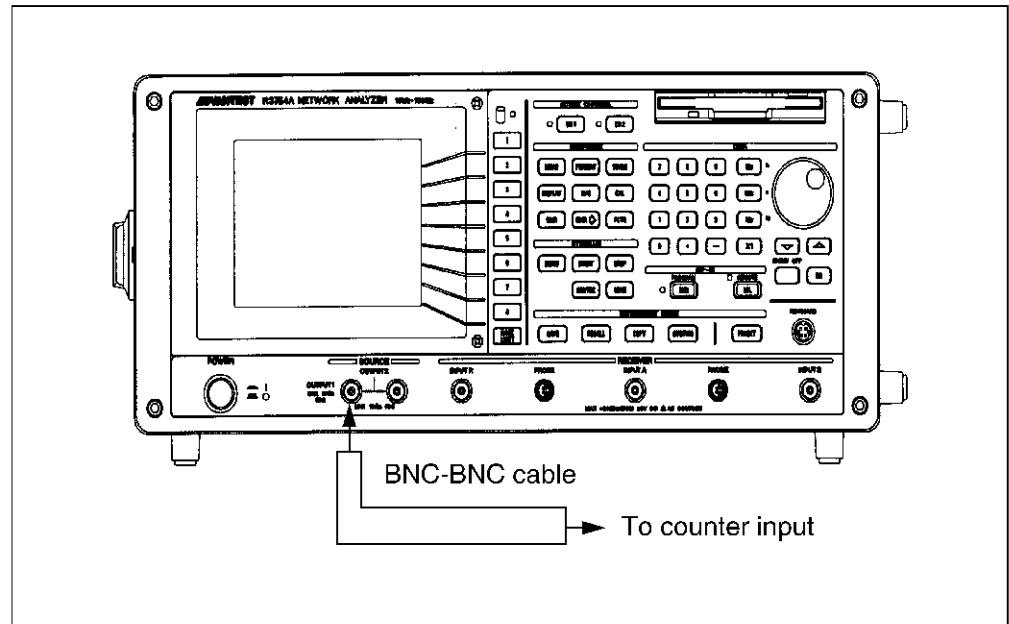

Figure 6-1 Frequency Accuracy and Range

- ② Set the R3754 Series as follows.
  - Span : 0Hz
  - Sweep mode : SINGLE
  - Output port : OUTPUT1
- ③ Change any center frequency in the range of 10kHz to 150MHz.
- ④ Check that the counter read frequency  $< \text{center frequency} \pm \text{center frequency} \times 5 \times 10^{-6}$ 
  - Example: When the center frequency is at 10MHz, the range is 10MHz  $\pm$  50Hz (that is between 9,999,950Hz and 10,000,050Hz).

6.3 Output Level Accuracy and Flatness

### 6.3 Output Level Accuracy and Flatness

Testing procedure

- (1) Setup the R3754 Series as shown in the figure below.

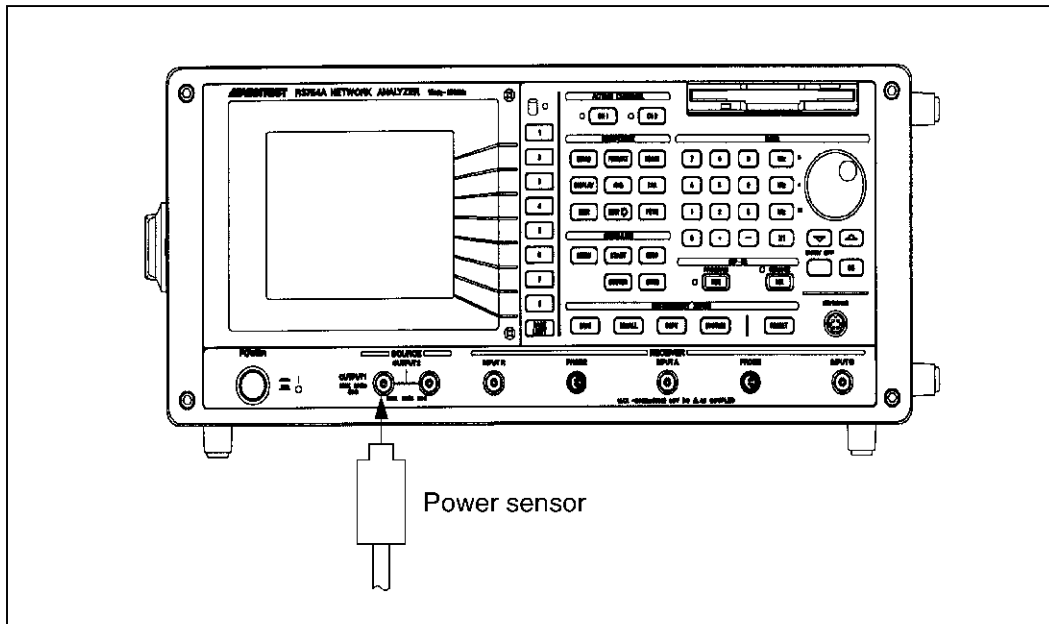

Figure 6-2 Output Level Accuracy and Flatness

- (2) Output level accuracy
  - ① Perform the ZERO calibration for the power meter.
  - ② Set the R3754 Series as follows.
    - Center frequency : 10MHz
    - Span : 0Hz
    - Output level : 0dBm
    - Output port : OUTPUT1
  - ③ Connect the power sensor to the output terminal and perform the measurement.  
**Note: The calibration factor should be set to 10MHz.**
  - ④ Check the output level accuracy of  $\pm 0.5\text{dB}$  at 0dBm and 10MHz.

(3) Flatness

- ① Perform the ZERO calibration for the power meter.
- ② Set the R3754 Series as follows.  
Center frequency : 10MHz  
Span : 0Hz  
Output level : 0dBm
- ③ Press the **[REL]** key on the power meter and set it to 0dB (ratio measurement mode).
- ④ The span and the output level are fixed. Change the center frequency and read data from the power meter.

**Note:** Use the calibration factor at the center frequency.

- ⑤ Check that the Flatness of 0dBm is as follows.  
10kHz to 300kHz :  $\pm 2.0$ dB  
300kHz to 150MHz :  $\pm 1.5$ dB

6.4 Output Level Linearity

### 6.4 Output Level Linearity

Testing procedure

- ① Perform the ZERO calibration for the power meter.
- ② Set the R3754 Series as follows.  
Center frequency : 10MHz  
Span : 0Hz  
Output level : 0dBm  
Output port : OUTPUT1
- ③ Connect the power sensor to the output terminal as shown in the figure below.

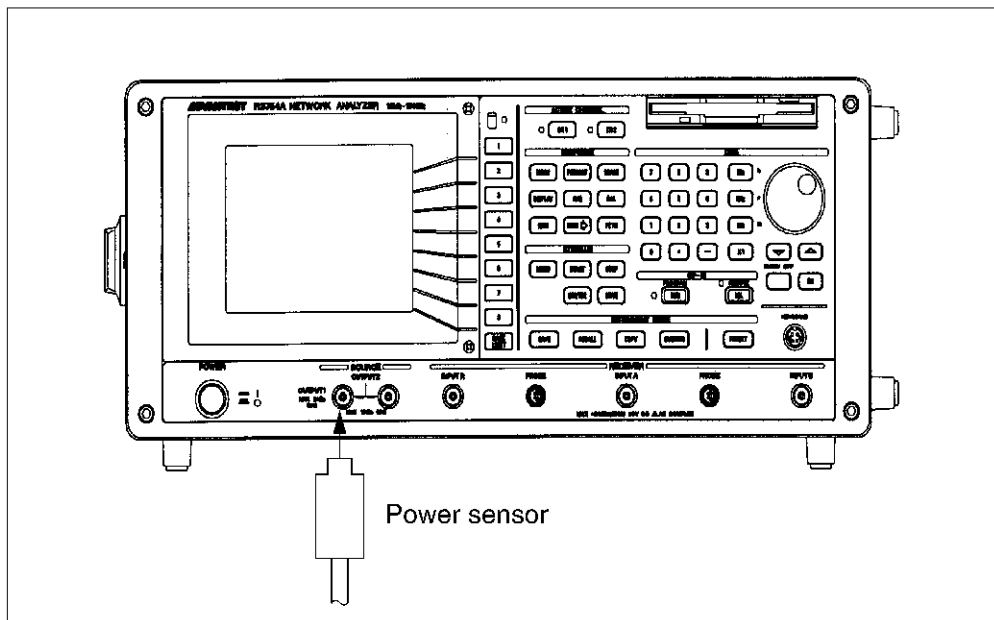

Figure 6-3 Output Level Linearity

- ④ Press the [REL] key on the power meter and set it to 0dB (ratio test mode).
- ⑤ Obtain the linearity data when the output level is changed.

**Note:** The calibration factor should be set to 10MHz.

- ⑥ Check that the output level linearity of 0dBm is as follows.

+21dBm to -35dBm :  $\pm 0.5$ dB  
-35dBm to -43dBm :  $\pm 1.5$ dB

## 6.5 Spectrum Purity (Phase Noise)

### Testing procedure

- ① In order to measure the spectrum purity, connect the R3754 Series and the spectrum analyzer, R3265A as shown in Figure 6-4.

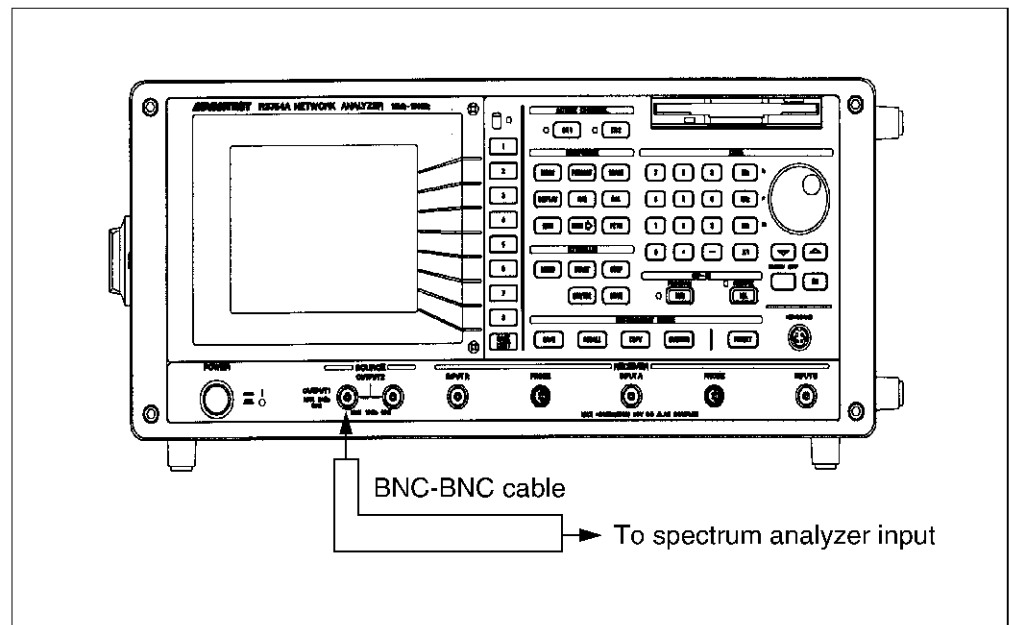

Figure 6-4 Spectrum Purity

- ② Set the R3754 Series as follows. (Other settings should be left at default values.)
 

Span frequency	: 0Hz
Sweep mode	: SINGLE
Output port	: OUTPUT1
- ③ Change any center frequency in the measurement range of the spectrum analyzer. (Setting range: 10kHz to 150MHz)
- ④ Set the spectrum analyzer as follows.
 

Center frequency	: Center frequency set to the R3754 Series
Span frequency	: 50kHz
Resolution band width	: 1kHz
Average	: 32
- ⑤ After performing a peak search to get the MAX data, use the Delta Marker function to obtain the value at a point of +10kHz higher. (Obtain a difference between the MAX value and the data at a point of +10kHz higher.)
- ⑥ Check: (readout of the difference) - 30dB < -95dBc/Hz.

6.6 Input Return Loss

## 6.6 Input Return Loss

Testing procedure

- ① In order to measure the input return loss, connect the network analyzer, R3763B as shown in Figure 6-5.

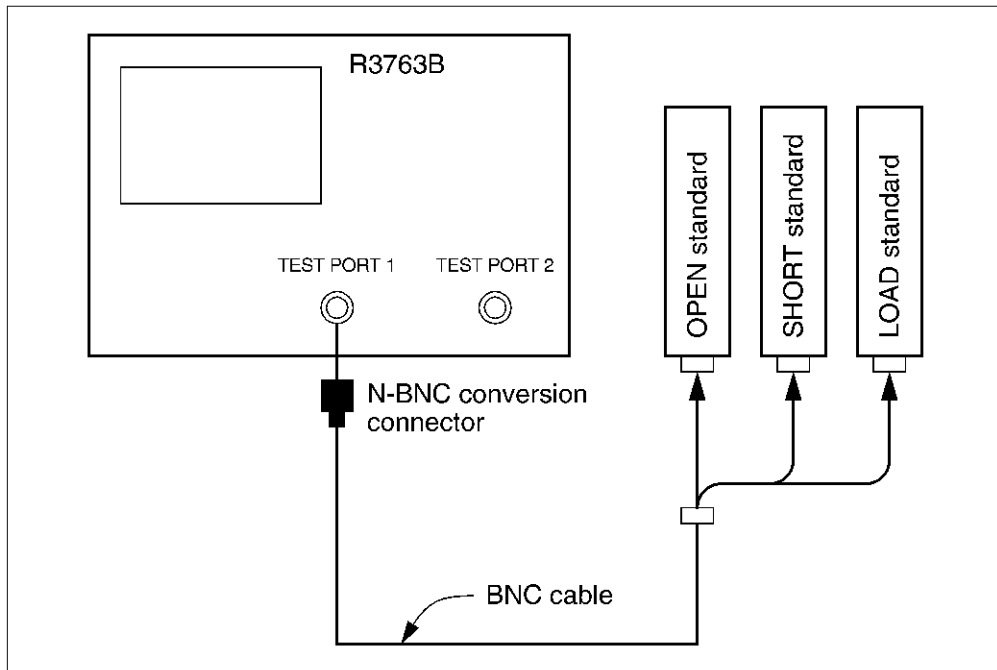
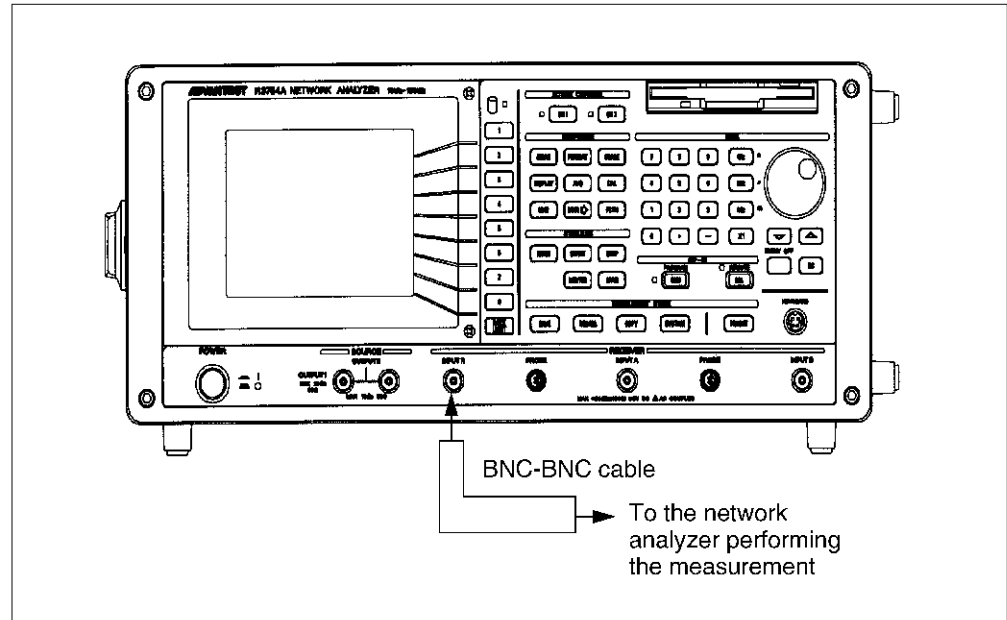

Figure 6-5 Connection for Measuring Return Loss

- ② When performing measurements, set the R3763B as follows.  
(Other settings should be left at default values.)  
Start frequency : 300kHz  
Stop frequency : 150MHz  
Measure :  $S_{11}$   
Resolution band width : 100Hz
- ③ Perform the 1PORT FULL calibration.
  - (a) Press the **[CAL]** → {CAL MENU} → {1PORT FULL CAL} button.
  - (b) Connect the Open standard at the end of the BNC cable and press the {OPEN} button.
  - (c) Connect the Short standard at the end of the BNC cable and press the {SHORT} button.
  - (d) Connect the Load standard at the end of the BNC cable and press the {LOAD} button.
  - (e) Press the {DONE 1-PORT} key.

- ④ Connect R3763B to the Input Port R of the R3754 Series with the BNC cable as shown in the figure below.



**Figure 6-6 Input Return Loss**

- ⑤ Set the R3754 Series as follows.  
(Other settings should be left at default values.)
- |                  |  |
|------------------|--|
| Center frequency | : 10kHz                                      |
| Span frequency   | : 0Hz  |
| Input attenuator | : 20dB                                       |
| Sweep mode       | : SINGLE (This setting should be made last.) |
- ⑥ When the input return loss is to be measured, check that the readout of the R3763B is as follows.
- Maximum value between 10kHz and 150MHz < -25dB
- ⑦ Set the R3754 Series as follows and sweep once using the SINGLE sweep mode.
- Input attenuator : 0dB
- ⑧ When the input return loss is being measured, check that the readout of the R3763B is as follows.
- Maximum value between 10kHz and 150MHz < -20dB
- ⑨ For model with Option 11, perform the same tasks for the Input Port A and the Input Port B.  
For model with Option 10, perform the same tasks for the Input Port A.

## 6.7 Input Level Accuracy (Absolute value measurement)

Testing procedure

- ① Perform the ZERO calibration for the power meter.
- ② Setup the R3754 Series as shown in the figure below.

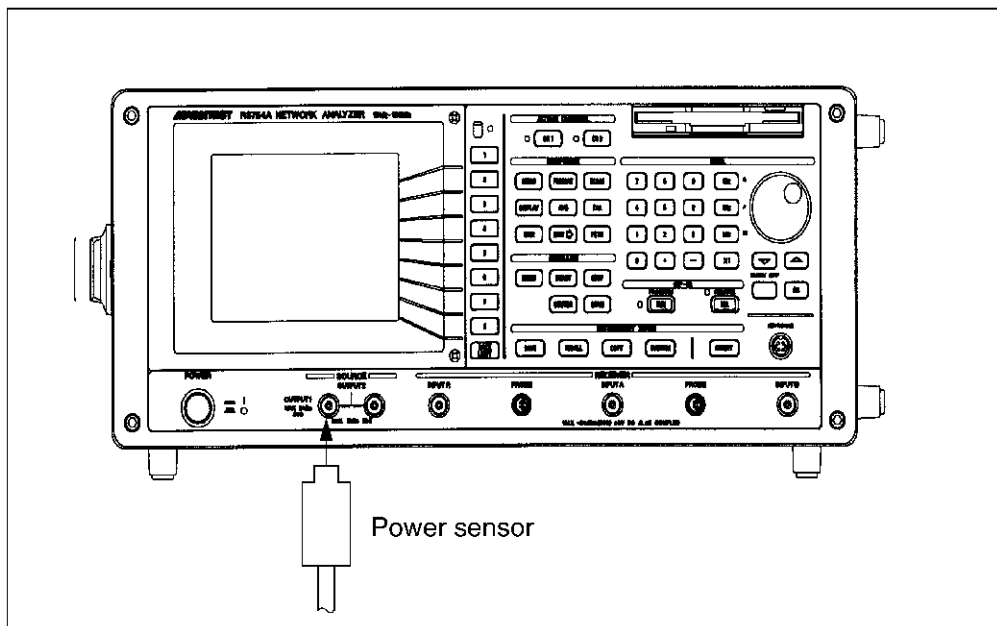

Figure 6-7 Input Level Accuracy (Output Level Calibration)

- ③ Set the R3754 Series as follows.  
(Other settings should be left at default values.)  
Center frequency : 10MHz  
Span frequency : 0Hz  
Output level : 0dBm  
Output port : OUTPUT1  
Input port : R  
Resolution band width : 1kHz  
Format : LOGMAG  
Sweep mode : SINGLE



## 6.7 Input Level Accuracy (Absolute value measurement)

- ④ Connect the power sensor to the OUT1 and perform the measurement.

**Note:** The calibration factor should be set to 10MHz.

Connect OUT1 and Rch with the BNC cable as shown in the figure below.

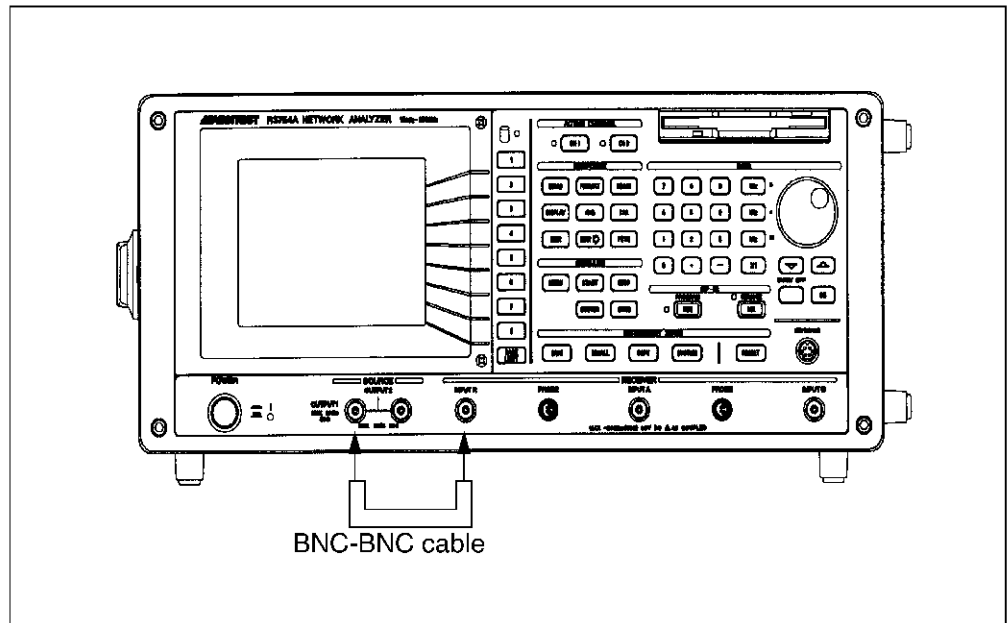

Figure 6-8 Input Level Accuracy

- ⑤ Sweep the frequency once using the SINGLE sweep mode and then read the measurement value by using the Marker.
- ⑥ <Check> : [(Measurement value by using the Marker) - (Measurement Value by using the Power meter)] :  $\pm 0.5\text{dB}$
- ⑦ For model with Option 11, connect the OUTPUT1 with the Ach in the same way and perform the measurement of Ach. And again connect the OUTPUT1 with the Bch and perform the measurement of Bch.  
For model with Option 10, connect the OUT1 with the Ach in the same way and perform the measurement of Ach.

## 6.8 Input Level Accuracy (Relative value measurement) ----- Only for model with Option 10/Option 11

Testing procedure

- ① Connect the two BNC cables to the R3754 Series as shown in the figure below.  
(Use the cables that have the same length and the identical characteristics.)

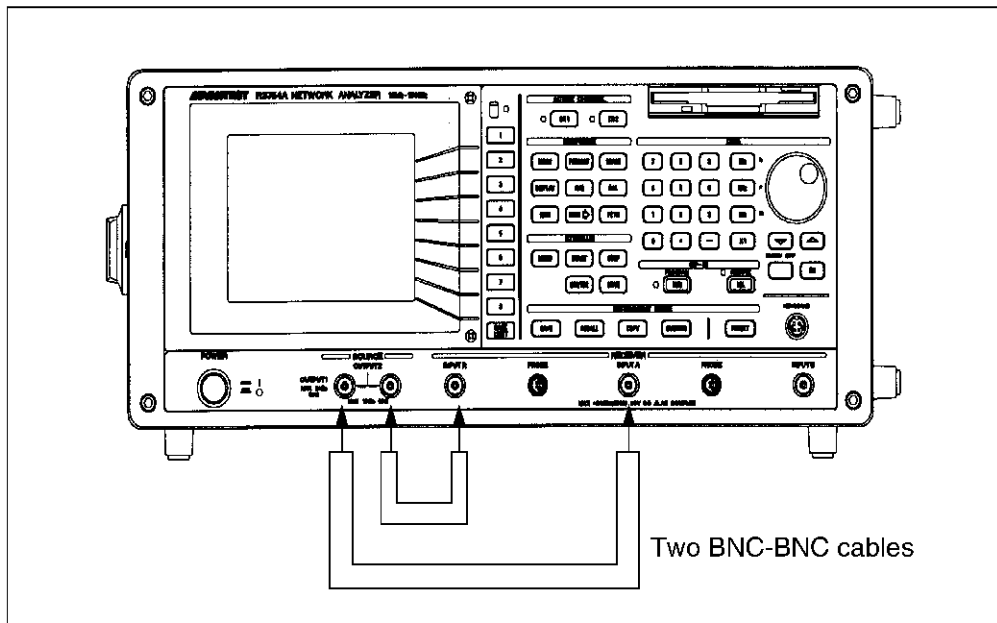

Figure 6-9 Input Level Accuracy (Relative Value)

- ② Set the R3754 Series as follows.  
Center frequency : 10MHz  
Span frequency : 0Hz  
Output level : 0dBm  
Output port : OUTPUT2  
Format : LOGMAG  
Input port : A/R  
Resolution band width : 1kHz
- ③ Read the measurement value by using the Marker.
- ④ <Check> : Measurement value by using the Marker :  $\pm 0.5\text{dB}$
- ⑤ For model with Option 11, change the Input port to the Input B/R and A/B and perform the measurement in the same way and check it.

## 6.9 Noise Floor

Testing procedure (Describes the procedure about the Input Port R.)

- ① Nothing should be connected to the R3754 Series.
- ② Set the R3754 Series as follows.
 

Output level	:	0dBm
Number of the measurement points	:	1201
Smoothing	:	ON
Smoothing aperture	:	5%
Input port	:	R
Format	:	LOGMAG
Input attenuator	:	0dB
Amplifier	:	16dB
- ③ Set the frequency range and the resolution band width as follows.
 

Start frequency	:	200kHz
Stop frequency	:	500kHz
Resolution band width	:	10kHz
- ④ Sweep the frequency once using the SINGLE sweep mode.  
Sum up the results of measurement data from the first point to the 1201th point and divide it by 1201.  
 Noise floor = 
$$\frac{\text{MEAS (1)} + \text{MEAS (2)} + \dots + \text{MEAS (1201)}}{1201}$$
 MEAS (n) : the measurement data at the nth point
- ⑤ <Check> : The noise floor (dB)  $\leq$  -102(dBm)
- ⑥ Change the frequency range as follows.
 

Start frequency	:	500kHz
Stop frequency	:	150MHz
- ⑦ Perform the same calculation described in the step ④.

6.9 Noise Floor

- ⑧ <Check> : The noise floor (dBm)  $\leq$  -112(dBm)
- ⑨ Change the resolution band width to 3kHz, 1kHz, 300Hz, 100Hz and check that these satisfy the specs in each frequency range.  
The value of the noise floor at each frequency range and the resolution band width is shown in the table below.

RBW \ FREQ	10kHz	3kHz	1kHz	300Hz
minf to 500kHz	minf = 200kHz -102dBm	minf = 60kHz -107dBm	minf = 20kHz -112dBm	minf = 6kHz -117dBm
500kHz to 150MHz	-112dBm	-117dBm	-122dBm	-127dBm

- ⑩ For model with Option 11, perform the same tasks for the Input Port A and the Input Port B.  
For model with Option 10, perform the same tasks for the Input Port A.

## 6.10 Crosstalk (between the input and output)

### Testing procedure

- ① Nothing should be connected to the R3754 Series.
- ② Set the R3754 Series as follows.  
(Other settings should be left at default values.)  
Output level : 0dBm  
Number of measurement points : 1201  
Smoothing : ON  
Smoothing aperture : 5%  
Input port : R  
Format : LOGMAG  
Input attenuator : 100kHz or less : 0dBm  
100kHz or more : AUTO  
Resolution band width : 100Hz
- ③ Set the frequency range as follows.  
Start frequency : 10kHz  
Stop frequency : 500kHz
- ④ Sweep the frequency once using the SINGLE sweep mode and obtain the data by using MAX search.
- ⑤ <Check> : [0(dBm) - the measurement value (dBm)] : 105dB or more
- ⑥ Perform the same tasks and check that they satisfy the specs in the frequency range described below.  
<Check> : When 500kHz to 150MHz,  
[0(dBm) - the measurement value (dBm)] : 120dB or more
- ⑦ For model with Option 11, perform the same tasks for the Input Port A and the Input Port B.  
For model with Option 10, perform the same tasks for the Input Port A.

## 6.11 Crosstalk (between the inputs) ----- Only for model with Option 10/Option 11

Testing procedure

- ① Connect the BNC cable to the R3754 Series as shown in the figure below.  
And connect the BNC terminator to the R3754 Series as shown in the figure below.

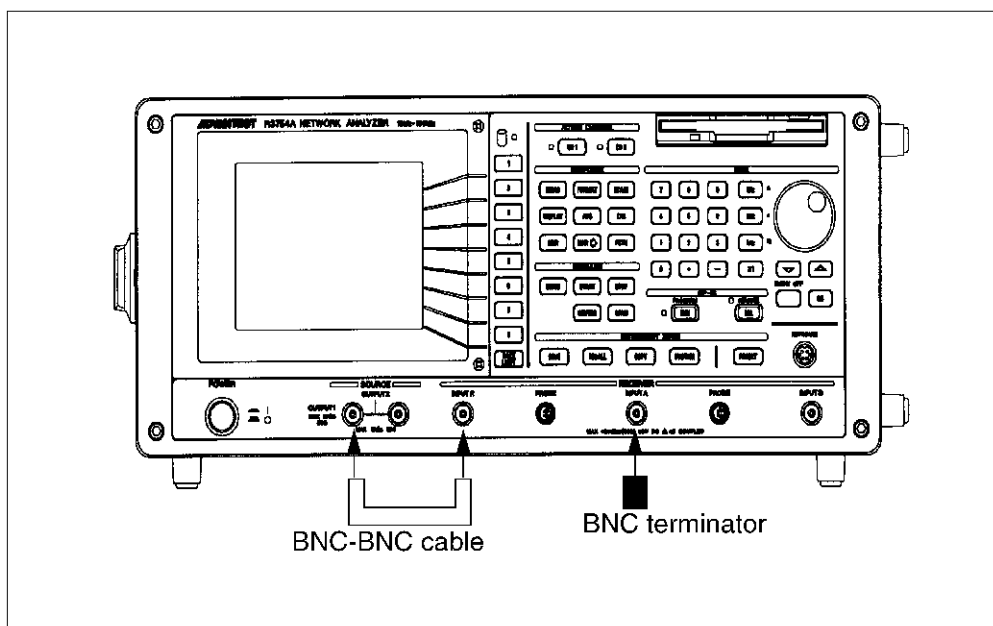

**Figure 6-10 Crosstalk (Between the Inputs)**

- ② Set the R3754 Series as follows. (Other settings should be left at default values.)
 

Output level	: 0dBm
Output port	: OUTPUT1
Input port	: A/R
Format	: LOGMAG
Number of measurement points	: 1201
Smoothing	: ON
Smoothing aperture	: 5%
- ③ Set the frequency range, the resolution band width and the input attenuator as follows.
 

Start frequency	: 10kHz
Stop frequency	: 500kHz
Resolution band width	: 30Hz
Input attenuator	: Rch AUTO
	Ach 0dB
- ④ Sweep the frequency once using the SINGLE sweep mode and obtain the data by using MAX search.

## 6.11 Crosstalk (between the inputs) ----- Only for model with Option 10/Option 11

- ⑤ <Check> : When 20kHz to 500kHz,  
(- the measurement value) : 105dB or more
- ⑥ Set the frequency range, the resolution band width and the input attenuator as follows.
- |                       |                        |
|-----------------------|------------------------|
| Start frequency       | : 500kHz               |
| Stop frequency        | : 150MHz               |
| Resolution band width | : 100Hz                |
| Input attenuator      | : Rch AUTO<br>Ach AUTO |
- ⑦ Sweep the frequency once using the SINGLE sweep mode and obtain the data by using MAX search.
- ⑧ <Check> : When 500kHz to 150MHz,  
(- the measurement value) : 120dB or more
- ⑨ For model with Option 11, execute the B/R measurement and the A/B measurement, referring to the above steps.
- When executing the B/R measurement, connect the BNC terminator to Bch and connect the BNC cable to Rch.
  - When executing the A/B measurement, connect the BNC terminator to Ach and connect the BNC cable to Bch.

When performing the measurements, set the input attenuator as described in the table below.

Frequency range	B/R measurement	A/B measurement
10kHz to 500kHz	R : AUTO B : 0dB	B : AUTO A : 0dB
500kHz to 150MHz	R : AUTO B : AUTO	B : AUTO A : AUTO





## 7 SPECIFICATIONS

**Note:** *If there are no other descriptions, these specifications are applied to the temperature range of  $23^{\circ}\text{C} \pm 5^{\circ}\text{C}$*

### (1) Measurement function

Measurement channel		2 channels (4 trace display)	
Measurement parameter		R	
		A/R, R, A	Option 10
		A/R, B/R, A/B, R, A, B	Option 11
Measurement format	Rectangular display	Log/linear magnitude, phase, group delay, the real part and the imaginary part of a complex parameter  Z , R, X (when performing the measurement of the Impedance conversion)  Y , G, B (when performing the measurement of the Admittance conversion) Phase extension display	
	Smith chart	The marker provides readouts of log/linear magnitude, phase, the real part + the imaginary part, $R + jX$ , $G + jB$	
	Pole coordinate display	The marker provides readouts of log/linear magnitude, phase, the real part + the imaginary part	

### (2) Source characteristics

Frequency characteristics	Range	10kHz to 150MHz	
	Resolution	0.1Hz	
	Accuracy	$\pm 5\text{ppm}$	
		$\pm 1\text{ppm}$ , 1MHz or more (0 to $50^{\circ}\text{C}$ , 30 min. or later after the power-on)	Option 20
Stability	$\pm 2 \times 10^{-8}$ per day (48 hour after the power-on)	Option 20	
Output power characteristics	Range	+21dBm to -43dBm	
	Resolution	0.1dB	
	Accuracy	$\pm 0.5\text{dB}$ (0dBm, 10MHz)	
		Linearity (10MHz)	+21dBm to -35dBm $\pm 0.5\text{dB}$ -35dBm to -43dBm $\pm 1.5\text{dB}$
	Flatness (0dBm output)	10kHz to 300kHz $\pm 2.0\text{dB}$	
		300kHz to 150kHz $\pm 1.5\text{dB}$	
Impedance (Output port 1)	Nominal $50\Omega$ Return loss 13dB or more (0dBm, typical)		

7 SPECIFICATIONS

Spectral purity	Harmonic distortion	≤ -15dBc	
	Non-harmonic spurious signal	≤ the bigger one of -20dBc or -60dBm	
	Phase noise	≤ -95dBc/Hz (10kHz offset)	
Sweep characteristics	Sweep parameter	Frequency, signal level	
	Range	Frequency sweep: Same as the frequency characteristics	
		Level sweep: +21dBm to -43dBm	
	Range setting	Start/stop or center/span	
	Sweep type	Linear sweep and logarithmic sweep, available for a user-specified segment, level sweep	
	Sweep time	0.05ms/point (RBW 15kHz)	
	Measuring point	3, 6, 11, 21, 51, 101, 201, 301, 401, 601, 801, 1201 points	
	Sweep trigger	Repeat, single, external	
	Sweep mode	Dual sweep (Sweeps frequency for each channel in the same frequency range.)	
Alternate sweep (Sweeps frequency for each channel in different sweep ways and different frequency ranges.)			
Output format	Output	Single	
		Single, dual	Options 10 and 11
	Connector	Type BNC female, 50Ω	
	Power splitter (Output port 2)		Options 10 and 11
	Insertion loss	6dB (typical)	
	Amplitude tracking	< 100MHz 0.1dB (typical)	
		≥ 100MHz 0.2dB (typical)	
Equivalent output SWR	< 100MHz 1.2 (typical)		
	≥ 100MHz 1.4 (typical)		

## (3) Receiver characteristics

Input characteristics	Input channel	1-channel	
		2-channel	Option 10
		3-channel	Option 11
	Frequency range	10kHz to 150MHz	
	Impedance	Nominal: 50Ω	
	Return loss	ATT0dB 20dB or more	
		ATT25dB 25dB or more	
	Maximum input level	ATT25dB AMP0dB +5dBm	
		ATT0dB AMP0dB -20dBm	
		ATT0dB AMP16dB -36dBm	
	Input damage level	+24dBm, ±3VDC	
	Noise level ATT0dB AMP16dB	RBW10kHz 200kHz to 500kHz -102dBm 500kHz to 150MHz -112dBm	
		RBW3kHz 60kHz to 500kHz -107dBm 500kHz to 150MHz -117dBm	
		RBW1kHz 20kHz to 500kHz -112dBm 500kHz to 150MHz -122dBm	
RBW300Hz 10kHz to 500kHz -117dBm 500kHz to 150MHz -127dBm			
Resolution bandwidth (RBW)	15kHz to 3Hz (1, 1.5, 2, 3, 4, 5, 7 steps)		
Input crosstalk	10kHz to 500kHz 105dB		
	500kHz to 150MHz 120dB		
Source crosstalk	10kHz to 500kHz 105dB		
	500kHz to 150MHz 120dB		
Input connector	Type BNC female, 50Ω		
Automatic offset calibration	Normalize function	Reduces the frequency characteristics of a measurement system.	
	Electrical length correction	Equivalent electric length or group delay time can be added to the measured phase and group delay time.	
	Range	$-3 \times 10^9$ m to $+3 \times 10^9$ m or +10sec to -10sec	

7 SPECIFICATIONS

Magnitude characteristics (Absolute characteristics)	Measurement range (RBW 1kHz)	ATT AUTO AMP 0dB +5dBm to -115dBm		
		ATT 25dB AMP 0dB +5dBm to -90dBm		
		ATT 0dB AMP 0dB -20dBm to -115dBm		
		ATT 0dB AMP 16dB -36dBm to -122dBm		
	Display resolution	0.001dB/div		
	Accuracy	±0.5dB (10MHz, maximum input level)		
	Frequency response (0dBm input)	10kHz to 1MHz 4dBp-p		
		1MHz to 150MHz 3.5dBp-p		
	Dynamic accuracy (ATT 25dB, AMP0dB) (100kHz or higher)	0 to -10dBm ±0.4dB		
		-10 to -60dBm ±0.1dB		
-60 to -70dBm ±0.2dB				
-70 to -80dBm ±0.6dB				
Magnitude characteristics (Relative characteristics)	Measurement range (ATT25dB AMP0dB) (100kHz or higher)	ATT AUTO AMP 0dB ±120dB	Options 10 and 11	
		ATT 20dB AMP 0dB ±95dB		
		ATT 0dB AMP 0dB ±95dB		
		ATT 0dB AMP 16dB ±86dB		
	Display resolution	0.001dB/div		
	Accuracy	±0.5dB (10MHz, maximum input level)		
	Frequency response (0dBm input)	10kHz to 1MHz 3dBp-p		
		1MHz to 150MHz 2dBp-p		
	Dynamic accuracy (ATT 25dB, AMP0dB) (100kHz or higher)	0 to -10dBm ±0.1dB		
		-10 to -60dBm ±0.05dB		
-60 to -70dBm ±0.1dB				
-70 to -80dBm ±0.3dB				
-80 to -90dBm ±0.9dB				

Phase characteristics * (Absolute characteristics)	Measurement range	$\pm 180^\circ$ (The phase extending function enables the display to trace data over $\pm 180^\circ$ continuously.)		
	Display resolution	0.01dB/div		
	Dynamic accuracy (ATT 25dB, AMP0dB) (100kHz or higher)	0 to -10dBm	$\pm 3.0^\circ$	
		-10 to -50dBm	$\pm 1.5^\circ$	
		-50 to -60dBm	$\pm 2.0^\circ$	
		-60 to -70dBm	$\pm 2.4^\circ$	
-70 to -80dBm		$\pm 3.6^\circ$		
Phase characteristics (Relative characteristics)	Measurement range	$\pm 180^\circ$ (The phase extending function enables the display to trace data over $\pm 180^\circ$ continuously.)	Options 10 and 11	
	Resolution	0.01°		
	Frequency response (0dBm input)	10kHz to 1MHz		20°p-p
		1MHz to 150MHz		15°p-p
	Dynamic accuracy (ATT 25dB, AMP0dB) (100kHz or higher)	0 to -10dBm		$\pm 1.0^\circ$
		-10 to -50dBm		$\pm 0.3^\circ$
		-50 to -60dBm		$\pm 0.5^\circ$
		-60 to -70dBm		$\pm 1.0^\circ$
-70 to -80dBm		$\pm 3.0^\circ$		
-80 to -90dBm		$\pm 8.0^\circ$		
Delay characteristics (Relative characteristics)	Range	The following formula is used to determine the range. $r = \frac{\Delta \phi}{360 \times \Delta f}$ $\Delta \phi$ : Phase $\Delta f$ : Aperture frequency (Hz)		
	Measurement range	1ps to 250s		
	Group delay resolution	1ps		
	Aperture frequency	Corresponds to the $\Delta f$ . Can be set from {100/(measurement points - 1) × 2 %} of the frequency span to {100/(measurement points - 1) × 100 %} of the frequency span, with the resolution of {100/(measurement points - 1) × 2 %}.		
	Accuracy	$\frac{\text{phase accuracy}}{360 \times \text{aperture frequency (Hz)}}$		

\*: In the absolute mode, the phase measurement can be executed within measurement ranges as follows.

- ① 10kHz ≤ measurement frequency ≤ 34MHz
- ② 31MHz < measurement frequency ≤ 150MHz.

7 SPECIFICATIONS

Error calibration function	Normalize	Corrects the frequency response (of magnitude, phase) in the transmission measurement.	
	One port calibration	Corrects the errors caused by the bridge directivity, the frequency response and the source match in the reflection measurement. Short, open and load standards are required for the error correction.	
	Data averaging	Averages the data (vector values) at each sweep. The averaging number can be set between 2 to 999.	
	Transmission full calibration	The transmission normalize enables the high accuracy measurement on transmission measurement. The short and load standards are required for the error correction.	

(4) Connection with external instruments

Signal output for an external display	15 pin D-SUB connector (VGA)	
GPIB data output and Remote control	IEEE488 applicable	
Printer port	25-pin D-SUB	
Serial port	RS-232 compatible (9-pin D-SUB)	
Keyboard	IBM PC-AT compatible	
External reference frequency input	Applicable input signal is Frequency: 1, 2, 5, 10MHz $\pm$ 10ppm, 0dBm (50 $\Omega$ ) or more	
Parallel I/O output	TTL level, 8-bit output (two ports) 4-bit input and output (two ports)	Option 01
Probe power	$\pm$ 12V	Options 10 and 11
External trigger signal input	BNC connector (female)	

## (5) Display section

Indicator	R3754A 5-inch monochrome liquid-crystal display
	R3754B 6.5-inch color TFT liquid-crystal display
Resolution	640 × 480 dots
Display mode	Rectangular log/linear coordinates, polar coordinate, Smith chart (Impedance/admittance display)
Display format	Single channel display, dual channel display (which shows plural traces together or respectively.)
Measurement condition display	Start/stop, center/span, scale/DIV
	Reference level, marker value, soft key function
	Warning message
Position of Reference line	The top (100%) to the bottom (0%) of the vertical axis
Auto scale	Optimizes the reference value and the scale to show the traced data best in the screen.
Brightness	R3754A: Not applicable
	R3754B: The back-light can be turned on/off.
Contrast	R3754A: Adjustable

---

 7 SPECIFICATIONS

## (6) Marker function

Marker display	The readout of the marker can be converted to the display value conforming to the measurement format.
Multi marker	Ten markers can be set for each channel, respectively.
Delta marker	Any one of the ten markers can be specified as a reference marker and can measure the delta value between a movable marker and the reference marker.
Marker couple	The marker of each channel can be set as a coupling marker or an independent marker.
Analysis of arbitrary specified zone	The marker search function can be performed in a segment specified by the delta marker function.
MKR search	MAX search, MIN search, NEXT search
Marker tracking	Performs the search for each sweep.
Target search	Calculates a XdB-down band width, a center frequency, Q value and so on. It is also possible to search for the frequency of the phase $0^\circ$ or the frequency band of $\pm X^\circ$ .
MKR $\rightarrow$	MKR $\rightarrow$ the reference value, MKR $\rightarrow$ START, MKR $\rightarrow$ STOP, MKR $\rightarrow$ CENTER
Limit line function	Limit line can be set up to 31 segments. Each segment can be judged by the pass/fail criteria.
Direct analysis function	Resonator analysis etc.



## (7) Instruments state function

Save register	The set condition and the CAL data can be saved in the internal memory which is keeping backup.
Data save/recall	Each kind of data can be stored by using a floppy disk which is standard.

## (8) Programming function

BASIC controller function	Controls this R3754 Series itself and instruments equipped with GPIB interface functions. This is a built-in standard controller function.
Built-in function	Enables the high speed analysis of the measurement data.
FDD function	MS-DOS format compatible. Recording capacity: DD 720kB HD 1.2MB, 1.44MB

## (9) General specification

Operating conditions	When disk drive is in operation	Temperature: +5°C to +40°C Humidity (without condensation): 80% or less
	When disk drive is not in operation	Operating temperature range: 0°C to +40°C (R3754A) 0°C to +50°C (R3754B) Humidity (without condensation): 80% or less
Non-operating conditions		-20°C to +60°C
Power supply		AC100V to 120V, AC220V to 240V at 50/60Hz Automatically switched to the AC100 family or the AC200V family.
Power consumption		200VA or less
Cabinet dimensions		Approx. 424mm(W) × 177mm(H) × 300mm(D)
Mass		12kg or less



## 8 ERROR MESSAGES

This chapter explains the error messages displayed on the screen. Error messages are classified into the following groups.

- 8.1 Hardware trouble
- 8.2 Overloading an input part
- 8.3 Notice of hardware information
- 8.4 Operating error
- 8.5 Warning of internal set, change, etc.
- 8.6 Completion operating condition messages

These error message are displayed as following.

- Error messages are left displayed on the fixed position. In other words, the error message is displayed over the former message, and the latest message remains on the screen.
- The error message does not disappear until some panel key is pressed. However, the messages in section 8.1 and 8.2 disappear if the R3754 Series is returned to the correct state.
- The message of section of 8.4 to 8.6 are not displayed in GPIB operation (also including an internal BASIC operation).

**Note:** → marks explain supplemental remarks of error message list and problem-solving methods.

### 8.1 Hardware Trouble

LOCAL #1 Unlock.

LOCAL #2 Unlock.

LOCAL has been unlocked.

VCXO Unlock.

VCXO has been unlocked.

→ If these error message appear, call the nearest dealer or sales-and-support office.

## 8.2 Overloading an Input Part

### 8.2 Overloading an Input Part

#### Ach Overload.

#### Bch Overload.

#### Rch Overload.

A signal exceeding a maximum permissible level has been input to the channel.

- Check the input signal level.

### 8.3 Notice of Hardware Information

#### External Standard In.

An external reference signal has been input.

#### External Trigger ignored.

An input external trigger was ignored. (That does not mean a prohibiting state.)

- An external trigger (PIO-18pin) has been input in a state of not waiting for the external trigger.  
The state of waiting for the external trigger is the state of waiting for sweep in the external trigger mode (that is, in a state that TRIGGER[CONT] or TRIGGER[SINGLE] on the panel).  
If next trigger pulse is input during a sweep in using an external trigger source, the above error occurs.  
Check the trigger setting and the specification of an external trigger signal.

#### Overtemperature detected.

The internal temperature is beyond the specified range.

- Turn the power off, and measure the ambient temperature. Turn the power on again after the temperature has fallen enough.  
Contact the nearest ADVANTEST service office or agency if you find the ambient temperature normal.

## 8.4 Operating Error

### Already Memorized.

Memorizing calibration data which {*DONE*} operation was already executed was attempted.

- Clear the already-memorized calibration data with {*CLEAR CAL DATA*}.

### Calibration aborted.

Memorizing calibration data was aborted.

- While calibration data is being memorized, if the setting is changed, the calibration is aborted.  
Do not change the setting until the calibration is finished.

### Calibration data not found.

CORRECT ON was executed without memorized calibration data.

- Memorize the calibration data.

### Can't ... When 0 SPAN.

CDMA IF GATE was tried to turn on in a sweep mode with the frequency set to 0 (zero) Hz.

- The CDMA IF GATE function cannot be used when set to the zero span.  
Set the frequency span to any frequency other than 0 (zero) Hz.

### Can't ... When CORRECT ON.

To memorize calibration data or to execute {*CLEAR CAL DATA*} was attempted in the state of CORRECT ON.

- Choose CORRECT OFF.

### Can't ... When not LIN-FREQ.

CDMA IF GATE was tried to turn on when set to a sweep mode other than the linear frequency mode.

- The CDMA IF GATE function can be enabled only when the linear frequency mode is turned on.  
Set the sweep mode to the linear frequency.

### Can't ... When PROG-SWEEP.

To set the number of points or to clear segments was attempted in the state of program sweep.

- Specify a sweep type other than PROGRAM SWEEP and USER SWEEP.

## 8.4 Operating Error

### Can't ... When USER-SWEEP.

To set the number of points or to clear segments was attempted in the state of user frequency sweep.

- Specify a sweep type other than PROGRAM SWEEP and USER SWEEP.

### Can't find plotter !!!

A plotter was not found in a plot output.

- The plotter is not connected or GPIB address of the plotter is not correct.

### Data and Coef not matched.

To execute CORRECT ON was attempted under a condition differing from a measurement condition where correction data was obtained.

- Specify the same measurement condition where the correction data was obtained.

### Data and Memory not matched.

A trace operation (DATA/MEM, etc.) or a memory trace display (DISPLAY MEMORY, DISPLAY DATA&MEM) was specified under a condition differing from a measurement condition where a memory trace was obtained.

- Specify the measurement condition where the memory trace was obtained.

### Disk not found

Data in a floppy disk was not able to be read with the {LOAD MENU}, {STORE FILE} or {LOAD FILE} key in R3754 Series.

- The floppy disk has some scratches or has not be formatted or inserted. Check the floppy disk.

### Duplicate name

The same name that has already been edited or a reserved name is input with the [SAVE] → {STORE FILE} → {EDIT NAME} key in this order in R3754 Series.

- Input a different name.

### File load error.

An error occurred in a {LOAD FILE} execution.

- Something is wrong with the floppy disk, or a file other than files stored in the R3754 Series was specified. Check the floppy disk.

File store error

An error occurred in a *{STORE FILE}* execution.

- The floppy disk has no available space, or the floppy disk is not formatted or is in a write-protect state. Check the floppy disk.

Formatting failure

Something was wrong in the formatting operation.

- The floppy disk has some scratches or is in a write-protect state. Check the floppy disk.

Illegal PROG-SWEEP points.

With the number of total points of all segments being less than 3 or more than 1201, the program sweep was specified.

- Specify the number of the segment point again.

Illegal USER-SWEEP points.

With the number of total points of all segments being less than 3 or more than 1201, the user frequency sweep was specified.

- Specify the number of the segment point again.

Memory not found.

A trace operation (DATA/MEM, etc.) or a memory trace display (DISPLAY MEMORY, DISPLAY DATA&MEM) was specified, with a memory trace not stored.

- Obtain the memory trace.

None Controller

A plot output was specified not in system controller mode.

- Set to the system controller mode.

Not enough space.

Enough disk space for saving registers is not available on the C drive.

- Delete unnecessary registers, or delete unnecessary files on the C drive.

## 8.4 Operating Error

### Now plotting !!!

Another plot output was specified in the course of executing a plot output.

- Until the current plot output is completed, the following plot can not be executed. Wait until the current plot output is completed.

### Please set 1-trace FORMAT

With the measurement format two traces (LOGMAG&PHASE, LOGMAG&DELAY, LOGMAG&PHASE), the memory trace display (DISPLAY MEMORY, DISPLAY DATA&MEM) was specified.

- The memory trace display is invalid with the measurement format two traces. Set the measurement format to one trace (other than LOGMAG&PHASE, LOGMAG&DELAY or LOGMAG&PHASE).

### Register recall error.

An error occurred in recalling a register.

- A register that had not been saved was specified or the register was broken by some factor. Clear the register with {CLEAR REG} and save again.

### Register save error.

An error occurred in saving a register.

- Available space is not in C: drive. Delete unnecessary files.

### Segment #x error.

The PROGRAM SWEEP or USER SWEEP was specified in a state that STOP FREQ of the Xth segment is higher than START FREQ of the following segment.

- Specify the frequency of the Xth segment again.

### Segment not entered.

The PROGRAM SWEEP or USER SWEEP was specified without setting any segment.

- Specify the segment.

### Some STD not memorized.

To execute the {DONE} operation was attempted without obtaining all related calibration data.

- Obtain all calibration data.



## 8.5 Warning of Internal Set, Change, etc.

### CDMA.GATE turned off.

The status shown below results either because the settings below are set with CDMA IF GATE on or because COUPLED CH is set to on.

- Sweep mode is set to one other than the linear frequency.
- Frequency span is set to 0 (zero) Hz.

→ The CDMA IF GATE function is enabled only when the network analyzer is set to the linear frequency mode, and the frequency span is set to any frequency other than 0 (zero) Hz. Set again the sweep mode and frequency span.

### CH1 INPUT-MEAS changed.

### CH2 INPUT-MEAS changed.

The INPUT MEAS setting at the channel 1 or channel 2 was internally changed.

→ When a S-parameter test set is connected, a INPUT MEAS setting that a Forward direction and Reverse direction of the S-parameter test set, respectively, are simultaneously assigned to either CH1 or CH2 is invalid for a dual sweep (DUAL CH ON, COUPLE CH on). These messages are displayed when the above setting is executed.

When above message is displayed, the direction assigned to the channel described in the message is internally made the same direction as the other channel has been assigned to in INPUT MEAS setting. (Settings of reflection or transmission measurement are not changed.)

### CORRECT turned off.

The CORRECT setting was internally altered to OFF.

→ The measuring condition in which the correction data was obtained must be the same as the current measuring condition in the correcting measurement (CORRECT ON). Therefore, when the number of points or a sweep type is altered in a state of CORRECT ON, this message is displayed and CORRECT OFF is set.

### CORR or MEM can't be saved.

The correction data or memory trace data was not able to be saved in executing SAVE REGISTER.

→ The correction data or memory trace data is saved in B: drive with SAVE REGISTER. If available space is not in B: drive, this message is displayed. (However, the setting condition of the R3754 Series is saved.)  
Clear unnecessary register.

### Data file can't be stored.

The trace data (RAW, COEF, MEM, DATA) was not able to be saved with STORE FILE.

→ Available space is not in A: drive (floppy disk). (However, the setting condition of the R3754 Series is saved.)  
Clear unnecessary file or use another floppy disk.

---

## 8.5 Warning of Internal Set, Change, etc.

### Display Mode changed.

The display mode setting was internally altered to DISPLAY DATA.

- A measuring condition in which the memory trace was obtained must be the same as the current measuring condition and the measuring format must be set to one trace in the memory trace display mode (DISPLAY MEMORY, DISPLAY DATA&MEM). Therefore, when the number of points or the sweep type is altered in a state that the memory trace is displayed, or when the measuring format is set to two traces (LOGMAG&PHASE, LOGMAG&DELAY, LINMAG&PHASE), this message is displayed and the display mode is altered to DISPLAY DATA.

### INPUT AMP changed.

The input attenuator is set to either AUTO or 25dB when the input preamplifier is set to 16dB.

- The input attenuator can be set to either AUTO or 25dB only when the input preamplifier is set to 16dB.  
The input preamplifier is forcibly set to 0dB when set as shown above.

### INPUT ATT changed.

The input preamplifier is set to 16dB when the input attenuator is set to either AUTO or 25dB.

- The input preamplifier can be set to 16dB only when the input attenuator is set to 0dB.  
The input attenuator is forcibly set to 0dB when set as shown above.

### Overwrite

Data is being written over an already-existing file with STORE FILE.

- Specify a different file name to prevent to write over.

### Sweep time increased.

The setting of the sweep time was internally altered and the sweep time was increased.

- The minimum setting of the sweep time depends on the RBW setting or others. When the sweep time is set to AUTO, this message is not displayed. Therefore, when the sweep time is not set to AUTO, if this message is displayed by altering the setting of the RBW or and the sweep time is increased. Afterward, even if the RBW setting is set to the previous setting, the sweep time setting do not be set back to the previous setting.

### Trace-Math turned off.

The setting of the trace operation (DATA/MEM and others) was internally altered to OFF.

- The measuring condition in which the memory trace was obtained must be the same as the current measuring condition in the trace operation. Therefore, when the number of points or the sweep type was altered with the trace operation executed, this message is displayed and the trace operation is set to OFF.

## 8.6 Completion Operating Condition Messages

### Abort PLOT !!!

The plot output was interrupted by pushing the *{ABORT}* key, **[PRESET]** key or **[STOP]** key.

### Clear Completed.

The memorized calibration data was cleared with CLEAR CAL DATA.

### Formatting now...

The floppy disk is now under formatting.

### Formatting complete

Formatting the floppy disk was correctly complete.

### Store Completed

A data trace was copied into a memory trace with *{DATA → MEMORY}*.

### Wait for sweep.

A sweep is being executed to obtain the calibration data.



## APPENDIX

### A.1 Initial Setting

(1) Initial setting

(1 of 3)

Function	Initialize method	
	Power on or preset	*RST
<b>Stimulus</b> Sweep type Continuous sweep Trigger source Trigger delay Sweep time Measurement point Start frequency Stop frequency Center frequency Frequency span Frequency display Fixed frequency of level sweep Output level Start level Stoplevel Two-channel interlocking Program sweep segment Output port	Linear frequency sweep ON Internal (FREE RUN) OFF (0sec) Auto 201 10kHz 150MHz 75.005MHz 149.99MHz Start/Stop 10MHz 5dBm -43dBm 5dBm ON All clear Port 1 *1	Linear frequency sweep OFF Internal (FREE RUN) OFF (0sec) Auto 1201 10kHz 150MHz 75.005MHz 149.99MHz Start/Stop 10MHz 5dBm -43dBm 21dBm ON All clear Port 1 *1
<b>Response</b> Dual channel Active channel Resolution bandwidth Selection item of input port Average Trace operation Conversion Characteristic impedance $Z_0$ Measurement format Group delay aperture Smoothing Display Split/Overlap Label	OFF 1 10kHz R *2 OFF (Number of times 16) NONE NONE 50Ω LOGMAG&PHASE 10% OFF (Aperture 10%) Data Overlap NONE	OFF 1 10kHz R *2 OFF (Number of times 16) NONE NONE 50Ω LOGMAG&PHASE 0.01% OFF (Aperture 0.01%) Data Overlap NONE

\*1 Port 2 is used if Option 10 or 11 is installed.

\*2 A/R is used if Option 10 or 11 is installed.

A.1 Initial Setting

(2 of 3)

Function	Initialize method	
	Power on or preset	*RST
<b>Calibration</b> Correct measurement Calibration data Electrical length correction Phase offset Measurement end extension correction R input A input B input Velocity factor	OFF Clear OFF (0sec) OFF (0°) OFF 0 sec 0 sec 0 sec 1	OFF Clear OFF (0sec) OFF (0°) OFF 0 sec 0 sec 0 sec 1
<b>The value per division of Y-axis</b> Logarithmic magnitude Phase Group delay Smith chart Polar Linear magnitude SWR Real part Imaginary part Continuous phase	10dB 45° 0.1 μsec — — 0.1 1 1 1 360°	10dB 45° 0.1 μsec — — 0.1 1 1 1 360°
<b>Reference position</b> Logarithmic magnitude Phase Group delay Smith chart Polar Linear magnitude SWR Real part Imaginary part Continuous phase	100% 50% 50% — — 0% 0% 100% 100% 50%	100% 50% 50% — — 0% 0% 100% 100% 50%

(3 of 3)

Function	Initialize method	
	Power on or preset	*RST
Reference value		
Logarithmic magnitude	0dB	0dB
Phase	0°	0°
Group delay	0sec	0sec
Smith chart	1	1
Polar	1	1
Linear magnitude	0	0
SWR	1	1
Real part	10	10
Imaginary part	10	10
Continuous phase	0°	0°
Input attenuator		
R input	AUTO	AUTO
A input	AUTO	AUTO
B input	ATUO	ATUO
Input preamplifier		
R input	0dB	0dB
A input	0dB	0dB
B input	0dB	0dB
CDMA IF filter analysis		
CDMA IF filter gate function	OFF	OFF
CDMA IF filter gate start time	0sec	0sec
CDMA IF filter gate stop time	6 $\mu$ sec	6 $\mu$ sec
CDMA IF filter gate shape	CDMA IF	CDMA IF
CDMA IF filter magnitude analysis	OFF	OFF
Search attenuation	6dB	6dB
Guaranteed attenuation measurement		
First frequency	900kHz	900kHz
Second frequency	1.2MHz	1.2MHz
Phase linearity analysis	OFF	OFF

## (2) Setting backup memory (factory default settings)

GPIB address	11
System controller/Addressable	Addressable
Printer GPIB address	18
Plotter GPIB address	5
Serial port setting	Baud rate: 9600 baud, Character length: 8 bits Parity: None, Stop bit: 1 bit
Save register	All clear
Calibration standard	
OPEN   Rs	1G $\Omega$
OPEN   Ls	0H
OPEN   Cp	0F
SHORT  Rs	0 $\Omega$
SHORT  Ls	0H
SHORT  Cp	0F
LOAD   Rs	50 $\Omega$
LOAD   Ls	0H
LOAD   Cp	0F

A.2 Soft Key Menu List

A.2 Soft Key Menu List

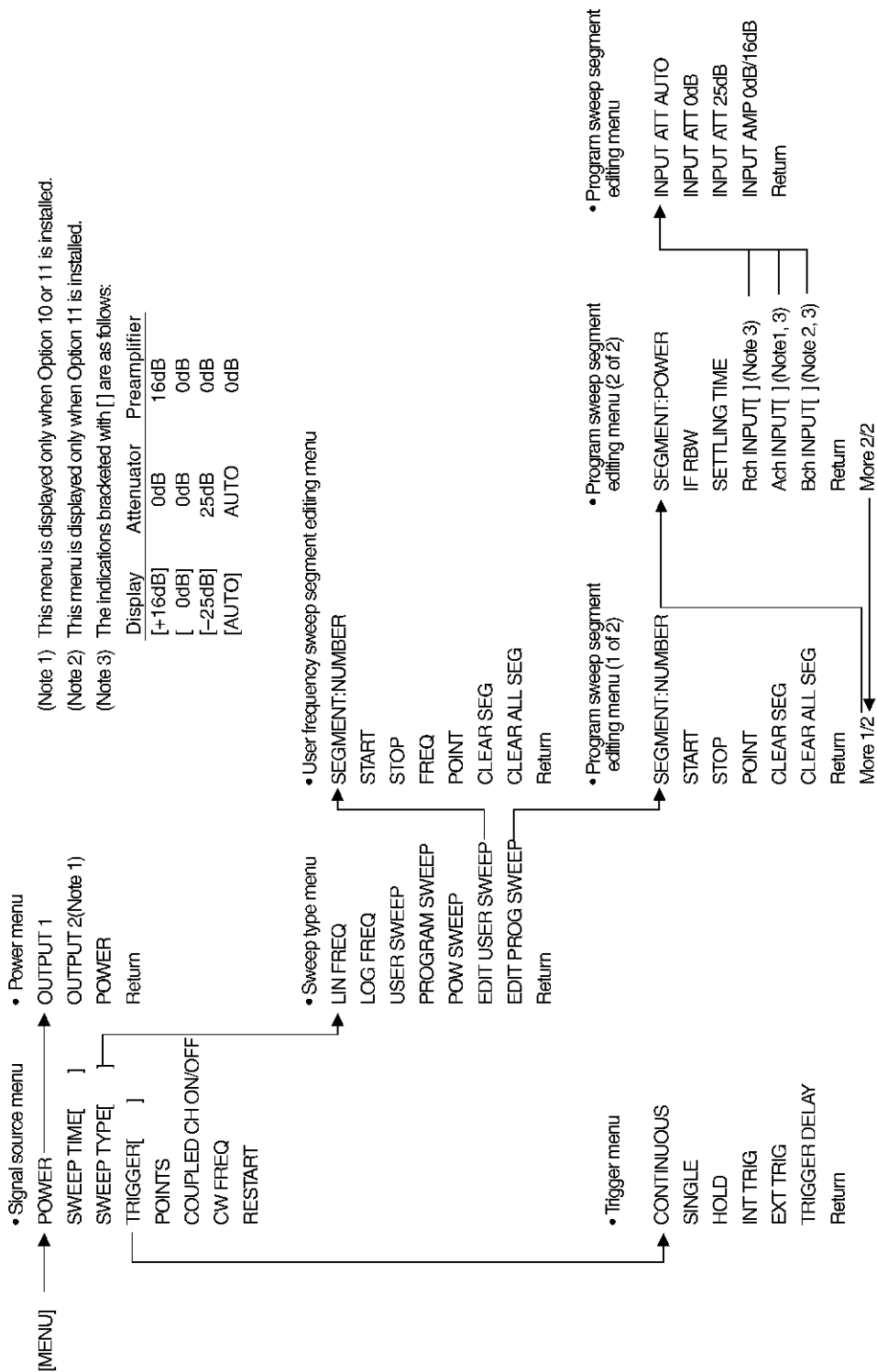



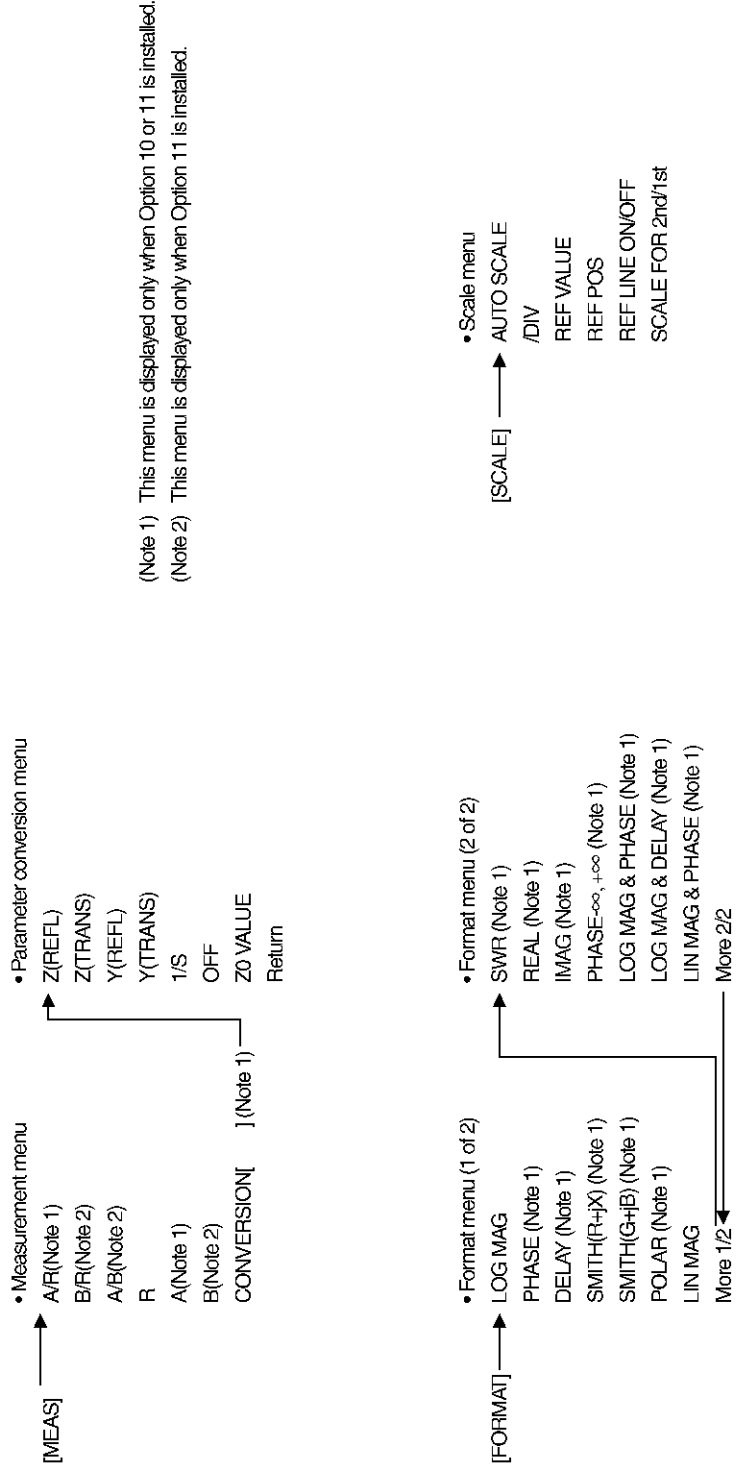

(Note 1) This menu is displayed only when Option 10 or 11 is installed.  
 (Note 2) This menu is displayed only when Option 11 is installed.

A.2 Soft Key Menu List

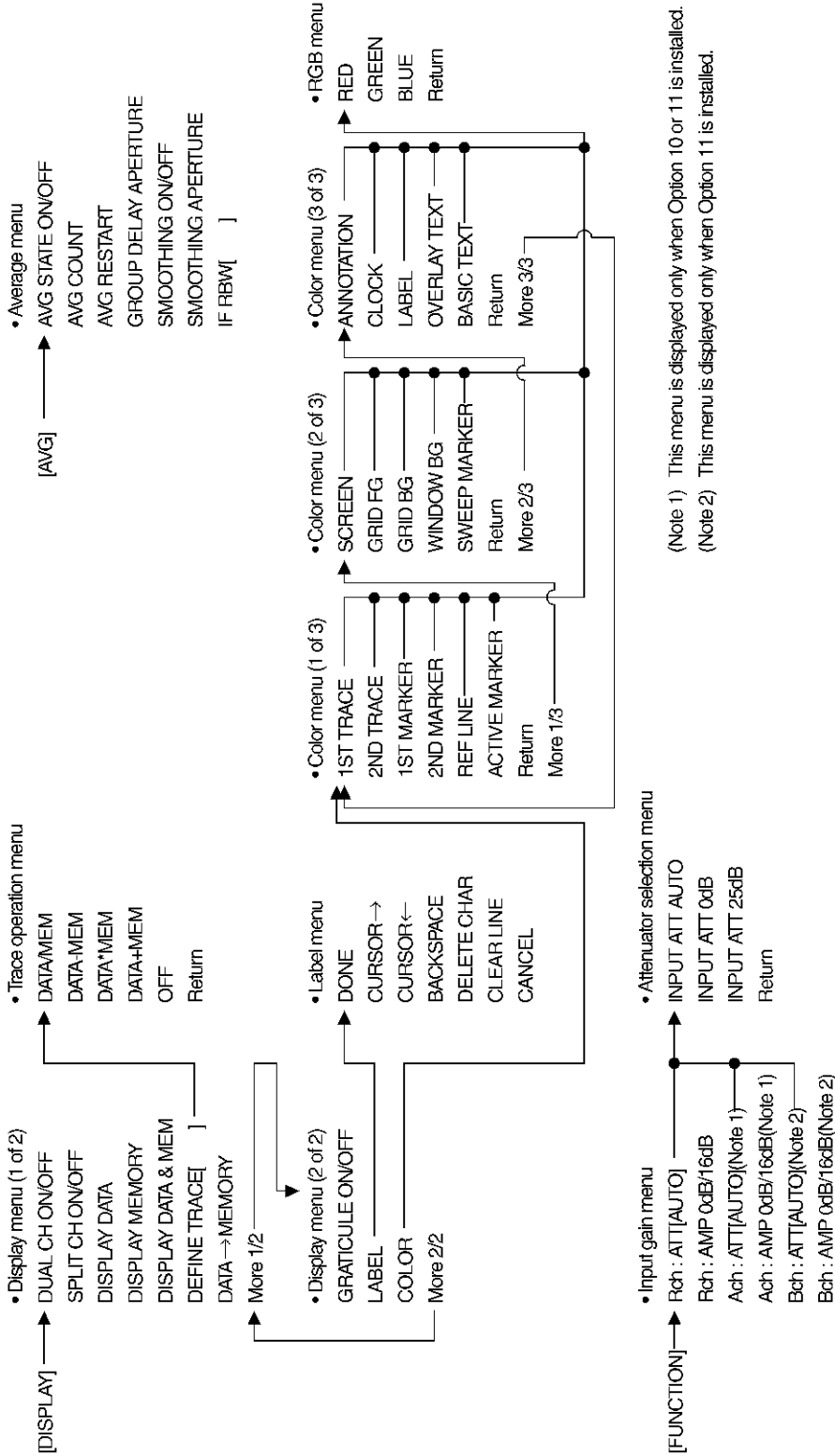

(Note 1) This menu is displayed only when Option 10 or 11 is installed.

(Note 2) This menu is displayed only when Option 11 is installed.

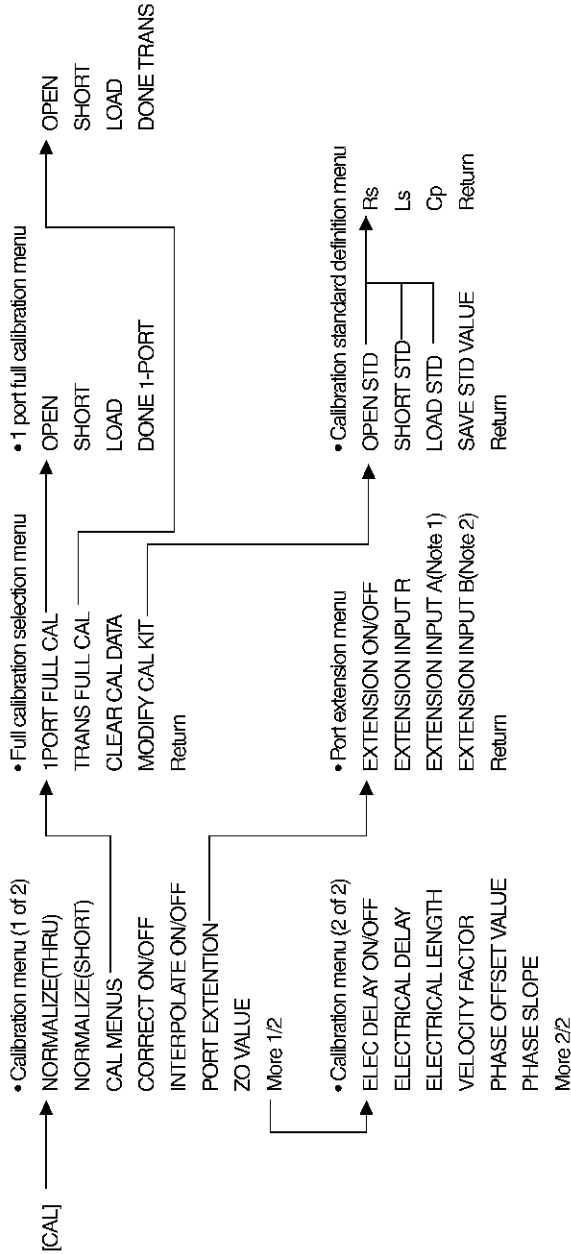

(Note 1) This menu is displayed only when Option 10 or 11 is installed.

(Note 2) This menu is displayed only when Option 11 is installed.

A.2 Soft Key Menu List

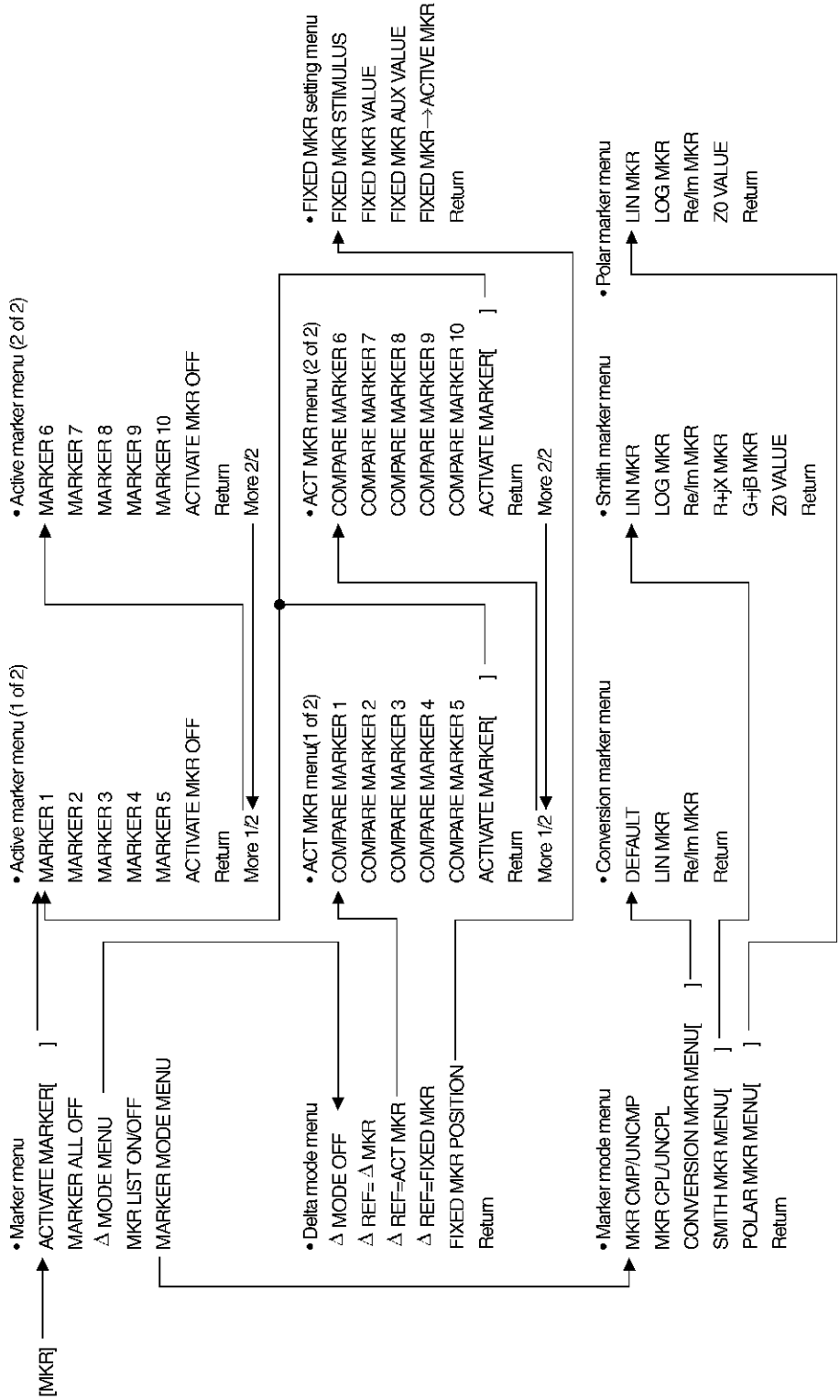

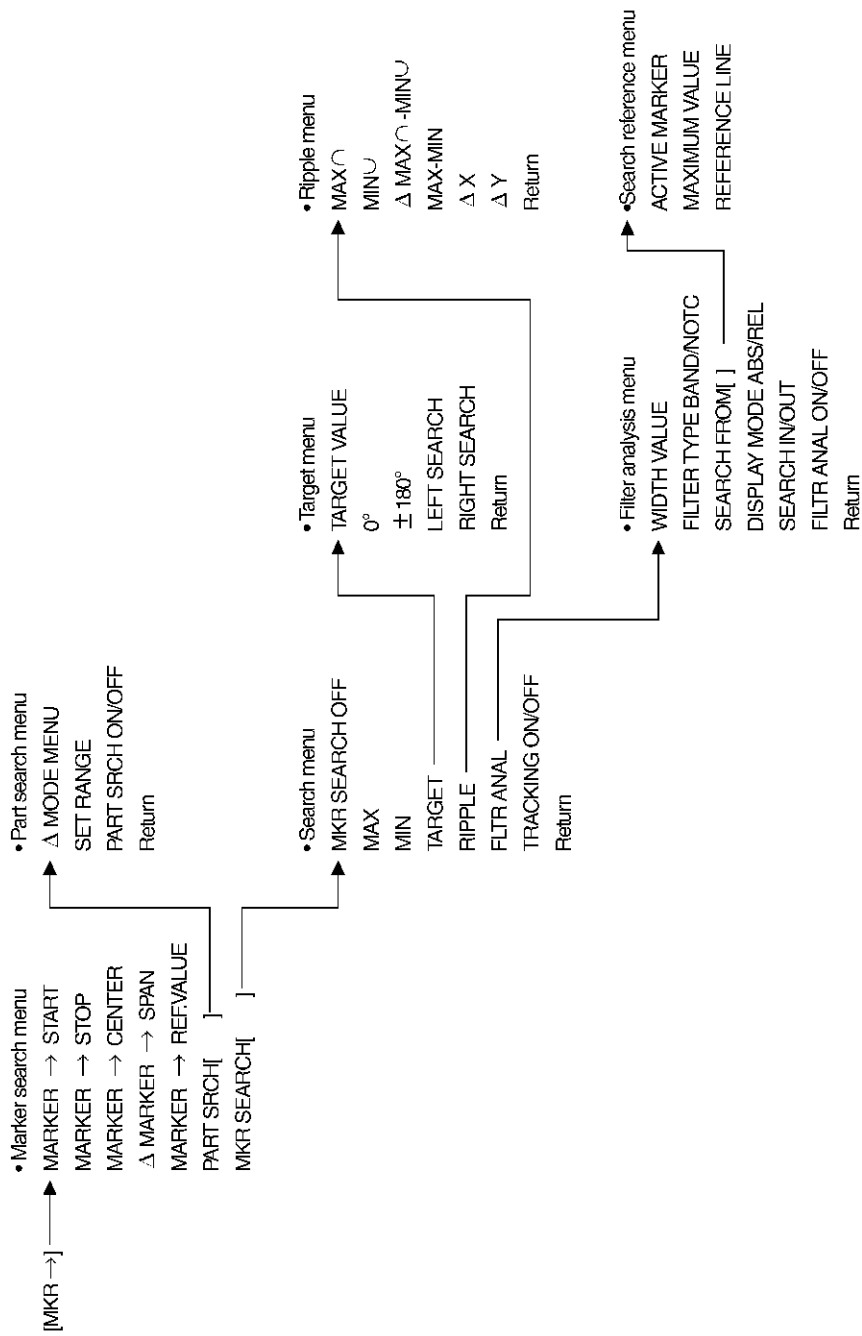

A.2 Soft Key Menu List

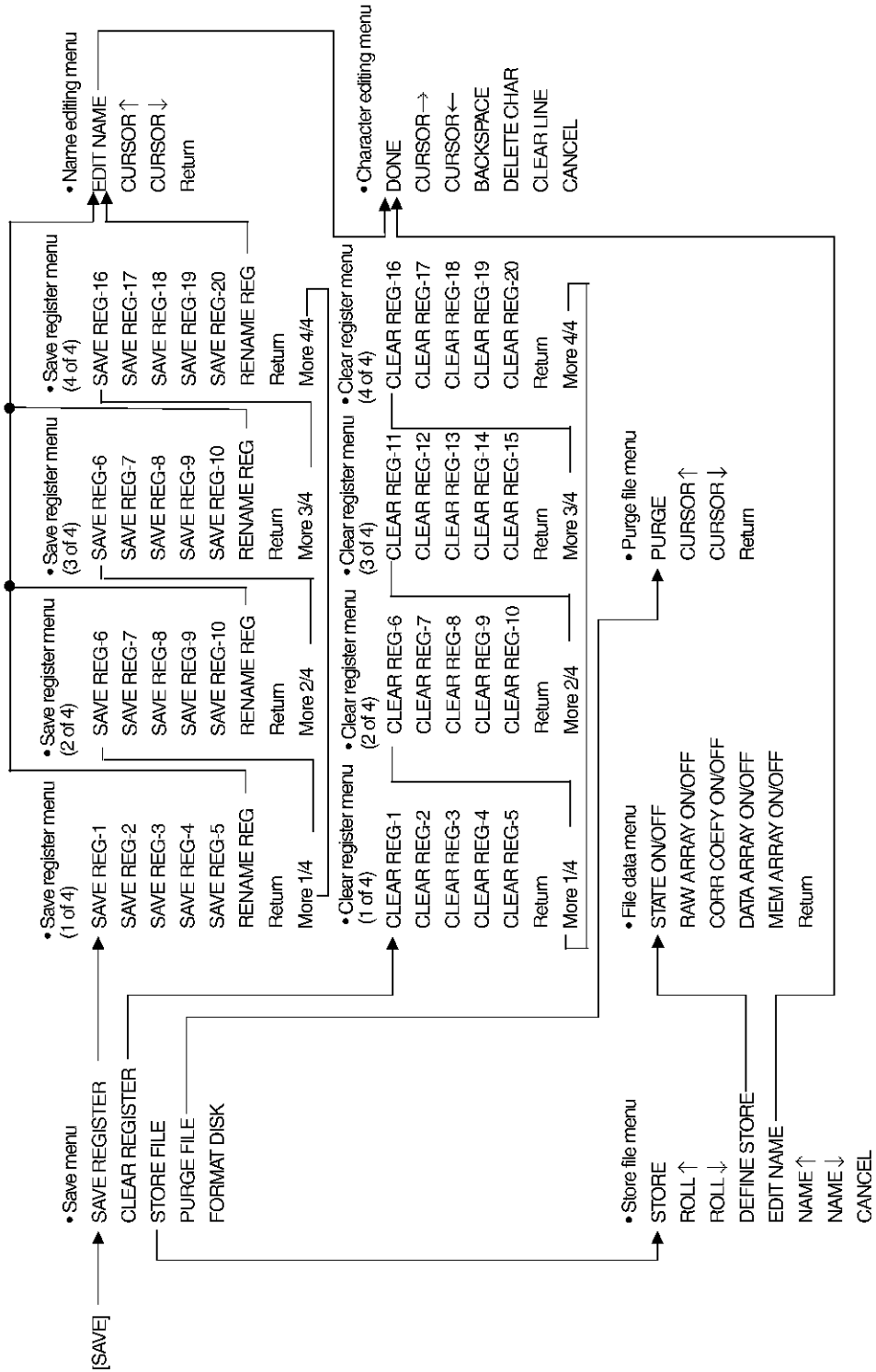

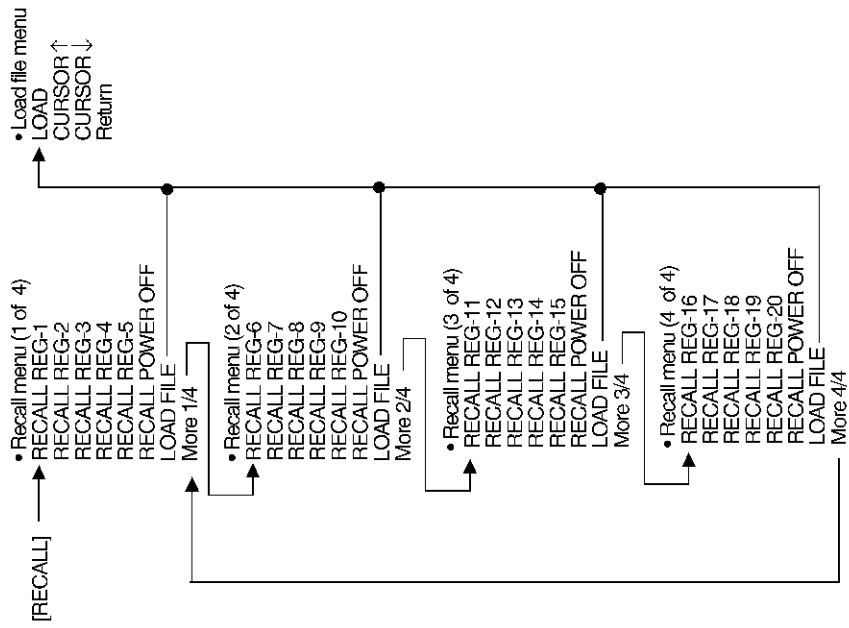

A.2 Soft Key Menu List

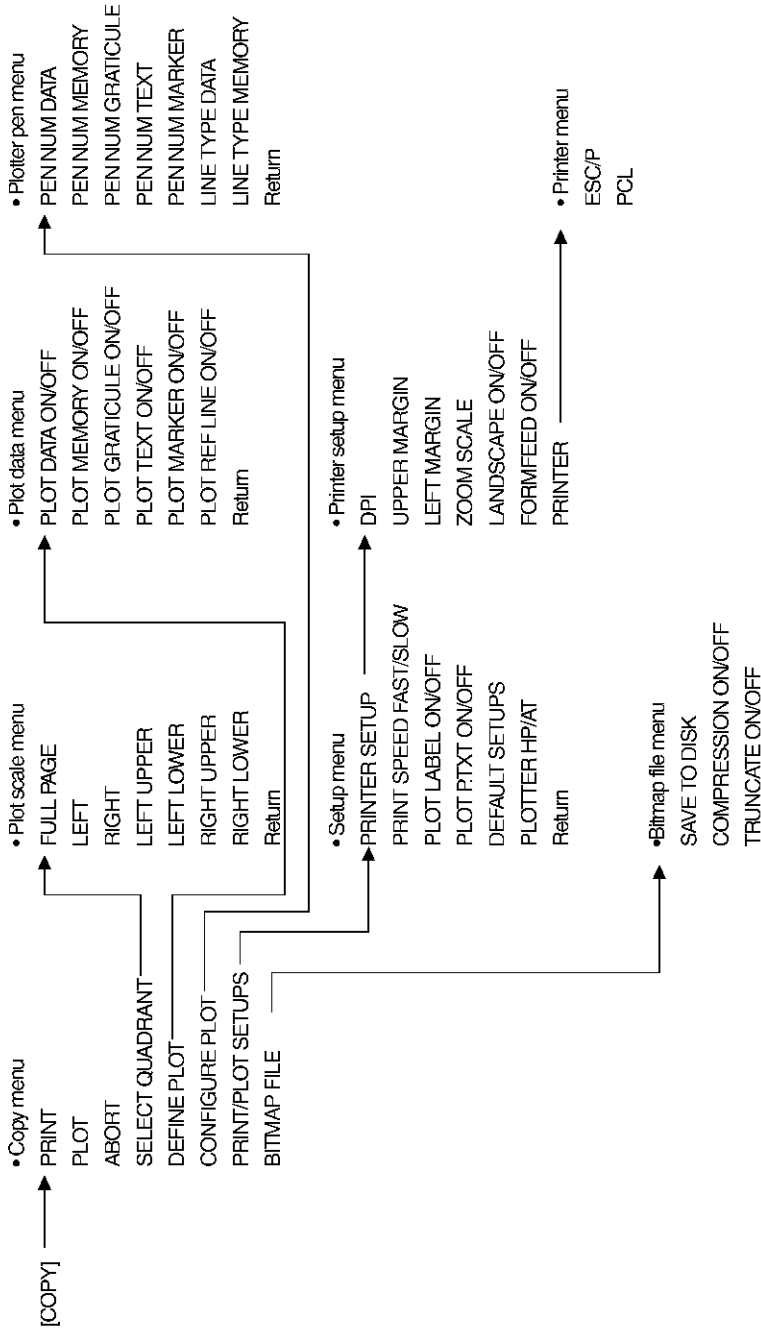



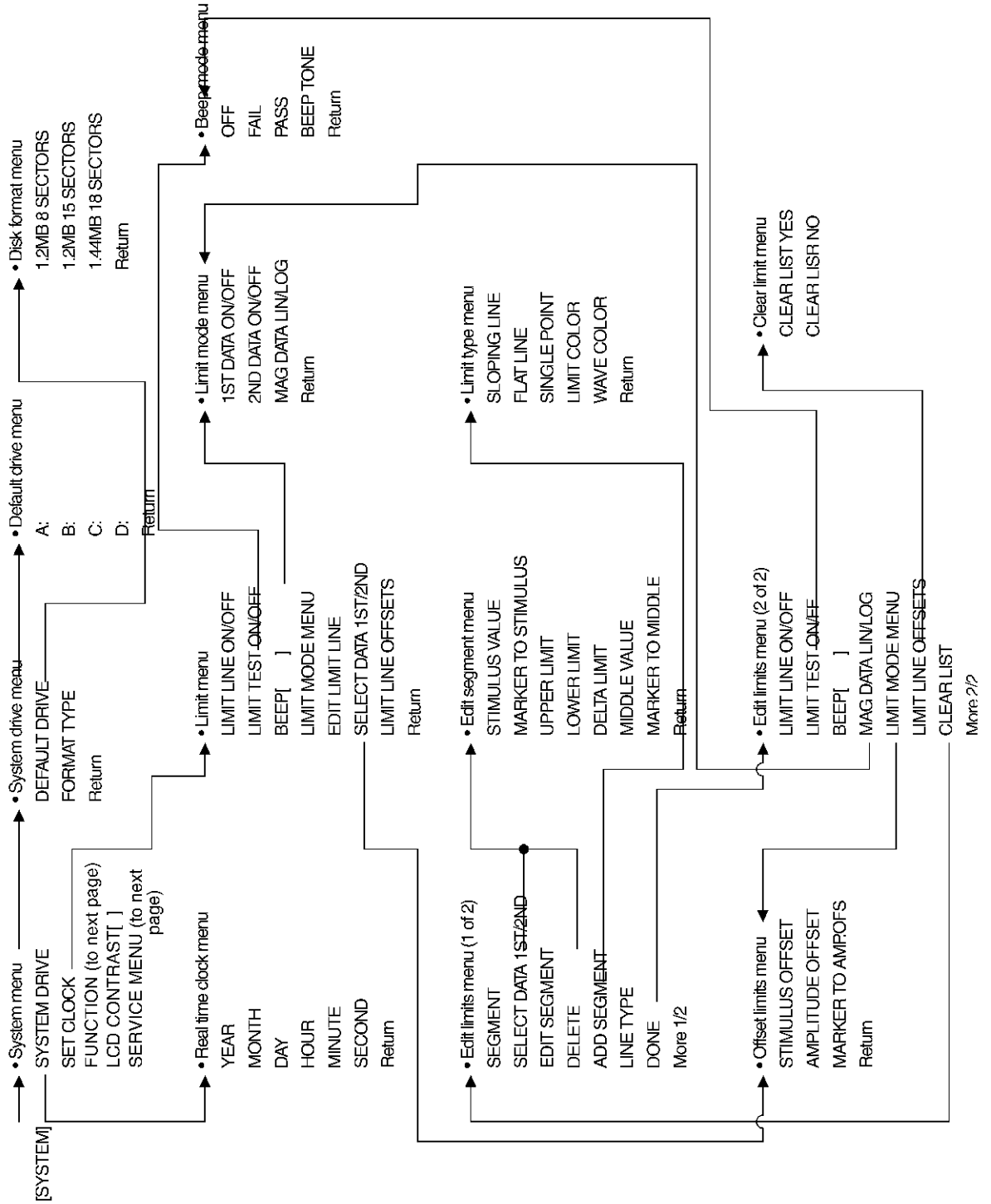

A.2 Soft Key Menu List

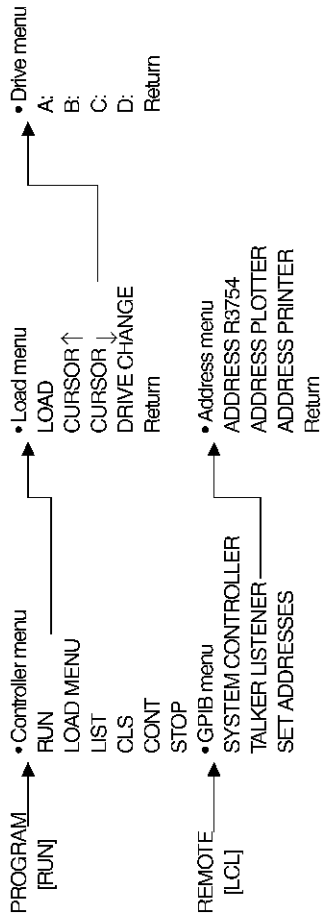

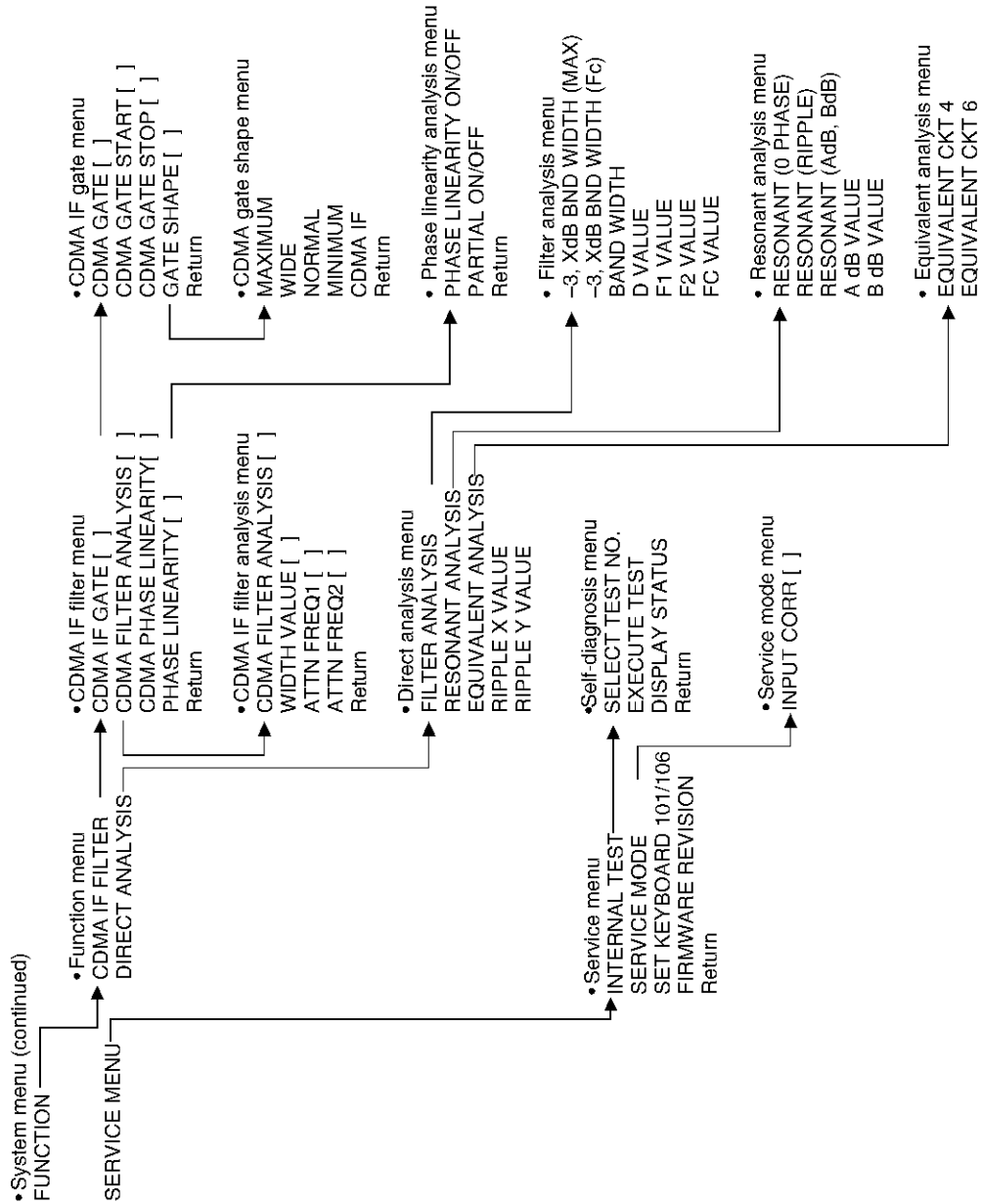

A.3 GPIB Command List for Panel Key/Soft Key

**A.3 GPIB Command List for Panel Key/Soft Key**

Shows the GPIB command corresponding to the panel key or the soft key. Refer to the separate volume "Programming Manual" for the details of each command.

- Describes depending on the item in the following panel.

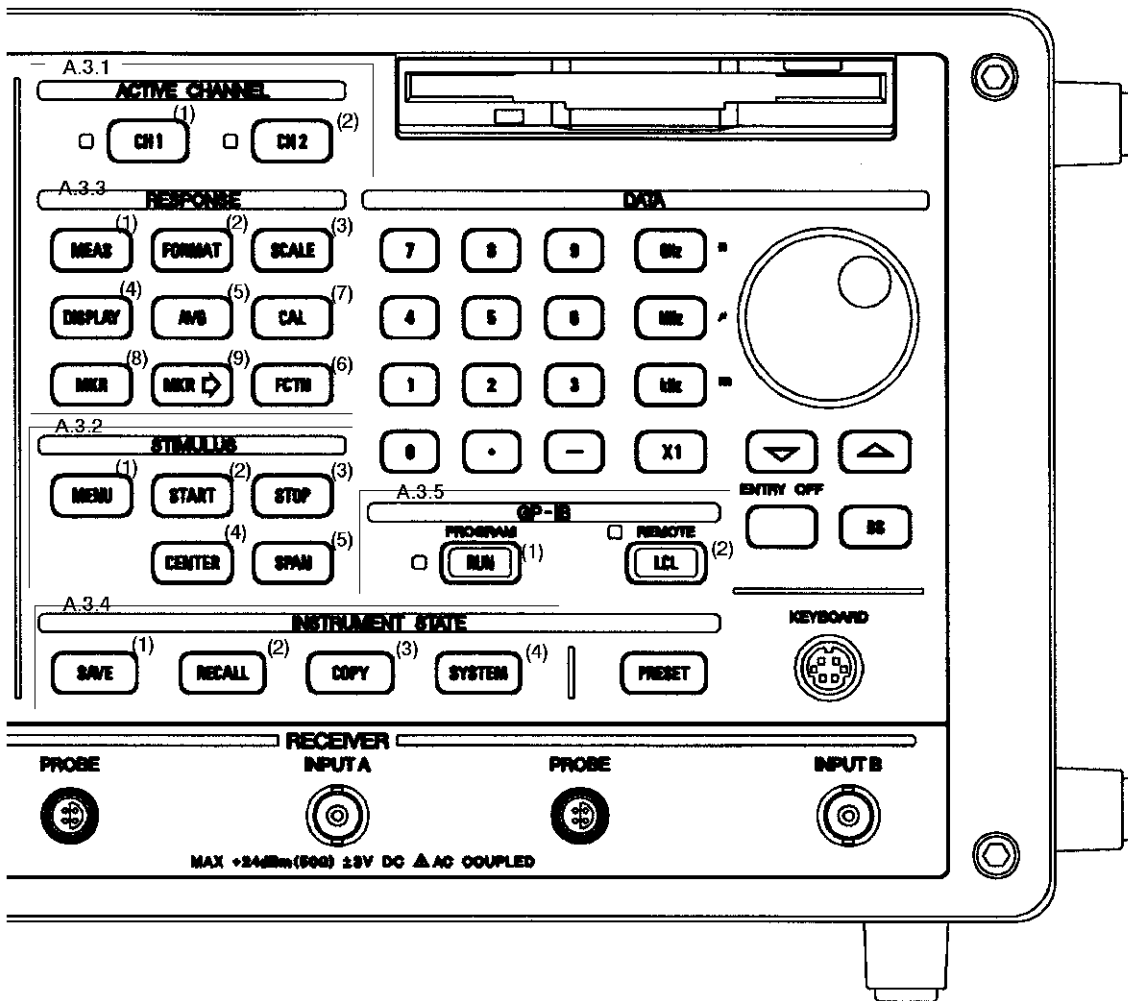

- Explanation of "O" and "N"
  - O: R3751 command mode
  - N: R3752/53H command mode

**A.3.1 ACTIVE CHANNEL Block**

(1) CH1

[CH1] O : CH1  
N : DISPlay:ACTive 1

(2) CH2

[CH2] O : CH2  
N : DISPlay:ACTive 2

**A.3.2 STIMULUS Block**

(1) MENU

Signal source menu

{POWER} Calls the power menu. (See step (1-1).)

{SWEEP TIME} O : STIME <real>  
STIMEAUTO  
N : [SOURce:]SWEep[<chno>]:TIME <real>  
[SOURce:]SWEep[<chno>]:TIME:AUTO <bool>

{SWEEP TYPE[ ]} Calls the sweep type menu. (See step (1-3).)

{TRIGGER[ ]} Calls the trigger menu. (See step (1-2).)

{POINTS} O : M{1201|601|301|201|101|51|21|11|6|3}P / POIN <int>  
N : [SOURce:]SWEep[<chno>]:POINts <int>

{COUPLED CH ON/OFF} O : COUPLE <bool>  
N : [SOURce:]COUPlE <bool>

{CW FREQ} O : CWFREQ <real>  
N : [SOURce:]FREQuency[<chno>]:CW <real>

{RESTART} O : MEAS  
N : ABORt;INITiate[:IMMediate]

A.3 GPIB Command List for Panel Key/Soft Key

(1-1) Power menu

{OUTPUT 1}	O : PORT1 N : OUTPut1[:STATe] ON
{OUTPUT 2}(Note 1)	O : PORT2 N : OUTPut2[:STATe] ON
{POWER}	O : OUTLEV <real> N : [SOURce:]POWer[<chno>][:LEVel][:AMPLitude] <real>
{Return}	Returns to the signal source menu. (See step (1).)

**Note1:** This menu is displayed only when Option 10 or 11 is installed.

(1-2) Trigger menu

{CONTINUOUS}	O : CONT ON N : INITiate:CONTInuous ON
{SINGLE}	O : SINGLE N : INITiate:CONTInuous OFF;;ABORt;INITiate
{HOLD}	O : SWPHLD N : INITiate:CONTInuous OFF;;ABORt
{INT TRIG}	O : FREE N : TRIGger[:SEQuence]:SOURce IMMEDIATE
{EXT TRIG}	O : EXTERN N : TRIGger[:SEQuence]:SOURce EXTernal
{TRIGGER DELAY}	O : SETLTIME <real> N : TRIGger[:SEQuence]:DELay <real>
{Return}	Returns to the signal source menu. (See step (1).)

## (1-3) Sweep type menu

{ <i>LIN FREQ</i> }	O : LINFREQ N : [SOURce:]FREQuency[<chno>]:MODE SWEep; [SOURce:]SWEep[<chno>]:SPACing LINear
{ <i>LOG FREQ</i> }	O : LOGFREQ N : [SOURce:]FREQuency[<chno>]:MODE SWep; [SOURce:]SWEep[<chno>]:SPACing LOGarithmic *Use these commands together.
{ <i>USER SWEEP</i> }	O : USRFSWP N : [SOURce:]PSWeep[<chno>]:MODE FREQuency
{ <i>PROGRAM SWEEP</i> }	O : USRARWP N : [SOURce:]PSWeep[<chno>]:MODE ALL
{ <i>POW SWEEP</i> }	O : LEVEL N : [SOURce:]POWer[<chno>]:MODE SWEep
{ <i>EDIT USER SWEEP</i> }	Calls the user frequency sweep segment editing menu. (See step (1-3-1).)
{ <i>EDIT PROG SWEEP</i> }	Calls the program sweep segment editing menu. (See step (1-3-2).)
{ <i>Return</i> }	Returns to the signal source menu. (See step (1).)

## (1-3-1) User frequency sweep segment editing menu

{ <i>SEGMENT:NUMBER</i> }	O : USEG <n> N : (Note)
{ <i>START</i> }	O : USTART <start> N : [SOURce:]PSWeep[<chno>]:FREQuency[<n>]<start>[,<stop>]
{ <i>STOP</i> }	O : USTOP <stop> N : [SOURce:]PSWeep[<chno>]:FREQuency[<n>]<start>[,<stop>]
{ <i>FREQ</i> }	O : UFREQ <real> N : [SOURce:]PSWeep[<chno>]:FREQuency[<n>] <start>
{ <i>POINT</i> }	O : UPOINT <int> N : [SOURce:]PSWeep[<chno>]:POINts[<n>] <int>
{ <i>CLEAR SEG</i> }	O : There is no GPIB command to be applied. N : [SOURce:]PSWeep[<chno>]:CLEar[<n>]
{ <i>CLEAR ALL SEG</i> }	O : USEGCL N : [SOURce:]PSWeep[<chno>]:CLEar[<n>]:ALL
{ <i>Return</i> }	

<start> and <stop> are <real>.

Note: In the R3752 and R3753 command modes, a segment number must be specified by the parameter <n> in the GPIB command.

A.3 GPIB Command List for Panel Key/Soft Key

(1-3-2) Program sweep segment editing menu (1 of 2)

<i>{SEGMENT:NUMBER}</i>	O : USEG <n> N : (Note)
<i>{START}</i>	O : USTART <start> / UFREQ <real> N : [SOURCE:]PSWeep[<chno>]:FREQUency[<n>]<start> [,<stop>]
<i>{STOP}</i>	O : USTOP <stop> N : [SOURCE:]PSWeep[<chno>]:FREQUency[<n>]<start> [,<stop>]
<i>{POINT}</i>	O : UPOINT <int> N : [SOURCE:]PSWeep[<chno>]:POINts[<n>] <int>
<i>{CLEAR SEG}</i>	O : There is no GPIB command to be applied. N : [SOURCE:]PSWeep[<chno>]:CLEAr[<n>]
<i>{CLEAR ALL SEG}</i>	O : USEGCL N : [SOURCE:]PSWeep[<chno>]:CLEAr[<n>]:ALL
<i>{Return}</i>	Returns to the sweep type menu. (See step (1-3).)
<i>{More 1/2}</i>	Calls the program sweep segment editing menu (2 of 2).

<start> and <stop> are real.

Note: In the R3752 and R3753 command modes, a segment number must be specified by the parameter <n> in the GPIB command.

Program sweep segment editing menu (2 of 2)

<i>{SEGMENT:POWER}</i>	O : ULEVEL<real> N : [SOURCE:]PSWeep[<chno>]:POWer[<n>] <real>
<i>{IF RBW}</i>	O : URBW<int> N : [SOURCE:]PSWeep[<chno>]:BANDwidth[<n>] <int>
<i>{SETTLING TIME}</i>	O : USETLT<real> N : [SOURCE:]PSWeep[<chno>]:SETTLing[<n>] <int>
<i>{Rch INPUT [ ]}</i>	O : UATTIR{AUTO 0 25}/UAMPIR{0 16} N : [SOURCE:]PSWeep[<chno>]:INPut1:ATTenuation[<n>]:AUTO ON/ [SOURCE:]PSWeep[<chno>]:INPut1:ATTenuation[<n>] {0 25}/ [SOURCE:]PSWeep[<chno>]:INPut1:GAIN[<n>] {0 16}
<i>{Ach INPUT [ ]}</i> (Note 1)	O : UATTIA{AUTO 0 25}/UAMPIA{0 16} N : [SOURCE:]PSWeep[<chno>]:INPut2:ATTenuation[<n>]:AUTO ON/ [SOURCE:]PSWeep[<chno>]:INPut2:ATTenuation[<n>] {0 25}/ [SOURCE:]PSWeep[<chno>]:INPut2:GAIN[<n>] {0 16}





### A.3.3 RESPONSE Block

(1) MEAS

Measurement menu

{A/R}(Note 1)           O : ARIN  
                          N : [SENSe:]FUNCTION[<chno>][:ON] 'POWer:AC:RATIo 2, 1'

{B/R}(Note 2)           O : BRIN  
                          N : [SENSe:]FUNCTION[<chno>][:ON] 'POWer:AC:RATIo 3, 1'

{A/B}(Note 2)           O : ABIN  
                          N : [SENSe:]FUNCTION[<chno>][:ON] 'POWer:AC:RATIo 2, 3'

{R}                       O : RIN  
                          N : [SENSe:]FUNCTION[<chno>][:ON] 'POWer:AC 1'

{A}(Note 1)             O : AIN  
                          N : [SENSe:]FUNCTION[<chno>][:ON] 'POWer:AC 2'

{B}(Note 2)             O : BIN  
                          N : [SENSe:]FUNCTION[<chno>][:ON] 'POWer:AC 3'

{CONVERSION[     ]}    Calls the parameter conversion menu. (See step (1-1).)

{S PARAMETERS}        Calls S parameter menu. (See step (1-2).)

**Note1: This menu is displayed only when Option 10 or 11 is installed.**

**Note 2: This menu is displayed only when Option 11 is installed.**

## (1-1) Parameter conversion menu

<i>{Z(REFL)}</i>	O : CONVRZ N : CALCulate[<chno>]:TRANSform:IMPedance:TYPE ZREFlection
<i>{Z(TRANS)}</i>	O : CONVTZ N : CALCulate[<chno>]:TRANSform:IMPedance:TYPE ZTRansmit
<i>{Y(REFL)}</i>	O : CONVRY N : CALCulate[<chno>]:TRANSform:IMPedance:TYPE YREFlection
<i>{Y(TRANS)}</i>	O : CONVTY N : CALCulate[<chno>]:TRANSform:IMPedance:TYPE YTRansmit
<i>{1/S}</i>	O : CONV1DS N : CALCulate[<chno>]:TRANSform:IMPedance:TYPE INVersion
<i>{OFF}</i>	O : CONVOFF N : CALCulate[<chno>]:TRANSform:IMPedance:TYPE NONE
<i>{Z0 VALUE}</i>	O : SETZ0 <real> / MKRZO {50 75} N : CALCulate[<chno>]:TRANSform:IMPedance:CIMPedance <real>
<i>{Return}</i>	Returns to the measurement menu (See step (1).)

A.3 GPIB Command List for Panel Key/Soft Key

(2) FORMAT

Format menu (1 of 2)

- {LOG MAG}*            O : LOGMAG  
                         N : CALCulate[<chno>]:FORMat MLOGarithmic
- {PHASE}*             O : PHASE  
                         N : CALCulate[<chno>]:FORMat PHASe
- {DELAY}*             O : DELAY  
                         N : CALCulate[<chno>]:FORMat GDELay
- {SMITH(R+jX)}*      O : SRJX  
                         N : CALCulate[<chno>]:FORMat SCHart
- {SMITH(G+jB)}*      O : SGJB  
                         N : CALCulate[<chno>]:FORMat ISCHart
- {POLAR}*             O : POLAR  
                         N : CALCulate[<chno>]:FORMat POLar
- {LIN MAG}*            O : LINMAG  
                         N : CALCulate[<chno>]:FORMat MLINear
- {More 1/2}*            Calls the format menu (2 of 2).

Format menu (2 of 2)

- {SWR}*                O : SWR  
                         N : CALCulate[<chno>]:FORMat SWR
- {REAL}*                O : REAL  
                         N : CALCulate[<chno>]:FORMat REAL
- {IMAG}*                O : IMAG  
                         N : CALCulate[<chno>]:FORMat IMAGinary
- {PHASE -∞, +∞}*      O : UNWRAP  
                         N : CALCulate[<chno>]:FORMat UPHase
- {LOG MAG & PHASE}*   O : LOGMP  
                         N : CALCulate[<chno>]:FORMat MLOPhase
- {LOG MAG & DELAY}*   O : LOGMD  
                         N : CALCulate[<chno>]:FORMat MLODelay
- {LIN MAG & PHASE}*   O : LINMP  
                         N : CALCulate[<chno>]:FORMat M LIPhase
- {More 2/2}*            Calls the format menu (1 of 2).

## (3) SCALE

Scale menu

<i>{AUTO SCALE}</i>	O : AUTO N : DISPlay[:WINDow[<chno>]]:Y[<trace>]:SCALE]:AUTO ONCE
<i>{/DIV}</i>	O : SDIV <real> N : DISPlay[:WINDow[<chno>]]:Y[<trace>]:SCALE]:PDIVision <real>
<i>{REF VALUE}</i>	O : REFL <real> N : DISPlay[:WINDow[<chno>]]:Y[<trace>]:SCALE]:REFVal <real>
<i>{REF POS}</i>	O : REFP <real> N : DISPlay[:WINDow[<chno>]]:Y[<trace>]:SCALE]:RPOSition <real>
<i>{REF LINE}</i>	O : REFL <bool> N : DISPlay[:WINDow[<chno>]]:Y[<trace>]:RLINE <bool>
<i>{SCALE FOR 2nd/1st}</i>	O : SCALF{1ST 2ND} N : (Note)

<trace>= 0,1,8,9 (0:CH1 TRACE 1st, 1:CH2 TRACE 1st, 8:CH1 TRACE 2nd, 9:CH2 TRACE 2nd)

Note: In the R3752 and R3753 command modes, a segment number must be specified by the parameter <trace> in the GPIB command.

A.3 GPIB Command List for Panel Key/Soft Key

(4) DISPLAY

Display menu (1 of 2)

{DUAL CH ON/OFF}	O : DUAL <bool> N : DISPlay:DUAL <bool>
{SPLIT CH ON/OFF}	O : SPLIT <bool> N : DISPlay:FORMat {ULOWer FBACK} (See Note.)
{DISPLAY DATA}	O : DISpdata N : DISPlay[:WINDow[<chno>]]:TRACe:ASSign DATA
{DISPLAY MEMORY}	O : DISPMEM N : DISPlay[:WINDow[<chno>]]:TRACe:ASSign MEMory
{DISPLAY DATA & MEM}	O : DISPDm N : DISPlay[:WINDow[<chno>]]:TRACe:ASSign DMEMemory
{DEFINE TRACE[    ]}	Calls the trace operation menu. (See step (4-2).)
{DATA → MEMORY}	O : DTOM N : TRACe[<chno>]:COPY DATA
{More 1/2}	Calls the display menu (2 of 2).

**Note: SPLIT CH:**  
           **ULOWer;    Split display**  
           **FBACK;    Overlap display**

Display menu (2 of 2)

{GRATICULE ON/OFF}	O : GRAT <bool> N : DISPlay[:WINDow[<chno>]]:TRACe:GRATicule[:STATe] <bool>
{LABEL}	Calls the label menu. (See step (4-1).)
{COLOR}	There is no GPIB command to be applied.
{DEFAULT COLOR}	There is no GPIB command to be applied.
{More 2/2}	Calls the display menu (1 of 2).

## (4-1) Label menu

<i>{DONE}</i>	O : LABEL <str> N : DISPlay[:WINDow[<chno>]]:TEXT[:DATA] {<str> <block>}
<i>{CURSOR→}</i>	There is no GPIB command to be applied.
<i>{CURSOR←}</i>	There is no GPIB command to be applied.
<i>{BACKSPACE}</i>	There is no GPIB command to be applied.
<i>{DELETE CHAR}</i>	There is no GPIB command to be applied.
<i>{CLEAR LINE}</i>	There is no GPIB command to be applied.
<i>{CANCEL}</i>	Calls the display menu (2 of 2). (See step (4).)

## (4-2) Trace operation menu

<i>{DATA/MEM}</i>	O : DISPDDM ON N : CALCulate[<chno>]:MATH[:EXPRession]:NAME DDM
<i>{DATA-MEM}</i>	O : There is no GPIB command to be applied. N : CALCulate[<chno>]:MATH[:EXPRession]:NAME DSM
<i>{DATA*MEM}</i>	O : There is no GPIB command to be applied. N : CALCulate[<chno>]:MATH[:EXPRession]:NAME DMM
<i>{DATA+MEM}</i>	O : There is no GPIB command to be applied. N : CALCulate[<chno>]:MATH[:EXPRession]:NAME DAM
<i>{OFF}</i>	O : DISPDDM OFF N : CALCulate[<chno>]:MATH[:EXPRession]:NAME NONE
<i>{Return}</i>	Returns to the display menu (1 of 2). (See step (4).)

A.3 GPIB Command List for Panel Key/Soft Key

(5) AVG

Average menu

<i>{AVG STATE ON/OFF}</i>	O : AVER <bool> N : [SENSe:]AVERAge[<chno>]:[STATe] <bool>
<i>{AVG COUNT}</i>	O : AVERFACT <int>/ AVR{2 4 8 16 32 64 128} N : [SENSe:]AVERAge[<chno>]:COUNT <int>
<i>{AVG RESTART}</i>	O : AVERREST N : [SENSe:]AVERAge[<chno>]:REStArt
<i>{GROUP DELAY APERTURE}</i>	O : APERTP <real> N : CALCulate[<chno>]:GDAPerture:APERture <real>
<i>{SMOOTHING ON/OFF}</i>	O : SMOO <bool> N : CALCulate[<chno>]:SMOothing:STATe <bool>
<i>{SMOOTHING APERTURE}</i>	O : SMOOAPER <REAL> N : CALCulate[<chno>]:SMOothing:APERture <real>
<i>{IF RBW[    ]}</i>	O : RBW <int> / RBW{1K 300 100 30 10}HZ / RBWAUTO N : [SENSe:]BANDwidth[:REsolution] <real> [SENSe:]BANDwidth[:REsolution]:AUTO <bool>



## (6) Function

## Input gain menu

<code>{Rch:ATT [ ]}</code>	O : ATTIR{AUTO 0 25}
	N : INPut1:ATTenuation:AUTO ON/ INPut1:ATTenuation {0 25}
<code>{Rch:AMP 0dB/16dB}</code>	O : AMPIR{0 16}
	N : INPut1:GAIN {0 16}
<code>{Ach:ATT [ ]}</code> (Note 1)	O : ATTIA{AUTO 0 25}
	N : INPut2:ATTenuation:AUTO ON/ INPut2:ATTenuation {0 25}
<code>{Ach:AMP 0dB/16dB}</code> (Note 1)	O : AMPIA{0 16}
	N : INPut2:GAIN {0 16}
<code>{Bch:ATT [ ]}</code> (Note 2)	O : ATTIB{AUTO 0 25}
	N : INPut3:ATTenuation:AUTO ON/ INPut3:ATTenuation {0 25}
<code>{Bch:AMP 0dB/16dB}</code> (Note 2)	O : AMPIB{0 16}
	N : INPut3:GAIN {0 16}

**Note 1:** This menu is displayed only when Option 10 or 11 is installed.

**Note 2:** This menu is displayed only when Option 11 is installed.

## (6-1) Attenuator selection menu

<code>{INPUT ATT AUTO}</code>	O : ATTI{RIAIB}AUTO
	N : INPut[<input>]:ATTenuation:AUTO <bool>
<code>{INPUT ATT 0dB}</code>	O : ATTI{RIAIB} 0
	N : INPut[<input>]:ATTenuation 0
<code>{INPUT ATT 25dB}</code>	O : ATTI{RIAIB} 25
	N : INPut[<input>]:ATTenuation 25
<code>{Return}</code>	Returns to the attenuator menu. (See step (6).)

<input> = {1|2|3}(1:Rch, 2:Ach, 3:Bch)

## A.3 GPIB Command List for Panel Key/Soft Key

## (7) CAL

Calibration menu (1 of 2)

<i>{NORMALIZE(THRU)}</i>	O : NORM ON N : [SENSe:]CORRection[<chno>]:COLLect[:ACQuire] NORMalize
<i>{NORMALIZE(SHORT)}</i>	O : NORMS ON N : [SENSe:]CORRection[<chno>]:COLLect[:ACQuire] SNORMalize
<i>{CAL MENU}</i>	Calls the full calibration selection menu. (See step (7-1).)
<i>{CORRECT ON/OFF}</i>	O : CORRECT <bool> N : [SENSe:]CORRection[<chno>]:CSET:STATe <bool>
<i>{INTERPOLATE ON/OFF}</i>	O : INTERPOL <bool> N : [SENSe:]CORRection[<chno>]:CSET:INTerpolate <bool>
<i>{PORT EXTENSION}</i>	Calls the port extension menu. (See step (7-2).)
<i>{Z0 VALUE}</i>	O : SETZ0 <real> / MKRZO{50 75} N : CALCulate[<chno>]:TRANSform:IMPedance:CIMPedance <real>
<i>{More 1/2}</i>	Calls the calibration menu (2 of 2).

Calibration menu (2 of 2)

<i>{ELEC DELAY ON/OFF}</i>	O : LENGTH <bool> N : [SENSe:]CORRection[<chno>]:EDELay:STATe <bool>
<i>{ELECTRICAL DELAY}</i>	O : ELED <real> N : [SENSe:]CORRection[<chno>]:EDELay[:TIME] <real>
<i>{ELECTRICAL LENGTH}</i>	O : LENGVAL <real> N : [SENSe:]CORRection[<chno>]:EDELay:DISTance <real>
<i>{VELOCITY FACTOR}</i>	O : VELOFACT <real> N : [SENSe:]CORRection[<chno>]:RVELocity:COAX <real>
<i>{PHASE OFFSET VALUE}</i>	O : PHAO N : [SENSe:]CORRection[<chno>]:OFFSet:PHASe <real>
<i>{PHASE SLOPE}</i>	O : PHASL0 <real> N : [SENSe:]CORRection[<chno>]:SLOPe:PHASe <real>
<i>{More 2/2}</i>	Calls the calibration menu (1 of 2).

## (7-1) Full calibration selection menu

<i>{1PORT FULL CAL}</i>	Calls the 1 port full calibration menu. (See step (7-1-1).)
<i>{TRANS FULL CAL}</i>	Calls the transmission full calibration menu. (See step (7-1-2).)
<i>{CLEAR CAL DATA}</i>	O : CLEAR N : [SENSe:]CORRection[<chno>]:COLLect:DELeTe
<i>{Return}</i>	Returns to the calibration menu (1 of 2). (See step (7).)

## (7-1-1) 1 port full calibration menu

<i>{OPEN}</i>	O : OPEN N : [SENSe:]CORRection[<chno>]:COLLect[:ACQuire] OPEN
<i>{SHORT}</i>	O : SHORT N : [SENSe:]CORRection[<chno>]:COLLect[:ACQuire] SHORT
<i>{LOAD}</i>	O : LOAD N : [SENSe:]CORRection[<chno>]:COLLect[:ACQuire] LOAD
<i>{DONE 1-PORT}</i>	O : DONE / DONE1PORT N : [SENSe:]CORRection:COLLect:SAVE

## (7-1-2) Impedance calibration menu

<i>{OPEN}</i>	O : IMPOPEN N : [SENSe:]CORRection:COLLect[:ACQuire] IOPen
<i>{SHORT}</i>	O : IMPSHORT N : [SENSe:]CORRection:COLLect[:ACQuire] ISHort
<i>{LOAD}</i>	O : IMPLD50 N : [SENSe:]CORRection:COLLect[:ACQuire] ILOad50
<i>{DONE TRANS}</i>	O : DONE N : [SENSe:]CORRection:COLLect:SAVE

## A.3 GPIB Command List for Panel Key/Soft Key

## (7-2) Port extension menu

{EXTENSION ON/OFF}	O : PORE <bool> N : [SENSe:]CORRection[<chno>]:PEXTension:STATe <bool>
{EXTENSION INPUT R}	O : EPORTR <real> N : [SENSe:]CORRection[<chno>]:PEXTension:TIME1 <real>
{EXTENSION INPUT A} (Note 1)	O : EPORTA <real> N : [SENSe:]CORRection[<chno>]:PEXTension:TIME2 <real>
{EXTENSION INPUT B} (Note 2)	O : EPORTB <real> N : [SENSe:]CORRection[<chno>]:PEXTension:TIME3 <real>
{Return}	Returns to the calibration menu (2 of 2). (See step (7).)

**Note 1: This menu is displayed only when Option 10 or 11 is installed.**

**Note 2: This menu is displayed only when Option 11 is installed.**

## (7-3) Calibration standard definition menu

{OPEN STD}	O : STDO{RSILSICP}<real> [SENSe:]CORRection[<chno>]:CKIT:DEFine:STANdard: {OIMPedancelOINDuctancelOCAPacitance} <real>
{SHORT STD}	O : STDS{RSILSICP}<real> N : [SENSe:]CORRection[<chno>]:CKIT:DEFine:STANdard: {SIMPedancelSINDuctancelSCAPacitance} <real>
{LOAD STD}	O : STDL{RSILSICP}<real> N : [SENSe:]CORRection[<chno>]:CKIT:DEFine:STANdard: {LIMPedancelLINDuctancelLCAPacitance} <real>
{SAVE STD VALUE}	O : STDSAVE N : [SENSe:]CORRection[<chno>]:CKIT:DEFine:SAVE

## (8) MKR

## Marker menu

{ACTIVATE MARKER}	}} Calls the active marker menu (1 of 2). (See step (8-1).)
{MARKER ALL OFF}	O : MKRAOFF N : MARKer[<chno>]:AOFF
{ΔMODE MENU}	Calls the delta mode menu. (See step (8-2).)
{MKR LIST}	O : There is no GPIB command to be applied. N : MARKer[<chno>]:LIST <bool>

*{MARKER MODE MENU}* Calls the marker mode menu. (See step (8-3).)

For acquiring the marker data, the following commands can be used.

O : MKR {1|2|3|4|5|6|7|8|9|10} A?

N : FETch[<chno>]:MARKer[:ACTivate]?  
FETch[<chno>]:MARKer:NUMBer<n>?

(8-1) Active marker menu (1 of 2)

*{MARKER 1}* O : MKR1A <real>  
N : MARKer[<chno>]:ACTivate[:NUMBer] 1[,<real>]

*{MARKER 2}* O : MKR2A <real>  
N : MARKer[<chno>]:ACTivate[:NUMBer] 2[,<real>]

*{MARKER 3}* O : MKR3A <real>  
N : MARKer[<chno>]:ACTivate[:NUMBer] 3[,<real>]

*{MARKER 4}* O : MKR4A <real>  
N : MARKer[<chno>]:ACTivate[:NUMBer] 4[,<real>]

*{MARKER 5}* O : MKR5A <real>  
N : MARKer[<chno>]:ACTivate[:NUMBer] 5[,<real>]

*{ACTIVATE MKR OFF}* O : MKROFF  
N : MARKer[<chno>]:ACTivate:STATe <bool>

*{Return}* Returns to the marker menu. (See step (8).)

*{More 1/2}* Calls the active marker menu (2 of 2).

Active marker menu (2 of 2)

*{MARKER 6}* O : MKR6A <real>  
N : MARKer[<chno>]:ACTivate[:NUMBer] 6[,<real>]

*{MARKER 7}* O : MKR7A <real>  
N : MARKer[<chno>]:ACTivate[:NUMBer] 7[,<real>]

*{MARKER 8}* O : MKR8A <real>  
N : MARKer[<chno>]:ACTivate[:NUMBer] 8[,<real>]

*{MARKER 9}* O : MKR9A <real>  
N : MARKer[<chno>]:ACTivate[:NUMBer] 9[,<real>]

*{MARKER 10}* O : MKR10A <real>  
N : MARKer[<chno>]:ACTivate[:NUMBer] 10[,<real>]

*{ACTIVATE MKR OFF}* O : MKROFF  
N : MARKer[<chno>]:ACTivate:STATe <bool>

*{Return}* Returns to the marker menu. (See step (8).)

## A.3 GPIB Command List for Panel Key/Soft Key

<i>{More 2/2}</i>	Calls the active marker menu (1 of 2).
(8-2) Delta mode menu	
<i>{ΔMODE OFF}</i>	O : DMKROF N : MARKer[<chno>]:DELTA[:MODE] OFF
<i>{ΔREF=ΔMKR}</i>	O : DMKRC N : MARKer[<chno>]:DELTA[:MODE] CHILd
<i>{ΔREF=ACT MKR}</i>	Calls the ACT MKR menu. (See step (8-2-1).) O : DMKRA N : MARKer[<chno>]:DELTA[:MODE] COMPare
<i>{ΔREF=FIXED MKR}</i>	O : DMKRF N : MARKer[<chno>]:DELTA[:MODE] FIXed
<i>{FIXED MKR POSITION}</i>	Calls FIXED MKR setting menu. (See step (8-2-2).)
<i>{Return}</i>	Returns to the marker menu. (See step (8).)
Select the compare marker before setting the delta mode to ΔREF=ACT MKR. (See ACT MKR menu.)	
(8-2-1) ACT MKR menu (1 of 2)	
<i>{COMPARE MARKER 1}</i>	O : DMKR1O <real> N : MARKer[<chno>]:DELTA:COMPare 1[,<real>]
<i>{COMPARE MARKER 2}</i>	O : DMKR2O <real> N : MARKer[<chno>]:DELTA:COMPare 2[,<real>]
<i>{COMPARE MARKER 3}</i>	O : DMKR3O <real> N : MARKer[<chno>]:DELTA:COMPare 3[,<real>]
<i>{COMPARE MARKER 4}</i>	O : DMKR4O <real> N : MARKer[<chno>]:DELTA:COMPare 4[,<real>]
<i>{COMPARE MARKER 5}</i>	O : DMKR5O <real> N : MARKer[<chno>]:DELTA:COMPare 5[,<real>]
<i>{ACTIVATE MARKER[ ]}</i>	}} Calls the active marker menu (1 of 2). (See step (8-1).)
<i>{Return}</i>	Returns to the delta mode menu. (See step (8-2).)
<i>{More 1/2}</i>	Calls ACT MKR menu (2 of 2).

## ACT MKR menu (2 of 2)

<i>{COMPARE MARKER 6}</i>	O : DMKR6O <real> N : MARKer[<chno>]:DELTA:COMPare 6[,<real>]
<i>{COMPARE MARKER 7}</i>	O : DMKR7O <real> N : MARKer[<chno>]:DELTA:COMPare 7[,<real>]
<i>{COMPARE MARKER 8}</i>	O : DMKR8O <real> N : MARKer[<chno>]:DELTA:COMPare 8[,<real>]
<i>{COMPARE MARKER 9}</i>	O : DMKR9O <real> N : MARKer[<chno>]:DELTA:COMPare 9[,<real>]
<i>{COMPARE MARKER 10}</i>	O : DMKR10O <real> N : MARKer[<chno>]:DELTA:COMPare 10[,<real>]
<i>{ACTIVATE MARKER[ ]}</i>	Calls the active marker menu (1 of 2). (See step (8-1).)
<i>{Return}</i>	Returns to the delta mode menu. (See step (8-2).)
<i>{More 2/2}</i>	Calls ACT MKR menu (1 of 2).

## (8-2-2) FIXED MKR setting menu

<i>{FIXED MKR STIMULUS}</i>	O : FMKRS <real> N : MARKer[<chno>]:FIXed:STIMulus <real>
<i>{FIXED MKR VALUE}</i>	O : FMKRV <real> N : MARKer[<chno>]:FIXed:VALue <real>
<i>{FIXED MKR AUX VALUE}</i>	O : There is no GPIB command to be applied. N : MARKer[<chno>]:FIXed:AVALue <real>
<i>{FIXED MKR → ACTIVE MKR}</i>	O : MKRFIX N : MARKer[<chno>]:LET FIXed
<i>{Return}</i>	Returns to the delta mode menu. (See step (8-2).)

A.3 GPIB Command List for Panel Key/Soft Key

(8-3) Marker mode menu

<i>{MKR CMP/UNCMP}</i>	O : MKRCMP/ MKRUCMP N : MARKer[<chno>]:COMPensate <bool>
<i>{MKR CPL/UNCPL}</i>	O : MKRCOUP/ MKRUCOUP N : MARKer[<chno>]:COUPle <bool>
<i>{CONVERSION MKR MENU[ ]}</i>	}} Calls the conversion marker menu. (See step (8-3-1).)
<i>{SMITH MKR MENU[ ]}</i>	}} Calls the smith marker menu. (See step (8-3-2).)
<i>{POLAR MKR MENU[ ]}</i>	}} Calls the ploar marker menu. (See step (8-3-3).)
<i>{Return}</i>	Returns to the marker menu. (See step (8).)

(8-3-1) Conversion marker menu

<i>{DEFAULT}</i>	O : ZYMKDFLT N : MARKer[<chno>]:CONVert[:MODE] DEFault
<i>{LIN MKR}</i>	O : ZYMKLIN N : MARKer[<chno>]:CONVert[:MODE] LINear
<i>{Re/Im}</i>	O : ZYMKRI N : MARKer[<chno>]:CONVert[:MODE] RIMaginary
<i>{Return}</i>	Returns to the marker mode menu. (See step (8-3).)

(8-3-2) Smith marker menu

<i>{LIN MKR}</i>	O : SMKRLIN N : MARKer[<chno>]:SMITH MLINear
<i>{LOG MKR}</i>	O : SMKRLOG N : MARKer[<chno>]:SMITH MLOGarithmic
<i>{Re/Im MKR}</i>	O : SMKRRRI N : MARKer[<chno>]:SMITH RIMaginary
<i>{R+jX MKR}</i>	O : SMKRRRX N : MARKer[<chno>]:SMITH IMPedance
<i>{G+jB MKR}</i>	O : SMKRGB N : MARKer[<chno>]:SMITH ADMittance
<i>{Z0 VALUE}</i>	O : SETZ0 <real> / MKRZO{50I75} N : CALCulate[<chno>]:TRANSform:IMPedance:CIMPedance <real>
<i>{Return}</i>	Returns to the marker mode menu. (See step (8-3).)



## (8-3-3) Polar marker menu

<i>{LIN MKR}</i>	O : PMKRLIN N : MARKer[<chno>]:POLar MLINear
<i>{LOG MKR}</i>	O : PMKRLOG N : MARKer[<chno>]:POLar MLOGarithmic
<i>{Re/Im MKR}</i>	O : PMKRRI N : MARKer[<chno>]:POLar RIMaginary
<i>{Z0 VALUE}</i>	O : SETZ0 <real> / MKRZO{50 75} N : CALCulate[<chno>]:TRANSform:IMPedance:CIMPedance <real>
<i>{Return}</i>	Returns to the marker mode menu. (See step (8-3).)

## (9) MKR →

## Marker search menu

<i>{MARKER → START}</i>	O : MKRSTAR N : MARKer[<chno>]:LET START
<i>{MARKER → STOP}</i>	O : MKRSTOP N : MARKer[<chno>]:LET STOP
<i>{MARKER → CENTER}</i>	O : MKRCENT N : MARKer[<chno>]:LET CENTer
<i>{MARKER → SPAN}</i>	O : MKRSPAN N : MARKer[<chno>]:LET SPAN
<i>{MARKER → REF.VALUE}</i>	O : MKRREF N : MARKer[<chno>]:LET RLEVel
<i>{PART SRCH[    ]}</i>	Calls the partial search menu. (See step (9-1).)
<i>{MKR SEARCH[    ]}</i>	Calls the search menu. (See step (9-2).)

## (9-1) Partial search menu

<i>{ΔMODE MENU}</i>	Calls the delta mode menu. (See step (8-2).)
<i>{SET RANGE}</i>	O : There is no GPIB command to be applied. N : MARKer[<chno>]:SEARCh:PARTial:SRANge
<i>{STATISTICS ON/OFF}</i>	O : MKRSTAT <bool> N : *MARKer[<chno>]:STATistics <bool>
<i>{PART SRCH ON/OFF}</i>	O : MKRPART <bool> N : MARKer[<chno>]:SEARCh:PARTial[:STATe] <bool>

A.3 GPIB Command List for Panel Key/Soft Key

*{Return}* Returns to the marker search menu. (See step (9).)

\*Getting the result of analysis.

The followings are available.

O : REPSTAT?

N : FETCh[<chno>]::MARKer]:STATistics?

(9-2) Search menu

*{MKR SEARCH OFF}* O : SRCHOFF  
N : MARKer[<chno>]:SEARch[:MODE] OFF

*{MAX}* O : MAXSRCH  
N : MARKer[<chno>]:SEARch[:MODE] MAX

*{MIN}* O : MINSRCH  
N : MARKer[<chno>]:SEARch[:MODE] MIN

*{TARGET}* Calls the target menu. (See step (9-2-1).)  
O : Not required to specify.  
N : MARKer[<chno>]:SEARch[:MODE] TARGET

*{RIPPLE}* Calls the ripple menu. (See step (9-2-2).)  
O : DRIPPL1  
N : MARKer[<chno>]:SEARch[:MODE] RIPPLE

*{FLTR ANAL}* Calls the filter analysis menu. (See step (9-2-3).)

*{TRACKING ON/OFF}* O : MKRTRAC <bool>  
N : MARKer[<chno>]:SEARch:TRACking <bool>

*{Return}* Returns to the marker search menu. (See stpe (9).)

(9-2-1) Target menu

*{TARGET VALUE}* O : There is no command to be applied.  
N : MARKer[<chno>]:SEARch:TARGet[:MODE] VALue  
MARKer[<chno>]:SEARch:TARGet:VALue <real>

*{0°}* O : ZRPSRCH  
N : MARKer[<chno>]:SEARch:TARGet[:MODE] ZERO

*{±180°}* O : There is no command to be applied.  
N : MARKer[<chno>]:SEARch:TARGet[:MODE] PI

*{LEFT SEARCH}* O : There is no command to be applied.  
N : MARKer[<chno>]:SEARch:TARGet:LLEFT

*{RIGHT SEARCH}* O : There is no command to be applied.  
N : MARKer[<chno>]:SEARch:TARGet:RIGHT

*{Return}* Returns to the search menu. (See step (9-2).)

## (9-2-2) Ripple menu

<i>{MAX}</i>	O : There is no command to be applied. N : MARKer[<chno>]:SEARch:RIPPlE[:MODE] MAX
<i>{MIN}</i>	O : There is no command to be applied. N : MARKer[<chno>]:SEARch:RIPPlE[:MODE] MIN
<i>{ΔMAX-MIN}</i>	O : DRIPPL1 N : MARKer[<chno>]:SEARch:RIPPlE[:MODE] BOTH
<i>{MAX-MIN}</i>	O : DMAXMIN N : MARKer[<chno>]:SEARch:RIPPlE[:MODE] PPEak
<i>{ΔX}</i>	O : DLTX <real> N : MARKer[<chno>]:SEARch:RIPPlE:DX <real>
<i>{ΔY}</i>	O : DLTY <real> N : MARKer[<chno>]:SEARch:RIPPlE:DY <real>
<i>{Return}</i>	Returns to the search menu. (See step (9-2).)

## (9-2-3) Filter analysis menu

<i>{WIDTH VALUE}</i>	O : T{3 6 60}DB/ T{3 6}DEG/ TXDB <real>/ TXDEG <real> N : MARKer[<chno>]:FANalysis:WIDTh <real>
<i>{FILTER TYPE BAND/NOTCH}</i>	O : FANABAND/FANANOTCH N : MARKer[<chno>]:FANalysis:TYPE {BAND NOTCh}
<i>{SEARCH FROM [ ]}</i>	Calls the search reference menu. (See step (9-2-4).)
<i>{DISPLAY MODE ABS/REL}</i>	O : FANAABS/FANAREL N : MARKer[<chno>]:FANalysis:FORMat {ABSolute RELative}
<i>{SEARCH IN/OUT}</i>	O : TIN/ TOUT N : MARKer[<chno>]:FANalysis:DIRection {IN OUT}
<i>{FILTER ANAL ON/OFF}</i>	O : FLTANA <bool> N : MARKer[<chno>]:FANalysis[:STATE] <bool>
<i>{Return}</i>	Returns to the search menu. (See step (9-2).)

The data of filter analysis can be acquired by the following command.

N: FETch[<chno>][:MARKer]:FANalysis?

---

A.3 GPIB Command List for Panel Key/Soft Key

(9-2-4) Search reference menu

{ACTIVE MARKER}	O : TREFACT	
	N : MARKer[<chno>]:FANalysis:REFerence	ACTive
{MAXIMUM VALUES}	O : TREFMAX	
	N : MARKer[<chno>]:FANalysis:REFerence	MAXimum
{REFERENCE LINE}	O : TREFREF	
	N : MARKer[<chno>]:FANalysis:REFerence	RLINe

**A.3.4 INSTRUMENT STATE Block**

## (1) SAVE

Save menu

*{SAVE REGISTER}* Calls the save register menu (1 of 4). (See step (1-1).)*{CLEAR REGISTER}* Calls the clear register menu (1 of 4). (See step (1-2).)*{STORE FILE}* Calls the store file menu. (See step (1-3).)*{PURGE FILE}* Calls the purge file menu. (See step (1-4).)*{FORMAT DISK}* There is no GPIB command to be applied.

## (1-1) Save register menu (1 of 4)

*{SAVE REG-1}* O : SAVEREG1  
N : \*SAV 1/ REGister:SAVE 1*{SAVE REG-2}* O : SAVEREG2  
N : \*SAV 2/ REGister:SAVE 2*{SAVE REG-3}* O : SAVEREG3  
N : \*SAV 3/ REGister:SAVE 3*{SAVE REG-4}* O : SAVEREG4  
N : \*SAV 4/ REGister:SAVE 4*{SAVE REG-5}* O : SAVEREG5  
N : \*SAV 5/ REGister:SAVE 5*{RENAME REG}* There is no GPIB command to be applied.*{Return}* Returns to the save menu. (See step (1).)*{More 1/4}* Calls the save register menu (2 of 4).

A.3 GPIB Command List for Panel Key/Soft Key

Save register menu (2 of 4)

{SAVE REG-6}	O : SAVEREG6 N : *SAV 6/ REGister:SAVE 6
{SAVE REG-7}	O : SAVEREG7 N : *SAV 7/ REGister:SAVE 7
{SAVE REG-8}	O : SAVEREG8 N : *SAV 8/ REGister:SAVE 8
{SAVE REG-9}	O : SAVEREG9 N : *SAV 9/ REGister:SAVE 9
{SAVE REG-10}	O : SAVEREG10 N : *SAV 10/ REGister:SAVE 10
{RENAME REG}	There is no GPIB command to be applied.
{Return}	Returns to the save menu. (See step (1).)
{More 2/4}	Calls the save register menu (3 of 4).

Save register menu (3 of 4)

{SAVE REG-11}	O : SAVEREG11 N : *SAV 11/ REGister:SAVE 11
{SAVE REG-12}	O : SAVEREG12 N : *SAV 12/ REGister:SAVE 12
{SAVE REG-13}	O : SAVEREG13 N : *SAV 13/ REGister:SAVE 13
{SAVE REG-14}	O : SAVEREG14 N : *SAV 14/ REGister:SAVE14
{SAVE REG-15}	O : SAVEREG15 N : *SAV 15/ REGister:SAVE 15
{RENAME REG}	There is no GPIB command to be applied.
{Return}	Returns to the save menu. (See step (1).)
{More 3/4}	Calls the save register menu (4 of 4).

## Save register menu (4 of 4)

<i>{SAVE REG-16}</i>	O : SAVEREG16 N : *SAV 16/ REGister:SAVE 16
<i>{SAVE REG-17}</i>	O : SAVEREG17 N : *SAV 17/ REGister:SAVE 17
<i>{SAVE REG-18}</i>	O : SAVEREG18 N : *SAV 18/ REGister:SAVE 18
<i>{SAVE REG-19}</i>	O : SAVEREG19 N : *SAV 19/ REGister:SAVE 19
<i>{SAVE REG-20}</i>	O : SAVEREG20 N : *SAV 20/ REGister:SAVE 20
<i>{RENAME REG}</i>	There is no GPIB command to be applied.
<i>{Return}</i>	Returns to the save menu. (See step (1).)
<i>{More 4/4}</i>	Calls the save register menu (1 of 4).

## (1-2) Clear register menu (1 of 4)

<i>{CLEAR REG-1}</i>	O : CLRREG1 N : REGister:CLear 1
<i>{CLEAR REG-2}</i>	O : CLRREG2 N : REGister:CLear 2
<i>{CLEAR REG-3}</i>	O : CLRREG3 N : REGister:CLear 3
<i>{CLEAR REG-4}</i>	O : CLRREG4 N : REGister:CLear 4
<i>{CLEAR REG-5}</i>	O : CLRREG5 N : REGister:CLear 5
<i>{Return}</i>	Returns to the save menu. (See step (1).)
<i>{More 1/4}</i>	Calls the clear register menu (2 of 4).

---

A.3 GPIB Command List for Panel Key/Soft Key

Clear register menu (2 of 4)

- |                       |   |
|-----------------------|---|
| <i>{CLEAR REG-6}</i>  | O : CLRREG6<br>N : REGISTER:CLEAR 6       |
| <i>{CLEAR REG-7}</i>  | O : CLRREG7<br>N : REGISTER:CLEAR 7       |
| <i>{CLEAR REG-8}</i>  | O : CLRREG8<br>N : REGISTER:CLEAR 8       |
| <i>{CLEAR REG-9}</i>  | O : CLRREG9<br>N : REGISTER:CLEAR 9       |
| <i>{CLEAR REG-10}</i> | O : CLRREG10<br>N : REGISTER:CLEAR 10     |
| <i>{Return}</i>       | Returns to the save menu. (See step (1).) |
| <i>{More 2/4}</i>     | Calls the clear register menu (3 of 4).   |

Clear register menu (3 of 4)

- |                       |   |
|-----------------------|---|
| <i>{CLEAR REG-11}</i> | O : CLRREG11<br>N : REGISTER:CLEAR 11     |
| <i>{CLEAR REG-12}</i> | O : CLRREG12<br>N : REGISTER:CLEAR 12     |
| <i>{CLEAR REG-13}</i> | O : CLRREG13<br>N : REGISTER:CLEAR 13     |
| <i>{CLEAR REG-14}</i> | O : CLRREG14<br>N : REGISTER:CLEAR 14     |
| <i>{CLEAR REG-15}</i> | O : CLRREG15<br>N : REGISTER:CLEAR 15     |
| <i>{Return}</i>       | Returns to the save menu. (See step (1).) |
| <i>{More 3/4}</i>     | Calls the clear register menu (4 of 4).   |



## Clear register menu (4 of 4)

<i>{CLEAR REG-16}</i>	O : CLRREG16 N : REGister:CLEar 16
<i>{CLEAR REG-17}</i>	O : CLRREG17 N : REGister:CLEar 17
<i>{CLEAR REG-18}</i>	O : CLRREG18 N : REGister:CLEar 18
<i>{CLEAR REG-19}</i>	O : CLRREG19 N : REGister:CLEar 19
<i>{CLEAR REG-20}</i>	O : CLRREG20 N : REGister:CLEar 20
<i>{Return}</i>	Returns to the save menu. (See step (1).)
<i>{More 4/4}</i>	Calls the clear register menu (1 of 4).

## (1-3) Store file menu

<i>{STORE}</i>	O : STFILE <str> N : FILE:STORe <str>
<i>{ROLL↑}</i>	There is no GPIB command to be applied.
<i>{ROLL↓}</i>	There is no GPIB command to be applied.
<i>{DEFINE STORE}</i>	Calls the file data menu. (See step (1-3-1).)
<i>{EDIT NAME}</i>	There is no GPIB command to be applied.
<i>{NAME↑}</i>	There is no GPIB command to be applied.
<i>{NAME↓}</i>	There is no GPIB command to be applied.
<i>{CANCEL}</i>	There is no GPIB command to be applied.

<str> in "STORE" is a file name.

---

A.3 GPIB Command List for Panel Key/Soft Key

(1-3-1) File data menu

{STATE ON/OFF}	O : DSSTATE <bool> N : FILE:STATE:CONDition <bool>
{RAY ARRAY ON/OFF}	O : RAWARY <bool> N : FILE:STATE:RAW <bool>
{CORR COEF ON/OFF}	O : CORARY <bool> N : FILE:STATE:CORRection <bool>
{DATA ARRAY ON/OFF}	O : DATAARY <bool> N : FILE:STATE:DATA <bool>
{MEM ARRY ON/OFF}	O : MEMARY <bool> N : FILE:STATE:MEMory <bool>
{Return}	Returns to the save menu. (See step (1).)

(1-4) Purge file menu

{PURGE}	O : PURGE <str> N : FILE:DELeTe <str>
{CURSOR ↑}	There is no GPIB command to be applied.
{CURSOR ↑}	There is no GPIB command to be applied.
{Return}	Returns to the save menu. (See step (1).)

<str> in "PURGE" is a file name.

## (2) RECALL

Recall menu (1 of 4)

<i>{RECALL REG-1}</i>	O : RECLREG1 N : *RCL 1/ REGISTER:RECall 1
<i>{RECALL REG-2}</i>	O : RECLREG2 N : *RCL 2/ REGISTER:RECall 2
<i>{RECALL REG-3}</i>	O : RECLREG3 N : *RCL 3/ REGISTER:RECall 3
<i>{RECALL REG-4}</i>	O : RECLREG4 N : *RCL 4/ REGISTER:RECall 4
<i>{RECALL REG-5}</i>	O : RECLREG5 N : *RCL 5/ REGISTER:RECall 5
<i>{RECALL POWER OFF}</i>	O : RECLPOFF N : *RCL POFF/ REGISTER:RECall POFF
<i>{LOAD FILE}</i>	O : LDFILE <str> N : FILE:LOAD <str>
<i>{More 1/4}</i>	Calls the recall menu (2 of 4).

&lt;str&gt; in "LOAD FILE" is a file name.

Recall menu (2 of 4)

<i>{RECALL REG-6}</i>	O : RECLREG6 N : *RCL 6/ REGISTER:RECall 6
<i>{RECALL REG-7}</i>	O : RECLREG7 N : *RCL 7/ REGISTER:RECall 7
<i>{RECALL REG-8}</i>	O : RECLREG8 N : *RCL 8/ REGISTER:RECall 8
<i>{RECALL REG-9}</i>	O : RECLREG9 N : *RCL 9/ REGISTER:RECall 9
<i>{RECALL REG-10}</i>	O : RECLREG10 N : *RCL 10/ REGISTER:RECall 10
<i>{RECALL POWER OFF}</i>	O : RECLPOFF N : *RCL POFF/ REGISTER:RECall POFF
<i>{LOAD FILE}</i>	O : LDFILE <str> N : FILE:LOAD <str>
<i>{More 2/4}</i>	Calls the recall menu (3 of 4).

&lt;str&gt; in "LOAD FILE" is a file name.

---

A.3 GPIB Command List for Panel Key/Soft Key

Recall menu (3 of 4)

- {RECALL REG-11}* O : RECLREG11  
N : \*RCL 11/ REGISTER:RECall 11
- {RECALL REG-12}* O : RECLREG12  
N : \*RCL 12/ REGISTER:RECall 12
- {RECALL REG-13}* O : RECLREG13  
N : \*RCL 13/ REGISTER:RECall 13
- {RECALL REG-14}* O : RECLREG14  
N : \*RCL 14/ REGISTER:RECall 14
- {RECALL REG-15}* O : RECLREG15  
N : \*RCL 15/ REGISTER:RECall 15
- {RECALL POWER OFF}* O : RECLPOFF  
N : \*RCL POFF/ REGISTER:RECall POFF
- {LOAD FILE}* O : LDFILE <str>  
N : FILE:LOAD <str>
- {More 3/4}* Calls the recall menu (4 of 4).

<str> in "LOAD FILE" is a file name.

Recall menu (4 of 4)

- {RECALL REG-16}* O : RECLREG16  
N : \*RCL 16/ REGISTER:RECall 16
- {RECALL REG-17}* O : RECLREG17  
N : \*RCL 17/ REGISTER:RECall 17
- {RECALL REG-18}* O : RECLREG18  
N : \*RCL 18/ REGISTER:RECall 18
- {RECALL REG-19}* O : RECLREG19  
N : \*RCL 19/ REGISTER:RECall 19
- {RECALL REG-20}* O : RECLREG20  
N : \*RCL 20/ REGISTER:RECall 20
- {RECALL POWER OFF}* O : RECLPOFF  
N : \*RCL POFF/ REGISTER:RECall POFF
- {LOAD FILE}* O : LDFILE <str>  
N : FILE:LOAD <str>
- {More 4/4}* Calls the recall menu (1 of 4).

<str> in "LOAD FILE" is a file name.

## (3) Copy menu

No GPIB commands are available for the following menus: the Plot scale menu, Plot data menu, Plot pen menu, Setup menu and Printer setting menu.

## (4) SYSTEM

System menu

<i>{SYSTEM DRIVE}</i>	There is no GPIB command to be applied.
<i>{SET CLOCK}</i>	Calls the real time clock menu. (See step (4-1).)
<i>{LIMIT MENU}</i>	Calls the limit line menu. (See step (4-2).)
<i>{FUNCTION}</i>	Calls the function menu. (See step (4-3).)
<i>{LCD CONTRAST[ ]}</i>	There is no GPIB command to be applied.
<i>{SERVICE MENU}</i>	Calls the service menu. (See step (4-6).)

## (4-1) Real time clock menu

<i>{YEAR}</i>	O : YEAR <int> N : SYSTem:DATE <year>, <month>, <day>
<i>{MONTH}</i>	O : MONTH <int> N : SYSTem:DATE <year>, <month>, <day>
<i>{DAY}</i>	O : DAY <int> N : SYSTem:DATE <year>, <month>, <day>
<i>{HOUR}</i>	O : HOUR <int> N : SYSTem:TIME <hour>, <minute>, <second>
<i>{MINUTE}</i>	O : MINUTE <int> N : SYSTem:TIME <hour>, <minute>, <second>
<i>{SECOND}</i>	O : SECOND <int> N : SYSTem:TIME <hour>, <minute>, <second>
<i>{Return}</i>	Returns to the system menu. (See step (4).)

A.3 GPIB Command List for Panel Key/Soft Key

(4-2) Limit line menu

(4-2-1) Limit menu

<i>{LIMIT LINE ON/OFF}</i>	O : LIMITLINE N : DISPlay[:WINDow[<chno>]]:LIMit[<pn>]:LINE <bool>
<i>{LIMIT TEST ON/OFF}</i>	O : LIMITTEST N : DISPlay[:WINDow[<chno>]]:LIMit[<pn>]:STATe <bool>
<i>{BEEP[    ]}</i>	Calls the beep menu.
<i>{LIMIT MODE MENU}</i>	Calls the limit mode menu. (See step (4-2-2).)
<i>{EDIT LIMIT LINE}</i>	Calls the edit limits menu (1 of 2). (See step (4-2-3).)
<i>{SELECT DATA 1st/2nd}</i>	O : LPAR<int> N : There is no GPIB command to be applied.
<i>{LIMIT LINE OFFSETS}</i>	Calls the offset limits menu. (See step (4-2-8).)
<i>{Return}</i>	Calls the system menu. (See step (4).)

(4-2-2) Limit mode menu

<i>{1ST DATA ON/OFF}</i>	O : LIMPAR<bool> N : DISPlay[:WINDow[<chno>]]:LIMit[<pn>]:PARAmeter[:STATe] <bool>
<i>{2ND DATA ON/OFF}</i>	O : LIMPAR<bool> N : DISPlay[:WINDow[<chno>]]:LIMit[<pn>]:PARAmeter[:STATe] <bool>
<i>{MAG DATA LIN/LOG}</i>	O : LIMSLIN/LIMSLOG     ← Smith display LIMPLIN/LIMPLOG     ← Polar display N : DISPlay[:WINDow[<chno>]]:LIMit[<pn>]:PARAmeter: :SmithLIMit {LINear LOGarithmic}   ← Smith display DISPlay[:WINDow[<chno>]]:LIMit[<pn>]:PARAmeter: :PolarLIMit {LINear LOGarithmic}   ← Polar display
<i>{Return}</i>	Calls the limit menu. (See step (4-2-1).)

## (4-2-3) Edit limits menu (1 of 2)

{SEGMENT}	O : LSEG N : There is no GPIB command to be applied.
{SELECT DATA 1ST/2ND}	O : LIMPAR<in> N : There is no GPIB command to be applied.
{EDIT SEGMENT}	Calls the edit segment menu. (See step (4-2-5).)
{DELETE}	O : There is no GPIB command to be applied. N : DISPlay[:WINDow[<chno>]]:LIMit[<pn>]:SEGment<n>:DELeTe
{ADD SEGMENT}	O : There is no GPIB command to be applied. N : There is no GPIB command to be applied.
{LINE TYPE}	Calls the limit type menu. (See step (4-2-6).)
{DONE}	O : There is no GPIB command to be applied. N : There is no GPIB command to be applied.
{More 1/2}	Calls the edit limits menu (2 of 2). (See step (4-2-4).)

## (4-2-4) Edit limits menu (2 of 2)

{LIMIT LINE ON/OFF}	O : LIMITLINE N : DISPlay[:WINDow[<chno>]]:LIMit[<pn>]:LINE <bool>
{LIMIT TEST ON/OFF}	O : LIMITTEST N : DISPlay[:WINDow[<chno>]]:LIMit[<pn>]::STATe] <bool>
{BEEP[ ]}	Calls the beep menu. (See step (4-2-9).)
{MAG DATA LIN/LOG}	O : LIMSLIN/LIMSLOG ← Smith display LIMPLIN/LIMPLOG ← Polar display N : DISPlay[:WINDow[<chno>]]:LIMit[<pn>]:PARAmeter:SmithLIMit {LINearLOGarithmic} ← Smith display DISPlay[:WINDow[<chno>]]:LIMit[<pn>]:PARAmeter:PolarLIMit {LINearLOGarithmic} ← Polar display
{LIMIT MODE MENU}	Calls the limit mode menu. (See step (4-2-2).)
{LIMIT LINE OFFSETS}	Calls the offset limits menu. (See step (4-2-8).)
{CLEAR LIST}	Calls the clear limit menu. (See step (4-2-6).)
{More 2/2}	Calls the edit limits menu (1 of 2). (See step (4-2-3).)

A.3 GPIB Command List for Panel Key/Soft Key

(4-2-5) Edit segment menu

<i>{STIMULUS VALUE}</i>	O : LIMS <real> N : DISPlay[:WINDow[<chno>]]:LIMit[<pn>]:SEGment<n>: :STIMulus <real>
<i>{MARKER TO STIMULUS}</i>	O : There is no GPIB command to be applied. N : There is no GPIB command to be applied.
<i>{UPPER LIMIT}</i>	O : LIMU<real> N : DISPlay[:WINDow[<chno>]]:LIMit[<pn>]:SEGment<n>: :UPPer <real>
<i>{LOWER LIMIT}</i>	O : LIML<real> N : DISPlay[:WINDow[<chno>]]:LIMit[<pn>]:SEGment<n>: :LOWer <real>
<i>{DELTA LIMIT}</i>	O : There is no GPIB command to be applied. N : There is no GPIB command to be applied.
<i>{MIDDLE VALUE}</i>	O : There is no GPIB command to be applied. N : There is no GPIB command to be applied.
<i>{MARKER TO MIDDLE}</i>	O : There is no GPIB command to be applied. N : There is no GPIB command to be applied.
<i>{Return}</i>	Calls the edit limits menu (1 of 2). (See step (4-2-3).)

(4-2-6) Clear limit menu

<i>{YES}</i>	O : LSEGCL N : DISPlay[:WINDow[<chno>]]:LIMit[<pn>]:CLEar
<i>{NO}</i>	O : There is no GPIB command to be applied. N : There is no GPIB command to be applied.



## (4-2-7) Limit type menu

<i>{SLOPING LINE}</i>	O : LIMITSLP N : DISPlay[:WINDow[<chno>]]:LIMit[<pn>]:SEGMENT<n>: :TYPE SLINe
<i>{FLAT LINE}</i>	O : LIMITFLT N : DISPlay[:WINDow[<chno>]]:LIMit[<pn>]:SEGMENT<n>: :TYPE FLINe
<i>{SINGLE POINT}</i>	O : LIMITSP N : DISPlay[:WINDow[<chno>]]:LIMit[<pn>]:SEGMENT<n>: :TYPE SPOint
<i>{LIMIT COLOR}</i>	O : LIMC<int> N : DISPlay[:WINDow[<chno>]]:LIMit[<pn>]:SEGMENT<n>: :COLor<int>
<i>{WAVE COLOR}</i>	O : LIMWC<int> N : DISPlay[:WINDow[<chno>]]:LIMit[<pn>]:SEGMENT<n>: :WCOLor<int>
<i>{Return}</i>	Calls the edit limits menu (1 of 2). (See step (4-2-3).)

## (4-2-8) Offset limits menu

<i>{STIMULUS OFFSET}</i>	O : LIMISTIO<real> N : DISPlay[:WINDow[<chno>]]:LIMit[<pn>]:OFFSet :STIMulus <real>
<i>{AMPLITUDE OFFSET}</i>	O : LIMIAMPO<real> N : DISPlay[:WINDow[<chno>]]:LIMit[<pn>]:OFFSet :AMPLitude <real>
<i>{MARKER TO AMP.OFS}</i>	O : There is no GPIB command to be applied. N : There is no GPIB command to be applied.
<i>{Return}</i>	Calls the limit menu. (See step (4-2-1).)

A.3 GPIB Command List for Panel Key/Soft Key

(4-2-9) Beep mode menu

- {OFF}*                    O : FAILBEEP OFF/PASSBEEP OFF  
                           N : DISPlay[:WINDow[<chno>]]:LIMit[<pn>]:BEEP OFF
- {FAIL}*                    O : FAILBEEP ON  
                           N : DISPlay[:WINDow[<chno>]]:LIMit[<pn>]:BEEP  
                                   :FOR FAIL
- {PASS}*                    O : PASSBEEP ON  
                           N : DISPlay[:WINDow[<chno>]]:LIMit[<pn>]:BEEP  
                                   :FOR PASS
- {BEEP TONE}*            O : BEEPTONE<int>  
                           N : DISPlay[:WINDow[<chno>]]:LIMit[<pn>]:BEEP  
                                   :TONE <int>
- {Return}*                    Calls the limit menu. (See step (4-2-1).)

Getting the result of the limit line judgment.

The followings are available.

For the PASS/FAIL information of all segments

- O : There is no GPIB command to be applied.  
 N : DISPlay[:WINDow[<chno>]]:LIMit[<pn>]:REPort?

For the PASS/FAIL information of test results

- O : LIMRES?  
 N : DISPlay[:WINDow[<chno>]]:LIMit[<pn>]:RESult?

(4-3) Function menu

- {CDMA IF FILTER}*            Calls the CDMA IF filter analysis menu. (See step (4-4).)
- {DIRECT ANALYSIS}*        Calls the direct analysis menu. (See step (4-5).)

(4-4) CDMA IF filter analysis menu

- {CDMA IF GATE[    ]}*        Calls the CDMA IF gate menu. (See step (4-4-1).)
- {CDMA FILTER ANALYSIS[    ]}*  
                                   Calls the CDMA filter analysis menu. (See step(4-4-3).)
- {CDMA PHASE LINEARITY ON/OFF}*  
                                   O : CDMAPLIN<bool>  
                                   N : CALCulate[<chno>]:CDMA:PLINearity:STATE <bool>
- {PHASE LINEARITY[    ]}*    Calls the phase linearity analysis menu. (See step (4-4-4).)

Getting the result of CDMA phase Linearity analysis.

The followings are available.

- O : PLINREP?  
 N : FETCh[<chno>]:PLINearity?

## (4-4-1) CDMA IF gate menu

<i>{CDMA GATE ON/OFF}</i>	O : CDMA<bool> N : CALCulate[<chno>]:CDMA:GATE:STATe <bool>
<i>{CDMA GATE START[ ]}</i>	O : CDMASSTAR<real> N : CALCulate[<chno>]:CDMA:GATE:START <real>
<i>{CDMA GATE STOP[ ]}</i>	O : CDMASSTOP<real> N : CALCulate[<chno>]:CDMA:GATE:STOP <real>
<i>{GATE SHAPE[ ]}</i>	Calls the CDMA IF filter gate shape menu. (See step (4-4-2).)

## (4-4-2) CDMA IF filter gate shape menu

<i>{MAXIMUM}</i>	O : CDMASMAXI N : CALCulate[<chno>]:CDMA:GATE:WINDow MAXimum
<i>{WIDE}</i>	O : CDMSWIDE N : CALCulate[<chno>]:CDMA:GATE:WINDow WIDE
<i>{NORMAL}</i>	O : CDMSNORM N : CALCulate[<chno>]:CDMA:GATE:WINDow NORMal
<i>{MINIMUM}</i>	O : CDMSMINI N : CALCulate[<chno>]:CDMA:GATE:WINDow MINimum
<i>{CDMA IF}</i>	O : CDMSCDMA N : CALCulate[<chno>]:CDMA:GATE:WINDow CDMA

## (4-4-3) CDMA filter analysis menu

<i>{CDMA FILTER ANALYSIS ON/OFF}</i>	O : CDMAFANA<bool> N : * <sup>1</sup> CALCulate[<chno>]:CDMA:FANalysis:STATe <bool>
<i>{WIDTH VALUE}</i>	O : CDMATXDB<real> N : CALCulate[<chno>]:CDMA:FANalysis:WIDTh <real>
<i>{ATTN FREQ1}</i>	O : CDMAATTN1<real> N : * <sup>2</sup> CALCulate[<chno>]:CDMA:FANalysis:ATTenuation1 <real>
<i>{ATTN FREQ2}</i>	O : CDMAATTN2<real> N : * <sup>2</sup> CALCulate[<chno>]:CDMA:FANalysis:ATTenuation2 <real>

\*1 Getting the result of the CDMA filter analysis.

FETCH[<chno>]:CDMA:FANalysis?

\*2 The abbreviations are as follows:

CALC[<chno>]:CDMA:FAN:ATT1<real>

CALC[<chno>]:CDMA:FAN:ATT2<real>

## A.3 GPIB Command List for Panel Key/Soft Key

## (4-4-4) Phase linearity analysis menu

*{PHASE LINEARITY ON/OFF}*

O : PLINE <bool>  
 N : CALCulate[<chno>]:PLINearity:STATe <bool>

*{PARTIAL ON/OFF}*

O : PLINPART<bool>  
 N : CALCulate[<chno>]:PLINearity:PARTial <bool>

Getting the result of the phase linearity analysis.

The followings are available.

O : PLINREP?  
 N : FETCh[<chno>]:PLINearity?

## (4-5) Direct analysis menu

*{FILTER ANALYSIS}* : Calls the filter analysis menu.*{RESONATOR ANALYSIS}* : Calls the resonator analysis menu.*{EQUIVALENT ANALYSIS}* : Calls the equivalent circuit analysis menu.

*{RIPPLE X VALUE}* O : There is no GPIB command to be applied.  
 N : CALCulate[<chno>]:WANalysis:RIPple:DX <real>

*{RIPPLE Y VALUE}* O : There is no GPIB command to be applied.  
 N : CALCulate[<chno>]:WANalysis:RIPple:DY <real>

## (4-5-1) Filter analysis menu

*{-3,XdB BND WIDTH(MAX)}* O : There is no GPIB command to be applied.  
 N : CALCulate[<chno>]:WANalysis:FILTer:MAXimum?

*{-3,XdB BND WIDTH(Fc)}* O : There is no GPIB command to be applied.  
 N : CALCulate[<chno>]:WANalysis:FILTer:CFrequency?

*{BAND WIDTH}* O : There is no GPIB command to be applied.  
 N : CALCulate[<chno>]:WANalysis:FILTer:BWIDth<real>

*{D VALUE}* O : There is no GPIB command to be applied.  
 N : CALCulate[<chno>]:WANalysis:FILTer:DIFFerence  
 <real>

*{F1 VALUE}* O : There is no GPIB command to be applied.  
 N : CALCulate[<chno>]:WANalysis:FILTer:RFRequency  
 <real>

*{F2 VALUE}* O : There is no GPIB command to be applied.  
 N : CALCulate[<chno>]:WANalysis:FILTer:SFRequency<real>

*{FC VALUE}* O : There is no GPIB command to be applied.  
 N : CALCulate[<chno>]:WANalysis:FILTer:NFRequency  
 <real>

## (4-5-2) Resonator analysis menu

<i>{RESONATOR (0 PHASE)}</i>	O : There is no GPIB command to be applied. N : CALCulate[<chno>]:WANalysis:RESonator:ZPHase?
<i>{RESONATOR (RIPPLE)}</i>	O : There is no GPIB command to be applied. N : CALCulate[<chno>]:WANalysis:RESonator:RIPPLE?
<i>{RESONATOR (AdB,BdB)}</i>	O : There is no GPIB command to be applied. N : CALCulate[<chno>]:WANalysis:RESonator:MMIN?
<i>{A dB VALUE}</i>	O : There is no GPIB command to be applied. N : CALCulate[<chno>]:WANalysis:RESonator:BELOW <real>
<i>{B dB VALUE}</i>	O : There is no GPIB command to be applied. N : CALCulate[<chno>]:WANalysis:RESonator:ABOVE <real>

## (4-5-3) Equivalent circuit analysis menu

<i>{EQUIVALENT 4-DEVICE}</i>	O : There is no GPIB command to be applied. N : CALCulate[<chno>]:WANalysis:EQUIvalent:DEVice4
<i>{EQUIVALENT 6-DEVICE}</i>	O : There is no GPIB command to be applied. N : CALCulate[<chno>]:WANalysis:EQUIvalent:DEVice6

## (4-6) Service menu

<i>{INTERNAL TEST}</i>	There is no GPIB command to be applied.
<i>{SERVICE MODE}</i>	There is no GPIB command to be applied.
<i>{SET KEYBOARD 101/106}</i>	There is no GPIB command to be applied.
<i>{FIRMWARE REVISION}</i>	O : Equivalent to IDNT? N : Equivalent to *IDN?

## (5) PRESET

<b>[PRESET]</b>	O : IP N : SYSTem:PRESet
-----------------	-----------------------------

**A.3.5 GPIB Block**

## (1) PROGRAM

<b>[PROGRAM]</b>	There is no GPIB command to be applied to the following menus which are called by this key. <ul style="list-style-type: none"> <li>• Controller menu</li> <li>• Load menu</li> <li>• Drive menu</li> </ul>
------------------	--

---

A.3 GPIB Command List for Panel Key/Soft Key

(2) REMOTE/LCL

GPIB menu

{SYSTEM CONTROLLER} There is no GPIB command to be applied.

{TALKER LISTENER} There is no GPIB command to be applied.

{SET ADDRESS} Calls the address menu. (See step (2-1).)

(2-1) Address menu

{ADDRESS R3754} There is no GPIB command to be applied.

{ADDRESS PLOTTER} O : ADDR PLOT <int>  
N : HCOpy:DEvice:ADDRess <int>

{ADDRESS PRINTER} There is no GPIB command to be applied.

{Return} Returns to the GPIB menu. (See step (2).)

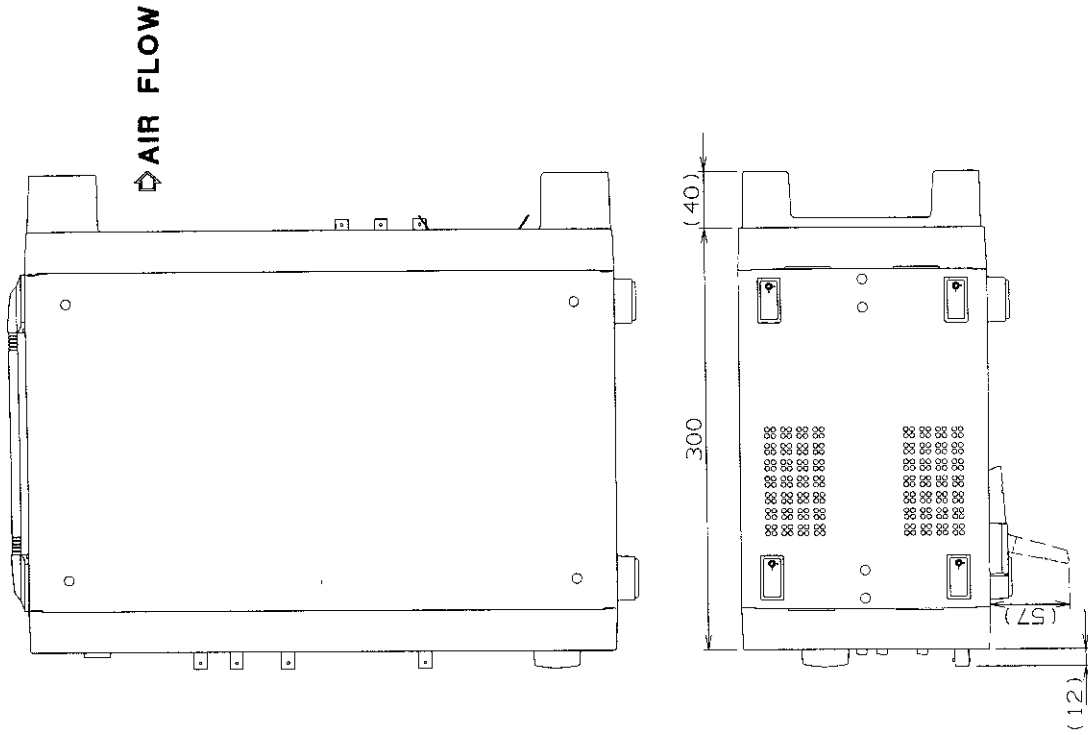
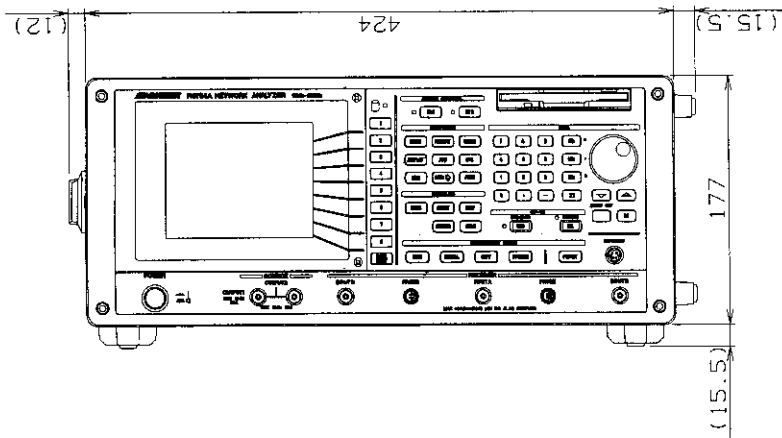

Unit : mm

**CAUTION**

This drawing shows external dimensions this instrument.  
The difference in products and options used can cause a change in the appearance of the instrument.

**DIMENSIONAL OUTLINE DRAWING**





## ALPHABETICAL INDEX

<b>[Panel keys]</b>		<b>[B]</b>	
0 to 9 .....	3-3	BACK LIGHT .....	2-2
- .....	3-3	backup memory .....	A-3
. .....	3-3	BASIC OPERATING GUIDELINES .....	3-1
AVG .....	3-5	BEEP .....	4-65
BS .....	3-3	Beep mode menu .....	A-13
CAL .....	3-5	Bitmap File Setup .....	4-97
CENTER .....	3-4	Brightness .....	7-7
COPY .....	3-6		
DISPLAY .....	3-5	<b>[C]</b>	
ENTRY OFF .....	3-3	Cal selection menu .....	5-31
FORMAT .....	3-5	Calibration .....	4-25
FUNCTION .....	3-5	calibration data .....	5-24
LCL .....	3-7	Calibration Data Clear .....	4-34, 5-29
MEAS .....	3-5	Calibration menu .....	4-33, 5-28, A-7
MENU .....	3-4	Calibration Method .....	4-27
MKR .....	3-5	Calibration standard .....	A-3
MKR→ .....	3-5	Calibration standard definition menu .....	A-7
PRESET .....	3-6	CDMA IF filter analysis .....	A-3
RECALL .....	3-6	Ceramic Oscillator Resonance and Antiresonance Point Measurements .....	3-68
RUN .....	3-7	Channel .....	2-5
SAVE .....	3-6	Character editing menu .....	4-84, A-10
SCALE .....	3-5	Character menu .....	4-86
SPAN .....	3-4	CH1 .....	3-2
START .....	3-4	CH2 .....	3-2
STOP .....	3-4	Cleaning .....	1-11
SYSTEM .....	3-6	Clear limit menu .....	4-69, A-13
		Clear register menu .....	4-86, A-10
<b>[Number]</b>		Clearing Saved Register .....	4-86
1 Port Full Cal .....	5-22, 5-30	Color men .....	A-6
1 port full calibration menu .....	A-7	Colors Settings .....	4-17
10-pin cable .....	5-23	Communication with Peripheral Devices .....	4-98
		Completion Operating Condition Messages .....	8-9
<b>[A]</b>		Confirmation of Product and Attachment .....	Preface-4
AC POWER connector .....	2-7	Connector Internal Pin Assigned .....	4-100, 4-109, 4-118
ACT MKR menu .....	4-41, A-8	Contrast .....	7-7
Active area .....	2-5	Controller Menu .....	4-78
ACTIVE CHANNEL Block .....	4-2, A-17	Controller menu .....	A-14
ACTIVE CHANNEL block .....	2-2, 3-2	Conversion marker menu .....	4-43, A-8
Active marker .....	2-5	Conversion Mode .....	5-1
Active marker menu .....	4-36, A-8	Copy menu .....	4-91, A-12
Address menu .....	4-79, A-14	correction .....	5-27
Attenuator .....	4-23	Crosstalk (between the input and output) .....	6-15
Attenuator selection menu .....	4-24, A-6		
Auto scale .....	7-7		
Automatic offset calibration .....	7-3		
Average menu .....	4-19, A-6		
Averaging/Smoothing and Resolution Bandwidth .....	4-19		

Alphabetical Index

Crosstalk (between the inputs) ----  
 Only for model with Option 10/Option 11 6-16  
 Crystal Resonator Impedance  
 Measurement ..... 3-83  
 Crystal Resonator Measurement ..... 3-42

**[D]**

Data Flow ..... 1-3  
 Data knob ..... 3-3  
 Default drive menu ..... 4-63, A-13  
 Delay characteristics ..... 7-5  
 Delta Marker Measurement ..... 3-49  
 Delta mode menu ..... 4-41, A-8  
 Delta Section Marker Measurement ..... 3-52  
 Delta-Marker Function ..... 4-40  
 Diagram of Receiver ..... 1-2  
 DIRECT ANALYSIS FUNCTIONS ..... 4-75  
 Direct analysis menu ..... 4-75, A-15  
 Disk format menu ..... 4-63, A-13  
 Display Data Format ..... 4-12  
 Display format ..... 7-7  
 Display menu ..... 4-14, A-6  
 Display mode ..... 7-7  
 Display of marker ..... 3-11  
 Displaying Marker Read out Value ..... 4-39  
 DLD detail setting menu ..... 5-13  
 DLD FORMAT ..... 5-21  
 DLD format menu ..... 5-13  
 DLD FREQUENCY ..... 5-20  
 DLD frequency menu ..... 5-12  
 DLD Function Key ..... 5-9  
 DLD LEVEL ..... 5-19  
 DLD level menu ..... 5-10  
 DLD menu ..... 5-9  
 DLD SWEEP TYPE ..... 5-20  
 DLD sweep type menu ..... 5-12  
 DRIVE LEVEL DEPENDENCY ..... 5-19  
 Drive Level Measurement (DLD)  
 Functions ..... 5-5  
 Drive menu ..... 4-79, A-14  
 Dual Channel Simultaneous Display  
 Measurement ..... 3-29  
 Dynamic range ..... 4-23

**[E]**

Edit limit menu ..... 4-67  
 Edit limits menu ..... A-13  
 Edit segment menu ..... 4-68, A-13  
 EDIT USER-LEVEL ..... 5-20  
 Editing Segment of Program Sweep ..... 4-58  
 Editing Segment of User Frequency

Sweep ..... 4-57  
 ENTRY Block ..... 4-3  
 ENTRY block ..... 2-3, 3-3, 4-3  
 Equivalent analysis menu ..... A-15  
 Equivalent circuit analysis menu ..... 4-77  
 Error calibration function ..... 7-6  
 ERROR MESSAGES ..... 8-1  
 Error Messages ..... 5-16, 5-31  
 Example of Basic Key Operation ..... 3-9  
 Executing Recall ..... 4-88  
 Executing Save Register ..... 4-81  
 Executing Store File ..... 4-83  
 EXT TRIG IN ..... 2-7  
 Extending Measurement Reference  
 Plane ..... 4-32  
 External reference frequency input ..... 7-6  
 External reference frequency input  
 connector ..... 2-7  
 External trigger signal input ..... 7-6

**[F]**

Fail section ..... 4-65  
 FET Probe ..... 1-8  
 File data menu ..... 4-83, A-10  
 File List Display ..... 4-81  
 Filter Analysis menu ..... 4-75  
 Filter analysis menu ..... 4-49, A-9, A-15  
 Filter Measurement ..... 3-14  
 FINE SETUP ..... 5-21  
 FIXED MKR setting menu ..... 4-42, A-8  
 Floppy disk drive ..... 2-2  
 FORMAT ..... A-5  
 Format ..... 2-5  
 Format menu ..... 4-12, A-5  
 four-element equivalent circuit  
 parameters ..... 4-77  
 Frequency Accuracy and Range ..... 6-3  
 Frequency characteristics ..... 7-1  
 Frequency setting of signal source ..... 3-10  
 Front Panel ..... 2-1  
 Front panel key ..... 3-2  
 Full calibration selection menu ..... A-7  
 FUNCTION DESCRIPTIONS ..... 4-1  
 Function menu ..... 4-64

**[G]**

Gate Function ..... 5-3  
 Gate function ..... 4-70  
 Gate menu ..... 5-4  
 Gate shape menu ..... 5-4

- GO/NG Measurement Using Limit Line  
Function ..... 3-88  
 GPIB Block ..... 2-3, 3-7, 4-78, A-57  
 GPIB Command List for  
 Panel Key/Soft Key ..... A-16  
 GPIB Commands ..... 5-19, 5-31  
 GPIB connector ..... 2-7  
 GPIB data output and Remote control ... 7-6  
 GPIB Menu ..... 4-79, A-14  
 Group Delay Measurement ..... 3-19
- [H]**
- Hard Copy ..... 4-91  
 Hardware Trouble ..... 8-1  
 High stability reference frequency  
 output connector ..... 2-7
- [I]**
- Impedance cal menu ..... 5-29, 5-31  
 Indicator ..... 7-7  
 Initial Circuit ..... 4-101, 4-110  
 Initial Setting ..... A-1  
 Initial Settings for DLD Functions ..... 5-18  
 Input attenuator ..... A-3  
 Input characteristics ..... 7-3  
 Input gain menu ..... 4-24, A-6  
 Input Level Accuracy  
 (Absolute value measurement) ..... 6-10  
 Input Level Accuracy  
 (Relative value measurement) ----- Only  
 for model with Option 10/Option 11 ..... 6-12  
 INPUT port ..... 2-5  
 Input Preamplifier ..... 4-23, A-3  
 Input Return Loss ..... 6-8  
 Input Signal Level Overload Cautions ... 1-10  
 INSTRUMENT STATE Block ..... 4-62, A-41  
 INSTRUMENT STATE block ..... 2-3, 3-6  
 Instruments state function ..... 7-9  
 Interlocking between Channels ..... 4-8  
 Interpolating Calibration Data ..... 4-31  
 Interpolation Between Measurement  
 Points ..... 4-39
- [K]**
- Keyboard ..... 7-6  
 KEYBOARD INPUT connector ..... 2-2
- [L]**
- Label input ..... 4-16  
 Label menu ..... 4-16, A-6  
 Label window ..... 2-5
- LCD display ..... 2-2  
 Limit Function ..... 4-65  
 Limit Menu ..... 4-65, A-13  
 Limit mode menu ..... 4-66, A-13  
 Limit type menu ..... 4-69, A-13  
 Linear Magnitude and  
 Phase Measurements ..... 3-27  
 load cal ..... 5-25  
 load capacitance ..... 5-27  
 Load file menu ..... 4-90, A-11  
 Load menu ..... 2-5, 4-79, A-14  
 Logarithmic Magnitude and  
 Group Delay Measurements ..... 3-25  
 Logarithmic Magnitude and  
 Phase Measurements ..... 3-23
- [M]**
- Magnitude analysis function ..... 4-71  
 Magnitude characteristics ..... 7-4  
 Maker search menu ..... 4-45  
 Marker Analysis Function ..... 4-45  
 Marker Analysis Measurement ..... 3-57  
 Marker Coupling and Interpolation  
 Measurements ..... 3-60  
 Marker Coupling between Channels ..... 4-37  
 Marker Function ..... 4-35, 7-8  
 Marker list ..... 2-5  
 Marker menu ..... A-8  
 Marker Menu during Impedance  
 Measurement ..... 4-43  
 Marker mode menu ..... 4-43, A-8  
 Marker search menu ..... A-9  
 Maximum Applicable Power to Crystal .. 5-11  
 Maximum input power ..... 4-23  
 MEAS ..... A-5  
 Measured Data Plotter Output ..... 3-72  
 Measurement channel ..... 7-1  
 Measurement condition display ..... 7-7  
 Measurement format ..... 7-1  
 Measurement function ..... 7-1  
 Measurement menu ..... 4-10, A-5  
 Measurement Method Example ..... 3-13  
 Measurement parameter ..... 7-1  
 MENU ..... A-4  
 Minimum Applicable Power to Crystal ... 5-11  
 Multi-marker Measurement ..... 3-47
- [N]**
- Name editing menu ..... 4-84, A-10  
 Narrow-band and Wide-band  
 Measurements ..... 3-21

Alphabetical Index

Noise Floor ..... 6-13  
 Noise level ..... 4-23  
 Non-operating conditions ..... 7-9  
 Normalizing ..... 4-25  
 Notes on the Use of Parallel I/O Ports ... 1-9  
 Notes on the Use of Serial I/O Ports ..... 1-9  
 Notice of Hardware Information ..... 8-2  
 Numeric keys ..... 3-3

**[O]**

Offset limit menu ..... 4-70, 4-71  
 Offset limits menu ..... A-13  
 One Port Full Calibration ..... 4-26  
 open cal ..... 5-24  
 Operating conditions ..... 7-9  
 Operating Environment ..... 1-4  
 Operating Error ..... 8-3  
 OPT Isolation Parallel I/O Port (Option03) 4-116  
 Option 70 ..... 5-1  
 Option 71 ..... 5-5  
 Option 72 ..... 5-22, 5-30  
 Output format ..... 7-2  
 Output Level Accuracy and Flatness ..... 6-4  
 Output Level Linearity ..... 6-6  
 Output power characteristics ..... 7-1  
 Overloading an Input Part ..... 8-2  
 Overview ..... 1-2

**[P]**

PARALLEL I/O connector ..... 2-7  
 Parallel I/O output ..... 7-6  
 Parallel I/O Port (Option01) ..... 4-98  
 Parallel I/O Port (Option02) ..... 4-107  
 Parameter conversion menu ..... A-5  
 Parameter conversion menu ..... 4-11, A-5  
 Part search menu ..... 4-55, A-9  
 PCMCIA ..... 2-7  
 PERFORMANCE TEST ..... 6-1  
 Phase analysis function ..... 4-71  
 Phase characteristics ..... 7-5  
 Phase Measurement ..... 3-17  
 Plot data menu ..... 4-92, A-12  
 Plot pen menu ..... A-12  
 Plot scale menu ..... 4-91, A-12  
 Plotter pen menu ..... 4-93, A-12  
 Plotter Setup ..... 4-93  
 Polar marker menu ..... 4-44, A-8  
 Port extension menu ..... 4-33, A-7  
 Position of Reference line ..... 7-7  
 Power Cable ..... 1-7  
 Power consumption ..... 7-9

Power Fuse ..... 1-6  
 Power menu ..... 4-7, A-4  
 Power supply ..... 7-9  
 Power Supply Specifications ..... 1-6  
 POWER switch ..... 2-2  
 Power/CW ..... 2-5  
 Preamplifier ..... 4-23  
 Preparing for a Performance Test ..... 6-1  
 Presetting ..... 3-9  
 Printer menu ..... 4-96,

A-12

Printer output connector ..... 2-7  
 Printer port ..... 7-6  
 Printer Setup ..... 4-96  
 Probe power ..... 7-6  
 Probe power cable ..... 5-23  
 PROBE POWER connector ..... 2-2  
 Product Description ..... 1-1  
 Program Sweep Measurement ..... 3-63  
 Program sweep segment editing  
 men ..... 4-58, A-4  
 Program sweep segment editing menu . A-4  
 Programming function ..... 7-9  
 Purge file menu ..... A-10  
 Purges files menu ..... 4-87  
 Purging Stored File ..... 4-87

**[R]**

Real time clock ..... 2-5  
 Real time clock menu ..... A-13  
 Real-time clock menu ..... 4-64  
 Rear Panel ..... 2-6  
 recall (read) ..... 5-28  
 Recall menu ..... 4-88, A-11  
 Receiver characteristics ..... 7-3  
 RECEIVER SECTION INPUT connector 2-2  
 Reference value ..... A-3  
 Reflection Characteristic Measurement 3-32  
 Required Measurement Instruments  
 for Performance Test ..... 6-1  
 Resolution ..... 7-7  
 Resonance analysis menu ..... 4-76  
 Resonant analysis menu ..... A-15  
 Response ..... A-1  
 RESPONSE Block ..... 4-9, A-22  
 RESPONSE block ..... 2-3, 3-5  
 RGB menu ..... A-6  
 Ripple menu ..... 4-48, A-9  
 RLA method ..... 5-5  
 RS-232 Interface ..... 4-123  
 R17041 ..... 5-22

**[S]**

save (store) ..... 5-28  
 Save menu ..... 4-80, A-10  
 Save register menu ..... 4-81, A-10  
 Save/Recall ..... 4-80  
 Saving to Floppy Disks ..... 3-78  
 Scale menu ..... 4-13, A-5  
 Scale reference ..... 2-5  
 Scale/DIV ..... 2-5  
 Screen Display ..... 2-4  
 Screen Displaying DLD Analysis ..... 5-7  
 Screen Displaying DLD Analysis List ..... 5-8  
 Screen Showing the Execution of  
 Load Cal ..... 5-25  
 Screen Showing the Execution of  
 Open Cal ..... 5-24  
 Screen Showing the Execution of  
 Short Cal ..... 5-25  
 Search menu ..... 4-46, A-9  
 Search reference menu ..... A-9  
 Selecting Input Attenuator ..... 4-23  
 Selecting Plot Data ..... 4-92  
 Selection of Save Type ..... 4-80  
 SERIAL I/O ..... 2-7  
 Serial port ..... 7-6  
 Service menu ..... 5-22, 5-30  
 Setting DIP Switches ..... 4-94  
 Setting Display Coordinate Scale ..... 4-13  
 Setting File Name ..... 4-86  
 Setting Input and Parameter Conversion ..... 4-10  
 Setting Marker ..... 4-36  
 Setting Plot Scale ..... 4-91  
 Setting Register Name ..... 4-84  
 Setting Signal Source ..... 4-6  
 Setting Sweep Type ..... 4-56  
 Setup ..... 3-9  
 Setup menu ..... 4-93, 4-96, A-12  
 short cal ..... 5-25  
 Signal output for an external display ..... 7-6  
 Signal source menu ..... 4-6, A-4  
 SIGNAL SOURCE OUTPUT connector . . . 2-2  
 Signal Standard ..... 4-100, 4-109, 4-118  
 six-element equivalent circuit parameters ..... 4-77  
 Slot ..... 2-7  
 Smith marker menu ..... 4-44, A-8  
 Soft key ..... 3-8  
 Soft key menu ..... 2-3, 2-5  
 Soft Key Menu List ..... A-4  
 Soft keys ..... 2-3  
 Source characteristics ..... 7-1  
 SPECIFICATIONS ..... 7-1

Specifying Pen ..... 4-93  
 Spectral purity ..... 7-2  
 Spectrum Purity (Phase Noise) ..... 6-7  
 Split-Screen Display and Display  
 Selection Information ..... 4-14  
 Standard attachment ..... Preface-4  
 Start/Center ..... 2-5  
 statistical analysis function ..... 4-55  
 Status area ..... 2-5  
 Step keys ..... 3-3  
 Stimulus ..... A-1  
 STIMULUS Block ..... 4-5, A-17  
 STIMULUS block ..... 2-3, 3-4  
 Stop/Span ..... 2-5  
 Storage ..... 1-11  
 Store file menu ..... 4-83, A-10  
 Sweep ..... 4-56  
 Sweep characteristics ..... 7-2  
 Sweep type menu ..... 4-56, A-4  
 System drive menu ..... 4-63, A-13  
 System Menu ..... 4-63, A-13

**[T]**

Target menu ..... 4-47, A-9  
 Three-terminal Resonator  
 Measurement Function ..... 5-22  
 three-terminal resonator measurement  
 function ..... 5-30  
 Three-terminator Resonator ..... 5-27  
 Time Domain Function ..... 5-1  
 Time domain transformation menu ..... 5-2  
 Timing Chart of WRITE STROBE  
 ..... 4-98, 4-107, 4-116  
 Trace display area ..... 2-5  
 TRACE Operation ..... 4-15  
 Trace operation men ..... 4-15, A-6  
 Trans Full Cal ..... 5-22, 5-30  
 Transmission Full Calibration ..... 4-27  
 Transportation ..... 1-11  
 Trigger menu ..... 4-7, A-4

**[U]**

Unit keys ..... 3-3  
 User frequency sweep segment editing  
 menu ..... 4-57, A-4  
 User level edit menu ..... 5-15  
 Using the Save/Recall Register ..... 3-76

**[V]**

VIDEO SIGNAL output ..... 2-7

---

Alphabetical Index

**[W]**

Wait for Sweep .....	5-24, 5-29
Warning of Internal Set, Change, etc. ....	8-7
Warnings .....	5-17
Window menu .....	5-3
Window processing .....	5-3

## **IMPORTANT INFORMATION FOR ADVANTEST SOFTWARE**

PLEASE READ CAREFULLY: This is an important notice for the software defined herein. Computer programs including any additions, modifications and updates thereof, operation manuals, and related materials provided by Advantest (hereafter referred to as "SOFTWARE"), included in or used with hardware produced by Advantest (hereafter referred to as "PRODUCTS").

### **SOFTWARE License**

All rights in and to the SOFTWARE (including, but not limited to, copyright) shall be and remain vested in Advantest. Advantest hereby grants you a license to use the SOFTWARE only on or with Advantest PRODUCTS.

### **Restrictions**

- (1) You may not use the SOFTWARE for any purpose other than for the use of the PRODUCTS.
- (2) You may not copy, modify, or change, all or any part of, the SOFTWARE without permission from Advantest.
- (3) You may not reverse engineer, de-compile, or disassemble, all or any part of, the SOFTWARE.

### **Liability**

Advantest shall have no liability (1) for any PRODUCT failures, which may arise out of any misuse (misuse is deemed to be use of the SOFTWARE for purposes other than its intended use) of the SOFTWARE. (2) For any dispute between you and any third party for any reason whatsoever including, but not limited to, infringement of intellectual property rights.

## LIMITED WARRANTY

1. Unless otherwise specifically agreed by Seller and Purchaser in writing, Advantest will warrant to the Purchaser that during the Warranty Period this Product (other than consumables included in the Product) will be free from defects in material and workmanship and shall conform to the specifications set forth in this Operation Manual.
2. The warranty period for the Product (the "Warranty Period") will be a period of one year commencing on the delivery date of the Product.
3. If the Product is found to be defective during the Warranty Period, Advantest will, at its option and in its sole and absolute discretion, either (a) repair the defective Product or part or component thereof or (b) replace the defective Product or part or component thereof, in either case at Advantest's sole cost and expense.
4. This limited warranty will not apply to defects or damage to the Product or any part or component thereof resulting from any of the following:
  - (a) any modifications, maintenance or repairs other than modifications, maintenance or repairs (i) performed by Advantest or (ii) specifically recommended or authorized by Advantest and performed in accordance with Advantest's instructions;
  - (b) any improper or inadequate handling, carriage or storage of the Product by the Purchaser or any third party (other than Advantest or its agents);
  - (c) use of the Product under operating conditions or environments different than those specified in the Operation Manual or recommended by Advantest, including, without limitation, (i) instances where the Product has been subjected to physical stress or electrical voltage exceeding the permissible range and (ii) instances where the corrosion of electrical circuits or other deterioration was accelerated by exposure to corrosive gases or dusty environments;
  - (d) use of the Product in connection with software, interfaces, products or parts other than software, interfaces, products or parts supplied or recommended by Advantest;
  - (e) incorporation in the Product of any parts or components (i) provided by Purchaser or (ii) provided by a third party at the request or direction of Purchaser or due to specifications or designs supplied by Purchaser (including, without limitation, any degradation in performance of such parts or components);
  - (f) Advantest's incorporation or use of any specifications or designs supplied by Purchaser;
  - (g) the occurrence of an event of force majeure, including, without limitation, fire, explosion, geological change, storm, flood, earthquake, tidal wave, lightning or act of war; or
  - (h) any negligent act or omission of the Purchaser or any third party other than Advantest.
5. **EXCEPT TO THE EXTENT EXPRESSLY PROVIDED HEREIN, ADVANTEST HEREBY EXPRESSLY DISCLAIMS, AND THE PURCHASER HEREBY WAIVES, ALL WARRANTIES, WHETHER EXPRESS OR IMPLIED, STATUTORY OR OTHERWISE, INCLUDING, WITHOUT LIMITATION, (A) ANY WARRANTY OF MERCHANTABILITY OR FITNESS FOR A PARTICULAR PURPOSE AND (B) ANY WARRANTY OR REPRESENTATION AS TO THE VALIDITY, SCOPE, EFFECTIVENESS OR USEFULNESS OF ANY TECHNOLOGY OR ANY INVENTION.**
6. **THE REMEDY SET FORTH HEREIN SHALL BE THE SOLE AND EXCLUSIVE REMEDY OF THE PURCHASER FOR BREACH OF WARRANTY WITH RESPECT TO THE PRODUCT.**
7. **ADVANTEST WILL NOT HAVE ANY LIABILITY TO THE PURCHASER FOR ANY INDIRECT, INCIDENTAL, SPECIAL, CONSEQUENTIAL OR PUNITIVE DAMAGES, INCLUDING, WITHOUT LIMITATION, LOSS OF ANTICIPATED PROFITS OR REVENUES, IN ANY AND ALL CIRCUMSTANCES, EVEN IF ADVANTEST HAS BEEN ADVISED OF THE POSSIBILITY OF SUCH DAMAGES AND WHETHER ARISING OUT OF BREACH OF CONTRACT, WARRANTY, TORT (INCLUDING, WITHOUT LIMITATION, NEGLIGENCE), STRICT LIABILITY, INDEMNITY, CONTRIBUTION OR OTHERWISE. TORT (INCLUDING, WITHOUT LIMITATION, NEGLIGENCE), STRICT LIABILITY, INDEMNITY, CONTRIBUTION OR OTHERWISE.**
8. **OTHER THAN THE REMEDY FOR THE BREACH OF WARRANTY SET FORTH HEREIN, ADVANTEST SHALL NOT BE LIABLE FOR, AND HEREBY DISCLAIMS TO THE FULLEST EXTENT PERMITTED BY LAW ANY LIABILITY FOR, DAMAGES FOR PRODUCT FAILURE OR DEFECT, WHETHER ARISING OUT OF BREACH OF CONTRACT, TORT (INCLUDING, WITHOUT LIMITATION, NEGLIGENCE), STRICT LIABILITY, INDEMNITY, CONTRIBUTION OR OTHERWISE.**



## **CUSTOMER SERVICE DESCRIPTION**

In order to maintain safe and trouble-free operation of the Product and to prevent the incurrence of unnecessary costs and expenses, Advantest recommends a regular preventive maintenance program under its maintenance agreement.

Advantest's maintenance agreement provides the Purchaser on-site and off-site maintenance, parts, maintenance machinery, regular inspections, and telephone support and will last a maximum of ten years from the date the delivery of the Product. For specific details of the services provided under the maintenance agreement, please contact the nearest Advantest office listed at the end of this Operation Manual or Advantest's sales representatives.

Some of the components and parts of this Product have a limited operating life (such as, electrical and mechanical parts, fan motors, unit power supply, etc.). Accordingly, these components and parts will have to be replaced on a periodic basis. If the operating life of a component or part has expired and such component or part has not been replaced, there is a possibility that the Product will not perform properly. Additionally, if the operating life of a component or part has expired and continued use of such component or part damages the Product, the Product may not be repairable. Please contact the nearest Advantest office listed at the end of this Operation Manual or Advantest's sales representatives to determine the operating life of a specific component or part, as the operating life may vary depending on various factors such as operating condition and usage environment.

## SALES & SUPPORT OFFICES

Advantest Korea Co., Ltd.

22BF, Kyobo KangNam Tower,  
1303-22, Seocho-Dong, Seocho-Ku, Seoul #137-070, Korea  
Phone: +82-2-532-7071  
Fax: +82-2-532-7132

Advantest (Suzhou) Co., Ltd.

Shanghai Branch Office:  
Bldg. 6D, NO.1188 Gumei Road, Shanghai, China 201102 P.R.C.  
Phone: +86-21-6485-2725  
Fax: +86-21-6485-2726

Shanghai Branch Office:  
406/F, Ying Building, Quantum Plaza, No. 23 Zhi Chun Road,  
Hai Dian District, Beijing,  
China 100083  
Phone: +86-10-8235-3377  
Fax: +86-10-8235-6717

Advantest (Singapore) Pte. Ltd.

438A Alexandra Road, #08-03/06  
Alexandra Technopark Singapore 119967  
Phone: +65-6274-3100  
Fax: +65-6274-4055

Advantest America, Inc.

3201 Scott Boulevard, Suite, Santa Clara, CA 95054, U.S.A  
Phone: +1-408-988-7700  
Fax: +1-408-987-0691

ROHDE & SCHWARZ Europe GmbH

Mühldorfstraße 15 D-81671 München, Germany  
(P.O.B. 80 14 60 D-81614 München, Germany)  
Phone: +49-89-4129-13711  
Fax: +49-89-4129-13723

**ADVANTEST**<sup>®</sup>

<http://www.advantest.co.jp>

---

ADVANTEST CORPORATION  
Shin-Marunouchi Center Building, 1-6-2 Marunouchi, Chiyoda-ku, Tokyo 100-0005, Japan  
Phone: +81-3-3214-7500