

Photovoltaic / Solar Array Simulation Solution

N8937APV, N8957APV Photovoltaic Array Simulators
 DG8901A Solar Array Simulator Control Software
 DG9000A Advanced / Multi-Input Photovoltaic Inverter Test Software



New DG9000A software enables testing of PV inverters from 1 to 12 inputs!

Whether your inverter has one or twelve inputs/MPPTs, Keysight's Photovoltaic / Solar Inverter Test Solution can help you go beyond the test standards to maximize performance and bankability.



Figure 1 - DG8900A test tab



Figure 2 - N8900APV PV simulators

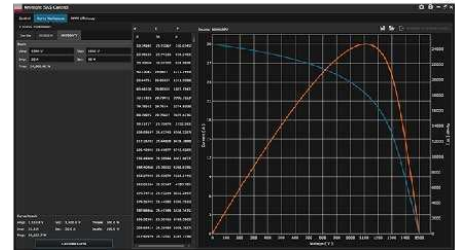

Figure 3 - DG8900A curve workspace

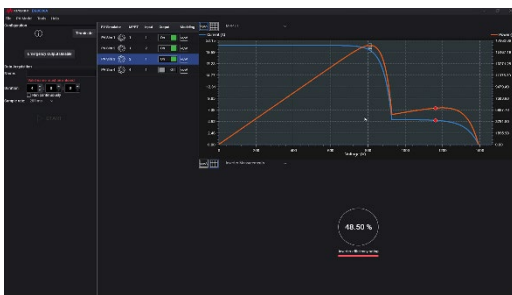

Figure 4 - DG9000A MPPT efficiency

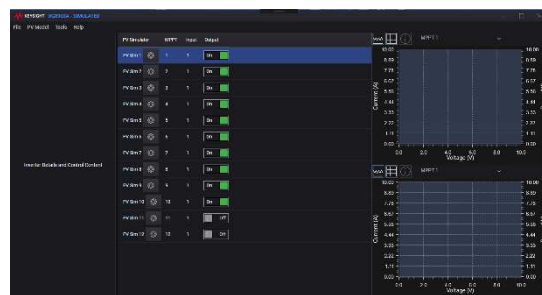

Figure 5 - DG9000A multiple control



Maximize the performance of your inverter



Figure 6 - N8957APV Photovoltaic Array Simulator

If you are designing or manufacturing photovoltaic solar inverters from one to twelve inputs and up to 1500 V per input, Keysight's Photovoltaic / Solar Inverter Test Solution can help you develop, verify, and maximize the performance and bankability of your inverter. The solution enables you to optimize maximum power point tracking (MPPT) algorithms and circuits. With the DG8900 software you can quickly and easily test individual inputs to the European EN50530 (April 2010) standard to easily compare your results to your competitors.

With the new DG9000A software you can simultaneously control from one to twelve PV simulators enabling you to go beyond the test standards, optimizing your multi-input inverters to beat the competition. The explosive growth in the solar power generation industry has intensified the need for solar inverter test and measurement solutions.

To keep solar power at grid parity with competing methods of power generation, performance and power conversion efficiency are increasingly important. Small increments in power production have a dramatic effect on the profitability of solar power generation.

You need to ensure your solar inverters are capable of converting the maximum power that is available from the solar array. Developing and verifying the performance of inverter MPPT algorithms and circuits is challenging. MPPT algorithms are complex, and under-the-sun testing with a comprehensive set of temperature and irradiance conditions is extremely difficult, expensive, and time consuming, if even possible at all.

As inverters increase in power, the size of the test array would become unmanageable. As they increase in number of inputs on a single inverter, the complexity of test changes exponentially. The only practical test method is to use a laboratory test solution that can simulate from one to many real-world solar array strings.

Want a turn-key system delivered?



Contact Keysight
www.keysight.com/find/contactus

Quickly create, visualize, and execute photovoltaic/solar I-V curves

Keysight's PV simulation solution consists of the N8900APV Series PV simulator hardware and two software packages to choose from: the DG8900 SAS control/curve generation software and the DG9000 advance/multi-input PV inverter test software.

The PV simulators are autoranging, programmable DC power sources that simulate the output characteristics of a photovoltaic array under different environmental conditions (temperature, irradiance, age, cell technology, etc.) enabling you to quickly and comprehensively test inverter MPPT algorithms and inverter efficiency. The DG8900 SAS Control software allows the user to control one N8900APV (or one primary/secondary set) output as well as easily create, visualize, and download solar / photovoltaic I-V curves to the instrument using the Curve Workspace. Once a curve has been downloaded to an N8900APV, the user can enable the output and watch as their PV inverter searches for the maximum power point, gaining insight into their MPPT algorithm.

The new DG9000 software has the same features as the DG8900, but allows control from one to twelve N8900APV units, or primary/secondary sets.

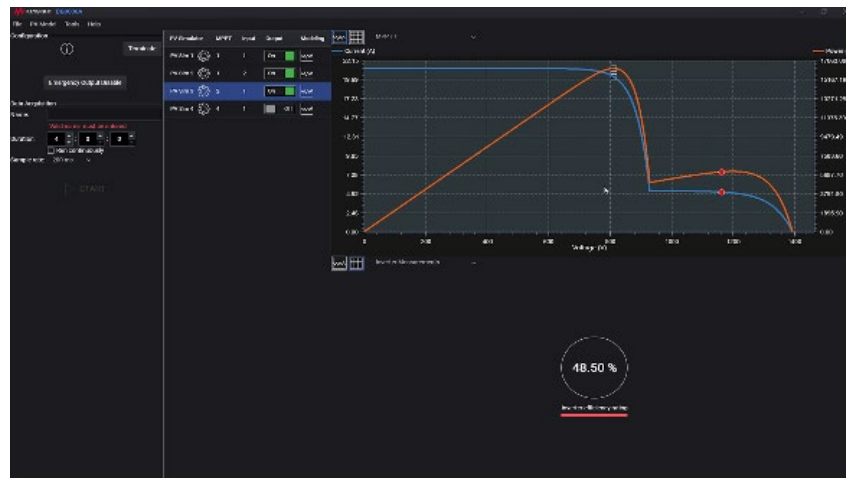

Figure 7 - DG9000A MPPT efficiency

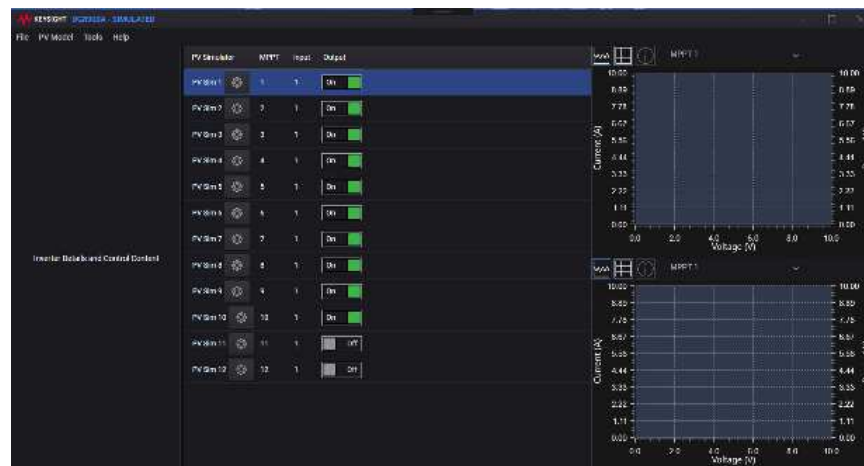

Figure 8 - DG9000A multiple control

DG8900 SAS Control Software

To easily compare your efficiency to your competitors and maximize your appeal to customers, the DG8900 SAS control software has automated static and dynamic EN50530 MPPT test. Simply input the test parameters, such as Pmp, Vmp, etc., click “Start Test” and the SAS Control App does the rest. Once the test is complete, SAS Control Pro creates a report formatted to the EN50530 standard as well as a log file with all of the measurements from the test.

Key features and benefits

- Easily view and control your N8900APV Series PV Simulator from the Control tab
 - Perform simple functions, such as setting voltage, current and OVP as well as turn the output on/off
 - Set the instrument mode: SAS or Power Supply
 - View the programmed I-V and power curves, maximum power point, and the active I-V and power points (SAS mode only)
- Quickly create and download photovoltaic I-V curves from the Curve Workspace tab
 - Create PV curves according to Sandia, EN50530, and Keysight’s proprietary (N8900APV) models
 - Choose between Basic and Advanced curve generation
 - Graphically view the curve before sending it to the instrument
- Create static and dynamic EN50530 test reports with one click from the MPPT Efficiency tab (DG8901A upgrade required after 30-day free trial)
 - Automated test to the EN50530 standard
 - Automated reports formatted to the EN50530 standard
 - Full log file with all the measurements from the test

DG9000A Advanced / Multi-Input PV Inverter Test Software

Existing test standards don’t address the testing of innovative multiple-input designs, missing 99% of the possible test points, and this leads to inaccurate representations of energy conversion.

The DG9000 software helps you avoid this scenario with testing that accounts for real-world operation of multi-input inverter designs. Going beyond outdated standards, it enables quick and easy analysis that covers more operating points. Broad coverage helps you pinpoint problems and correct them before they reach your customers.

The DG9000 helps you innovate in testing with a solution that combines extensive test data with informative analysis. We’re filling in the gaps the standards haven’t yet addressed, covering more of the missing 99% and enabling testing of PV inverters that have up to 12 inputs.

Key features and benefits

- Intelligent user interface with single point of control, configuration, management, and I-V curve generation for up to 12 separate 1500 V SAS channels (15-300kW/ea)
- Swap between / view MPPT operation on up to 12 separate I-V curves; software automatically calculates combined I-V curves from multiple separate SAS channels connected in parallel
- Synchronized dynamic I-V curve scaling across separate SAS channels
- Test data dashboard aggregates/displays time-synchronized real-time measurements of voltage, current, power, and MPPT efficiency for up to 12 independent MPPTs and/or 12 separate PV inverter inputs
- Synchronized time-stamped data logging of all theoretical (programmed) and actual (measured) operating characteristics

DG9000 Advanced / Multi-Input PV Inverter Test Software

The N8937/57APV has two solar array simulation (SAS) operating modes: curve mode where the PV array simulator quickly creates the curve mathematically and table mode where you can enter the precise I-V curve with up to 1024 points.

Use multiple simulation modes to create SAS characteristics

The N8937APV (208-VAC input) and N8957APV (400-VAC input) PV array simulators enable you to develop and verify the performance of inverter maximum power tracking algorithms and efficiency.

With 1500-VDC output and 1000-VDC isolation voltage, the PV array simulators are ready for emerging solar power plant technologies and allow testing to higher solar inverter input voltages. You can configure multiple 15-kW instruments in parallel for up to 150 kW of power for testing the largest string inverters at their full rated power.

In curve mode, the output I-V characteristic follows an exponential model of the solar array/module. The characteristic is created from four input parameters:

- | | | | |
|----------|--|----------|--|
| I_{mp} | – the current at the maximum power point | V_{mp} | – the voltage at the maximum power point |
| I_{sc} | – the short-circuit current of the array | V_{oc} | – the open-circuit voltage of the array |

You also can operate the N8937/57APV PV array simulators as conventional autoranging single-output supplies, giving you the flexibility to use these supplies throughout your laboratory and production facilities. Refer to the following pages for details.

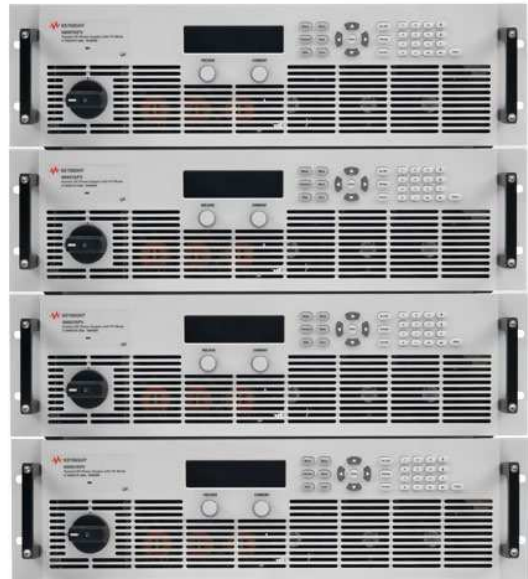

Figure 9 - Parallel the N8937/57APV to test at full power (up to 150 kW)

In table mode, the SAS characteristic curve is created from up to 1024 user-specified voltage/current points to match specific I-V curves. An intuitive PC-based software application makes creating and downloading SAS characteristic curves fast and straight-forward.

Your PV Array Simulator is Also an Autoranging System DC Power Supply

The Keysight Technologies N8937/57APV PV array simulator provides 15 kW autoranging, single-output programmable DC power for ATE applications that require just the right amount of performance at just the right price. The autoranging output characteristic enables unprecedented flexibility by offering a wide range of voltage and current combinations at full power. Power supplies with “rectangular,” or traditional, output characteristics provide full power at only one voltage and current combination. Just one does the job of multiple power supplies. It’s like having many power supplies in one!

The N8937/57APV PV array simulator Series provides stable output power, built-in voltage and current measurements, and autoranging output voltage and current from up to 1500V and up to 30 A. These supplies offer many system-ready features like multiple standard I/O interfaces to simplify and accelerate test-system development and compact 3U design to save rack space. If you need more power, you can easily parallel multiple units to create “one” power supply with up to 90 kW of total output power. The built-in primary/secondary control enables programming as if it’s just one big power supply; no need to program each supply individually.

Autoranging output – does the job of multiple power supplies

The N8937/57APV PV array simulators’ autoranging output characteristic makes it much more flexible than rectangular, or traditional, output characteristic power supplies because they expand the power curve, giving you more voltage and current combinations in one power supply. It’s like having many rectangular power supplies in one.

For example, the 1500 V, 30 A, 15 kW model is capable of 1500 V and 10 A at 15 kW as well as 500 V and 30 A at 15 kW. If it were a rectangular output, the specifications will be 1500 V, 10 A, 15 kW. At 500 V it would only be able to output 5 kW, not the 15 kW of autoranging output. Figures 4 and 5 show a graphical representation of this example.

Easy front-panel operation

Using the front panel controls, you have complete access to all of the N8937/57APV PV array simulator features via the extensive menu system (Note: SAS table points cannot

Just the right amount of performance at just the right price

- 15 kW maximum output power
- Up to 1500 V and up to 30 A
- Available with 208- and 400-VAC input
- Easily parallel units to create “one” power supply with up to 150 kW of power
- Built-in voltage and current measurement
- High power density, 15 kW in only 3U (5.25 inch/13.34 cm)
- Protection from over-voltage, over-current, and over-temperature
- LAN (LXI Core), USB, GPIB, and analog interfaces all standard



Figure 10 – Autoranging output – like having many power supplies in one

be programmed from the front panel). You can either use the voltage and current knobs or enter your settings via the keypad. You can also set protection settings, power-on states, and other features. The output voltage, current, and power can be displayed simultaneously, and annunciators at the bottom of the display show PV array simulator status and operating modes. You can lock the front panel controls to protect against accidental parameter changes.

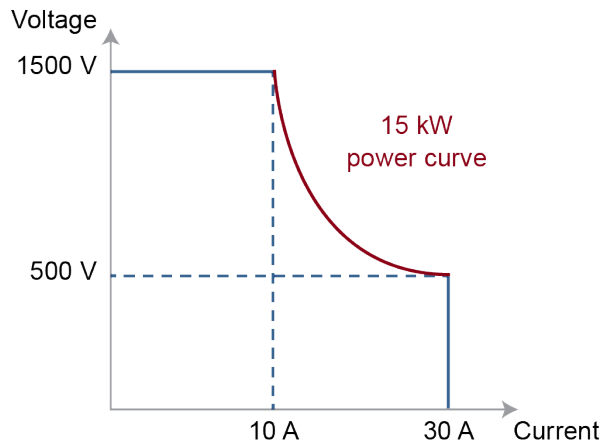

Figure 11. Autoranging output characteristic

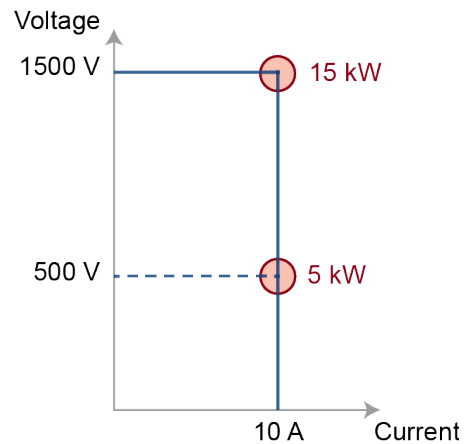

Figure 12. Rectangular output characteristic

Device protection

To safeguard your device, the N8937/57APV PV array simulator provides over-temperature, over-current and over-voltage protection to shut down the power supply output when a fault condition occurs.

Simple system connections

The N8937/57APV PV array simulator comes standard with GPIB, Ethernet/LAN, USB 2.0, and analog interfaces giving you the flexibility to use your I/O interface of choice today and safeguard your test setup for the future. There is no need to worry whether or not you are choosing the right interface when they all come standard. The PV array simulators are fully compliant with the LXI Core specification.

Remote access and control

The built-in Web server provides remote access and control of the instrument via a standard browser. This control goes above and beyond the LXI specification, giving you the ability to monitor and control the instrument from anywhere. Using the Web browser, you can set up, monitor and operate the instrument remotely.



Figure 13. Web graphical user interface for remote access and control of the instrument.

Easy system integration and configuration

To simplify system development, the PV array simulators come standard with IVI-COM drivers. The PV array simulators support easy-to-use SCPI (Standard Commands for Programmable Instruments) commands.

Need more power? We've got you covered.

Quickly create a primary/secondary setup for even more total output power. The PV array simulators give you the flexibility to easily connect in parallel up to ten identical units for greater output current and power. The units can also be configured to look like "one" big power supply. (See Figure 7, page 6.) Series operation is not recommended.

Analog programming and monitoring

The output voltage and current can be programmed from zero to full-scale by an analog voltage signal from 0 to 5 V or 0 to 10 V, each corresponding to 0 to 100% of full-scale. The measured output voltage and current can also be monitored in the same way.

AC input

Choose either the N8937APV for 208-VAC input or the N8957APV for 400-VAC input. This gives the PV array simulator the ability to be used anywhere in the world. Choose 208 VAC for regions such as the Americas and Japan or choose 400 VAC for regions such as Europe and Asia.



Figure 14. Parallel operation for more power (cables not included)

Performance specifications

All specifications pertain to > 2% of rated voltage and > 1% of rated current

		N8937APV / N8957APV
DC output ratings	Voltage	1500 V
	Current	30 A
	Power	15 kW
Output voltage ripple and noise	CV p-p ¹	2400 mV
	CV rms ²	400 mV
Load effect (change from 0% to 100% of full load)	Voltage	750 mV
	Current	53 mA / 45 mA
Programming accuracy (23 °C ± 5 °C)	Voltage	≤ 1.5 V
	Current	≤ 60 mA
Measurement accuracy (23 °C ± 5 °C)	Voltage	≤ 1.5 V
	Current	≤ 60 mA
Load transient recovery time (time for output voltage to recover within 1% of its rated output for a load change from 10% to 90% of its rated output current)		
Time		≤ 1.5 ms

Supplemental characteristics (typical)

		N8937APV / N8957APV
Output response time: Time from 10% to 90%, or 90% to 10%, of total voltage excursion	Up, full load ³	≤ 30 ms
	Down, full load ³	≤ 80 ms
	Down, no load	≤ 10 s
Command response time		< 25 ms
Remote sense compensation	Volts/load lead	30 V
Over-voltage protection	Range	0 - 1650 V
Source effect (± 10% of AC input rating)	Voltage	300 mV
	Current	15 mA
Output current ripple and noise	CC rms	26 mA
Programming resolution	Voltage	61 mV
	Current	2 mA
Measurement resolution	Voltage	61 mV
	Current	2 mA

¹ 20 Hz to 20 MHz

² 20 Hz to 300 kHz

³ For purposes of output response time, full load occurs at the full range output voltage and the maximum output current available at the full output voltage.

Supplemental characteristics (typical)

		N8937APV / N8957APV
Output terminal isolation	Positive terminal	+ 1500 V
	Negative terminal	± 1000 V
Acoustic noise declaration	Idle fan speed	56 dBA / 52 dBA
	Max fan speed	79 dBA / 73 dBA
N8937APV (208-VAC input)	Nominal input voltage	208 VAC
	Input range	Nominal ± 10%
	Frequency	45-65 Hz
	Phase	3 phase
	Input current	3 x 56 A
	Inrush current	97 A
	Efficiency	91%
N8957APV (400-VAC input)	Nominal input voltage	400 VAC
	Input range	Nominal ± 10%
	Frequency	45-65 Hz
	Phase	3 phase
	Input current	3 x 28 A
	Inrush current	49A
	Power factor	> 0.99
Efficiency	93%	

Supplemental characteristics (typical) - all models

Supplemental characteristics		
Analog programming	Input range	Selectable: 0 to 5 V or 0 to 10 V
	Accuracy	Specified accuracy + 0.2% of rating
	Input impedance	150 k Ω
	Referenced to:	Ground
Temperature coefficients: (after 30-minute warmup)	Voltage	50 PPM/ $^{\circ}$ C of rated output voltage
	Current	50 PPM/ $^{\circ}$ C of rated output current
Series operation not recommended		
Parallel operation	Primary/secondary	Yes
	Saveable states Non-volatile memory	10 memory locations
Interface capabilities	GPIB, USB 2.0, 10/100 LAN	SCPI - 1993, IEEE 488.2 - compliant interface
	LXI compliance	LXI Core 2011 compliant
Environmental conditions	Environment	Indoor use, installation category II (AC input), pollution degree 2
	Operating temp	0 $^{\circ}$ C to 45 $^{\circ}$ C
	Storage temp	-20 $^{\circ}$ C to 70 $^{\circ}$ C
	Operating humidity	80%
	Storage humidity	80%
	Altitude	2000 m
	Built-in Web server	Requires Internet Explorer 7+, or Firefox. Additionally requires Java plug-in and the Java Runtime Environment.
Regulatory compliance		
EMC	<ul style="list-style-type: none"> Complies with European EMC Directive for test and measurement products Complies with Australian standard and carries C-Tick mark Complies with Canadian ICES-001 	
Safety	<ul style="list-style-type: none"> Complies with European Low Voltage Directive and carries the CE-marking Complies with US and Canadian safety regulations Not applicable for IT mains supply systems <p>Declarations of Conformity for this product may be downloaded from the web. Go to http://www.keysight.com/go/conformity and enter model number of your unit in the search field.</p>	

Outline diagrams

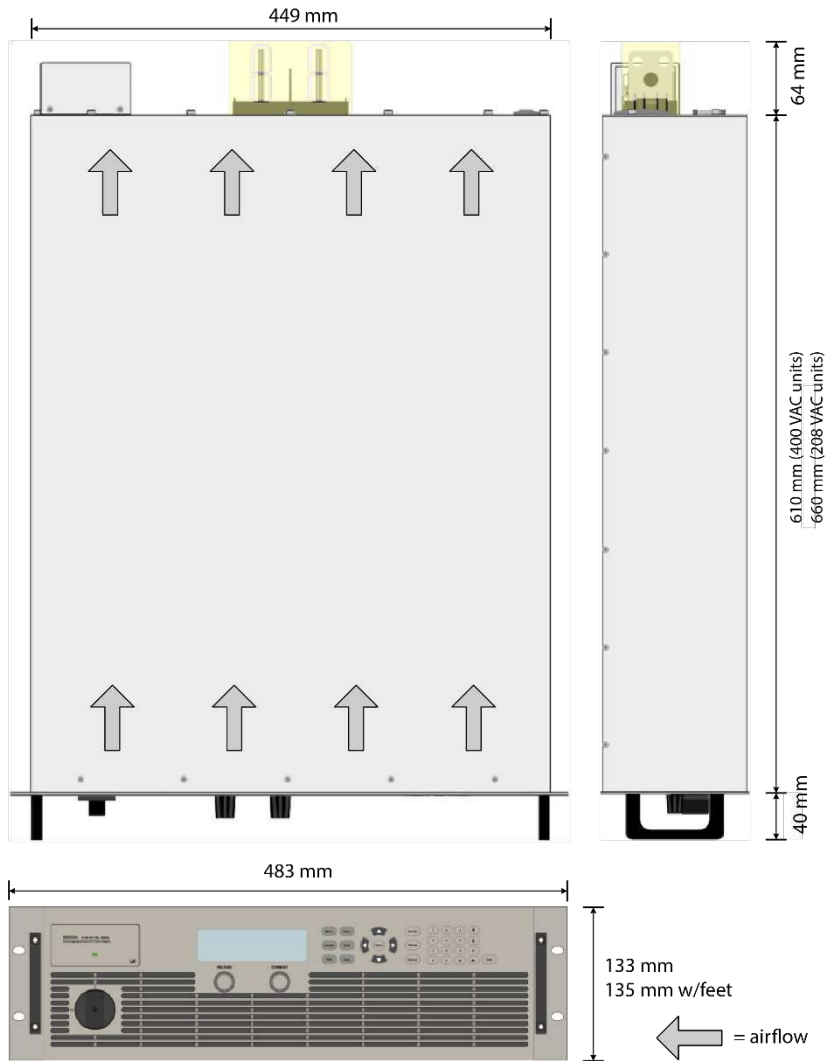

Product weight

N8937APV (208-VAC)	35.2 kg (77.4 lbs)
N8957APV (400-VAC)	31.8 kg (70 lbs)

DC output bus-bar detail

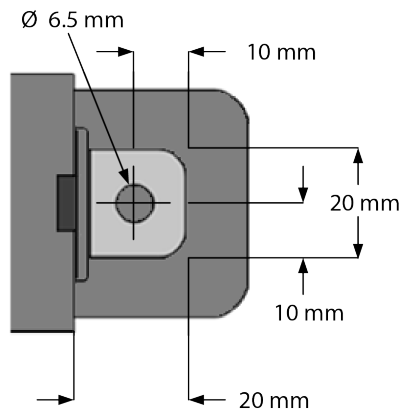

Available N8900APV models

Model #	Max voltage (V)	Current (A) @ max voltage ¹	Voltage (V) @ max current ¹	Max current (A)	Max power (W)	AC input voltage (VAC)
N8937APV	1500	10.0	500.0	30	15000	208
N8957APV	1500	10.0	500.0	30	15000	400



Figure 15. N8937APV System DC Power Supply with PV Mode

DG9000A Advanced / Multi-Input Photovoltaic Inverter Test Software

Available for download at <http://http://www.keysight.com/find/DG9000Adownload>

Product/Model #	Description
DG9104A	License to control up to 4 PV simulators in DG9000A software
DG9108A	License to control up to 8 PV simulators in DG9000A software
DG9112A	License to control up to 12 PV simulators in DG9000A software

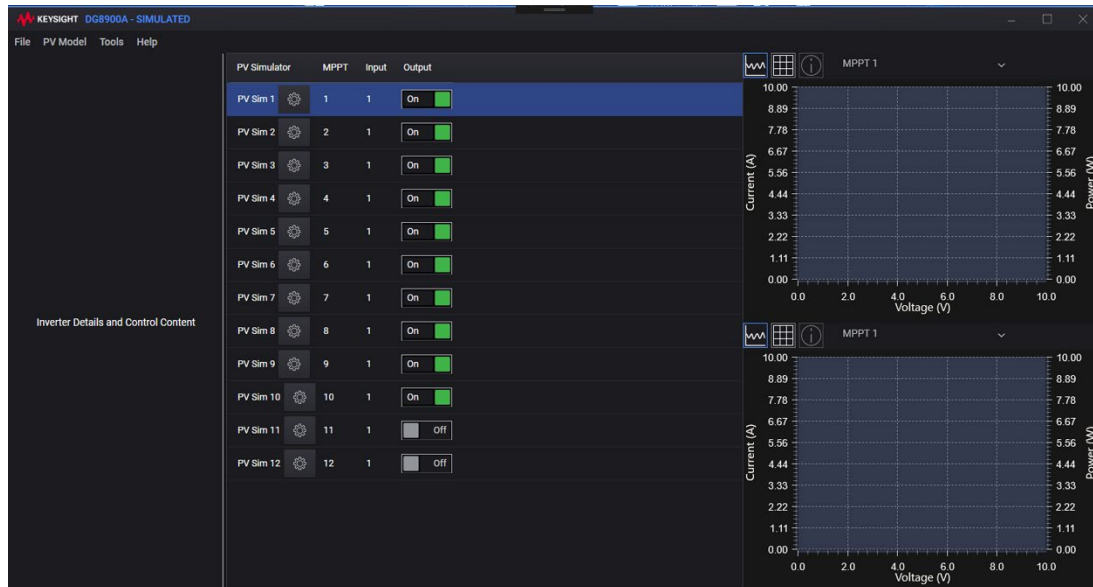

Figure 16 – DG9000A Multit

¹ The N8937/57APV PV array simulators can be used as autoranging power supplies. The “Current @ max voltage” and “Voltage @ max current” are listed to show the full range of voltage and current combinations possible due to the autoranging capability.

DG901A SAS Control Software

Available for download at <http://www.keysight.com/find/SasControlSoftware>

Product/Model #	Description
DG8901A	License for SAS Control Pro, enables automated static and dynamic EN50530 test

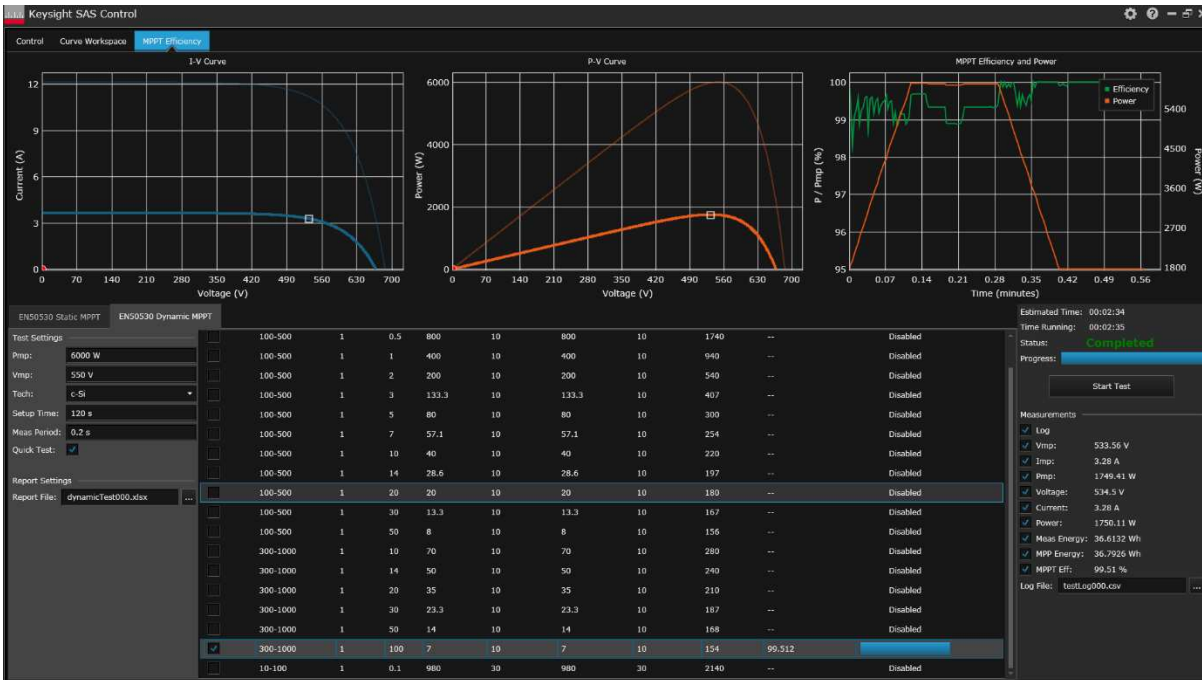

Figure 17. SAS Control Software performing dynamic EN50530 MPPT test

N8900APV Options

None

N8900APV AC input voltages

If the AC input voltage where the instrument will be used is:

- 208, 220, 230, or 240 VAC, $\pm 10\%$, please choose the N8937APV
- 400 VAC $\pm 10\%$, please choose the N8957APV

N8900APV Line cords and terminations (plugs)

Due to the number of different line cords and regulations around the world, the N8937/57APV PV array simulators do not include line cords or terminations. You will need to supply your own dependent on the local laws and codes of the country/region where you will use the PV array simulator.

Learn more at: www.keysight.com

For more information on Keysight Technologies' products, applications or services, please contact your local Keysight office. The complete list is available at: www.keysight.com/find/contactus

