

## About this Manual

We've added this manual to the Agilent website in an effort to help you support your product. This manual is the best copy we could find; it may be incomplete or contain dated information. If we find a more recent copy in the future, we will add it to the Agilent website.

## Support for Your Product

Agilent no longer sells or supports this product. Our service centers may be able to perform calibration if no repair parts are needed, but no other support from Agilent is available. You will find any other available product information on the Agilent Test & Measurement website, [www.tm.agilent.com](http://www.tm.agilent.com).

## HP References in this Manual

This manual may contain references to HP or Hewlett-Packard. Please note that Hewlett-Packard's former test and measurement, semiconductor products and chemical analysis businesses are now part of Agilent Technologies. We have made no changes to this manual copy. In other documentation, to reduce potential confusion, the only change to product numbers and names has been in the company name prefix: where a product number/name was HP XXXX the current name/number is now Agilent XXXX. For example, model number HP8648A is now model number Agilent 8648A.

# Measurement Guide

## HP ESA-L1500A Spectrum Analyzer



**HP Part No. E4411-90022 Supersedes E4411-90001**

**Printed in: USA**

**June 1997**

Hewlett-Packard Company 1997 All Rights Reserved. Reproduction, adaptation, or translation without prior written permission is prohibited, except as allowed under the copyright laws.

1400 Fountaingrove Parkway, Santa Rosa, CA 95403-1799, USA

---

## Notice

The information contained in this document is subject to change without notice.

Hewlett-Packard makes no warranty of any kind with regard to this material, including but not limited to, the implied warranties of merchantability and fitness for a particular purpose. Hewlett-Packard shall not be liable for errors contained herein or for incidental or consequential damages in connection with the furnishing, performance, or use of this material.

---

## Safety Notice

The following safety notes are used throughout this manual. Familiarize yourself with the notes and their meaning before operating this instrument.

---

### CAUTION

Caution denotes a hazard. It calls attention to a procedure that, if not correctly performed or adhered to, would result in damage to or destruction of the instrument. Do not proceed beyond a caution until the indicated conditions are fully understood and met.

---

### WARNING

**Warning denotes a hazard. It calls attention to a procedure which, if not correctly performed or adhered to, could result in injury or loss of life. Do not proceed beyond a warning note until the indicated conditions are fully understood and met.**

---

### WARNING

**This is a Safety Class 1 Product (provided with a protective earthing ground incorporated in the power cord). The mains plug shall only be inserted in a socket outlet provided with a protective earth contact. Any interruption of the protective conductor inside or outside of the product is likely to make the product dangerous. Intentional interruption is prohibited.**

---

# Contents

<b>1. Instrument Overview</b>	
Front Panel Features .....	6
Rear Panel Features .....	10
Screen Annotation .....	13
<b>2. Making Basic Measurements</b>	
What's in This Chapter .....	18
Comparing Signals .....	19
Resolving Signals of Equal Amplitude .....	23
Resolving Small Signals Hidden by Large Signals .....	26
Making Better Frequency Measurements .....	29
Decreasing the Frequency Span Around the Signal .....	31
Tracking Unstable Signals .....	33
Measuring Low Level Signals .....	37
Identifying Distortion Products .....	44
Demodulating AM Signals (Using the Analyzer As a Fixed Tuned Receiver) .....	49
<b>3. Making Measurements</b>	
What's in This Chapter .....	54
Making Stimulus Response Measurements .....	55
Making a Reflection Calibration Measurement .....	62
Demodulating and Listening to an AM Signal .....	65
Measuring Device Bandwidth .....	68
Measuring Percent Amplitude Modulation .....	70
Measuring Third Order Intermodulation Distortion .....	72
<b>4. Using Instrument Features</b>	
What's in this Chapter .....	76
Saving and Loading Files from Analyzer Memory .....	77
Creating Limit Lines .....	81
Entering Amplitude Correction Factors .....	92

## Index

---

# **1 Instrument Overview**

- Front Panel
- Rear Panel
- Screen Annotation

## Front Panel Features

Figure 1-1 Front Panel Feature Overview

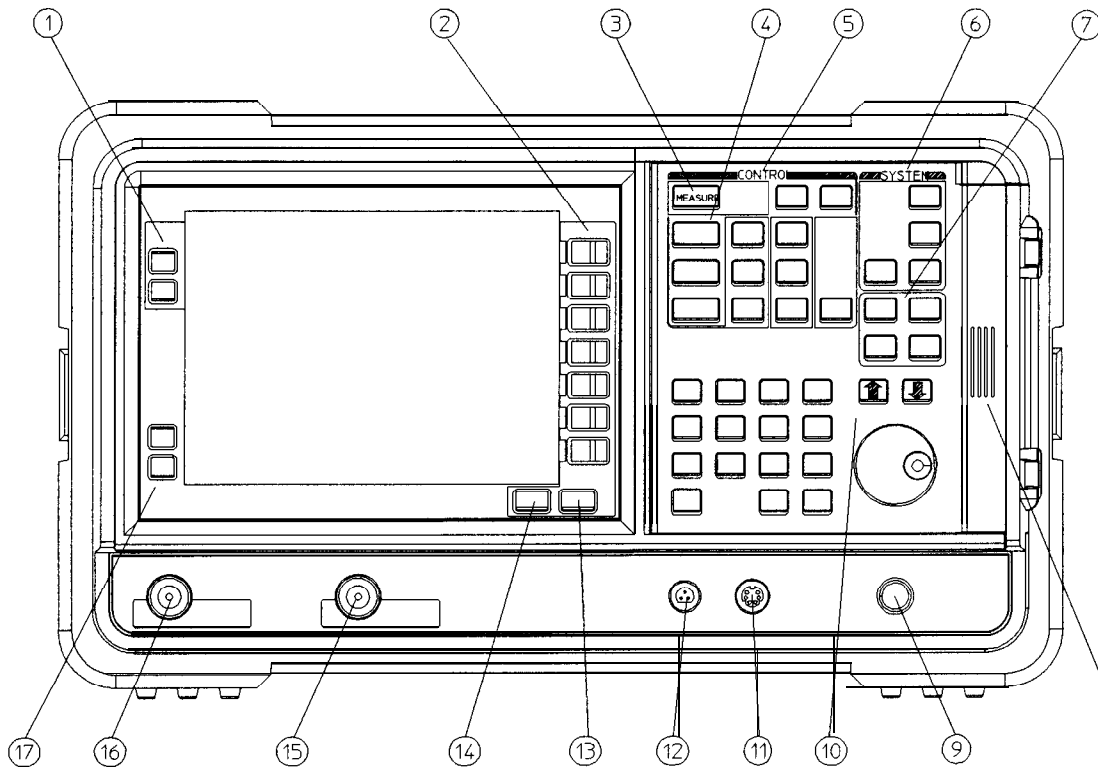

- 1 **Brightness keys** allow you to change the brightness of the display.
- 2 **Menu keys** are the unlabeled keys next to the screen. The menu key labels are the annotation on the screen next to the unlabeled keys. Most of the labeled keys on the spectrum analyzer front panel (also called front panel keys) access menus of related function keys.
- 3 **Measure** accesses a menu of keys that make some common spectrum analyzer measurements.
- 4 **Frequency, Span, and Amplitude** are the three large keys that activate the primary spectrum analyzer functions and access menus of related functions.

- 5           **CONTROL** functions access menus that allow you to adjust the resolution bandwidth, adjust the sweep time, and control the instrument display They also set other spectrum analyzer parameters needed for making measurements.
- 6           **SYSTEM** functions affect the state of the entire spectrum analyzer. Printer setup and alignment routines are accessed with the **System** key The green **Preset** key resets the spectrum analyzer to a known state.
- The **File** key menu allows you to save and load traces, states, limit-line tables and amplitude correction factors to or from spectrum analyzer memory.
- Print** sends a copy of the screen data to a printer. Use the **Printer** menu keys under **System** before using the **Print** key See the user's guide for more details.
- 7           **MARKER** functions control the markers, read out frequencies and amplitudes along the spectrum analyzer trace, automatically locate the signals of highest amplitude, and keep a signal in the center of the screen.
- 8           **EARPHONE.** The **EARPHONE** connector (located behind the door on the right side of the front panel) provides a connection for an earphone jack instead of using the internal speaker. The speaker is turned on and off with the **Speaker On Off** key in the **Det/Demod** menu.
- 9           **VOLUME.** The **VOLUME** knob can adjust the volume of the internal speaker. The speaker is turned on and off with the **Speaker On Off** key in the **Det/Demod** menu.
- 10          **DATA** keys, which include the step keys, knob, and numeric keypad, allow you to change the numeric value of an active function.
- 11          **EXT KEYBOARD.** The **EXT KEYBOARD** connector is a 6-pin mini-DIN connector that is compatible with most PC key boards. The external keyboard is not included with the spectrum analyzer. The external keyboard can be used to enter screen titles and remote commands.

---

**CAUTION**

---

Turn off the spectrum analyzer before connecting an external keyboard to the spectrum analyzer.

- 12          **PROBE POWER** provides power for high-impedance ac probes or other accessories.

- 13            **Esc.** The **Esc** (escape) key deactivates the active function and blanks the active function text from the display **Esc** will abort a print (if one is in progress) and clear error messages from the analyzer display
- 14            **More.** The **More** key accesses other pages of a multi-page menu. A 1 of 2 type message is displayed just above the key if there is more than one page.
- 15            **INPUT 50Ω (INPUT 75Ω** for Option 1DP) is the signal input for the spectrum analyzer.
- 16            **RF OUT 50Ω** (for Option 1DN) or **RF OUT 75Ω** (for Option 1DQ) is the source output for the built-in tracking generator. Option 1DN or 1DQ only

---

**CAUTION**

If the tracking generator output power is too high, it may damage the device under test. Do not exceed the maximum power that the device under test can tolerate.

- 17            The **I** (On) key turns the analyzer on, while the **0** (Standby) key turns most of the analyzer off. An instrument alignment is performed every time the analyzer is turned on. After applying power, allow 5 minutes of warm-up time to ensure the analyzer will meet all specifications.

---

**NOTE**

The instrument continues to draw power when it is plugged into the ac power source even if the line power switch is in standby

## Data Controls

Data controls are used to change values for functions such as center frequency, start frequency, resolution bandwidth, and marker position.

The data controls will change the active function in a manner prescribed by that function. For example, you can change center frequency in fine steps with the knob, in discrete steps with the step keys, or to an exact value with the numeric keypad. Resolution bandwidth, however, which can be set to discrete values in a 1, 3, 10 sequence only, is changed to the closest allowed value with any of the data controls.

## Knob

The knob allows continuous change of functions such as center frequency, reference level, and marker position. It also changes the values of many functions that change in increments only Clockwise rotation of the knob increases values. For continuous changes, the



extent of alteration is determined by the size of the measurement range; the speed at which the knob is turned affects the rate at which the values are changed.

The knob enables you to change the center frequency, start or stop frequency, or reference level. In slow sweep times, the analyzer uses a smooth scrolling feature which is designed to move the trace display to the latest function value as the knob is turned. When either center frequency or reference level is adjusted, the signal will shift right or left or up or down with the rotation of the knob before a new sweep is actually taken. An asterisk is placed in the message block (the upper right hand corner of the spectrum analyzer display) to indicate that the data on-screen does not reflect data at the current setting.

## Numeric Keypad

The numeric keypad allows entry of exact values for many of the spectrum analyzer functions. You may include a decimal point in the number portion. If not, the decimal point is placed at the end of the number.

Numeric entries must be terminated with a units key. The units keys change depending on what the active function is. They are labeled on the right edge of the display. For example, the units keys for frequency span are **GHz**, **MHz**, **kHz**, and **Hz**, whereas the units for reference level are **+dBm**, **-dBm**, **mV**, and **μV**.

---

**NOTE**

---

If an entry from the numeric keypad does not coincide with an allowed function value (for example, that of a 12 MHz bandwidth), the spectrum analyzer defaults to the nearest allowable value.

## Step Keys

The step keys allow discrete increases or decreases of the active function value. The step size depends upon the spectrum analyzer measurement range or on a preset amount. Each press results in a single step change. For those parameters with fixed values, the next value in a sequence is selected each time a step key is pressed. Changes are predictable and can be set for some functions. Out-of-range values or out-of-sequence values will not occur using these keys.

## Rear Panel Features

Figure 1-2 Rear Panel Feature Overview

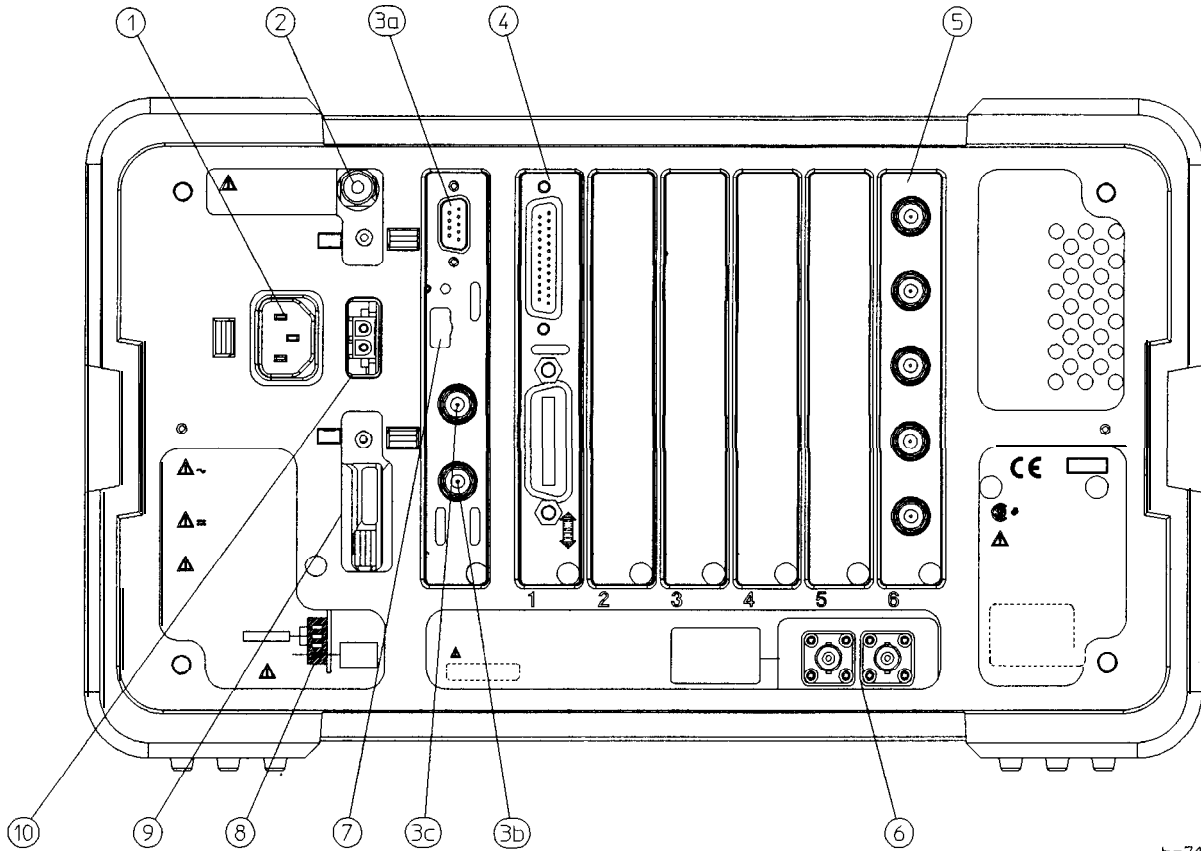

bn710a

- 1** **Power input** is the input for the line power source. Make sure that the line power source outlet has a protective ground contact.
- 2** **Line Fuse.** The fuse is removed by twisting 1/4 turn. Replace only with a fuse of the same rating. See the label on the rear panel.
- 3** **Standard Inputs/Outputs**
  - 3a** **VGA OUTPUT** drives an external VGA compatible monitor with a signal that has 31.5 kHz horizontal, 60 Hz vertical synchronizing rate, non-interlaced.
  - 3b**
  - 3c**

- 3b                    **EXT TRIG IN (TTL)** accepts the positive edge of an external voltage input that triggers the spectrum analyzer internal sweep source.
- 3c                    **HI SWP OUT (TTL)** indicates when the spectrum analyzer is sweeping.
- 4                    **(Shown) HP-IB and parallel (Option A4H)** are optional interfaces. HP-IB supports remote instrument operation and direct printing of screen data. The parallel port is for printing only
- (Not Shown) RS-232 and parallel (Option 1AX)** are optional interfaces. RS-232 supports remote instrument operation and direct printing of screen data. The parallel port is for printing only
- Only one optional interface can be installed at a time. Option 1AX or Option A4H must be installed in slot 1 on the rear panel. Option A4H is shown installed in slot 1 in the figure.
- 5                    **Spectrum Analyzer Inputs/outputs (Option A4J):**
- SWP OUT** provides a voltage ramp corresponding to the sweep of the spectrum analyzer (0 V to 10 V).
- HI SWP OUT (TTL)** indicates when the spectrum analyzer is sweeping.
- HI SWP IN (TTL)** can be grounded to stop sweeping.
- AUX VIDEO OUT** provides detected video output (before the analog to digital conversion) proportional to vertical deflection of the trace. Output is from 0 V to 1 V. Amplitude correction factors are not applied to this signal. The output signal will be blanked occasionally during retrace by the automatic alignment routine. Select a very long sweep time to minimize this, or turn off the Auto Align All function (and use Align Now All manually to maintain calibration.) Refer to the user's guide for more information on alignment key functions.
- AUX IF OUT** is a 50 $\Omega$ , 21.4 MHz IF output that is the down-converted signal of the RF input of the spectrum analyzer. Amplitude-correction factors are not applied to this signal. This output is taken after the resolution bandwidth filters and step gains and before the log amplifier. The output signal will be blanked occasionally during retrace by the automatic alignment routine. Select a very long sweep time to minimize this, or turn off the Auto Align All function (and use Align

Now All manually to maintain calibration.) Refer to the user's guide for more information on alignment key functions.

**10 MHz REF IN** accepts an external frequency source to provide the 10 MHz, -15 to +10 dBm frequency reference used by the spectrum analyzer.

**10 MHz REF OUT** provides a 10 MHz, 0 dBm minimum, timebase reference signal.

**Service Connector.** The service connector is for service use only

**Power On Selection** selects a preference for when power is applied to the analyzer's rear panel power connector. The analyzer can be set to be always off or always on when power is connected. This is useful when the analyzer is used at an unattended location to ensure that the analyzer powers on after a power outage.

- 9 **DC Fuse.** Protects against too much power to the DC power connector on the rear panel of the spectrum analyzer.
- 10 **DC Power** is the input for the DC power source. Refer to "Power Requirements" in the specifications chapter of the user's guide.

## Screen Annotation

Here is an example of the annotation that may appear on a spectrum analyzer screen. The screen annotation is referenced by numbers which are listed in the following table. The Function Key column indicates which key activates the function related to the screen annotation. Refer to the user's guide for more information on a specific function key.

Figure 1-3 Screen Annotation

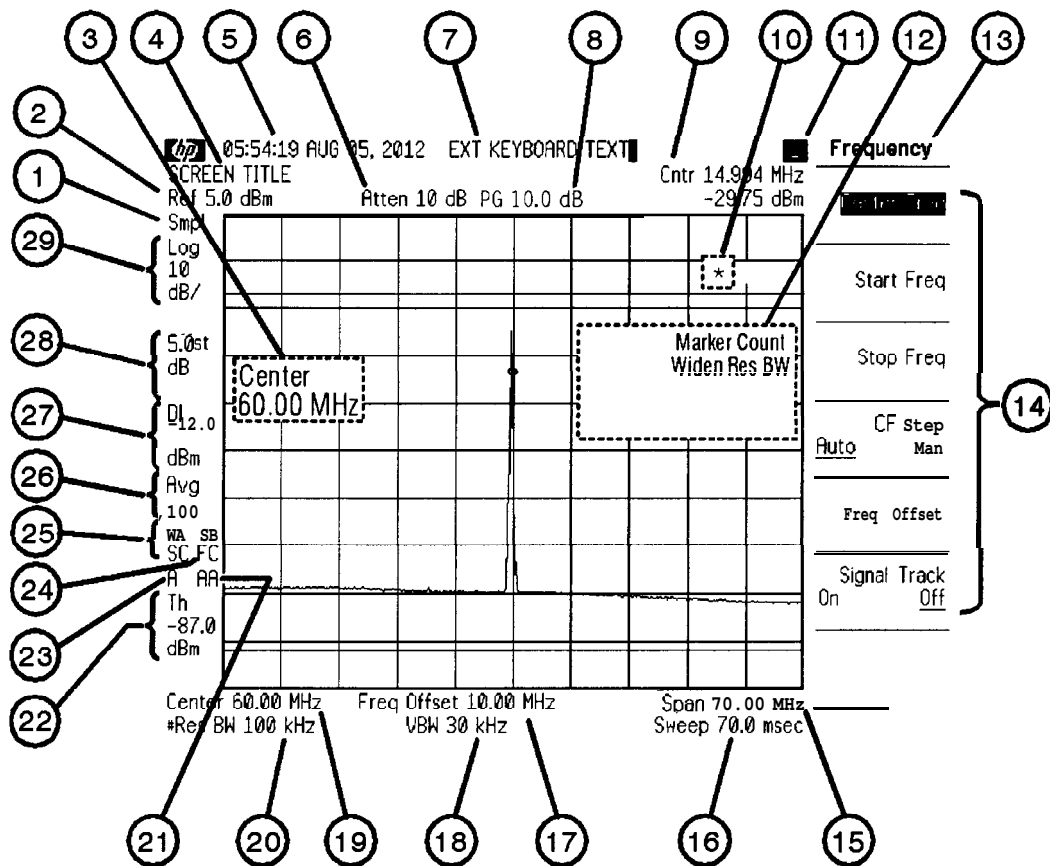

nl744a

## Screen Annotation

Item	Description	Function Key
1	Detector mode	<b>Detector</b>
2	Reference level	<b>Ref Level</b>
3	Active function block	Refer to the description of the activated function.
4	Screen title	<b>Change Title</b>
5	Time and date display	<b>Time/Date On Off</b>
6	RF attenuation	<b>Attenuation Auto Man</b>
7	External keyboard entry	Refer to the external keyboard information in the Measurement Guide.
8	Preamplifier gain	<b>Ext Amp Gain</b>
9	Marker counter	<b>Marker Count On Off</b>
10	Measurement uncalibrated or function-in-progress messages	<b>Auto Couple</b>
11	Remote/local operation	See <b>Local</b> key in user's guide.
12	Error messages	See the user's guide for more information.
13	Key menu title	Dependent on key selection.
14	Key menu	See key label descriptions in user's guide.
15	Frequency span or stop frequency	<b>Span, Stop Freq</b>
16	Sweep time	<b>Sweep Time Auto Man</b>
17	Frequency offset	<b>Freq Offset</b>
18	Video bandwidth	<b>Video BW Auto Man</b>
19	Center frequency or start frequency	<b>Center Freq, Start Freq</b>
20	Resolution bandwidth	<b>Resolution BW Auto Man</b>
21	Auto alignment routine is on	<b>Auto Align All</b>
22	Threshold	<b>Threshold On Off</b>

Item	Description	Function Key
23	Amplitude correction factors on	See "Entering Amplitude Correction Factors" in Chapter 4.
24	Trigger	<b>Trig</b>
25	Trace mode	<b>Trace</b>
26	Video average	<b>Video Average On Off</b>
27	Display line	<b>Display Line On Off</b>
28	Amplitude offset	<b>Ref Lvl Offst</b>
29	Amplitude scale	<b>Scale Type Log Lin</b>

Item 24 refers to the trigger and sweep modes of the spectrum analyzer. The first letter ("F") indicates the spectrum analyzer is in free run trigger mode. The second letter ("C") indicates the spectrum analyzer is in continuous sweep mode.

Item 25 refers to the trace modes of the spectrum analyzer. The first letter ("W") indicates that the spectrum analyzer is in clear-write mode. The second letter is "A," representing trace A. The trace B trace mode is "SB", indicating trace B ("B") is in the store-blank mode ("S"). The trace mode annotation for trace C is displayed under the trace mode annotation of trace A. The trace C trace mode is "SC", indicating trace C ("C") is in the store blank mode ("S").

Refer to the following table for the screen annotation codes for trace, trigger, and sweep modes.

**Table 1-1**

**Screen Annotation for Trace, Trigger, and Sweep Modes**

Trace Mode	Trigger Mode	Sweep Mode
W clear write (traces A/B/C)	F free run	C continuous
M maximum hold (traces A/B)	L line	S single sweep
V view (traces A/B/C)	V video	
S store blank (traces A/B/C)	E external	
M minimum hold (trace C)		

---

## **2 Making Basic Measurements**



## What's in This Chapter

This chapter demonstrates basic spectrum analyzer measurements with examples of typical measurements; each measurement focuses on different functions. The measurement procedures covered in this chapter are listed below.

- “Comparing Signals” on page 19
- “Resolving Signals of Equal Amplitude” on page 23
- “Resolving Small Signals Hidden by Large Signals” on page 26
- “Making Better Frequency Measurements” on page 29
- “Decreasing the Frequency Span Around the Signal” on page 31
- “Tracking Unstable Signals” on page 33
- “Measuring Low Level Signals” on page 37
- “Identifying Distortion Products” on page 44
- “Demodulating AM Signals (Using the Analyzer As a Fixed Tuned Receiver)” on page 49

To find descriptions of specific spectrum analyzer functions, refer to the user's guide.

## Comparing Signals

Using the spectrum analyzer, you can easily compare frequency and amplitude differences between signals, such as radio or television signal spectra. The spectrum analyzer delta marker function lets you compare two signals when both appear on the screen at one time or when only one appears on the screen.

### Example 1:

Measure the differences between two signals on the same display screen.

1. Use the spectrum analyzer's internal 50 MHz alignment signal as the signal being measured. Press **Preset**, **System**, **50 MHz osc On Off** (On). Set the center frequency to 75 MHz and the span to 200 MHz: press **Frequency**, **75 MHz**, **Span**, **200 MHz**.

The alignment signal and its harmonics appear on the display

2. Press **Search** to place a marker at the highest peak on the display (The **Next Pk Right** and **Next Pk Left** softkeys are available to move the marker from peak to peak.) The marker should be on the 50 MHz alignment signal. See Figure 2-1.

The signal that appears to the left of the 50 MHz signal, is the spectrum analyzer local oscillator (LO) and represents 0 Hz.

**Figure 2-1**     **Placing a Marker on the 50 MHz Signal**

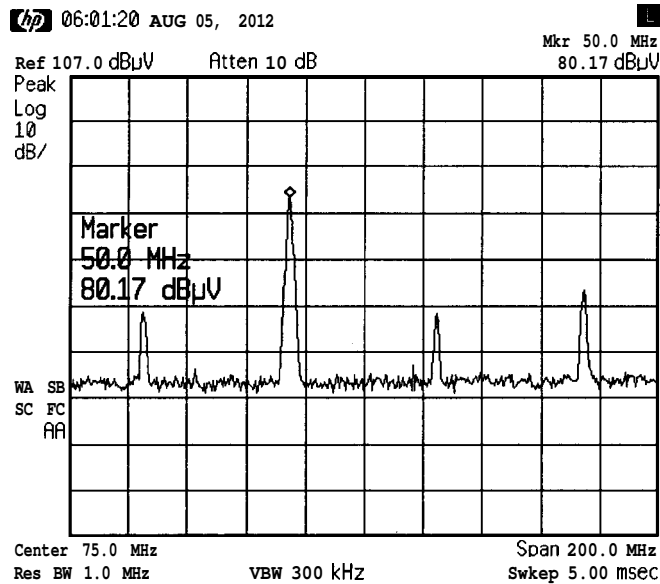

3. Press **Marker, Marker A**, to activate a second marker at the position of the first marker. Move the second marker to another signal peak using the knob, or by pressing **Search** and **Next Pk Right** or **Next Pk Left**.
4. The amplitude and frequency difference between the markers is displayed in the active function block and in the upper left corner of the screen. See Figure 2-2. The resolution of the marker readings can be increased by turning on the frequency count function. Press **Freq Count**.

Press **Marker, Marker All Off** to turn the markers off.

**Figure 2-2 Using the Marker Delta Function**

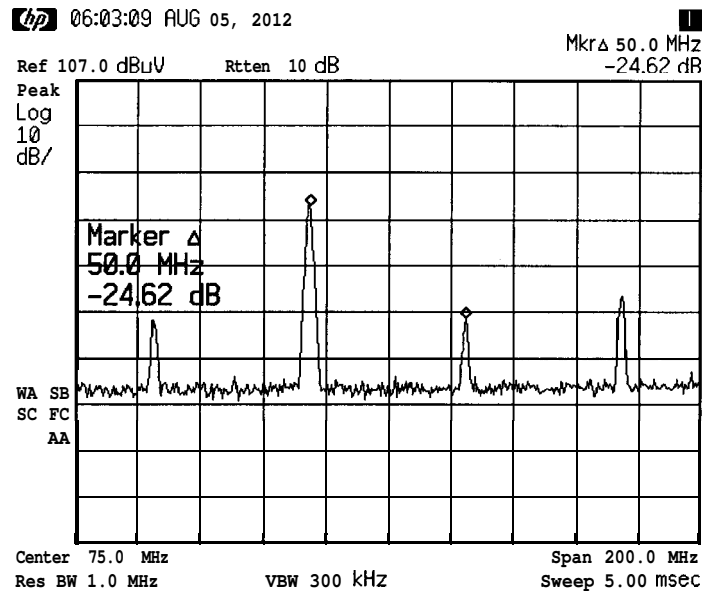

### Example 2:

Measure the frequency and amplitude difference between two signals that do not appear on the screen at one time. (This technique is useful for harmonic distortion tests when narrow span and narrow bandwidth are necessary to measure the low level harmonics.)

1. Turn on the spectrum analyzer's internal 50 MHz alignment signal (if you have not already done so). Press **Preset, System, 50 MHz osc On Off (On)**. Then press **Frequency, 50 MHz, Span** and the step down key ( $\downarrow$ ) to narrow the frequency span until only one signal appears on the screen.
2. Press **Peak Search** to place a marker on the peak.
3. Press **Marker, Marker A** to anchor the position of the first marker and activate a second marker.
4. Press **Frequency, CF Step Auto Man (Man)** to activate the center frequency step size function, and enter **50 MHz**. Press **Center Freq** and the ( $\uparrow$ ) key to increase the center frequency by 50 MHz. The first marker remains on the screen at the amplitude of the first signal peak.

**NOTE**

Changing the reference level changes the marker delta amplitude readout.

The annotation in the upper right corner of the screen indicates the amplitude and frequency difference between the two markers. See Figure 2-3.

5. To turn the markers off, press **Marker, Marker All Off**.

**Figure 2-3** Frequency and Amplitude Difference Between Signals

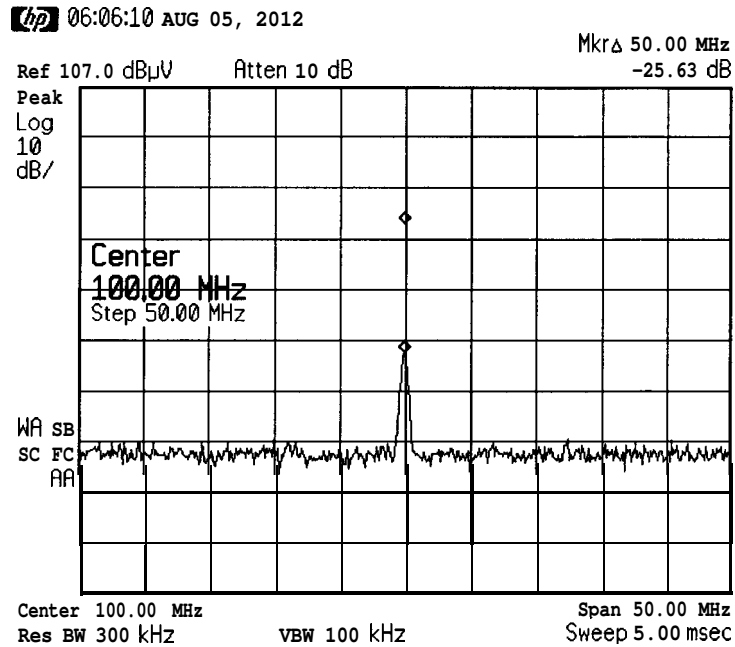

## Resolving Signals of Equal Amplitude

Two equal-amplitude input signals that are close in frequency can appear as one on the spectrum analyzer display. Responding to a single frequency signal, a swept-tuned spectrum analyzer traces out the shape of its internal IF (intermediate frequency) filters. As we change the filter bandwidth, we change the width of the displayed response. If a wide filter is used and two equal-amplitude input signals are close enough in frequency, then the two signals appear as one. Thus, signal resolution is determined by the IF filters inside the spectrum analyzer.

The bandwidth of the IF filter tells us how close together equal amplitude signals can be and still be distinguished from each other. The resolution bandwidth (Res BW) function selects an IF filter setting for a measurement. Resolution bandwidth is defined as the 3 dB bandwidth of the filter.

Generally, to resolve two signals of equal amplitude, the resolution bandwidth must be less than or equal to the frequency separation of the two signals. If the bandwidth is equal to the separation, a dip of approximately 3 dB is seen between the peaks of the two equal signals, and it is clear that more than one signal is present. See Figure 2-5.

In order to keep the spectrum analyzer measurement calibrated, sweep time is automatically set to a value that is inversely proportional to the square of the resolution bandwidth. So, if the resolution bandwidth is reduced by a factor of 10, the sweep time is increased by a factor of 100 when sweep time and bandwidth settings are coupled. (Sweep time is proportional to  $1/BW^2$ .) For fastest measurement times, use the widest resolution bandwidth that still permits discrimination of all desired signals. The spectrum analyzer allows you to select from 1 kHz to 3 MHz resolution bandwidths in a 1, 3, 10 sequence for maximum measurement flexibility.

### Example:

Resolve two signals of equal amplitude with a frequency separation of 100 kHz.

1. Connect two sources to the spectrum analyzer input as shown in Figure 2-4.

Figure 2-4 Setup for Obtaining Two Signals

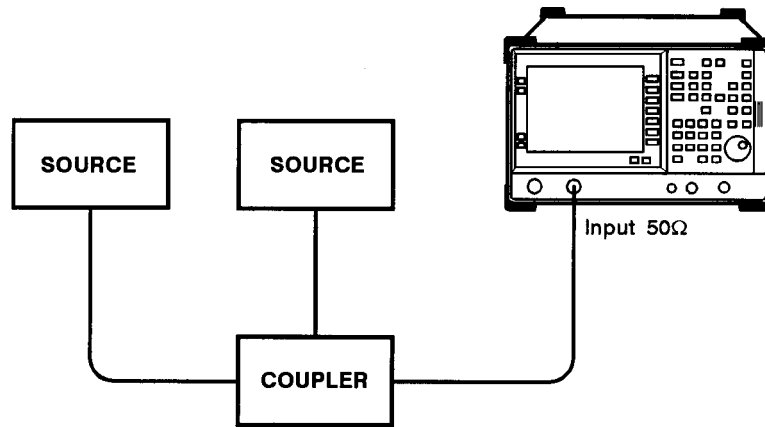

bn71a

2. Set one source to 300 MHz. Set the frequency of the other source to 300.1 MHz. The amplitude of both signals should be approximately -20 dBm.
3. On the spectrum analyzer, press **Preset**. Set the center frequency to 300 MHz, the span to 2 MHz, and the resolution bandwidth to 300 kHz by pressing **Frequency 300 MHz**, **Span 2 MHz**, then **BW/Avg 300 kHz**. A single signal peak is visible.

---

**NOTE**

If the signal peak cannot be found, increase the span to 20 MHz by pressing **Span 20 MHz**. The signal should be visible. Press **Peak Search**, **Frequency**, **Signal Track On Off** (On is underlined), then **Span 2 MHz** to bring the signal to center screen. Then press **Signal Track On Off** so that Off is underlined to turn the signal track function off.

4. Since the resolution bandwidth must be less than or equal to the frequency separation of the two signals, a resolution bandwidth of 100 kHz must be used. Change the resolution bandwidth to 100 kHz by pressing **BW/Avg 100 kHz**. Two signals are now visible as shown in Figure 2-5. Use the knob or step keys to further reduce the resolution bandwidth and better resolve the signals.

Figure 2-5 Resolving Signals of Equal Amplitude

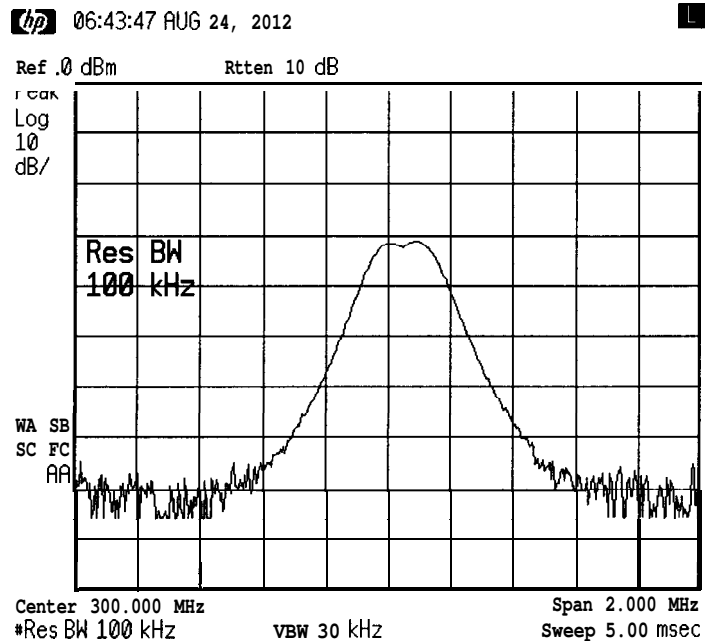

As the resolution bandwidth is decreased, resolution of the individual signals is improved and the sweep time is increased. For fastest measurement times, use the widest possible resolution bandwidth. Under preset conditions, the resolution bandwidth is “coupled” (or linked) to the span.

Since the resolution bandwidth has been changed from the coupled value, a # mark appears next to **Res BW** in the lower-left corner of the screen, indicating that the resolution bandwidth is uncoupled. (Also see the **Auto Couple** key description in the user’s guide.)

**NOTE**

To resolve two signals of equal amplitude with a frequency separation of 200 kHz, the resolution bandwidth must be less than the signal separation, and resolution of 100 kHz must be used. The next larger filter, 300 kHz, would exceed the 200 kHz separation and would not resolve the signals.



---

## Resolving Small Signals Hidden by Large Signals

When dealing with the resolution of signals that are close together and not equal in amplitude, you must consider the shape of the spectrum analyzer's IF filter as well as its 3 dB bandwidth. (See "Resolving Signals of Equal Amplitude" on page 23 example for more information.) The shape of a filter is defined by the shape factor, which is the ratio of the 60 dB bandwidth to the 3 dB bandwidth. (Generally, the IF filters in this spectrum analyzer have shape factors of 15:1 or less.) If a small signal is too close to a larger signal, the smaller signal can be hidden by the skirt of the larger signal. To view the smaller signal, you must select a resolution band width such that  $k$  is less than  $a$ . See Figure 2-6.

Figure 2-6

### Resolution Bandwidth Requirements for Resolving Small Signals

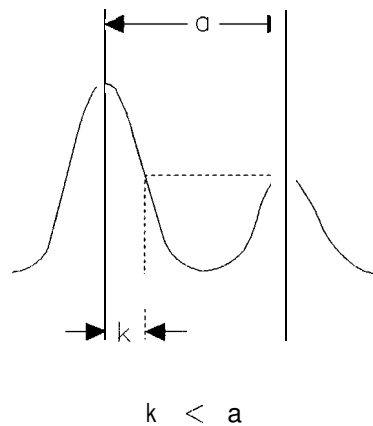

The separation between the two signals ( $a$ ) must be greater than half the filter width of the larger signal at the amplitude level of the smaller signal ( $k$ ).

### Example:

Resolve two input signals with a frequency separation of 200 kHz and an amplitude separation of 60 dB.

1. To obtain two signals with a 200 kHz separation, connect the equipment as shown in the previous section, "Resolving Signals of Equal Amplitude" on page 23. Set one source to 300 MHz at -20 dBm.
2. Set the analyzer center frequency to 300 MHz and the span to 2 MHz: press **Frequency**, 300 MHz, then **Span** 2 MHz.

NOTE

If the signal peak cannot be found, increase the span to 20 MHz by pressing **Span, 20 MHz**. The signal should be visible. Press **Peak Search, Frequency, Signal Track On Off** so that **On** is underlined, then **Span, 2 MHz** to bring the signal to center screen. Then press **Signal Track On Off** to **Off** to turn the signal track function off

3. Set the second source to 300.2 MHz, so that the signal is 200 kHz higher than the first signal. Set the amplitude of the signal to -80 dBm (60 dB below the first signal).
4. Set the 300 MHz signal to the reference level by pressing **Peak Search, Search**, then **Mkr -> RL**.

If a 10 kHz filter with a typical shape factor of 15:1 is used, the filter will have a band width of 150 kHz at the 60 dB point. The half-bandwidth (75 kHz) is narrower than the frequency separation, so the input signals will be resolved. See Figure 2-7.

**Figure 2-7 Signal Resolution with a 10 kHz Resolution Bandwidth**

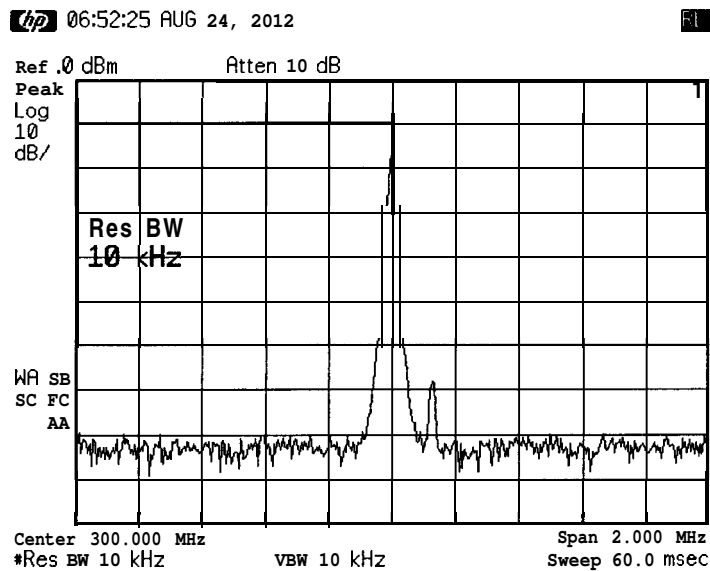

If a 30 kHz filter is used, the 60 dB bandwidth could be as wide as 450 kHz. Since the half-bandwidth (225 kHz) is wider than the frequency separation, the signals most likely will not be resolved. See Figure 2-8. (In this example, we used the 60 dB bandwidth value. To determine resolution capability for intermediate values of amplitude level differences, assume the filter skirts between the 3 dB and 60 dB points are approximately straight.)

**Figure 2-8**      **Signal Resolution with a 30 kHz Resolution Bandwidth**

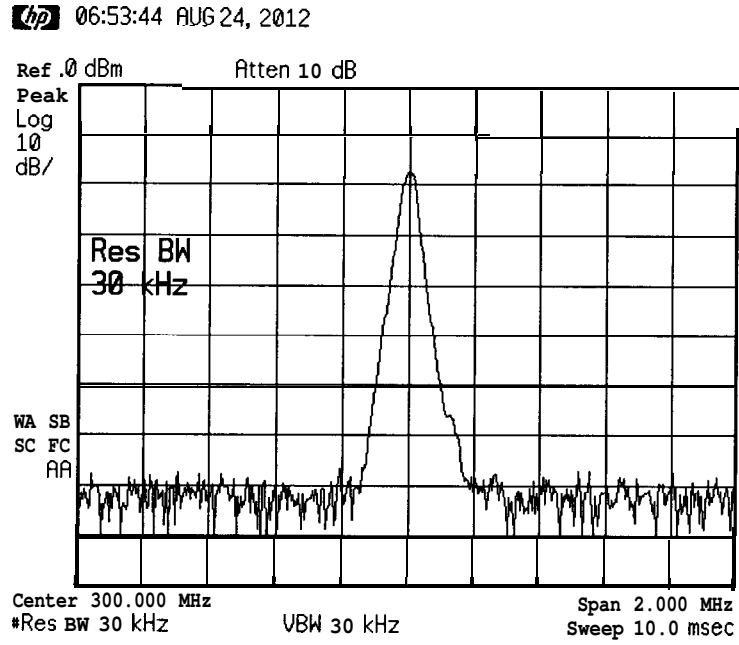

## Making Better Frequency Measurements

The frequency counter increases the resolution and accuracy of the frequency readout. When using this function, if the ratio of the resolution bandwidth to the span is too small (less than 0.002), the **Marker Count Widen Res BW** message appears on the display. It indicates that the resolution bandwidth is too narrow.

### Example:

Increase the resolution and accuracy of the frequency readout on the signal of interest.

1. This example uses the internal 50 MHz alignment signal. Turn it on by pressing **System, 50 MHz osc On Off** and place a marker on the signal.
2. Set the center frequency to 50 MHz and the span to 80 MHz.
3. Press **Freq Count**. (Notice that **Marker Count On Off** has **On** underlined turning the frequency counter on.) The frequency and amplitude of the marker and the word **Counter** will appear in the active function area.
4. Increase the counter resolution by pressing **Resolution Auto Man** and then entering the desired resolution using the step keys or the numbers keypad. For example, press **1 kHz**. The marker counter readout is in the upper-right corner of the screen. The resolution can be set from 1 Hz to 100 kHz.
5. The marker counter remains on until turned off. Turn off the marker counter by pressing **Freq Count**, then **Marker Count On Off** (until **Off** is underlined). (**Marker All Off** also turns the marker counter off.)

Figure 2-9 Using the Marker Counter

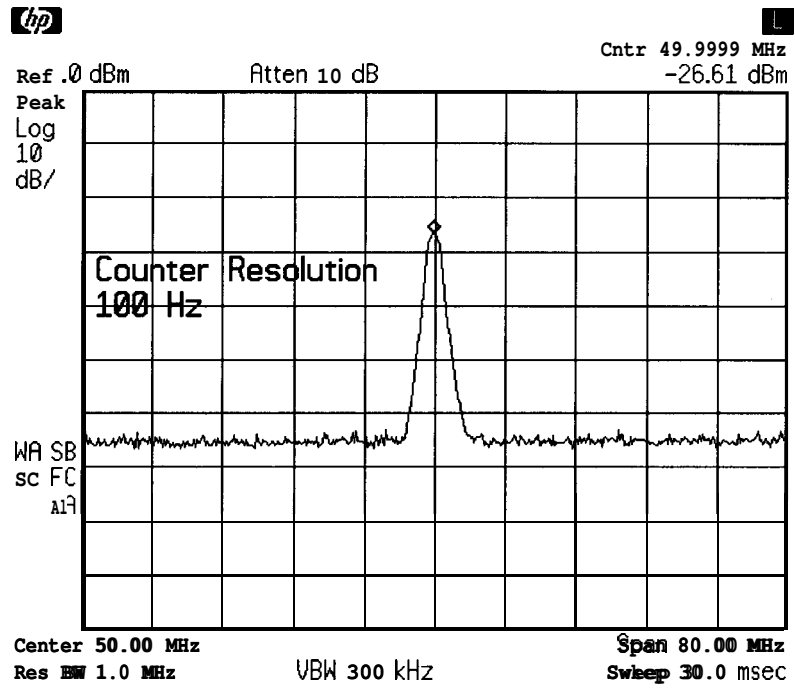

## Decreasing the Frequency Span Around the Signal

Using the spectrum analyzer signal track function, you can quickly decrease the span while keeping the signal at center frequency. This is a fast way to take a closer look at the area around the signal to identify signals that would otherwise not be resolved.

### Example:

Examine a signal in a 200 kHz span.

1. Press **Preset** and use the internal signal as the test signal. To turn it on, press **System, 50 MHz osc On Off**.
2. Press **Peak Search** to place a marker at the peak.
3. Press **Frequency, Signal Track On Off (On)** and the signal will move to the center of the screen, if it is not already positioned there. (Note that the marker must be on the signal before turning signal track on.) Because the signal track function automatically maintains the signal at the center of the screen, you can reduce the span quickly for a closer look. If the signal drifts off of the screen as you decrease the span, use a wider frequency span.
4. Press **Span, 200 kHz**. The span decreases in steps as automatic zoom is completed. See Figure 2-10. You can also use the knob or step keys to decrease the span or use the **Span Zoom** function under **Span**.

Press **Signal Track On Off** again (so that **Off** is underlined) to turn off the signal track function.

Making Basic Measurements  
Decreasing the Frequency Span Around the Signal

NOTE

When you are finished with the example, turn off the signal tracking function.

Figure 2-10 After Zooming In on the Signal

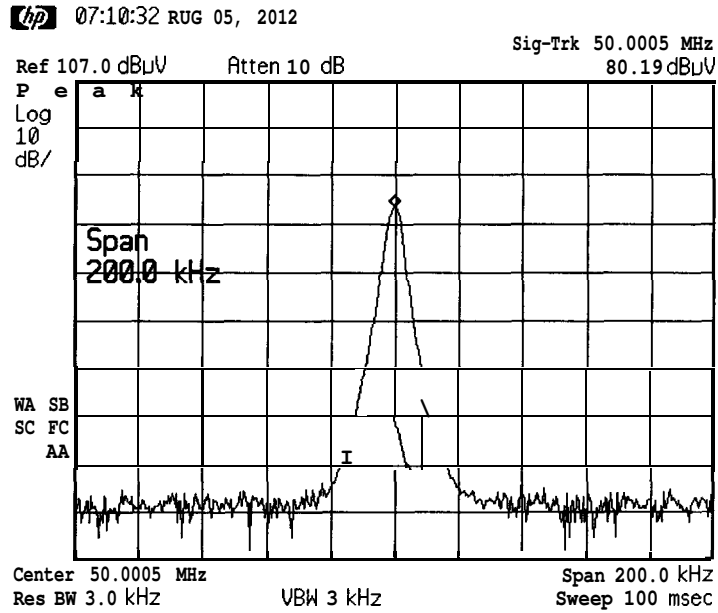

---

## Tracking Unstable Signals

The signal track function is useful for tracking unstable signals that drift with time. The maximum hold function is useful for displaying modulated signals which appear unstable, but have an envelope that contains the information bearing portion of the signal.

**Signal Track On Off** may be used to track these unstable signals. Use **Peak Search** to place a marker on the highest signal on the display. Pressing **Frequency, Signal Track On Off (On)** will bring that signal to the center frequency of the graticule and adjust the center frequency every sweep to bring the selected signal back to the center. (**Span Zoom**, in the **Span** menu, is a quick way to perform the **Peak Search, Frequency, Signal Track On Off, Span** key sequence.)

Note that the primary function of the signal track function is to track unstable signals, not to track a signal as the center frequency of the spectrum analyzer is changed. If you choose to use the signal track function when changing center frequency, check to ensure that the signal found by the tracking function is the correct signal.

### Example 1:

Use the signal track function to keep a drifting signal at the center of the display and monitor its change.

This example requires a modulated signal. An acceptable signal can be easily found by connecting an antenna to the spectrum analyzer input and tuning to the FM broadcast band (88 to 108 MHz). Set the spectrum analyzer center frequency to one of the signals, the span to 20 MHz, the attenuator setting to 0 dB, and the reference level setting to approximately -30 dBm. Your circumstances may be slightly different, depending on building shielding and proximity to transmitters.

1. Connect an antenna to the spectrum analyzer input.
2. Press **Preset, Marker** and move the marker to the peak of one of your local FM broadcast signals. Set the span to 20 MHz.

---

**NOTE**

---

Use a different FM signal source if no FM broadcast signals are available in your area.

3. Press **Amplitude, 30 -dBm, Attenuation Auto Man (Man), 0 +dBm**.
4. Press **Marker, Marker A**, to fix a marker on the signal peak.
5. Press **Span, Span Zoom, 500 kHz**.

Notice that the signal has been held in the center of the display.



**NOTE**

If the signal you selected drifts too quickly for the spectrum analyzer to keep up with, use a wider span.

- The signal frequency drift can be read from the screen if both the signal track and marker delta functions are active. Press **Frequency, Signal Track On Off (On)**. The marker readout indicates the change in frequency and amplitude as the signal drifts. See Figure 2-11.

**Figure 2-11 Using Signal Tracking to Track an Unstable Signal**

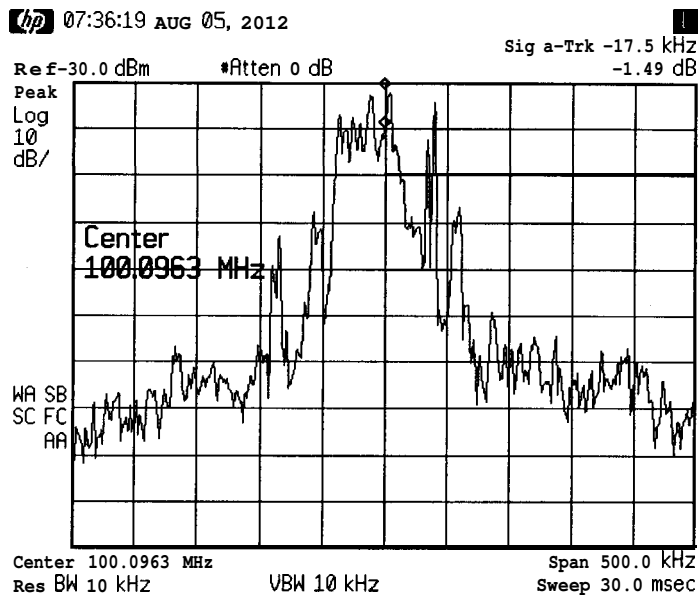

The spectrum analyzer can measure the short- and long-term stability of a source. The maximum amplitude level and the frequency drift of an input signal trace can be displayed and held by using the maximum-hold function. You can also use the maximum hold function if you want to determine how much of the frequency spectrum an FM signal occupies.

**Example 2:**

Using the maximum-hold functions, monitor the envelopes of an FM modulated signal.

- Connect an antenna to the spectrum analyzer input to display the FM broadcast band 88 to 108 MHz.
- Press **Preset, Frequency**, (enter your local FM broadcast signal frequency), and **Span, 20 MHz**.

3. Press **Amplitude**, 30 -dBm, **Attenuation Auto Man**, (Man), 0 +dBm, **Span**, **Span Zoom**, 500 kHz.
4. Turn off the signal track function by pressing **Frequency**, **Signal Track On Off** (Off).
5. To measure the excursion of the signal, press **Trace** then **Max Hold A**. As the signal varies, maximum hold maintains the maximum responses of the input signal, as shown in Figure 2-12.

**Figure 2-12 Viewing an Unstable Signal Using Max Hold A**

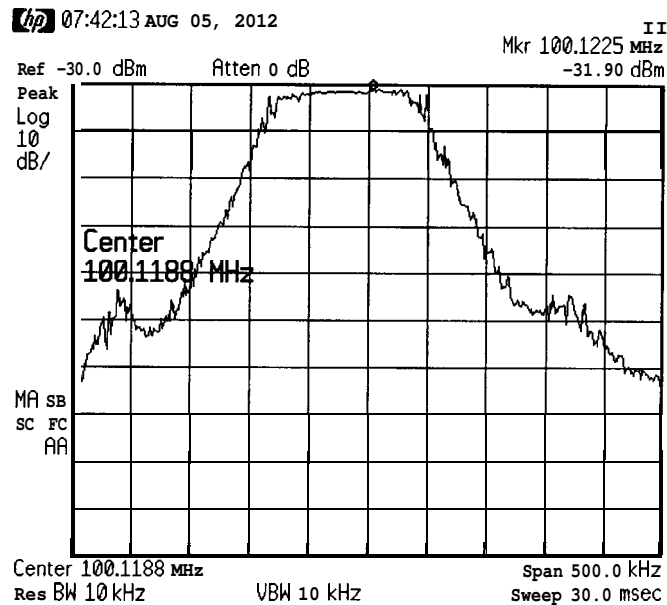

Annotation on the left side of the screen indicates the trace mode. For example, **MA SB SC** indicates trace A is in maximum-hold mode, trace B and trace C are in store-blank mode. See “Screen Annotation” in Chapter 1.

6. Press **Trace**, **Trace A B C**, to select trace B. (Trace B is selected when B is underlined.) Press **Clear Write B** to place trace B in clear-write mode, which displays the current measurement results as it sweeps. Trace A remains in maximum hold mode, showing the frequency shift of the signal.

Figure 2-13 Viewing an Unstable Signal With Max Hold and Clear Write

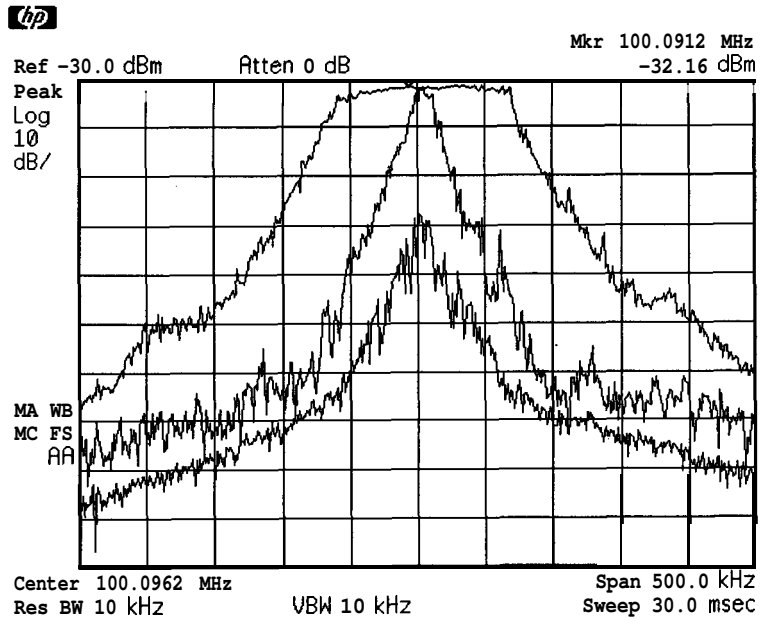

## Measuring Low Level Signals

The spectrum analyzer's ability to measure low level signals is limited by the noise generated inside the spectrum analyzer. A signal may be masked by the noise floor so that it is not visible. This sensitivity to low level signals is affected by the measurement setup.

The spectrum analyzer input attenuator and bandwidth settings affect the sensitivity by changing the signal-to-noise ratio. The attenuator affects the level of a signal passing through the instrument, whereas the bandwidth affects the level of internal noise without affecting the signal. In the first two examples in this section, the attenuator and bandwidth settings are adjusted to view low level signals.

If, after adjusting the attenuation and resolution bandwidth, a signal is still near the noise, visibility can be improved by using the video bandwidth and video averaging functions, as demonstrated in the third and fourth examples.

### Example 1:

If a signal is very close to the noise floor, reducing input attenuation brings the signal out of the noise. Reducing the attenuation to 0 dB maximizes signal power in the spectrum analyzer.

---

**CAUTION**

---

The total power of all input signals at the spectrum analyzer input must not exceed the maximum power level for the spectrum analyzer.

1. Connect an antenna to the spectrum analyzer input. Press **Preset**.
2. Reduce the frequency range to locate a low level signal of interest. Narrow the frequency span to a range of 88 MHz to 108 MHz, the FM broadcast range. Press **Frequency**, **Start Freq**, **88 MHz**, **Stop Freq**, **108 MHz**.
3. Place a marker on the low level signal of interest. Press **Marker** and use the knob to position the marker at the signal's peak.
4. Place the signal at center frequency by pressing **Search**, then **Marker -> CF**.
5. Reduce the span to 10 MHz. Press **Span**, and then use the step-down key ( $\downarrow$ ). See Figure 2-14.

Figure 2-14 Low-Level Signal

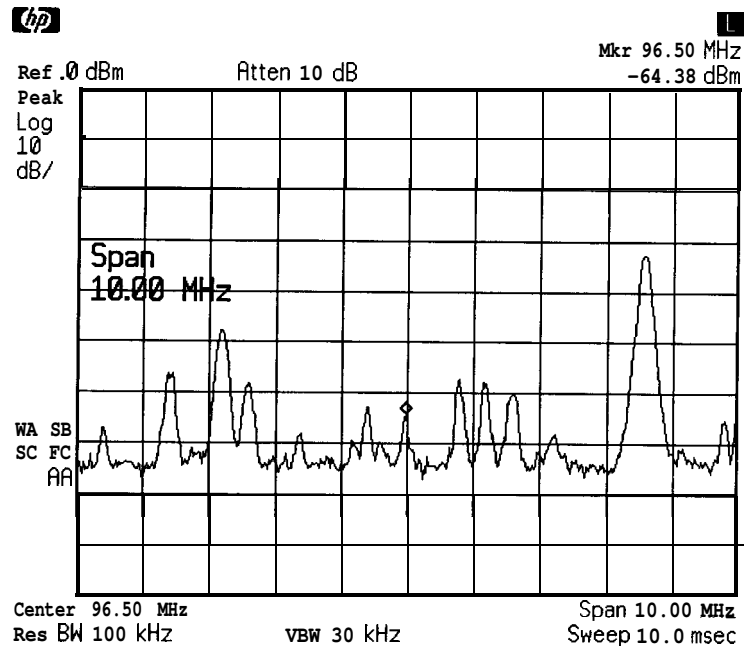

6. Press **Amplitude, Attenuation Auto Man**. Press the step-up key ( $\uparrow$ ) twice to select **20 dB** attenuation. Increasing the attenuation moves the noise floor closer to the signal.

A # mark appears next to the **Atten** annotation at the top of the display, indicating the attenuation is no longer coupled to other spectrum analyzer settings.

7. To see the signal more clearly, enter **0 dB**. Zero attenuation makes the signal more visible. Note that the reference level changed to **-10 dBm**, the highest level allowed with **0 dB** attenuation. See Figure 2-15.

Before connecting other signals to the spectrum analyzer input, increase the RF attenuation to protect the spectrum analyzer input: press **Attenuation Auto Man** so that **Auto** is underlined or press **Auto Couple**.

Figure 2-15 Using 0 dB Attenuation

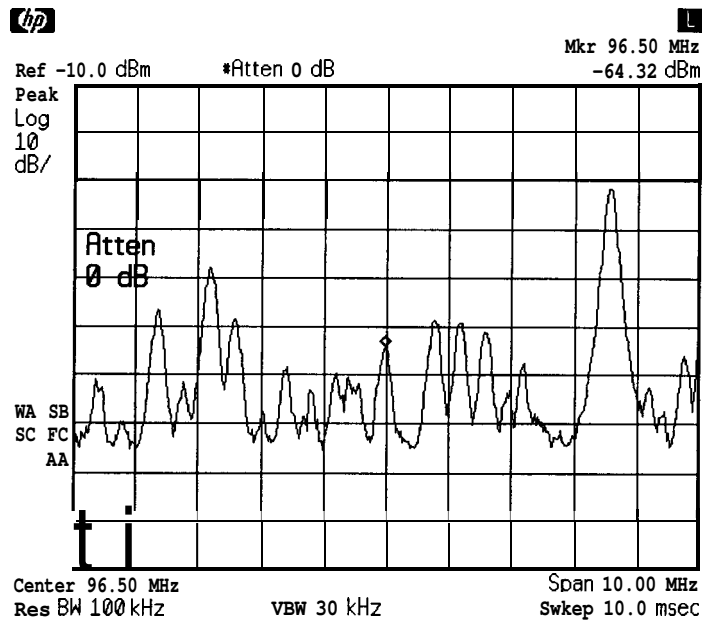

### Example 2:

The resolution bandwidth can be decreased to view low level signals.

1. As in the previous example, connect an antenna to the spectrum analyzer input. Set the spectrum analyzer to view a low level signal.
2. Press **BW/Avg**, then ↓. The low level signal appears more clearly because the noise level is reduced. See Figure 2-16.

Figure 2-16 Decreasing Resolution Bandwidth

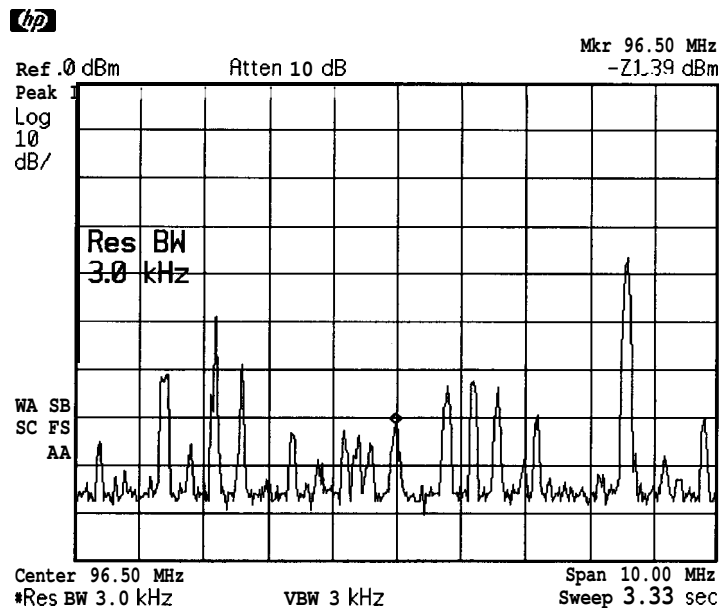

A # mark appears next to the **Res BW** annotation at the lower left corner of the screen, indicating that the resolution bandwidth is uncoupled.

As the resolution bandwidth is reduced, the sweep time is increased to maintain calibrated data.

### Example 3:

Narrowing the video filter can be useful for noise measurements and observation of low level signals close to the noise floor. The video filter is a post-detection low-pass filter that smooths the displayed trace. When signal responses near the noise level of the spectrum analyzer are visually masked by the noise, the video filter can be narrowed to smooth this noise and improve the visibility of the signal. (Reducing video bandwidths requires slower sweep times to keep the spectrum analyzer calibrated.)

Using the video bandwidth function, measure the amplitude of a low level signal.

1. As in the first example, connect an antenna to the spectrum analyzer input. Set the spectrum analyzer to view a low level signal.
2. Narrow the video bandwidth by pressing **BW/Avg, Video BW Auto Man**, and the step-down key ( $\downarrow$ ). This clarifies the signal by smoothing the noise, which allows better measurement of the signal amplitude.

A “#” mark appears next to the **VBW** annotation at the bottom of the screen, indicating that the video bandwidth is not coupled to the resolution bandwidth. See Figure 2-17.

Instrument preset conditions couple the video bandwidth to the resolution bandwidth so that the video bandwidth is equal to, or narrower than, the resolution bandwidth. If the bandwidths are uncoupled when video bandwidth is the active function, pressing **Video BW Auto Man** (so that Auto is underlined) recouples the bandwidths.

---

**NOTE** The video bandwidth must be set wider than the resolution bandwidth when measuring impulse noise levels.

---

**Figure 2-17** Decreasing Video Bandwidth

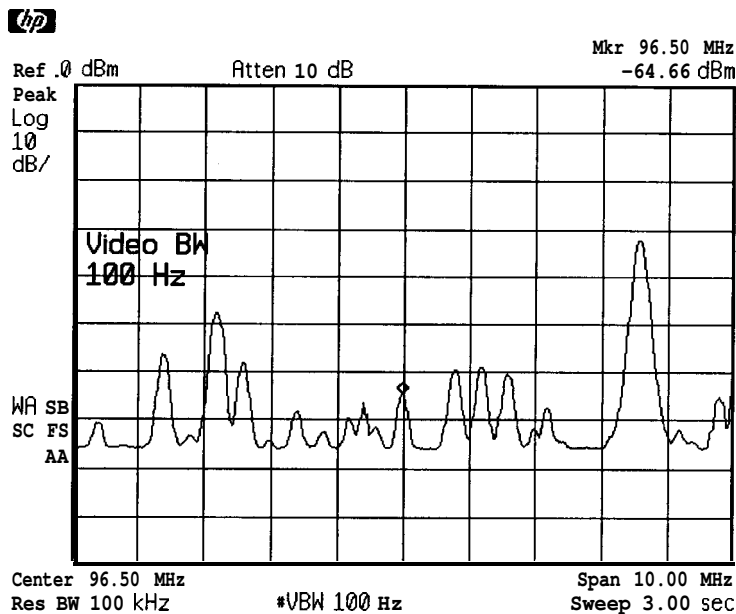

**Example 4:**

If a signal level is very close to the noise floor, video averaging is another way to make the signal more visible.

---

**NOTE** The time required to construct a full trace that is averaged to the desired degree is approximately the same when using either the video bandwidth or the video averaging technique. The video bandwidth technique completes the averaging as a slow sweep is taken, whereas the video averaging technique takes many sweeps to complete the average. Characteristics of the signal being measured, such as drift and duty cycle, determine which technique is appropriate.

---



Video averaging is a digital process in which each trace point is averaged with the previous trace-point average. Selecting video averaging changes the detection mode from peak to sample. The result is a sudden drop in the displayed noise level. The sample mode displays the instantaneous value of the signal at the end of the time or frequency interval represented by each display point, rather than the value of the peak during the interval. Sample mode is not used to measure signal amplitudes accurately because it may not find the true peak of the signal.

Video averaging clarifies low-level signals in wide bandwidths by averaging the signal and the noise. As the spectrum analyzer takes sweeps, you can watch video averaging smooth the trace.

1. Position a low-level signal on the spectrum analyzer screen.
2. Press **BW/Avg**, then **Video Average On Off**. When **On** is underlined, the video averaging routine is initiated. As the averaging routine smooths the trace, low level signals become more visible. **Vid Avg 100** appears in the active function block. The number represents the number of samples (or sweeps) taken to complete the averaging routine.
3. To set the number of samples, use the numbers keypad. For example, press **Video Average On Off** (so that **On** is underlined), **25 Enter**. Turn video averaging off and on again by pressing **Video Average On Off (Off)**, **Video Average On Off (On)**. The number of samples equals the number of sweeps in the averaging routine.

During averaging, the current sample number appears at the left side of the graticule. Changes in active functions settings, such as the center frequency or reference level, will restart the sampling. The sampling will also restart if video averaging is turned off and then on again.

Once the set number of sweeps has been completed, the spectrum analyzer continues to provide a running average based on this set number.

Figure 2-18 Using the Video Averaging Function

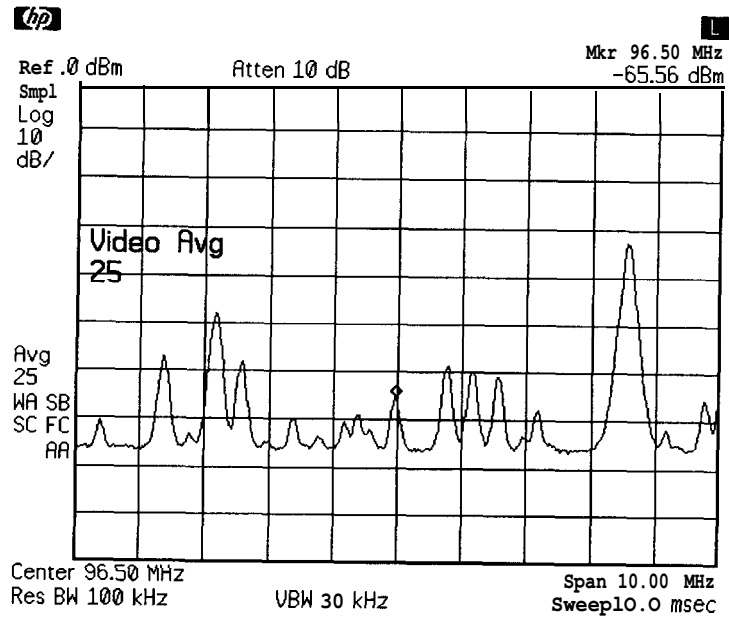

## Identifying Distortion Products

### Distortion from the Analyzer

High level input signals may cause spectrum analyzer distortion products that could mask the real distortion measured on the input signal. Using trace B and the RF attenuator, you can determine which signals, if any, are internally generated distortion products.

#### Example:

Using a signal from a signal generator, determine whether the harmonic distortion products are generated by the spectrum analyzer.

1. Connect a signal generator to the spectrum analyzer INPUT. Set the signal generator frequency to 200 MHz and the amplitude to 0 dBm.

Set the center frequency of the spectrum analyzer to 400 MHz and the span to 500 MHz: press **Frequency, 400 MHz, Span 500 MHz**. The signal shown in Figure 2-19 produces harmonic distortion products in the spectrum analyzer input mixer.

Figure 2-19 Harmonic Distortion

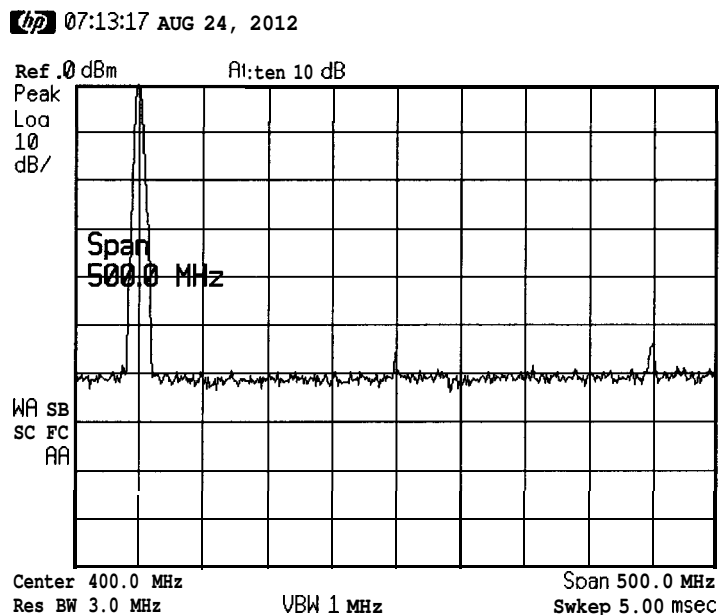

2. Change the center frequency to the value of one of the observed harmonics.

3. Change the span to 200 MHz: press **Span, 200 MHz**.
4. Change the attenuation to 0 dB: press **Amplitude, Attenuation Auto Man, 0 dBm**.
5. To determine whether the harmonic distortion products are generated by the spectrum analyzer, first save the screen data in trace B.

Press **Trace, Trace A B C** (until trace B is underlined), then **Clear Write B**. Allow the trace to update (two sweeps) and press **View B, Peak Search, Marker, Marker A**. The spectrum analyzer display shows the stored data in trace B and the measured data in trace A.

6. Next, increase the RF attenuation by 10 dB: press **Amplitude, Attenuation Auto Man**, and the step-up key ( $\uparrow$ ) twice. See Figure 2-20.

**Figure 2-20 RF Attenuation of 10 dB**

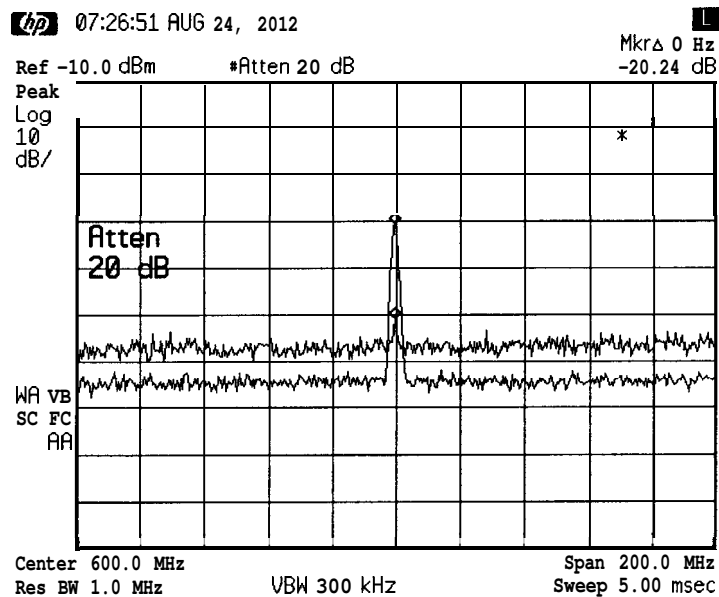

7. Compare the response in trace A to the response in trace B. If the distortion product decreases as the attenuation increases, then it is caused by the spectrum analyzer.

The change in the distortion product is shown by the marker A value. The high level input signals that are overloading the input and causing the internal distortion, must be attenuated.

If the responses in trace A and trace B differ, as in Figure 2-20, then attenuation is required. If there is no change in the signal level, the distortion is not caused internally. For example, the signal that is

causing the distortion shown in Figure 2-21 is not high enough in amplitude to cause internal distortion in the spectrum analyzer so any distortion that is displayed is present on the input signal.

**Figure 2-21** No Harmonic Distortion

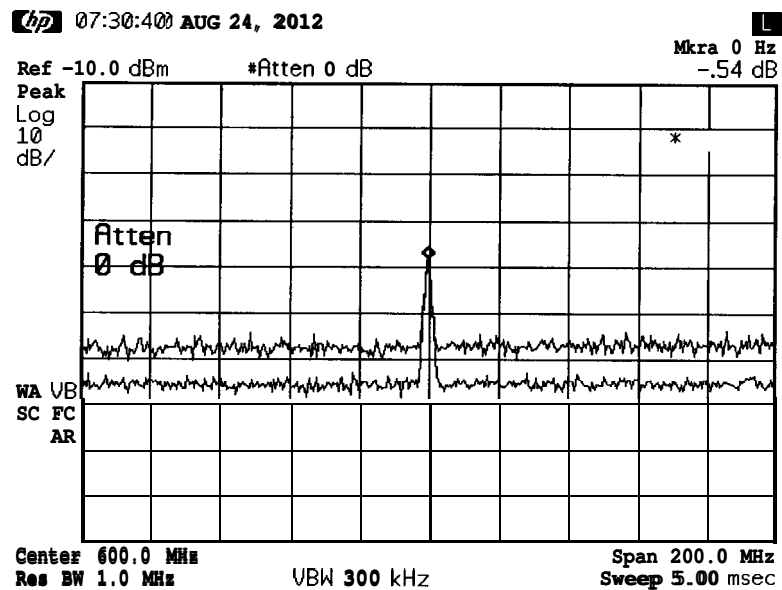

### Third-Order Intermodulation Distortion

Two-tone, third-order intermodulation distortion is a common problem in communication systems. When two signals are present in a system, they can mix with the second harmonics generated and create third-order inter-modulation distortion products, that are located close to the original signals. These distortion products are generated by system components such as amplifiers and mixers.

#### Example:

Test a device for third-order intermodulation. This example uses two sources, one set to 300 MHz and the other to approximately 301 MHz. (Other source frequencies may be substituted, but try to maintain a frequency separation of approximately 1 MHz.)

1. Connect the equipment as shown in Figure 2-22.

Figure 2-22 Third-Order Intermodulation Equipment Setup

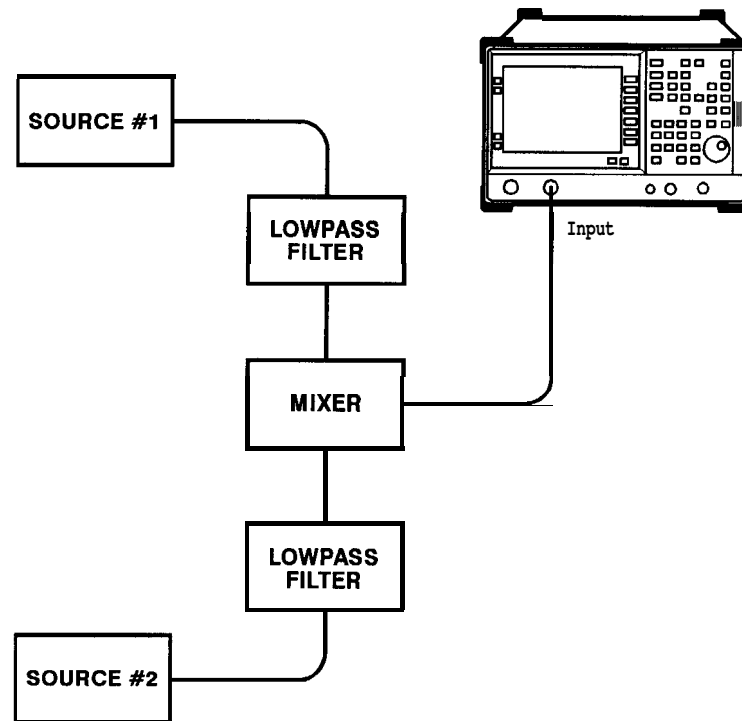

bn72a

2. Set one source to 300 MHz and the other source to 301 MHz, for a frequency separation of 1 MHz. Set the sources equal in amplitude (in this example, they are set to -5 dBm).
3. Tune both signals onto the screen by setting the center frequency between 300 and 301 MHz. Then, using the knob, center the two signals on the display. Reduce the frequency span to 5 MHz. This should be wide enough to include the distortion products on the screen. To be sure the distortion products are resolved, reduce the resolution bandwidth until the distortion products are visible.
4. For best dynamic range, set the mixer input level to -40 dBm and move the signal to the reference level: press **Amplitude, More, Max Mixer Lvl, 40 -dBm**.

The spectrum analyzer automatically sets the attenuation so that a signal at the reference level will be a maximum of -40 dBm at the input mixer. Press **BW/Avg, Resolution BW**, and then use the step-down key ( $\downarrow$ ) to reduce the resolution bandwidth until the distortion products are visible.

5. To measure a distortion product, press **Marker** to place a marker on a source signal. To activate the second marker, press **Marker A**. Using the knob, adjust the second marker to the peak of the distortion product that is beside the test signal. The difference between the markers is displayed in the active function block.

Making Basic Measurements  
Identifying Distortion Products

To measure the other distortion product, press **Search, Next Peak**. This places a marker on the next highest peak, which, in this case, is the other source signal. To measure the difference between this test signal and the second distortion product, press **Marker A** and use the knob to adjust the second marker to the peak of the second distortion product. See Figure 2-23.

**Figure 2-23**      **Measuring the Distortion Product**

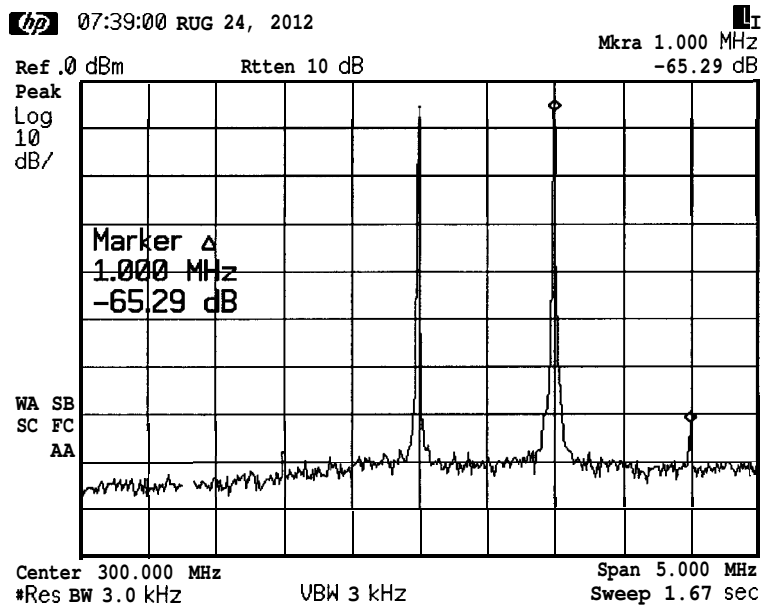

## Demodulating AM Signals (Using the Analyzer As a Fixed Tuned Receiver)

The zero span mode can be used to recover amplitude modulation on a carrier signal. The spectrum analyzer operates as a fixed-tuned receiver in zero span to provide time domain measurements.

Center frequency in the swept-tuned mode becomes the tuned frequency in zero span. The horizontal axis of the screen becomes calibrated in time, rather than frequency. Markers display amplitude and time values.

The following functions establish a clear display of the waveform:

- Trigger stabilizes the waveform trace on the display by triggering on the modulation envelope. If the signal's modulation is stable, video trigger synchronizes the sweep with the demodulated waveform.
- Linear mode should be used in amplitude modulation (AM) measurements to avoid distortion caused by the logarithmic amplifier when demodulating signals.
- Sweep time adjusts the full sweep time from 5 ms to 2000 s. The sweep time readout refers to the full 10-division graticule. Divide this value by 10 to determine sweep time per division.
- Resolution and video bandwidth are selected according to the signal bandwidth.

Each of the coupled function values remains at its current value when zero span is activated. Video bandwidth is coupled to resolution bandwidth. Sweep time is not coupled to any other function.

---

**NOTE**

---

Refer to “Demodulating and Listening to an AM Signal” on page 65 for more information on signal demodulation.

### Example:

View the modulation waveform of an AM signal in the time domain.

1. To obtain an AM signal, you can either connect a source to the spectrum analyzer input and set the source percent modulation, or connect an antenna to the spectrum analyzer input and tune to a commercial AM broadcast station. This example uses a source. (If you are using a commercial broadcast station as your signal, press **Det/Demod**, **Demod**, and **AM** to turn on AM demodulation. Then press **Done**, **Speaker On Off (On)**, and the spectrum analyzer will operate as a radio.)



## Making Basic Measurements

### Demodulating AM Signals (Using the Analyzer As a Fixed Tuned Receiver)

2. First, center and zoom in on the signal in the frequency domain. See “Decreasing the Frequency Span Around the Signal” on page 31. Be sure to turn off the signal track function, since it must be off for zero span operation. See Figure 2-24.

**Figure 2-24 Viewing an AM Signal**

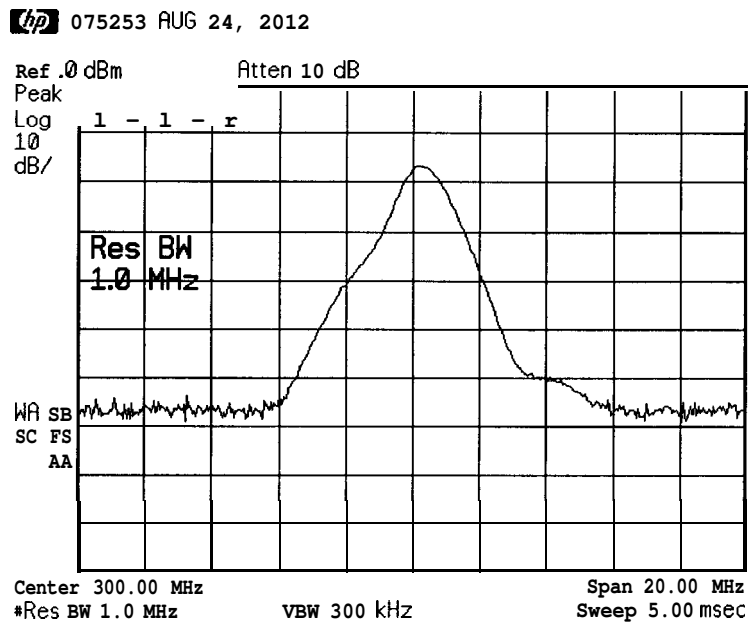

3. To demodulate the **AM**, press **BW/Avg**. Increase the resolution bandwidth to include both sidebands of the signal within the passband of the spectrum analyzer.
4. Next, position the signal peak near the reference level and select a linear voltage display **Press Amplitude**, and change the reference level, then press **Scale Log Lin** to underline **Lin**.
5. To select zero span, either press **Span, 0 Hz**, or press **Zero Span**. See Figure 2-25. If the modulation is a steady tone, for example from a signal generator, use video trigger to trigger on the waveform and stabilize the display (If you are viewing an off-the-air signal you will not be able to stabilize the waveform.) Adjust the sweep time to change the horizontal scale.

Use markers and delta markers to measure the time parameters of the waveform.

Figure 2-25 Measuring Modulation In Zero Span

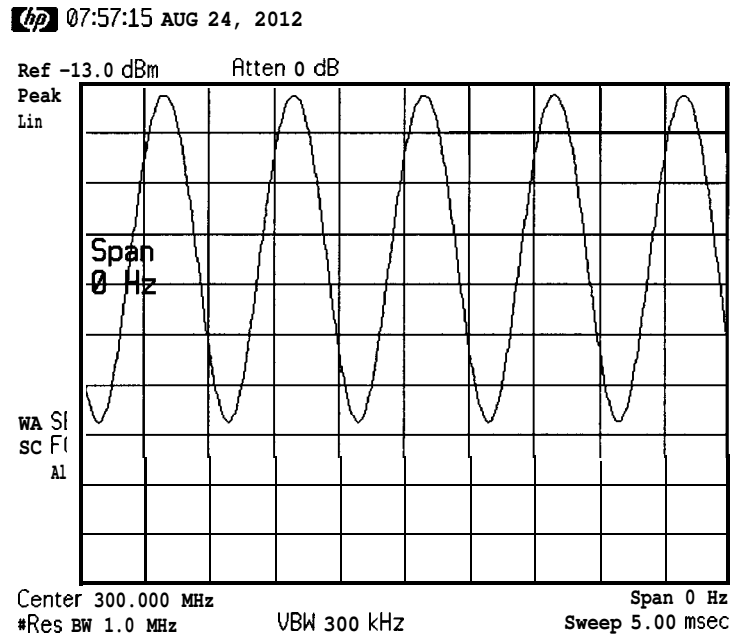

---

## **3 Making Measurements**

## What's in This Chapter

- “Making Stimulus Response Measurements” on page 55
- “Demodulating and Listening to an AM Signal” on page 65
- “Measuring Third Order Inter-modulation Distortion” on page 72
- “Measuring Percent Amplitude Modulation” on page 70
- “Measuring Percent Amplitude Modulation” on page 70
- “Measuring Third Order Intermodulation Distortion” on page 72

To find descriptions of specific spectrum analyzer functions refer to the user's guide.

## Making Stimulus Response Measurements

### What Are Stimulus Response Measurements?

Stimulus response measurements require a source to stimulate a device under test (DUT), a receiver to analyze the frequency response characteristics of the DUT, and, for return loss measurements, a directional coupler. Characterization of a DUT can be made in terms of its transmission or reflection parameters. Examples of transmission measurements include flatness and rejection. Return loss is an example of a reflection measurement.

A spectrum analyzer combined with a tracking generator forms a stimulus response measurement system. With the tracking generator as the swept source and the spectrum analyzer as the receiver, operation is the same as a single channel scalar network analyzer. The tracking generator's output frequency must be made to precisely track the spectrum analyzer input frequency for good narrow band operation. A narrow band system has a wide dynamic measurement range. This wide dynamic range will be illustrated in the following example.

### Using A Spectrum Analyzer With A Tracking Generator

There are three basic steps in performing a stimulus response measurement, whether it is a transmission or a reflection measurement. The steps are to set all the spectrum analyzer settings, normalize, and measure.

The procedure below describes how to use a built in tracking generator system to measure the rejection of a low pass filter, which is a type of transmission measurement. Illustrated in this example are functions in the tracking generator menu such as adjusting the tracking generator output power. Normalization functions located in the trace menu are also used. Making a reflection measurement is similar and is covered in "Making a Reflection Calibration Measurement" on page 62. Refer to the *HP Spectrum Analyzer Seminar* (HP part number 5958-6564) for more information.

### Stepping Through a Transmission Measurement

1. To measure the rejection of a low pass filter, connect the equipment as shown in Figure 3-2. This example uses a filter with a cut off frequency of 300 MHz as the DUT.

**Figure 3-1**      **Transmission Measurement Test Setup**

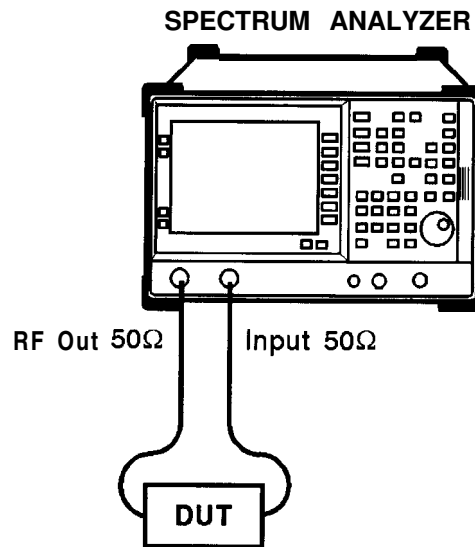

bn73a

2. Access the tracking generator functionality using the source key on the spectrum analyzer. To activate the tracking generator power level, press **Source Amptd**. See Figure 3-2.

---

**CAUTION**

Excessive signal input may damage the DUT. Do not exceed the maximum power that the device under test can tolerate.

---

**NOTE**

To reduce ripples caused by source return loss, use 10 dB or greater tracking generator output attenuation. Tracking generator output attenuation is normally a function of the source power selected. However, the output attenuation may be controlled in the **Source Amptd** menu. Refer to specifications and characteristics in your user's and calibration guide for more information on the relationship between source power and source attenuation.

Figure 3-2 Tracking Generator Output Power Activated

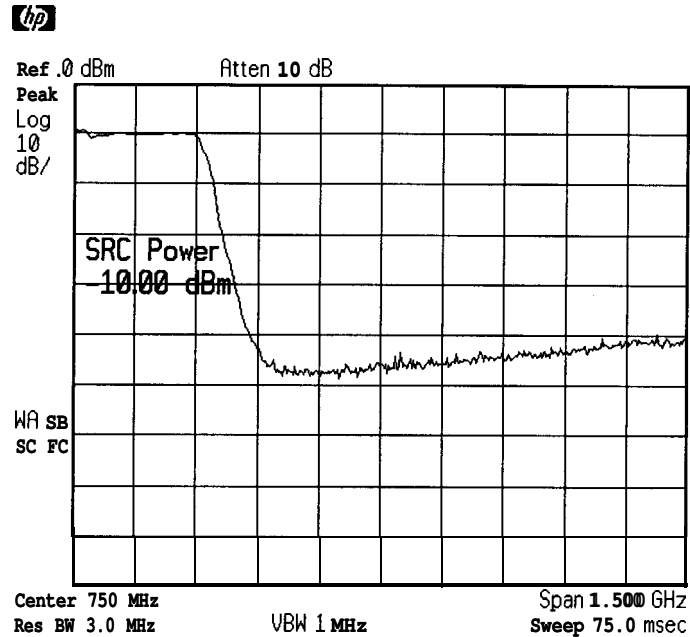

- Put the sweep time of the analyzer into stimulus response auto coupled mode by pressing **Sweep**, then **Swp Coupling SR SA** until **SR** (stimulus response mode) is underlined. Auto coupled sweep times are usually much faster for stimulus response measurements than they are for spectrum analyzer measurements.

**NOTE**

In the stimulus response mode, the  $Q$  of the DUT can determine the fastest rate at which the spectrum analyzer can be swept. ( $Q$  is the quality factor, which is reactance versus resistance.) To determine whether the analyzer is sweeping too fast, slow the sweep time and note whether there is a frequency or amplitude shift of the trace. Continue to slow the sweep time until there is no longer a frequency or amplitude shift.

- Since we are only interested in the rejection of the low pass filter, tune the spectrum analyzer center frequency and span so that the roll-off of the filter comprises the majority of the trace on the display See Figure 3-3.

**Figure 3-3**      **Spectrum Analyzer Settings According to the Measurement Requirement**

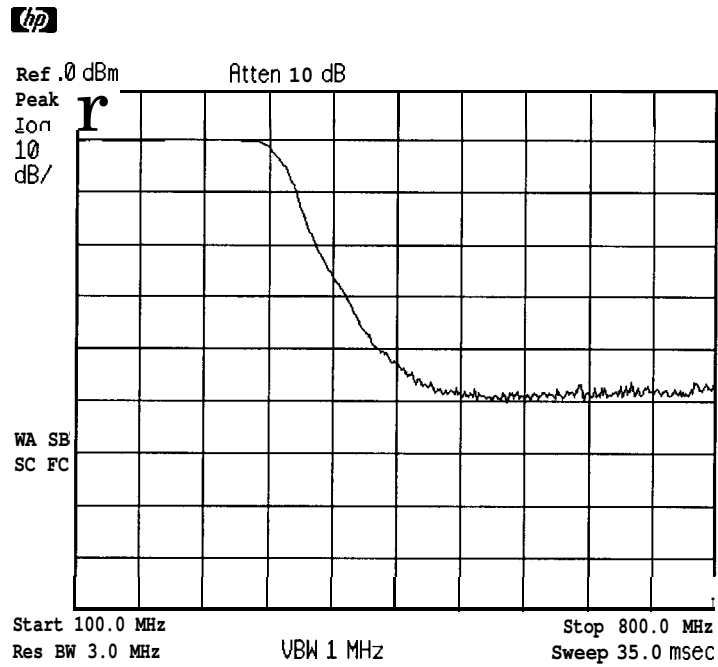

5. Decrease the resolution bandwidth to increase sensitivity, and narrow the video bandwidth to smooth the noise. In Figure 3-4, the resolution bandwidth has been decreased to 10 kHz.



Figure 3-4 Decrease the Resolution Bandwidth to Improve Sensitivity

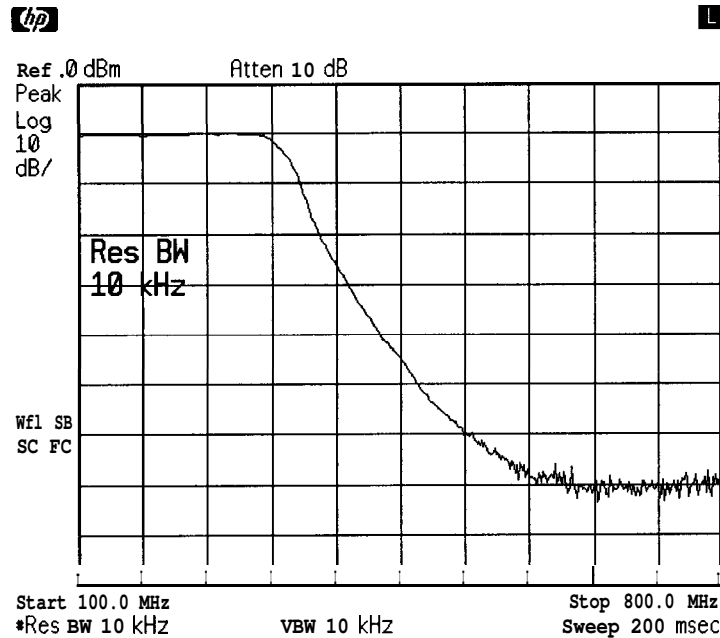

- To make a transmission measurement accurately, the frequency response of the test system must be known. Normalization is then used to eliminate this error from the measurement. To measure the frequency response of the test system, connect the cable (but not the DUT) from the tracking generator output to the spectrum analyzer input. Press **Trace**, **Normalize**, **Normalize On Off** so that **On** is underlined. The frequency response of the test system is automatically stored in trace B and a normalization is performed. This means that the active displayed trace is now the ratio of the input data to the data stored in trace B.

When normalization is on, trace math is being performed on the active trace. The trace math performed is (trace A - trace B + the normalized reference position), with the result placed into trace A. Remember that trace A contains the measurement trace, trace B contains the stored calibration trace of the system frequency response, and normalized reference position is indicated by arrowheads at the edges of the graticule.

**NOTE**

Since the calibration trace is stored in trace B, changing trace B to Clear Write will invalidate the normalization.

- Reconnect the DUT to the spectrum analyzer. Note that the units of the reference level have changed to **dB**, indicating that this is now a relative measurement. Press **Norm Ref Posn** to change the normalized reference position. Arrowheads at the left and right edges of the graticule mark the normalized reference position, or the

Making Measurements  
Making Stimulus Response Measurements

position where 0 dB insertion loss (transmission measurements) or 0 dB return loss (reflection measurements) will normally reside. Using the knob results in a change in the position of the normalized trace, within the range of the graticule.

8. To measure the rejection of the filter at a given frequency, press **Marker**, and enter the frequency. For example, enter 350 MHz. The marker readout displays the rejection of the filter at 350 MHz. See Figure 3-5.

**NOTE**

Due to the horizontal resolution of the trace, the marker frequency value will be rounded to within 0.25% of the span of the value entered.

**Figure 3-5 Measure the Rejection Range**

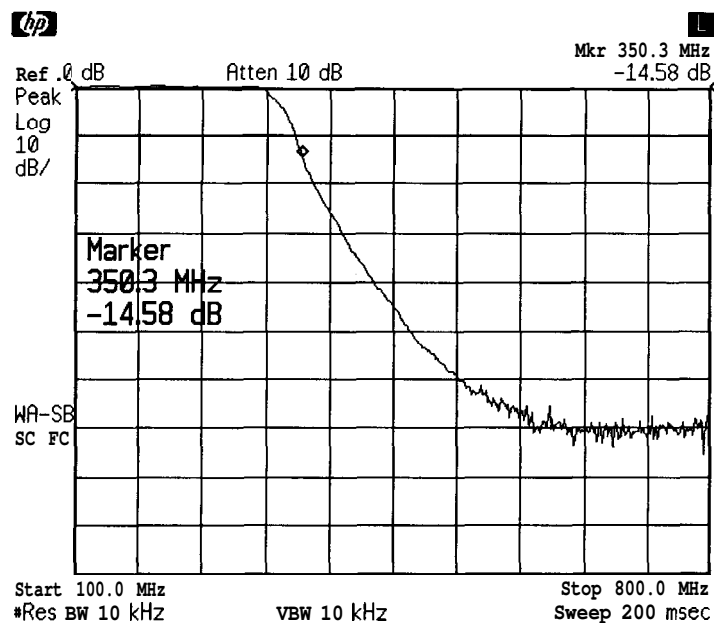

### Tracking Generator Unleveled Condition

When using the tracking generator, the message **TG unleveled** may appear. The **TG unleveled** message indicates that the tracking generator source power (**Source Amptd**, **Amplitude On Off**) could not be maintained at the selected level during some portion of the sweep. If the unleveled condition exists at the beginning of the sweep, the message will be displayed immediately. If the unleveled condition occurs after the sweep begins, the message will be displayed after the sweep is completed. A momentary unleveled condition may not be detected when the sweep time is small. The message will be cleared after a sweep is completed with no unleveled conditions.

The unleveled condition may be caused by any of the following:

- Start frequency is too low or the stop frequency is too high. The unlevelled condition is likely to occur if the true frequency range exceeds the tracking generator frequency specification (especially the low frequency specification).
- Source attenuation may be set incorrectly (select **Attenuation Auto Man (Auto)** for optimum setting).
- The source power may be set too high or too low, use **Amplitude On Off** to reset it.
- The source power sweep may be set too high, resulting in an unlevelled condition at the end of the sweep. Use **Power Sweep On Off** to decrease the amplitude.
- Reverse RF power from the device under test detected by the tracking generator ALC (automatic level control) system.

---

## Making a Reflection Calibration Measurement

The calibration standard for reflection measurements is usually a short circuit connected at the reference plane (the point at which the test device will be connected.) See Figure 3-6. A short circuit has a reflection coefficient of 1 (0 dB return loss). It reflects all incident power and provides a convenient 0 dB reference.

**Figure 3-6** Reflection Measurement Short Calibration Test Setup

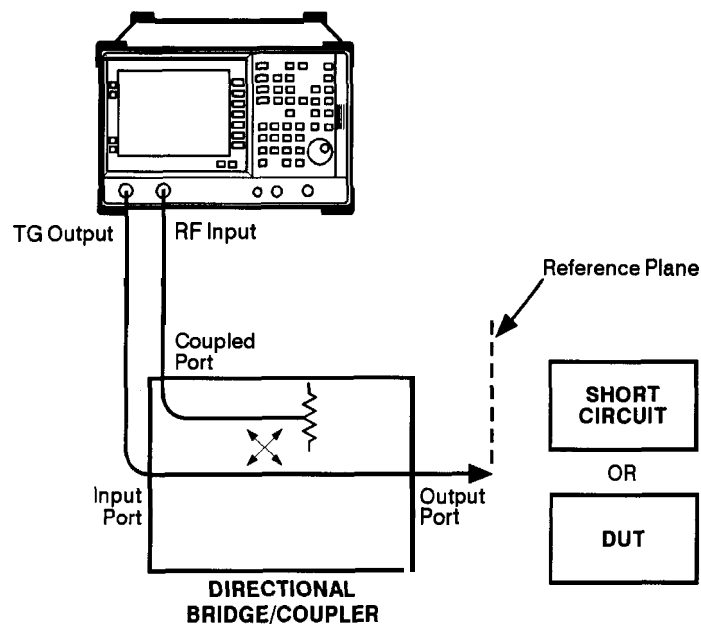

bn74a

### Example:

Measure the return loss of a filter. The following procedure makes a reflection measurement using a coupler or directional bridge.

### Reflection Calibration

---

**NOTE**

The spectrum analyzer center frequency and span for this measurement can easily be set up using the transmission measurement setup in “Making Stimulus Response Measurements” on page 55. Tune the spectrum analyzer so that the passband of the filter comprises a majority of the display, then proceed with the steps outlined below.

---

1. Connect the DUT to the directional bridge or coupler as shown in Figure 3-6. Terminate the unconnected port of the DUT.

---

NOTE

If possible, use a coupler or bridge with the correct test port connector for both calibrating and measuring. Any adapter between the test port and DUT degrades coupler/bridge directivity and system source match. Ideally, you should use the same adapter for the calibration and the measurement. Be sure to terminate the second port of a two port device.

---

2. Connect the tracking generator output of the spectrum analyzer to the **input** port of a directional bridge or coupler.
3. Connect the spectrum analyzer input to the **coupled** port of a directional bridge or coupler.
4. Set center frequency, span, and other spectrum analyzer settings. Turn on the tracking generator and set the amplitude level by pressing **Source Amptd, Amplitude On Off (On)**.
5. Replace the DUT with a short circuit.
6. Normalize the trace by pressing **Trace, Normalize**. Then set **Normalize On Off** to On, to activate the trace A minus trace B function and display the results in trace A. The normalized trace or flat line represents 0 dB return loss. Normalization occurs each sweep. Replace the short circuit with the DUT.

---

NOTE

Since the calibration trace is stored in trace B, changing trace B to Clear Write will invalidate the normalization.

---

## Measuring the Return Loss

- After calibrating the system with the above procedure, reconnect the filter in place of the short circuit without changing any spectrum analyzer settings.
- Use the marker to read return loss. Press **Marker** and position the marker with the knob to read the return loss at that frequency. See Figure 3-7.

Figure 3-7 Measuring the Return Loss of the Filter

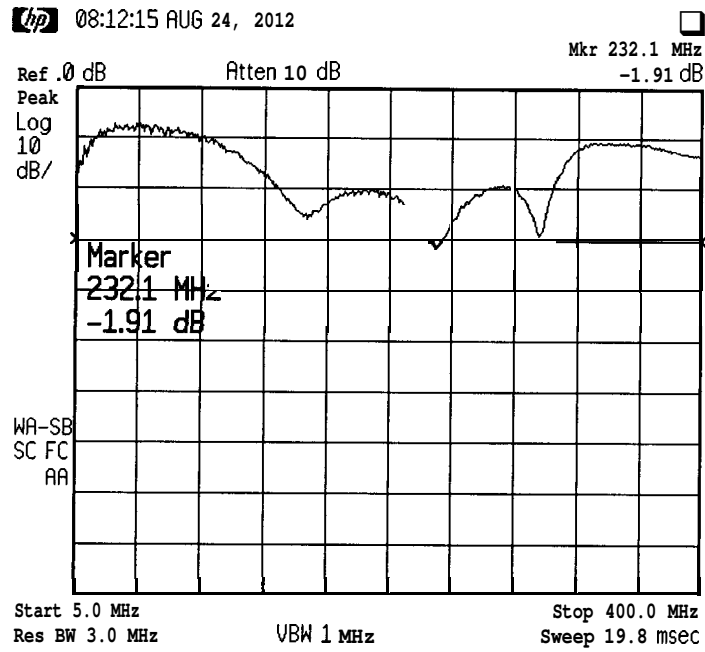

---

## Demodulating and Listening to an AM Signal

The functions listed in the menu under **Det/Demod** allow you to demodulate and hear signal information displayed on the spectrum analyzer. Simply place a marker on a signal of interest, activate AM demodulation, turn the speaker on, and then listen.

### Example:

1. Connect an antenna to the spectrum analyzer input.
2. Select a frequency range on the spectrum analyzer, such as the range for AM radio broadcasts. For example, the frequency range for AM broadcasts in the United States is 550 kHz to 1650 kHz. Press **Preset, Frequency, Start Freq, 550 kHz, Stop Freq, 1650 kHz**.
3. Place a marker on the signal of interest by using **Peak Search** to place a marker on the highest amplitude signal, or by pressing **Marker, Marker Normal** and moving the marker to a signal of interest.
4. Press **Det/Demod, Demod, AM**. Use the front panel volume knob to control the speaker's volume. (**Speaker On Off** is set to On by the preset function.)

---

#### NOTE

The AM demodulation function can also be used to listen to an FM signal.

- a. First find an FM signal in the FM band (88 to 108 MHz, in the US.)
- b. Make sure that the resolution bandwidth is set to 100 kHz by either setting the span to 10 MHz, or by directly setting the resolution bandwidth.
- c. Adjust the reference level until FM broadcast signals can be seen on the display
- d. Place the marker on the skirt (off of the peak) of a strong FM signal.
- e. Turn on the speaker and the AM demodulation. The FM signal can be heard on the speaker. This example uses an AM detector to do slope detection on an FM signal.

Figure 3-8 Demodulation of an AM Signal

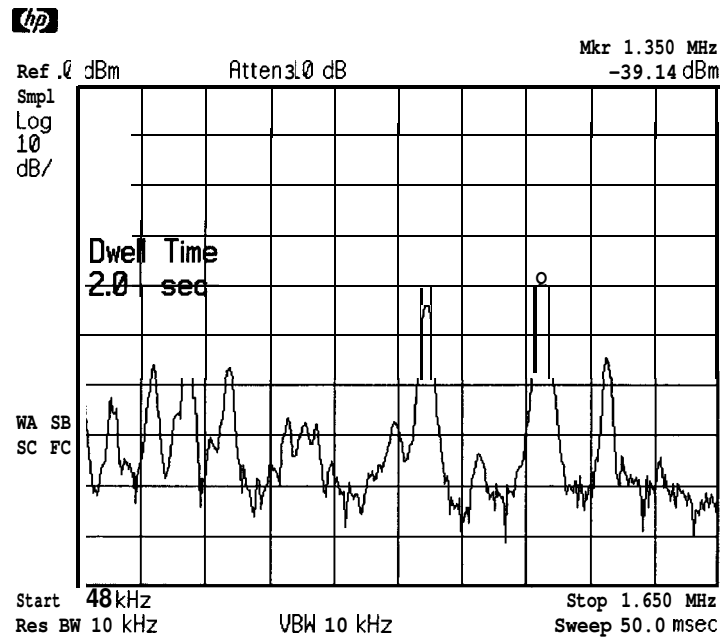

5. The signal is demodulated at the marker's position only for the duration of the dwell time. Use the step keys, knob, or numbers keypad to change the dwell time. For example, press the step up key ( $\uparrow$ ) to increase the dwell time to 2 seconds. Notice that you can hear the demodulated signal for a longer period of time.
6. The marker search functions can be used to move the marker to other signals of interest. Press **Search** to access **Next Peak**, **Next Pk Right**, or **Next Pk Left**.

### Example:

1. Place the marker on a signal of interest as in steps 1 through 3 of the previous example.
2. If the signal of interest is the highest amplitude on screen signal, set the frequency of the signal to center frequency by pressing **Frequency** then **Signal Track On Off (On)**. If it is not the highest amplitude signal on screen, move the signal to center screen by pressing **Search** and **Marker -> CF**.
3. If signal track function is on, press **Span** and 1 MHz to reduce the span to 1 MHz. If signal track is not used, use the step down key ( $\downarrow$ ) to reduce the span and use **Marker -> CF** to keep the signal of interest at center screen.
4. Set the span to zero by pressing **Zero Span**. **Zero Span** turns off the marker track function.



5. Change the resolution bandwidth to 100 kHz by pressing **BW/Avg** and entering 100 kHz.
6. Set the signal in the top two divisions of the screen by changing the reference level. Press **Amplitude**, and then the step down key (↓) until the signal is in the top two divisions. Set the amplitude scale to linear by pressing **Scale Log Lin** so that **Lin** is under lined.
7. Press **Det/Demod, Demod, AM**. Use the front panel volume knob to control the speaker's volume. (**Speaker On Off** is set to On by the preset function.)

**NOTE**

The signal to the speaker will be interrupted during retrace because the analyzer is performing automatic alignment routines. You can turn off the alignment by pressing **System, Alignments, Auto Align, Off**. Refer to the specifications for information about operating the analyzer with the alignments turned off.

8. To eliminate the clicks between sweeps, turn the auto alignment function off by pressing **System, Alignments, Auto Align, Off**.

**Figure 3-9**

**Continuous Demodulation of an AM Signal**

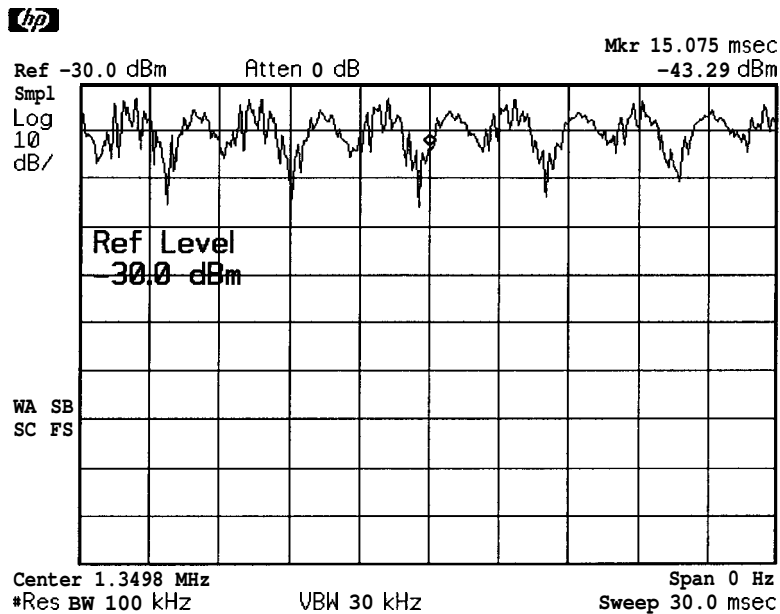

## Measuring Device Bandwidth

It is often necessary to measure device bandwidth, such as when testing a band pass filter. There is a key in the **Measure** menu that will perform this function. The device signal being measured must be displayed before activating the measurement. The span must include the full response.

Activate the measurement by turning the **N dB Points On Off** key (On). The spectrum analyzer places arrow markers at the **-3 dB** points on either side of the response and reads the bandwidth. For other bandwidth responses enter the number of **dB** down desired, from **1 dB** to **80 dB**.

No other signal can appear on the display within **N dB** of the highest signal. The measured signal cannot have more than one peak that is greater than or equal to **N dB**. A signal must have a peak greater than the currently defined peak excursion to be identified. The default value for the peak excursion is **6 dB**.

Measurements are made continuously, updating at the end of each sweep. **This** allows you to make adjustments and see changes as they happen. The single sweep mode can also be used, providing time to study or record the data.

The **N dB** bandwidth measurement error is typically about  $\pm 1\%$  of the span.

Figure 3-10 N dB Bandwidth Measurement

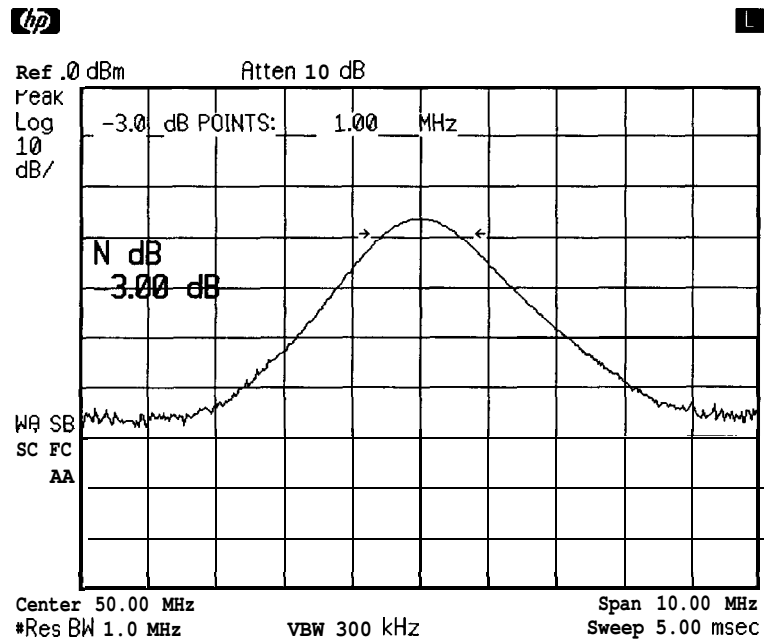

**Example:** Measure the 3 dB bandwidth of the spectrum analyzer's 1 MHz resolution bandwidth filter using the internal 50 MHz signal.

1. On the spectrum analyzer, press **Preset, System, 50 MHz Osc On Off** (On) to turn on the internal signal.
2. Press **Frequency, 50 MHz**, to center the signal.
3. Press **Span, 10 MHz**, to narrow the displayed span.
4. Press **BW/Avg** and  $\uparrow$  until the 1 MHz resolution bandwidth is selected.
5. Press **Measure** and **N dB Points On Off** (On) to activate the N dB bandwidth function.
6. Read the measurement results in the upper left corner of the screen.
7. The knob or the data entry keys can be used to change the N dB value from 3 dB to 6 dB to measure the 6 dB bandwidth of the filter.
8. Press **N dB Points On Off** (Off) to turn the measurement off.

## Measuring Percent Amplitude Modulation

Percent amplitude modulation (AM) can be measured quickly and easily using the front panel **% AM On Off** key. The signal and both its sidebands must be on the display before the measurement is activated.

The signal sidebands are assumed to be entirely from amplitude modulation. The spectrum analyzer places arrow markers on the three signals to be used to compute percent amplitude modulation, and displays the value. If the sidebands are not in the frequency span or their frequency spacing is not equal, the measurement stops and an error message is displayed.

Measurements are made continuously, updating at the end of each sweep. This allows you to make adjustments and see changes as they happen. The single sweep mode can also be used, providing time to study or record the data.

Percent AM measurement accuracy:

- Typically about  $\pm 0.1\%$ , for log mode
- Typically about  $\pm 3\%$ , for linear mode

**Figure 3-11** Percent Amplitude Modulation Measurement

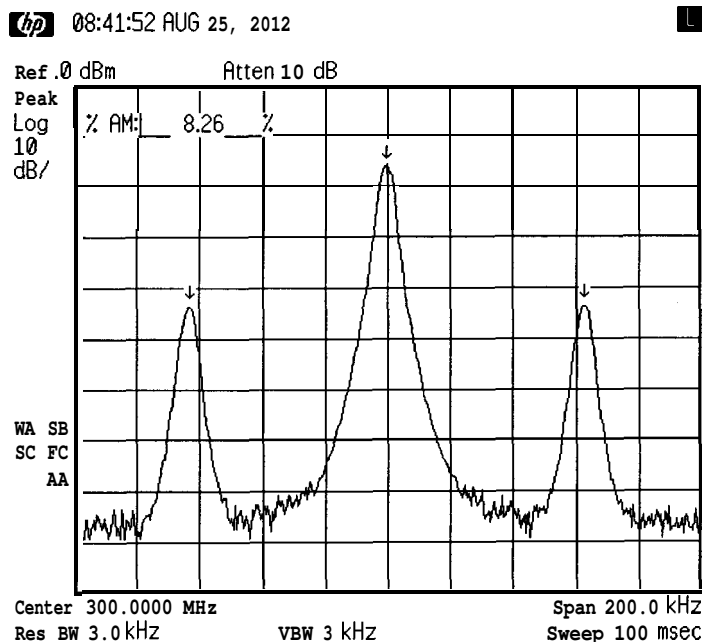

**Example:**

1. Press **Preset**. Connect a signal with amplitude modulation, to the INPUT connector. The modulation frequency should be 210 kHz.
2. Press **Frequency** and enter the frequency of your input signal to place the signal at the analyzer center frequency.
3. Press **Span**. Change the span until only the signal and its two sidebands appear on the display.
4. Press **Measure** and **% AM On Off (On)** to activate the percent amplitude modulation function.
5. Read the measurement results in the upper left corner of the screen.
6. Press **% AM On Off (Off)** to turn the measurement off.

## Measuring Third Order Intermodulation Distortion

There is a front panel TOI (third order intercept) measurement key to make quick and easy inter-modulation measurements on mixers or converters. Before the TOI measurement is turned on there must be four signals on the display, two test signals and their two associated distortion products. All of the signals must have peaks greater than the peak excursion value that is currently defined. (The default value for the peak excursion is 6 dB.) The two highest amplitude signals are assumed to be the test signals for the third order intercept measurement.

The spectrum analyzer computes and displays the third order intercept of the displayed signals, marking all four signals with arrows to confirm the correct signal selection. The measurement updates at the end of every sweep, which enables real time optimization of devices or systems under test. The single sweep mode can also be used to provide time to study or record the data.

**Third Order Intercept:** Third order intercept is defined as the absolute power level at which the third order distortion products intercept the level of two equal level test signals. If the distortion products are due to true third order distortion, then the measurement result will be independent of the level of the test signals.

The third order intermodulation is calculated as follows (all amplitude values are expressed in dBm):

$$\text{TOI} = \frac{2 \times \text{Ampl}_{\text{signal A}} - \text{Ampl}_{\text{distortion product A}} + \text{Ampl}_{\text{signal B}}}{2}$$

where the frequency of distortion product A is:

$$\text{Freq}_{\text{distortion product A}} = 2 \times \text{Freq}_{\text{signal A}} - \text{Freq}_{\text{signal B}}$$

The measurement algorithm used by **TOI On Off** (see above equation) corrects for the two test signals being different amplitudes. The result is a calculated value for the two test signals being equal amplitude, and is independent of the absolute level of either test signal. In order to minimize the measurement error, it is best to keep the test signals as close as possible to the same level and to the top of the screen.

Figure 3-12 Third Order Intermodulation Measurement

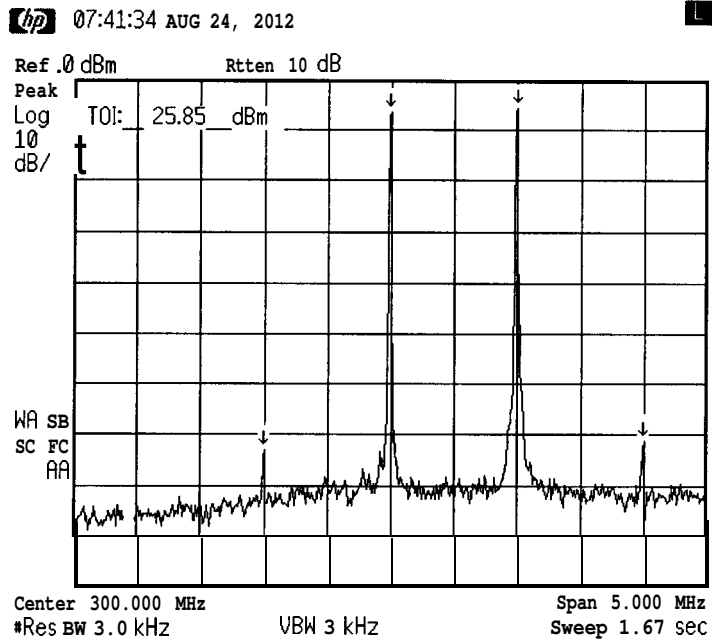

### Example:

Use the TOI function to make a measurement.

1. Press **Preset**. Connect two equal amplitude signals with different frequencies, to the spectrum analyzer INPUT.
2. Press **Frequency** and enter the frequency of one of your input signals to place the signal at the spectrum analyzer center frequency
3. Press **Span**. Change the span until only the two signals and their two distortion products appear on the display
4. Press **Measure** and **TOI On Off (On)** to activate the third order intercept measurement function.
5. Read the measurement results in the upper left corner of the screen.
6. Press **TOI On Off (Off)** to turn the measurement off.

It is important to verify that the TOI being measured is coming from the device under test and not from the spectrum analyzer. An easy way to do this is as follows:

1. Set up the TOI measurement and turn it on.
2. Press **Amplitude, Attenuation Auto Man (Auto)** and increase the attenuation +10 dB by pressing  $\uparrow$  twice.

## Making Measurements

### Measuring Third Order Intermodulation Distortion

3. If the displayed result of the **TOI** measurement remains constant, then the value is the result of the device under test.
4. If the displayed result of the **TOI** measurement increases, then the value is due to spectrum analyzer distortion and not the device under test. In this case, continue to increase the attenuator setting until the measurement result no longer changes as the attenuator is changed. When the value remains constant, the result is from the device under test.

Increasing the attenuator setting of the spectrum analyzer decreases the level of the signal internal to the spectrum analyzer and therefore decreases the distortion generated by the analyzer. However, it also increases the noise floor of the instrument, which decreases the measurement range and the ability to see low level distortion products. Refer to the information in the specifications and characteristics chapter of your user's and calibration guide for a graph of the distortion performance of the spectrum analyzer.



---

## **4 Using Instrument Features**

## What's in this Chapter

This chapter introduces features of the spectrum analyzers. These features can be used to manipulate measurement data and to make measurements more easily. In this chapter you will be:

- “Saving and Loading Files from Analyzer Memory” on page 77
- “Creating Limit Lines” on page 81
- “Entering Amplitude Correction Factors” on page 92
- “Using the External Keyboard” on page 99

---

## Saving and Loading Files from Analyzer Memory

This section explains how to save and load state, trace, limit line, and amplitude correction factor data files to and from spectrum analyzer memory using the functions in the **File** menu.

Saving state data saves the spectrum analyzer settings, but not the trace data. Saving trace data saves the trace data and the state data. States, traces, limit line tables, and amplitude correction factors are retained in spectrum analyzer memory even if the instrument is turned **off** or **Preset** is pressed. Files cannot be saved if the **Internal Lock On Off** softkey function is set to **On**.

Refer to Table , “Summary of Save and Recall Operations to Analyzer Memory,” on page 78 at the end of this section for a summary of saving and loading data to and from spectrum analyzer memory. Refer to page 79 for the rules for naming a file.

### To Save a File in Memory

1. Several different types of files can be saved in analyzer memory:
  - **Saving a state:** Set up the spectrum analyzer settings to be saved.
  - **Saving a trace:** Set the analyzer to display the trace to be saved. (Enter a screen title, if desired, by using **Display** and **Title, Change Title.**) Saving trace data saves both the trace data and the state data in the same file.
  - **Saving limit**  Set up the limit line table to be saved. See page 81 in this chapter. Limit line data can be entered using the remote programming commands as well as through the front panel keys.
  - **Saving amplitude correction data:** Set up the table of correction data to be saved. See page 92 in this chapter for more information. Amplitude correction data can be entered using the remote programming commands as well as through the front panel keys.
2. Press **File, Save**.
3. Press the key for the desired type of file to be saved. (for example, **State**). The files of the selected type, that are currently in memory, will be displayed on the spectrum analyzer.

---

**NOTE**

If a trace is being saved, press the **Trace A B C** softkey until you have underlined the trace that you want to save.

Using Instrument Features  
**Saving and Loading Files from Analyzer Memory**

4. The analyzer will create a unique name for the file to be saved, with the proper **suffix**. (. **STA** for a state) To select a different file name, press **New Filename** and use the alpha editor keys to enter a name. The correct suffix is automatically attached to the file name.
5. Press **Save Now** to save the file in memory.

### To Load a File from Memory

1. Press **File, Load**.
2. Select the desired type of file to load (for example, State).

---

**NOTE**

---

If a trace is being loaded, press **Trace A B C** so that the desired destination for the trace data is underlined.

3. Use the Up/Down arrows or the knob to select the desired file.
4. Press **Load Now**.

### To Protect Data From Being Overwritten

If you want to protect all state, trace, limit line, and amplitude correction data from being overwritten, press **File**, then **Internal Lock On Off** so that **On** is under lined. page 78 summarizes the functions when saving and loading data to and from spectrum analyzer memory.

Summary of Save and Recall Operations to Analyzer Memory

Operation	Screen Title Available?	Key Sequence
Save state	No	<b>File, Save, State, New Filename</b> (enter file name), <b>Save Now</b>
Load state	No	<b>File, Load, State</b> , (select desired file name), <b>Load Now</b>
Save trace	Yes	<b>File, Save, Trace, Trace A B C</b> (select desired source trace), <b>New Filename</b> (enter file name), <b>Save Now</b>
Load trace	Yes	<b>File, Load, Trace, Trace A B C</b> (select desired destination trace), (select desired file name), <b>Load Now</b>
Save limit line table	Yes	<b>File, Save, Limits, New Filename</b> (enter file name), <b>Save Now</b>

Operation	Screen Title Available?	Key Sequence
Load limit line table	No	<b>File, Load, Limits</b> , (select desired file name), <b>Load Now</b>
Save amplitude correction factors	Yes	<b>File, Save, Ampcor, New Filename</b> (enter file name), <b>Save Now</b>
Load amplitude correction factors	No	<b>File, Load, Ampcor</b> , (select desired file name), <b>Load Now</b>

## File Naming Rules

File names for storing states, traces, limit lines or amplitude correction data files in the analyzer should follow the conventions as indicated below:

- They can be up to eight characters long. In addition, they can have a file extension up to three characters long. The analyzer assigns the extension.
- They are not case sensitive. It does not matter whether you use upper case or lower case letters when you type them.
- They can contain only the letters A through Z, the number 0 through 9, and the following special characters:
  - underscore \_
  - carat ^
  - dollar sign \$
  - tilde ~
  - exclamation point !
  - number sign #
  - percent sign %
  - ampersand &
  - hyphen -
  - braces { }
  - at sign @
  - single quotation mark ‘
  - apostrophe ’
  - parenthesis ( )

No other characters are valid.

## Using Instrument Features

### Saving and Loading Files from Analyzer Memory

- They cannot contain spaces, commas, backslashes, or periods. (except the period that separates the name from the extension.)
- They cannot be identical to the name of another file in the same directory.

---

## Creating Limit Lines

Limit lines provide an easy way to compare trace data to a set of amplitude and frequency parameters while the spectrum analyzer is sweeping the measurement range. An upper and/or lower limit line can be displayed. Every measurement sweep of trace A is compared to the limit lines. If trace A is at or within the bounds of the limit lines, **LIMIT PASS** is displayed. If trace A is out of the limit line boundaries, **LIMIT FAIL** is displayed. Figure 4-1 shows a sample limit line display.

Limit lines are constructed from a table of frequency and amplitude coordinate pairs. Limit line segments are created by connecting these points. Everything except the segment length is defined by the entry for the beginning point. Limit lines can be entered as coordinates of frequency and amplitude, or in terms of time and amplitude for zero span measurements.

This section provides a procedure for creating a sample upper limit line and descriptions of the limit line functions. Refer to the user's guide for more information on a specific limit line function.

### Procedure for Creating an Upper Limit Line

This procedure demonstrates how to create a sample upper limit line for the internal alignment signal and then activate testing. Detailed descriptions of the limit line functions follow this procedure.

1. Press **Preset**.
2. Set the center frequency and span by pressing **Frequency, 50 MHz**, and **Span, 90 MHz**.
3. Turn on the internal alignment signal by pressing **System** and **50 MHz osc On Off**, so that **On** is underlined. (The alignment signal is used as the "test" signal for this demonstration.) The amplitude units are in **dBm**.
4. Press **Measure, Limits** to access the limit line menus.

---

**NOTE**

To clear an existing limit-line table, you must press **Delete Limits** two times. The **Preset** key turns limit-line testing off (if it is on), but does not clear an existing limit-line table.

5. Select the type of limit line needed.
  - a. **Limits Fixed Rel** specifies whether or not the limit line values are fixed values, or are values relative to the spectrum analyzer center frequency and reference level settings. Press **Limits Fixed Rel** so that **fixed** is underlined. The table will be labeled **limits=FIXED** or **limits=RELATIVE**.

- b. **X Axis Units Freq Time** allows you to select frequency (or time, for zero span) units for the horizontal axis. Press **X Axis Units Freq Time** so that **Freq** is under lined. The table column will be labeled **START-FREQ** or **START-TIME**.

When time parameters are used, the **RELATIVE** format only affects the amplitude part of the coordinate pairs. The time parameters are always fixed beginning at the left edge of the graticule.

- 6. Press **Edit Limits**. Notice that **Upper** is selected on the **Select Line Upper Lower** key Press **Edit Line** to create an upper limit line.
- 7. The limit line table will be displayed. The table type defaults are frequency parameters (the second column is labeled **START\_FREQ**) and fixed parameters (the table is labeled **Limits=FIXED**).

**Figure 4-1 Typical Limit Line Display**

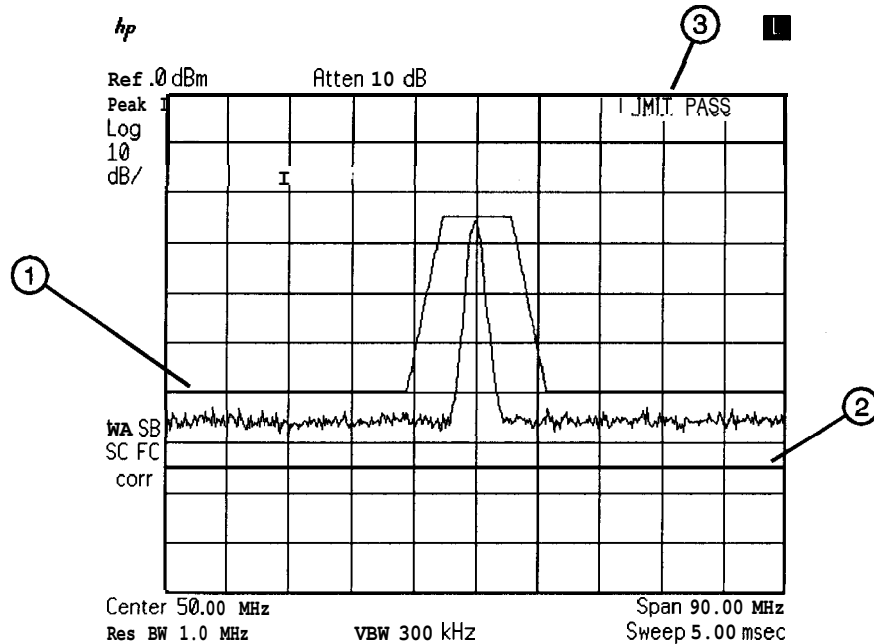

bn78a

**Table 4-1**

Item	Description of Items in Figure 4-1
1	Upper limit line
2	Lower limit line
3	Screen message



8. Specify the first limit line segment to begin at 5 MHz and have an amplitude of -60 dBm by using the following key sequence. (Use the Frequency menu key that is labeled on the display, not the permanent key on the right side of the front panel.):

- **Frequency, 5 MHz**
- **60 -dBm**
- **Flat**

---

**NOTE**

When entering a limit line segment, the frequency (or time) and amplitude values will be listed as asterisks (\* \* \*) until new values are entered. The new segment will be listed last until the frequency (time), amplitude, and type of line segment have been entered. Once the values are entered, the segment will be sorted into the limit line table according to frequency or time. The coordinates for the second point must be entered before the first limit line segment is displayed.

---

9. Enter the second limit line segment by pressing the following keys:

- **Frequency, 40 MHz**
- **60 -dBm**
- **Slope**

Table entries can be edited if you make a mistake. To edit an existing segment, use **Segment** in the Edit Line menu to specify the segment. Use **Frequency**, **Amplitude**, or **Select Type** to specify the column you wish to edit.

10. Specify the third limit line segment by pressing the following keys:

- **Frequency, 45 MHz**
- **30 -dBm**
- **Flat**

You may notice that the end coordinate of segment three is drawn to a point off the top of the spectrum analyzer display. This assures that no trace data beyond the end of the limit line will cause the test to fail.

11. Specify the fourth limit line segment by pressing the following keys:

- **Frequency, 100 MHz**
- **30 -dBm**
- **Point**

Since the limit line in this procedure has only four segments specified, the frequency value of segment four (the last segment) is set to 100 MHz, which is greater than the stop frequency of the display.

12. Press **Done** twice when all the segments have been entered.
13. Press **Limit Test On Off** so that **On** is underlined. This turns the limit testing on. For example, **LIMIT FAIL** is displayed because the signal exceeds the limit line. See Figure 4-2.

**Figure 4-2 The Completed Limit Line Table**

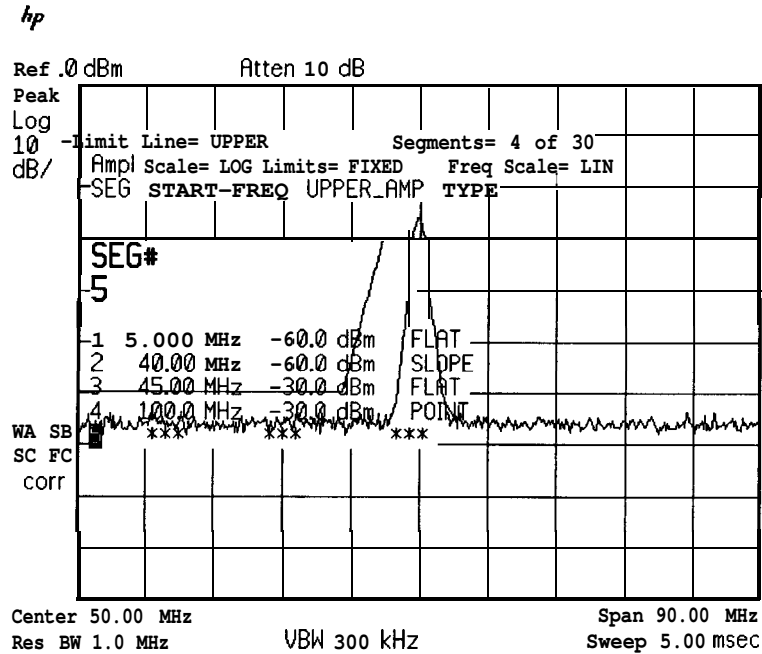

14. Press **System** and **50 MHz osc Off**. **LIMIT PASS** is displayed since no signal exceeds the limit line.
15. At this point you may want to try the following:
  - a. To remove the limit line from the display without deleting it, use **Limit Display Y N Auto**. Underlining **Y** displays the limit lines, while **N** turns them off. Selecting **Auto** allows them to be displayed if limit line testing is turned on, or it turns the limit lines off if testing is turned off.
  - b. To clear an existing limit line table, press **Delete Limits**.
  - c. To save the current limit line table, press **File, Save, Limits**. Press **Edit File Name** to enter the file name, or use the default file name assigned by the analyzer. Then press **Save Now**.
16. You may need to have limit lines above and below your test signal. Follow the same procedure above to generate the upper limit line. Then press **Select Line Upper Lower** so that **Lower** is underlined and enter in the desired values for the lower limit line. See Figure 4-3.

Figure 4-3 Upper and Lower Limit Line Testing

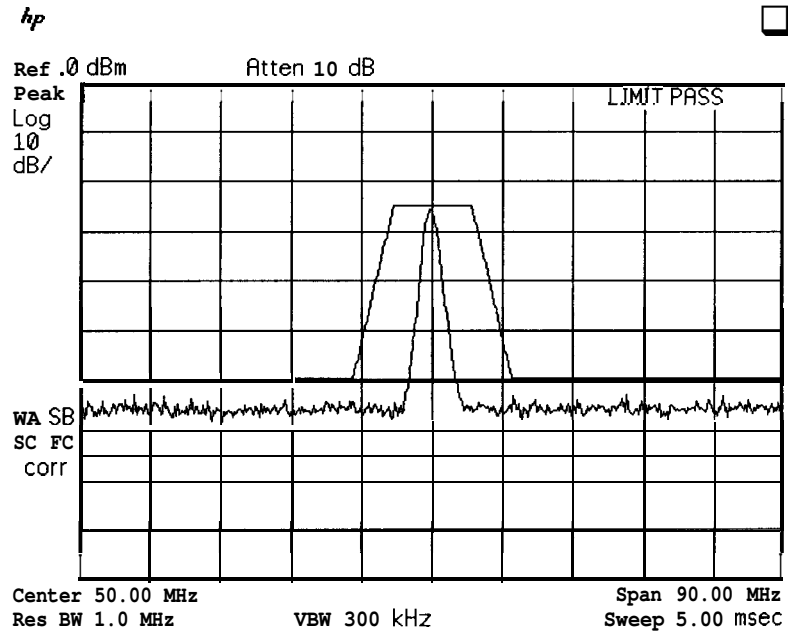

## Limit Line Functions

This section describes the limit line functions in the order that they are usually used.

### Editing, Creating, or Viewing a Limit Line

Pressing **Measure**, then **Limits** accesses the **softkey** menus used for creating a limit line.

Press **Edit Limits**, **Edit Line** to edit an existing limit line table. If no limit line table currently exists, this will allow you to create one.

If a limit line exists currently, and you would like to purge it and create a new one, press **Select Line Upper**, and **Done**, **Done**. Then press **Delete Limits** two times to clear the existing limit line table and press **Edit Limits**, **Edit Line** to access the limit line editing menu.

### Selecting the Type of Limit Line Table

The **X Axis Units Freq Time** key selects the type of limit line parameters for the horizontal axis. Parameters can be entered as frequency/amplitude coordinates, or as time/amplitude coordinates. Use the **X Axis Units Freq Time** key, to underline the desired choice of either frequency or time parameters. **Frequency** is the default selection. If **Time** is selected Time will replace Frequency in the Edit Line menu. The second column of the limit line table is labeled **START-FREQ** when frequency is selected. It is labeled **START-TIME** when time is selected.

The **Limits Fixed Ret** key selects the type of limit line. There are two types of limit lines: fixed and relative. Fixed limit lines contain only absolute amplitude and frequency (or time) values. Relative limit lines consist of frequency values that are referenced to the spectrum analyzer center frequency and amplitude values that are relative to the analyzer reference level. The relative setting does not affect time values. Time values always begin at the left edge of the graticule.

As an example of fixed versus relative limit lines, if a limit line is specified as fixed, entering a limit line segment with a frequency coordinate of 300 MHz displays a limit line segment at 300 MHz. If the same limit line table is specified as relative, it is displayed relative to the spectrum analyzer center frequency and reference level. If the analyzer center frequency is at 900 MHz, a relative limit line segment with a frequency coordinate of 300 MHz will display a limit line segment at 1.2 GHz. If the amplitude component of a relative limit line segment is -10 dB and the spectrum analyzer reference level is -15 dBm, then -10 dB is added to the reference level value and the amplitude component of the limit line will be at -25 dBm.

**Limits=RELATIVE** is displayed in the limit line table when the limit line type is relative; **Limits=FIXED** is displayed when the limit line type is fixed. A limit line entered as fixed may be changed to relative, and one entered as relative may be changed to fixed. When the limit line type is changed, the frequency and amplitude values in the limit line table are modified by the current center frequency and reference level settings to keep the limit line in the same position on the spectrum analyzer.

### Selecting the Limit Line Table Format

Press **Select Line Upper Lower** and underline either Upper or Lower to edit or create the desired type of limit line table. You can use an upper limit line only, or a lower limit line only, or both an upper and a lower limit line. The upper and lower limit lines are each edited separately, but activated together.

### Selecting the Segment Number and Entering Coordinates

Pressing the **Segment** key specifies the segment number to be entered or edited. Up to 30 segments can be specified for an upper or lower limit line table. Limit lines are constructed from left to right.

Limit line segments are created by entering frequency (time) values and amplitude values into a limit line table. The **frequency(time)** and amplitude values specify a coordinate point from which a limit line segment is drawn. The segment is defined by its beginning point, that is the coordinate point that is the lowest frequency or time point of the line segment. See Figure 4-4.

The segment coordinates are entered by pressing **Frequency (or Time)** and entering the value. Regardless of the table format, a frequency (time) coordinate must be specified. Pressing the **Amplitude** key allows you to enter the amplitude value of the coordinate.

---

**NOTE**

When entering a limit line segment, the frequency (or time) and amplitude values will be listed as asterisks (\* \* \*) until new values are entered. The new segment will be listed last until the frequency (time), amplitude, and type of line segment have been entered. Once the values are entered, the segment will be sorted into the limit line table according to frequency or time.

---

**Figure 4-4**      **Limit Line Segments**

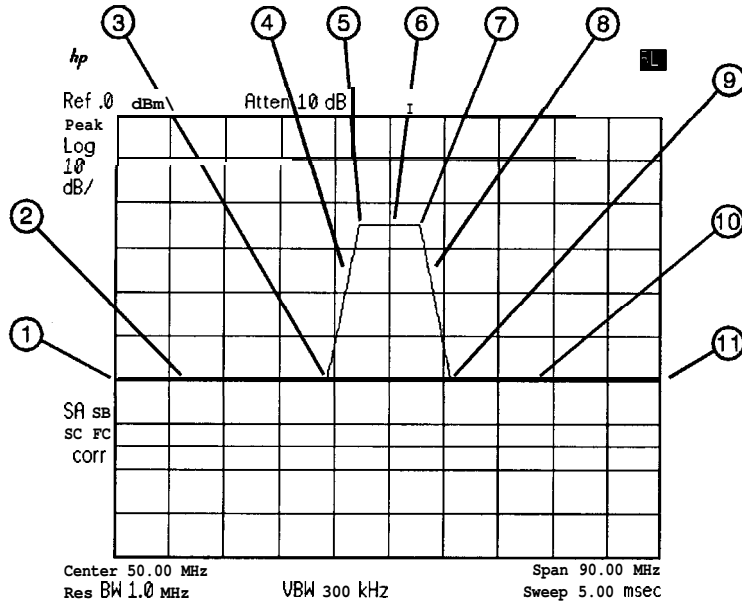

bn77a

**Table 4-2**

Item	Description of Items in Figure 4-4
1	Frequency and amplitude coordinate that starts the first segment
2	First segment
3	Frequency and amplitude coordinate that starts the second segment
4	Second segment
5	Frequency and amplitude coordinate that starts the third segment
6	Third segment
7	Frequency and amplitude coordinate that starts the fourth segment
8	Fourth segment
9	Frequency and amplitude coordinate that starts the fifth segment
10	Fifth segment
11	Frequency and amplitude coordinate that starts the sixth segment

## Selecting the Segment Type

After entering the frequency (time) and amplitude coordinates, press **Type** and **Flat**, **Slope**, or **Point** to specify the segment type. The segment type determines how to connect the coordinate point of the current line segment with the coordinate point of the next line segment. The segment type determines whether the line segment is horizontal, sloped, or a single point. The three segment types are:

1. Flat draws a zero slope line between the coordinate point of the current segment and the coordinate point of the next segment, producing limit line values equal in amplitude for all frequencies or times between the two points. If the amplitude values of the two segments differ, the limit line will “step” to the value of the second segment at the frequency coordinate of the second segment. See Figure 4-5.
2. Slope draws a straight line between the coordinate point of the current segment and the coordinate point of the next segment, producing limit line values for all frequencies between the two points.
3. Point specifies a limit value for the coordinate point. It specifies a limit at a single frequency or time, and for no other frequency/time points. For an upper limit line, a point segment is indicated by a line drawn from the coordinate point, vertically off the top of screen. For a lower limit line, a point segment is indicated by a line drawn from the coordinate point, vertically off the bottom of screen. The line will continue to the right edge of the display, but testing stops at the defined point.

The point segment type should be used as the last segment in the limit line table. However, if the last segment in the table is not specified, an implicit point is automatically used. If a point segment at the right edge of the display is not desired, add a last point segment to the limit line table that is higher in frequency than the displayed stop frequency.

Figure 4-5 demonstrates the different segment types.

**Figure 4-5** Segment Types

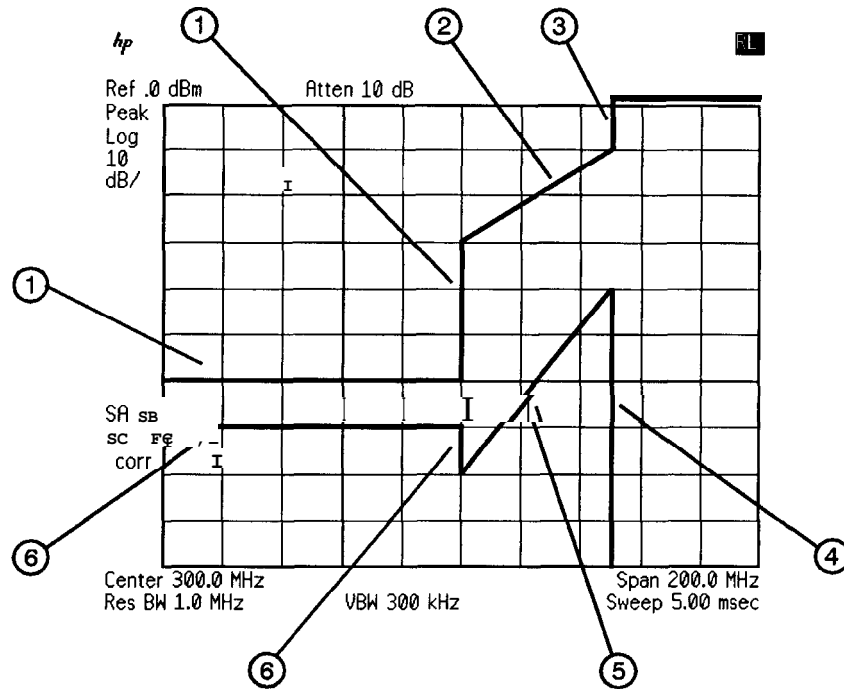

bn76a

Table 4-3

Item	Segment Types
1	Flat (upper limit line)
2	Slope (upper limit line)
3	Point (upper limit line)
4	Point (lower limit line)
5	Slope (lower limit line)
6	Flat (lower limit line)

**Completing Table Entry and Activating Limit Line Testing**

Pressing **Done** blanks the limit line table from the screen and accesses the menu with **Limit Test On Off** and **Limit Display Y N Auto** softkeys.

Pressing **Limit Test On Off** turns on the testing of the current trace against the limit line values.



Pressing **Limit Display Y N Auto** (**Y** or **N**) turns display of the limit lines on and **off**. Pressing **Limit Display Y N Auto** (**Auto**) sets the limit line display to match the limit line test function. With **Auto** underlined the limit lines are only displayed when limit line testing is turned on.

## Entering Amplitude Correction Factors

This section provides an overview of amplitude correction, a procedure for creating amplitude correction data, and descriptions of the amplitude correction functions. Refer to the key descriptions in the user's guide for more information on a specific amplitude correction function.

Amplitude corrections provide an easy way to adjust trace data with a set of amplitude and frequency parameters while the spectrum analyzer is sweeping the measurement range. Every measurement sweep of data is adjusted by the amplitude correction values. When using the amplitude correction functions, an **A** is displayed at the left hand side of the graticule edge. See Figure 4-6.

Figure 4-6 Amplitude Correction Display

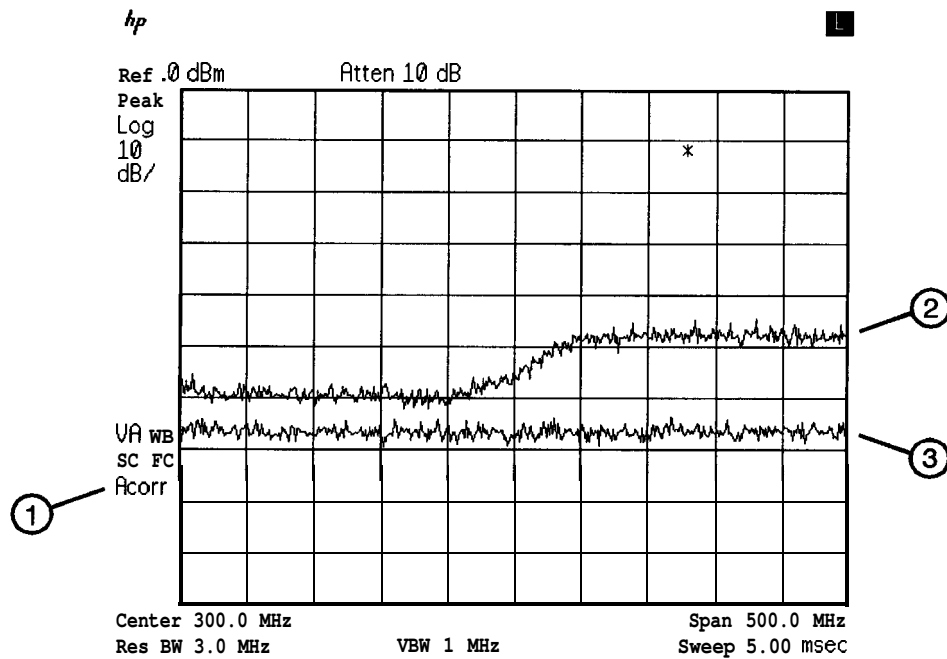

bn75a

Table 4-4

Item	Description of Items in Figure 4-6
1	Indicates amplitude correction factors are on
2	Amplitude corrections ON
3	Amplitude corrections OFF

## Procedure for Creating Amplitude Correction Factors

This procedure demonstrates how to create and activate amplitude correction data. Detailed descriptions of the amplitude correction functions follow this procedure.

### 1. Press Preset.

---

**NOTE**

---

A signal is not used in this procedure for demonstrating how to create amplitude correction data. Disconnect any cable on the spectrum analyzer input.

2. Set the center frequency to 300 MHz and the span to 500 MHz by pressing:

- **Frequency, 300 MHz**
- **Span, 500 MHz**

3. Press **Amplitude, More, Ampcor** to access the amplitude correction functions.

4. Press **Modify Ampcor** to access the editing menus for amplitude correction factors.

5. To clear any existing amplitude correction data, press **Purge Ampcor** twice.

6. Specify the first amplitude correction point by pressing the following keys:

- **Select Freq**
- **50 MHz**
- **12 dB**

7. Specify the second amplitude correction point by pressing the following keys:

- **250 MHz**
- **10 dB**

**NOTE** Table entries can be edited if you make a mistake. To edit an existing point, use **Select Point** to specify the point. Then use **Select Freq** or **Select Amptd** to specify the entry that you wish to edit.

8. Specify the third and fourth amplitude correction points by using the following key sequence:
  - **300 MHz, 15 dB**
  - **350 MHz, 22 dB**

**Figure 4-7 Completed Amplitude Correction Table**

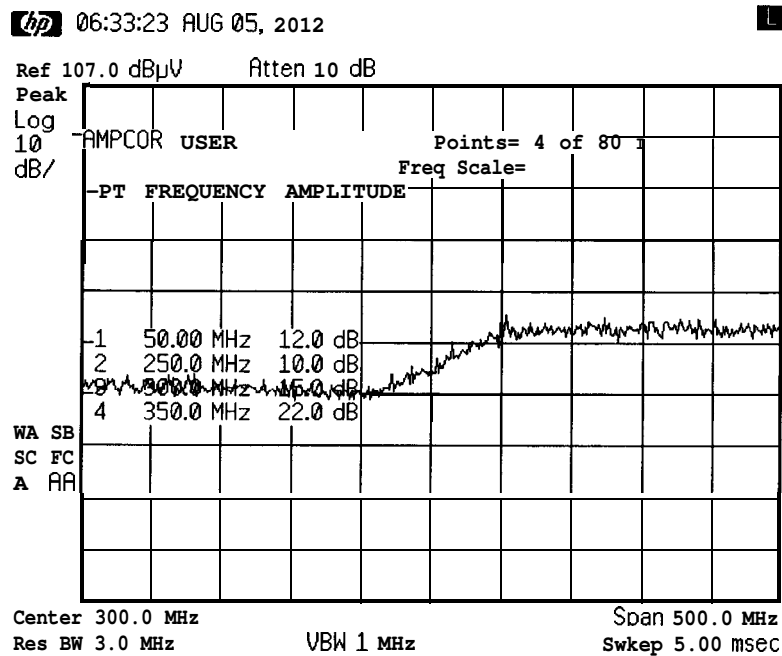

9. Press **Done** when all the points have been entered.  
Use step 10 and step 11 to display corrected versus uncorrected amplitude trace data for trace comparison.
10. Display the amplitude corrected trace in trace A by pressing the following keys:
  - **Trace**
  - **Clear Write A**
  - **View A**

11. Display the uncorrected amplitude trace in trace B by pressing the following keys. See Figure 4-8.

- Trace A B C until B is selected
- Clear Write B
- Amplitude, More, Ampcor
- Ampcor On Off until Off is selected

Figure 4-8 Uncorrected and Amplitude Corrected Trace

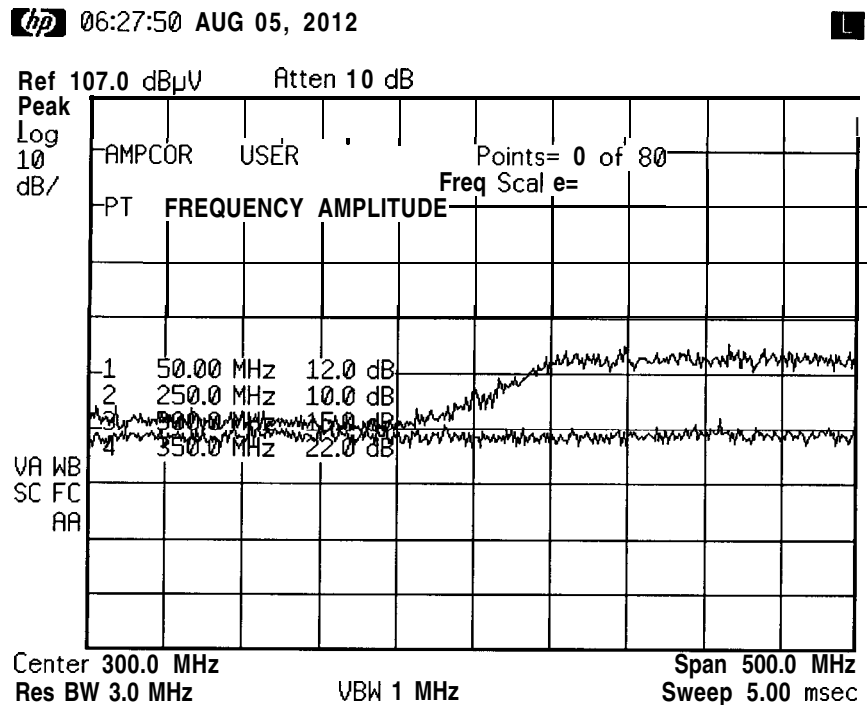

## Amplitude Correction Functions

This section describes the amplitude correction functions in the order they are usually used.

### Editing or Viewing the Amplitude Correction Tables

Pressing **Amplitude, More, Ampcor** accesses the softkey menus for creating an amplitude correction table.

#### NOTE

**Preset** turns amplitude correction factors off (if it is on), but does not clear an existing amplitude correction table. Use **Purge Ampcor** to clear an existing amplitude correction table.

Using Instrument Features  
Entering Amplitude Correction Factors

Press **Modify Ampcor** to edit an existing amplitude correction table or, if no amplitude correction table currently exists, to create an amplitude correction table.

Selecting the Amplitude Correction Point

Pressing **Select Point** specifies the amplitude correction point to be entered or edited. Amplitude correction data is constructed from left to right and is created by entering frequency and amplitude values into an amplitude correction table. The frequency and amplitude values specify a coordinate point from which amplitude corrections are interpolated. See Figure 4-9. Up to 80 points can be specified for the amplitude correction table.

**Table 4-5** Amplitude Correction data for Figure 4-9

Point	Frequency	Amplitude
1	200.0 MHz	.0dB
2	250.0 MHz	15.0 dB
3	300.0 MHz	20.0 dB
4	300.0 MHz	-10.0 dB
5	350.0 MHz	25.0 dB

Figure 4-9 Amplitude Correction Points

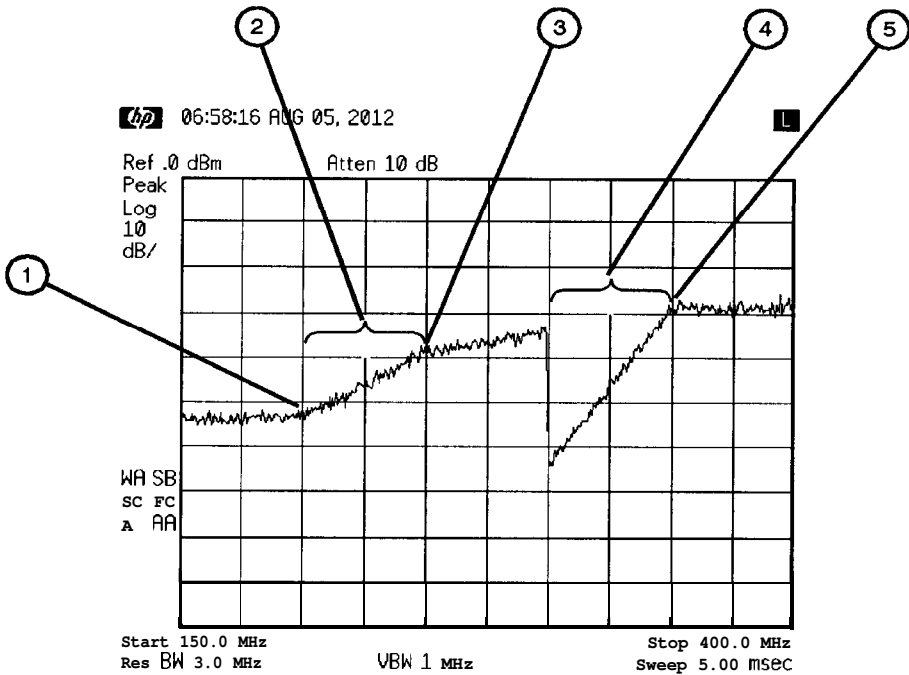

ni746a

Table 4-6

Item	Description of Items in Figure 4-9
1	Frequencies below first point use first amplitude level
2	First segment interpolated with the 15 dB amplitude correction
3	Frequency and amplitude coordinate that starts the second segment
4	Third segment interpolated with the -10 dB amplitude correction
5	Frequency and amplitude coordinate that starts the fourth segment

### Selecting the Frequency Coordinate

Press **Select Freq**, then enter a frequency value for the point.

---

**NOTE**

Only two entries per frequency are used. If more points with the same frequency are entered, only the first and last entries are used. All other amplitude values are ignored. See Figure 4-9 for an example of two entries at the same frequency

---

---

**NOTE**

When entering amplitude correction data, the frequency and amplitude values will be listed as asterisks (\*\*\*) until new values are entered. Once the frequency value is entered, the segment is immediately sorted into the table according to this value.

---

### Selecting the Amplitude Coordinate

The amplitude value is entered by pressing **Select Amptd**, entering an amplitude value, and pressing a units key

### Completing Table Entry and Activating Amplitude Corrections

Pressing **Done** blanks the amplitude correction table from the screen and accesses the menu with **Ampcor On Off**. This turns the amplitude corrections on and off.

### Saving or Loading Amplitude Correction Tables

Pressing **File** accesses **Save** and **Load**. These **softkey** functions provide an easy way to save or load current amplitude correction tables. **Save**, **Ampcor** saves the current amplitude correction table in the spectrum analyzer memory, Press **Edit File Name** to enter a file name, then press **Save Now** to save the current amplitude correction table.

Press **File**, **Load**, **Ampcor** to load amplitude correction tables from the spectrum analyzer memory. Scroll through the displayed amplitude correction files to select the desired one and press **Load Now** to load the table.



## Using the External Keyboard

The HP C1405B keyboard is an IBM AT compatible keyboard (with a mini-DIN connector) that can be connected to the external keyboard connector on the front panel of the spectrum analyzer. The external keyboard allows a convenient way to enter screen titles and remote programming commands directly into the spectrum analyzer or to access the **softkey** functions. Detailed information on using the external keyboard can be found in the programmer's guide.

The function keys of the external keyboard control the spectrum analyzer as follows:

**Table 4-7 External Keyboard Functions**

Key	Description
<b>Esc</b>	Replaces the analyzer <b>Esc</b> key. Turns off the currently active function, but will not abort a printer operation.
<b>Num Lock</b>	Shows what the current operation mode is, either command mode or enter title mode on the analyzer screen.
<b>Scroll Lock</b>	Retrieves the present screen title for editing.
<b>F1 — F7</b>	<b>Softkeys</b> 1 through 7 (respectively) of the current analyzer menu.
<b>F8</b>	Replaces the analyzer <b>More</b> key. Accesses other pages of the current menu, for multi-page menus.
<b>F9</b>	Accesses the <b>Measure</b> menu.
<b>F10</b>	Accesses the <b>Frequency</b> menu.
<b>F11</b>	Accesses the <b>Span</b> menu.
<b>F12</b>	Accesses the <b>Amplitude</b> menu.
<b>Print Screen</b>	Copies the analyzer screen display to the active copy device.
<b>Pause</b>	Toggles operation between the command mode and the enter title mode.
<b>Delete</b>	Deletes the character over the cursor.
<b>Insert</b>	Toggles between the insert and replace mode at the <b>cursor</b> .
<b>Backspace</b>	Erases the previous character to the left of the <b>cursor</b> .
<b>Alt-Delete</b>	Clears the keyboard line.

Using Instrument Features  
Using the External Keyboard

Key	Description
<b>Ctrl-Delete</b>	Clears to end of line.
[←]	Moves the cursor to the left.
[→]	Moves the cursor to the right.
[↓]	Moves from earlier items to later items in the recall buffer.
[↑]	Moves from later items to earlier items in the recall buffer.
<b>Ctrl- C</b>	End-of-text.
<b>Ctrl- J</b>	Linefeed.
<b>Ctrl- M</b>	Carriage return.
<b>Ctrl- N</b>	Turns on inverse video.
<b>Ctrl- O</b>	Turns enhancements (inverse video, underlining) off.
<b>Ctrl- P</b>	Turns on underlining.
<b>Ctrl- (space)</b>	Escape.
The dash between keys indicates that both keys should be pressed at the same time.	

The external keyboard operation with the spectrum analyzer is similar to its operation with a computer except for the following:

**Pause**, **Num Lock** and **Scroll Lock** are fixed and cannot be changed. Pressing **Pause** toggles between the keyboard's command mode and title mode. Pressing **Num Lock** displays the current keyboard mode on the spectrum analyzer screen. Pressing **Scroll Lock** retrieves the current title for editing.

The keyboard supports a 244 character recall buffer. The longest single item is limited to 243 characters; subsequent characters are ignored. Using the (↑) or (↓) keys of the external keyboard to recall an item does not change the buffer contents. Recalling an item and then pressing the **Enter** key does not store a new copy of the item in the recall buffer. If an item is recalled and then modified, a new copy will be made in the recall buffer. Adding new data into the keyboard line deletes the oldest data automatically.

When in command mode, the active line will append a semicolon to the keyboard entry if the line does not end with a semicolon and it is fewer than 243 characters long.

## Using the External Keyboard

The following three example procedures demonstrate how to use an external key board to enter a screen title and programming commands. However, a brief procedure on installing your external keyboard is described first. More detailed information on using the external keyboard is found in the programmer's guide.

### External Keyboard Installation

1. Turn off the spectrum analyzer.

---

**CAUTION**

---

The spectrum analyzer must be turned off before connecting an external keyboard to it.

2. Connect the HP C1405B keyboard cable to the spectrum analyzer front panel connector **EXT KEYBOARD**.
3. Turn the spectrum analyzer on.
4. The external keyboard is now ready to use for entering a screen title or programming commands.

### To Enter a Screen Title

Refer to the programmer's guide for more information.

1. **Press Pause** on the external keyboard to enter the title mode.
2. Type in a screen title using the external keyboard. The entry appears at the top line of the spectrum analyzer display as it is entered.
3. Press **Enter** on the external keyboard. Pressing **Enter** moves the characters to the position on the display for screen title annotation.

---

**NOTE**

---

To view more than 31 characters per line, turn off the time and date display by pressing the following keys: **System, Time/Date, Time/Date On off (Off)**.

### To Enter Programming Commands

Refer to the programmer's guide for more information.

1. **Press Pause** on the external keyboard to enter the mode for executing remote commands.
2. Type in a programming command (for example, type **TP**).
3. Press **Enter** on the external keyboard to execute the command.

---

**NOTE**

Unlike entering a remote programming command using an external controller, entering the remote programming commands with the external keyboard does not require including the spectrum analyzer address. It is also not necessary to terminate the programming line with a semicolon. However, semicolons are necessary for separating the programming commands. For example, a program line is entered via the external controller as: **OUTPUT 718;"CF 300MHZ;SP 1MHZ;"**. The same program line is entered using the external keyboard as: **CF 300MHZ;SP 1MHZ; Enter**.

---

After **Pause** is pressed, the spectrum analyzer remains in command mode. To return to the title entry mode, press **Pause** (on the external keyboard).

## Symbols

% AM, 6  
% AM On Off, 70

## Numerics

10 MHz REF INPUT, 12  
10 MHz REF OUTPUT, 12

## A

AM signal demodulation, 49  
Ampcor On Off, 94, 98  
amplitude correction  
  amplitude coordinate, 98  
  point, 96  
amplitude correction factors, 92  
amplitude correction functions,  
  95  
amplitude corrections  
  creating, 93, 94  
  editing, 94  
  frequency coordinate, 98  
  testing, 98  
  turning on/off, 94  
  using, 98  
Amplitude key, 6  
analyzer distortion products, 44  
annotation, 13  
arrow keys, 9  
AUX IF OUT, 12  
AUX VIDEO OUT, 11

## B

bandwidth measurement, 6, 68  
brightness keys, 6  
BW/Avg key, 7

## C

compare two signals, 19  
connector  
  10 MHz ref input, 12  
  10 MHz ref output, 12  
  aux if output, 12  
  aux video output, 11  
  ext alc input, 10  
  ext trig input, 11  
  external keyboard, 7  
  hi sweep in, 11  
  hi sweep out, 11  
  HP-IB, 11  
  INPUT 50 ohm, 8  
  parallel interface, 11  
  probe power, 7  
  RF OUT 50 ohm, 8  
  RS-232, 11  
  service, 12

## COPY, 7

counter resolution, 29  
creating amplitude correction  
  factors, 93  
creating limit lines, 81

## D

data controls, 8  
data entry keys, 7  
data keys, 9  
data protection, 78  
Delete Limits, 85  
delta marker, 19, 20  
Demod key, 65  
demodulating AM, 49  
demodulation  
  AM, 65  
  continuous, 66  
Det/Demod key, 7  
Display key, 7  
display limit lines, 90  
distortion products, 44  
down arrow key, 9  
drifting signals, 33

## E

earphone connector, 7  
Edit Ampcor, 95  
Edit Limits, 85  
Edit Lower, 86  
Edit Upper, 86  
editing amplitude corrections, 94  
editing limit lines, 83  
Esc key, 8  
escape key, 8  
EXT TRIG IN, 11  
external keyboard  
  keyboard, 99  
  programming command entry,  
    101  
  screen title entry, 101  
external keyboard connector, 7  
external keyboard installation,  
  101  
external keyboard operation, 101

## F

features  
  front panel, 6  
File key, 7  
file name rules, 79  
file protection, 78  
fixed limit lines, 82, 86  
fix-tuned receiver, 49  
Flat, 89  
Freq Count key, 29

## Frequency

  amplitude correction, 98  
  frequency counter function, 7  
  Frequency key, 6  
  frequency limit lines, 86  
  frequency readout resolution  
    increased, 29  
  front panel features, 6  
  fuse holder, 10  
  fuse location, 10

## H

HI SWEEP IN, 11  
HI SWEEP OUT, 11  
hold key, 8  
hold, maximum, 33  
HP-IB connector, 11

## I

identifying distortion products, 44  
impulse noise measurement, 4 1  
INPUT 50 ohm, 8  
installation, external keyboard  
  attaching external keyboard,  
    101  
  instrument preset, 7  
intermodulation distortion, third  
  order, 46  
Internal Lock On Off, 78

## K

key functions, external keyboard,  
  99  
keyboard  
  external connector, 7  
  keyboard operation, external, 101  
  keys labeled on display, 6  
  knob, 8

## L

Limit Display Y N Auto, 90  
limit line functions, 85  
limit lines, 6, 85, 87  
  creating, 81  
  displaying, 90  
  editing, 83  
  fixed, 86  
  freq time, 82  
  frequency or time, 86  
  relative, 86  
  segment number, 87  
  segment type, 89  
  table format, 86  
  table type, 86  
  testing, 90  
  using, 81

Limit Test On Off, 81, 84, 90  
Limits, 85  
Limits Fixed Rel, 82, 86  
LINE front panel key, 8  
line fuse, 10  
line power connector, 10  
LINE switch, 8  
LO feedthrough, 19  
Load key, 7  
loading a state from analyzer  
  memory, 78  
loading amplitude correction  
  factors from analyzer  
  memory, 78  
loading files from memory, 77  
loading limit lines from analyzer  
  memory, 78  
local oscillator signal, 19  
lock files in memory, 78  
low level signals  
  reducing attenuation, 37  
  reducing resolution bandwidth,  
    39  
  reducing video BW, 40  
  video averaging, 41  
low-level signals, 37

## M

Marker Count key, 29  
marker counter example  
  marker frequency resolution, 29  
Marker Delta key, 20  
marker keys, 7  
Marker to peak-to-peak key, 2 1  
Max Hold A key, 35  
maximum hold, 33  
Measure key, 6  
measurement  
  %AM, 70  
  bandwidth, 68  
  stimulus response, 55  
  TOI, 72  
measuring low-level signals, 37  
measuring return loss, 63  
memory  
  saving and loading files, 77  
menu keys, 6  
monitor output, 10  
More key, 8  
moving signals, 33

## N

N dB Points key, 68  
naming a file, 79  
normalization, 59  
Normalize On Off key, 59  
number/units keypad, 9

## O

on/off switch, 8

## P

parallel interface connector, 11  
Peak Search key, 7  
percent AM, 6  
percent AM measurement, 70  
Point, 89, 96  
power connector, 10  
power input, 10  
power on key, 8  
Preset key, 7  
presetting the analyzer, 7  
Print key, 7  
printer control, 7  
probe power connector, 7  
programming command entry,  
  external keyboard, 101  
protect files in memory, 78

## R

rear panel features, 10  
reflection calibration and  
  measurement, 62  
relative limit lines, 82, 86  
resolution bandwidth  
  resolving signals, 23  
resolving signals using resolution  
  bandwidth, 27  
return loss measurement, 63  
RF OUT 50 ohm, 8  
RPG knob, 8  
RS-232 interface connector, 11

## S

Save key, 7  
saving a state in analyzer  
  memory, 77  
saving files in memory, 77  
screen annotation, 13  
screen title, using an external  
  keyboard  
  title, create with external  
  keyboard, 101  
Segment, 87  
sensitivity  
  spectrum analyzer, 37  
service connector, 12  
signal tracking  
  marker tracking, 31  
Slope, 89  
softkeys, 6  
source power control, 56  
Span key, 6  
Span Zoom key, 33

speaker on/off control, 7  
speaker volume control, 7  
step keys, 9  
stimulus response  
  measurements, 55  
sweep coupling  
  stimulus response  
    measurements, 57  
Sweep key, 7  
sweep modes, 14  
sweep output connector  
  SWEEP OUT, 11  
Swp Coupling SR SA, 57  
System key, 7

## T

testing with limit lines, 81  
third order intermodulation  
  distortion example, 46  
third order intermodulation  
  measurement, 72  
  verification of, 73  
time limit lines, 86  
TOI, 6  
TOI On Off key, 72  
Trace key, 7  
trace modes, 15  
tracking generator  
  measurement, 55  
  normalization, 60  
  stimulus response, 55  
tracking unstable signals, 33  
Trig key, 7  
trigger modes, 14

## U

unstable signals, 33  
up arrow key, 9  
using limit lines, 81

## V

VGA connector, 10  
video averaging example, 41  
video BW example, 40  
video connector, 10  
volume control, 7

## W

write-protect files, 78

## X

X Axis Units Freq Time, 82, 86